

# Eaton XBUT25D12

Catalog Number: XBUT25D12

Eaton XB IEC terminal block, Screw Connection Multi-Conductor Terminal Blocks, Gray, 12 AWG/2.5 mm<sup>2</sup> maximum wire, Three-wire

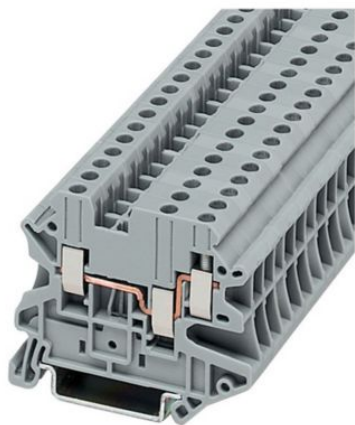

## General specifications

<b>Product Name</b>	<b>Catalog Number</b>
Eaton XB IEC terminal block	XBUT25D12
<b>UPC</b>	<b>Product Length/Depth</b>
782116905096	1.85 in
<b>Product Height</b>	<b>Product Width</b>
2.17 in	0.2 in
<b>Product Weight</b>	<b>Warranty</b>
0.02 lb	1 year
<b>Certifications</b>	
UL Listed	
CSA Certified	

## Product specifications

### Type

IEC-XB Series

### Amperage Rating

28A (IEC), 20A (UL)

### Voltage rating

IEC 500V, UL 150V

## Resources

### Specifications and datasheets

[Eaton Specification Sheet - XBUT25D12](#)



Eaton Corporation plc  
Eaton House  
30 Pembroke Road  
Dublin 4, Ireland  
Eaton.com

© 2025 Eaton. All Rights Reserved.

Eaton is a registered trademark.

All other trademarks are property of their respective owners.



[Eaton.com/socialmedia](https://Eaton.com/socialmedia)

# Eaton XBUT25D12

Catalog Number: XBUT25D12

Eaton XB IEC terminal block, Screw Connection Multi-Conductor Terminal Blocks, Gray, 12 AWG/2.5 mm<sup>2</sup> maximum wire, Three-wire

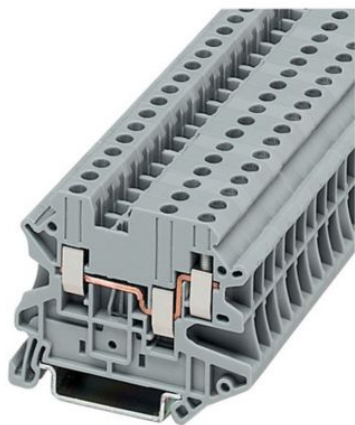

## General specifications

<b>Product Name</b>	<b>Catalog Number</b>
Eaton XB IEC terminal block	XBUT25D12
<b>UPC</b>	<b>Product Length/Depth</b>
782116905096	1.85 in
<b>Product Height</b>	<b>Product Width</b>
2.17 in	0.2 in
<b>Product Weight</b>	<b>Warranty</b>
0.02 lb	1 year
<b>Certifications</b>	
UL Listed	
CSA Certified	

## Product specifications

### Type

IEC-XB Series

### Amperage Rating

28A (IEC), 20A (UL)

### Voltage rating

IEC 500V, UL 150V

## Resources

### Specifications and datasheets

[Eaton Specification Sheet - XBUT25D12](#)



Eaton Corporation plc  
Eaton House  
30 Pembroke Road  
Dublin 4, Ireland  
Eaton.com

© 2025 Eaton. All Rights Reserved.

Eaton is a registered trademark.

All other trademarks are property of their respective owners.



[Eaton.com/socialmedia](https://Eaton.com/socialmedia)