

July 2004

Utilities Servicing Upstate New York

Metering Equipment

Contents

<i>Description</i>	<i>Page</i>
Meter Socket Catalog Number Logic	
Catalog Numbering System	2
Product Selection by Utility	
Niagara Mohawk (NIMO) Utility	4
New York State Electric & Gas (NYSEG)	5
Rochester Gas & Electric (RGE).....	6
Technical Data	
Knockout Drawings	7
Meter Packs	
Product Description	8
Product Selection	8
Main Tenant Circuit Breakers	
Product Description	10
Product Selection	10
Dimensions and Knockouts.....	11
Accessories	
Meter Packs.....	13



Group Metering

Catalog Numbering System

Table 1. "RS" Group Catalog Numbering System

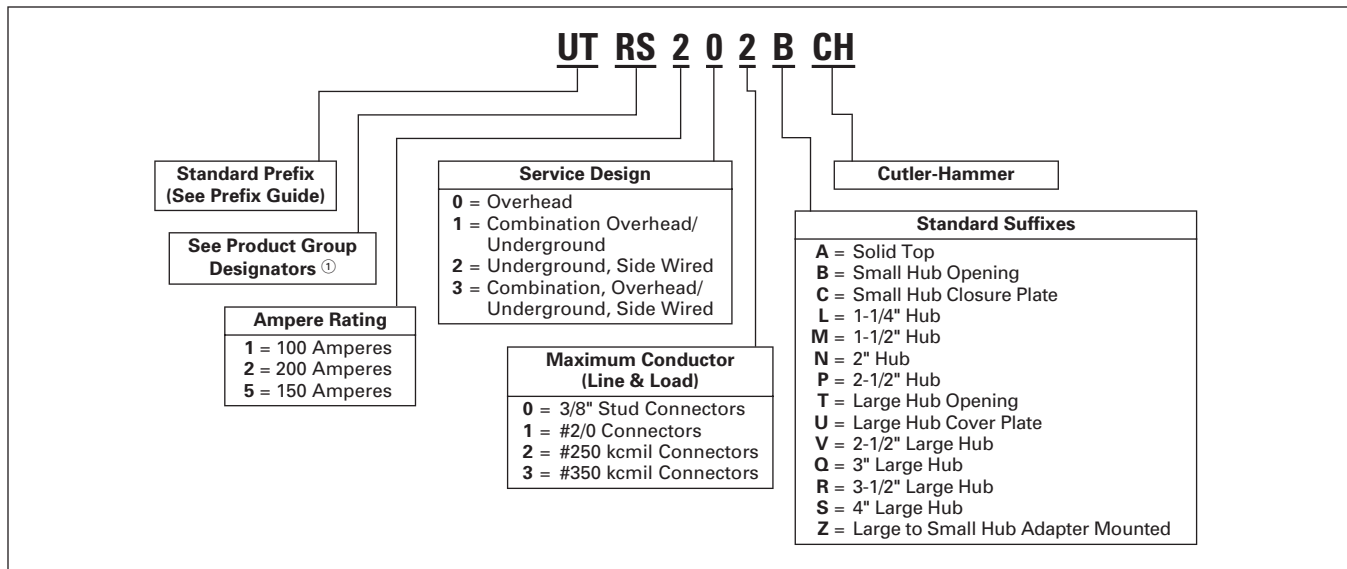

① "RS" Group = Residential Service, Single Position.

Note: Some sockets that are built for specific utilities have their own unique catalog numbers. These can be found on the utility selection pages.

Meter Socket "Prefix" Guide

A	Aluminum enclosure
B	Barrel lock provision, for an exposed INNER-TITE® or Brooks barrel lock; unit includes an internal lock receiver bracket.
F	Barrel lock with guard provision, for a lock guard INNER-TITE or Brooks barrel lock; unit includes an internal lock receiver bracket.
G	Grounded fifth terminal (9 o'clock position)
H	Horn bypass
I	Inhibitor installed in wire connectors
M	Temporary meter cover (waxed cardboard)
N	No sealing ring (applies only to ring style sockets)
R	Ring style socket
S	Aluminum screw type sealing ring (applies only to ring style sockets)
T	Grounding connector (#14 – #2 Cu) for Tri-Plex ground
TT	Two (2) grounding connectors (#14 – #2 Cu) for Quad-Plex ground
U	UL® (Underwriters Laboratories) labeled
Z	5/16" Hex head connector screw in place of slotted (100 amperes only)

Note: The "U" prefix is always used first followed by other prefixes required in alphabetical order.

Table 2. "2R-6R" and "2H-6H" Group Catalog Numbering System

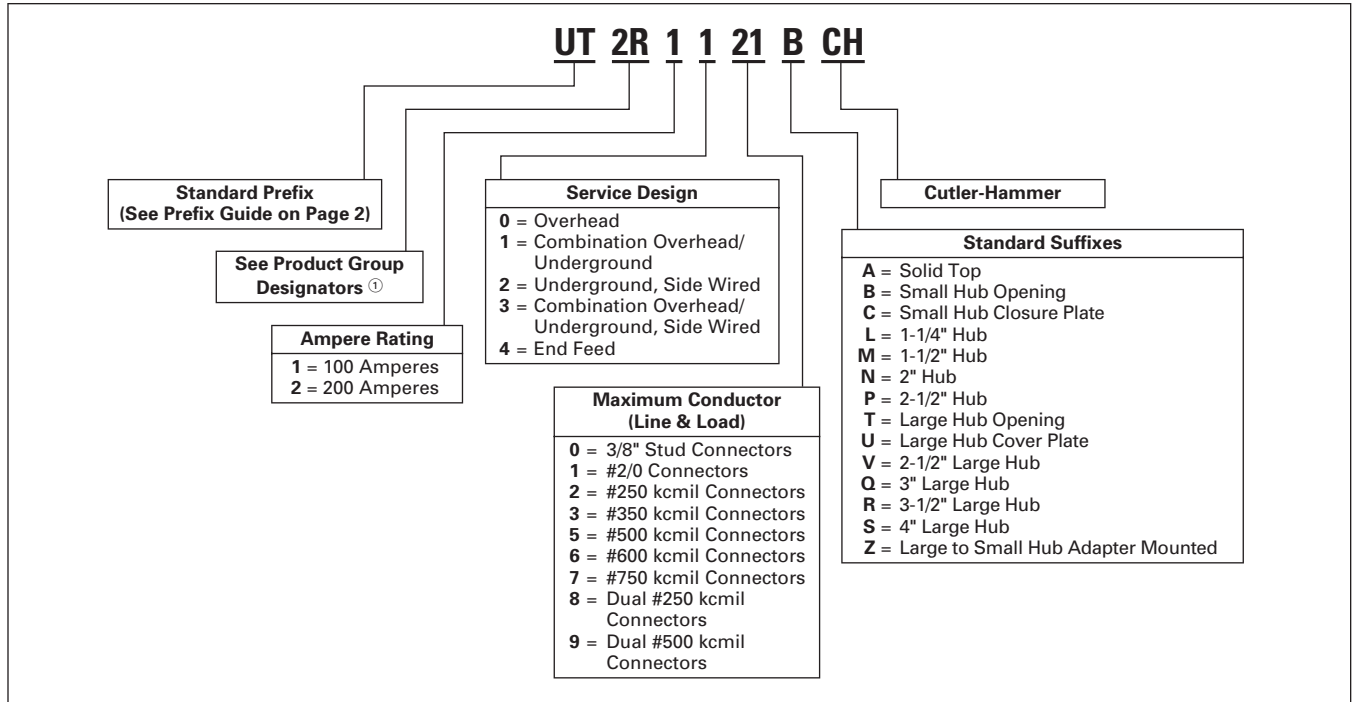

① "2R-6R" Group = Residential Service, Multiple Position.
"2H-6H" Group = Commercial or Residential Service, Multiple Position.

Table 3. "H" Group Catalog Numbering System

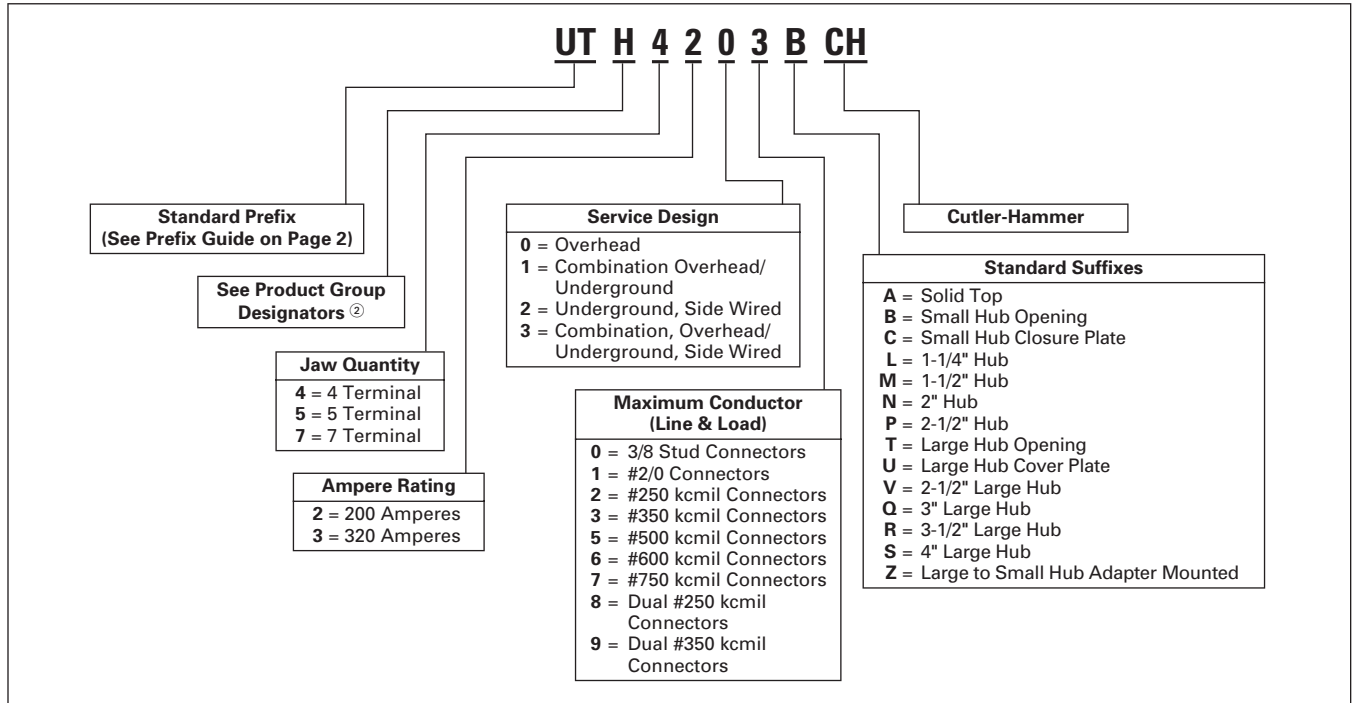

② "H" Group = Commercial or Residential Service, Single Position (lever bypass).

Product Selection by Utility

Niagara Mohawk (NIMO) Utility



200 Ampere Single-Position
Meter Socket



320 Ampere Lever Bypass
Meter Socket



200 Ampere Lever Bypass
Meter Socket



200 Ampere Multi-Position
Meter Socket

Table 4. Niagara Mohawk (NIMO) Utility

Cutler-Hammer Catalog Number	Description	Dimensions			Connections		Concentric Knockouts (See Page 7)				
		H	W	D	Line	Load	1	2	3	4	5
100 – 200 Ampere Single-Position — Residential Single-Phase											
UFTRS202BCH	125 – 200 A, 4 Terminal, SM Hub Open, OH ①②	14.00	8.00	4.38	#8 – 250 kcmil	#8 – 250 kcmil	2.50	2.50	2.50	—	.50
UFHTRS213CCH	125 – 200 A, 4 Terminal, SM Hub Cover Plate, OH ①②③④	15.00	11.00	4.38	#8 – 350 kcmil	#8 – 350 kcmil	2.50	2.50	2.50	2.50	.50
1009046CH	125 – 200 A, 4 Terminal, Solid Top, UG ①②⑤	20.75	9.00	4.94	3/8" Stud	#8 – 350 kcmil	2.50	—	—	2.50	.50
200 Ampere Single-Position — Commercial w/ Lever Bypass											
UETH5203BCH	200 A, 5 Terminal, SM Hub Open, OH ①②⑥	19.00	10.50	4.94	#6 – 350 kcmil	#6 – 350 kcmil	3.00	2.50	3.00	—	.50
UETH5213UCH	200 A, 5 Terminal, LG Hub Cover Plate, OH/UG ①②⑥	19.00	13.00	4.94	#6 – 350 kcmil	#6 – 350 kcmil	3.00	2.50	3.00	3.00	.50
UETH7203TCH	200 A, 7 Terminal, LG Hub Open, OH ①②⑥	19.00	10.50	4.94	#6 – 350 kcmil	#6 – 350 kcmil	3.00	2.50	3.00	—	.50
UETH7213UCH	200 A, 7 Terminal, LG Hub Cover Plate, OH/UG ①②④⑥	19.00	13.00	4.94	#6 – 350 kcmil	#6 – 350 kcmil	3.00	2.50	3.00	3.00	.50
320 Ampere Commercial — Residential w/ Lever Bypass											
UFTH4300TCH	320 A, 4 Terminal, LG Hub Open, OH ①②⑥	34.50	13.00	4.94	3/8" Stud	3/8" Stud	3.00	3.00	3.00	3.00	.50
UFTH4300TCH	320 A, 4 Terminal, LG Hub Open, OH/UG ①②⑥	36.63	15.00	5.69	3/8" Stud	3/8" Stud	3.50	3.50	3.50	3.50	.50
UFTH7300TCH	320 A, 7 Terminal, LG Hub Open, OH ①②⑥	34.50	15.00	5.69	3/8" Stud	3/8" Stud	3.50	3.50	3.50	3.50	.50
UFTH7330TCH	320 A, 7 Terminal, LG Hub Open, OH/UG ①②⑥	39.88	20.00	6.50	3/8" Stud	3/8" Stud	4.00	4.00	4.00	4.00	.50
200 Ampere Multi-Position — Residential Single-Phase											
UEHT2R2302UCH	200 A, 2 Position, LG Hub Cover Plate, OH/UG ①②③④⑦	14.13	24.31	5.38	#6 – 350 kcmil	#8 – 250 kcmil	2.50	2.50	3.00	2.50	.50
UEHT3R2302UCH	200 A, 3 Position, LG Hub Cover Plate, OH/UG ①②③④⑦	14.13	32.47	5.38	#6 – 350 kcmil	#8 – 250 kcmil	2.50	2.50	3.00	2.50	.50
UEHT4R2302UCH	200 A, 4 Position, LG Hub Cover Plate, OH/UG ①②③④⑦	14.13	40.63	5.38	1/0 – 500 kcmil	#8 – 250 kcmil	2.50	2.50	3.00	2.50	.75
UEHT5R2302UUCH	200 A, 5 Position, LG Hub Cover Plate, OH/UG ①②③④⑦	14.13	54.78	5.38	1/0 – 500 kcmil	#8 – 250 kcmil	2.50	2.50	3.00	2.50	.75
UEHT6R2302UUCH	200 A, 6 Position, LG Hub Cover Plate, OH/UG ①②③④⑦	14.13	62.94	5.38	1/0 – 500 kcmil	#8 – 250 kcmil	2.50	2.50	3.00	2.50	.75

- ① Ground connection.
- ② Barrel lock provision.
- ③ Horn bypass.
- ④ Approved by both NIMO and New York State Electric & Gas (NYSEG).
- ⑤ Low profile design.
- ⑥ Lever bypass.
- ⑦ Center feed.

Table 5. Cutler-Hammer Meter Socket Accessories

Cutler-Hammer Catalog Number	Description	Cutler-Hammer Catalog Number	Description
ARP00003CH1	1.00-Inch Hub	ARP00008CH	Small Hub Closure Plate — Aluminum
ARP00004CH12	1.25-Inch Hub	ARP00016CHB	Large Hub Closure Plate
ARP00005CH15	1.50-Inch Hub	ARP00015CHAP	Hub Adapter Plate — Large to Small
ARP00006CH2	2.00-Inch Hub — Small Opening	ARP00035CHJ	Replacement — Plug-in Fifth Terminal (R and RS Models Only)
ARP00007CH25	2.50-Inch Hub — Small Opening	ARP00039CH	Replacement Block Assembly for 100 A Sockets — 2/0 Maximum
ARP00017CH2	2.00-Inch Hub — Large Opening	ARP00048CH	Replacement Block Assembly for 200 A Sockets — 350 Maximum
ARP00018CH25	2.50-Inch Hub — Large Opening	ARP00354CH	Replacement Block Assembly for 150 A Sockets — 250 Maximum
ARP00019CH3	3.00-Inch Hub — Large Opening	ARP00129CH	#4 – 600 kcmil Lug
ARP00021CH4	4.00-Inch Hub — Large Opening	ARP00427CH	#6 – 350 kcmil Dual Lug
ARP00002CHB	Small Hub Closure Plate	ARP00119CH	#6 – 350 kcmil Lug

New York State Electric & Gas (NYSEG)



100 Ampere Single-Position Meter Socket



200 Ampere Single-Position Meter Socket



200 Ampere Lever Bypass Meter Socket



200 Ampere Multi-Position Meter Socket

Table 6. New York State Electric & Gas (NYSEG)

Cutler-Hammer Catalog Number	Description	Dimensions			Connections		Concentric Knockouts (See Page 7)				
		H	W	D	Line	Load	1	2	3	4	5
100 – 125 Ampere Single-Position — Residential Single-Phase											
UHTRS101BCH	125 A, 4 Terminal, SM Hub Open, OH/UG ①②	10.88	8.00	3.50	#8 – 2/0	#8 – 2/0	1.50	1.50	2.00	1.25	—
200 Ampere Single-Position — Residential Single-Phase											
UHTRS202BCH	200 A, 4 Terminal, SM Hub Open, OH ①②	14.00	8.00	4.38	#8 – 250 kcmil	#8 – 250 kcmil	2.50	2.50	2.50	—	.50
UFHTRS213CCH	200 A, 4 Terminal, SM Hub Cover Plate, OH/UG ①②③④	15.00	11.00	4.38	#8 – 350 kcmil	#8 – 350 kcmil	2.50	2.50	2.50	2.50	.50
UHTRS213BCH	200 A, 4 Terminal, SM Hub Open, OH/UG ①②	15.00	11.00	4.38	#8 – 350 kcmil	#8 – 350 kcmil	2.50	2.50	2.50	2.50	.50
200 Ampere Single-Position — Commercial 3-Phase w/ Lever Bypass											
UHT7213UCH	200 A, 7 Terminal, LG Hub Cover Plate, OH/UG ①⑤	19.00	13.00	4.94	#6 – 350 kcmil	#6 – 350 kcmil	3.00	2.50	3.00	3.00	.50
UETH7213UCH	200 A, 7 Terminal, LG Hub Cover Plate, OH/UG ①③④⑤	19.00	13.00	4.94	#6 – 350 kcmil	#6 – 350 kcmil	3.00	2.50	3.00	3.00	.50
125 Ampere Multi-Position — Residential Single-Phase											
UHT2R1121BCH	125 A, 2 Position, SM Hub Open, OH/UG ①②⑥	14.13	24.31	4.50	#6 – 250 kcmil	#8 – 2/0	2.50	2.50	2.50	2.50	.50
UHT3R1121BCH	125 A, 3 Position, SM Hub Open, OH/UG ①②⑥	14.13	32.47	4.50	#6 – 250 kcmil	#8 – 2/0	2.50	2.50	2.50	2.50	.50
UHT4R1121BCH	125 A, 4 Position, SM Hub Open, OH/UG ①②⑥	14.13	40.63	4.50	#6 – 250 kcmil	#8 – 2/0	2.50	2.50	2.50	2.50	.50
UHT5R1121BCH	125 A, 5 Position, SM Hub Open, OH/UG ①②⑥	14.13	48.78	4.50	#6 – 250 kcmil	#8 – 2/0	2.50	2.50	2.50	2.50	.50
UHT6R1131BCH	125 A, 6 Position, SM Hub Open, OH/UG ①②⑥	14.13	56.94	4.50	#6 – 350 kcmil	#8 – 2/0	2.50	2.50	2.50	2.50	.50
UHT2R1421BCH	125 A, 2 Position, SM Hub Open, OH/UG ①②⑦	14.13	20.16	5.38	#6 – 250 kcmil	#8 – 2/0	2.50	2.50	3.00	2.50	.50
UHT3R1421BCH	125 A, 3 Position, SM Hub Open, OH/UG ①②⑦	14.13	28.31	5.38	#6 – 250 kcmil	#8 – 2/0	2.50	2.50	3.00	2.50	.50
UHT4R1421BCH	125 A, 4 Position, SM Hub Open, OH/UG ①②⑦	14.13	36.47	5.38	#6 – 250 kcmil	#8 – 2/0	2.50	2.50	3.00	2.50	.50
UHT5R1421BCH	125 A, 5 Position, SM Hub Open, OH/UG ①②⑦	14.13	44.63	5.38	#6 – 250 kcmil	#8 – 2/0	2.50	2.50	3.00	2.50	.50
UHT6R1431BCH	125 A, 6 Position, SM Hub Open, OH/UG ①②⑦	14.13	52.78	5.38	#6 – 350 kcmil	#8 – 2/0	2.50	2.50	3.00	2.50	.50
200 Ampere Multi-Position — Residential Single-Phase											
UHT2R2332TCH	200 A, 2 Position, LG Hub Open, OH/UG ①②⑥	14.13	24.16	5.38	#6 – 350 kcmil	#8 – 250 kcmil	2.50	2.50	3.00	2.50	.50
UHT3R2332TCH	200 A, 3 Position, LG Hub Open, OH/UG ①②⑥	14.13	32.47	5.38	#6 – 350 kcmil	#8 – 250 kcmil	2.50	2.50	3.00	2.50	.50
UHT4R2352TCH	200 A, 4 Position, LG Hub Open, OH/UG ①②⑥	14.13	40.63	5.38	1/0 – 500 kcmil	#8 – 250 kcmil	2.50	2.50	3.00	2.50	.75
UHT5R2392TTCH	200 A, 5 Position, LG Hub Open, OH/UG ①②⑥	14.13	54.78	5.38	1/0 – 500 kcmil	#8 – 250 kcmil	2.50	2.50	3.00	2.50	.75
UHT6R2392TTCH	200 A, 6 Position, LG Hub Open, OH/UG ①②⑥	14.13	62.94	5.38	1/0 – 500 kcmil	#8 – 250 kcmil	2.50	2.50	3.00	2.50	.75
UEHT2R2302UCH	200 A, 2 Position, LG Hub Cover Plate, OH/UG ①②③④⑥	14.13	24.31	5.38	#6 – 350 kcmil	#8 – 250 kcmil	2.50	2.50	3.00	2.50	.50
UEHT3R2302UCH	200 A, 3 Position, LG Hub Cover Plate, OH/UG ①②③④⑥	14.13	32.47	5.38	#6 – 350 kcmil	#8 – 250 kcmil	2.50	2.50	3.00	2.50	.50
UEHT4R2302UCH	200 A, 4 Position, LG Hub Cover Plate, OH/UG ①②③④⑥	14.13	40.63	5.38	1/0 – 500 kcmil	#8 – 250 kcmil	2.50	2.50	3.00	2.50	.75
UEHT5R2302UUCH	200 A, 5 Position, LG Hub Cover Plate, OH/UG ①②③④⑥	14.13	54.78	5.38	1/0 – 500 kcmil	#8 – 250 kcmil	2.50	2.50	3.00	2.50	.75
UEHT6R2302UUCH	200 A, 6 Position, LG Hub Cover Plate, OH/UG ①②③④⑥	14.13	62.94	5.38	1/0 – 500 kcmil	#8 – 250 kcmil	2.50	2.50	3.00	2.50	.75

- ① Ground connection.
- ② Horn bypass.
- ③ Barrel lock provision.
- ④ Approved by both NIMO and NYSEG.
- ⑤ Lever bypass.
- ⑥ Center feed.
- ⑦ End feed.

Table 7. Cutler-Hammer Meter Socket Accessories

Cutler-Hammer Catalog Number	Description	Cutler-Hammer Catalog Number	Description
ARP00003CH1	1.00-Inch Hub	ARP00008CH	Small Hub Closure Plate — Aluminum
ARP00004CH12	1.25-Inch Hub	ARP00016CHB	Large Hub Closure Plate
ARP00005CH15	1.50-Inch Hub	ARP00015CHAP	Hub Adapter Plate — Large to Small
ARP00006CH2	2.00-Inch Hub — Small Opening	ARP00035CHJ	Replacement — Plug-in Fifth Terminal (R and RS Models Only)
ARP00007CH25	2.50-Inch Hub — Small Opening	ARP00039CH	Replacement Block Assembly for 100 A Sockets — 2/0 Maximum
ARP00017CH2	2.00-Inch Hub — Large Opening	ARP00048CH	Replacement Block Assembly for 200 A Sockets — 350 Maximum
ARP00018CH25	2.50-Inch Hub — Large Opening	ARP00354CH	Replacement Block Assembly for 150 A Sockets — 250 Maximum
ARP00019CH3	3.00-Inch Hub — Large Opening	ARP00129CH	#4 – 600 kcmil Lug
ARP00021CH4	4.00-Inch Hub — Large Opening	ARP00427CH	#6 – 350 kcmil Dual Lug
ARP00002CHB	Small Hub Closure Plate	ARP00119CH	#6 – 350 kcmil Lug

Product Selection by Utility

Rochester Gas & Electric (RGE)



150 Ampere Single-Position
Meter Socket



320 Ampere Lever Bypass
Meter Socket



200 Ampere Multi-Position
Meter Socket



200 Ampere Single-Position
Meter Socket

Table 8. Rochester Gas & Electric (RGE)

Cutler-Hammer Catalog Number	Description	Dimensions			Connections		Concentric Knockouts (See Page 7)				
		H	W	D	Line	Load	1	2	3	4	5
150 Ampere Single-Position — Residential Single-Phase											
1007699CH	150 A, 4 Terminal, SM Hub Open, OH ①②	14.00	8.00	4.38	#8 – 250 kcmil	#8 – 250 kcmil	2.50	2.50	2.50	—	.50
UHTRS202BCH	150 A, 4 Terminal, SM Hub Open, OH ①②③	14.00	8.00	4.38	#8 – 250 kcmil	#8 – 250 kcmil	2.50	2.50	2.50	—	.50
200 Ampere Single-Position — Residential Single-Phase											
1007476CH	200 A, 4 Terminal, LG Hub Cover Plate, UG ①④	26.81	13.00	4.94	3/8" Stud	3/8" Stud	3.00	3.00	3.00	3.00	.50
1007817CH	200 A, 4 Terminal, SM Hub Open, OH/UG ①②	15.00	11.00	4.38	#8 – 350 kcmil	#8 – 350 kcmil	2.50	2.50	2.50	2.50	.50
UHTRS213CCH	200 A, 4 Terminal, SM Hub Cover Plate, OH/UG ①②③	15.00	11.00	4.38	#8 – 350 kcmil	#8 – 350 kcmil	2.50	2.50	2.50	2.50	.50
320 Ampere Commercial — Residential w/ Lever Bypass											
1007818CH	320 A, 4 Terminal, LG Hub Open, OH/UG ①④	36.63	15.00	5.69	3/8" Stud	3/8" Stud	3.50	3.50	3.50	3.50	.50
UTH4330TCH	320 A, 4 Terminal, LG Hub Open, OH/UG ①③④	36.63	15.00	5.69	3/8" Stud	3/8" Stud	3.50	3.50	3.50	3.50	.50
200 Ampere Multi-Position — Residential Single-Phase											
1007700CH	200 A, 2 Position, LG Hub Open, OH/UG ①②⑤	14.13	24.31	5.38	#6 – 350 kcmil	#8 – 250 kcmil	2.50	2.50	3.00	2.50	.50
UEHT2R2302UCH	200 A, 2 Position, LG Hub Cover Plate, OH/UG ①②③⑤⑥⑦	14.13	24.31	5.38	#6 – 350 kcmil	#8 – 250 kcmil	2.50	2.50	3.00	2.50	.50
1007701CH	200 A, 3 Position, LG Hub Open, OH/UG ①②⑤	14.13	32.47	5.38	#6 – 350 kcmil	#8 – 250 kcmil	2.50	2.50	3.00	2.50	.50
UEHT3R2302UCH	200 A, 3 Position, LG Hub Cover Plate, OH/UG ①②③⑤⑥⑦	14.13	32.47	5.38	#6 – 350 kcmil	#8 – 250 kcmil	2.50	2.50	3.00	2.50	.50
1007702CH	200 A, 4 Position, LG Hub Open, OH/UG ①②⑤	14.13	40.63	5.38	1/0 – 500 kcmil	#8 – 250 kcmil	2.50	2.50	3.00	2.50	.75
UEHT4R2302UCH	200 A, 4 Position, LG Hub Cover Plate, OH/UG ①②③⑤⑥⑦	14.13	40.63	5.38	1/0 – 500 kcmil	#8 – 250 kcmil	2.50	2.50	3.00	2.50	.75
1007703CH	200 A, 5 Position, LG Hub Open, OH/UG ①②⑤	14.13	54.78	5.38	1/0 – 500 kcmil	#8 – 250 kcmil	2.50	2.50	3.00	2.50	.75
UEHT5R2302UUCH	200 A, 5 Position, LG Hub Cover Plate, OH/UG ①②③⑤⑥⑦	14.13	54.78	5.38	1/0 – 500 kcmil	#8 – 250 kcmil	2.50	2.50	3.00	2.50	.75
1007704CH	200 A, 6 Position, LG Hub Open, OH/UG ①②⑤	14.13	62.94	5.38	1/0 – 500 kcmil	#8 – 250 kcmil	2.50	2.50	3.00	2.50	.75
UEHT6R2302UUCH	200 A, 6 Position, LG Hub Cover Plate, OH/UG ①②③⑤⑥⑦	14.13	62.94	5.38	1/0 – 500 kcmil	#8 – 250 kcmil	2.50	2.50	3.00	2.50	.75

① Ground connection.

② Horn bypass.

③ No RGE label.

④ Lever bypass.

⑤ Center feed.

⑥ Barrel lock provision.

⑦ Approved by NIMO, NYSEG and RGE.

Note: Please note that Rochester Gas & Electric will no longer require the RGE label on the unit effective 1/1/2005.

Table 9. Cutler-Hammer Meter Socket Accessories

Cutler-Hammer Catalog Number	Description	Cutler-Hammer Catalog Number	Description
ARP00003CH1	1.00-Inch Hub	ARP00008CH	Small Hub Closure Plate — Aluminum
ARP00004CH12	1.25-Inch Hub	ARP00016CHB	Large Hub Closure Plate
ARP00005CH15	1.50-Inch Hub	ARP00015CHAP	Hub Adapter Plate — Large to Small
ARP00006CH2	2.00-Inch Hub — Small Opening	ARP00035CHJ	Replacement — Plug-in Fifth Terminal (R and RS Models Only)
ARP00007CH25	2.50-Inch Hub — Small Opening	ARP00039CH	Replacement Block Assembly for 100 A Sockets — 2/0 Maximum
ARP00017CH2	2.00-Inch Hub — Large Opening	ARP00048CH	Replacement Block Assembly for 200 A Sockets — 350 Maximum
ARP00018CH25	2.50-Inch Hub — Large Opening	ARP00354CH	Replacement Block Assembly for 150 A Sockets — 250 Maximum
ARP00019CH3	3.00-Inch Hub — Large Opening	ARP00129CH	#4 – 600 kcmil Lug
ARP00021CH4	4.00-Inch Hub — Large Opening	ARP00427CH	#6 – 350 kcmil Dual Lug
ARP00002CHB	Small Hub Closure Plate	ARP00119CH	#6 – 350 kcmil Lug

July 2004

Technical Data

Knockout Drawings

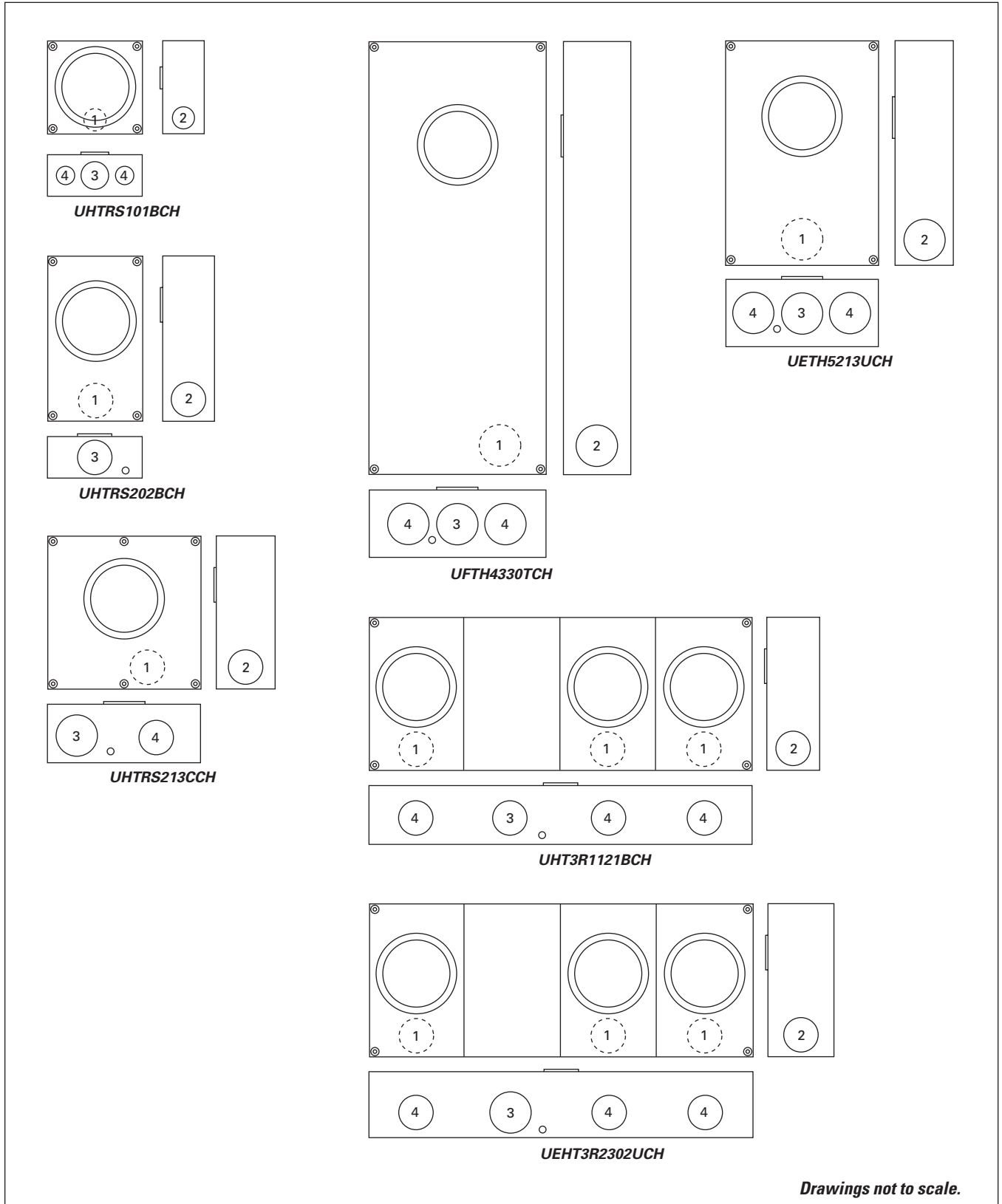

Figure 1. Knockout Drawings

Meter Packs

Product Description



Meter Pack

- Cutler-Hammer 1MP units by Eaton Electrical are self-contained (main terminal box included) for installations requiring up to six meter socket positions in a single enclosure.
- Units are not gangable with any other metering device.
- Approved by major power companies, UL listed, suitable as service equipment and meets the service and electrical requirements of EUSERC and CECHA.
- Series rating up to 100 kAIC.
- All ringless cover devices include fifth jaw as standard.
- Ring type devices do not include fifth jaw as standard. Order **1MM5JK** if needed.
- Bondable neutral.
- 120/240 Vac, single-phase, 3-wire metering device.
- Up to 600 amperes maximum horizontal bus rating.
- Incoming lugs not included (phase A, phase B, and neutral).
- Indoor/outdoor construction.
- Provision for 2-pole breaker (plug-on type for 125 ampere sockets and bolt-on type for 200 ampere sockets) — circuit breakers not included.
- Underground incoming feed.
- Aluminum or copper bus.

Product Selection

Table 10. Meter Pack Catalog Numbering System

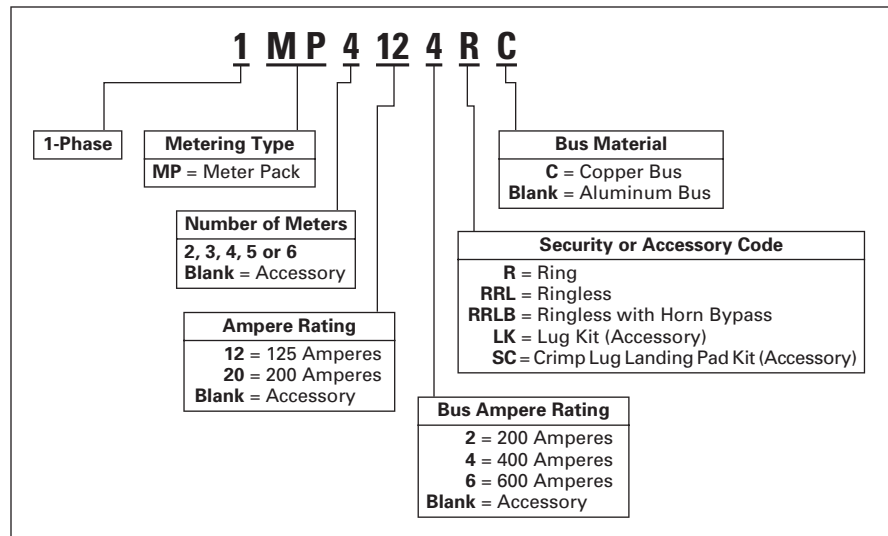

When Ordering:

1. Determine catalog number of the basic device.
2. Include Lug Kit for incoming section. See **Table 14**.
3. Find quantity and catalog numbers for tenant circuit breakers. (Order one breaker per socket.) See **Page 10**.
4. Select required accessories. See **Page 13**.

Table 11. Meter Packs — Aluminum Bus

Socket Ampere Rating	Number of Meter Sockets	Bus Ampere Rating	Main Tenant Breaker Type ①	Catalog Number	Semi-flush Flange Kit Catalog Number
Ringless Style Meter Socket Covers ②					
125	2	200	Plug-on Type	1MP2122RRL ③④	1MPSFK1
	2	200	Plug-on Type	1MP2122RRLC	1MPSFK1
	3	400	BR_	1MP3124RRL	1MPSFK2
	4	400	BRH_	1MP4124RRL	1MPSFK2
	5	600	BRHH_	1MP5126RRL	1MPSFK3
	6	600	—	1MP6126RRL	1MPSFK3
200	2	400	Bolt-on Type	1MP2204RRL	1MPSFK4
	3	600	CC2_X	1MP3206RRL	1MPSFK5
	4	600	CHH2_H2X	1MP4206RRL	1MPSFK5
	5	600	CHH2_H4X	1MP5206RRL	1MPSFK6
	5	600	CHH_X	1MP6206RRL	1MPSFK6
	6	600	—	—	—
Ringless Style Covers with Horn Bypass ②					
125	2	200	Plug-on Type	1MP2122RRLB ③④⑤	1MPSFK1
	2	200	Plug-on Type	1MP2122RRLBC ⑤	1MPSFK1
	3	400	BR_	1MP3124RRLB ⑤	1MPSFK2
	4	400	BRH_	1MP4124RRLB ⑤	1MPSFK2
	5	600	BRHH_	1MP5126RRLB ⑤	1MPSFK3
	6	600	—	1MP6126RRLB ⑤	1MPSFK3
200	2	400	Bolt-on Type	1MP2204RRLB ⑤	1MPSFK4
	3	600	CC2_X	1MP3206RRLB ⑤	1MPSFK5
	4	600	CHH2_H2X	1MP4206RRLB	1MPSFK5
	5	600	CHH2_H4X	1MP5206RRLB ⑤	1MPSFK6
	5	600	CHH_X	1MP6206RRLB ⑤	1MPSFK6
	6	600	—	—	—

① See **Table 16**.

② Fifth jaw factory installed at 9 o'clock position.

③ Main lugs included. #6 – 300 kcmil. (Optional lugs are not available.)

④ Bottom feed only.

⑤ CECHA approved.

Note: See **Table 14** for Main Lug Kit Selection. See **Table 15** for Wire Sizes.

July 2004

Meter Packs

Table 12. Meter Packs — Copper Bus

Socket Ampere Rating	Number of Meter Sockets	Bus Ampere Rating	Main Tenant Breaker Type ^①	Catalog Number	Semi-flush Flange Kit Catalog Number
Ringless Style Meter Socket Covers ^②					
125	3	400	Plug-on Type	1MP3124RRLC	1MP5FK2
	4	400	BR_	1MP4124RRLC	1MP5FK2
	5	600	BRH_	1MP5126RRLC	1MP5FK3
	6	600	BRHH_	1MP6126RRLC	1MP5FK3
200	2	400	Bolt-on Type	1MP2204RRLC	1MP5FK4
	3	600	CC2_X	1MP3206RRLC	1MP5FK5
	4	600	CHH2_H2X	1MP4206RRLC	1MP5FK5
	5	600	CHH2_H4X	1MP5206RRLC	1MP5FK6
6	600	CHH_X	1MP6206RRLC	1MP5FK6	

Ringless Style Covers with Horn Bypass ^{②③}

125	3	400	Plug-on Type	1MP3124RRLBC	1MP5FK2
	4	400	BR_	1MP4124RRLBC	1MP5FK2
	5	600	BRH_	1MP5126RRLBC	1MP5FK3
	6	600	BRHH_	1MP6126RRLBC	1MP5FK3
200	2	400	Bolt-on Type	1MP2204RRLBC	1MP5FK4
	3	600	CC2_X	1MP3206RRLBC	1MP5FK5
	4	600	CHH2_H2X	1MP4206RRLBC	1MP5FK5
	5	600	CHH2_H4X	1MP5206RRLBC	1MP5FK6
6	600	CHH_X	1MP6206RRLBC	1MP5FK6	

① See Table 16.

② Fifth jaw factory installed at 9 o'clock position.

③ CECHA approved.

Table 13. CECHA Approved Meter Socket Accessories

Description	Catalog Number
Pedestal Trough Raceway for Underground Services ^④	
36.00-Inch Pedestal Trough Raceway (36.00" H 9.00" W 4.25" D)	1008934CH
Adapter Plates	
Adapter Plate for 2 – 4 Gang	1MP34EW125
Adapter Plate for 5 – 6 Gang	1MP56EW125

④ Bottom raceway adapter plates required.

Table 14. Main Lug Kit Selection —
Field Installed Kits for Either 400 or 600 Ampere Main Bus

Line Lug and Wire Sizes Order Separately and Field Install	Line Lug Kit Catalog Number Order Three Kits (For Two Lines and Neutral)
(1) #6 – 600 kcmil or (2) 2/0 – 250 kcmil (2) 250 – 500 kcmil (3) #4 – 300 kcmil (1) 750 kcmil Crimp lug landing pad 250 – 750 kcmil	1MPLK1 1MPLK3 1MPLK4 1MPLK2 ^⑤ 1MPSC1 ^⑥

⑤ This lug is not UL listed.

⑥ This kit comes with three pads for two lines and neutral. Each pad will accept one or two crimp lugs. Cannot be used on 1MP2122R, RL and RLB EUSERC underground termination.

Table 15. Wire Sizes — Neutral and Ground Lugs

Description	Wire Size, Al/Cu	Catalog Number
Neutral: 125 ampere meter pack 200 ampere meter pack	#6 – 2/0 #1/0 – 300 kcmil	— —
Equipment Ground Bar: 125 ampere meter pack 200 ampere meter pack	#14 – #2 #14 – 2/0	— —
Optional Ground Bar	#6 – 2/0	1MMGBK

Note: Each stack includes a neutral and ground bar.
If an extra ground bar is needed, order 1MMGBK.

Main Tenant Circuit Breakers

Product Description

1MP, 1MM and 3MM Main Tenant Circuit Breakers

The following Cutler-Hammer breakers are to be used on 1MP, 1MM and 3MM modular metering stacks. They are 120/240 Vac — field installed.



BR2100



CC2200

Product Selection

Table 16. 1MP, 1MM and 3MM Main Tenant Circuit Breakers

Description	Number of Poles	Main Tenant Circuit Breaker Ampere Rating	Catalog Number					
			10,000 AIC	22,000 AIC	25,000 AIC	42,000 AIC	100,000 AIC	
Plug-on type circuit breakers used with 1MP, 1MM and 3MM 125 ampere modular metering stacks	2	60	BR260	BRH260	—	BRHH260	—	
	2	70	BR270	BRH270	—	BRHH270	—	
	2	80	BR280	BRH280	—	BRHH280	—	
	2	90	BR290	BRH290	—	BRHH290	—	
	2	100	BR2100	BRH2100	—	BRHH2100	—	
	2	110	BR2110	BRH2110	—	BRHH2110	—	
	2	125	BR2125	BRH2125	—	BRHH2125	—	
	Bolt-on type circuit breakers used with 1MP, 1MM and 3MM 200 ampere modular metering stacks	2	60	—	—	CHH2060H2X	CHH2060H4X	CHH2060X
		2	70	—	—	CHH2070H2X	CHH2070H4X	CHH2070X
		2	80	—	—	CHH2080H2X	CHH2080H4X	CHH2080X
2		90	—	—	CHH2090H2X	CHH2090H4X	CHH2090X	
2		100	CC2100X	—	CHH2100H2X	CHH2100H4X	CHH2100X	
2		125	CC2125X	—	CHH2125H2X	CHH2125H4X	CHH2125X	
2		150	CC2150X	—	CHH2150H2X	CHH2150H4X	CHH2150X	
2		175	CC2175X	—	CHH2175H2X	CHH2175H4X	CHH2175X	
2	200	CC2200X	—	CHH2200H2X	CHH2200H4X	CHH2200X		

July 2004

Main Tenant Circuit Breakers

Dimensions and Knockouts (in Inches) — 1MP Meter Packs — Aluminum and Copper Bus

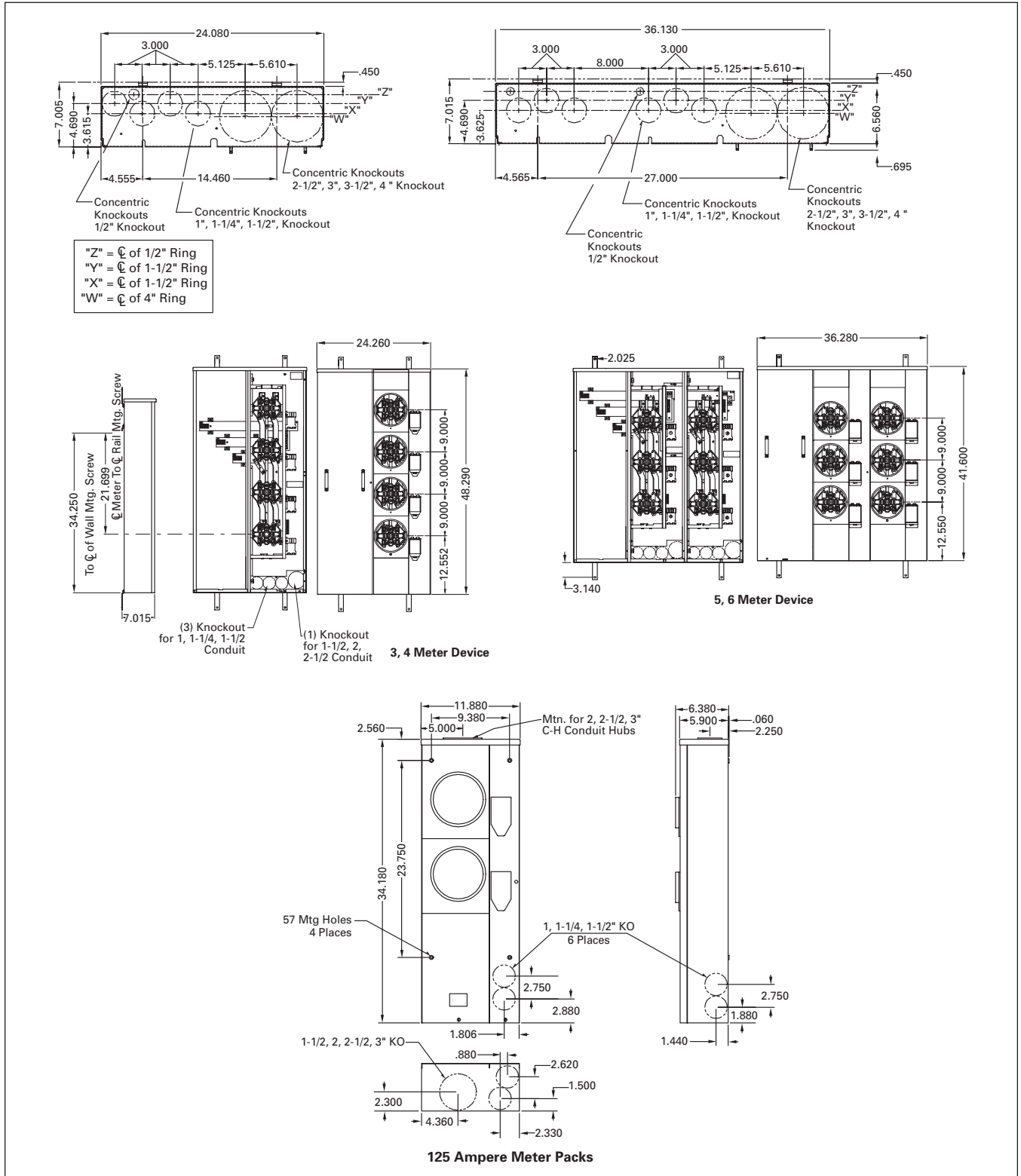

Figure 2. 125 Ampere Maximum Tenant Breaker

Meter Packs

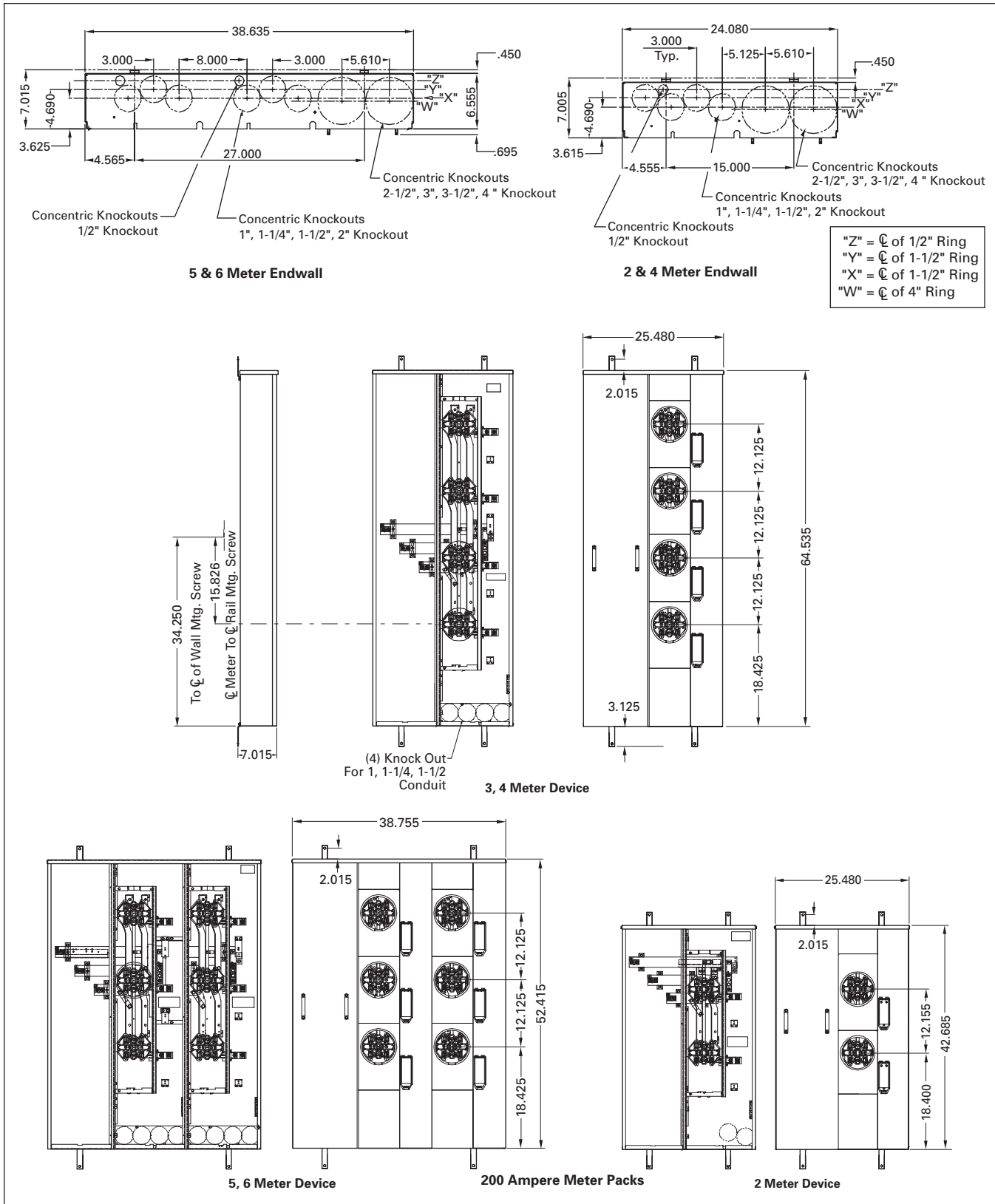

Figure 3. 200 Ampere Maximum Tenant Breaker

July 2004

Accessories

Meter Packs

Table 17. Accessories for 1MP, 1MM and 3MM Modular Metering Stacks

Description	Application	Catalog Number
Fifth Jaw Kit	Bolted onto neutral in the 3, 6 or 9 o'clock position. Typically used on network metering systems (3-phase in/single-phase out) or when specified by utility company.	1MM5JK
Isolated Fifth Jaw Kit	Connects to the neutral with an insulated wire.	1MM5JKOP
Horn Bypass	Used only on ringless cover stacks, kits can be installed on 125 ampere or 200 ampere sockets. Note: For 1MP2122RRL use:	1MMBPH WCG8HB
Meter Bypass Jumper	Installed on 125 ampere or 200 ampere sockets. Jumpers are plugged into jaws. Order Lexan® cover plate with bypass jumpers to prevent access to meter socket once energized. (Not UL listed.)	1MMBPJ
Lexan Blank Cover	Circular cover mounted on ring or ringless devices preventing access to meter socket while meter is not in place. Includes 4 plastic tabs which plug into each jaw.	1MMPCP
	Same as 1MMPCP minus the tabs located in the back to plug into jaws. This device to be used while meter bypass jumpers are in place (1MMBPJ).	1MMACP
Blank Meter Socket Cover	Used for 125 ampere stacks. Fits bottom socket only. Kit replaces existing meter cover preventing access to meter socket. Includes hasp for seal.	1MMBC125B
	Used on 200 ampere stacks. Fits bottom socket only. Kit replaces existing meter cover preventing access to meter socket. Includes hasp for seal.	1MMBC200B
Wall Mounting Rail	Rails are 4 feet (1.2 m) in length. Bolted on wall for stacks, packs, and mains to be hung.	1MMWB
Bussed Spacer	Bussed spacer 1200 ampere 4-inch (101.6 mm). Required when stacks are mounted on right-hand side in EUSERC areas. (Copper)	3MMBSK
Bus Duct Riser/ Meter Center Connection	Available in 400, 600, 800 ampere Main Fusible units only. Contact Product Line for details.	—



Fifth Jaw Kit



Horn Bypass Kit



Lexan Blank Cover



Wall Mounting Rail



Bussed Spacer

INNER-TITE is a registered trademark of Inner-Tite Corp. Lexan is a registered trademark of General Electric Co., USA. UL is a federally registered trademark of Underwriters Laboratories Inc.

This page intentionally left blank.

July 2004
Vol. 1, Ref. No. [01]

This page intentionally left blank.

Eaton Electrical Inc.
1000 Cherrington Parkway
Moon Township, PA 15108-4312
USA
tel: 1-800-525-2000
www.EatonElectrical.com