



MILBANK[®]
ENERGY AT WORK



New England

Area Catalog



Milbank designs and manufactures electrical solutions that move and manage power for the residential, commercial, industrial, utility and transportation sectors. With 90 years of expertise in electrical engineering design and manufacturing, Milbank's portfolio includes metering equipment, enclosures and enclosed controls. Founded in 1927, Milbank is a family-owned, American manufacturer headquartered in Kansas City, Mo. For more information, please visit milbankworks.com.

METERING



As a market leader in electrical metering equipment, Milbank has set the standard for quality since 1927. Hundreds of configurations are available, including many sizes, knockout configurations, terminal configurations, bypass options, hubs, locks and connectors. Milbank has the socket you need with thousands of active products to meet your utility's requirements.

ENCLOSURES



Milbank's line of enclosures include commercial junction boxes, panel mount enclosures, transformer cabinets, wireway, trough and industrial panel mount and push-button enclosures. Built with high-quality craftsmanship and materials which meet or exceed industry standards, Milbank enclosures are made to protect controls and equipment from dust, dirt and other harmful elements found in a wide variety of environments.

ENCLOSED CONTROLS



Milbank doesn't just build empty enclosures. We can deliver the entire package, complete with custom control equipment built to your exact specifications by our engineers. Milbank commercial pedestals are an attractive, secure, easy to install and cost-effective solution when underground remote site power distribution and control equipment is required, replacing unsightly and inefficient strut and backboard structures.



Please consult serving utility for their requirements prior to ordering or installing, as specifications and approvals vary by utility, and may require local electrical inspector approval. All installations must be installed by a licensed electrician and must comply with all national and local codes, laws and regulations. Milbank reserves the right to make changes in specifications and features shown without notice or obligation.

Air Conditioner Disconnects

30 & 60 amp AC disconnects	6
60 amp AC disconnect with 20 amp GFCI receptacle	7
Hot tub disconnects	8

Single Position Sockets

100 amps, 4 terminals, ringless, solar	9
125-200 amps, 4 terminals, ringless	10-12
125 amps, 5 & 7 terminals, medium duty lever bypass, ringless	13
200 amps, 5 terminals, medium duty lever bypass, ringless	14
200 amps, 4 terminals, heavy duty lever bypass, ringless	15
200 amps, 5 & 7 terminals, heavy duty lever bypass, ringless	16-17
320 amps, 4,5 & 7 terminals, heavy duty lever bypass, ringless	18-19

Meter Mains

100-200 amps, 4 terminals, ringless	20
100-200 amps, 4 terminals, lever bypass, ringless	21
100-200 amps, 4 terminals, meter main with load center, ringless	22
100-200 amps, 7 terminals, lever bypass, ringless	23
320 amps, 4 terminals, lever bypass, ringless	24
Cold Sequence, 200 & 400 amps, 7 terminals, lever bypass, ringless	25

Multi-Position

100 amps, 4 terminals, ringless & ring type, vertical	26
100 amps, 4 terminals, ringless	27-28
200 amps, 4 terminals, ringless	29
125 amps, 4 terminals, with single position lever bypass, ringless	30
100 amps, 5 terminals, lever bypass, ringless, vertical	31
100-200 amps, 5 terminals, lever bypass, ringless	32-33
200 amps, 7 terminals, lever bypass, ringless	34

Multi-Position Meter Mains

125 amps, 4 terminals, with single position lever, ringless	35
125 & 200 amps, 4 terminals, ringless	36-37
200 amps, 5 terminals, lever bypass, ringless	38

Please consult serving utility for their requirements prior to ordering or installing, as specifications and approvals vary by utility, and may require local electrical inspector approval. All installations must be installed by a licensed electrician and must comply with all national and local codes, laws and regulations. Milbank reserves the right to make changes in specifications and features shown without notice or obligation.



Transformer Rated

20 amps, 6 -13 terminals, plunger bypass, ringless	39
20 amps, 6 -13 terminals, test switch provision, ringless	40
20 amps, 6 -13 terminals, pre-wired, ringless	41
Test switches, test switch work sheet	42
CT Cabinets	43-44

Polyphase Enclosures

A base enclosures	45
-------------------------	----

Pedestals

Meter pedestal for pad mounting	46
200 amps, 4 terminal, direct bury	47
200 amps, 4 terminal, lever bypass, direct bury	48

Temp Power Units

125, 4 terminal, ringless	49
---------------------------------	----

Parts & Accessories

Circuit breakers and accessories	50-54
--	-------

Miscellaneous

Commercial pedestals	55-64
Reference information	65-69
Index	70



Please consult serving utility for their requirements prior to ordering or installing, as specifications and approvals vary by utility, and may require local electrical inspector approval. All installations must be installed by a licensed electrician and must comply with all national and local codes, laws and regulations. Milbank reserves the right to make changes in specifications and features shown without notice or obligation.

Catalog Number Logic

How our product catalog numbers are derived

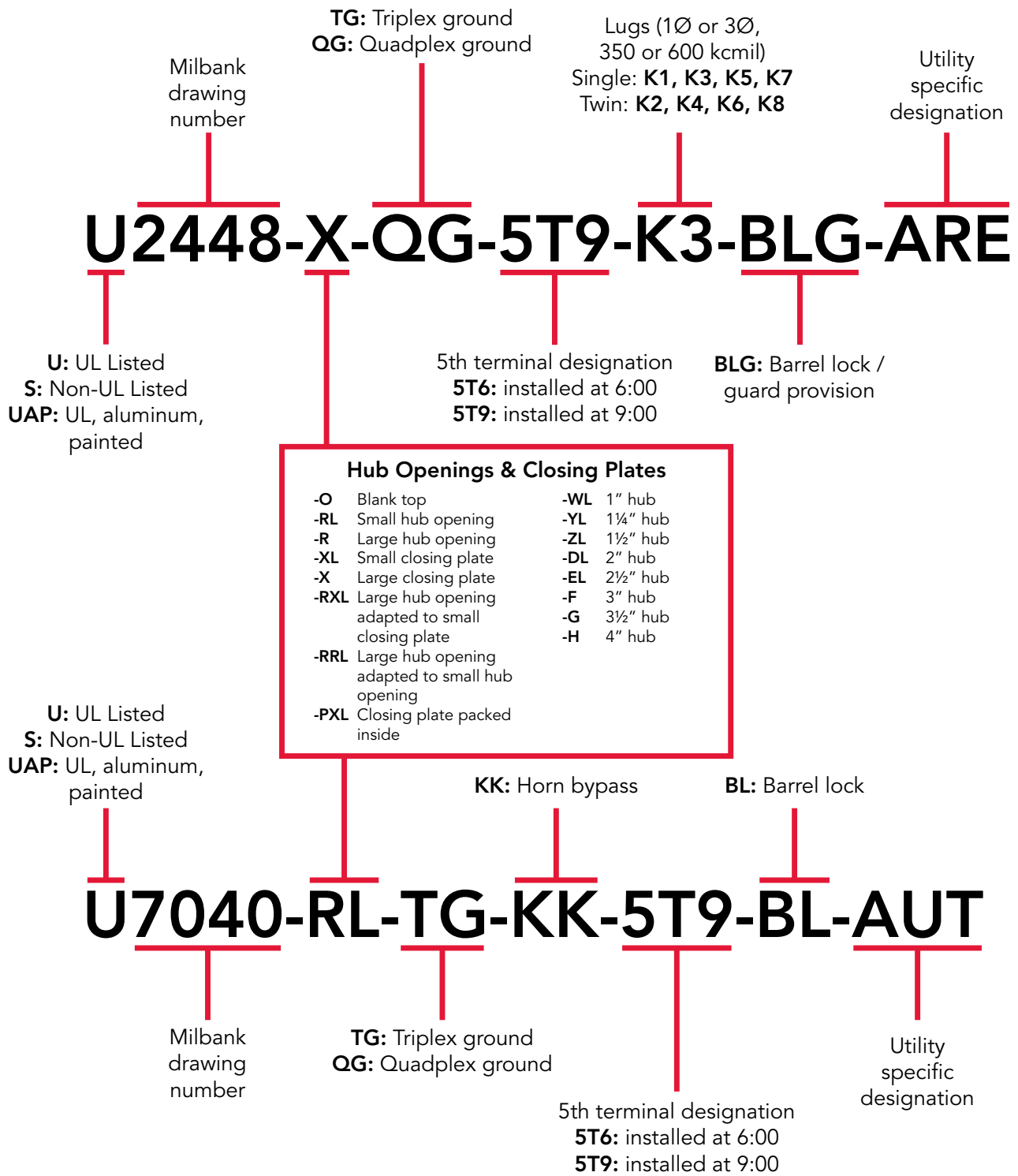

Please consult serving utility for their requirements prior to ordering or installing, as specifications and approvals vary by utility, and may require local electrical inspector approval. All installations must be installed by a licensed electrician and must comply with all national and local codes, laws and regulations. Milbank reserves the right to make changes in specifications and features shown without notice or obligation.



Air Conditioner Disconnects

30 & 60 Amps | Fusible & Non-Fusible



U3802



U3812



U3832

Milbank's air conditioner disconnect has a removable hinged cover for ease of installation. Our compact design meets NEC wiring space requirements and also complies with NEC article 440-14. For safe working conditions, our disconnect pullers may be removed and reinstalled in the OFF position. Additionally, padlock provisions are included on the front cover. As with other Milbank products, our enclosure is constructed of G90U galvanized steel and electrostatically finished with an attractive, light gray, baked powder coating. Our epoxy/polyester resin blend offers a finish that is both durable and fade-resistant.

30-60 Amps | 1Ø 240 VAC | Air Conditioner Disconnects

Catalog Number	Amps	Type	Max H.P.	Weight (lbs.)	Line/Load Wire Range		Ground Wire Range CU/AL	Dimensions			Wire Rating	
					CU	AL		D"	W"	H"	CU °C	AL °C
U3802	60	Non-Fusible	10	3.25	#14-#2	#12-#2	#14-4	2½	5	7½	60°/75°	60°/75°
U3812	60	Non-Auto	10	3.25	#14-#2	#12-#2	#14-4	2½	5	7½	60°/75°	60°/75°
U3832	30	Fusible	3	2.5	#14-#3	#14-#3	#14-3	2½	5	7	60°/75°	60°/75°
U3862	60	Fusible	10	3.3	#14-#3	#14-#3	#14-3	2½	5	9	60°/75°	60°/75°

Notes

- UL listed as Enclosed Pullout Switch
- Type 3R rainproof
- One-inch concentric knockouts



Please consult serving utility for their requirements prior to ordering or installing, as specifications and approvals vary by utility, and may require local electrical inspector approval. All installations must be installed by a licensed electrician and must comply with all national and local codes, laws and regulations. Milbank reserves the right to make changes in specifications and features shown without notice or obligation.

Air Conditioner Disconnects

60 Amps | With 20 Amp GFCI Receptacle



U3822-20GWR

Specifications

- Meets NEC #210.63 requirements
- UL listed as Power Outlet
- Type 3R enclosure
- In-use cover*
- Duplex ground connector
- 1" concentric knockouts
- 1Ø, 240 volt
- 60 amp, non-fused
- 20 amp GFCI receptacle
- Reset/test button
- Weather and tamper resistant
- Meets NEC #406.8 requirements

60 Amps | 1Ø, 240 VAC | Air Conditioner Disconnect with GFCI Receptacle

Catalog Number	Type	Max H.P.	Weight (lbs.)	Line/Load Wire Range		Ground Wire Range CU/AL	Dimensions			Wire Rating	
				CU	AL		D"	W"	H"	CU °C	AL °C
U3822-20GWR	Non-Fusible	10	6	#14-#2	#12-#2	#14-4	4½	5¼	7½	60°/75°	60°/75°

Notes

- **Disconnect Pullouts:** To ensure the safest conditions, Milbank disconnect pullouts are reversible so they may be reinstalled in the OFF position.
- **Padlock Provision:** All units are designed with a padlock provision on the cover for security.
- ***In-Use Cover:** Cover is rated as an in-use cover (cover may be closed with cords plugged into receptacle).

Please consult serving utility for their requirements prior to ordering or installing, as specifications and approvals vary by utility, and may require local electrical inspector approval. All installations must be installed by a licensed electrician and must comply with all national and local codes, laws and regulations. Milbank reserves the right to make changes in specifications and features shown without notice or obligation.



Hot Tub Disconnects

Type 3R Enclosures



U4881-O-50GB



U4881-O-60GB

Specifications

- 240 volt ground fault protection
- UL listed, Type 3R rainproof
- 2-pole, 50 or 60 amp GFCI breaker protection
- Compact size
- Three or four wire installation
- 1Ø, 120/240 VAC
- Standard package of 12
- Two extra one-pole breaker spaces
- 100 amp overall rating
- Easy to install

100 Amps | Hot Tub Disconnect or Sub Panel Breaker Enclosure | Type 3R

Catalog Number	Breaker Amps	Type	Weight (lbs.)	Line/Load Wire Range		Ground Wire Range CU/AL	Dimensions		
				CU	AL		D"	W"	H"
U4881-O-50GB	50	Breaker	8	#14-1/0	#14-1/0	#14-1/0	3¾	7½	8½
U4881-O-60GB	60	Breaker	8	#14-1/0	#14-1/0	#14-1/0	3¾	7½	8½



Please consult serving utility for their requirements prior to ordering or installing, as specifications and approvals vary by utility, and may require local electrical inspector approval. All installations must be installed by a licensed electrician and must comply with all national and local codes, laws and regulations. Milbank reserves the right to make changes in specifications and features shown without notice or obligation.

Single Position Sockets

100 Amps | 4 Terminals | Ringless | 600 VAC

9
100 AMP
SINGLE
POSITION
SOCKETS

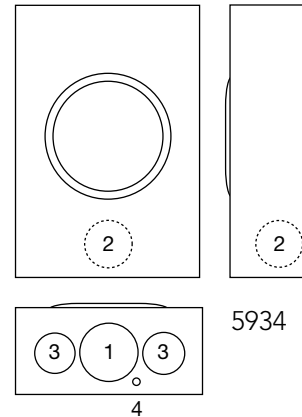

U5934-XL-BLG

100 Amps | 4 Terminals | Ringless | Single Position | 1Ø3W

Catalog Number	Service	Hub	Connectors CU/AL		Bypass	Dimensions			Knockouts			
			Line	Load		D"	W"	H"	1	2	3	4
U5934-XL-BLG	OH/UG	C.P.	#12-1/0	#12-1/0	None	3 ⁵ / ₁₆	8	11 ¹ / ₂	2	1 ¹ / ₂	1 ¹ / ₄	1 ¹ / ₄

Notes

- **Hubs:** Accepts standard meter socket hubs.
- **Construction:** Units are Type 3R for durable outdoor use, lockable and sealable.
- **Connectors:** Connectors will accept #14-1/0 conductors.
- To isolate neutral remove bonding screw.

Please consult serving utility for their requirements prior to ordering or installing, as specifications and approvals vary by utility, and may require local electrical inspector approval. All installations must be installed by a licensed electrician and must comply with all national and local codes, laws and regulations. Milbank reserves the right to make changes in specifications and features shown without notice or obligation.



Single Position Sockets

125 Amps | 4 Terminals | Ringless | 600 VAC



U7487-O-TG

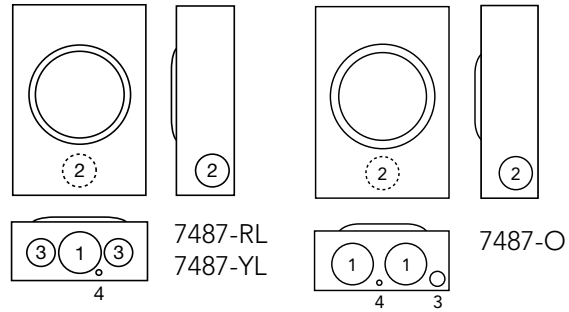

125 Amps | 4 Terminals | Ringless | Single Position | 1Ø3W

Catalog Number	Service	Hub	Connectors CU/AL		Bypass	Dimensions			Knockouts			
			Line	Load		D"	W"	H"	1	2	3	4
U7487-YL-TG	OH	1¼	#6-2/0	#6-2/0	None	3⅝	8	11½	2	1½	1¼	¼
U7487-RL-TG	OH/UG	H.O.	#6-2/0	#6-2/0	None	3⅝	8	11½	2	1½	1¼	¼
U7487-O-TG	UG	Blank	#6-2/0	#6-2/0	None	3⅝	8	11½	2	1½	¼, ½	¼

Notes

- **Hubs:** For proper hub selection, see the hub suffix chart on the Accessories page.
- **Fifth Terminal:** For field-installed fifth terminal, order catalog number **5T8K2**.
- **Connectors:** Extruded aluminum connectors are tin plated.
- **Ground:** Units are supplied with a triplex ground (-TG).



Please consult serving utility for their requirements prior to ordering or installing, as specifications and approvals vary by utility, and may require local electrical inspector approval. All installations must be installed by a licensed electrician and must comply with all national and local codes, laws and regulations. Milbank reserves the right to make changes in specifications and features shown without notice or obligation.

Single Position Sockets

200 Amps | 4 Terminals | Ringless | 600 VAC

1 1
200 AMP
SINGLE
POSITION
SOCKETS

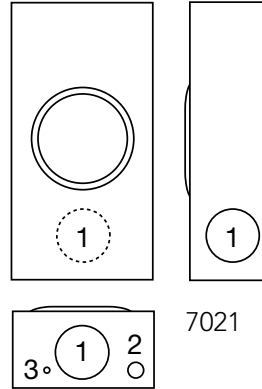

7021

U7021-RL-TG

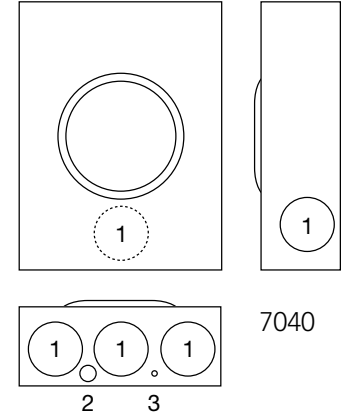

7040

U7040-O-TG

200 Amps | 4 Terminals | Ringless | Single Position | 1Ø3W

Catalog Number	Service	Hub	Connectors CU/AL	Bypass	Dimensions			Knockouts			
					D"	W"	H"	1	2	3	4
U7021-RL-TG	OH	H.O.	#6-350	None	4 $\frac{1}{8}$	8	15 $\frac{1}{2}$	2 $\frac{1}{2}$	1 $\frac{1}{4}$, 1 $\frac{1}{2}$	1 $\frac{1}{4}$	—
U7040-XL-TG	OH/UG	C.P.	#6-350	None	4 $\frac{1}{8}$	11	15 $\frac{1}{2}$	2 $\frac{1}{2}$	1 $\frac{1}{4}$, 1 $\frac{1}{2}$	1 $\frac{1}{4}$	—
U7040-O-TG	UG	Blank	#6-350	None	4 $\frac{1}{8}$	11	15 $\frac{1}{2}$	2 $\frac{1}{2}$	1 $\frac{1}{4}$, 1 $\frac{1}{2}$	1 $\frac{1}{4}$	—

Notes

- **Hubs:** For proper hub selection, see the hub suffix chart on the Accessories page.
- **Fifth Terminal:** For field installed fifth terminal, order **K5T**.
- **Ground:** Units supplied with triplex ground.
- **Connectors:** Extruded aluminum connectors are tin plated.

Please consult serving utility for their requirements prior to ordering or installing, as specifications and approvals vary by utility, and may require local electrical inspector approval. All installations must be installed by a licensed electrician and must comply with all national and local codes, laws and regulations. Milbank reserves the right to make changes in specifications and features shown without notice or obligation.



Single Position Sockets

200 Amps | 4 Terminals | Side Wireway | 600 VAC



U1980-O

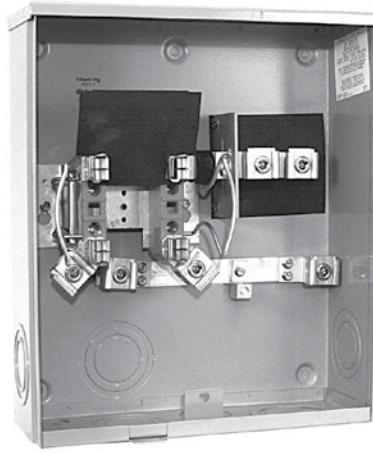

U4413-O-BL



U5777-O

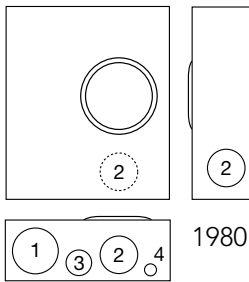

1980

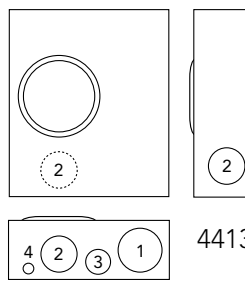

4413

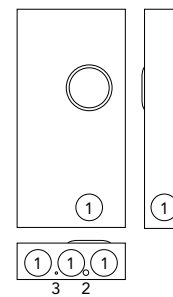

200 Amps | 4 Terminals | Ringless | Side Wireway | Single Position | 1Ø3W

Catalog Number	Service	Hub	Connectors CU/AL		Bypass	Dimensions			Knockouts			
			Line	Load		D"	W"	H"	1	2	3	4
U1980-O	UG	Blank	#6-350	#6-350	None	4½	10	18½	3	2½	¾	¼, ½
U4413-O-BL	UG	Blank	#6-350	#6-350	None	4½	10	18½	3	2½	¾	¼, ½
U5777-O	UG	Blank	¾-16 Studs	#2-350	None	4⅞	13	19	3	2½	¼, ½	¼

Notes

- **Hubs:** For proper hub selection, see the hub suffix chart on the Accessories page.
- **Connectors:** Extruded aluminum connectors are tin plated.
- **Ground:** Units supplied with triplex ground.
- **Fifth Terminal:** For field installed fifth terminal, order **K5T**.



Please consult serving utility for their requirements prior to ordering or installing, as specifications and approvals vary by utility, and may require local electrical inspector approval. All installations must be installed by a licensed electrician and must comply with all national and local codes, laws and regulations. Milbank reserves the right to make changes in specifications and features shown without notice or obligation.

Lever Bypass Single Position

125 Amps | 5 & 7 Terminals | Ringless | 600 VAC

13
125 AMP
LEVER
BYPASS
SOCKETS

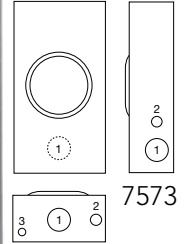
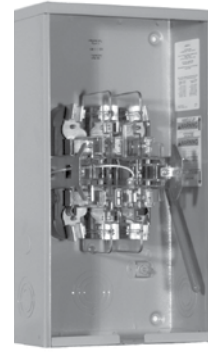
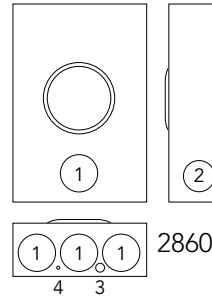
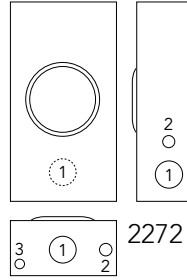

U2272-RL-5T9-BL

U2860-XL-5T9-QG

U7573-RL

125 Amps | 5 Terminals | Ringless | Lever Bypass | Single Position 1Ø3W

Catalog Number	Service	Hub	Connectors CU/AL		Bypass	Dimensions			Knockouts			
			Line	Load		D"	W"	H"	1	2	3	4
U2272-RL-5T9-BL	OH	H.O.	#6-2/0	#6-2/0	Lever	4 ⁷ / ₈	10	18 ¹ / ₂	2	3/4	1/4, 1/2	—
U2860-XL-5T9-QG	OH/UG	C.P.	#6-2/0	#6-2/0	Lever	4 ⁷ / ₈	13	19	3	2 ¹ / ₂	1/4, 1/2	1/4

Notes

- **Hubs:** For proper hub selection, see the hub suffix chart on the Accessories page.
- **Lever Bypass:** The lever operates bypass device only; it is **not jaw clamping**.
- **Connectors:** Extruded aluminum connectors are tin plated.
- **Fifth Terminal:** Factory installed in 9 o'clock position.

125 Amps | 7 Terminals | Ringless | Lever Bypass | Single Positions 3Ø4W

Catalog Number	Service	Hub	Connectors CU/AL		Bypass	Dimensions			Knockouts		
			Line	Load		D"	W"	H"	1	2	3
U7573-RL	OH	H.O.	#6-2/0	#6-2/0	Lever	4 ⁷ / ₈	10	18 ¹ / ₂	2	3/4	1/4, 1/2

Notes

- **Hubs:** For proper hub selection, see the hub suffix chart on the Accessories page.
- **Lever Bypass:** The lever operates bypass device only; it is not jaw clamping (medium duty).
- **Connectors:** Extruded aluminum connectors are tin plated.

Please consult serving utility for their requirements prior to ordering or installing, as specifications and approvals vary by utility, and may require local electrical inspector approval. All installations must be installed by a licensed electrician and must comply with all national and local codes, laws and regulations. Milbank reserves the right to make changes in specifications and features shown without notice or obligation.



Lever Bypass Single Position

200 Amps | 5 Terminals | Ringless | 600 VAC



U9318-RL

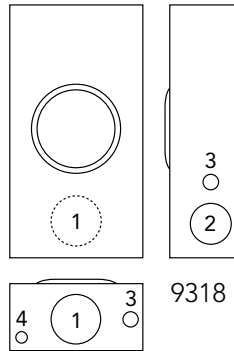

U9319-XL

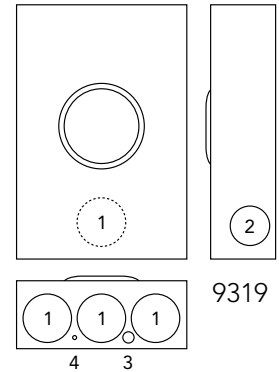

200 Amps | 5 Terminals | Ringless | Single Position | 1Ø3W

Catalog Number	Service	Hub	Connectors CU/AL	Bypass	Dimensions			Knockouts				
					D"	W"	H"	1	2	3	4	5
U9318-RL	OH	H.O.	#6-350	Lever	4 ⁷ / ₈	10	18 ¹ / ₂	3	2 ¹ / ₂	3/4	1/4, 1/2	—
U9319-XL	OH/UG	C.P.	#6-350	Lever	4 ⁷ / ₈	13	19	3	2 ¹ / ₂	1/4, 1/2	1/4	—

Notes

- **Hubs:** For proper hub selection, see the hub suffix chart on the Accessories page.
- **Lever Bypass:** The lever operates bypass device only; it is **not jaw clamping** (medium duty).
- **Connectors:** Extruded aluminum connectors are tin plated.



Please consult serving utility for their requirements prior to ordering or installing, as specifications and approvals vary by utility, and may require local electrical inspector approval. All installations must be installed by a licensed electrician and must comply with all national and local codes, laws and regulations. Milbank reserves the right to make changes in specifications and features shown without notice or obligation.

Lever Bypass Single Position

200 Amps | 4 Terminals | Ringless | 600 VAC

15
200 AMP
LEVER
BYPASS
SOCKETS



U9800-RRL-QG-BL-NE

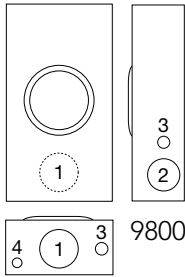

U9801-RXL-QG

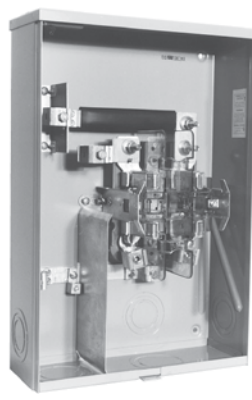
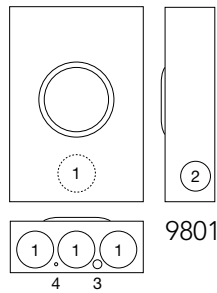

U3924-XL

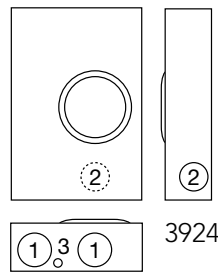

U4721-O-BL

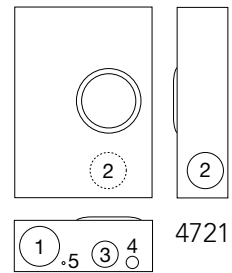

200 Amps | 4 Terminals | Ringless | Single Position | 1Ø3W

Catalog Number	Service	Hub	Connectors CU/AL	Bypass	Dimensions			Knockouts					
					D"	W"	H"	1	2	3	4	5	
U9800-RRL-QG-BL-NE	OH	H.O.	#6-350	Lever	4 $\frac{7}{8}$	10	18 $\frac{1}{2}$	3	2 $\frac{1}{2}$	$\frac{3}{4}$	$\frac{1}{4}, \frac{1}{2}$	—	—
U9801-RXL-QG	OH/UG	C.P.	#6-350	Lever	4 $\frac{7}{8}$	13	19	3	2 $\frac{1}{2}$	$\frac{1}{4}, \frac{1}{2}$	$\frac{1}{4}$	—	—
U3924-XL	UG	C.P.	#6-350	Lever	4 $\frac{7}{8}$	14	20 $\frac{1}{2}$	3	2 $\frac{1}{2}$	$\frac{1}{4}, \frac{1}{2}$	—	—	—
U4721-O-BL	UG	Blank	#6-350	Lever	5 $\frac{3}{4}$	16	22	4	3 $\frac{1}{2}$	2 $\frac{1}{2}$	1	$\frac{1}{4}$	—

Notes

- **Hubs:** For proper hub selection, see the hub suffix chart on the Accessories page.
- **Fifth Terminal:** For field installed fifth terminal, order as extra **K3866** for the **U9800**, **U9801**, **U4721**, and **K3865** for the **U3924**.
- **Bypass:** The lever supplies clamping action on meter spades and also operates bypass device.
- **Connectors:** Extruded aluminum connectors are tin plated.

Please consult serving utility for their requirements prior to ordering or installing, as specifications and approvals vary by utility, and may require local electrical inspector approval. All installations must be installed by a licensed electrician and must comply with all national and local codes, laws and regulations. Milbank reserves the right to make changes in specifications and features shown without notice or obligation.



Lever Bypass Single Position

200 Amps | 5 Terminals | Ringless | 600 VAC



U9550-RRL-QG

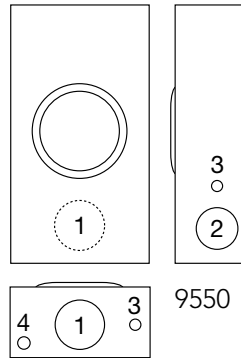

U9551-RXL-QG

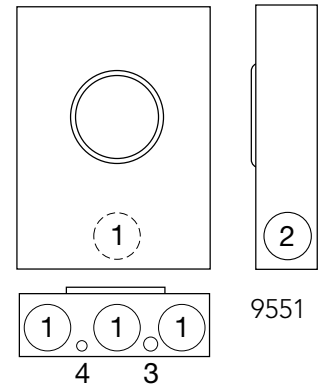

200 Amps | 5 Terminals | Ringless | Single Position | 1Ø3W or 3Ø3W

Catalog Number	Service	Hub	Connectors CU/AL	Bypass	Dimensions			Knockouts			
					D"	W"	H"	1	2	3	4
U9550-RRL-QG	OH	H.O.	#6-350	Lever	4 ⁷ / ₈	10	18 ¹ / ₂	3	2 ¹ / ₂	³ / ₄	¹ / ₄ , ¹ / ₂
U9551-RXL-QG	OH/UG	C.P.	#6-350	Lever	4 ⁷ / ₈	13	19	3	2 ¹ / ₂	¹ / ₄ , ¹ / ₂	¹ / ₄

Notes

- **Hubs:** For proper hub selection, see the hub suffix chart on the Accessories page.
- **Bypass:** The lever supplies clamping action on meter spades and also operates bypass device.
- **Connectors:** Extruded aluminum connectors are tin plated.



Please consult serving utility for their requirements prior to ordering or installing, as specifications and approvals vary by utility, and may require local electrical inspector approval. All installations must be installed by a licensed electrician and must comply with all national and local codes, laws and regulations. Milbank reserves the right to make changes in specifications and features shown without notice or obligation.

Lever Bypass Single Position

200 Amps | 7 Terminals | Ringless | 600 VAC

17
200 AMP
LEVER
BYPASS
SOCKETS



U9700-RRL-QG-BL

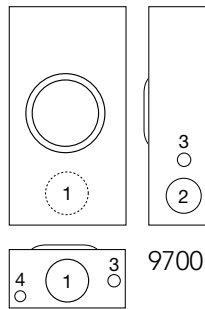

U9701-RXL-QG

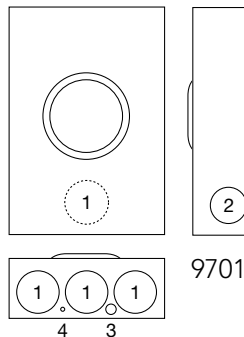

U4910-O-BL

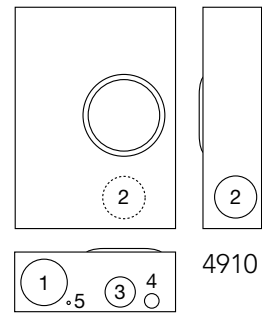

200 Amps | 7 Terminals | Ringless | Single Position | 3Ø4W

Catalog Number	Service	Hub	Connectors CU/AL	Bypass	Dimensions			Knockouts				
					D"	W"	H"	1	2	3	4	4
U9700-RRL-QG-BL	OH	H.O.	#6-350	Lever	4 $\frac{7}{8}$	10	18 $\frac{1}{2}$	3	2 $\frac{1}{2}$	$\frac{3}{4}$	1 $\frac{1}{4}$, $\frac{1}{2}$	—
U9701-RXL-QG	OH/UG	C.P.	#6-350	Lever	4 $\frac{7}{8}$	13	19	3	2 $\frac{1}{2}$	1 $\frac{1}{4}$, $\frac{1}{2}$	$\frac{1}{4}$	—
U4910-O-BL	UG	Blank	#6-350	lever	5 $\frac{3}{4}$	16	22	4	3 $\frac{1}{2}$	2 $\frac{1}{2}$	1	$\frac{1}{4}$

Notes

- **Hubs:** For proper hub selection, see the hub suffix chart on the Accessories page.
- **Bypass:** The lever supplies clamping action on meter spades and also operates bypass device.
- **Connectors:** Extruded aluminum connectors are tin plated.

Please consult serving utility for their requirements prior to ordering or installing, as specifications and approvals vary by utility, and may require local electrical inspector approval. All installations must be installed by a licensed electrician and must comply with all national and local codes, laws and regulations. Milbank reserves the right to make changes in specifications and features shown without notice or obligation.



Lever Bypass Single Position

320 Amps | 4 Terminals | Ringless | 600 VAC



U2448-X

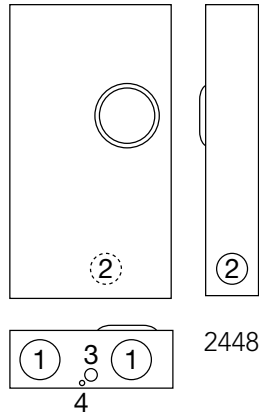

U4778-X-BL

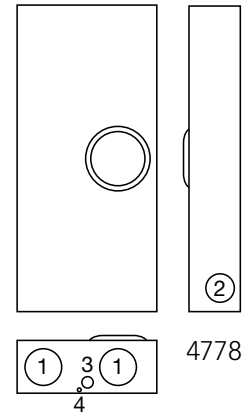

320 Amps | 4 Terminals | Ringless | Single Position | 1Ø3W

Catalog Number	Service	Hub	Connectors CU/AL	Bypass	Dimensions			Knockouts			
					D"	W"	H"	1	2	3	4
U2448-X	OH/UG	C.P.	3/8" x 16 Studs	Lever	6½	17¾	34⅞	4	3	1	¼
U4778-X-BL	OH/UG	C.P.	3/8" x 16 Studs	Lever	6½	17¾	38¾	4	3	1	¼

Notes

- **Hubs:** For proper hub selection, see the hub suffix chart on the Accessories page.
- **Bypass:** The lever supplies clamping action on meter spades and also operates bypass device.
- **Connectors:** Units are supplied with 3/8" x 16 hex nuts with Belleville washers. Order **K1540** (single, 600 kcmil) or **K1350** (twin, 350 kcmil). Order two kits to cover both line and load.
- **Fifth Terminal:** For field-installed fifth terminal, order **K3865** as extra.



Please consult serving utility for their requirements prior to ordering or installing, as specifications and approvals vary by utility, and may require local electrical inspector approval. All installations must be installed by a licensed electrician and must comply with all national and local codes, laws and regulations. Milbank reserves the right to make changes in specifications and features shown without notice or obligation.

Lever Bypass Single Position

320 Amps | 5 & 7 Terminals | Ringless | 600 VAC

19
320 AMP
LEVER
BYPASS
SOCKETS



320 Amps | 5 Terminals | Ringless | Single Position | 3Ø3W

Catalog Number	Service	Hub	Connectors CU/AL	Bypass	Dimensions			Knockouts			
					D"	W"	H"	1	2	3	4
U4611-X	OH/UG	C.P.	3/8" x 16 Studs	Lever	6½	17¾	31¼	4	1	¼	3

320 Amps | 7 Terminals | Ringless | Single Position | 3Ø4W

Catalog Number	Service	Hub	Connectors CU/AL	Bypass	Dimensions			Knockouts			
					D"	W"	H"	1	2	3	4
U4911-X-BL	OH/UG	C.P.	3/8" x 16 Studs	Lever	6½	17¾	38¾	4	3	1	¼
U2594-X	OH/UG	C.P.	3/8" x 16 Studs	Lever	6½	19¾	34½	4	3	1	¼

Notes

- **Hubs:** For proper hub selection, see the hub suffix chart on the Accessories page.
- **Bypass:** The lever supplies clamping action on meter spades and also operates bypass device.
- **Connectors:** Units are supplied with 3/8" x 16 hex nuts with Belleville washers. Order **K3441** (single, 600 kcmil) or **K3442** (twin, 350 kcmil). Order two kits to cover both line and load.

Please consult serving utility for their requirements prior to ordering or installing, as specifications and approvals vary by utility, and may require local electrical inspector approval. All installations must be installed by a licensed electrician and must comply with all national and local codes, laws and regulations. Milbank reserves the right to make changes in specifications and features shown without notice or obligation.





U3499-XL-100

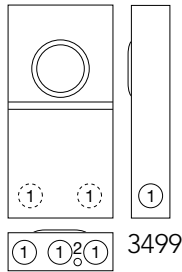

U3989-XL-100

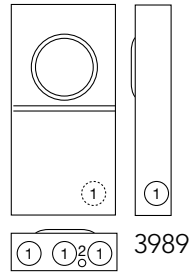

U3990-XL-150

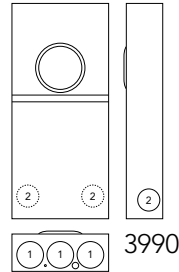

U3798-O-200

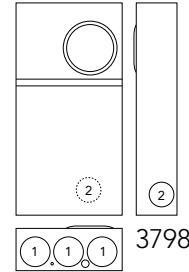

U5757-O-200

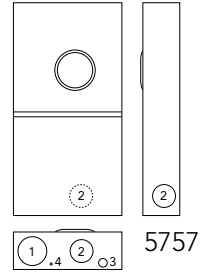

4 Terminals | Ringless | Meter Mains | 1Ø3W

Catalog Number	Service	Amps	Hub	Connectors CU/AL		Bypass	Dimensions			Knockouts			
				Line	Load		D"	W"	H"	1	2	3	4
U3499-XL-100	OH/UG	100	C.P.	#6-2/0	#6-1/0	None	3¾	11	22	2	¼, ½	—	—
U3989-XL-100	OH/UG	100	C.P.	#6-2/0	#6-1/0	None	3¾	11	22	2	¼, ½	—	—
U3990-XL-150	OH/UG	150	C.P.	#2-350	#1/0-300	None	4⅞	13	29	3	2½	¼, ½	¼
U3990-XL-200	OH/UG	200	C.P.	#2-350	#1/0-300	None	4⅞	13	29	3	2½	¼, ½	¼
U3798-O-200	UG	200	Blank	#2-350	#1/0-300	None	4⅞	13	25 ¹³ / ₁₆	3	2½	¼, ½	¼
U5757-O-200	UG	200	Blank	¾"-16 Studs	#1/0-300	None	5¾	17¾	34	4	3	1	¼

Notes

- **Hubs:** For proper hub selection, see the hub suffix chart on the Accessories page.
- **Circuit Breakers:** The **U3499-XL-100** has a factory-installed 100 amp breaker. The **U3990-XL-150** and **U3990-XL-200** have factory installed Milbank **UQFB-(AMP)-X1** breakers. The **U3798-O-200** has a factory-installed UQFB-200-X1 breaker. The **U3989-XL-100** is supplied with a 100 amp plug-in style breaker and has provisions for two 1-pole breakers.
- **Fifth Terminal:** For field-installed fifth terminal for **U3499** and **U3989**, order **5T8K2**. For **U3990** and **U3798**, order **K5T**. For **U5757**, order **K3865**.



Please consult serving utility for their requirements prior to ordering or installing, as specifications and approvals vary by utility, and may require local electrical inspector approval. All installations must be installed by a licensed electrician and must comply with all national and local codes, laws and regulations. Milbank reserves the right to make changes in specifications and features shown without notice or obligation.

Lever Bypass Meter Mains

100–200 Amps | 4 Terminals | Ringless | 120/240 VAC

21
100–200 AMP
LEVER BYPASS
METER MAINS

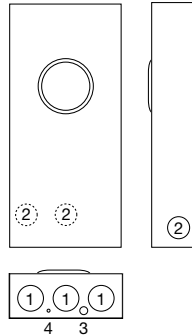
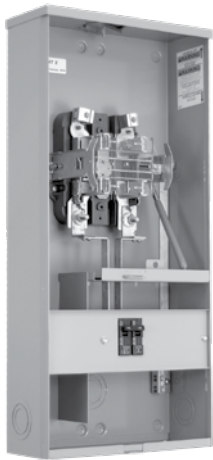

U3741-XL-100-BL

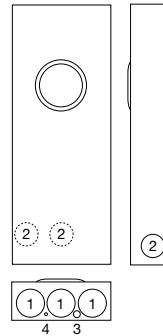
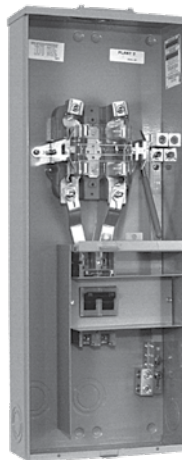

U3791N-RXL-200-BL

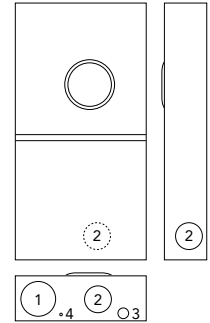

U5140-RXL-200-BL

4 Terminals | Ringless | Meter Mains | 1Ø3W

Catalog Number	Service	Amps	Hub	Connectors CU/AL		Bypass	Dimensions			Knockouts			
				Line	Load		D"	W"	H"	1	2	3	4
U3741-XL-100-BL	OH/UG	100	C.P.	#6-1/0	#6-1/0	Lever	4 ⁷ / ₈	13	28	2 ¹ / ₂	2	¼, ½	¼
U3791N-RXL-200-BL	OH/UG	200	C.P.	#6-350	#1/0-300	Lever	4 ⁷ / ₈	13	34	3	2 ¹ / ₂	¼, ½	¼
U5140-RXL-200-BL	OH/UG	200	C.P.	#6-350	#1/0-300	Lever	5 ³ / ₄	17 ³ / ₈	34	4	3	1	¼

Notes

- **Hubs:** For proper hub selection, see the hub suffix chart on the Accessories page.
- **Circuit Breakers:** The **U3741** is supplied with a factory-installed 2-pole, 100 amp plug-in breaker. The **U3791** unit is supplied with a factory installed Milbank **UQFB-200-X1** 2-pole, 200 amp bolt-in breaker.
- **Fifth Terminal:** For field-installed fifth terminal, order **K3866**. For a **3W network**, use fifth terminal.
- **Bypass:** The lever bypass on the **U3741** operates the sliding bypass only; it is not jaw clamping (medium duty). The lever bypass on the **U3791N** and **U5140** supplies clamping action on the meter spades and also operates the bypass device (heavy duty).
- **Connectors:** Extruded aluminum connectors are tin plated.

Please consult serving utility for their requirements prior to ordering or installing, as specifications and approvals vary by utility, and may require local electrical inspector approval. All installations must be installed by a licensed electrician and must comply with all national and local codes, laws and regulations. Milbank reserves the right to make changes in specifications and features shown without notice or obligation.



Meter Main with Load Center

100–200 Amps | 4 Terminals | Ringless



U3784-RL

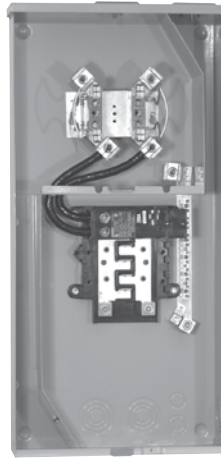
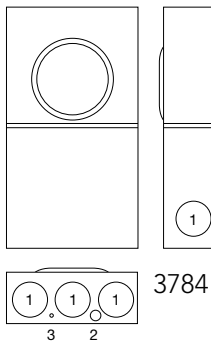

U5168-XTL-200-BL-NE

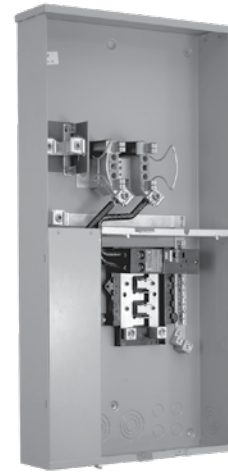
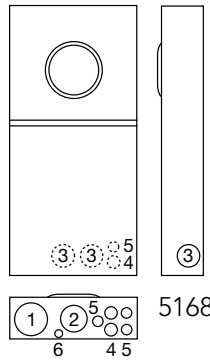

U5898-O-200-BL

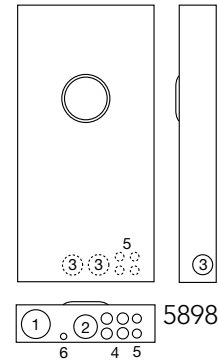

4 Terminals | Ringless | Meter Main with Load Center | 1Ø3W

Catalog Number	Service	Amps	Hub	Circuits	Connectors CU/AL – Line	Bypass	Dimensions			Knockouts					
							D"	W"	H"	1	2	3	4	5	6
U5168-XTL-100-BL-NE	OH/UG	100	(2) C.P.	10	#6-350	None	4½	14⅞	32⅜	3	2½	2	1	½,¾	¼,½
U5168-XTL-200-BL-NE	OH/UG	200	(2) C.P.	8	#6-350	None	4½	14⅞	32⅜	3	2½	2	1	½,¾	¼,½
U3784-RL	OH	200	H.O.	6	#6-350	None	5½	10	31	2	½	¼	—	—	—
U5898-O-200-BL	UG	200	Blank	8	#6-350	None	4½	17	34½	3	2½	2	1	½,¾	¼,½

Notes

- **Fifth Terminal:** For a field-installable fifth terminal for the **U5168**, **U5898**, and **U3784**, order **K5T**.
- **Connectors:** Extruded aluminum connectors are tin plated.
- **Breakers:** The **U5168** and **U5898** are rated **22K AIC** with **QN2200H** main breaker installed and have eight branch breaker provisions.



Please consult serving utility for their requirements prior to ordering or installing, as specifications and approvals vary by utility, and may require local electrical inspector approval. All installations must be installed by a licensed electrician and must comply with all national and local codes, laws and regulations. Milbank reserves the right to make changes in specifications and features shown without notice or obligation.

Lever Bypass Meter Mains

100–200 Amps | 5 & 7 Terminals | Ringless | 120/240 VAC

23
100-200 AMP
LEVER BYPASS
METER MAINS

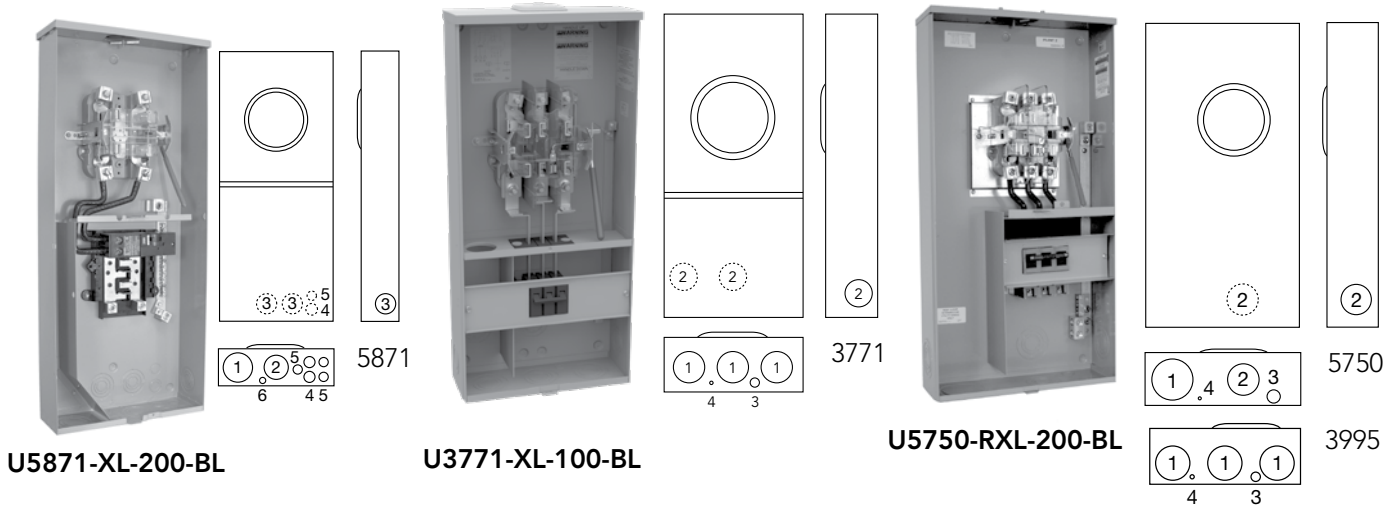

U5871-XL-200-BL

U3771-XL-100-BL

U5750-RXL-200-BL

5 Terminals | Ringless | Meter Main with Load Center | 1Ø3W

Catalog Number	Service	Amps	Hub	Circuits	Connectors CU/AL – Line	Bypass	Dimensions			Knockouts					
							D"	W"	H"	1	2	3	4	5	6
U3995-XL-200	OH/UG	200	C.P.	4	#6-350	Lever	4 $\frac{7}{8}$	16	35	3 $\frac{1}{2}$	2 $\frac{1}{2}$	$\frac{1}{4}, \frac{1}{2}$	$\frac{1}{4}$	—	—
U5871-XL-200-BL	OH/UG	200	C.P.	8	#6-350	Lever	4 $\frac{1}{2}$	14 $\frac{1}{8}$	33 $\frac{1}{2}$	3	2 $\frac{1}{2}$	2	1	$\frac{1}{2}, \frac{3}{4}$	$\frac{1}{4}, \frac{1}{2}$

7 Terminals | Ringless | Meter Mains | 3Ø4W

Catalog Number	Service	Amps	Hub	Connectors CU/AL		Bypass	Dimensions			Knockouts			
				Line	Load		D"	W"	H"	1	2	3	4
U3771-XL-100-BL	OH/UG	100	C.P.	#6-2/0	#6-1/0	Lever	4 $\frac{7}{8}$	13	28	2 $\frac{1}{2}$	2	$\frac{1}{4}, \frac{1}{2}$	$\frac{1}{4}$
U5750-RXL-200-BL	OH/UG	200	C.P.	#6-350	#1/0-300	Lever	5 $\frac{3}{4}$	17 $\frac{3}{8}$	34	4	3	1	$\frac{1}{4}$

Notes

- **Hubs:** For proper hub selection, see the hub suffix chart on the Accessories page.
- **Bypass:** The lever on the **U3771** operates the bypass device only; it is not jaw-clamping (medium duty). The lever on the **U5750** supplies clamping action on the meter spades and also operates bypass device (heavy duty).
- **Connectors:** Extruded aluminum connectors are tin plated.
- **Fifth Terminal:** For a field-installable fifth terminal for **U5871** and **U3995**, order **K3865**.
- **Breakers:** The **U3771** is supplied with a factory-installed 3-pole, 100 amp plug-in breaker. The **U5750** is supplied with a factory-installed Milbank **UQFB-3200** 3-pole, 200 amp bolt-on breaker.

Please consult serving utility for their requirements prior to ordering or installing, as specifications and approvals vary by utility, and may require local electrical inspector approval. All installations must be installed by a licensed electrician and must comply with all national and local codes, laws and regulations. Milbank reserves the right to make changes in specifications and features shown without notice or obligation.



24

320 AMP
LEVER BYPASS
METER MAINS

Lever Bypass Meter Mains

320 Amps | 4 Terminals | Ringless



U4835-X-2/200-BL

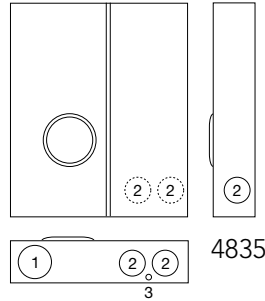

U4031-O-2/200

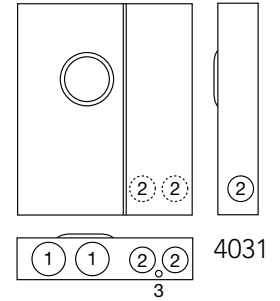

320 Amps | 4 Terminals | Ringless | Meter Mains | 1Ø

Catalog Number	Service	Hub	Connectors CU/AL		Bypass	Dimensions			Knockouts		
			Line	Load		D"	W"	H"	1	2	3
U4835-X-2/200-BL	OH/UG	C.P.	3/8"-16 Studs	#1/0-300	Lever	5 3/4	25	30	4	3	1/4, 1/2
U4031-O-2/200	UG	Blank	3/8"-16 Studs	#1/0-300	Lever	5 3/4	25	30	4	3	1/4, 1/2

Notes

- **Connectors:** The line wire section is supplied with 3/8" -16 studs with hex head nuts and captive Belleville washers. For single lug connector kits, order **K1539** (350 kcmil) or **K1540** (600 kcmil). For twin lug connector kits, order **K1350** (350 kcmil).
- **Breakers:** The **U4031** and **U4835** are supplied with (2) bolt-on Milbank **UQFBH-200** breakers.
- **Bypass:** The lever supplies clamping action on the meter spades and also operates the bypass device.
- **Fifth Terminal:** For field-installed fifth terminal, order catalog number **K3865**.



Please consult serving utility for their requirements prior to ordering or installing, as specifications and approvals vary by utility, and may require local electrical inspector approval. All installations must be installed by a licensed electrician and must comply with all national and local codes, laws and regulations. Milbank reserves the right to make changes in specifications and features shown without notice or obligation.

Cold Sequence Meter Mains

200 & 400 Amps | For use on 480V services

25
COLD
SEQUENCE
METER MAINS

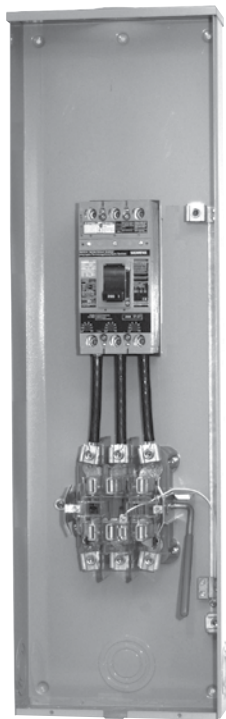

U5767-X-200-CB-BL

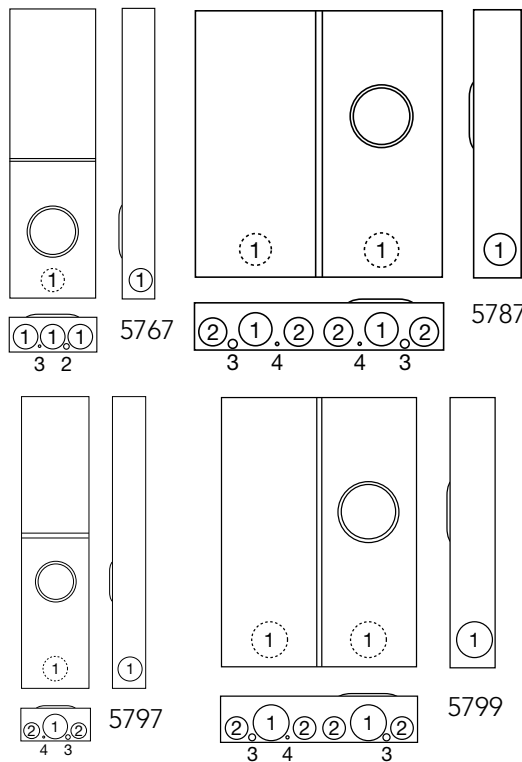

U5799-O-400-CB-BL

200 Amps | 7 Terminals | Circuit Breaker Disconnect Ahead of Meter Socket | 3Ø4W

Catalog Number	Service	Hub	Connectors CU/AL		Bypass	AIC Rating	Dimensions			Knockouts			
			Line	Load			D"	W"	H"	1	2	3	4
U5767-X-200-CB-BL	OH	C.P.	1/0-350	#6-350	Lever	*See note	4 ²⁷ / ₃₂	13	43	3	¼, ½	¼	—
U5787-O-200-CB	UG	Blank	1/0-350	#6-350	Lever	*See note	4 ²⁷ / ₃₂	26	28	4	½, ¾	1	½, ¾

400 Amps (320A Cont.) | 7 Terminals | Circuit Breaker Disconnect Ahead of Meter Socket | 3Ø4W

Catalog Number	Service	Hub	Connectors CU/AL		Bypass	AIC Rating	Dimensions			Knockouts			
			Line	Load			D"	W"	H"	1	2	3	4
U5796-X-400-CB-BL	OH	C.P.	(2) 3/0-500	(2) 3/0-500	Lever	10K	6	13	56	3	¼, ½	¼	—
U5799-O-400-CB-BL	UG	Blank	(2) 3/0-500	(2) 3/0-500	Lever	10K	6	26	36	4 ½	2 ¼	2 ¼	—

Notes

- *AIC Ratings: Circuit breaker rated 600V @ 22K AIC, 480V @ 35K AIC, and 240V @ 65K AIC.

Please consult serving utility for their requirements prior to ordering or installing, as specifications and approvals vary by utility, and may require local electrical inspector approval. All installations must be installed by a licensed electrician and must comply with all national and local codes, laws and regulations. Milbank reserves the right to make changes in specifications and features shown without notice or obligation.



26

100 AMP
MULTI-
POSITION
SOCKETS

Vertical Multi-Position Sockets

100 Amps | 4 Terminals | Ringless | 300 VAC

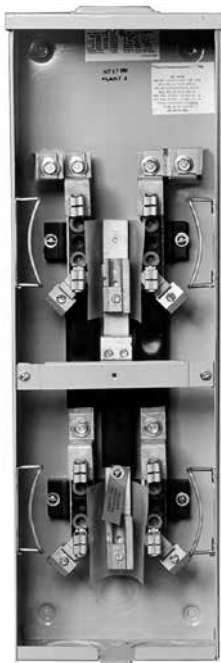

U2692-XL

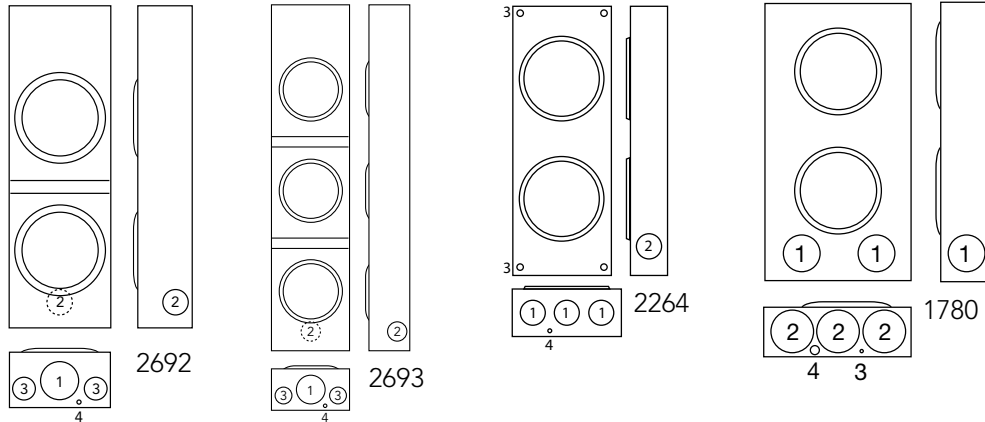

100 Amps | 4 Terminals | Multi-Position | Ringless

Catalog Number	Positions	Service	Hub	Connectors CU/AL		Bypass	Dimensions			Knockouts			
				Line	Load		D"	W"	H"	1	2	3	4
U2692-XL	2	OH/UG	C.P.	#2-350	#6-2/0	None	4 ⁷ / ₈	8	25 ¹ / ₄	2 ¹ / ₂	1 ¹ / ₂	1 ¹ / ₄	1 ¹ / ₄
U2693-XL	3	OH/UG	C.P.	#2-350	#6-2/0	None	4 ¹ / ₈	8	35 ²³ / ₃₂	2 ¹ / ₂	1 ¹ / ₂	1 ¹ / ₄	1 ¹ / ₄
U2264-XL	2	OH/UG	C.P.	#2-350	#6-2/0	*	4 ²⁷ / ₃₂	11	30	2 ¹ / ₂	2 ¹ / ₂	—	1 ¹ / ₄

200 Amps upper socket & 100 Amps lower socket | 4 Terminals | Multi-Position | Ring Type

Catalog Number	Positions	Service	Hub	Connectors CU/AL		Bypass	Dimensions			Knockouts			
				Line	Load		D"	W"	H"	1	2	3	4
U1780-O	2	OH/UG	Blank	#2-350	#6-2/0	None	4 ¹ / ₈	11	26	2 ¹ / ₂	2 ¹ / ₂	1 ¹ / ₄	1 ¹ / ₄

Notes

- **Hubs:** For proper hub selection, see the hub suffix chart on the Accessories page.
- **Fifth Terminal:** For a field-mounted fifth terminal, order catalog number **5T8K2**.
- **Connectors:** Extruded aluminum connectors are tin plated.
- **Bussing:** 1/4 x 1" aluminum bussing is supplied.
- * The **U2264-XL** upper meter socket has a medium duty lever bypass and upper socket is 200 Amps, and the lower socket is 100 Amps.



Please consult serving utility for their requirements prior to ordering or installing, as specifications and approvals vary by utility, and may require local electrical inspector approval. All installations must be installed by a licensed electrician and must comply with all national and local codes, laws and regulations. Milbank reserves the right to make changes in specifications and features shown without notice or obligation.

Multi-Position Sockets

100 Amps/Position | 4 Terminals | Ringless | 300 VAC

27
100 AMP
MULTI-
POSITION
SOCKETS

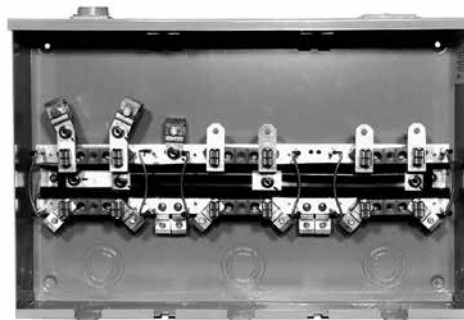

U7363-DL

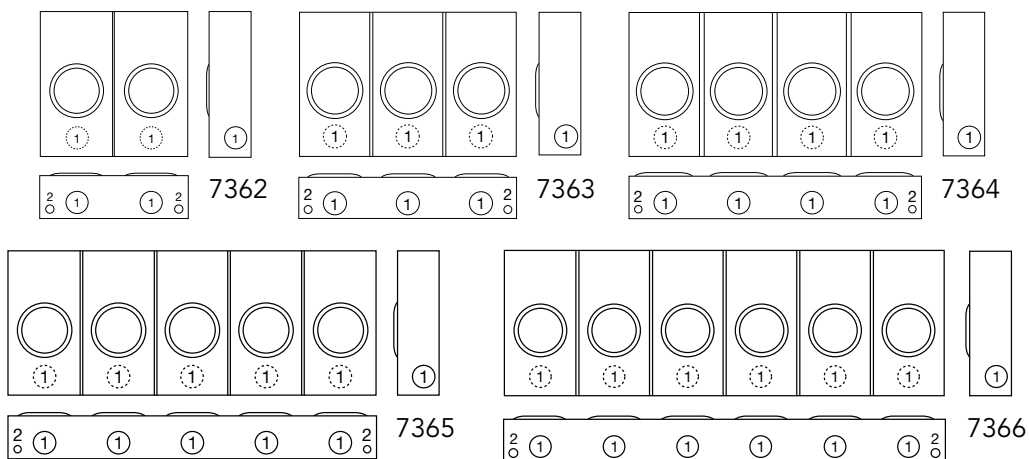

100 Amp/Position | 4 Terminals | Multi-Position | Ringless

Catalog Number	Positions	Service	Hub	Connectors CU/AL			Dimensions			Knockouts	
				Line	Load	Bypass	D"	W"	H"	1	2
U7362-DL	2	OH	2"	#6-350	#6-2/0	None	4½	16 ⁵ / ₁₆	16	2	¼, ½
U7363-DL	3	OH	2"	#6-350	#6-2/0	None	4½	24 ¹ / ₂	16	2	¼, ½
U7364-DL	4	OH	2"	#6-350	#6-2/0	None	4½	32 ¹ / ₁₆	16	2	¼, ½
U7365-DL	5	OH	2"	#6-350	#6-2/0	None	4½	40 ⁷ / ₈	16	2	¼, ½
U7366-DL	6	OH	2"	#6-350	#6-2/0	None	4½	49 ¹ / ₁₆	16	2	¼, ½

Notes

- **Hubs:** For proper hub selection, refer to the hub suffix chart on the Accessories page. Hub opening is supplied at each end. Extra opening is closed with a closing plate.
- **Fifth Terminal:** For field mounted fifth terminal, order catalog number **K1815** for each meter position.
- **Connectors:** Extruded aluminum connectors are tin plated.
- **Bussing:** Bussing is 5/8" x 1" aluminum.

Please consult serving utility for their requirements prior to ordering or installing, as specifications and approvals vary by utility, and may require local electrical inspector approval. All installations must be installed by a licensed electrician and must comply with all national and local codes, laws and regulations. Milbank reserves the right to make changes in specifications and features shown without notice or obligation.



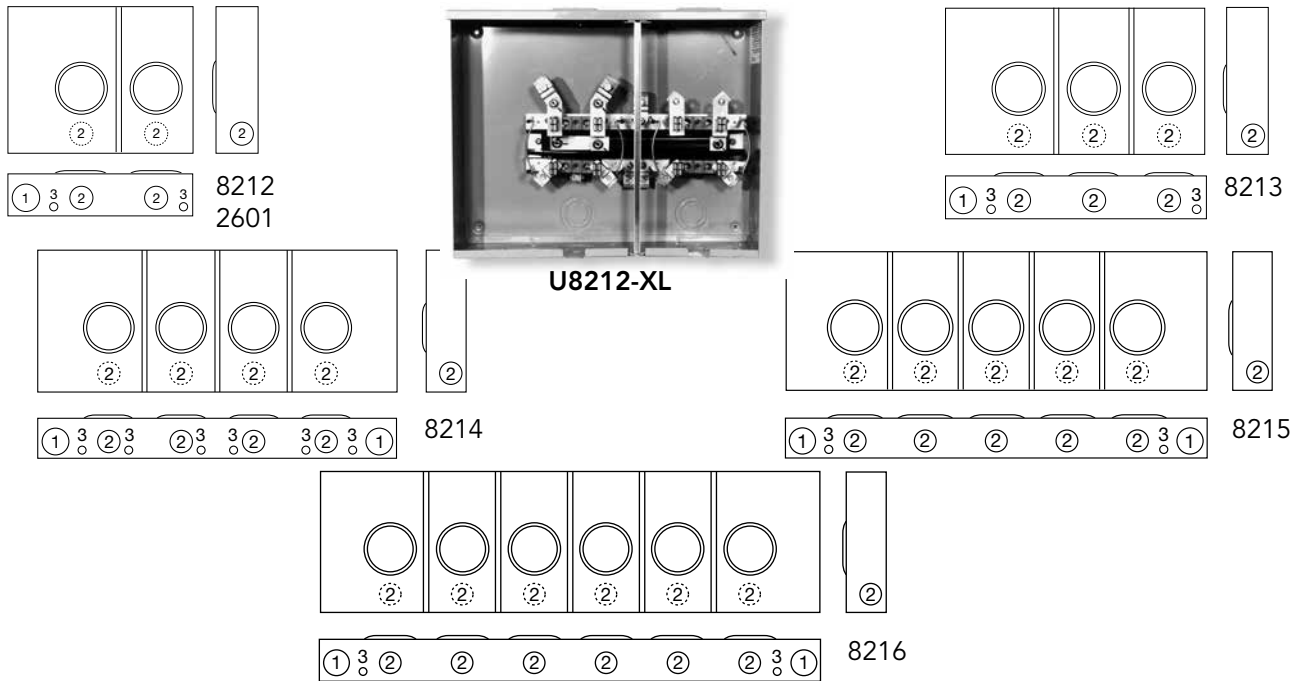

100 Amp per Position | 4 Terminal | Multi-Position | End Wireway | Ringless

Catalog Number	Positions	Service	Hub	Connectors CU/AL		Dimensions			Knockouts		
				Line	Load	D"	W"	H"	1	2	3
U8212-XL	2	OH	C.P.	#6-350	#6-2/0	4½	20 ⁵ / ₁₆	16	2½	2	¼, ½
U8213-XL	3	OH	C.P.	#6-350	#6-2/0	4½	28 ¹ / ₂	16	2½	2	¼, ½
U8214-XL	4	OH	C.P.	#6-350	#6-2/0	4½	40 ¹¹ / ₁₆	16	2½	2	¼, ½
U8215-XL	5	OH	C.P.	#6-350	#6-2/0	4½	48 ⁷ / ₈	16	2½	2	¼, ½
U8216-XL	6	OH	C.P.	#6-350	#6-2/0	4½	57 ¹ / ₁₆	16	2½	2	¼, ½

200 left /100 right Amp per Position | 4 Terminal | Multi-Position | End Wireway | Ringless

Catalog Number	Positions	Service	Hub	Connectors CU/AL		Dimensions			Knockouts		
				Line	Load	D"	W"	H"	1	2	3
U2601-XL	2	OH	C.P.	#2-350	#2-350 #6-2/0	4½	20 ⁵ / ₁₆	16	2½	2	¼, ½

Notes

- **Hubs:** For proper hub selection, refer to the hub suffix chart on the Accessories page. Hub opening is supplied at each end. Extra opening is closed with a closing plate.
- **Fifth Terminal:** For field mounted fifth terminal, order catalog number **K1815** for each meter position.
- **Connectors:** Extruded aluminum connectors are tin plated.
- **Bussing:** Bussing is 5/16" x 1" aluminum.



Please consult serving utility for their requirements prior to ordering or installing, as specifications and approvals vary by utility, and may require local electrical inspector approval. All installations must be installed by a licensed electrician and must comply with all national and local codes, laws and regulations. Milbank reserves the right to make changes in specifications and features shown without notice or obligation.

Multi-Position Sockets

200 Amps/Position | 4 Terminals | Ringless | 300 VAC

29
200 AMP
MULTI-
POSITION
SOCKETS



U1252-X-K1

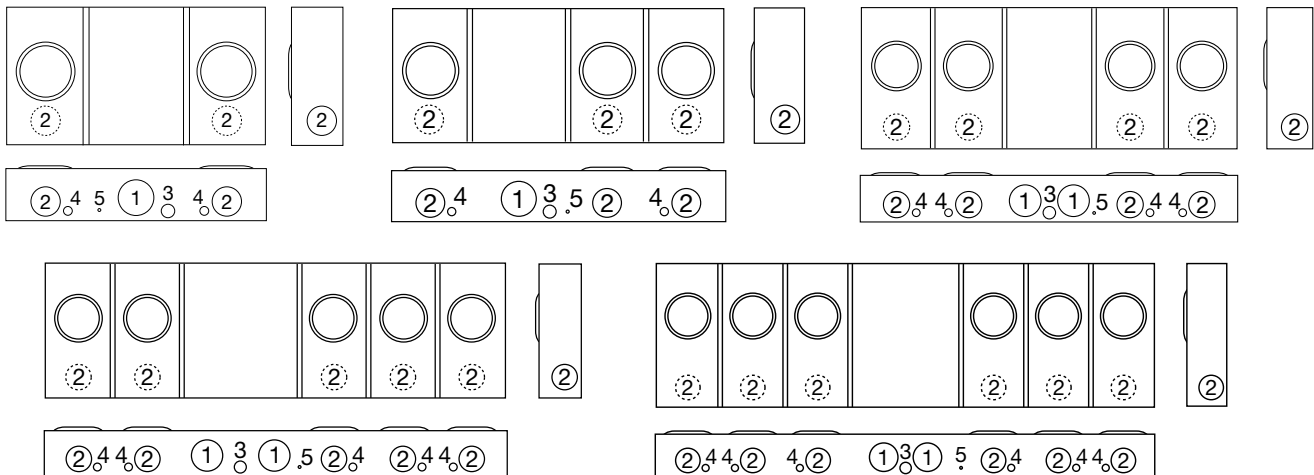

200 Amps | 4 Terminals | Multi-Position | Ringless | 1Ø3W

Catalog Number	Positions	Service	Hub	Connectors CU/AL		Bypass	Dimensions			Knockouts				
				Line	Load		D"	W"	H"	1	2	3	4	5
U1252-X-K1	2	OH/UG	C.P.	#6-350	#6-350	None	5½	26½	14	3	2½	1	½	¼
U1253-X-K3	3	OH/UG	C.P.	#4-600	#6-350	None	5½	34¾	14	3	2½	1	½	¼
U1254-X-K3	4	OH/UG	C.P.	#4-600	#6-350	None	5½	42⅞	16	3	2½	1	½	¼
U1255-X-K4	5	OH/UG	C.P.	(2) #2-600	#6-350	None	5½	54⅞	16	3	2½	1	½	¼
U1256-X-K4	6	OH/UG	C.P.	(2) #2-600	#6-350	None	5½	63⅞	18	3	2½	1	½	¼

Notes

- **Hubs:** For proper hub selection, see the hub suffix chart on the Accessories page.
- **Fifth Terminal:** For a field-mounted fifth terminal, order catalog number **K5T**.
- **Connectors:** Extruded aluminum connectors are tin plated.
- **Bussing:** 5/16" x 1" aluminum bussing is supplied in the **U1252**. 5/16" x 1" aluminum bussing is supplied in the **U1253–U1256**.
- **Overhead Service:** Extension kits for 4, 5 & 6 gang sockets available. Consult factory.

Please consult serving utility for their requirements prior to ordering or installing, as specifications and approvals vary by utility, and may require local electrical inspector approval. All installations must be installed by a licensed electrician and must comply with all national and local codes, laws and regulations. Milbank reserves the right to make changes in specifications and features shown without notice or obligation.



Multi-Position Sockets

125 Amps/Position | 4 Terminals | Ringless | 300 VAC

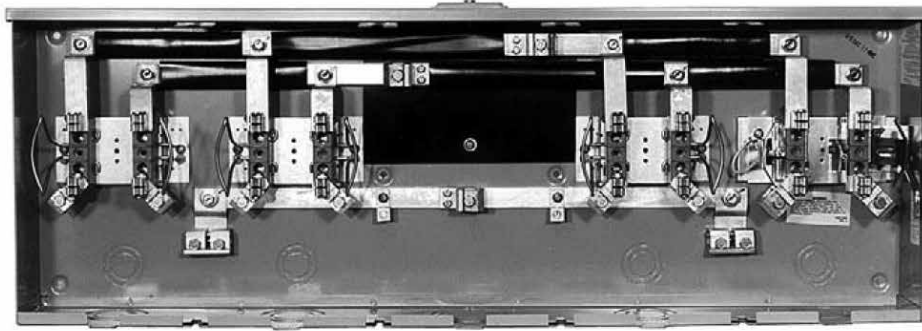

U3764-XL

NOTE

Each unit is supplied with a 125 amp non jaw-clamping lever bypass block assembly in the far right meter position only. All remaining positions are 125 amp with no bypass.

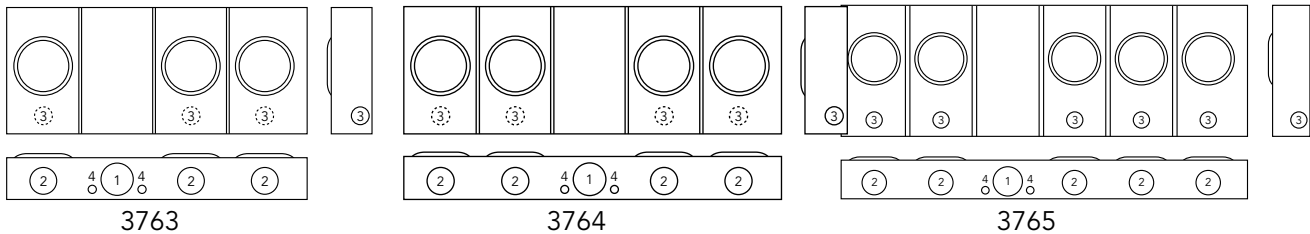

100 Amps | 5 Terminals | Multi-Position | Ringless

Catalog Number	Positions	Service	Hub	Connectors CU/AL		Bypass	Dimensions			Knockouts			
				Line	Load		D"	W"	H"	1	2	3	4
U3763-XL	3	OH/UG	C.P.	#6-2/0	#2-350	See note	4½	33⅞	14	3	2½	1½	¼, ½
U3764-XL	4	OH/UG	C.P.	#6-2/0	#2-350	See note	4½	41⅝	14	3	2½	1½	¼, ½
U3765-XL	5	OH/UG	C.P.	#6-2/0	#2-350	See note	4½	49⅜	16	3	2½	1½	¼, ½

Notes

- **Hubs:** For proper hub selection, see the hub suffix chart on the Accessories page.
- **Fifth Terminal:** For a field-mounted fifth terminal, order catalog number **5T8K2** for tenant positions, and order **K3356** for the far right house power lever bypass socket.
- **Connectors:** Extruded aluminum connectors are tin plated.
- **Bussing:** ¼ x 1" aluminum bussing is supplied.



Please consult serving utility for their requirements prior to ordering or installing, as specifications and approvals vary by utility, and may require local electrical inspector approval. All installations must be installed by a licensed electrician and must comply with all national and local codes, laws and regulations. Milbank reserves the right to make changes in specifications and features shown without notice or obligation.

Vertical Lever Bypass Multi-Position Sockets

100 Amps/Position | 5 Terminals | Ringless | 300 VAC

3 1
100 AMP
LEVER BYPASS
MULTI-
POSITION
SOCKETS



U5112-X-5T9-BL

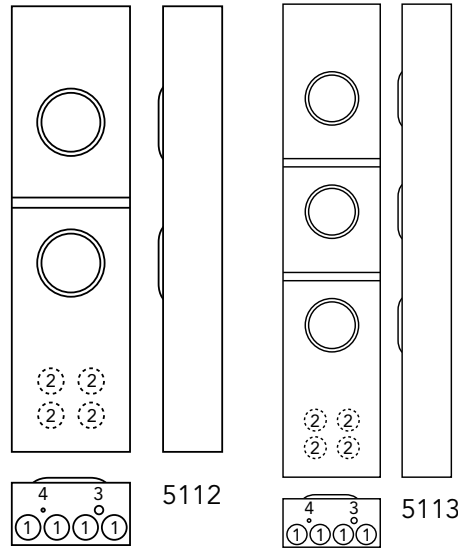

100 Amps | 5 Terminals | Multi-Position | Ringless

Catalog Number	Positions	Service	Hub	Connectors CU/AL		Bypass	Dimensions			Knockouts			
				Line	Load		D"	W"	H"	1	2	3	4
U5112-X-5T9-BL	2	OH	C.P.	#6-350	#6-2/0	Lever	6	12	44½	2½	2	¼, ½	¼
U5113-X-5T9-BL	3	OH	C.P.	#6-350	#6-2/0	Lever	6	12	58½	2½	2	1¼	¼

Notes

- **Hubs:** For proper hub selection, see the hub suffix chart on the Accessories page.
- **Fifth Terminal:** For a field-mounted fifth terminal, order catalog number **5T8K2**.
- **Connectors:** Extruded aluminum connectors are tin plated.
- **Bussing:** ¼ x 1" aluminum bussing is supplied.

Please consult serving utility for their requirements prior to ordering or installing, as specifications and approvals vary by utility, and may require local electrical inspector approval. All installations must be installed by a licensed electrician and must comply with all national and local codes, laws and regulations. Milbank reserves the right to make changes in specifications and features shown without notice or obligation.



32

100 AMP
LEVER BYPASS
MULTI-
POSITION
SOCKETS

Lever Bypass Multi-Position Sockets

100 Amps/Position | 5 Terminals | Ringless | 600 VAC



U2754-X-5T9

(unit shown with connector kit -K1539, order as extra)

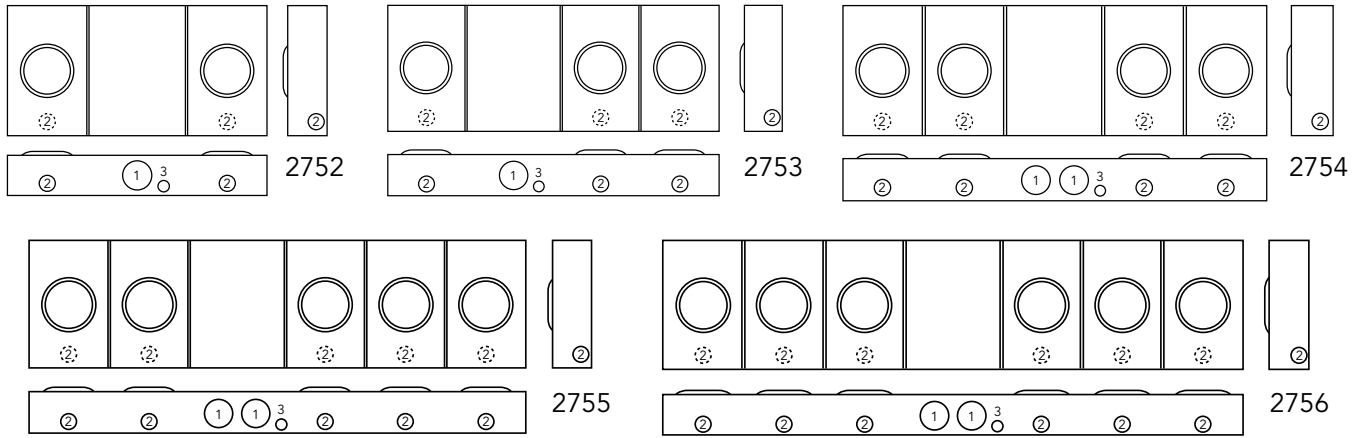

100 Amps | 5 Terminals | Multi-Position | Ringless

Catalog Number	Positions	Service	Hub	Connectors CU/AL		Bypass	Dimensions			Knockouts		
				Line	Load		D"	W"	H"	1	2	3
U2752-X-5T9	2	OH/UG	C.P.	3/8 x 16 studs	#6-2/0	Lever	4 7/8	32 1/8	16	3	1 1/2	1
U2753-X-5T9	3	OH/UG	C.P.	3/8 x 16 studs	#6-2/0	Lever	4 7/8	42 1/4	16	3	1 1/2	1
U2754-X-5T9	4	OH/UG	C.P.	3/8 x 16 studs	#6-2/0	Lever	4 7/8	52 1/4	16	3	1 1/2	1
U2755-X-5T9	5	OH/UG	C.P.	3/8 x 16 studs	#6-2/0	Lever	4 7/8	62 3/8	16	3	1 1/2	1
U2756-X-5T9	6	OH/UG	C.P.	3/8 x 16 studs	#6-2/0	Lever	4 7/8	72 3/8	16	3	1 1/2	1

Notes

- **Fifth Terminal:** The fifth terminal is factory installed in the 9 o'clock position. May field-change to the 6 o'clock position.
- **Connectors:** Aluminum extruded load side connectors are tin plated. For line side single lug connector kits, order **K1539** (350 kcmil) or **K1540** (600 kcmil) as extra. For twin lug connectors, order **K1350** (350 kcmil) or **K1541** (600 kcmil) as extra.
- **Bussing:** 1/4 x 1" aluminum bussing is supplied.
- **Lever Bypass:** The lever operates bypass only; it is not jaw-clamping (medium duty).



Please consult serving utility for their requirements prior to ordering or installing, as specifications and approvals vary by utility, and may require local electrical inspector approval. All installations must be installed by a licensed electrician and must comply with all national and local codes, laws and regulations. Milbank reserves the right to make changes in specifications and features shown without notice or obligation.

Lever Bypass Multi-Position Sockets

200 Amps/Position | 5 Terminals | Ringless | 600 VAC

33
200 AMP
LEVER BYPASS
MULTI-
POSITION

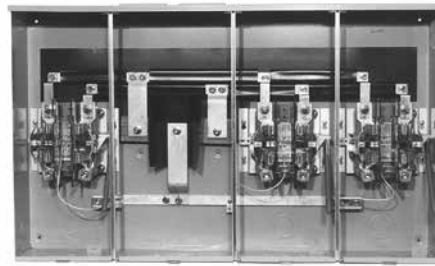

U2873-Xt-5t9

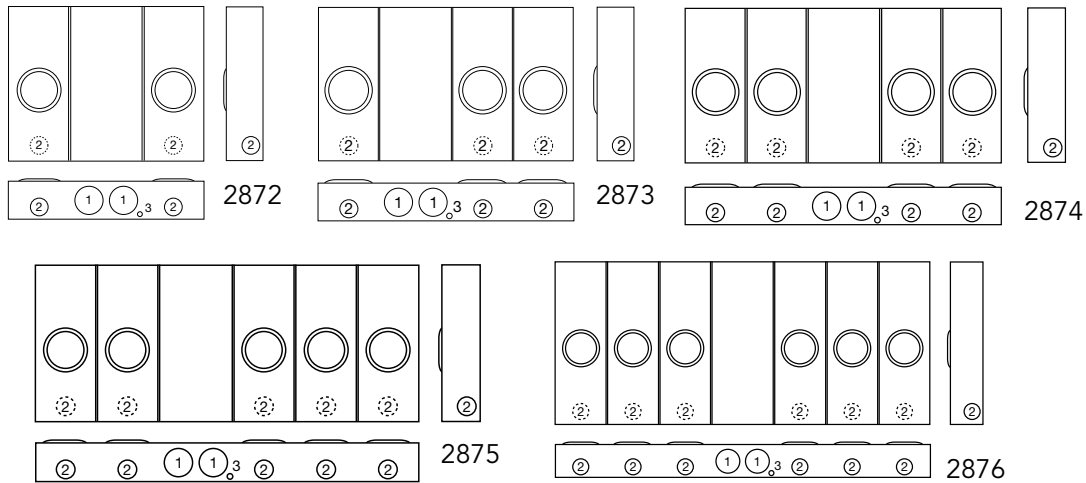

200 Amps per Position | 5 Terminals | Multi-Position | Ringless | 1Ø3W

Catalog Number	Positions	Service	Hub	Connectors CU/AL		Bypass	Dimensions			Knockouts		
				Line	Load		D"	W"	H"	1	2	3
U2872-Xt-5t9	2	OH	(2) C.P.	3/8" x 16 Stud	#6-350	Lever	6	32 1/8	25 1/4	4	2 1/2	1/4, 1/2
U2873-Xt-5t9	3	OH	(2) C.P.	3/8" x 16 Stud	#6-350	Lever	6	42 3/16	25 1/4	4	2 1/2	1/4, 1/2
U2874-Xt-5t9	4	OH	(2) C.P.	3/8" x 16 Stud	#6-350	Lever	6	52 1/4	25 1/4	4	2 1/2	1/4, 1/2
U2875-Xt-5t9	5	OH	(2) C.P.	3/8" x 16 Stud	#6-350	Lever	6	62 5/16	25 1/4	4	2 1/2	1/4, 1/2
U2876-Xt-5t9	6	OH	(2) C.P.	3/8" x 16 Stud	#6-350	Lever	6	72 3/8	31 1/4	4	2 1/2	1/4, 1/2

Notes

- **Hubs:** Units supplied with two closing plates. To order as extra, refer to the hub suffix chart in the Accessories section.
- **Connectors:** Units supplied with 3/8"-16 hex head nuts with Belleville washers on line side. Order connector kits **K1539** (350 kcmil), **K1540** (600 kcmil), **K1350** ((2) 350 kcmil) or **K1541** ((2) 600 kcmil).
- **Bypass:** Lever supplies clamping action on meter spades and also operates bypass device.
- **Fifth Terminal:** The fifth terminal is factory-installed in the 9 o'clock position; may be field-changed to the 6 o'clock position.
- **Bussing:** 3/8" x 1" aluminum bussing is supplied.

Please consult serving utility for their requirements prior to ordering or installing, as specifications and approvals vary by utility, and may require local electrical inspector approval. All installations must be installed by a licensed electrician and must comply with all national and local codes, laws and regulations. Milbank reserves the right to make changes in specifications and features shown without notice or obligation.



34

200 AMP
LEVER BYPASS
MULTI-
POSITION

Lever Bypass Multi-Position Sockets

200 Amps | 7 Terminals | Ringless | 600 VAC

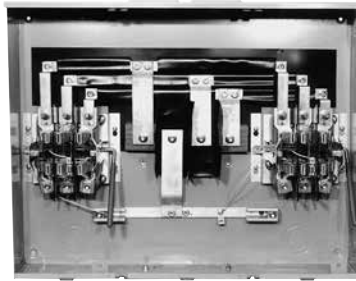

U2732-XT

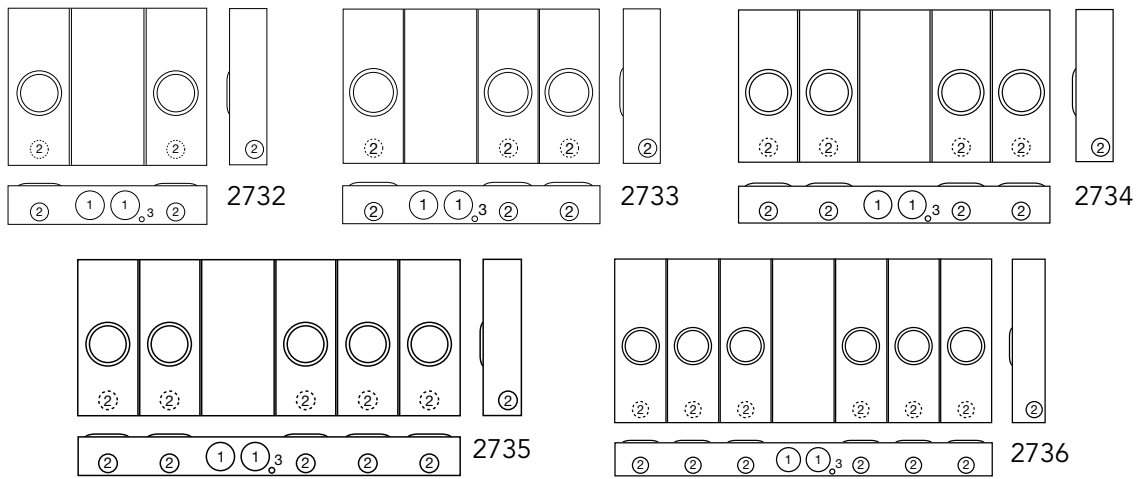

200 Amps per Position | 7 Terminals | Multi-Position | Ringless | 3Ø4W

Catalog Number	Positions	Service	Hub	Connectors CU/AL		Dimensions			Knockouts		
				Line	Load	D"	W"	H"	1	2	3
U2732-XT	2	OH/UG	(2) C.P.	3/8" x 16 Stud	#6-350	6	32 3/8"	25 1/4"	4	2 1/2"	1/4, 1/2"
U2733-XT	3	OH/UG	(2) C.P.	3/8" x 16 Stud	#6-350	6	42 3/16"	25 1/4"	4	2 1/2"	1/4, 1/2"
U2734-XT	4	OH/UG	(2) C.P.	3/8" x 16 Stud	#6-350	6	52 1/4"	25 1/4"	4	2 1/2"	1/4, 1/2"
U2735-XT	5	OH/UG	(2) C.P.	3/8" x 16 Stud	#6-350	6	62 5/16"	25 1/4"	4	2 1/2"	1/4, 1/2"
U2736-XT	6	OH/UG	(2) C.P.	3/8" x 16 Stud	#6-350	6	72 3/8"	31 1/4"	4	2 1/2"	1/4, 1/2"

Notes

- **Hubs:** Units supplied with two closing plates. To order as extra, refer to the hub suffix chart in the Accessories section.
- **Connector Kits:** For line side connector kits, order as extra **K3082** (350 kcmil), **K3441** (600 kcmil), **K3442** (twin 350 kcmil), or **K3083** (twin 600 kcmil). Line connectors can be reversed to change from overhead to underground service.
- **Bypass:** Lever supplies clamping action on meter spades and also operates bypass device.
- **Bussing:** 3/8" x 1" aluminum bussing is supplied.



Please consult serving utility for their requirements prior to ordering or installing, as specifications and approvals vary by utility, and may require local electrical inspector approval. All installations must be installed by a licensed electrician and must comply with all national and local codes, laws and regulations. Milbank reserves the right to make changes in specifications and features shown without notice or obligation.

Multi-Position Meter Mains

125 Amps | 4 Terminal | Ringless | 120/240 VAC

35
125 AMP
MULTI-
POSITION
METER MAINS



U6123-X-BL

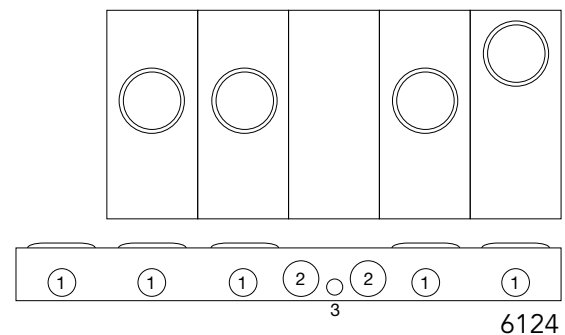
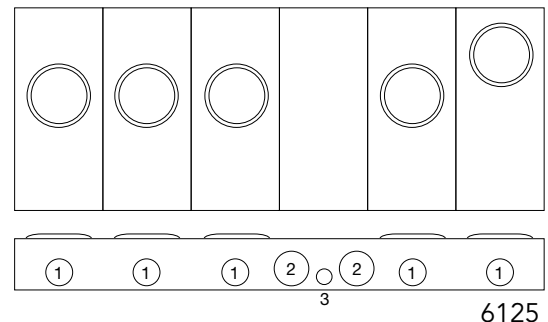
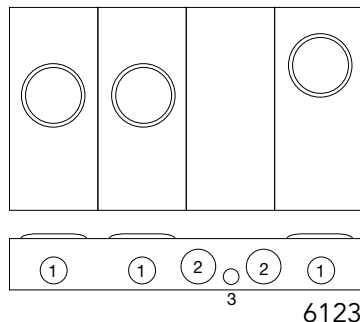

NOTE
Each unit is supplied with a 125 amp jaw clamping lever bypass block assembly in the far right meter position only. All remaining positions are 125 amp with no bypass.

125 Amp Per Position | Multi-Position Meter Mains | Ringless

Catalog Number	Amps Per Position	Positions	Line Connector Size		Dimensions			Knockouts		
			Line	Load	D"	W"	H"	1	2	3
U6123-X-BL	125	3	3/8" x 16 Stud*	C.B.	5 ³¹ / ₃₂	36 ¹ / ₂	30 ¹ / ₂	2 ¹ / ₂	3	1
U6124-X-BL	125	4	3/8" x 16 Stud*	C.B.	5 ³¹ / ₃₂	44 ¹³ / ₁₆	30 ¹ / ₂	2 ¹ / ₂	3	1
U6125-X-BL	125	5	3/8" x 16 Stud*	C.B.	5 ³¹ / ₃₂	53 ¹ / ₁₆	30 ¹ / ₂	2 ¹ / ₂	3	1

Notes

- **AIC Rating:** All models are rated **22K AIC** when used with approved breakers rated at 22K.
- **Hub:** Units supplied with one (1) closing plate. Order hubs separately, see Accessories page.
- **Fifth Terminal:** For a field-mounted fifth terminal, order catalog number **K5T** for tenant positions, and order **K3865** for the far right house power lever bypass socket.

Manufacturer	Cutler Hammer	Siemens	G.E. (50 Amp Max)	Square D
125 Amps or Less	BR, HQP, QPGF	QP, QPH (22K)	THQL	Homeline

Please consult serving utility for their requirements prior to ordering or installing, as specifications and approvals vary by utility, and may require local electrical inspector approval. All installations must be installed by a licensed electrician and must comply with all national and local codes, laws and regulations. Milbank reserves the right to make changes in specifications and features shown without notice or obligation.



36

125 & 200 AMP
MULTI-
POSITION
METER MAINS

Multi-Position Meter Mains

125 & 200 Amps | 4 Terminal | Ringless | 120/240 VAC



U2854-X

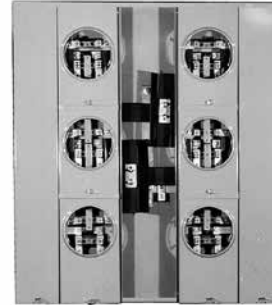

U2866-X

125 Amp Per Position | Multi-Position Sockets | Ringless

Catalog Number	Amps Per Position	Positions	Main Bus Rating	Line Connector Size	Dimensions		
					D"	W"	H"
U2852-X	125	2	200 Amp	3/8" x 16 Stud*	5 13/16	18	25
U2853-X	125	3	200 Amp	3/8" x 16 Stud*	5 13/16	18	37
U2854-X	125	4	400 Amp	3/8" x 16 Stud*	4 7/8	31	25
U2855-X	125	5	400 Amp	3/8" x 16 Stud*	4 7/8	31	37
U2856-X	125	6	400 Amp	3/8" x 16 Stud*	4 7/8	31	37

200 Amp Per Position | Multi-Position Sockets | Ringless

Catalog Number	Amps Per Position	Positions	Main Bus Rating	Line Connector Size	Dimensions		
					D"	W"	H"
U2288-X	200	1	200 Amp	#6-350 kcmil	4 27/32	13	21
U2862-X	200	2	250 Amp	3/8" x 16 Stud*	5 13/16	21	29
U2863-X	200	3	300 Amp	3/8" x 16 Stud*	5 13/16	21	41
U2864-X	200	4	400 Amp	3/8" x 16 Stud*	4 7/8	36	29
U2865-X	200	5	600 Amp	3/8" x 16 Stud*	4 7/8	36	41
U2866-X	200	6	600 Amp	3/8" x 16 Stud*	4 7/8	36	41

Connector Kits*

Size	Suffix	Kit Number	Compatible With	Wire Range
Single	-K1	K1539	U2852-56, U2862-66	#6-350
	-K3	K1540	U2854-56, U2864-66	#4-600
Twin	-K2	K1350	U2854-56, U2863-66	#6-350
	-K4	K1541	U2864-66	#2-600

Breaker Chart

Manufacturer	150–200 Amps	125 Amps or Less
Cutler Hammer	BJ, WBJ	Quicklag P, BR, HQP
Siemens	QNR	QP
Murray	MD	MP
G.E.		Q Line
Square D	—	Homeline

Notes

- **Connectors:** For line wire connector kits, order separately.
- **Fifth Terminal:** For field mounted fifth terminal, order catalog number **K2381**. Order one per meter position.
- **Breakers:** Units have provision for one double pole main per meter position. Breakers not included.
- **Short Circuit Current Rating:** 10K AIC. However, this rating is limited to the lowest interrupting capacity of any circuit breaker installed. Watthour meter not included in short circuit current rating.



Please consult serving utility for their requirements prior to ordering or installing, as specifications and approvals vary by utility, and may require local electrical inspector approval. All installations must be installed by a licensed electrician and must comply with all national and local codes, laws and regulations. Milbank reserves the right to make changes in specifications and features shown without notice or obligation.

Multi-Position Meter Mains

Knockout Information

37

125 & 200 AMP
MULTI-
POSITION
METER MAINS

Catalog Number	Knockouts			
	1	2	3	4
U2288-X	2½	4	¼, ½	3
U2852-X	3	1¼	¼, ½	—
U2853-X	3	1¼	¼, ½	—
U2854-X	3	1¼	¼, ½	—
U2855-X	3	1¼	¼, ½	—
U2856-X	3	1¼	¼, ½	—
U2862-X	3	2	¼, ½	—
U2863-X	3	2	¼, ½	—
U2864-X	3	2	¼, ½	—
U2865-X	3	2	¼, ½	—
U2866-X	3	2	¼, ½	—

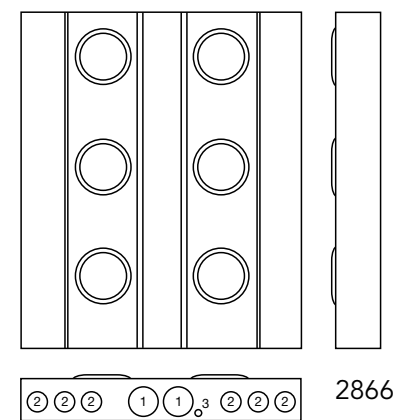
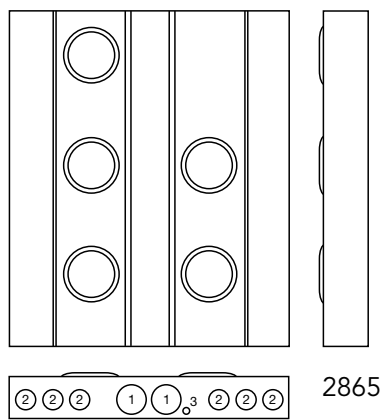
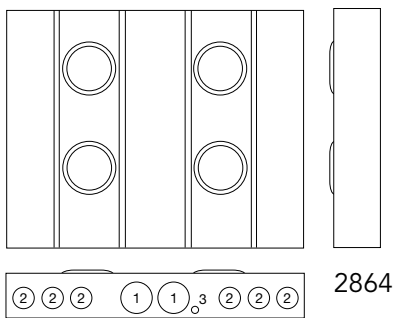
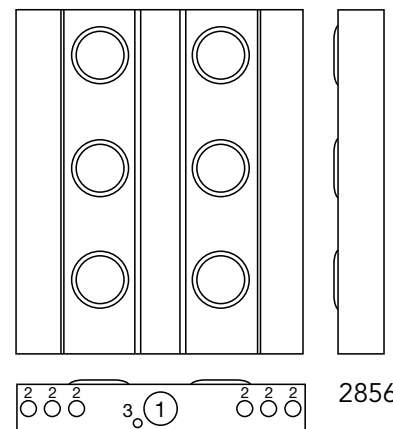
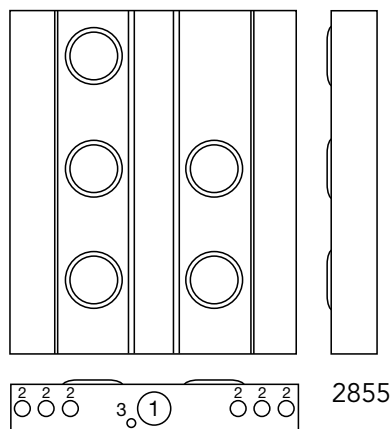
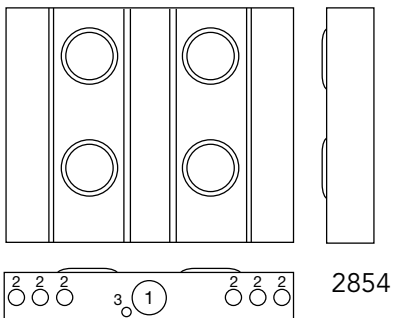
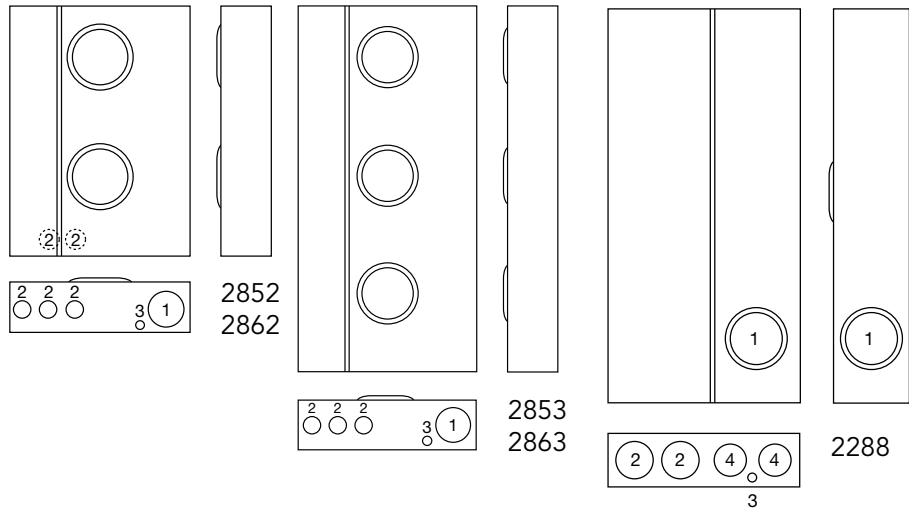

Please consult serving utility for their requirements prior to ordering or installing, as specifications and approvals vary by utility, and may require local electrical inspector approval. All installations must be installed by a licensed electrician and must comply with all national and local codes, laws and regulations. Milbank reserves the right to make changes in specifications and features shown without notice or obligation.



38

200 AMP
LEVER BYPASS
MULTI-
POSITION
METER MAINS

Lever Bypass Multi-Position Meter Mains

200 Amps | 5 Terminals | Ringless | 120/240 VAC



U4374-Xt-5T9

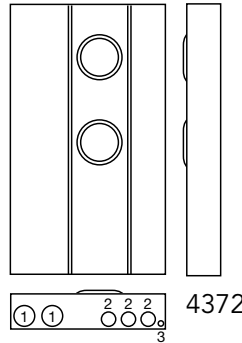

4372

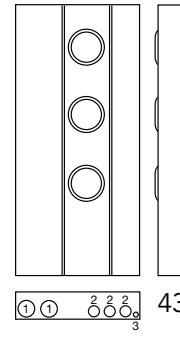

4373

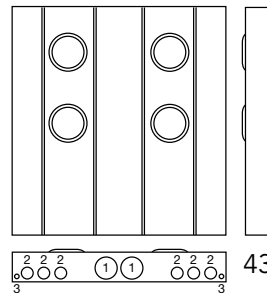

4374

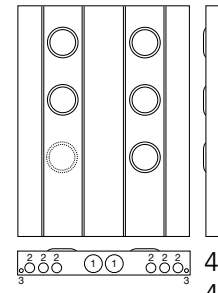

4375

4376

200 Amps/Position | 5 Terminals | Lever Bypass Multi-Position Meter Mains | Ringless | 1Ø3W

Catalog Number	Positions	Main Bus Rating	Line Connector Size	Dimensions			Knockouts		
				D"	W"	H"	1	2	3
U4372-Xt-5T9	2	320 Amps	3/8" x 16 Stud*	6	27 3/4	48	3	2	1/4, 1/2
U4373-Xt-5T9	3	480 Amps	3/8" x 16 Stud*	6	27 3/4	60	3	2	1/4, 1/2
U4374-Xt-5T9	4	640 Amps	3/8" x 16 Stud*	6	45	48	4	2	1/4, 1/2
U4375-Xt-5T9	5	640 Amps	3/8" x 16 Stud*	6	45	60	4	2	1/4, 1/2
U4376-Xt-5T9	6	640 Amps	3/8" x 16 Stud*	6	45	60	4	2	1/4, 1/2

Connector Kits*

Size	Suffix	Kit Number	Wire Range
Single	-K3	K1540	#4-600
Twin	-K2	K1350	#6-350
	-K4	K1541	#2-600

Breaker Chart

Manufacturer	150-200 Amps	125 Amps or Less
Cutler Hammer	BJ, WBJ	Quicklag P BR, HQP
Siemens (ITE)	QNR	QP
Murray	MD	MP
G.E.	—	Q Line
Square D	—	Homeline

Notes

- ***Connectors:** For line wire connector kits, order separately (see chart above).
- **Breakers:** Units have provision for one double pole main per meter position. Breakers not included. Order as extra (see chart above).
- **Bypass:** Lever supplies clamping action on meter spades and also operates bypass device.



Please consult serving utility for their requirements prior to ordering or installing, as specifications and approvals vary by utility, and may require local electrical inspector approval. All installations must be installed by a licensed electrician and must comply with all national and local codes, laws and regulations. Milbank reserves the right to make changes in specifications and features shown without notice or obligation.

Plunger Bypass Transformer Rated Sockets

20 Amps | 6-13 Terminals | 600 VAC

39
20 AMP
TRANSFORMER
RATED SOCKETS



UC1299-XL

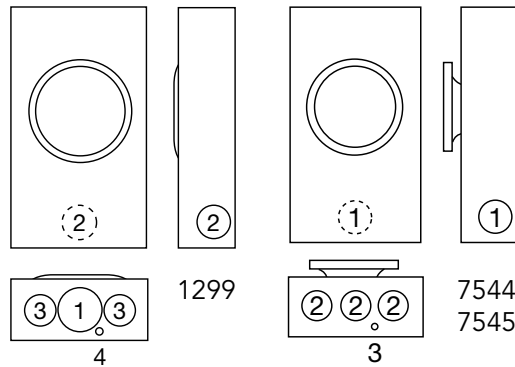

UC7545-RL

20 Amps | Transformer Rated Sockets

Catalog Number	Type	Terminals	Meter Form	Hub	Connectors CU	Bypass	Dimensions			Knockouts			
							D"	W"	H"	1	2	3	4
UC1299-XL	Ringless	6	4S	C.P.	#14 - 4	Plunger	3 ⁵ / ₁₆	8	14	2	1 ¹ / ₂	1 ¹ / ₄	1 ¹ / ₄
UC7544-RL	Ring Type	8	5S	H.O.	#14 - 4	Plunger	3 ⁵ / ₁₆	8	14	1 ¹ / ₂	1 ¹ / ₄	1 ¹ / ₄	—
UC7545-RL	Ring Type	13	6, 8, 9S & (ALT) 10S	H.O.	#14 - 4	Plunger	3 ⁵ / ₁₆	8	14	1 ¹ / ₂	1 ¹ / ₄	1 ¹ / ₄	—

Notes

- **Hubs:** For proper hub selection, see the hub suffix chart on the Accessories page.
- **Bypass:** Plunger type bypass automatically closes when meter is removed.
- **Connectors:** Units are supplied with mechanical type connectors.
- **Sealing Ring:** The ring-type **UC7544** and **UC7545** units include a **MR-2** snap type sealing ring.

Please consult serving utility for their requirements prior to ordering or installing, as specifications and approvals vary by utility, and may require local electrical inspector approval. All installations must be installed by a licensed electrician and must comply with all national and local codes, laws and regulations. Milbank reserves the right to make changes in specifications and features shown without notice or obligation.



Transformer Rated Sockets

20 Amps | 6-13 Terminals | 600 VAC

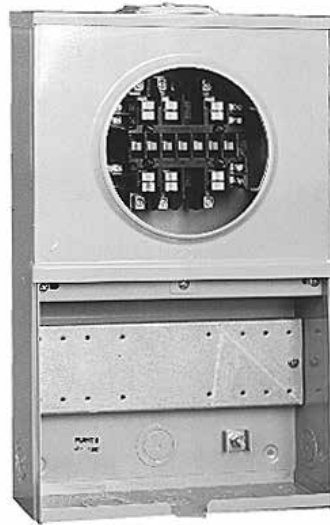

U7449-XL

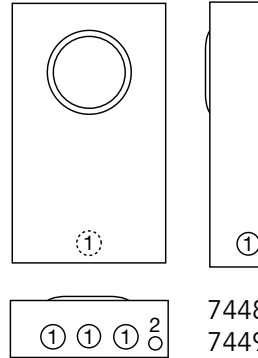

7448
7449
7532

20 Amps | Transformer Rated Sockets | 2 Piece Cover

Catalog Number	Terminals	Meter Form	Hub	Connectors CU	Bypass	Dimensions			Knockouts	
						D"	W"	H"	1	2
UC7532-XL	6	4S	C.P.	#14 - 4	Test Switch Provision	4 $\frac{1}{8}$	12	20	1 $\frac{1}{4}$	1 $\frac{1}{4}$, 1 $\frac{1}{2}$
UC7448-XL	8	5S	C.P.	#14 - 4	Test Switch Provision	4 $\frac{1}{8}$	12	20	1 $\frac{1}{4}$	1 $\frac{1}{4}$, 1 $\frac{1}{2}$
UC7449-XL	13	6, 8, 9S & (ALT) 10S	C.P.	#14 - 4	Test Switch Provision	4 $\frac{1}{8}$	12	20	1 $\frac{1}{4}$	1 $\frac{1}{4}$, 1 $\frac{1}{2}$

Notes

- **Hubs:** For proper hub selection, see the hub suffix chart on the Accessories page.
- **Connectors:** Supplied with tin plated mechanical connectors (#4 maximum).

Transformer Rated Sockets

20 Amps | 6-13 Terminals | 600 VAC

41
20 AMP
TRANSFORMER
RATED
SOCKETS



UC7445-O-311-NOE

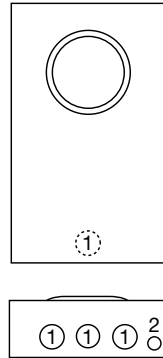

7444
7445
7478

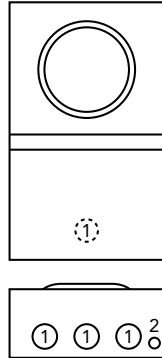

4964
4965
4966



UC4965-O-WC-21-NST

20 Amps | Transformer Rated Sockets | With Pre-wired Test Switch | Approved for N.E. Utilities

Catalog Number	Terminals	Meter Form	Cover	Hub	Connectors CU	Bypass	Dimensions			Knockouts	
							D"	W"	H"	1	2
UC7478-O-81-NOE	6	4S	1 Piece	Blank	#14 - 4	Test Switch	4 $\frac{1}{8}$	12	20	1 $\frac{1}{4}$	1 $\frac{1}{4}$, 1 $\frac{1}{2}$
UC7444-O-141-NOE	8	5S	1 Piece	Blank	#14 - 4	Test Switch	4 $\frac{1}{8}$	12	20	1 $\frac{1}{4}$	1 $\frac{1}{4}$, 1 $\frac{1}{2}$
UC7445-O-311-NOE	13	6, 8, 9S & (ALT) 10S	1 Piece	Blank	#14 - 4	Test Switch	4 $\frac{1}{8}$	12	20	1 $\frac{1}{4}$	1 $\frac{1}{4}$, 1 $\frac{1}{2}$

20 Amps | Transformer Rated Sockets | With Prewired Test Switch | Approved for NSTAR

Catalog Number	Terminals	Meter Form	Cover	Hub	Connectors CU	Bypass	Dimensions			Knockouts	
							D"	W"	H"	1	2
UC4964-O-WC-21-NST	6	4S	2 Piece	Blank	#14 - 4	Test Switch	5 $\frac{1}{8}$	12	20	2	1 $\frac{1}{4}$, 1 $\frac{1}{2}$
UC4965-O-WC-21-NST	8	5S	2 Piece	Blank	#14 - 4	Test Switch	5 $\frac{1}{8}$	12	20	2	1 $\frac{1}{4}$, 1 $\frac{1}{2}$
UC4966-O-WC-21-NST	13	6, 8, 9S & (ALT) 10S	2 Piece	Blank	#14 - 4	Test Switch	5 $\frac{1}{8}$	12	20	2	1 $\frac{1}{4}$, 1 $\frac{1}{2}$

Notes



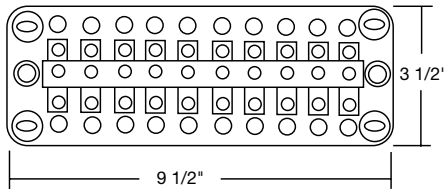
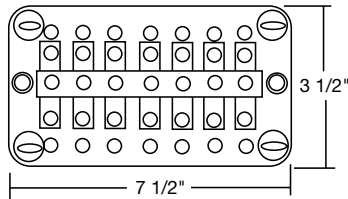
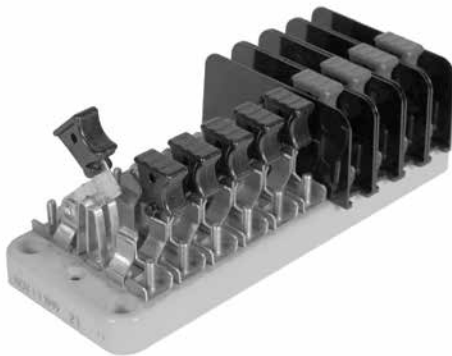

- **Hubs:** For proper hub selection, see the hub suffix chart on the Accessories page.
- **Connectors:** Supplied with tin plated mechanical connectors (#4 maximum).

Please consult serving utility for their requirements prior to ordering or installing, as specifications and approvals vary by utility, and may require local electrical inspector approval. All installations must be installed by a licensed electrician and must comply with all national and local codes, laws and regulations. Milbank reserves the right to make changes in specifications and features shown without notice or obligation.













Key	
P	Potential Switch
C+	Line side current switch with short circuit assembly
C	Load side current switch with test jack assembly
N	Neutral bar (no switch)
Pn	Neutral Potential Switch
X	Unused Position on base
	Insulating barrier, isolates both sides of switch

Catalog Number	4-Pole						
TS04-0101	X	P		X	C+	C	X
TS04-0102	X		C+	C	X	Pn	X
TS04-0103	X	P		X	C	C+	X
TS04-0104	X	C+	C	X	P		X









Notes











- 4-pole switches are also available on 10-pole bases. Contact Milbank for appropriate catalog numbers.

Catalog Number	7-Pole						
TS07-0105		P		C+	C	C+	C
TS07-0106		C+	C		C+	C	
TS07-0107		P		C	C+	C	C+
TS07-0108	C+	C	C+	C		P	

Notes

- 4-pole switches are also available on 10-pole bases. Contact Milbank for appropriate catalog numbers.

Catalog Number	7-Pole on a 10-Pole Base									
TS07-0049		X		X		X	C+	C	C	C+
TS07-0018		X		X		X	C+	C	C+	C
TS07-0059	X		C+	C		C	C+		X	X
TS07-0022	P	X	P	X	Pn	X	C	C+	C	C+

Catalog Number	10-Pole									
TS10-0109	P		P		C+	C	C+	C	C+	C
TS10-0110		C+	C		C+	C		C+	C	
TS10-0111	P		P		C	C+	C	C+	C	C+
TS10-0112	C+	C	C+	C	C+	C		P		

Current Transformer Enclosures

400–1200 Amps

43

400–1200 AMP
CURRENT
TRANSFORMER
ENCLOSURES



U1855-O-NE

Current Transformer Enclosures

Catalog Number	Amperage Rating	Hub	Steel Gauge	Connectors CU/AL	Dimensions		
					D"	W"	H"
U1855-O-NE	400–800	Blank	12	3 connectors per phase	12	36	36
U1856-O-NE	800–1200	Blank	12	5 connectors per phase	12	48	48

Notes

- **Features:** These enclosures have three-point locking handles, lift-off hinges with stainless steel pins and two doors. Type 3R rated.
- **Connectors:** Minimum #4, maximum 600 mcm.
- **U1855** and **U1856** both come from the factory with isolated neutrals. Bonding straps are included but not attached with each 1855 and 1856 if isolated neutral is not needed.

Please consult serving utility for their requirements prior to ordering or installing, as specifications and approvals vary by utility, and may require local electrical inspector approval. All installations must be installed by a licensed electrician and must comply with all national and local codes, laws and regulations. Milbank reserves the right to make changes in specifications and features shown without notice or obligation.



Test Cabinet

With Pre-Drilled Test Switch Bridge

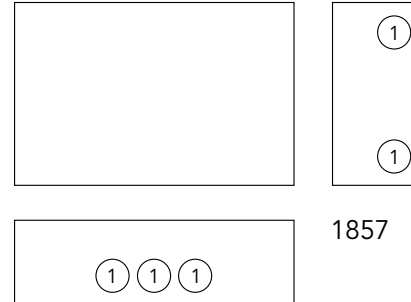
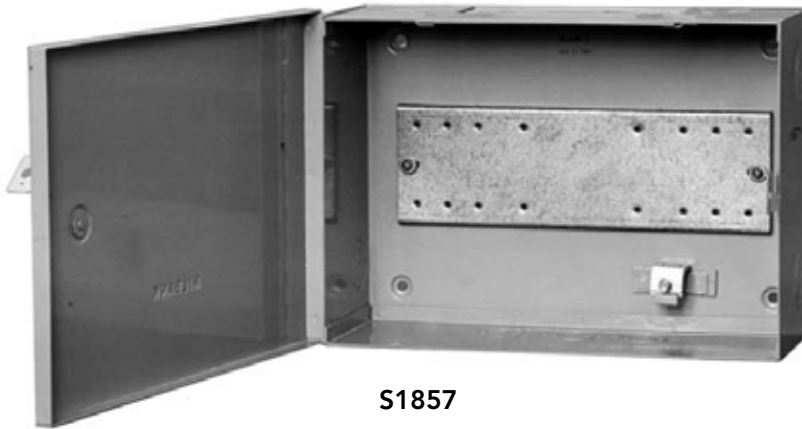

Test Cabinet

Catalog Number	Hub	Dimensions			Knockouts
		D"	W"	H"	1
S1857	Blank	4 $\frac{1}{8}$	14	10	1 $\frac{1}{4}$

Notes

- **Features:** Test cabinet has a piano-hinged cover and pre-drilled test switch bridge. The top of the enclosure has a rectangular knockout for bussing.



Please consult serving utility for their requirements prior to ordering or installing, as specifications and approvals vary by utility, and may require local electrical inspector approval. All installations must be installed by a licensed electrician and must comply with all national and local codes, laws and regulations. Milbank reserves the right to make changes in specifications and features shown without notice or obligation.

Polyphase Enclosures

For "A" Base Meters

45
POLYPHASE
ENCLOSURES



S2718-FB-XL-C



S3390-FB-XL-C7

Polyphase Enclosures

Catalog Number	Number of Positions	Hub	Dimensions		
			D"	W"	H"
S2718-FB-XL-C	1	C.P.	14	15	34 ¹¹ / ₁₆
S3390-FB-XL-C7	2	C.P.	11	28	34 ¹¹ / ₁₆

Notes

- **Features:** Units are supplied with full board and one demand reset cover per meter position. Cover holding arms included.

Please consult serving utility for their requirements prior to ordering or installing, as specifications and approvals vary by utility, and may require local electrical inspector approval. All installations must be installed by a licensed electrician and must comply with all national and local codes, laws and regulations. Milbank reserves the right to make changes in specifications and features shown without notice or obligation.



MILBANK
ENERGY AT WORK

Universal Meter Pedestal Unit

For Pad Mounting Applications

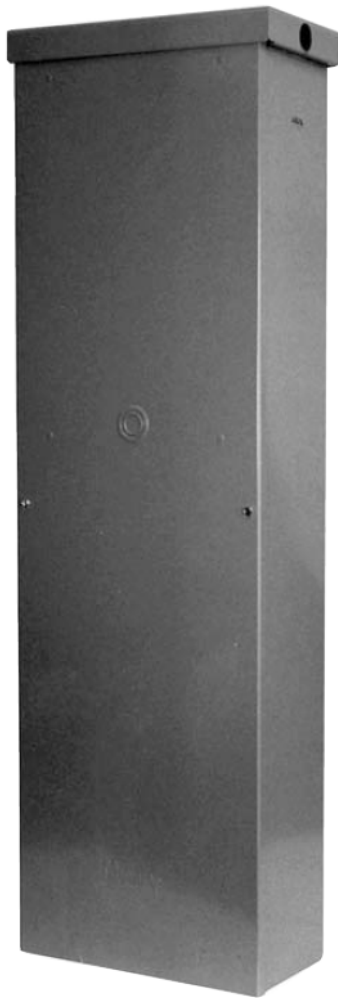

S3176-O

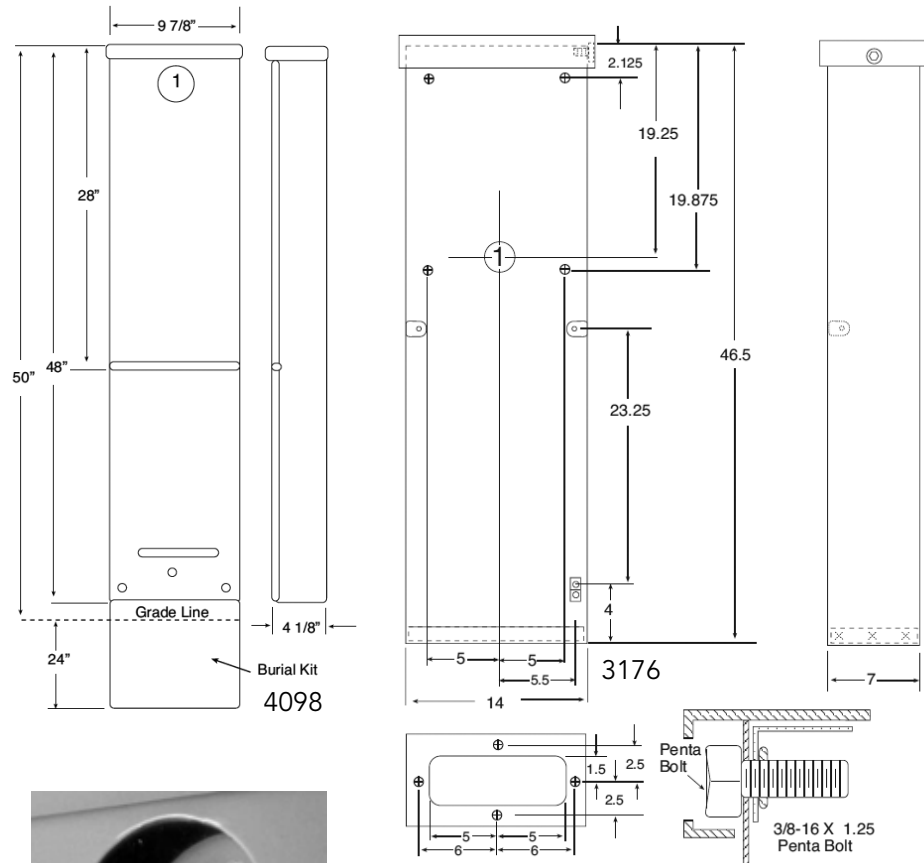

Penta Bolt locking mechanism

Universal Meter Pedestal Units for Pad Mounting

Catalog Number	Hub	Application	Service	Dimensions			Knockouts
				D"	W"	H"	1
S3176-O	Blank	Pad mounted pedestal	UG	7	14	46½"	1¼
S4098-O	Blank	See note below	UG	4⅞	9⅞	20	2½

Notes

- **Direct Burial Kit:** Direct burial kit K3236 and stabilizer foot K3188 are included. Pad mount sleeve K3237 must be ordered separately.
- **Connectors:** Supplied with tin plated mechanical connectors (#4 maximum).



Please consult serving utility for their requirements prior to ordering or installing, as specifications and approvals vary by utility, and may require local electrical inspector approval. All installations must be installed by a licensed electrician and must comply with all national and local codes, laws and regulations. Milbank reserves the right to make changes in specifications and features shown without notice or obligation.

Meter Main Pedestal

200 Amps | 4 Terminals | 120/240 VAC

47
200 AMP
METER MAIN
PEDESTAL

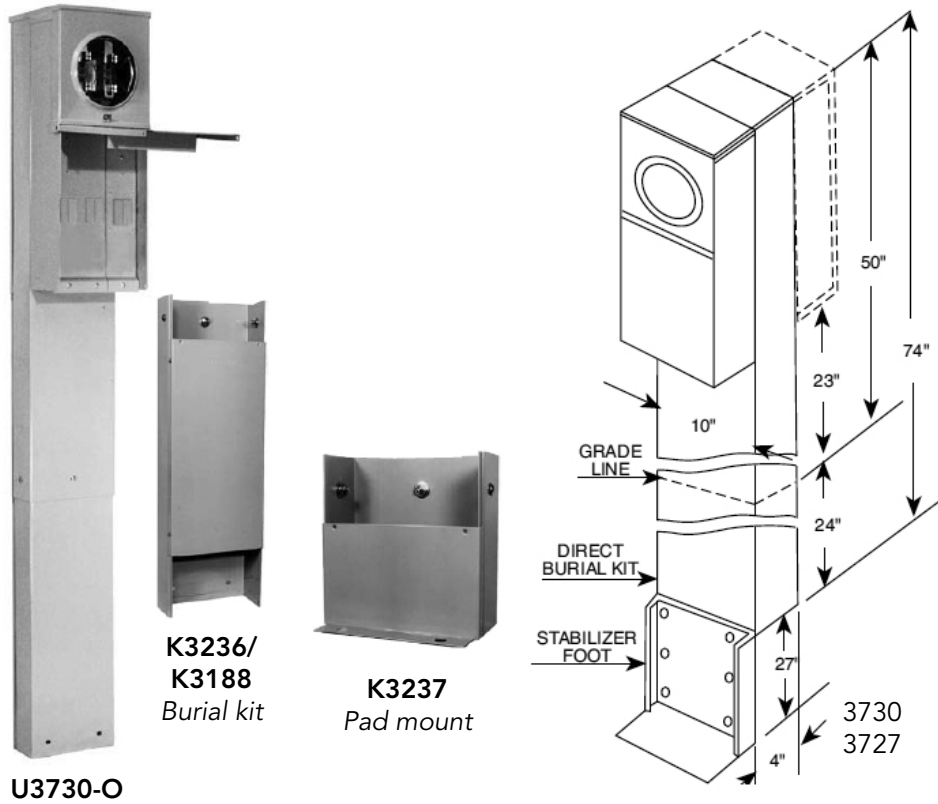

Universal Meter Pedestal Units for Pad Mounting

Catalog Number	Hub	Application	Service	Dimensions			Knockouts
				D"	W"	H"	1
U3730-O	Blank	Pad mounted pedestal	UG	7	14	46½"	1¼
U3727-O	Blank	See note below	UG	4⅞	9⅞	20	2½

Notes

- **Direct Burial Kit:** Direct burial kit K3236 and stabilizer foot K3188 are included. Pad mount sleeve K3237 must be ordered separately.
- **Connectors:** Supplied with tin plated mechanical connectors (#4 maximum).

Please consult serving utility for their requirements prior to ordering or installing, as specifications and approvals vary by utility, and may require local electrical inspector approval. All installations must be installed by a licensed electrician and must comply with all national and local codes, laws and regulations. Milbank reserves the right to make changes in specifications and features shown without notice or obligation.



48

200 AMP
METER MAIN
W/ LOAD CENTER
PEDESTALS

Meter Main w/ Load Center Pedestal

200 Amps | 4 Terminals | Lever Bypass | 120/240 VAC



U4322-O-BL

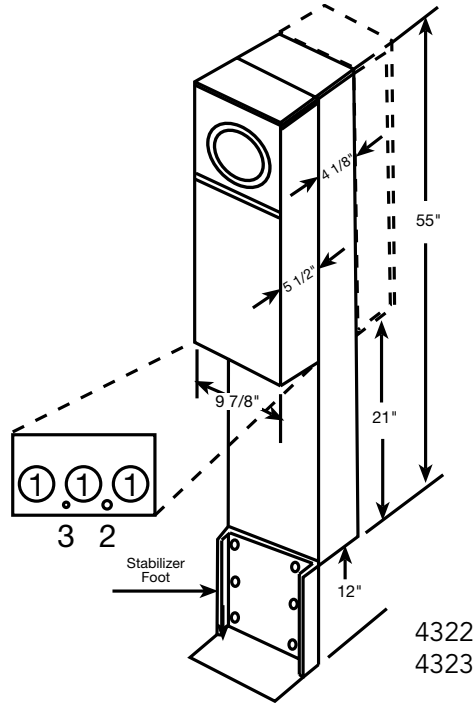

4322
4323



U4323-O-BL

200 Amps | 4 Terminals | Meter Main Pedestals | Lever Bypass | Ringless

Catalog Number	Meter Positions	Bypass	Connectors CU/AL		Circuit Provisions	Knockouts			Dimensions		
			Line	Load		1	2	3	D"	W"	H"
U4322-O-BL	Single	Lever	Twin #6-350	CB	6	2	1/2	1/4	9 5/8	9 7/8	55
U4323-O-BL	Double	Lever	Twin #6-350	CB	6	2	1/2	1/4	15 1/8	9 7/8	55

Notes

- **Lever Bypass:** Lever provides clamping action on meter spades and also operates bypass device
- **Application:** The U4322 & U4323 pedestals are suitable for use as service equipment or mobile home service equipment. K5081/K3188 for direct burial application is included with unit. K5151 for pad mount application must be ordered as extra.
- **Breakers:** These units are wired as parallel mains and have provisions for six circuits: 6 single-pole or 3 double-pole breakers.
- **Short Circuit Current Rating:** 10K AIC. However, this rating is limited to the lowest interrupting capacity of any circuit breaker installed. Watthour meter not included in short circuit current rating.



Please consult serving utility for their requirements prior to ordering or installing, as specifications and approvals vary by utility, and may require local electrical inspector approval. All installations must be installed by a licensed electrician and must comply with all national and local codes, laws and regulations. Milbank reserves the right to make changes in specifications and features shown without notice or obligation.

Temporary Power Units

125 Amp | 4 Terminal | Ringless | 120/240 VAC

49
125 AMP
TEMPORARY
POWER UNITS



U5101-XL-11GR

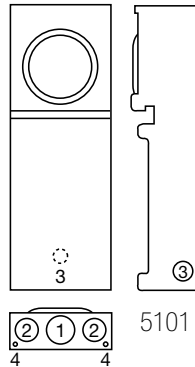

5101



U4908-O-11GR

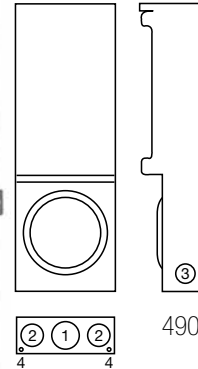

4908

4 Terminal | Temporary Power Units | Ringless | 1Ø3W

Catalog Number	Amps	Service	Hub	Connectors CU/AL		Dimensions			Knockouts				
				Line	Load	D"	W"	H"	1	2	3	4	5
U5101-XL-11GR*	125	OH	C.P.	#6-350	CB	5 ³ / ₁₆	8 ⁷ / ₈	25	2	1 ¹ / ₂	1 ¹ / ₄	1 ¹ / ₄	—
U4908-O-11GR*	125	UG	Blank	#6-2/0	CB	5 ³ / ₁₆	9	25 ¹⁵ / ₁₆	2	1 ¹ / ₂	1 ¹ / ₄	1 ¹ / ₄	—

Notes

- **Interior:** Six circuit plated copper interior accepts standard plug-in type circuit breakers.
- **Receptacle Bridge:** Three position self-grounded receptacle bridge accepts most standard NEMA receptacles with mounting plates.
- **Included Parts:** **U4908** and **U5101** come supplied with 2-20 amp single pole breakers and 2-20 amp GFCI receptacles (pre-wired and installed).

Please consult serving utility for their requirements prior to ordering or installing, as specifications and approvals vary by utility, and may require local electrical inspector approval. All installations must be installed by a licensed electrician and must comply with all national and local codes, laws and regulations. Milbank reserves the right to make changes in specifications and features shown without notice or obligation.





UQFP
UQFP-M



UQFB-M
UQFBH-M



UQFB-X1



UQFBH

200 Amp Frame | Plug-In | 10,000 AIC & 22,000 AIC | Two-Pole - Common Trip

Amps	10K AIC Plug-In	22K AIC Plug-In	10K AIC Plug-In	22K AIC Plug-In	Wire Range	
					CU	AL
100	UQFP-100	UQFPH-100	UQFP-M-100	UQFPH-M-100	#3-#1	#1-1/0
125	UQFP-125	UQFPH-125	UQFP-M-125	UQFPH-M-125	#3-#1	#1-1/0
150	UQFP-150	UQFPH-150	UQFP-M-150	UQFPH-M-150	1/0-300	2/0-300
175	UQFP-175	UQFPH-175	UQFP-M-175	UQFPH-M-175	1/0-300	2/0-300
200	UQFP-200	UQFPH-200	UQFP-M-200	UQFPH-M-200	1/0-300	2/0-300

200 Amp Frame | Bolt-On | 10,000 AIC & 22,000 AIC | Two-Pole - Common Trip

Amps	10K AIC Bolt-On	22K AIC Bolt-On	10K AIC Bolt-On	22K AIC Bolt-On	Wire Range	
					CU	AL
100	UQFB-100	UQFBH-100	UQFB-100-X1	UQFBH-M-100	#3-#1	#1-1/0
125	UQFB-125	UQFBH-125	UQFB-125-X1	UQFBH-M-125	#3-#1	#1-1/0
150	UQFB-150	UQFBH-150	UQFB-150-X1	UQFBH-M-150	1/0-300	2/0-300
175	UQFB-175	UQFBH-175	UQFB-175-X1	UQFBH-M-175	1/0-300	2/0-300
200	UQFB-200	UQFBH-200	UQFB-200-X1	UQFBH-M-200	1/0-300	2/0-300

Notes

- **UL Listed:** For use with 60°C or 75°C wire.
- **UQFP:** For parallel main circuit breaker applications.
- **UQFP-M:** For series main circuit breaker applications Split load tab features allow for feed-through capability.
- **UQFB:** (2) 1/0-300 lugs provided on load and line side (cable-in, cable-out).
- **UQFB3:** Three-pole available. Consult factory.
- **UQFB-X:** (2) 1/0-300 lugs provided on load side and (2) line bar bus connections on line side.
- **UQFB-M:** For series main circuit breaker applications. Split load tab features allow for feed-through capability.



Please consult serving utility for their requirements prior to ordering or installing, as specifications and approvals vary by utility, and may require local electrical inspector approval. All installations must be installed by a licensed electrician and must comply with all national and local codes, laws and regulations. Milbank reserves the right to make changes in specifications and features shown without notice or obligation.

Circuit Breakers

QP (small frame) and QN (large frame) | 120/240 VAC

15–125 Amp Breaker Plug-In Type | 1" Per Pole

Amps	Poles	10K AIC Plug-In	22K AIC Plug-In
15	Single	Q115	Q115H
15	Double	Q215	Q215H
20	Single	Q120	Q120H
20	Double	Q220	Q220H
25	Single	Q125	Q125H
25	Double	Q225	Q225H
30	Single	Q130	Q130H
30	Double	Q230	Q230H
35	Single	Q135	Q135H
35	Double	Q235	Q235H
40	Single	Q140	Q140H
40	Double	Q240	Q240H
50	Single	Q150	Q150H
50	Double	Q250	Q250H
60	Single	Q160	Q160H
60	Double	Q260	Q260H
70	Single	Q170	Q170H
70	Double	Q270	Q270H
80	Double	Q280	Q280H
90	Double	Q290	Q290H
100	Double	Q2100	Q2100H
125	Double	Q2125	Q2125H



QN2200H



QN2200RH



WBJ2200



Q250

200 Amp Frame | Plug-In | 10,000 AIC & 22,000 AIC | Two-Pole, Common Trip

Amps	10K AIC Plug-In	22K AIC Plug-In	Handle Location	Wire Range	
				CU	AL
150	QN2150	QN2150H	Left facing	#4-300	#4-300
200	QN2200	QN2200H	Left facing	#4-300	#4-300
150	QN2150R	QN2150RH	Right facing	#4-300	#4-300
200	QN2200R	QN2200RH	Right facing	#4-300	#4-300
150	WBJ2150	—	Centered	#2-300	#2-300
200	WBJ2200	—	Centered	#2-300	#2-300

Notes

- Load connectors supplied with breakers.
- UL Listed for use with 60°C or 75°C wire.
- Wire sizes shown are lug capacity. Consult NEC Article #310 for specific wire sizes.

Please consult serving utility for their requirements prior to ordering or installing, as specifications and approvals vary by utility, and may require local electrical inspector approval. All installations must be installed by a licensed electrician and must comply with all national and local codes, laws and regulations. Milbank reserves the right to make changes in specifications and features shown without notice or obligation.



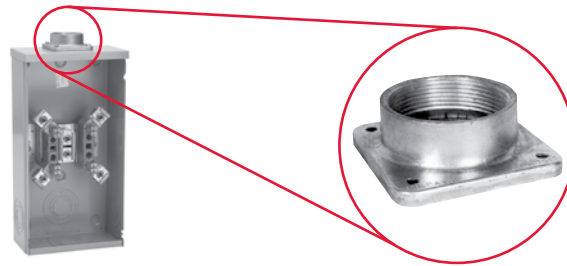
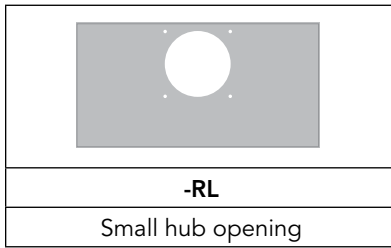

-WL A7514	-YL A7515	-ZL A7516	-DL A7517	-EL A7518	-XL A7551
1" hub	1¼" hub	1½" hub	2" hub	2½" hub	Small closing plate

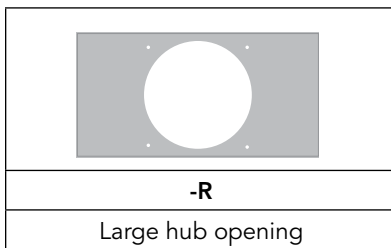

-F A8110	-G A8111	-H A8112	-X A9064	-RRL S8324
3" hub	3½" hub	4" hub	Large closing plate	Large hub opening adapted to small hub opening

Notes

- **Suffix:** Add to catalog number for factory installation of hub.
- **Packaging:** Individually packed units for field installation.
- **Abbreviations:** H.O. (hub opening), C.P. (closing plate).
- Hub Mast rated





Please consult serving utility for their requirements prior to ordering or installing, as specifications and approvals vary by utility, and may require local electrical inspector approval. All installations must be installed by a licensed electrician and must comply with all national and local codes, laws and regulations. Milbank reserves the right to make changes in specifications and features shown without notice or obligation.

Accessories

Connector Kits, Closing Kits & Generator Interlock

Connector Kits — For Use with 3/8"-16 Stud Type Units Only

					
Single			Twin		
Suffix	Part #	(3 per set) - 1Ø	Suffix	Part #	(3 per set) - 1Ø
K1	K1539	6-350	K2	K1350	6-350
K3	K1540	4-600 or (2) 1/0-250*	K2L	K1350L	6-350 (non rotating)
K3L	K1540L	4-600 or (2) 1/0-250* (non rotating)	K4	K1541	4-600
Suffix	Part #	(4 per set) - 3Ø	Suffix	Part #	(4 per set) - 3Ø
K5	K3082	6-350	K6	K3442	6-350
K7	K3441	4-600 or (2) 1/0-250*	K8	K3083	4-600

*For (2) 1/0-250, conductors must be of same size.



Bypass Link



Note

Consult factory for proper connector kits for studded meter sockets.

Closing Covers

	
Meter Closing Plate (Ring Type / Ringless)	Metal Closing Plate (For Ringless Sockets)
6003 - Grey Plastic	CP-21
6116 - Clear Plastic	
6002 - Clear Plastic	

Disconnect Sleeve



Isolated Neutral Kit



Pole Hanger Kit



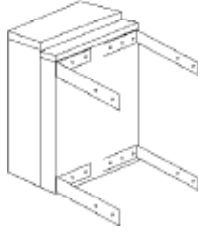

850 comes with 4 pole hangers

	
Catalog Number	Description of pole hanger brackets
850	Two pair (4 pieces) with mounting hardware

Please consult serving utility for their requirements prior to ordering or installing, as specifications and approvals vary by utility, and may require local electrical inspector approval. All installations must be installed by a licensed electrician and must comply with all national and local codes, laws and regulations. Milbank reserves the right to make changes in specifications and features shown without notice or obligation.

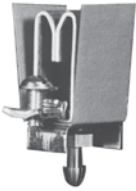
Fifth Terminals, Tap Connectors & Block Assemblies

Fifth Terminals

			
5T8K2 - 100-200 Amp "Plug-In"	K5T - 200 Amp (Block with Square Hole)	K3865 - Heavy Duty Jaw Clamping (K3866 without Neutral Wire)	K3356

Tap Connectors (3 per set)

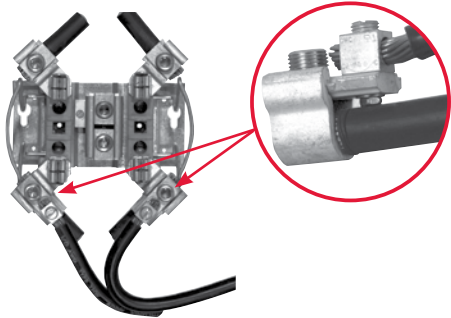
	Replaces the load or line side slide-in nut assembly on Milbank 200 amp sockets. Allows for a 100 amp tap location in addition to the #6-350 kcmil load-side connector. K5022 includes safety barrier extensions for applications over 300 VAC. Three lugs per kit.
K4977-INT - Internal Hex	
K4977-EXT - External Hex	
K5022-INT - Internal Hex (set of 4 w/ barrier)	

Triplex Ground

K1190 (For factory installed triplex ground, add suffix -TG to catalog number)

100 Amp Blocks *(single sockets only)*

BL7474 - Block Assembly
Z904486-AO - Slotted Nut Assembly
Z802965-AC - Neutral without Nut
Z901925-AC - Hex Nut Set Screw

200 Amp Blocks *(single sockets only)*



Please consult serving utility for their requirements prior to ordering or installing, as specifications and approvals vary by utility, and may require local electrical inspector approval. All installations must be installed by a licensed electrician and must comply with all national and local codes, laws and regulations. Milbank reserves the right to make changes in specifications and features shown without notice or obligation.

Commercial Pedestals

Attractive | Easy to Install | Secure | Cost-Effective

Milbank Commercial Pedestals are pad-mounted, weather resistant electrical enclosures consisting of a utility pull section with optional meter socket, and a customer section containing distribution and control equipment. Milbank Commercial Pedestals are an attractive, secure, easy to install and cost-effective solution when underground remote site power distribution and control equipment is required, replacing unsightly and inefficient strut and backboard structures.



Strut and backboard



Commercial pedestal

UL Listed as Industrial Control Equipment (File E113855)

Standard Features

- Type 3R rain resistant, vandal-resistant cabinet of polyurethane powder-coated steel (aluminum or stainless steel also available)
- UL listed as enclosed industrial control equipment (UL508)
- Isolated lockable and sealable utility metering and lug landing sections
- Lockable customer section for distribution and control equipment with internal deadfront
- Print pocket inside customer section door contains wiring schematics and installation instructions
- Most load centers are UL listed for use with various manufacturers' circuit breakers
- All stainless steel external hardware (screws, bolts, hinges, handles, hasps and sealing screws)

Note

All meter form and bypass options available to meet utility requirements.

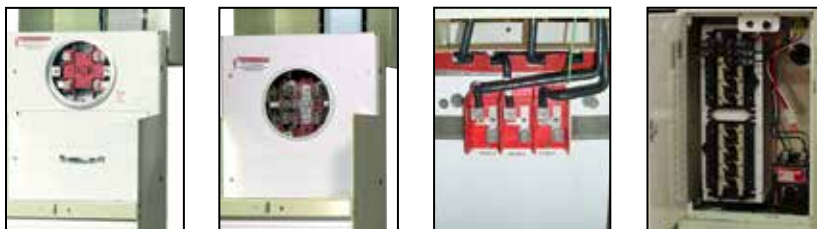

Please consult serving utility for their requirements prior to ordering or installing, as specifications and approvals vary by utility, and may require local electrical inspector approval. All installations must be installed by a licensed electrician and must comply with all national and local codes, laws and regulations. Milbank reserves the right to make changes in specifications and features shown without notice or obligation.



Attractive | Easy to Install | Secure | Cost-Effective



Applications

These units are ideal for controlling and metering:

- Traffic signals
- Street lighting
- Power distribution for EV charging stations
- Irrigation and sprinkler systems
- Cell towers and telephone vaults
- Pump stations
- Temporary power for fairgrounds, swap meets, outdoor markets, portable offices, holiday lights, etc.
- Outdoor lighting for athletic fields, tennis and basketball courts, parking lots, landscaping and subdivision entrances, etc.

Available Factory-Installed Options

- Meter sockets: ring type or ringless, up to 400 amp
- Main and branch breakers or T fuses
- Distribution: copper load centers and panel boards
- Clocks, timers and relays
- Photoelectric cells and controls
- Power receptacles: pin and sleeve, twist lock or straight blade
- Contactors: definite purpose, electrical or mechanically held, IEC and mercury types
- Surge protection and lightning arrestors
- Reserve inlet generator receptacle with interlocked circuit breakers
- Motor starters and relays
- Push button controls
- Thermostat controls, fans and heating strips
- Power blocks and terminal blocks
- Steel, aluminum and plywood backboards
- Transformers
- Interlock devices for circuit breakers
- Available in steel, aluminum (raw painted or anodized) or stainless steel construction with powder-coated finish available in eight standard colors or special-ordered RAL colors
- Available for applications up to 400 amp, 120V, 208V, 240V, 277V, 480V - 1Ø or 3Ø

Accessories



K3865
Fifth terminal kit for use with ringless meter sockets

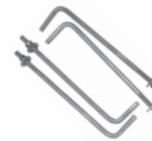

CP-ABK5/8
Anchor bolt kit (includes four 5/8 - 13 x 18" anchor bolts)



105J
Fifth terminal kit for use with ring type meter sockets



CP-TC7D
7-day time clock kit
CP-TC24H
24-hour time clock kit
CP-TCWIRE
Male 4-pin connector and wiring harness for use with time clocks other than above

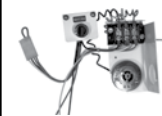

CP-PE-HOA-3POS
HOA switch for field installation



CP-16PDMNT-CALT
16" pedestal mounting base
CP-24PDMNT-CALT
24" pedestal mounting base (includes mounting hardware)



Please consult serving utility for their requirements prior to ordering or installing, as specifications and approvals vary by utility, and may require local electrical inspector approval. All installations must be installed by a licensed electrician and must comply with all national and local codes, laws and regulations. Milbank reserves the right to make changes in specifications and features shown without notice or obligation.

Commercial Pedestals

Main Load Center Series | Custom Designs Available

CP3B "ML" Series

Main Load Center Series

1Ø3 wire 120/240V or 208Y/120V

Application: remote site service for multiple loads

The **Milbank Main Load Center Commercial Pedestals** are designed to handle the vast majority of all requirements in a standard, stocked configuration.

- All units feature a load center with a plug-on, back-fed main breaker.
- Load center has 16 positions for the 100 amp pedestals and 24 circuits for the 200 amp pedestals.
- Both sizes include sub-feed lugs to allow feeding an external panel.

If your application requires turning loads on based on "dusk-to-dawn" requirements, be sure to see the Milbank Switched Load Center Commercial Pedestal products on the following page.

Features

These units include everything required for remote site service:

- NEMA 3R construction.
- Expandable: load centers allow for future expansion without costly modifications.
- All units feature 200 amp meter socket with optional field installable fifth terminal kit available.
- 22K ampere interrupting capacity (AIC) standard.
- Optional mounting base can be embedded in concrete for fast, easy installation.
- Separate sealable and lockable utility termination section.
- Separate sealable and lockable metering section.
- Separate sealable and lockable customer section with a load center for "always on" loads that include a main circuit breaker, 20 (125 or 200 amp model) or 14 (100 amp model) blank breaker spaces and a circuit directory to document configuration.



CP3B11115A22

Typical Applications

Remote site service for multiple loads.

Stocked Pedestals	Optional Fifth Terminal Kit	Main CB		Load Center Circuits	Meter Socket Type
		Amp	Spaces		
CP3B51115A22	K3865	100	1,2	16	Ringless socket with lever bypass
CP3B52119A22	K3865	200	1,2,3,4	24	Ringless socket with lever bypass

Notes

- Chart shows standard, stocked items. Other options and features are available. Contact factory for options, details and availability.

Please consult serving utility for their requirements prior to ordering or installing, as specifications and approvals vary by utility, and may require local electrical inspector approval. All installations must be installed by a licensed electrician and must comply with all national and local codes, laws and regulations. Milbank reserves the right to make changes in specifications and features shown without notice or obligation.



CP3B "SL" Series

Switched Load Center Series
1Ø3 wire 120/240V or 208Y/120V

Milbank's Switched Load Center Commercial Pedestals are designed not only to provide power for various loads, but also to switch specific loads on and off under certain conditions. A photoelectric cell is used for these controlled loads, and an optional time clock is also available.

Features

These units include everything required for remote site service:

- NEMA 3R construction.
- Expandable: load centers allow for future expansion without costly modifications.
- All units feature 200 amp meter socket with optional field installable fifth terminal kit available.
- 22K ampere interrupting capacity (AIC) standard.
- Optional mounting base can be embedded in concrete for fast, easy installation.
- Separate sealable and lockable utility termination section.
- Separate sealable and lockable metering section.
- Separate sealable and lockable customer section with a control circuit including PE receptacle, Lexan® window, glare shield, Hand-Off-Auto (HOA) switch, contractor controlling a 16-circuit load center for controlled loads, a pre-mounted DIN rail and pre-wired connector to add an optional "plug-and-play" time clock kit for PE on and TC off operation and a circuit directory to document configuration.
- A load center for "always on" loads that includes a main circuit breaker, a control power circuit breaker, a switched load center main breaker, nine (125 or 200 amp model) or 11 (100 amp model) blank breaker spaces and a circuit directory to document configuration.



CP3B11110A22SL1

Typical Applications

Traffic signals, parking lots, highways & athletic field lighting

Stocked Pedestals	Optional Fifth Terminal Kit	Main CB		Contactor Amperage	Meter Socket Type
		Amp	Spaces		
CP3B51110A22SL1	K3865	100	1,3	60	Ringless socket with lever bypass
CP3B52110A22SL1	K3865	200	1,2,3,4	100	Ringless socket with lever bypass

Notes

- Chart shows standard, stocked items. Other options and features are available. Contact factory for options, details and availability.



Please consult serving utility for their requirements prior to ordering or installing, as specifications and approvals vary by utility, and may require local electrical inspector approval. All installations must be installed by a licensed electrician and must comply with all national and local codes, laws and regulations. Milbank reserves the right to make changes in specifications and features shown without notice or obligation.

Commercial Pedestals

CP3B "400" 400 Amp Series



CP3B1411JB22

Typical Applications

Remote site service for residential and commercial job sites

Milbank's 400 Amp Commercial Pedestal is designed to provide a weather and vandal resistant metered enclosure for various loads and distribution. Each pedestal has been designed to handle a wide range of applications using standard, stocked configurations.

- Choice of a single main breaker or twin service disconnect breakers gives flexibility to the pedestal design.
- Optional distribution with feed-thru lugs below the service disconnect breakers allows the pedestal to handle numerous applications.
- Typical applications include remote homes where the metering is best located at the curb side or other remote area. The pedestal can also provide power to secondary residence, on-site business, workshop, irrigation, lighting, security or other secondary load.
- Available in custom colors to match home or landscaping.

Features

These units include everything required for remote service:

- Type 3R construction
- Main circuit breaker or dual service disconnects
- Expandable: load center units allow for future expansion without costly modifications
- Optional mounting base can be embedded in concrete for fast, easy installation
- Separate sealable and lockable utility termination section with lug termination
- Separate sealable and lockable metering section
- A separate sealable and lockable customer section with a circuit directory and a print pocket to hold all documentation
- Meter socket options include ring type with bypass studs, ringless with heavy duty lever bypass, or K-Type bolt-on

Standard Pedestals	Optional fifth Terminal Kit	Main CB	Load Center Circuits	Meter Socket Type
CP3B54120B22	K3865	2-200 amp	(2) 12 circuit	Ringless with lever bypass
CP3B5411JB22	K3865	320 amp (400 max)	0	Ringless with lever bypass

Notes

- Chart shows standard, stocked items. Other options and features are available. Contact factory for options, details and availability.
- Stud utility landing is standard. Lug kits are available from factory.
- Units with load centers have (2) #6-250 sub-feed lugs on each load center. (Each load center is 200 amp rated and UL Listed with: Siemens, General Electric and Cutler-Hammer plug-in style circuit breakers.)

Please consult serving utility for their requirements prior to ordering or installing, as specifications and approvals vary by utility, and may require local electrical inspector approval. All installations must be installed by a licensed electrician and must comply with all national and local codes, laws and regulations. Milbank reserves the right to make changes in specifications and features shown without notice or obligation.



Commercial Pedestals

CP3B "IR" Irrigation Control Series



CP3B0281UMWIR04

Milbank's "IR" Series Irrigation Pedestals install quickly and simply – often in less than an hour with a single technician – a fraction of the time typically needed for strut farm and other installation set ups. Additionally, the pedestal comes pre-wired, so the technician simply drops in the pre-drilled concrete box pad, fastens the pedestal and runs the wires. Prewired landing lugs are provided in a separate utility side so that there is no more need to wrestle with hard-to-bend wires. Simply run the utility wire up and land on the lugs. With both the motor starter and disconnect in the same enclosure, all the controls are housed in a safe, lockable pedestal that protects against vandalism and energy theft.

Features

- 3Ø4W, 480Y/277 volt
- One technician can install in under an hour with use of Milbank's pre-drilled box pad
- All units are UL listed and service entrance rated
- Fused disconnect with accessible handle through the deadfront
- HOA and push button start
- Separate accessible utility side with pre-wired landing lugs
- NEMA rated starters (sizes 1-5)
- Soft start units sizes 30HP-150HP
- 30 amp fuse block for pivot pre-wired in the unit
- White powder coated paint finish helps keep components cooler
 - Options include:
 - Hour meter
 - Chemical injection receptacle
 - Multiple injection receptacle
 - Multiple 30A fuse blocks possible

Typical Applications

Power pedestal for irrigation systems or other pump control applications

Stocked Pedestals	Exterior Cabinet	NEMA Rating
CP3B0281UMWIR04	White	4
CP3B0281UMWIR03	White	3
CP3B0181UMWIR02	White	2

Notes

- Chart shows standard, stocked items. Other options and features are available. Contact factory for options, details and availability.



Please consult serving utility for their requirements prior to ordering or installing, as specifications and approvals vary by utility, and may require local electrical inspector approval. All installations must be installed by a licensed electrician and must comply with all national and local codes, laws and regulations. Milbank reserves the right to make changes in specifications and features shown without notice or obligation.

Commercial Pedestals

CP3B "BBS" Battery Backup Series



CP3B5111TCAWSP1

Typical Applications

Metered emergency uninterrupted power for traffic intersections, wireless, phone and communications equipment, parking lots, camera and security locations

Milbank's BBS Series Commercial Pedestals are designed to provide battery backup power for various loads, and to switch specific loads on and off under certain conditions; a photoelectric cell or time clock to control lighting circuits, as an example. Metered and non-metered power distribution options are available. The back-up power pedestal is designed to handle the vast majority of today's back-up power requirements. By using 19" rack design, shelves can be adjusted to accommodate the required batteries and manufactures DC to AC inverters, transfer switches and other related equipment. This design gives the user a wide range of design and configuration options. Complete turnkey, ready to power-up pedestals are offered along with basic units ready to accept batteries and inverters supplied by others.

Features

- Type 3R construction
- 100 through 320 amp meter socket with the option of either a ring type socket (conforms to EUSERC 308) with or without test / bypass blocks or a heavy duty ringless socket with lever bypass
- Separate sealable utility termination compartment
- An isolated separate customer section with service disconnects, power distribution options and power control
- 19" wide rack in customer compartment for easy layout of equipment
- Battery trays
- Thermostat with cooling fan
- Filtered louvers for heat rise flow through ventilation
- Three point door latch (key or pad lockable)

Options

- Manual bypass switch
- Transfer switch for generator power back-up
- Generator inlet receptacles 30A through 200A
- Pad lockable provision for receptacles
- Police access door
- Metered load center distribution
- Non metered load center distribution
- Photo electric controls (for street lighting)
- Time clocks
- HOA switches
- Contactors
- GFI duplex receptacles
- Thermostat for heating control
- Heating pads or elements
- Roll out shelves for batteries
- Surge arrestors and lighting arrestors

Please consult serving utility for their requirements prior to ordering or installing, as specifications and approvals vary by utility, and may require local electrical inspector approval. All installations must be installed by a licensed electrician and must comply with all national and local codes, laws and regulations. Milbank reserves the right to make changes in specifications and features shown without notice or obligation.



Commercial Pedestals

CP3B "Power Transfer" Series



Milbank's Power Transfer Series Pedestals provide non metered AC power, distribution, surge suppression, mechanical interlock and stand-by generator receptacle all in a neat, compact pedestal.

Features

- 120/240V 1Ø3W thru 277/480V 3Ø4W ratings
- Metered or unmetered units
- Choice of EUSERC ring type or ringless meter sockets
- 60 Amp thru 400 amp ratings
- UL Listed Type 3R rated
- Pad lockable, isolated utility compartments
- 20 amp GFI convenience receptacle
- Lockable recessed generator receptacle door
- Utility and generator indicator light options
- All stainless steel hardware
- Galvanized steel, aluminum or stainless steel cabinet options
- Custom designs available



Typical Applications

Traffic intersections, cell sites, cable TV, pump and lift stations requiring utility power with backup generator power



Please consult serving utility for their requirements prior to ordering or installing, as specifications and approvals vary by utility, and may require local electrical inspector approval. All installations must be installed by a licensed electrician and must comply with all national and local codes, laws and regulations. Milbank reserves the right to make changes in specifications and features shown without notice or obligation.

Commercial Pedestals

CP3BB "CT Metered" Series

63
COMMERCIAL
PEDESTALS



Milbank's CT Metered Series

Commercial Pedestals are designed to be used where a smaller service package would be a better choice over large 3R rated combination switchboards. These pedestals have amperage ratings of 400 to 800 amp at voltages up through 480 volt three phase.

Features

- UL Listed, freestanding Type 3R service
- A low profile CT pedestal
- All utility equipment is isolated in separated pad lockable and sealable compartments
- Separate customer compartment designed to hold distribution and control equipment
- Dead front customer construction
- Optional mounting base
- Optional construction in steel, aluminum and stainless steel.
- Wide choice of powder paint colors

Typical Applications

Large homes, pumping and lift stations, motor control, water treatment plants, EV charging stations, commercial buildings, large remote service requirements, commercial and industrial control systems

Please consult serving utility for their requirements prior to ordering or installing, as specifications and approvals vary by utility, and may require local electrical inspector approval. All installations must be installed by a licensed electrician and must comply with all national and local codes, laws and regulations. Milbank reserves the right to make changes in specifications and features shown without notice or obligation.



Commercial Pedestals

CP3A "Slimline" Series



Milbank's Slimline Series Commercial Pedestals provide a sleeker, smaller footprint and wireway access on the side of the unit rather than the back, allowing maximum flexibility to place the pedestal in tighter spaces.

Features

- UL Listed as service equipment
- 100 or 200 amp
- Vandal-resistant, secure and attractive design
- Customer compartment with distribution and control equipment with swing dead front door, secured with both a hasp/latch and draw latch outer door
- Utility metering compartment protected with a hinged hood, increasing resistance to meter vandalism
- Small footprint
- Wireway located on left side of pedestal for utility incoming wire, allowing pedestal to be mounted with back very close to a wall (14")
- Available in 12" and 20" widths and 50" and 63" (metered) and 43" (nonmetered) heights
- Includes a print pocket for plans and drawings
- 200 amp main available
- Voltage range: 120V–480V
- Compatible with both ringless and ring type meter sockets, 4–7 terminals
- Available in a wide array of colors, including but not limited too all ANSI powder coated paint colors upon request
- Pedestal mounting base option saves time and labor to install on a cement pad—no anchor bolts required
- Powder-coated G90 galvanized steel, raw, anodized or powder-coated aluminum and stainless steel exterior options

"Slimline" Series Direct Bury Extension

- No need for concrete
- Bolts directly to unit
- Easy, modular design
- Ships in a smaller package
- Increases project flexibility
- Easier to handle and install
- Utilizes a stabilizer foot to prevent leaning over time
- Pedestal and extension can be installed within 30 minutes

Notes

- Currently only built in 14 guage steel
- Only available for 12" pedestals

Typical Applications

Roadway lighting and signage, wastewater treatment facilities, parks and landscaping, and any application where physical space is at a premium



Please consult serving utility for their requirements prior to ordering or installing, as specifications and approvals vary by utility, and may require local electrical inspector approval. All installations must be installed by a licensed electrician and must comply with all national and local codes, laws and regulations. Milbank reserves the right to make changes in specifications and features shown without notice or obligation.

Watt-hour Meter Forms

Standard Forms | Transformer Rated or Self-Contained

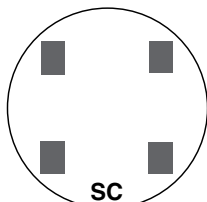

SC
2 and 3-WIRE FORMS
1S & 2S

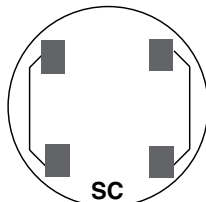

SC
2 and 3-WIRE FORMS
1S & 2S with BYPASS

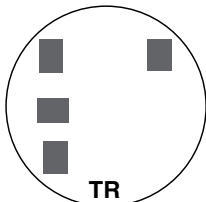

TR
2-WIRE FORM 3S
5th Term. 9 o'clock

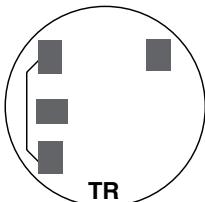

TR
2-WIRE FORM 3S
with BYPASS

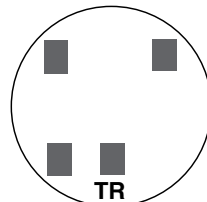

TR
2-WIRE FORM 3S
5th Term. 6 o'clock

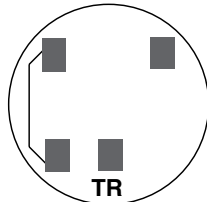

TR
2-WIRE FORM 3S
with BYPASS

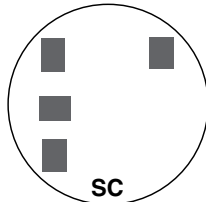

SC
2 ELEMENT
3-WIRE NETWORK
FORM 12S 5th
TERM. 9 o'clock

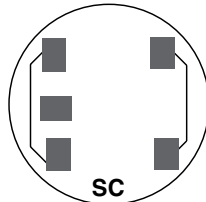

SC
2 ELEMENT 3-WIRE
NETWORK FORM 12S
with BYPASS
5th Term. 9 o'clock

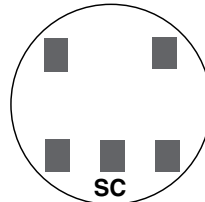

SC
2 ELEMENT
3-WIRE NETWORK
FORM 12S 5th
TERM. 6 o'clock

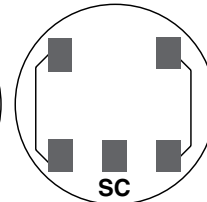

SC
2 ELEMENT 3-WIRE
NETWORK FORM 12S
with BYPASS
5th Term. 6 o'clock

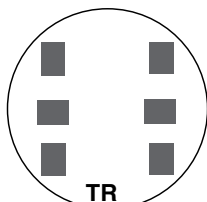

TR
3-WIRE FORM 4S

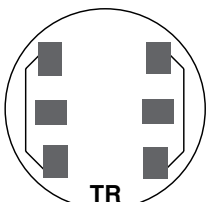

TR
3-WIRE FORM 4S
WITH BYPASS

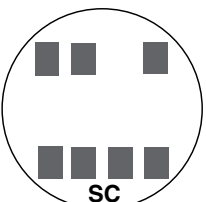

SC
2 or 3 ELEMENT
3Ø4W Y or
Y FORM 14S
FORM 15S
Y FORM 16S

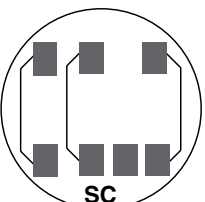

SC
2 or 3 ELEMENT
3Ø4W Y or
FORMS 14S & 15S
with BYPASS

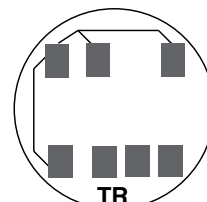

TR
2 ELEMENT
3Ø4W Y or
Y FORM 7S
FORM 24S
with BYPASS

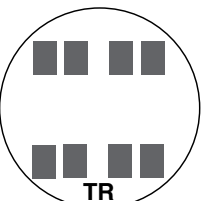

TR
2 ELEMENT
2Ø3W, 2Ø4W, 3Ø3W
FORM 5S

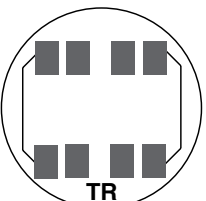

TR
2 ELEMENT Ø3W,
2Ø4W, 3Ø3W
FORM 5S with
BYPASS

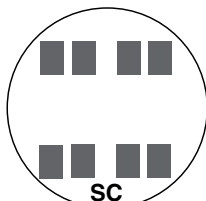

SC
2 ELEMENT
2Ø3W, 2Ø4W, 3Ø3W
FORM 13S

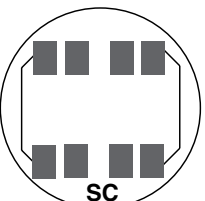

SC
2 or 3 ELEMENT
2Ø3W, 2Ø4W, 3Ø3W
FORM 13S with
BYPASS

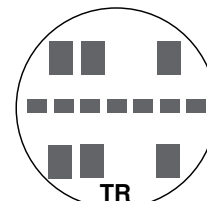

TR
2 or 3 ELEMENT
3Ø4W Y or
Y FORM 9S
FORM 8S

TR = TRANSFORMER RATED
SC = SELF CONTAINED

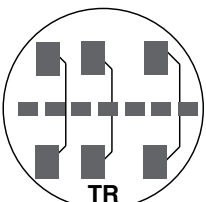

TR
2 or 3 ELEMENT
3Ø4W Y or
FORMS 8S & 9S
FORMS 8S & 9S
with BYPASS

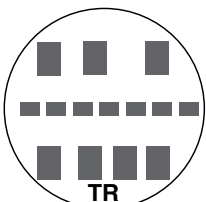

TR
2 ELEMENT
3Ø4W Y
FORM 6S

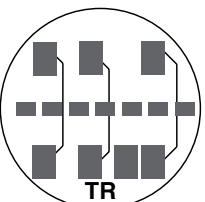

TR
2 ELEMENT
3Ø4W Y
FORM 6S
with BYPASS

Please consult serving utility for their requirements prior to ordering or installing, as specifications and approvals vary by utility, and may require local electrical inspector approval. All installations must be installed by a licensed electrician and must comply with all national and local codes, laws and regulations. Milbank reserves the right to make changes in specifications and features shown without notice or obligation.

DIAGRAM A
1∅2W with 1 P.T.'s & 1 C.T.
Single Stator Meter (2W1∅) - Form 3S
5T Socket, Test Switch #TS04-0101

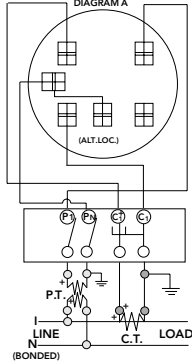

DIAGRAM B
1∅3W with 1 C.T.
Single Stator Meter (2W1∅) - Form 3S
5T Socket, Test Switch #TS04-0101

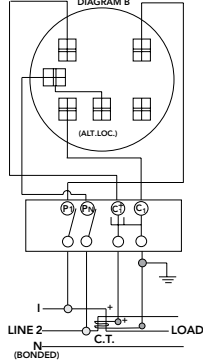

DIAGRAM C
1∅3W with 2 C.T.'s
Single Stator Meter (3W1∅) - Form 4S
6T Socket, Test Switch #TS07-0105

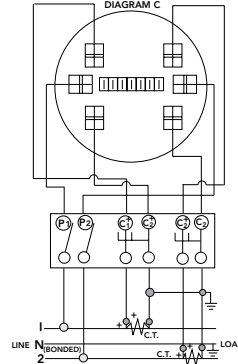

DIAGRAM D
1∅3W or 3W Network with 2 C.T.'s
2 Stator Meter - Form 5S
8T Socket, Test Switch #TS07-0105

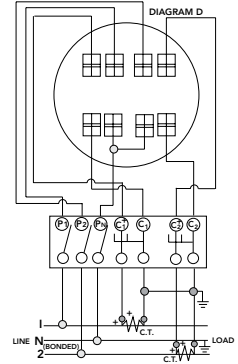

DIAGRAM E
3∅3W "A" with 2 P.T.'s & 2 C.T.'s
2 Stator Meter - Form 5S
8T Socket, Test Switch #TS07-0105

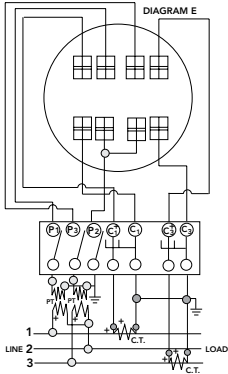

DIAGRAM F
3∅3W "A" with 2 C.T.'s
2 Stator Meter - Form 5S
8T Socket, Test Switch #TS07-0105

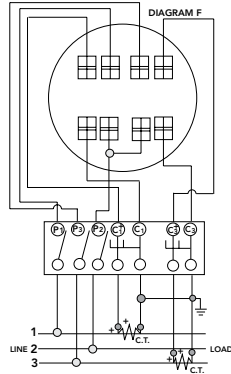

DIAGRAM G
3∅4W "Y" with 3 C.T.'s
2 1/2 Stator Meter - Form 6S
13T Socket, Test Switch #TS10-0109

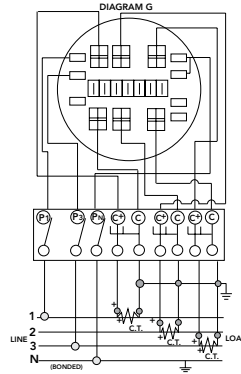

DIAGRAM H
3∅4W "Y" with 2 P.T.'s & 3 C.T.'s
2 1/2 Stator Meter - Form 6S
13T Socket, Test Switch #TS10-0109

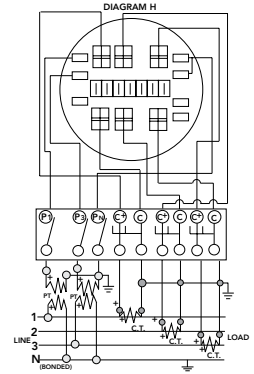

DIAGRAM I
3∅4W "Y" or "A" with 3 C.T.'s
"Y" 3 Stator Meter - Form 9S
"A" 2 Stator Meter - Form 8S
13T Socket, Test Switch #TS10-0109

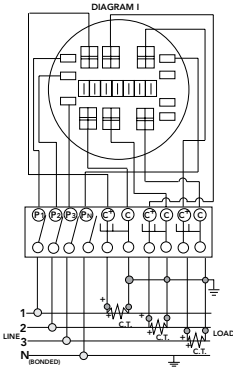
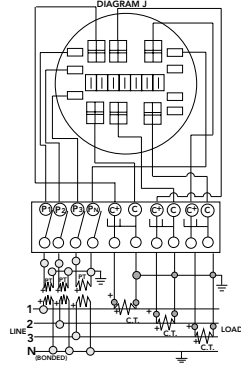

DIAGRAM J
3∅4W "Y" with 3 P.T.'s & 3 C.T.'s
3 Stator Meter - Form 9S
13T Socket, Test Switch #TS10-0109



Prewiring: If standard factory prewiring is required, refer to wiring diagrams on this page. Determine appropriate diagram and send a copy with order. If custom factory prewiring is required, specify on order. Be sure to include meter socket catalog number, test switch make and catalog number, meter form number and provide a copy of your wiring diagram.

Conduit, Ampacity & SCCR

Reference Information

MAXIMUM NUMBER OF CONDUCTORS IN CONDUIT

Table from 2008 NEC Code Reference: Rigid Metal Conduit

Type	Conductor Size (AWG/kcmil)	Conduit Trade Sizes (Inches)									
		½	¾	1	1¼	1½	2	2½	3	3½	4
THHN, THWN, THWN-2	12	9	16	26	46	62	102	146	225	301	387
	10	6	10	17	29	39	64	92	142	189	244
	8	3	6	9	16	22	37	53	82	109	140
	6	2	4	4	12	16	27	38	59	79	101
	4	1	2	4	7	10	16	23	36	48	62
	3	1	1	3	6	8	14	20	31	41	53
	2	1	1	3	5	7	11	19	26	34	44
	1	1	1	1	4	5	8	12	19	25	35
	1/0	1	1	1	3	4	7	10	16	21	27
	2/0	0	1	1	2	3	6	8	13	18	23
3/0	0	1	1	1	3	5	7	11	15	19	
4/0	0	1	1	1	2	4	6	9	12	16	
XHH, XHHW, XHHW-2	4	1	2	4	7	10	16	24	37	49	63
	2	1	1	3	5	7	12	17	26	35	45
	1/0	1	1	1	3	4	7	10	16	22	28
	2/0	0	1	1	2	3	6	9	13	18	23
	4/0	0	1	1	1	2	4	6	9	12	16
	250	0	0	1	1	1	3	5	7	10	13
	350	0	0	1	1	1	2	3	6	7	10
	500	0	0	0	1	1	1	2	4	5	7
750	0	0	0	0	1	1	1	3	4	5	

This table is for concentric stranded conductors only. For cables with compact conductors refer to NEC. Refer to latest NEC Code or Local Codes for updated requirements.

* ALLOWABLE AMPACITIES OF INSULATED COPPER & ** ALUMINUM CONDUCTORS (3W IN CONDUIT) 75°C (167°F)

*CU		AL or **Cu-Clad AL	
A	B	A	C
18	-	-	-
16	-	-	-
14	20†	-	-
12	25†	12	20†
10	35†	10	30†
8	50	8	40
6	65	6	50
4	85	4	65
3	100	3	75
2	115	2	90
1	130	1	100
1/0	150	1/0	120
2/0	175	2/0	135
3/0	200	3/0	155
4/0	230	4/0	180
250	255	250	205
300	285	300	230
350	310	350	250
400	335	400	270
500	380	500	310
600	420	600	340
700	460	700	375
750	475	750	385

A = Size: AWG/MCM
 *B = Ampere Rating for Insulation Types:
FEPW, RH, RHW, THW, THWN, XHHW, USE, 2W.
 **C = Ampere Rating for Insulation Types:
RH, RHW, THW, THWN, XHHW, USE
 (Per NEC table 310-16)

AMPACITY CORRECTION FACTORS

AMBIENT TEMP.°C	CORRECTION FACTOR	AMBIENT TEMP.°F
21 - 25	1.05	70 - 77
26 - 30	1.00	78 - 86
31 - 35	.94	87 - 95
36 - 40	.88	96 - 104
41 - 45	.82	105 - 113
46 - 50	.75	114 - 122
51 - 55	.67	123 - 131
56 - 60	.58	132 - 140
61 - 65	.33	141 - 158

Overall ampere ratings of U/L listed Milbank multiple position meter sockets are based on 2008 N.E.C. Handbook Article 220-84 and ANSI / UL-414 (except where restricted by line connector size.) These requirements provide for a diversity factor / demand factor being utilized in determining the overall (main bus / lug) rating of a gang socket. All Milbank U/L listed gang sockets meet or exceed these diversity factor/demand factor requirements. Standard overall ampacity ratings for U/L listed and non U/L listed gang sockets are as shown in the chart below. Ampere ratings of meter sockets are based on the meter socket being wired with 75° C insulated wire conductor, sized in accordance with Table 310-16 of the National Electric Code.

GANG SOCKET OVERALL AMPACITIES

NO. OF METER POSITIONS	100A / POS. AMPACITY	125A / POS. AMPACITY	150A / POS. AMPACITY	200A / POS. AMPACITY
2	200A	200A	200A	200A #
3	200A	225A	225A	270A
4	200A	250A	270A	360A
5	225A	285A	338A	450A
6	270A	330A	396A	528A

† Unless otherwise permitted elsewhere in the Code, the overcurrent protection for conductor types marked with an obelisk (†) shall not exceed 15 amps for 14 AWG, 20 amps for 12 AWG, and 30 amps for 10 AWG copper; or 15 amps for 12 AWG and 25 amps for 10 AWG aluminum and copper-clad aluminum after any correction factors for ambient temperature and number of conductors have been applied.

Some constructions are rated at 400 amps overall. Contact your sales representative for more information. Refer to latest NEC Code or Local Codes for updated requirements.

Please consult serving utility for their requirements prior to ordering or installing, as specifications and approvals vary by utility, and may require local electrical inspector approval. All installations must be installed by a licensed electrician and must comply with all national and local codes, laws and regulations. Milbank reserves the right to make changes in specifications and features shown without notice or obligation.



MILBANK
ENERGY AT WORK

Important Note

In addition to national and local electrical codes, many utilities have specific requirements for metering equipment. Always consult the serving utility for their specifications and requirements prior to ordering or installing Milbank meter mounting equipment.

Before Energizing

1. Give equipment a thorough visual examination to determine that:
 - A. No shipping or installation damage exists.
 - B. Proper clearances have been maintained.
 - C. All connections have been made.
 - D. Equipment is clean and dry.
2. Make a thorough examination to:
 - A. Verify tightness of all bolted connections (see table below).
 - B. Manually operate all circuit breakers, switches, relays, etc.
 - C. Check rigidity of all mountings, bus bars and components.
 - D. Use test equipment to check continuity of circuitry and integrity of insulation.
3. All switches and circuit breakers should be in the "off" position.
4. Verify that manual meter bypass (if applicable) is in non-bypass position.
5. Install cover and/or close doors.
6. If installation is not being energized at this time, follow "after-energizing" steps listed below. These steps will secure the installation in case of accidental energization.

When Energizing

Use caution and follow established safety procedures:

- 1) Wear safety apparel.
- 2) Use safety equipment.
- 3) Take action to prevent injury to yourself and others in the event of failure of the installation.
- 4) Take action to prevent/decrease damage to property in the event of failure of the installation.
- 5) If you are unsure how to safely energize the installation, get someone who is knowledgeable to do it.

After Energizing

Secure the installation:

- 1) To prevent accidental contact with energized parts, cover all openings with approved filler devices.
- 2) To prevent unauthorized access, secure all covers and/or doors with approved security devices.
- 3) Attach/post information to advise others of potential hazards associated with the installation.

Recommended Torque for General Applications*

Nominal Size	Joint Description		Head Type	Torque (Inch Lbs.)
	Screw	Nut		
10	Brass	Brass Nut or Extruded Hole	All	20-25 inch lbs.
10	Steel	Copper or Aluminum Busbar $\leq 1/8"$	All	25-30 inch lbs.
10	Steel	Steel Nut or Extruded Hole; CU or AL Busbar $> 1/8"$	All	30-35 inch lbs.
12	Steel	Aluminum Extruded Hole	All	30-35 inch lbs.
12	Steel	Steel Nut or Extruded Hole	All	40-50 inch lbs.
1/4	Steel	Aluminum Extruded Hole	All	40-50 inch lbs.
1/4	Steel	Steel Nut or Extruded Hole; CU or AL Busbar	All	50-60 inch lbs.
5/16	Steel	Aluminum Extruded Hole	Hex	60-70 inch lbs.
5/16	Steel	Steel Nut or Extruded Hole; CU or AL Busbar	Hex	100-150 inch lbs.
3/8	Steel	Steel Nut	Hex	150-200 inch lbs.
1/2	Steel	Steel Nut	Hex	200-250 inch lbs.

* Interior labels typically indicate the required torque for wire connectors and studs, and should be referenced first.
CU: Copper
AL: Aluminum



Please consult serving utility for their requirements prior to ordering or installing, as specifications and approvals vary by utility, and may require local electrical inspector approval. All installations must be installed by a licensed electrician and must comply with all national and local codes, laws and regulations. Milbank reserves the right to make changes in specifications and features shown without notice or obligation.

Materials & Finishes

Reference Information

Materials

Steel Quality

The meter equipment listed in this catalog is made of galvanized steel (AISI* G90) to afford the best possible weather proofing.
*American Iron and Steel Institute.

Steel Sheet

16 gauge, galvanized, sheet: 1 1/4 oz./ sq.ft. class zinc-coated. (AISI G90)
14 gauge, galvanized, sheet: 1 1/4 oz./ sq.ft. class zinc-coated.

Aluminum Extrusion

Wire-Terminals: Alloy; 6061-T6, Tin-plated for CU/AL wire.
Bus Bar: Alloy; 6101-O & 6063-O

Aluminum Sheet

3000 series aluminum sheet, H14, or 5052 series aluminum sheet, H32. Where applicable thicknesses range from .064-.125

Copper Sheet & Bus

Electrolytic copper with tin plating in most applications.

Insulating Materials

- In most units, support bases for current-carrying components are molded from fiberglass reinforced high-strength, track resistant, thermoset polyester molding compounds.
- Clear or black safety shields and polarity barriers are molded from high-strength, track resistant, polycarbonate molding compounds.
- Various sheet insulating materials, as appropriate for the application are utilized in the fabrication of flat, formed and punched component parts and barriers.

Finish

Process

Light gray state-of-the-art electrostatically applied powder paint offers a durable, non-fading finish. For further information concerning the chemical analysis of the weather resistant finish, please contact the factory.

Metal Fasteners

Zinc-coated with a chromate dip.

Ratings & Compliance

Ratings & Compliance

All Milbank electrical enclosures in this catalog are rated "Type 3R Enclosure" unless specified otherwise on the product's page. All enclosures with a UL designation are constructed per the appropriate UL Standard and may be installed per the National Electric Code. UL procedure files associated with the UL Standards are listed as follows: Meter Sockets (UL 414, File E30202), Test Switches (UL 414, File E62531), Power Outlets (UL 231, File E90945), Panelboards (UL 67, File E32628) and Pullout Switches (UL 1429, File E133062). Additional standards are utilized as applicable: Meter Sockets (ANSI C12.7), Test Switches (ANSI C12.9) and Panelboards (NEMA PB-1).

Please consult serving utility for their requirements prior to ordering or installing, as specifications and approvals vary by utility, and may require local electrical inspector approval. All installations must be installed by a licensed electrician and must comply with all national and local codes, laws and regulations. Milbank reserves the right to make changes in specifications and features shown without notice or obligation.



850.....	53	Q135.....	51	TS04-0101.....	42
6002.....	53	Q135H.....	51	TS04-0102.....	42
6003.....	53	Q140.....	51	TS04-0103.....	42
6116.....	53	Q140H.....	51	TS04-0104.....	42
5T8K2.....	54	Q150.....	51	TS07-0018.....	42
A7514.....	52	Q150H.....	51	TS07-0022.....	42
A7515.....	52	Q160.....	51	TS07-0049.....	42
A7516.....	52	Q160H.....	51	TS07-0059.....	42
A7517.....	52	Q170.....	51	TS07-0105.....	42
A7518.....	52	Q170H.....	51	TS07-0106.....	42
A7551.....	52	Q2100.....	51	TS07-0107.....	42
A8110.....	52	Q2100H.....	51	TS07-0108.....	42
A8111.....	52	Q2125.....	51	TS10-0109.....	42
A8112.....	52	Q2125H.....	51	TS10-0110.....	42
A9064.....	52	Q215.....	51	TS10-0111.....	42
BL7474.....	54	Q215H.....	51	TS10-0112.....	42
CP-21.....	53	Q220.....	51	U1252-X-K1.....	29
K1047.....	53	Q220H.....	51	U1253-X-K3.....	29
K1190.....	54	Q225.....	51	U1254-X-K3.....	29
K1190.....	54	Q225H.....	51	U1255-X-K4.....	29
K1350.....	36	Q230.....	51	U1256-X-K4.....	29
K1350.....	53	Q230H.....	51	U1780-O.....	26
K1350L.....	53	Q235.....	51	U1855-O-NE.....	43
K1539.....	36	Q235H.....	51	U1856-O-NE.....	43
K1539.....	53	Q240.....	51	U1980-O.....	12
K1540.....	36	Q240H.....	51	U2264-XL.....	26
K1540.....	53	Q250.....	51	U2272-RL-5T9-BL.....	13
K1540L.....	53	Q250H.....	51	U2288-X.....	37
K1541.....	36	Q260.....	51	U2448-X.....	18
K1541.....	53	Q260H.....	51	U2594-X.....	19
K3082.....	53	Q270.....	51	U2601-XL.....	28
K3083.....	53	Q270H.....	51	U2692-XL.....	26
K3356.....	54	Q280.....	51	U2693-XL.....	26
K3441.....	53	Q280H.....	51	U2732-XT.....	34
K3442.....	53	Q290.....	51	U2733-XT.....	34
K3865.....	54	Q290H.....	51	U2734-XT.....	34
K3866.....	54	QN2150.....	51	U2735-XT.....	34
K4527.....	54	QN2150H.....	51	U2736-XT.....	34
K4528.....	54	QN2150R.....	51	U2752-X-5T9.....	32
K4977-EXT.....	54	QN2150RH.....	51	U2753-X-5T9.....	32
K4977-INT.....	54	QN2200.....	51	U2754-X-5T9.....	32
K5022-INT.....	54	QN2200H.....	51	U2755-X-5T9.....	32
K5T.....	54	QN2200R.....	51	U2756-X-5T9.....	32
M5-144.....	53	QN2200RH.....	51	U2852-X.....	36
Q115.....	51	-R.....	52	U2852-X.....	37
Q115H.....	51	-RL.....	52	U2853-X.....	36
Q120.....	51	S1857.....	44	U2853-X.....	37
Q120H.....	51	S2718-FB-XL-C.....	45	U2854-X.....	36
Q125.....	51	S3176-O.....	46	U2854-X.....	37
Q125H.....	51	S3390-FB-XL-C7.....	45	U2855-X.....	36
Q130.....	51	S4098-O.....	46	U2855-X.....	37
Q130H.....	51	S8324.....	52	U2856-X.....	36



Please consult serving utility for their requirements prior to ordering or installing, as specifications and approvals vary by utility, and may require local electrical inspector approval. All installations must be installed by a licensed electrician and must comply with all national and local codes, laws and regulations. Milbank reserves the right to make changes in specifications and features shown without notice or obligation.

U2856-X.....	37	U4910-O-BL.....	17	UC7478-O-81-NOE.....	41
U2860-XL-5T9-QG.....	13	U4911-X-BL.....	19	UC7532-XL.....	40
U2862-X.....	36	U5101-XL-11GR*.....	49	UC7544-RL.....	39
U2862-X.....	37	U5112-X-5T9-BL.....	31	UC7545-RL.....	39
U2863-X.....	36	U5113-X-5T9-BL.....	31	UQFB-100.....	50
U2863-X.....	37	U5140-RXL-200-BL.....	21	UQFB-100-X1.....	50
U2864-X.....	36	U5168-XTL-100-BL-NE.....	22	UQFB-125.....	50
U2864-X.....	37	U5168-XTL-200-BL-NE.....	22	UQFB-125-X1.....	50
U2865-X.....	36	U5750-RXL-200-BL.....	23	UQFB-150.....	50
U2865-X.....	37	U5757-O-200.....	20	UQFB-150-X1.....	50
U2866-X.....	36	U5767-X-200-CB-BL.....	25	UQFB-175.....	50
U2866-X.....	37	U5777-O.....	12	UQFB-175-X1.....	50
U2872-XT-5T9.....	33	U5787-O-200-CB.....	25	UQFB-200.....	50
U2873-XT-5T9.....	33	U5796-X-400-CB-BL.....	25	UQFB-200-X1.....	50
U2874-XT-5T9.....	33	U5799-O-400-CB-BL.....	25	UQFBH-100.....	50
U2875-XT-5T9.....	33	U5871-XL-200-BL.....	23	UQFBH-125.....	50
U2876-XT-5T9.....	33	U5898-O-200-BL.....	22	UQFBH-150.....	50
U3499-XL-100.....	20	U5934-XL-BLG.....	9	UQFBH-175.....	50
U3727-O.....	47	U6123-X-BL.....	35	UQFBH-200.....	50
U3730-O.....	47	U6124-X-BL.....	35	UQFBH-M-100.....	50
U3741-XL-100-BL.....	21	U6125-X-BL.....	35	UQFBH-M-125.....	50
U3763-XL.....	30	U7021-RL-TG.....	11	UQFBH-M-150.....	50
U3764-XL.....	30	U7040-O-TG.....	11	UQFBH-M-175.....	50
U3765-XL.....	30	U7040-XL-TG.....	11	UQFBH-M-200.....	50
U3771-XL-100-BL.....	23	U7362-DL.....	27	UQFP-100.....	50
U3784-RL.....	22	U7363-DL.....	27	UQFP-125.....	50
U3791N-RXL-200-BL.....	21	U7364-DL.....	27	UQFP-150.....	50
U3798-O-200.....	20	U7365-DL.....	27	UQFP-175.....	50
U3802.....	6	U7366-DL.....	27	UQFP-200.....	50
U3812.....	6	U7487-O-TG.....	10	UQFPH-100.....	50
U3822-20GWR.....	7	U7487-RL-TG.....	10	UQFPH-125.....	50
U3832.....	6	U7487-YL-TG.....	10	UQFPH-150.....	50
U3862.....	6	U7573-RL.....	13	UQFPH-175.....	50
U3924-XL.....	14	U8212-XL.....	28	UQFPH-200.....	50
U3989-XL-100.....	20	U8213-XL.....	28	UQFPH-M-100.....	50
U3990-XL-150.....	20	U8214-XL.....	28	UQFPH-M-125.....	50
U3990-XL-200.....	20	U8215-XL.....	28	UQFPH-M-150.....	50
U3995-XL-200.....	23	U8216-XL.....	28	UQFPH-M-175.....	50
U4031-O-2/200.....	24	U9318-RL.....	15	UQFPH-M-200.....	50
U4322-O-BL.....	48	U9319-XL.....	15	UQFP-M-100.....	50
U4323-O-BL.....	48	U9550-RRL-QG.....	16	UQFP-M-125.....	50
U4372-XT-5T9.....	38	U9551-RXL-QG.....	16	UQFP-M-150.....	50
U4373-XT-5T9.....	38	U9700-RRL-QG-BL.....	17	UQFP-M-175.....	50
U4374-XT-5T9.....	38	U9701-RXL-QG.....	17	UQFP-M-200.....	50
U4375-XT-5T9.....	38	U9800-RRL-QG-BL-NE.....	14	WBJ2150.....	51
U4376-XT-5T9.....	38	U9801-RXL-QG.....	14	WBJ2200.....	51
U4413-O-BL.....	12	UC1299-XL.....	39	Z802965-AC.....	54
U4611-X.....	19	UC4964-O-WC-21-NST.....	41	Z814898-AC.....	54
U4721-O-BL.....	14	UC4965-O-WC-21-NST.....	41	Z901925-AC.....	54
U4778-X-BL.....	18	UC4966-O-WC-21-NST.....	41	Z904486-AO.....	54
U4835-X-2/200-BL.....	24	UC7444-O-141-NOE.....	41	Z916264-AO.....	54
U4881-O-50GB.....	8	UC7445-O-311-NOE.....	41	Z916265-AO.....	54
U4881-O-60GB.....	8	UC7448-XL.....	40		
U4908-O-11GR*.....	49	UC7449-XL.....	40		

Please consult serving utility for their requirements prior to ordering or installing, as specifications and approvals vary by utility, and may require local electrical inspector approval. All installations must be installed by a licensed electrician and must comply with all national and local codes, laws and regulations. Milbank reserves the right to make changes in specifications and features shown without notice or obligation.



MILBANK
ENERGY AT WORK

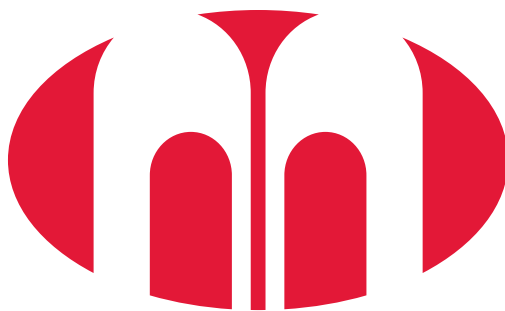

MILBANK®

ENERGY AT WORK

HOLBROOK-ASSOCIATED

Electrical Manufacturer's Representatives

35 Reservoir Park Drive, Rockland, MA 02370

p: 781.871.0011

1.800.322.9641 (*New England Area Only*)

f: 781.871.2956

holbrook-associated.com





MILBANK[®]
ENERGY AT WORK



New England

Area Catalog



Milbank designs and manufactures electrical solutions that move and manage power for the residential, commercial, industrial, utility and transportation sectors. With 90 years of expertise in electrical engineering design and manufacturing, Milbank's portfolio includes metering equipment, enclosures and enclosed controls. Founded in 1927, Milbank is a family-owned, American manufacturer headquartered in Kansas City, Mo. For more information, please visit milbankworks.com.

METERING



As a market leader in electrical metering equipment, Milbank has set the standard for quality since 1927. Hundreds of configurations are available, including many sizes, knockout configurations, terminal configurations, bypass options, hubs, locks and connectors. Milbank has the socket you need with thousands of active products to meet your utility's requirements.

ENCLOSURES



Milbank's line of enclosures include commercial junction boxes, panel mount enclosures, transformer cabinets, wireway, trough and industrial panel mount and push-button enclosures. Built with high-quality craftsmanship and materials which meet or exceed industry standards, Milbank enclosures are made to protect controls and equipment from dust, dirt and other harmful elements found in a wide variety of environments.

ENCLOSED CONTROLS



Milbank doesn't just build empty enclosures. We can deliver the entire package, complete with custom control equipment built to your exact specifications by our engineers. Milbank commercial pedestals are an attractive, secure, easy to install and cost-effective solution when underground remote site power distribution and control equipment is required, replacing unsightly and inefficient strut and backboard structures.



Please consult serving utility for their requirements prior to ordering or installing, as specifications and approvals vary by utility, and may require local electrical inspector approval. All installations must be installed by a licensed electrician and must comply with all national and local codes, laws and regulations. Milbank reserves the right to make changes in specifications and features shown without notice or obligation.

Air Conditioner Disconnects

30 & 60 amp AC disconnects	6
60 amp AC disconnect with 20 amp GFCI receptacle	7
Hot tub disconnects	8

Single Position Sockets

100 amps, 4 terminals, ringless, solar	9
125-200 amps, 4 terminals, ringless	10-12
125 amps, 5 & 7 terminals, medium duty lever bypass, ringless	13
200 amps, 5 terminals, medium duty lever bypass, ringless	14
200 amps, 4 terminals, heavy duty lever bypass, ringless	15
200 amps, 5 & 7 terminals, heavy duty lever bypass, ringless	16-17
320 amps, 4,5 & 7 terminals, heavy duty lever bypass, ringless	18-19

Meter Mains

100-200 amps, 4 terminals, ringless	20
100-200 amps, 4 terminals, lever bypass, ringless	21
100-200 amps, 4 terminals, meter main with load center, ringless	22
100-200 amps, 7 terminals, lever bypass, ringless	23
320 amps, 4 terminals, lever bypass, ringless	24
Cold Sequence, 200 & 400 amps, 7 terminals, lever bypass, ringless	25

Multi-Position

100 amps, 4 terminals, ringless & ring type, vertical	26
100 amps, 4 terminals, ringless	27-28
200 amps, 4 terminals, ringless	29
125 amps, 4 terminals, with single position lever bypass, ringless	30
100 amps, 5 terminals, lever bypass, ringless, vertical	31
100-200 amps, 5 terminals, lever bypass, ringless	32-33
200 amps, 7 terminals, lever bypass, ringless	34

Multi-Position Meter Mains

125 amps, 4 terminals, with single position lever, ringless	35
125 & 200 amps, 4 terminals, ringless	36-37
200 amps, 5 terminals, lever bypass, ringless	38

Please consult serving utility for their requirements prior to ordering or installing, as specifications and approvals vary by utility, and may require local electrical inspector approval. All installations must be installed by a licensed electrician and must comply with all national and local codes, laws and regulations. Milbank reserves the right to make changes in specifications and features shown without notice or obligation.



Transformer Rated

20 amps, 6 -13 terminals, plunger bypass, ringless	39
20 amps, 6 -13 terminals, test switch provision, ringless	40
20 amps, 6 -13 terminals, pre-wired, ringless	41
Test switches, test switch work sheet	42
CT Cabinets	43-44

Polyphase Enclosures

A base enclosures	45
-------------------------	----

Pedestals

Meter pedestal for pad mounting	46
200 amps, 4 terminal, direct bury	47
200 amps, 4 terminal, lever bypass, direct bury	48

Temp Power Units

125, 4 terminal, ringless	49
---------------------------------	----

Parts & Accessories

Circuit breakers and accessories	50-54
--	-------

Miscellaneous

Commercial pedestals	55-64
Reference information	65-69
Index	70



Please consult serving utility for their requirements prior to ordering or installing, as specifications and approvals vary by utility, and may require local electrical inspector approval. All installations must be installed by a licensed electrician and must comply with all national and local codes, laws and regulations. Milbank reserves the right to make changes in specifications and features shown without notice or obligation.

Catalog Number Logic

How our product catalog numbers are derived

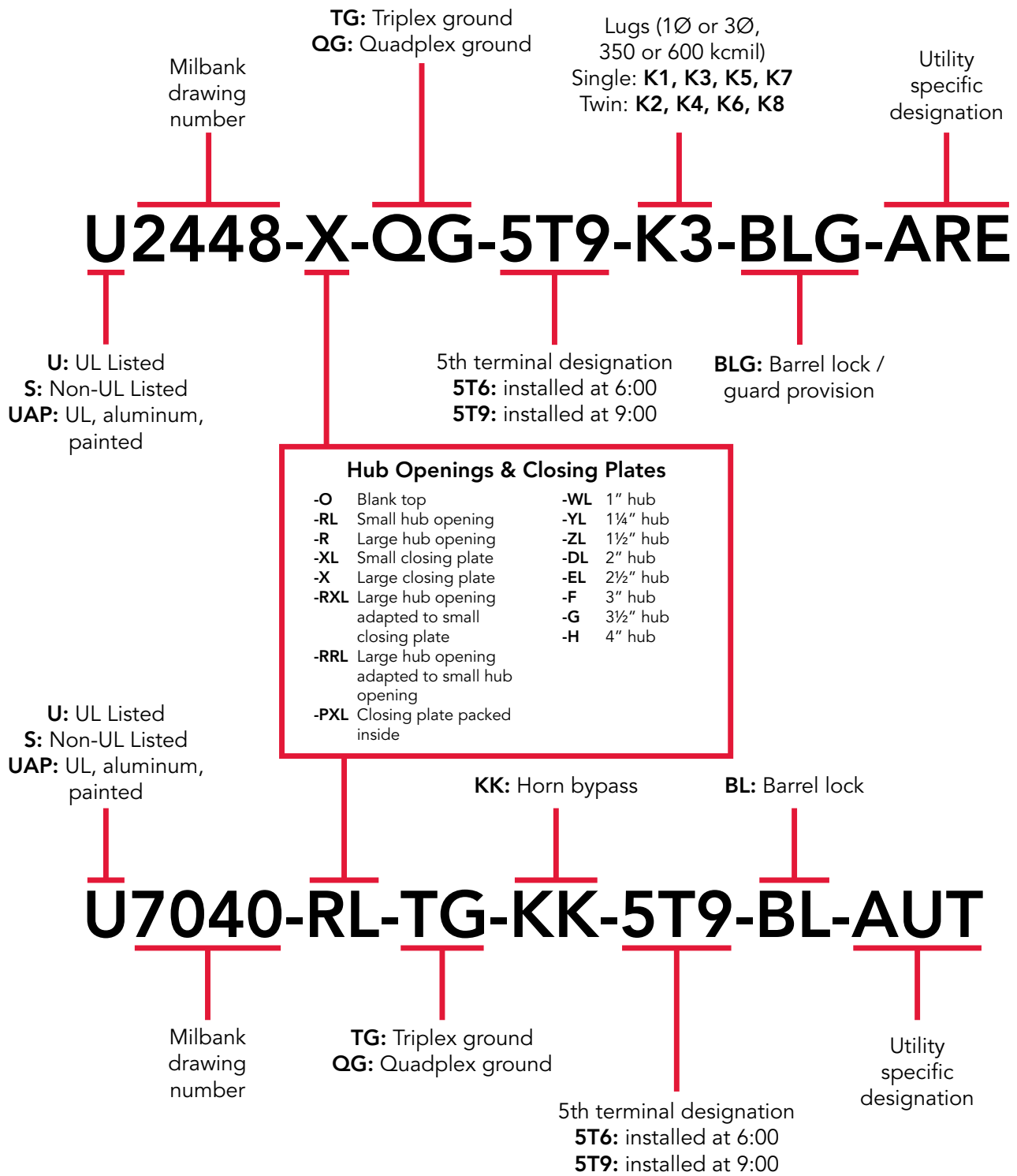

Please consult serving utility for their requirements prior to ordering or installing, as specifications and approvals vary by utility, and may require local electrical inspector approval. All installations must be installed by a licensed electrician and must comply with all national and local codes, laws and regulations. Milbank reserves the right to make changes in specifications and features shown without notice or obligation.



Air Conditioner Disconnects

30 & 60 Amps | Fusible & Non-Fusible



U3802



U3812



U3832

Milbank's air conditioner disconnect has a removable hinged cover for ease of installation. Our compact design meets NEC wiring space requirements and also complies with NEC article 440-14. For safe working conditions, our disconnect pullers may be removed and reinstalled in the OFF position. Additionally, padlock provisions are included on the front cover. As with other Milbank products, our enclosure is constructed of G90U galvanized steel and electrostatically finished with an attractive, light gray, baked powder coating. Our epoxy/polyester resin blend offers a finish that is both durable and fade-resistant.

30–60 Amps | 1Ø 240 VAC | Air Conditioner Disconnects

Catalog Number	Amps	Type	Max H.P.	Weight (lbs.)	Line/Load Wire Range		Ground Wire Range CU/AL	Dimensions			Wire Rating	
					CU	AL		D"	W"	H"	CU °C	AL °C
U3802	60	Non-Fusible	10	3.25	#14-#2	#12-#2	#14-4	2½	5	7½	60°/75°	60°/75°
U3812	60	Non-Auto	10	3.25	#14-#2	#12-#2	#14-4	2½	5	7½	60°/75°	60°/75°
U3832	30	Fusible	3	2.5	#14-#3	#14-#3	#14-3	2½	5	7	60°/75°	60°/75°
U3862	60	Fusible	10	3.3	#14-#3	#14-#3	#14-3	2½	5	9	60°/75°	60°/75°

Notes

- UL listed as Enclosed Pullout Switch
- Type 3R rainproof
- One-inch concentric knockouts



Please consult serving utility for their requirements prior to ordering or installing, as specifications and approvals vary by utility, and may require local electrical inspector approval. All installations must be installed by a licensed electrician and must comply with all national and local codes, laws and regulations. Milbank reserves the right to make changes in specifications and features shown without notice or obligation.

Air Conditioner Disconnects

60 Amps | With 20 Amp GFCI Receptacle



U3822-20GWR

Specifications

- Meets NEC #210.63 requirements
- UL listed as Power Outlet
- Type 3R enclosure
- In-use cover*
- Duplex ground connector
- 1" concentric knockouts
- 1Ø, 240 volt
- 60 amp, non-fused
- 20 amp GFCI receptacle
- Reset/test button
- Weather and tamper resistant
- Meets NEC #406.8 requirements

60 Amps | 1Ø, 240 VAC | Air Conditioner Disconnect with GFCI Receptacle

Catalog Number	Type	Max H.P.	Weight (lbs.)	Line/Load Wire Range		Ground Wire Range CU/AL	Dimensions			Wire Rating	
				CU	AL		D"	W"	H"	CU °C	AL °C
U3822-20GWR	Non-Fusible	10	6	#14-#2	#12-#2	#14-4	4½	5¼	7½	60°/75°	60°/75°

Notes

- **Disconnect Pullouts:** To ensure the safest conditions, Milbank disconnect pullouts are reversible so they may be reinstalled in the OFF position.
- **Padlock Provision:** All units are designed with a padlock provision on the cover for security.
- ***In-Use Cover:** Cover is rated as an in-use cover (cover may be closed with cords plugged into receptacle).

Please consult serving utility for their requirements prior to ordering or installing, as specifications and approvals vary by utility, and may require local electrical inspector approval. All installations must be installed by a licensed electrician and must comply with all national and local codes, laws and regulations. Milbank reserves the right to make changes in specifications and features shown without notice or obligation.



Hot Tub Disconnects

Type 3R Enclosures



U4881-O-50GB



U4881-O-60GB

Specifications

- 240 volt ground fault protection
- UL listed, Type 3R rainproof
- 2-pole, 50 or 60 amp GFCI breaker protection
- Compact size
- Three or four wire installation
- 1Ø, 120/240 VAC
- Standard package of 12
- Two extra one-pole breaker spaces
- 100 amp overall rating
- Easy to install

100 Amps | Hot Tub Disconnect or Sub Panel Breaker Enclosure | Type 3R

Catalog Number	Breaker Amps	Type	Weight (lbs.)	Line/Load Wire Range		Ground Wire Range CU/AL	Dimensions		
				CU	AL		D"	W"	H"
U4881-O-50GB	50	Breaker	8	#14-1/0	#14-1/0	#14-1/0	3¾	7½	8½
U4881-O-60GB	60	Breaker	8	#14-1/0	#14-1/0	#14-1/0	3¾	7½	8½



Please consult serving utility for their requirements prior to ordering or installing, as specifications and approvals vary by utility, and may require local electrical inspector approval. All installations must be installed by a licensed electrician and must comply with all national and local codes, laws and regulations. Milbank reserves the right to make changes in specifications and features shown without notice or obligation.

Single Position Sockets

100 Amps | 4 Terminals | Ringless | 600 VAC

9
100 AMP
SINGLE
POSITION
SOCKETS

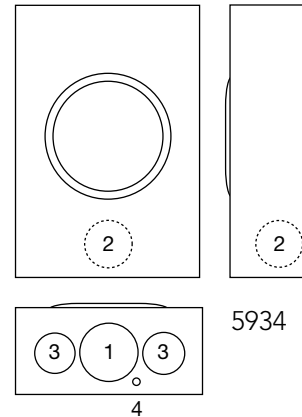

U5934-XL-BLG

100 Amps | 4 Terminals | Ringless | Single Position | 1Ø3W

Catalog Number	Service	Hub	Connectors CU/AL		Bypass	Dimensions			Knockouts			
			Line	Load		D"	W"	H"	1	2	3	4
U5934-XL-BLG	OH/UG	C.P.	#12-1/0	#12-1/0	None	3 ⁵ / ₁₆	8	11 ¹ / ₂	2	1 ¹ / ₂	1 ¹ / ₄	1 ¹ / ₄

Notes

- **Hubs:** Accepts standard meter socket hubs.
- **Construction:** Units are Type 3R for durable outdoor use, lockable and sealable.
- **Connectors:** Connectors will accept #14-1/0 conductors.
- To isolate neutral remove bonding screw.

Please consult serving utility for their requirements prior to ordering or installing, as specifications and approvals vary by utility, and may require local electrical inspector approval. All installations must be installed by a licensed electrician and must comply with all national and local codes, laws and regulations. Milbank reserves the right to make changes in specifications and features shown without notice or obligation.



Single Position Sockets

125 Amps | 4 Terminals | Ringless | 600 VAC



U7487-O-TG

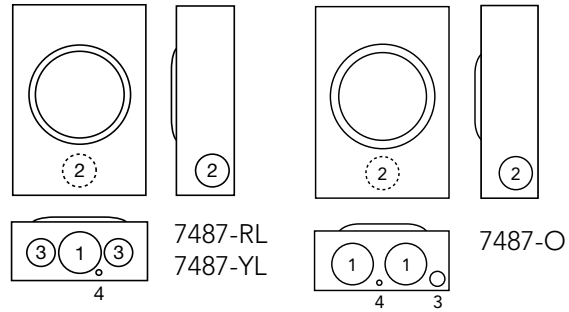

125 Amps | 4 Terminals | Ringless | Single Position | 1Ø3W

Catalog Number	Service	Hub	Connectors CU/AL		Bypass	Dimensions			Knockouts			
			Line	Load		D"	W"	H"	1	2	3	4
U7487-YL-TG	OH	1¼	#6-2/0	#6-2/0	None	3⅞	8	11½	2	1½	1¼	¼
U7487-RL-TG	OH/UG	H.O.	#6-2/0	#6-2/0	None	3⅞	8	11½	2	1½	1¼	¼
U7487-O-TG	UG	Blank	#6-2/0	#6-2/0	None	3⅞	8	11½	2	1½	¼, ½	¼

Notes

- **Hubs:** For proper hub selection, see the hub suffix chart on the Accessories page.
- **Fifth Terminal:** For field-installed fifth terminal, order catalog number **5T8K2**.
- **Connectors:** Extruded aluminum connectors are tin plated.
- **Ground:** Units are supplied with a triplex ground (-TG).



Please consult serving utility for their requirements prior to ordering or installing, as specifications and approvals vary by utility, and may require local electrical inspector approval. All installations must be installed by a licensed electrician and must comply with all national and local codes, laws and regulations. Milbank reserves the right to make changes in specifications and features shown without notice or obligation.

Single Position Sockets

200 Amps | 4 Terminals | Ringless | 600 VAC

1 1
200 AMP
SINGLE
POSITION
SOCKETS

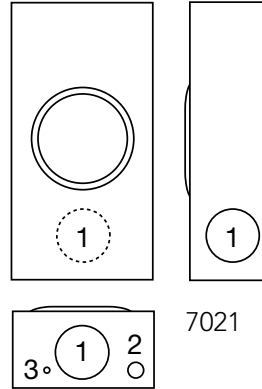

U7021-RL-TG

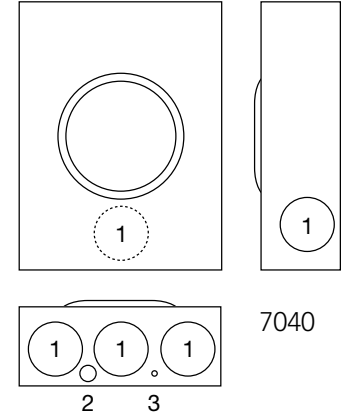

U7040-O-TG

200 Amps | 4 Terminals | Ringless | Single Position | 1Ø3W

Catalog Number	Service	Hub	Connectors CU/AL	Bypass	Dimensions			Knockouts			
					D"	W"	H"	1	2	3	4
U7021-RL-TG	OH	H.O.	#6-350	None	4 $\frac{1}{8}$	8	15 $\frac{1}{2}$	2 $\frac{1}{2}$	1 $\frac{1}{4}$, 1 $\frac{1}{2}$	1 $\frac{1}{4}$	—
U7040-XL-TG	OH/UG	C.P.	#6-350	None	4 $\frac{1}{8}$	11	15 $\frac{1}{2}$	2 $\frac{1}{2}$	1 $\frac{1}{4}$, 1 $\frac{1}{2}$	1 $\frac{1}{4}$	—
U7040-O-TG	UG	Blank	#6-350	None	4 $\frac{1}{8}$	11	15 $\frac{1}{2}$	2 $\frac{1}{2}$	1 $\frac{1}{4}$, 1 $\frac{1}{2}$	1 $\frac{1}{4}$	—

Notes

- **Hubs:** For proper hub selection, see the hub suffix chart on the Accessories page.
- **Fifth Terminal:** For field installed fifth terminal, order **K5T**.
- **Ground:** Units supplied with triplex ground.
- **Connectors:** Extruded aluminum connectors are tin plated.

Please consult serving utility for their requirements prior to ordering or installing, as specifications and approvals vary by utility, and may require local electrical inspector approval. All installations must be installed by a licensed electrician and must comply with all national and local codes, laws and regulations. Milbank reserves the right to make changes in specifications and features shown without notice or obligation.



Single Position Sockets

200 Amps | 4 Terminals | Side Wireway | 600 VAC



U1980-O

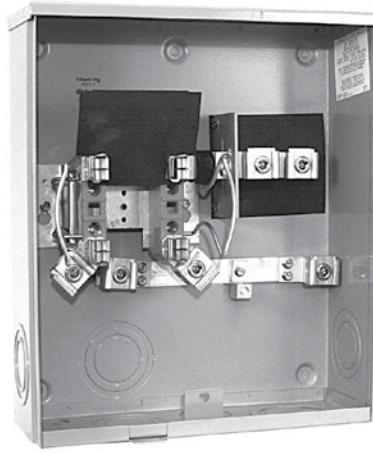

U4413-O-BL



U5777-O

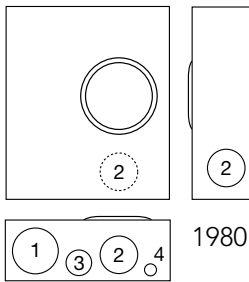

1980

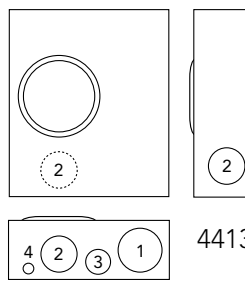

4413

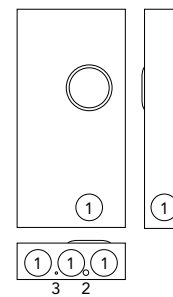

200 Amps | 4 Terminals | Ringless | Side Wireway | Single Position | 1Ø3W

Catalog Number	Service	Hub	Connectors CU/AL		Bypass	Dimensions			Knockouts			
			Line	Load		D"	W"	H"	1	2	3	4
U1980-O	UG	Blank	#6-350	#6-350	None	4½	10	18½	3	2½	¾	¼, ½
U4413-O-BL	UG	Blank	#6-350	#6-350	None	4½	10	18½	3	2½	¾	¼, ½
U5777-O	UG	Blank	¾-16 Studs	#2-350	None	4⅞	13	19	3	2½	¼, ½	¼

Notes

- **Hubs:** For proper hub selection, see the hub suffix chart on the Accessories page.
- **Connectors:** Extruded aluminum connectors are tin plated.
- **Ground:** Units supplied with triplex ground.
- **Fifth Terminal:** For field installed fifth terminal, order **K5T**.



Please consult serving utility for their requirements prior to ordering or installing, as specifications and approvals vary by utility, and may require local electrical inspector approval. All installations must be installed by a licensed electrician and must comply with all national and local codes, laws and regulations. Milbank reserves the right to make changes in specifications and features shown without notice or obligation.

Lever Bypass Single Position

125 Amps | 5 & 7 Terminals | Ringless | 600 VAC

13
125 AMP
LEVER
BYPASS
SOCKETS

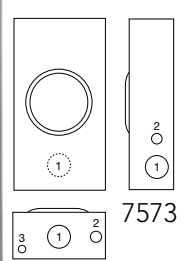
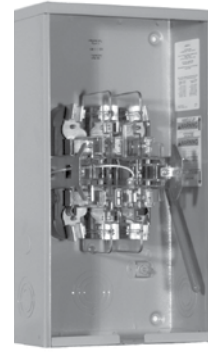
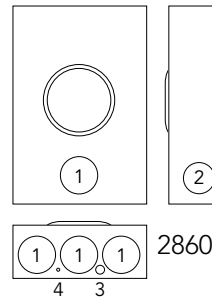
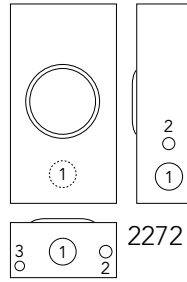

U2272-RL-5T9-BL

U2860-XL-5T9-QG

U7573-RL

125 Amps | 5 Terminals | Ringless | Lever Bypass | Single Position 1Ø3W

Catalog Number	Service	Hub	Connectors CU/AL		Bypass	Dimensions			Knockouts			
			Line	Load		D"	W"	H"	1	2	3	4
U2272-RL-5T9-BL	OH	H.O.	#6-2/0	#6-2/0	Lever	4 ⁷ / ₈	10	18 ¹ / ₂	2	3/4	1/4, 1/2	—
U2860-XL-5T9-QG	OH/UG	C.P.	#6-2/0	#6-2/0	Lever	4 ⁷ / ₈	13	19	3	2 ¹ / ₂	1/4, 1/2	1/4

Notes

- **Hubs:** For proper hub selection, see the hub suffix chart on the Accessories page.
- **Lever Bypass:** The lever operates bypass device only; it is **not jaw clamping**.
- **Connectors:** Extruded aluminum connectors are tin plated.
- **Fifth Terminal:** Factory installed in 9 o'clock position.

125 Amps | 7 Terminals | Ringless | Lever Bypass | Single Positions 3Ø4W

Catalog Number	Service	Hub	Connectors CU/AL		Bypass	Dimensions			Knockouts		
			Line	Load		D"	W"	H"	1	2	3
U7573-RL	OH	H.O.	#6-2/0	#6-2/0	Lever	4 ⁷ / ₈	10	18 ¹ / ₂	2	3/4	1/4, 1/2

Notes

- **Hubs:** For proper hub selection, see the hub suffix chart on the Accessories page.
- **Lever Bypass:** The lever operates bypass device only; it is not jaw clamping (medium duty).
- **Connectors:** Extruded aluminum connectors are tin plated.

Please consult serving utility for their requirements prior to ordering or installing, as specifications and approvals vary by utility, and may require local electrical inspector approval. All installations must be installed by a licensed electrician and must comply with all national and local codes, laws and regulations. Milbank reserves the right to make changes in specifications and features shown without notice or obligation.



Lever Bypass Single Position

200 Amps | 5 Terminals | Ringless | 600 VAC



U9318-RL

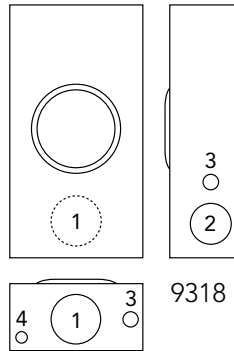

U9319-XL

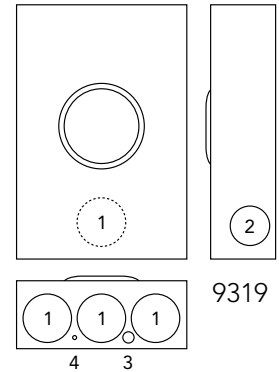

200 Amps | 5 Terminals | Ringless | Single Position | 1Ø3W

Catalog Number	Service	Hub	Connectors CU/AL	Bypass	Dimensions			Knockouts				
					D"	W"	H"	1	2	3	4	5
U9318-RL	OH	H.O.	#6-350	Lever	4 ⁷ / ₈	10	18 ¹ / ₂	3	2 ¹ / ₂	3/4	1/4, 1/2	—
U9319-XL	OH/UG	C.P.	#6-350	Lever	4 ⁷ / ₈	13	19	3	2 ¹ / ₂	1/4, 1/2	1/4	—

Notes

- **Hubs:** For proper hub selection, see the hub suffix chart on the Accessories page.
- **Lever Bypass:** The lever operates bypass device only; it is **not jaw clamping** (medium duty).
- **Connectors:** Extruded aluminum connectors are tin plated.



Please consult serving utility for their requirements prior to ordering or installing, as specifications and approvals vary by utility, and may require local electrical inspector approval. All installations must be installed by a licensed electrician and must comply with all national and local codes, laws and regulations. Milbank reserves the right to make changes in specifications and features shown without notice or obligation.

Lever Bypass Single Position

200 Amps | 4 Terminals | Ringless | 600 VAC

15
200 AMP
LEVER
BYPASS
SOCKETS



U9800-RRL-QG-BL-NE

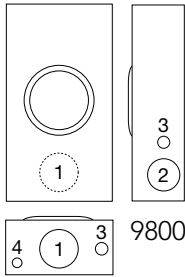

U9801-RXL-QG

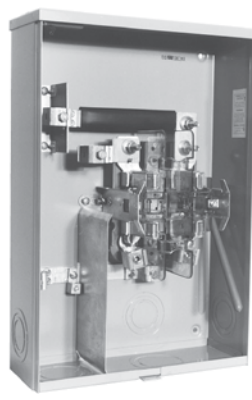
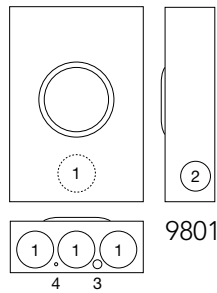

U3924-XL

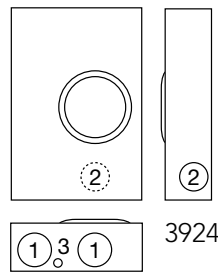

U4721-O-BL

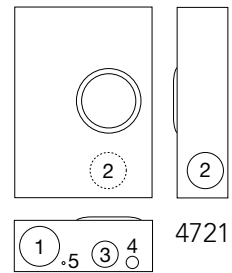

200 Amps | 4 Terminals | Ringless | Single Position | 1Ø3W

Catalog Number	Service	Hub	Connectors CU/AL	Bypass	Dimensions			Knockouts					
					D"	W"	H"	1	2	3	4	5	
U9800-RRL-QG-BL-NE	OH	H.O.	#6-350	Lever	4 $\frac{7}{8}$	10	18 $\frac{1}{2}$	3	2 $\frac{1}{2}$	$\frac{3}{4}$	$\frac{1}{4}, \frac{1}{2}$	—	—
U9801-RXL-QG	OH/UG	C.P.	#6-350	Lever	4 $\frac{7}{8}$	13	19	3	2 $\frac{1}{2}$	$\frac{1}{4}, \frac{1}{2}$	$\frac{1}{4}$	—	—
U3924-XL	UG	C.P.	#6-350	Lever	4 $\frac{7}{8}$	14	20 $\frac{1}{2}$	3	2 $\frac{1}{2}$	$\frac{1}{4}, \frac{1}{2}$	—	—	—
U4721-O-BL	UG	Blank	#6-350	Lever	5 $\frac{3}{4}$	16	22	4	3 $\frac{1}{2}$	2 $\frac{1}{2}$	1	$\frac{1}{4}$	—

Notes

- **Hubs:** For proper hub selection, see the hub suffix chart on the Accessories page.
- **Fifth Terminal:** For field installed fifth terminal, order as extra **K3866** for the **U9800**, **U9801**, **U4721**, and **K3865** for the **U3924**.
- **Bypass:** The lever supplies clamping action on meter spades and also operates bypass device.
- **Connectors:** Extruded aluminum connectors are tin plated.

Please consult serving utility for their requirements prior to ordering or installing, as specifications and approvals vary by utility, and may require local electrical inspector approval. All installations must be installed by a licensed electrician and must comply with all national and local codes, laws and regulations. Milbank reserves the right to make changes in specifications and features shown without notice or obligation.



Lever Bypass Single Position

200 Amps | 5 Terminals | Ringless | 600 VAC



U9550-RRL-QG

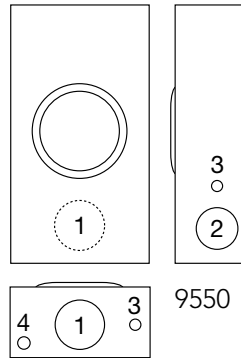

U9551-RXL-QG

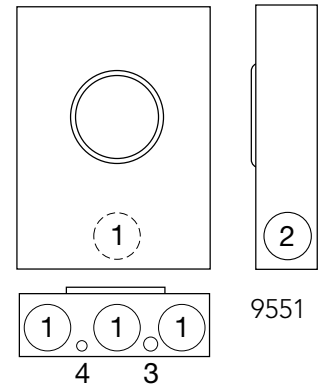

200 Amps | 5 Terminals | Ringless | Single Position | 1Ø3W or 3Ø3W

Catalog Number	Service	Hub	Connectors CU/AL	Bypass	Dimensions			Knockouts			
					D"	W"	H"	1	2	3	4
U9550-RRL-QG	OH	H.O.	#6-350	Lever	4 ⁷ / ₈	10	18 ¹ / ₂	3	2 ¹ / ₂	³ / ₄	¹ / ₄ , ¹ / ₂
U9551-RXL-QG	OH/UG	C.P.	#6-350	Lever	4 ⁷ / ₈	13	19	3	2 ¹ / ₂	¹ / ₄ , ¹ / ₂	¹ / ₄

Notes

- **Hubs:** For proper hub selection, see the hub suffix chart on the Accessories page.
- **Bypass:** The lever supplies clamping action on meter spades and also operates bypass device.
- **Connectors:** Extruded aluminum connectors are tin plated.



Please consult serving utility for their requirements prior to ordering or installing, as specifications and approvals vary by utility, and may require local electrical inspector approval. All installations must be installed by a licensed electrician and must comply with all national and local codes, laws and regulations. Milbank reserves the right to make changes in specifications and features shown without notice or obligation.

Lever Bypass Single Position

200 Amps | 7 Terminals | Ringless | 600 VAC

17
200 AMP
LEVER
BYPASS
SOCKETS



U9700-RRL-QG-BL

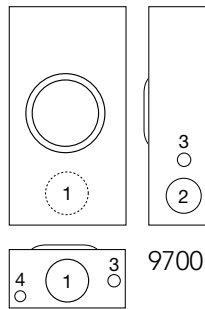

U9701-RXL-QG

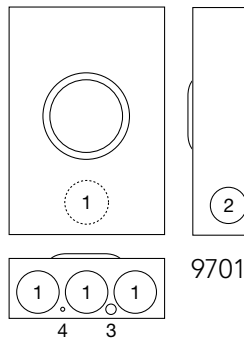

U4910-O-BL

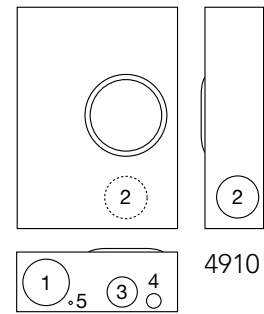

200 Amps | 7 Terminals | Ringless | Single Position | 3Ø4W

Catalog Number	Service	Hub	Connectors CU/AL	Bypass	Dimensions			Knockouts				
					D"	W"	H"	1	2	3	4	4
U9700-RRL-QG-BL	OH	H.O.	#6-350	Lever	4 ⁷ / ₈	10	18 ¹ / ₂	3	2 ¹ / ₂	³ / ₄	1 ¹ / ₄ , 1 ¹ / ₂	—
U9701-RXL-QG	OH/UG	C.P.	#6-350	Lever	4 ⁷ / ₈	13	19	3	2 ¹ / ₂	1 ¹ / ₄ , 1 ¹ / ₂	1 ¹ / ₄	—
U4910-O-BL	UG	Blank	#6-350	lever	5 ³ / ₄	16	22	4	3 ¹ / ₂	2 ¹ / ₂	1	1 ¹ / ₄

Notes

- **Hubs:** For proper hub selection, see the hub suffix chart on the Accessories page.
- **Bypass:** The lever supplies clamping action on meter spades and also operates bypass device.
- **Connectors:** Extruded aluminum connectors are tin plated.

Please consult serving utility for their requirements prior to ordering or installing, as specifications and approvals vary by utility, and may require local electrical inspector approval. All installations must be installed by a licensed electrician and must comply with all national and local codes, laws and regulations. Milbank reserves the right to make changes in specifications and features shown without notice or obligation.



Lever Bypass Single Position

320 Amps | 4 Terminals | Ringless | 600 VAC



U2448-X

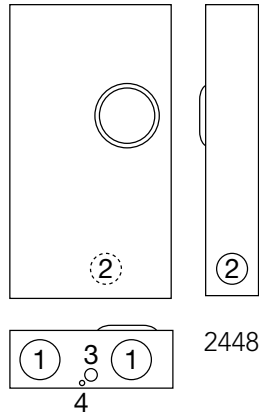

U4778-X-BL

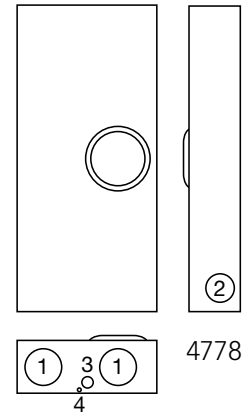

320 Amps | 4 Terminals | Ringless | Single Position | 1Ø3W

Catalog Number	Service	Hub	Connectors CU/AL	Bypass	Dimensions			Knockouts			
					D"	W"	H"	1	2	3	4
U2448-X	OH/UG	C.P.	3/8" x 16 Studs	Lever	6½	17¾	34⅞	4	3	1	¼
U4778-X-BL	OH/UG	C.P.	3/8" x 16 Studs	Lever	6½	17¾	38¾	4	3	1	¼

Notes

- **Hubs:** For proper hub selection, see the hub suffix chart on the Accessories page.
- **Bypass:** The lever supplies clamping action on meter spades and also operates bypass device.
- **Connectors:** Units are supplied with 3/8" x 16 hex nuts with Belleville washers. Order **K1540** (single, 600 kcmil) or **K1350** (twin, 350 kcmil). Order two kits to cover both line and load.
- **Fifth Terminal:** For field-installed fifth terminal, order **K3865** as extra.



Please consult serving utility for their requirements prior to ordering or installing, as specifications and approvals vary by utility, and may require local electrical inspector approval. All installations must be installed by a licensed electrician and must comply with all national and local codes, laws and regulations. Milbank reserves the right to make changes in specifications and features shown without notice or obligation.

Lever Bypass Single Position

320 Amps | 5 & 7 Terminals | Ringless | 600 VAC

19
320 AMP
LEVER
BYPASS
SOCKETS



320 Amps | 5 Terminals | Ringless | Single Position | 3Ø3W

Catalog Number	Service	Hub	Connectors CU/AL	Bypass	Dimensions			Knockouts			
					D"	W"	H"	1	2	3	4
U4611-X	OH/UG	C.P.	3/8" x 16 Studs	Lever	6½	17¾	31¼	4	1	¼	3

320 Amps | 7 Terminals | Ringless | Single Position | 3Ø4W

Catalog Number	Service	Hub	Connectors CU/AL	Bypass	Dimensions			Knockouts			
					D"	W"	H"	1	2	3	4
U4911-X-BL	OH/UG	C.P.	3/8" x 16 Studs	Lever	6½	17¾	38¾	4	3	1	¼
U2594-X	OH/UG	C.P.	3/8" x 16 Studs	Lever	6½	19¾	34½	4	3	1	¼

Notes

- **Hubs:** For proper hub selection, see the hub suffix chart on the Accessories page.
- **Bypass:** The lever supplies clamping action on meter spades and also operates bypass device.
- **Connectors:** Units are supplied with 3/8" x 16 hex nuts with Belleville washers. Order **K3441** (single, 600 kcmil) or **K3442** (twin, 350 kcmil). Order two kits to cover both line and load.

Please consult serving utility for their requirements prior to ordering or installing, as specifications and approvals vary by utility, and may require local electrical inspector approval. All installations must be installed by a licensed electrician and must comply with all national and local codes, laws and regulations. Milbank reserves the right to make changes in specifications and features shown without notice or obligation.





U3499-XL-100

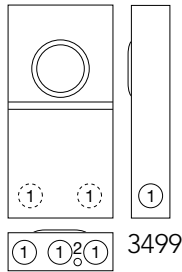

U3989-XL-100

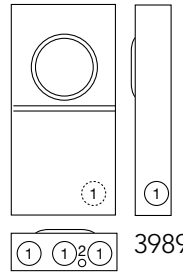

U3990-XL-150

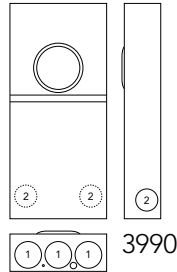

U3798-O-200

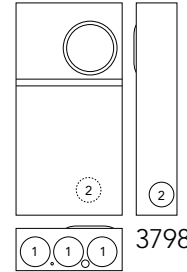

U5757-O-200

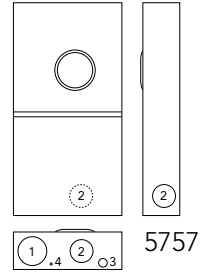

4 Terminals | Ringless | Meter Mains | 1Ø3W

Catalog Number	Service	Amps	Hub	Connectors CU/AL		Bypass	Dimensions			Knockouts			
				Line	Load		D"	W"	H"	1	2	3	4
U3499-XL-100	OH/UG	100	C.P.	#6-2/0	#6-1/0	None	3 ³ / ₄	11	22	2	1/4, 1/2	—	—
U3989-XL-100	OH/UG	100	C.P.	#6-2/0	#6-1/0	None	3 ³ / ₄	11	22	2	1/4, 1/2	—	—
U3990-XL-150	OH/UG	150	C.P.	#2-350	#1/0-300	None	4 ⁷ / ₈	13	29	3	2 1/2	1/4, 1/2	1/4
U3990-XL-200	OH/UG	200	C.P.	#2-350	#1/0-300	None	4 ⁷ / ₈	13	29	3	2 1/2	1/4, 1/2	1/4
U3798-O-200	UG	200	Blank	#2-350	#1/0-300	None	4 ⁷ / ₈	13	25 ¹³ / ₁₆	3	2 1/2	1/4, 1/2	1/4
U5757-O-200	UG	200	Blank	3/8"-16 Studs	#1/0-300	None	5 ³ / ₄	17 ³ / ₈	34	4	3	1	1/4

Notes

- **Hubs:** For proper hub selection, see the hub suffix chart on the Accessories page.
- **Circuit Breakers:** The **U3499-XL-100** has a factory-installed 100 amp breaker. The **U3990-XL-150** and **U3990-XL-200** have factory installed Milbank **UQFB-(AMP)-X1** breakers. The **U3798-O-200** has a factory-installed UQFB-200-X1 breaker. The **U3989-XL-100** is supplied with a 100 amp plug-in style breaker and has provisions for two 1-pole breakers.
- **Fifth Terminal:** For field-installed fifth terminal for **U3499** and **U3989**, order **5T8K2**. For **U3990** and **U3798**, order **K5T**. For **U5757**, order **K3865**.



Please consult serving utility for their requirements prior to ordering or installing, as specifications and approvals vary by utility, and may require local electrical inspector approval. All installations must be installed by a licensed electrician and must comply with all national and local codes, laws and regulations. Milbank reserves the right to make changes in specifications and features shown without notice or obligation.

Lever Bypass Meter Mains

100–200 Amps | 4 Terminals | Ringless | 120/240 VAC

21
100–200 AMP
LEVER BYPASS
METER MAINS

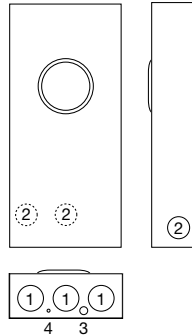
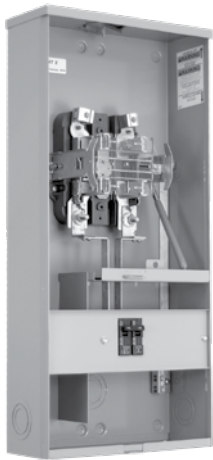

U3741-XL-100-BL

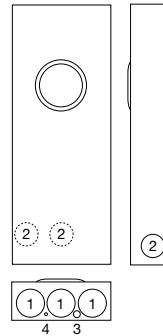
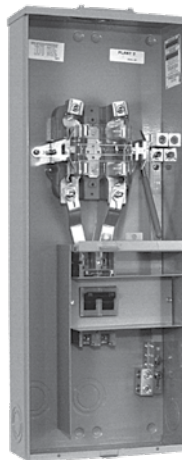

U3791N-RXL-200-BL

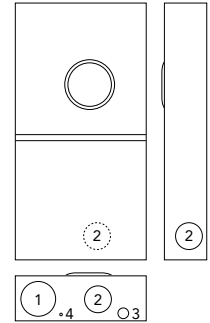

U5140-RXL-200-BL

4 Terminals | Ringless | Meter Mains | 1Ø3W

Catalog Number	Service	Amps	Hub	Connectors CU/AL		Bypass	Dimensions			Knockouts			
				Line	Load		D"	W"	H"	1	2	3	4
U3741-XL-100-BL	OH/UG	100	C.P.	#6-1/0	#6-1/0	Lever	4 ⁷ / ₈	13	28	2 ¹ / ₂	2	1 ¹ / ₄ , 1 ¹ / ₂	1 ¹ / ₄
U3791N-RXL-200-BL	OH/UG	200	C.P.	#6-350	#1/0-300	Lever	4 ⁷ / ₈	13	34	3	2 ¹ / ₂	1 ¹ / ₄ , 1 ¹ / ₂	1 ¹ / ₄
U5140-RXL-200-BL	OH/UG	200	C.P.	#6-350	#1/0-300	Lever	5 ³ / ₄	17 ³ / ₈	34	4	3	1	1 ¹ / ₄

Notes

- **Hubs:** For proper hub selection, see the hub suffix chart on the Accessories page.
- **Circuit Breakers:** The **U3741** is supplied with a factory-installed 2-pole, 100 amp plug-in breaker. The **U3791** unit is supplied with a factory installed Milbank **UQFB-200-X1** 2-pole, 200 amp bolt-in breaker.
- **Fifth Terminal:** For field-installed fifth terminal, order **K3866**. For a **3W network**, use fifth terminal.
- **Bypass:** The lever bypass on the **U3741** operates the sliding bypass only; it is not jaw clamping (medium duty). The lever bypass on the **U3791N** and **U5140** supplies clamping action on the meter spades and also operates the bypass device (heavy duty).
- **Connectors:** Extruded aluminum connectors are tin plated.

Please consult serving utility for their requirements prior to ordering or installing, as specifications and approvals vary by utility, and may require local electrical inspector approval. All installations must be installed by a licensed electrician and must comply with all national and local codes, laws and regulations. Milbank reserves the right to make changes in specifications and features shown without notice or obligation.



Meter Main with Load Center

100–200 Amps | 4 Terminals | Ringless



U3784-RL

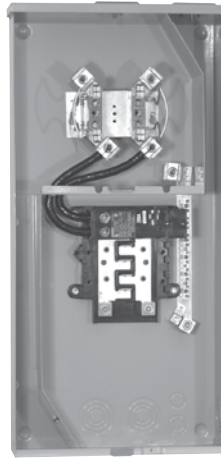
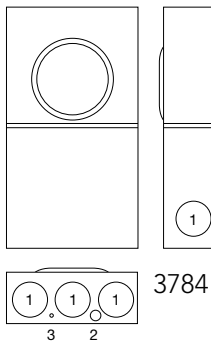

U5168-XTL-200-BL-NE

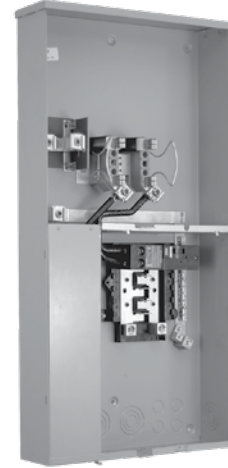
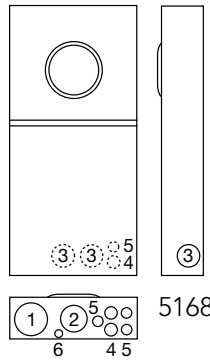

U5898-O-200-BL

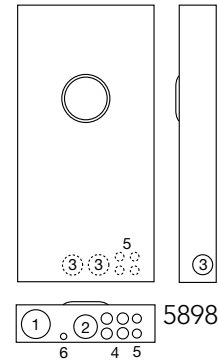

4 Terminals | Ringless | Meter Main with Load Center | 1Ø3W

Catalog Number	Service	Amps	Hub	Circuits	Connectors CU/AL – Line	Bypass	Dimensions			Knockouts					
							D"	W"	H"	1	2	3	4	5	6
U5168-XTL-100-BL-NE	OH/UG	100	(2) C.P.	10	#6-350	None	4½	14⅞	32⅜	3	2½	2	1	½,¾	¼,½
U5168-XTL-200-BL-NE	OH/UG	200	(2) C.P.	8	#6-350	None	4½	14⅞	32⅜	3	2½	2	1	½,¾	¼,½
U3784-RL	OH	200	H.O.	6	#6-350	None	5½	10	31	2	½	¼	—	—	—
U5898-O-200-BL	UG	200	Blank	8	#6-350	None	4½	17	34½	3	2½	2	1	½,¾	¼,½

Notes

- **Fifth Terminal:** For a field-installable fifth terminal for the **U5168**, **U5898**, and **U3784**, order **K5T**.
- **Connectors:** Extruded aluminum connectors are tin plated.
- **Breakers:** The **U5168** and **U5898** are rated **22K AIC** with **QN2200H** main breaker installed and have eight branch breaker provisions.



Please consult serving utility for their requirements prior to ordering or installing, as specifications and approvals vary by utility, and may require local electrical inspector approval. All installations must be installed by a licensed electrician and must comply with all national and local codes, laws and regulations. Milbank reserves the right to make changes in specifications and features shown without notice or obligation.

Lever Bypass Meter Mains

100–200 Amps | 5 & 7 Terminals | Ringless | 120/240 VAC

23
100-200 AMP
LEVER BYPASS
METER MAINS

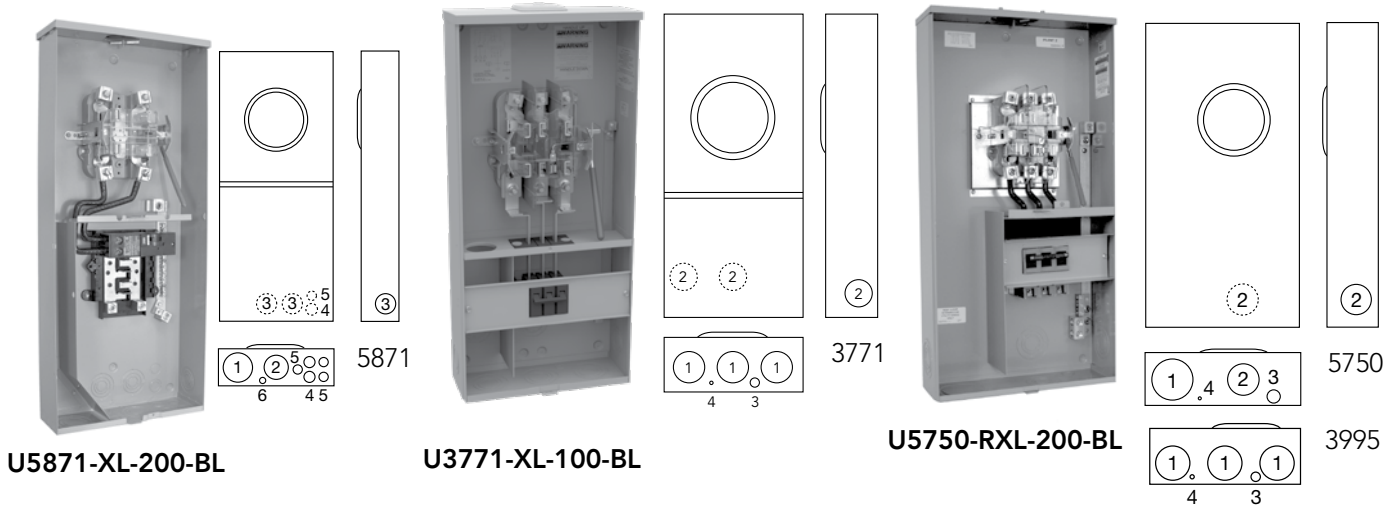

5 Terminals | Ringless | Meter Main with Load Center | 1Ø3W

Catalog Number	Service	Amps	Hub	Circuits	Connectors CU/AL – Line	Bypass	Dimensions			Knockouts					
							D"	W"	H"	1	2	3	4	5	6
U3995-XL-200	OH/UG	200	C.P.	4	#6-350	Lever	4 $\frac{7}{8}$	16	35	3 $\frac{1}{2}$	2 $\frac{1}{2}$	¼, ½	¼	—	—
U5871-XL-200-BL	OH/UG	200	C.P.	8	#6-350	Lever	4 $\frac{1}{2}$	14 $\frac{1}{8}$	33 $\frac{1}{2}$	3	2 $\frac{1}{2}$	2	1	½, ¾	¼, ½

7 Terminals | Ringless | Meter Mains | 3Ø4W

Catalog Number	Service	Amps	Hub	Connectors CU/AL		Bypass	Dimensions			Knockouts			
				Line	Load		D"	W"	H"	1	2	3	4
U3771-XL-100-BL	OH/UG	100	C.P.	#6-2/0	#6-1/0	Lever	4 $\frac{7}{8}$	13	28	2 $\frac{1}{2}$	2	¼, ½	¼
U5750-RXL-200-BL	OH/UG	200	C.P.	#6-350	#1/0-300	Lever	5 $\frac{3}{4}$	17 $\frac{3}{8}$	34	4	3	1	¼

Notes

- **Hubs:** For proper hub selection, see the hub suffix chart on the Accessories page.
- **Bypass:** The lever on the **U3771** operates the bypass device only; it is not jaw-clamping (medium duty). The lever on the **U5750** supplies clamping action on the meter spades and also operates bypass device (heavy duty).
- **Connectors:** Extruded aluminum connectors are tin plated.
- **Fifth Terminal:** For a field-installable fifth terminal for **U5871** and **U3995**, order **K3865**.
- **Breakers:** The **U3771** is supplied with a factory-installed 3-pole, 100 amp plug-in breaker. The **U5750** is supplied with a factory-installed Milbank **UQFB-3200** 3-pole, 200 amp bolt-on breaker.

Please consult serving utility for their requirements prior to ordering or installing, as specifications and approvals vary by utility, and may require local electrical inspector approval. All installations must be installed by a licensed electrician and must comply with all national and local codes, laws and regulations. Milbank reserves the right to make changes in specifications and features shown without notice or obligation.



24

320 AMP
LEVER BYPASS
METER MAINS

Lever Bypass Meter Mains

320 Amps | 4 Terminals | Ringless



U4835-X-2/200-BL

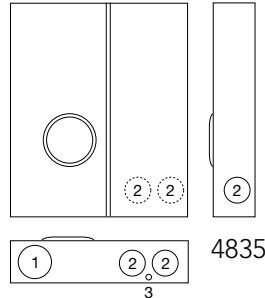

U4031-O-2/200

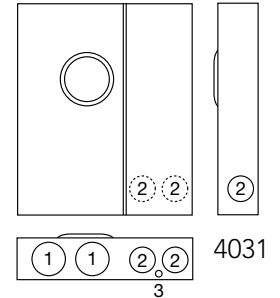

320 Amps | 4 Terminals | Ringless | Meter Mains | 1Ø

Catalog Number	Service	Hub	Connectors CU/AL		Bypass	Dimensions			Knockouts		
			Line	Load		D"	W"	H"	1	2	3
U4835-X-2/200-BL	OH/UG	C.P.	3/8"-16 Studs	#1/0-300	Lever	5 3/4	25	30	4	3	1/4, 1/2
U4031-O-2/200	UG	Blank	3/8"-16 Studs	#1/0-300	Lever	5 3/4	25	30	4	3	1/4, 1/2

Notes

- **Connectors:** The line wire section is supplied with 3/8" -16 studs with hex head nuts and captive Belleville washers. For single lug connector kits, order **K1539** (350 kcmil) or **K1540** (600 kcmil). For twin lug connector kits, order **K1350** (350 kcmil).
- **Breakers:** The **U4031** and **U4835** are supplied with (2) bolt-on Milbank **UQFBH-200** breakers.
- **Bypass:** The lever supplies clamping action on the meter spades and also operates the bypass device.
- **Fifth Terminal:** For field-installed fifth terminal, order catalog number **K3865**.



Please consult serving utility for their requirements prior to ordering or installing, as specifications and approvals vary by utility, and may require local electrical inspector approval. All installations must be installed by a licensed electrician and must comply with all national and local codes, laws and regulations. Milbank reserves the right to make changes in specifications and features shown without notice or obligation.

Cold Sequence Meter Mains

200 & 400 Amps | For use on 480V services

25
COLD
SEQUENCE
METER MAINS

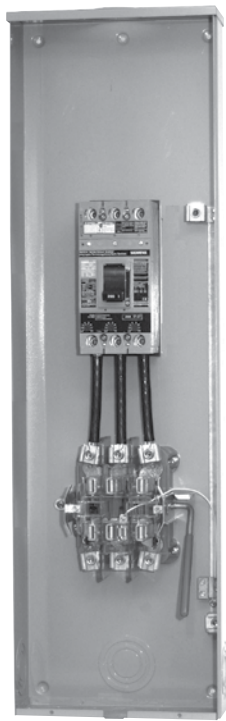

U5767-X-200-CB-BL

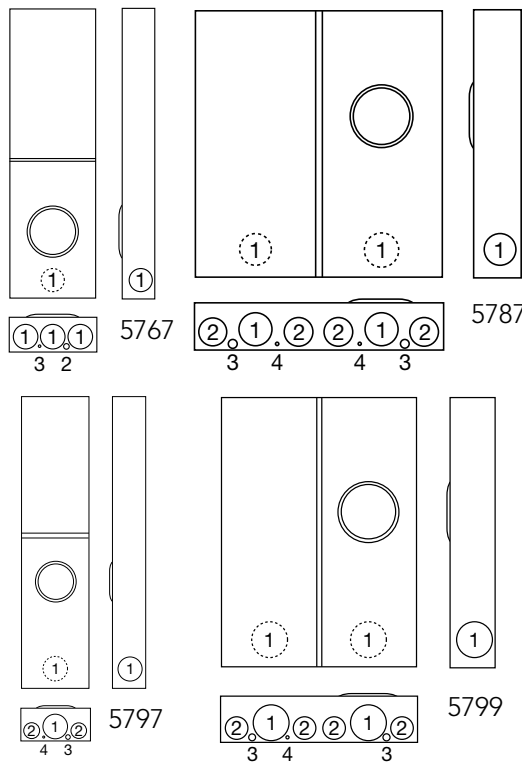

U5799-O-400-CB-BL

200 Amps | 7 Terminals | Circuit Breaker Disconnect Ahead of Meter Socket | 3Ø4W

Catalog Number	Service	Hub	Connectors CU/AL		Bypass	AIC Rating	Dimensions			Knockouts			
			Line	Load			D"	W"	H"	1	2	3	4
U5767-X-200-CB-BL	OH	C.P.	1/0-350	#6-350	Lever	*See note	4 ²⁷ / ₃₂	13	43	3	¼, ½	¼	—
U5787-O-200-CB	UG	Blank	1/0-350	#6-350	Lever	*See note	4 ²⁷ / ₃₂	26	28	4	½, ¾	1	½, ¾

400 Amps (320A Cont.) | 7 Terminals | Circuit Breaker Disconnect Ahead of Meter Socket | 3Ø4W

Catalog Number	Service	Hub	Connectors CU/AL		Bypass	AIC Rating	Dimensions			Knockouts			
			Line	Load			D"	W"	H"	1	2	3	4
U5796-X-400-CB-BL	OH	C.P.	(2) 3/0-500	(2) 3/0-500	Lever	10K	6	13	56	3	¼, ½	¼	—
U5799-O-400-CB-BL	UG	Blank	(2) 3/0-500	(2) 3/0-500	Lever	10K	6	26	36	4 ½	2 ¼	2 ¼	—

Notes

- *AIC Ratings: Circuit breaker rated 600V @ 22K AIC, 480V @ 35K AIC, and 240V @ 65K AIC.

Please consult serving utility for their requirements prior to ordering or installing, as specifications and approvals vary by utility, and may require local electrical inspector approval. All installations must be installed by a licensed electrician and must comply with all national and local codes, laws and regulations. Milbank reserves the right to make changes in specifications and features shown without notice or obligation.



26

100 AMP
MULTI-
POSITION
SOCKETS

Vertical Multi-Position Sockets

100 Amps | 4 Terminals | Ringless | 300 VAC

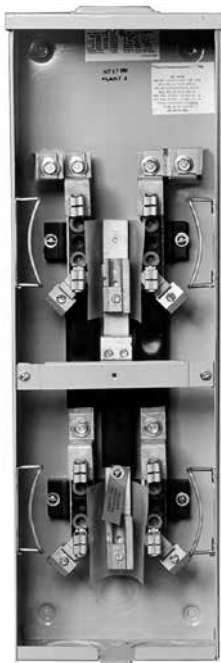

U2692-XL

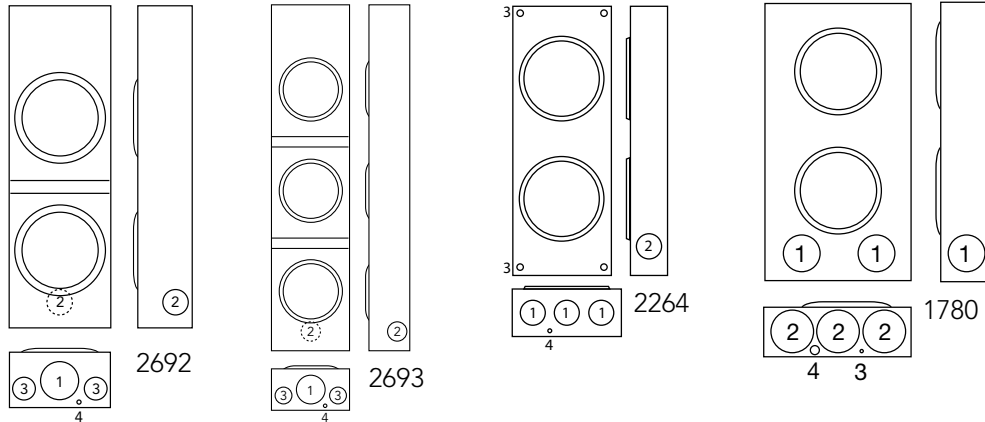

100 Amps | 4 Terminals | Multi-Position | Ringless

Catalog Number	Positions	Service	Hub	Connectors CU/AL		Bypass	Dimensions			Knockouts			
				Line	Load		D"	W"	H"	1	2	3	4
U2692-XL	2	OH/UG	C.P.	#2-350	#6-2/0	None	4 ⁷ / ₈	8	25 ¹ / ₄	2 ¹ / ₂	1 ¹ / ₂	1 ¹ / ₄	1 ¹ / ₄
U2693-XL	3	OH/UG	C.P.	#2-350	#6-2/0	None	4 ¹ / ₈	8	35 ²³ / ₃₂	2 ¹ / ₂	1 ¹ / ₂	1 ¹ / ₄	1 ¹ / ₄
U2264-XL	2	OH/UG	C.P.	#2-350	#6-2/0	*	4 ²⁷ / ₃₂	11	30	2 ¹ / ₂	2 ¹ / ₂	—	1 ¹ / ₄

200 Amps upper socket & 100 Amps lower socket | 4 Terminals | Multi-Position | Ring Type

Catalog Number	Positions	Service	Hub	Connectors CU/AL		Bypass	Dimensions			Knockouts			
				Line	Load		D"	W"	H"	1	2	3	4
U1780-O	2	OH/UG	Blank	#2-350	#6-2/0	None	4 ¹ / ₈	11	26	2 ¹ / ₂	2 ¹ / ₂	1 ¹ / ₄	1 ¹ / ₄

Notes

- **Hubs:** For proper hub selection, see the hub suffix chart on the Accessories page.
- **Fifth Terminal:** For a field-mounted fifth terminal, order catalog number **5T8K2**.
- **Connectors:** Extruded aluminum connectors are tin plated.
- **Bussing:** 1/4 x 1" aluminum bussing is supplied.
- * The **U2264-XL** upper meter socket has a medium duty lever bypass and upper socket is 200 Amps, and the lower socket is 100 Amps.



Please consult serving utility for their requirements prior to ordering or installing, as specifications and approvals vary by utility, and may require local electrical inspector approval. All installations must be installed by a licensed electrician and must comply with all national and local codes, laws and regulations. Milbank reserves the right to make changes in specifications and features shown without notice or obligation.

Multi-Position Sockets

100 Amps/Position | 4 Terminals | Ringless | 300 VAC

27
100 AMP
MULTI-
POSITION
SOCKETS

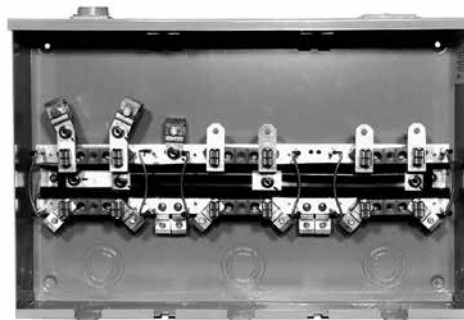

U7363-DL

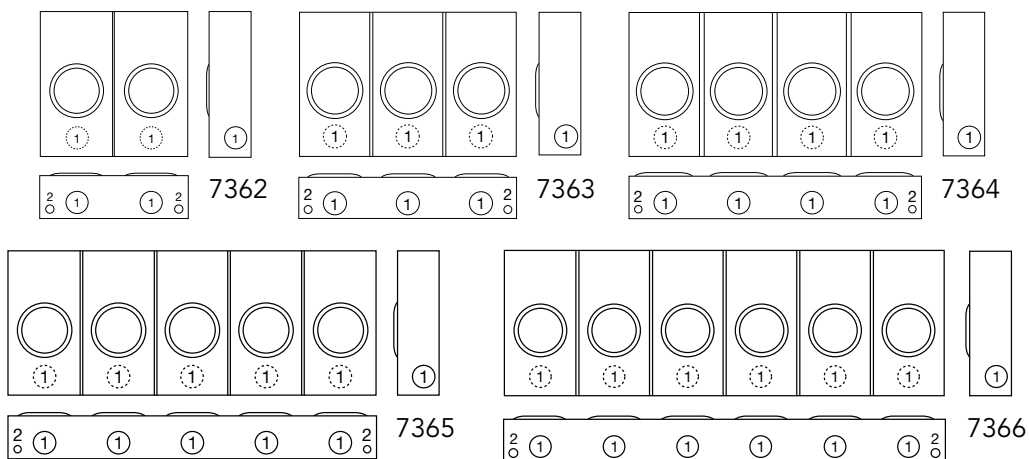

100 Amp/Position | 4 Terminals | Multi-Position | Ringless

Catalog Number	Positions	Service	Hub	Connectors CU/AL			Dimensions			Knockouts	
				Line	Load	Bypass	D"	W"	H"	1	2
U7362-DL	2	OH	2"	#6-350	#6-2/0	None	4½	16 ⁵ / ₁₆	16	2	¼, ½
U7363-DL	3	OH	2"	#6-350	#6-2/0	None	4½	24 ¹ / ₂	16	2	¼, ½
U7364-DL	4	OH	2"	#6-350	#6-2/0	None	4½	32 ¹ / ₁₆	16	2	¼, ½
U7365-DL	5	OH	2"	#6-350	#6-2/0	None	4½	40 ⁷ / ₈	16	2	¼, ½
U7366-DL	6	OH	2"	#6-350	#6-2/0	None	4½	49 ¹ / ₁₆	16	2	¼, ½

Notes

- **Hubs:** For proper hub selection, refer to the hub suffix chart on the Accessories page. Hub opening is supplied at each end. Extra opening is closed with a closing plate.
- **Fifth Terminal:** For field mounted fifth terminal, order catalog number **K1815** for each meter position.
- **Connectors:** Extruded aluminum connectors are tin plated.
- **Bussing:** Bussing is 5/8" x 1" aluminum.

Please consult serving utility for their requirements prior to ordering or installing, as specifications and approvals vary by utility, and may require local electrical inspector approval. All installations must be installed by a licensed electrician and must comply with all national and local codes, laws and regulations. Milbank reserves the right to make changes in specifications and features shown without notice or obligation.



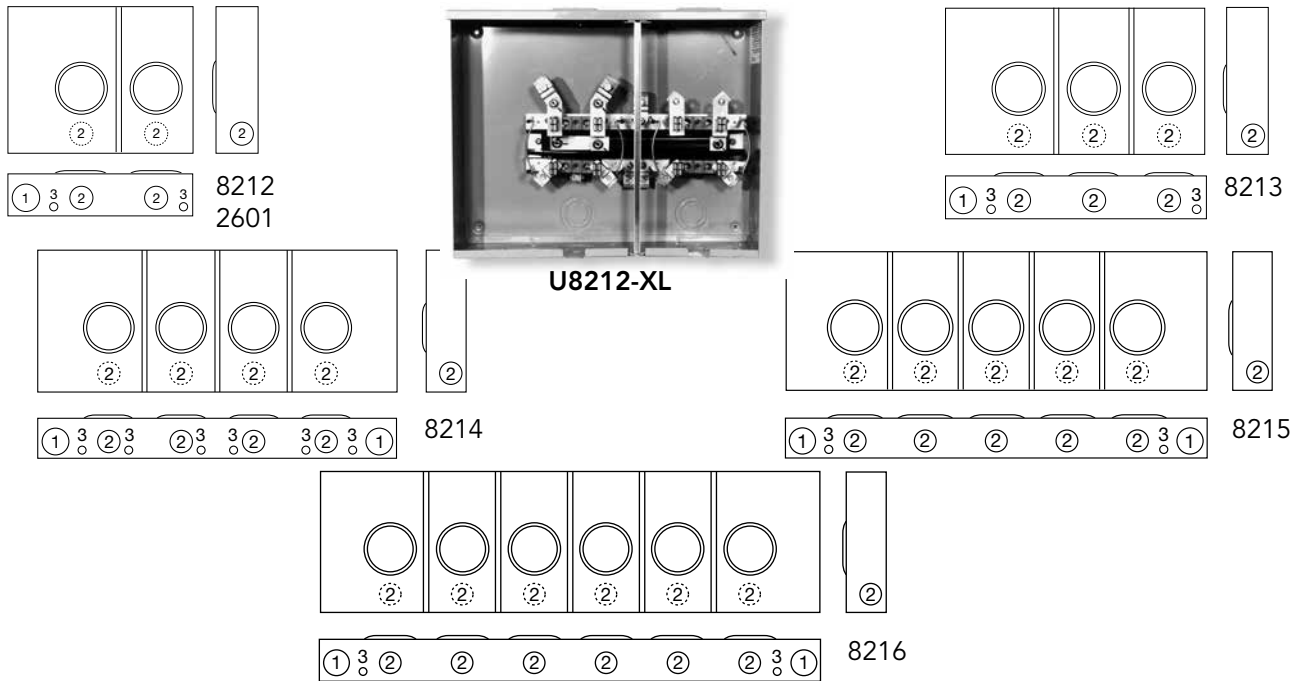

100 Amp per Position | 4 Terminal | Multi-Position | End Wireway | Ringless

Catalog Number	Positions	Service	Hub	Connectors CU/AL		Dimensions			Knockouts		
				Line	Load	D"	W"	H"	1	2	3
U8212-XL	2	OH	C.P.	#6-350	#6-2/0	4½	20 ⁵ / ₁₆	16	2½	2	¼, ½
U8213-XL	3	OH	C.P.	#6-350	#6-2/0	4½	28½	16	2½	2	¼, ½
U8214-XL	4	OH	C.P.	#6-350	#6-2/0	4½	40 ¹¹ / ₁₆	16	2½	2	¼, ½
U8215-XL	5	OH	C.P.	#6-350	#6-2/0	4½	48 ⁷ / ₈	16	2½	2	¼, ½
U8216-XL	6	OH	C.P.	#6-350	#6-2/0	4½	57 ¹ / ₁₆	16	2½	2	¼, ½

200 left /100 right Amp per Position | 4 Terminal | Multi-Position | End Wireway | Ringless

Catalog Number	Positions	Service	Hub	Connectors CU/AL		Dimensions			Knockouts		
				Line	Load	D"	W"	H"	1	2	3
U2601-XL	2	OH	C.P.	#2-350	#2-350 #6-2/0	4½	20 ⁵ / ₁₆	16	2½	2	¼, ½

Notes

- **Hubs:** For proper hub selection, refer to the hub suffix chart on the Accessories page. Hub opening is supplied at each end. Extra opening is closed with a closing plate.
- **Fifth Terminal:** For field mounted fifth terminal, order catalog number **K1815** for each meter position.
- **Connectors:** Extruded aluminum connectors are tin plated.
- **Bussing:** Bussing is 5/16" x 1" aluminum.



Please consult serving utility for their requirements prior to ordering or installing, as specifications and approvals vary by utility, and may require local electrical inspector approval. All installations must be installed by a licensed electrician and must comply with all national and local codes, laws and regulations. Milbank reserves the right to make changes in specifications and features shown without notice or obligation.

Multi-Position Sockets

200 Amps/Position | 4 Terminals | Ringless | 300 VAC

29
200 AMP
MULTI-
POSITION
SOCKETS



U1252-X-K1

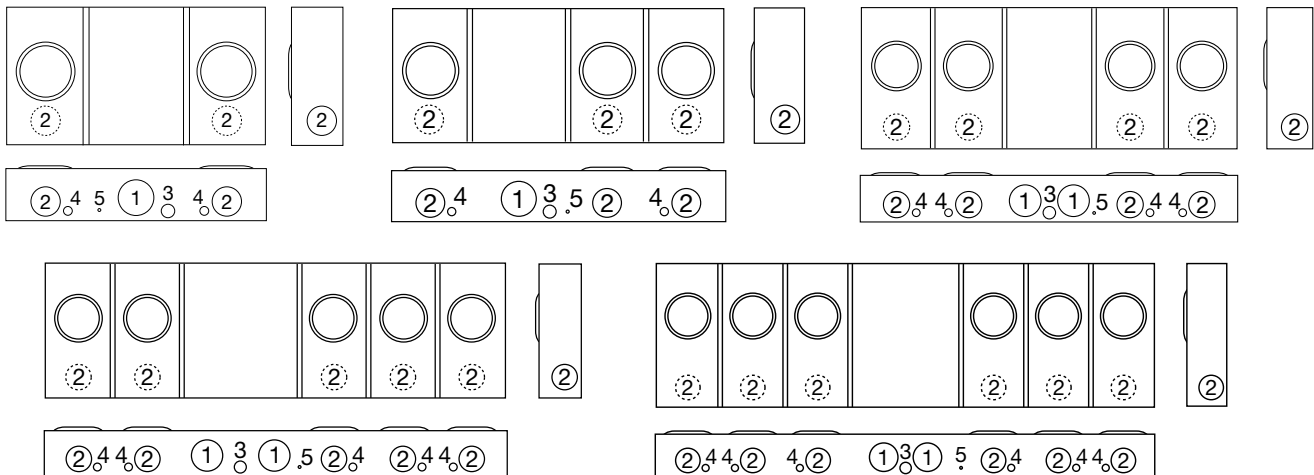

200 Amps | 4 Terminals | Multi-Position | Ringless | 1Ø3W

Catalog Number	Positions	Service	Hub	Connectors CU/AL		Bypass	Dimensions			Knockouts				
				Line	Load		D"	W"	H"	1	2	3	4	5
U1252-X-K1	2	OH/UG	C.P.	#6-350	#6-350	None	5½	26½	14	3	2½	1	½	¼
U1253-X-K3	3	OH/UG	C.P.	#4-600	#6-350	None	5½	34¾	14	3	2½	1	½	¼
U1254-X-K3	4	OH/UG	C.P.	#4-600	#6-350	None	5½	42⅞	16	3	2½	1	½	¼
U1255-X-K4	5	OH/UG	C.P.	(2) #2-600	#6-350	None	5½	54⅞	16	3	2½	1	½	¼
U1256-X-K4	6	OH/UG	C.P.	(2) #2-600	#6-350	None	5½	63⅞	18	3	2½	1	½	¼

Notes

- **Hubs:** For proper hub selection, see the hub suffix chart on the Accessories page.
- **Fifth Terminal:** For a field-mounted fifth terminal, order catalog number **K5T**.
- **Connectors:** Extruded aluminum connectors are tin plated.
- **Bussing:** 5/16" x 1" aluminum bussing is supplied in the **U1252**. 5/16" x 1" aluminum bussing is supplied in the **U1253–U1256**.
- **Overhead Service:** Extension kits for 4, 5 & 6 gang sockets available. Consult factory.

Please consult serving utility for their requirements prior to ordering or installing, as specifications and approvals vary by utility, and may require local electrical inspector approval. All installations must be installed by a licensed electrician and must comply with all national and local codes, laws and regulations. Milbank reserves the right to make changes in specifications and features shown without notice or obligation.



Multi-Position Sockets

125 Amps/Position | 4 Terminals | Ringless | 300 VAC

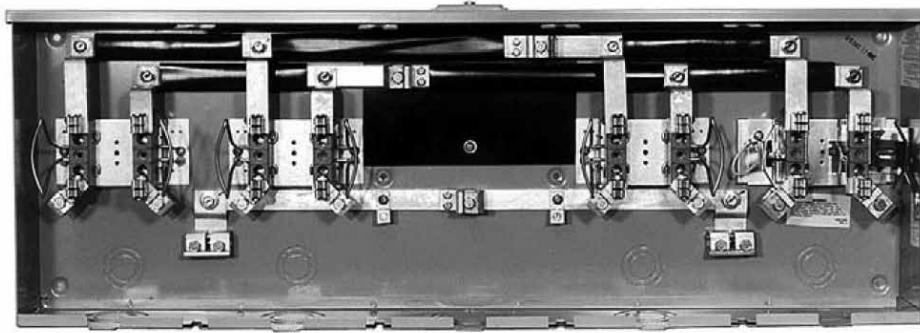

U3764-XL

NOTE

Each unit is supplied with a 125 amp non jaw-clamping lever bypass block assembly in the far right meter position only. All remaining positions are 125 amp with no bypass.

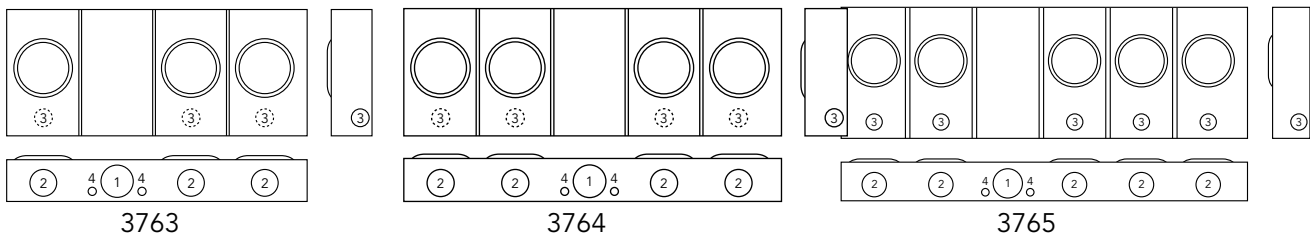

100 Amps | 5 Terminals | Multi-Position | Ringless

Catalog Number	Positions	Service	Hub	Connectors CU/AL		Bypass	Dimensions			Knockouts			
				Line	Load		D"	W"	H"	1	2	3	4
U3763-XL	3	OH/UG	C.P.	#6-2/0	#2-350	See note	4½	33⅞	14	3	2½	1½	¼, ½
U3764-XL	4	OH/UG	C.P.	#6-2/0	#2-350	See note	4½	41⅝	14	3	2½	1½	¼, ½
U3765-XL	5	OH/UG	C.P.	#6-2/0	#2-350	See note	4½	49⅜	16	3	2½	1½	¼, ½

Notes

- **Hubs:** For proper hub selection, see the hub suffix chart on the Accessories page.
- **Fifth Terminal:** For a field-mounted fifth terminal, order catalog number **5T8K2** for tenant positions, and order **K3356** for the far right house power lever bypass socket.
- **Connectors:** Extruded aluminum connectors are tin plated.
- **Bussing:** ¼ x 1" aluminum bussing is supplied.



Please consult serving utility for their requirements prior to ordering or installing, as specifications and approvals vary by utility, and may require local electrical inspector approval. All installations must be installed by a licensed electrician and must comply with all national and local codes, laws and regulations. Milbank reserves the right to make changes in specifications and features shown without notice or obligation.

Vertical Lever Bypass Multi-Position Sockets

100 Amps/Position | 5 Terminals | Ringless | 300 VAC

3 1
100 AMP
LEVER BYPASS
MULTI-
POSITION
SOCKETS



U5112-X-5T9-BL

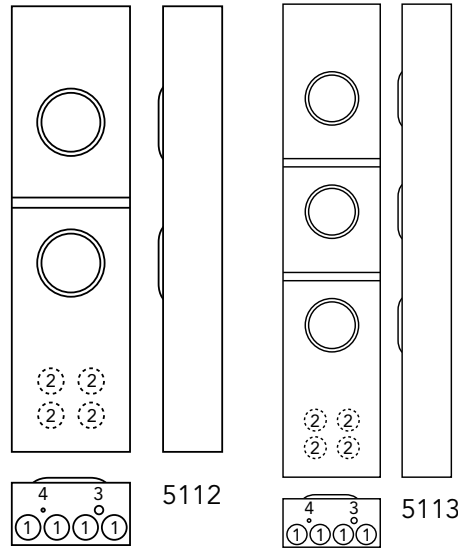

100 Amps | 5 Terminals | Multi-Position | Ringless

Catalog Number	Positions	Service	Hub	Connectors CU/AL		Bypass	Dimensions			Knockouts			
				Line	Load		D"	W"	H"	1	2	3	4
U5112-X-5T9-BL	2	OH	C.P.	#6-350	#6-2/0	Lever	6	12	44½	2½	2	¼, ½	¼
U5113-X-5T9-BL	3	OH	C.P.	#6-350	#6-2/0	Lever	6	12	58½	2½	2	1¼	¼

Notes

- **Hubs:** For proper hub selection, see the hub suffix chart on the Accessories page.
- **Fifth Terminal:** For a field-mounted fifth terminal, order catalog number **5T8K2**.
- **Connectors:** Extruded aluminum connectors are tin plated.
- **Bussing:** ¼ x 1" aluminum bussing is supplied.

Please consult serving utility for their requirements prior to ordering or installing, as specifications and approvals vary by utility, and may require local electrical inspector approval. All installations must be installed by a licensed electrician and must comply with all national and local codes, laws and regulations. Milbank reserves the right to make changes in specifications and features shown without notice or obligation.



32

100 AMP
LEVER BYPASS
MULTI-
POSITION
SOCKETS

Lever Bypass Multi-Position Sockets

100 Amps/Position | 5 Terminals | Ringless | 600 VAC



U2754-X-5T9

(unit shown with connector kit -K1539, order as extra)

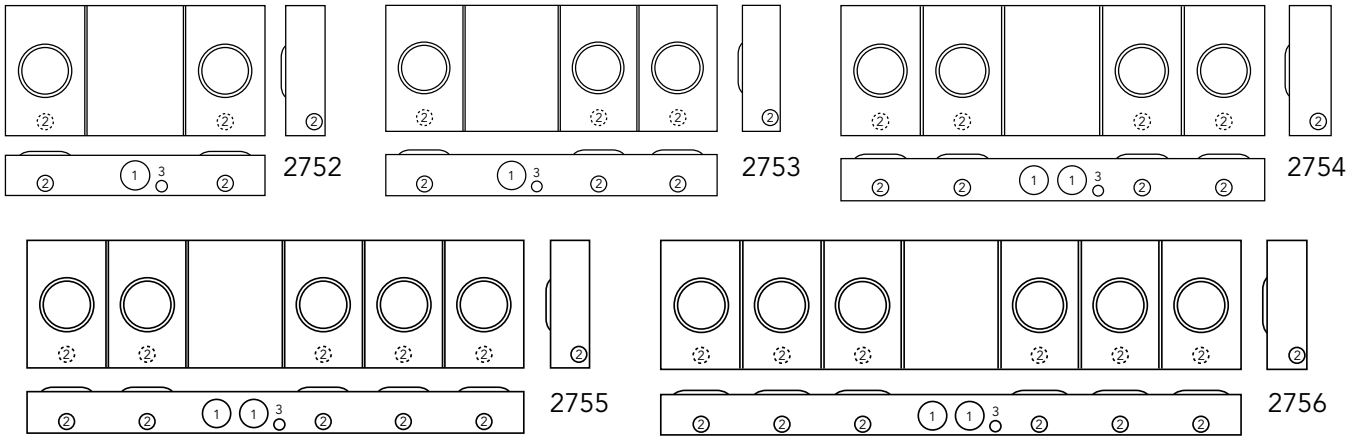

100 Amps | 5 Terminals | Multi-Position | Ringless

Catalog Number	Positions	Service	Hub	Connectors CU/AL		Bypass	Dimensions			Knockouts		
				Line	Load		D"	W"	H"	1	2	3
U2752-X-5T9	2	OH/UG	C.P.	3/8 x 16 studs	#6-2/0	Lever	4 7/8	32 1/8	16	3	1 1/2	1
U2753-X-5T9	3	OH/UG	C.P.	3/8 x 16 studs	#6-2/0	Lever	4 7/8	42 1/4	16	3	1 1/2	1
U2754-X-5T9	4	OH/UG	C.P.	3/8 x 16 studs	#6-2/0	Lever	4 7/8	52 1/4	16	3	1 1/2	1
U2755-X-5T9	5	OH/UG	C.P.	3/8 x 16 studs	#6-2/0	Lever	4 7/8	62 3/8	16	3	1 1/2	1
U2756-X-5T9	6	OH/UG	C.P.	3/8 x 16 studs	#6-2/0	Lever	4 7/8	72 3/8	16	3	1 1/2	1

Notes

- **Fifth Terminal:** The fifth terminal is factory installed in the 9 o'clock position. May field-change to the 6 o'clock position.
- **Connectors:** Aluminum extruded load side connectors are tin plated. For line side single lug connector kits, order **K1539** (350 kcmil) or **K1540** (600 kcmil) as extra. For twin lug connectors, order **K1350** (350 kcmil) or **K1541** (600 kcmil) as extra.
- **Bussing:** 1/4 x 1" aluminum bussing is supplied.
- **Lever Bypass:** The lever operates bypass only; it is not jaw-clamping (medium duty).



Please consult serving utility for their requirements prior to ordering or installing, as specifications and approvals vary by utility, and may require local electrical inspector approval. All installations must be installed by a licensed electrician and must comply with all national and local codes, laws and regulations. Milbank reserves the right to make changes in specifications and features shown without notice or obligation.

Lever Bypass Multi-Position Sockets

200 Amps/Position | 5 Terminals | Ringless | 600 VAC

33
200 AMP
LEVER BYPASS
MULTI-
POSITION



U2873-Xt-5t9

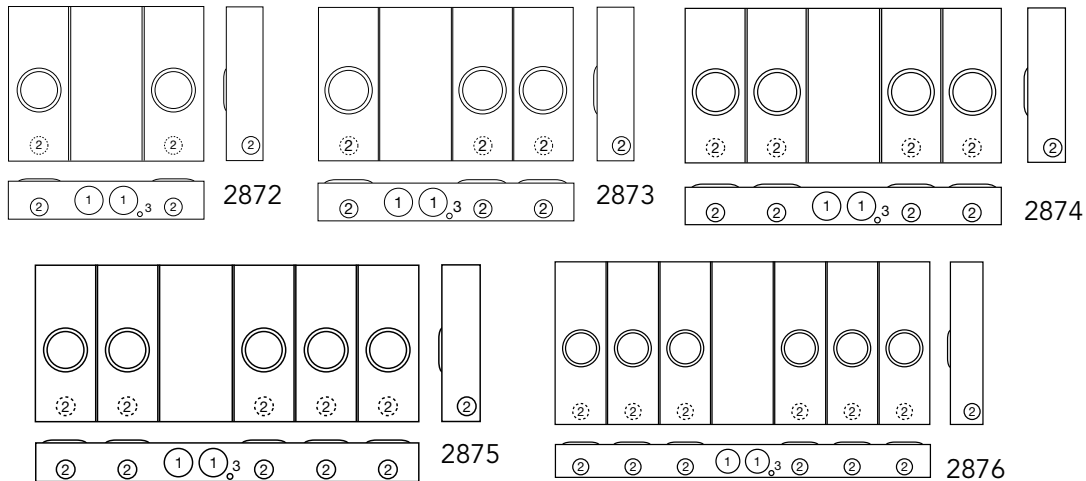

200 Amps per Position | 5 Terminals | Multi-Position | Ringless | 1Ø3W

Catalog Number	Positions	Service	Hub	Connectors CU/AL		Bypass	Dimensions			Knockouts		
				Line	Load		D"	W"	H"	1	2	3
U2872-Xt-5t9	2	OH	(2) C.P.	3/8" x 16 Stud	#6-350	Lever	6	32 1/8	25 1/4	4	2 1/2	1 1/4, 1/2
U2873-Xt-5t9	3	OH	(2) C.P.	3/8" x 16 Stud	#6-350	Lever	6	42 3/16	25 1/4	4	2 1/2	1 1/4, 1/2
U2874-Xt-5t9	4	OH	(2) C.P.	3/8" x 16 Stud	#6-350	Lever	6	52 1/4	25 1/4	4	2 1/2	1 1/4, 1/2
U2875-Xt-5t9	5	OH	(2) C.P.	3/8" x 16 Stud	#6-350	Lever	6	62 5/16	25 1/4	4	2 1/2	1 1/4, 1/2
U2876-Xt-5t9	6	OH	(2) C.P.	3/8" x 16 Stud	#6-350	Lever	6	72 3/8	31 1/4	4	2 1/2	1 1/4, 1/2

Notes

- **Hubs:** Units supplied with two closing plates. To order as extra, refer to the hub suffix chart in the Accessories section.
- **Connectors:** Units supplied with 3/8"-16 hex head nuts with Belleville washers on line side. Order connector kits **K1539** (350 kcmil), **K1540** (600 kcmil), **K1350** ((2) 350 kcmil) or **K1541** ((2) 600 kcmil).
- **Bypass:** Lever supplies clamping action on meter spades and also operates bypass device.
- **Fifth Terminal:** The fifth terminal is factory-installed in the 9 o'clock position; may be field-changed to the 6 o'clock position.
- **Bussing:** 3/8" x 1" aluminum bussing is supplied.

Please consult serving utility for their requirements prior to ordering or installing, as specifications and approvals vary by utility, and may require local electrical inspector approval. All installations must be installed by a licensed electrician and must comply with all national and local codes, laws and regulations. Milbank reserves the right to make changes in specifications and features shown without notice or obligation.



34

200 AMP
LEVER BYPASS
MULTI-
POSITION

Lever Bypass Multi-Position Sockets

200 Amps | 7 Terminals | Ringless | 600 VAC

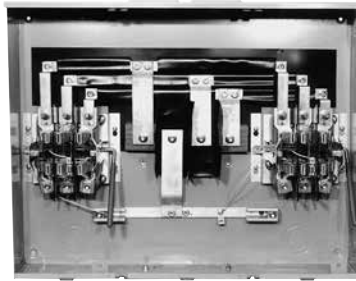

U2732-XT

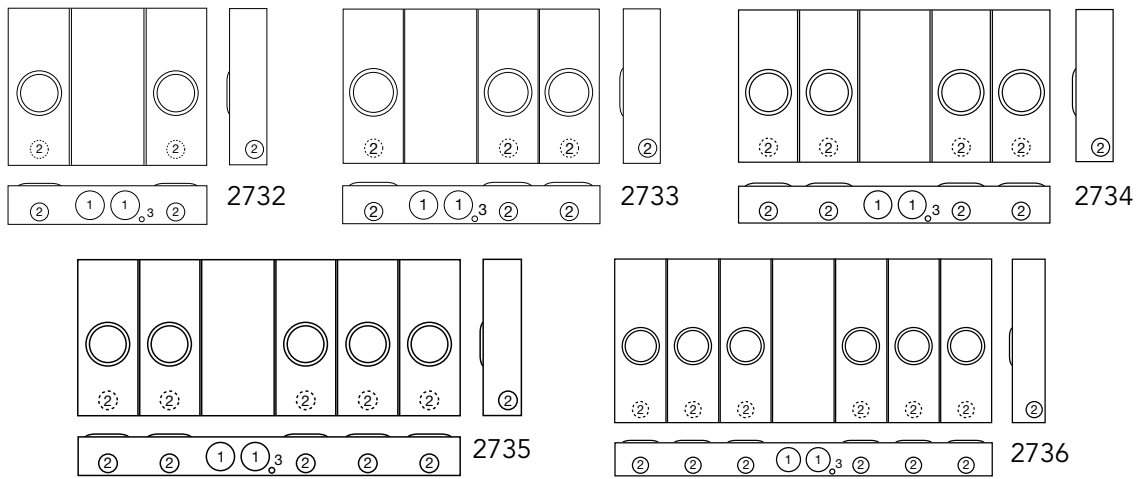

200 Amps per Position | 7 Terminals | Multi-Position | Ringless | 3Ø4W

Catalog Number	Positions	Service	Hub	Connectors CU/AL		Dimensions			Knockouts		
				Line	Load	D"	W"	H"	1	2	3
U2732-XT	2	OH/UG	(2) C.P.	3/8" x 16 Stud	#6-350	6	32 3/8"	25 1/4"	4	2 1/2"	1/4, 1/2"
U2733-XT	3	OH/UG	(2) C.P.	3/8" x 16 Stud	#6-350	6	42 3/16"	25 1/4"	4	2 1/2"	1/4, 1/2"
U2734-XT	4	OH/UG	(2) C.P.	3/8" x 16 Stud	#6-350	6	52 1/4"	25 1/4"	4	2 1/2"	1/4, 1/2"
U2735-XT	5	OH/UG	(2) C.P.	3/8" x 16 Stud	#6-350	6	62 5/16"	25 1/4"	4	2 1/2"	1/4, 1/2"
U2736-XT	6	OH/UG	(2) C.P.	3/8" x 16 Stud	#6-350	6	72 3/8"	31 1/4"	4	2 1/2"	1/4, 1/2"

Notes

- **Hubs:** Units supplied with two closing plates. To order as extra, refer to the hub suffix chart in the Accessories section.
- **Connector Kits:** For line side connector kits, order as extra **K3082** (350 kcmil), **K3441** (600 kcmil), **K3442** (twin 350 kcmil), or **K3083** (twin 600 kcmil). Line connectors can be reversed to change from overhead to underground service.
- **Bypass:** Lever supplies clamping action on meter spades and also operates bypass device.
- **Bussing:** 3/8" x 1" aluminum bussing is supplied.



Please consult serving utility for their requirements prior to ordering or installing, as specifications and approvals vary by utility, and may require local electrical inspector approval. All installations must be installed by a licensed electrician and must comply with all national and local codes, laws and regulations. Milbank reserves the right to make changes in specifications and features shown without notice or obligation.

Multi-Position Meter Mains

125 Amps | 4 Terminal | Ringless | 120/240 VAC

35
125 AMP
MULTI-
POSITION
METER MAINS



U6123-X-BL

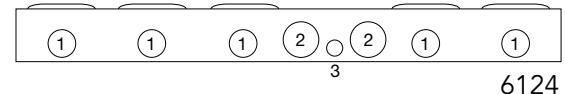
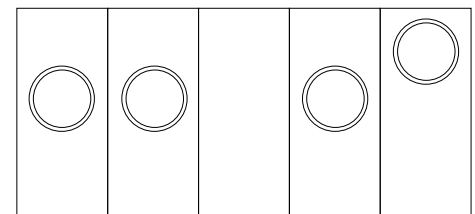
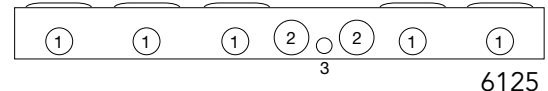
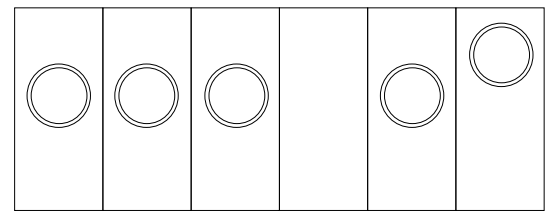
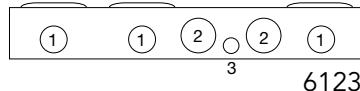
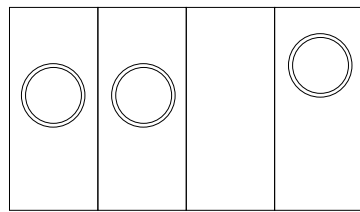

NOTE

Each unit is supplied with a 125 amp jaw clamping lever bypass block assembly in the far right meter position only. All remaining positions are 125 amp with no bypass.

125 Amp Per Position | Multi-Position Meter Mains | Ringless

Catalog Number	Amps Per Position	Positions	Line Connector Size		Dimensions			Knockouts		
			Line	Load	D"	W"	H"	1	2	3
U6123-X-BL	125	3	3/8" x 16 Stud*	C.B.	5 ³¹ / ₃₂	36 ¹ / ₂	30 ¹ / ₂	2 ¹ / ₂	3	1
U6124-X-BL	125	4	3/8" x 16 Stud*	C.B.	5 ³¹ / ₃₂	44 ¹³ / ₁₆	30 ¹ / ₂	2 ¹ / ₂	3	1
U6125-X-BL	125	5	3/8" x 16 Stud*	C.B.	5 ³¹ / ₃₂	53 ¹ / ₁₆	30 ¹ / ₂	2 ¹ / ₂	3	1

Notes

- **AIC Rating:** All models are rated **22K AIC** when used with approved breakers rated at 22K.
- **Hub:** Units supplied with one (1) closing plate. Order hubs separately, see Accessories page.
- **Fifth Terminal:** For a field-mounted fifth terminal, order catalog number **K5T** for tenant positions, and order **K3865** for the far right house power lever bypass socket.

Manufacturer	Cutler Hammer	Siemens	G.E. (50 Amp Max)	Square D
125 Amps or Less	BR, HQP, QPGF	QP, QPH (22K)	THQL	Homeline

Please consult serving utility for their requirements prior to ordering or installing, as specifications and approvals vary by utility, and may require local electrical inspector approval. All installations must be installed by a licensed electrician and must comply with all national and local codes, laws and regulations. Milbank reserves the right to make changes in specifications and features shown without notice or obligation.



36

125 & 200 AMP
MULTI-
POSITION
METER MAINS

Multi-Position Meter Mains

125 & 200 Amps | 4 Terminal | Ringless | 120/240 VAC



U2854-X

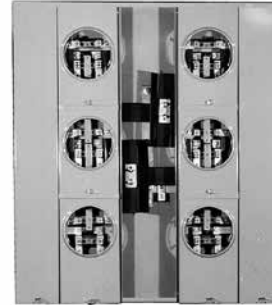

U2866-X

125 Amp Per Position | Multi-Position Sockets | Ringless

Catalog Number	Amps Per Position	Positions	Main Bus Rating	Line Connector Size	Dimensions		
					D"	W"	H"
U2852-X	125	2	200 Amp	3/8" x 16 Stud*	5 13/16	18	25
U2853-X	125	3	200 Amp	3/8" x 16 Stud*	5 13/16	18	37
U2854-X	125	4	400 Amp	3/8" x 16 Stud*	4 7/8	31	25
U2855-X	125	5	400 Amp	3/8" x 16 Stud*	4 7/8	31	37
U2856-X	125	6	400 Amp	3/8" x 16 Stud*	4 7/8	31	37

200 Amp Per Position | Multi-Position Sockets | Ringless

Catalog Number	Amps Per Position	Positions	Main Bus Rating	Line Connector Size	Dimensions		
					D"	W"	H"
U2288-X	200	1	200 Amp	#6-350 kcmil	4 27/32	13	21
U2862-X	200	2	250 Amp	3/8" x 16 Stud*	5 13/16	21	29
U2863-X	200	3	300 Amp	3/8" x 16 Stud*	5 13/16	21	41
U2864-X	200	4	400 Amp	3/8" x 16 Stud*	4 7/8	36	29
U2865-X	200	5	600 Amp	3/8" x 16 Stud*	4 7/8	36	41
U2866-X	200	6	600 Amp	3/8" x 16 Stud*	4 7/8	36	41

Connector Kits*

Size	Suffix	Kit Number	Compatible With	Wire Range
Single	-K1	K1539	U2852-56, U2862-66	#6-350
	-K3	K1540	U2854-56, U2864-66	#4-600
Twin	-K2	K1350	U2854-56, U2863-66	#6-350
	-K4	K1541	U2864-66	#2-600

Breaker Chart

Manufacturer	150–200 Amps	125 Amps or Less
Cutler Hammer	BJ, WBJ	Quicklag P, BR, HQP
Siemens	QNR	QP
Murray	MD	MP
G.E.		Q Line
Square D	—	Homeline

Notes

- **Connectors:** For line wire connector kits, order separately.
- **Fifth Terminal:** For field mounted fifth terminal, order catalog number **K2381**. Order one per meter position.
- **Breakers:** Units have provision for one double pole main per meter position. Breakers not included.
- **Short Circuit Current Rating:** 10K AIC. However, this rating is limited to the lowest interrupting capacity of any circuit breaker installed. Watthour meter not included in short circuit current rating.



Please consult serving utility for their requirements prior to ordering or installing, as specifications and approvals vary by utility, and may require local electrical inspector approval. All installations must be installed by a licensed electrician and must comply with all national and local codes, laws and regulations. Milbank reserves the right to make changes in specifications and features shown without notice or obligation.

Multi-Position Meter Mains

Knockout Information

37

125 & 200 AMP
MULTI-
POSITION
METER MAINS

Catalog Number	Knockouts			
	1	2	3	4
U2288-X	2½	4	¼, ½	3
U2852-X	3	1¼	¼, ½	—
U2853-X	3	1¼	¼, ½	—
U2854-X	3	1¼	¼, ½	—
U2855-X	3	1¼	¼, ½	—
U2856-X	3	1¼	¼, ½	—
U2862-X	3	2	¼, ½	—
U2863-X	3	2	¼, ½	—
U2864-X	3	2	¼, ½	—
U2865-X	3	2	¼, ½	—
U2866-X	3	2	¼, ½	—

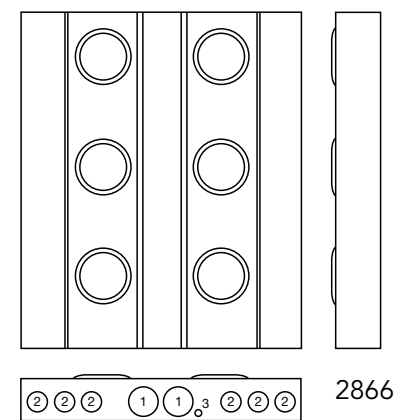
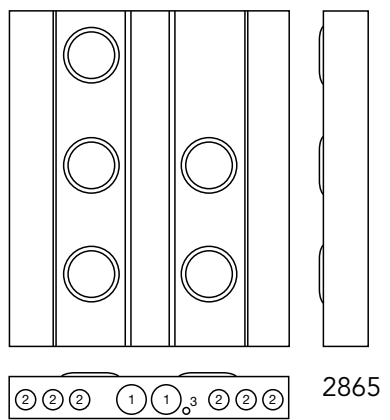
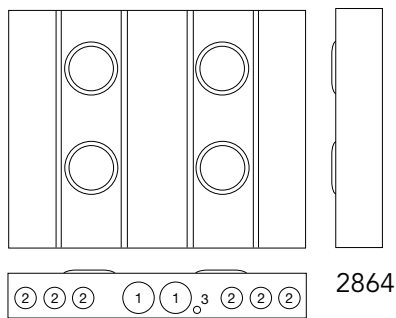
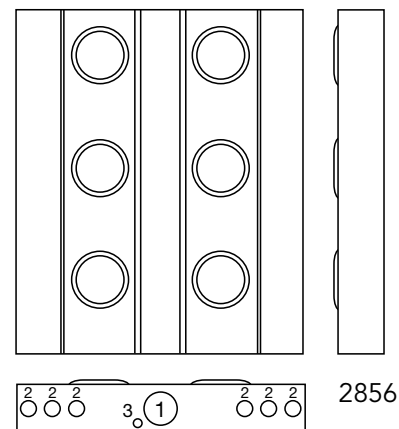
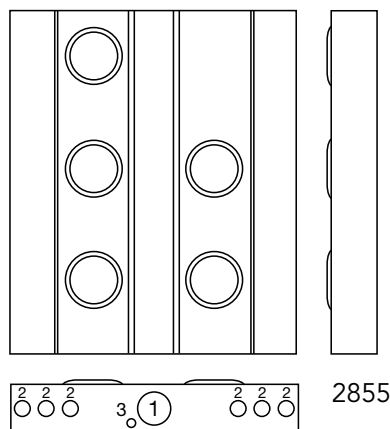
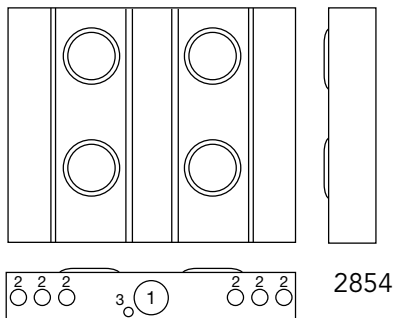
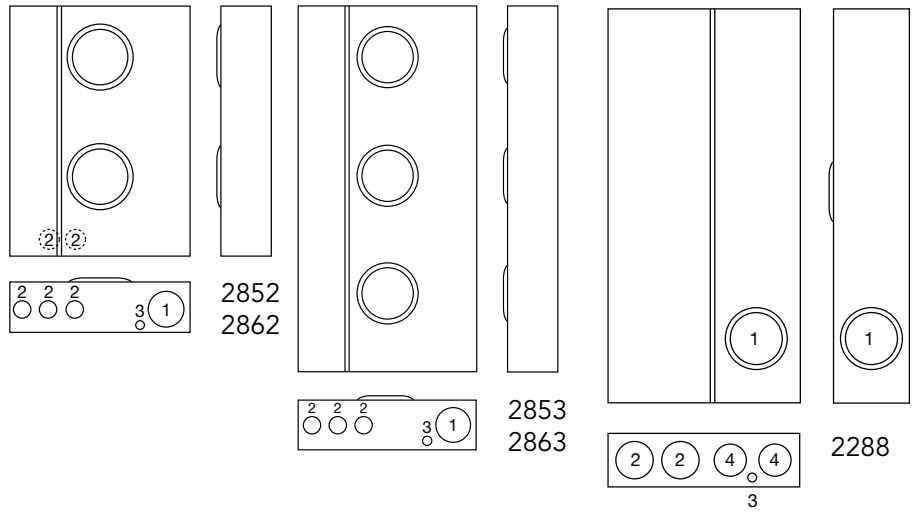

Please consult serving utility for their requirements prior to ordering or installing, as specifications and approvals vary by utility, and may require local electrical inspector approval. All installations must be installed by a licensed electrician and must comply with all national and local codes, laws and regulations. Milbank reserves the right to make changes in specifications and features shown without notice or obligation.



38

200 AMP
LEVER BYPASS
MULTI-
POSITION
METER MAINS

Lever Bypass Multi-Position Meter Mains

200 Amps | 5 Terminals | Ringless | 120/240 VAC



U4374-Xt-5T9

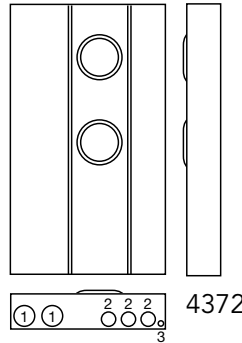

4372

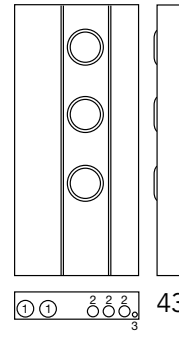

4373

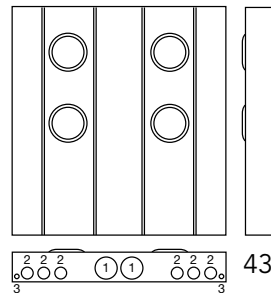

4374

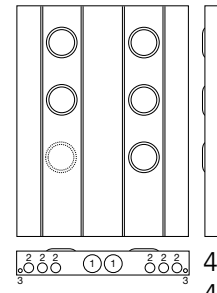

4375

4376

200 Amps/Position | 5 Terminals | Lever Bypass Multi-Position Meter Mains | Ringless | 1Ø3W

Catalog Number	Positions	Main Bus Rating	Line Connector Size	Dimensions			Knockouts		
				D"	W"	H"	1	2	3
U4372-Xt-5T9	2	320 Amps	3/8" x 16 Stud*	6	27 3/4	48	3	2	1/4, 1/2
U4373-Xt-5T9	3	480 Amps	3/8" x 16 Stud*	6	27 3/4	60	3	2	1/4, 1/2
U4374-Xt-5T9	4	640 Amps	3/8" x 16 Stud*	6	45	48	4	2	1/4, 1/2
U4375-Xt-5T9	5	640 Amps	3/8" x 16 Stud*	6	45	60	4	2	1/4, 1/2
U4376-Xt-5T9	6	640 Amps	3/8" x 16 Stud*	6	45	60	4	2	1/4, 1/2

Connector Kits*

Size	Suffix	Kit Number	Wire Range
Single	-K3	K1540	#4-600
Twin	-K2	K1350	#6-350
	-K4	K1541	#2-600

Breaker Chart

Manufacturer	150-200 Amps	125 Amps or Less
Cutler Hammer	BJ, WBJ	Quicklag P BR, HQP
Siemens (ITE)	QNR	QP
Murray	MD	MP
G.E.	—	Q Line
Square D	—	Homeline

Notes

- ***Connectors:** For line wire connector kits, order separately (see chart above).
- **Breakers:** Units have provision for one double pole main per meter position. Breakers not included. Order as extra (see chart above).
- **Bypass:** Lever supplies clamping action on meter spades and also operates bypass device.



Please consult serving utility for their requirements prior to ordering or installing, as specifications and approvals vary by utility, and may require local electrical inspector approval. All installations must be installed by a licensed electrician and must comply with all national and local codes, laws and regulations. Milbank reserves the right to make changes in specifications and features shown without notice or obligation.

Plunger Bypass Transformer Rated Sockets

20 Amps | 6-13 Terminals | 600 VAC

39
20 AMP
TRANSFORMER
RATED SOCKETS



UC1299-XL

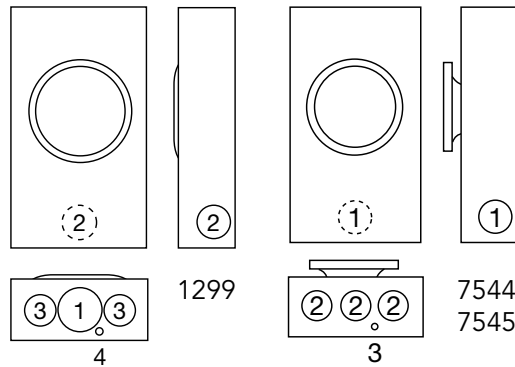

UC7545-RL

20 Amps | Transformer Rated Sockets

Catalog Number	Type	Terminals	Meter Form	Hub	Connectors CU	Bypass	Dimensions			Knockouts			
							D"	W"	H"	1	2	3	4
UC1299-XL	Ringless	6	4S	C.P.	#14 - 4	Plunger	3 ⁵ / ₁₆	8	14	2	1 ¹ / ₂	1 ¹ / ₄	1 ¹ / ₄
UC7544-RL	Ring Type	8	5S	H.O.	#14 - 4	Plunger	3 ⁵ / ₁₆	8	14	1 ¹ / ₂	1 ¹ / ₄	1 ¹ / ₄	—
UC7545-RL	Ring Type	13	6, 8, 9S & (ALT) 10S	H.O.	#14 - 4	Plunger	3 ⁵ / ₁₆	8	14	1 ¹ / ₂	1 ¹ / ₄	1 ¹ / ₄	—

Notes

- **Hubs:** For proper hub selection, see the hub suffix chart on the Accessories page.
- **Bypass:** Plunger type bypass automatically closes when meter is removed.
- **Connectors:** Units are supplied with mechanical type connectors.
- **Sealing Ring:** The ring-type **UC7544** and **UC7545** units include a **MR-2** snap type sealing ring.

Please consult serving utility for their requirements prior to ordering or installing, as specifications and approvals vary by utility, and may require local electrical inspector approval. All installations must be installed by a licensed electrician and must comply with all national and local codes, laws and regulations. Milbank reserves the right to make changes in specifications and features shown without notice or obligation.



Transformer Rated Sockets

20 Amps | 6-13 Terminals | 600 VAC

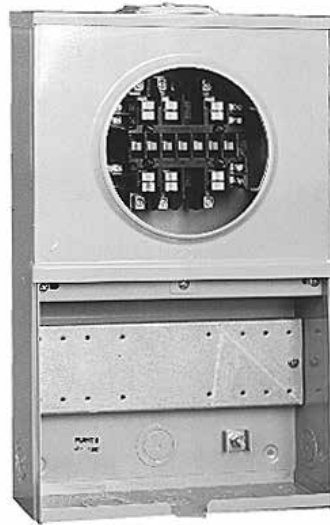

U7449-XL

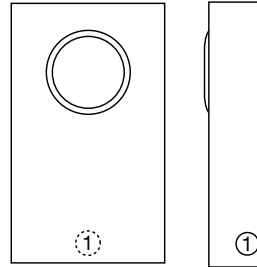

7448
7449
7532

20 Amps | Transformer Rated Sockets | 2 Piece Cover

Catalog Number	Terminals	Meter Form	Hub	Connectors CU	Bypass	Dimensions			Knockouts	
						D"	W"	H"	1	2
UC7532-XL	6	4S	C.P.	#14 - 4	Test Switch Provision	4 1/8	12	20	1 1/4	1/4, 1/2
UC7448-XL	8	5S	C.P.	#14 - 4	Test Switch Provision	4 1/8	12	20	1 1/4	1/4, 1/2
UC7449-XL	13	6, 8, 9S & (ALT) 10S	C.P.	#14 - 4	Test Switch Provision	4 1/8	12	20	1 1/4	1/4, 1/2

Notes

- **Hubs:** For proper hub selection, see the hub suffix chart on the Accessories page.
- **Connectors:** Supplied with tin plated mechanical connectors (#4 maximum).

Transformer Rated Sockets

20 Amps | 6-13 Terminals | 600 VAC

41
20 AMP
TRANSFORMER
RATED
SOCKETS



UC7445-O-311-NOE

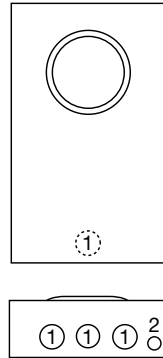

7444
7445
7478

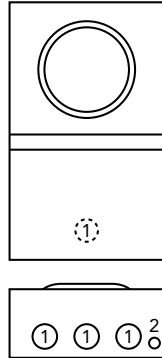

4964
4965
4966



UC4965-O-WC-21-NST

20 Amps | Transformer Rated Sockets | With Pre-wired Test Switch | Approved for N.E. Utilities

Catalog Number	Terminals	Meter Form	Cover	Hub	Connectors CU	Bypass	Dimensions			Knockouts	
							D"	W"	H"	1	2
UC7478-O-81-NOE	6	4S	1 Piece	Blank	#14 - 4	Test Switch	4 $\frac{1}{8}$	12	20	1 $\frac{1}{4}$	1 $\frac{1}{4}$, 1 $\frac{1}{2}$
UC7444-O-141-NOE	8	5S	1 Piece	Blank	#14 - 4	Test Switch	4 $\frac{1}{8}$	12	20	1 $\frac{1}{4}$	1 $\frac{1}{4}$, 1 $\frac{1}{2}$
UC7445-O-311-NOE	13	6, 8, 9S & (ALT) 10S	1 Piece	Blank	#14 - 4	Test Switch	4 $\frac{1}{8}$	12	20	1 $\frac{1}{4}$	1 $\frac{1}{4}$, 1 $\frac{1}{2}$

20 Amps | Transformer Rated Sockets | With Prewired Test Switch | Approved for NSTAR

Catalog Number	Terminals	Meter Form	Cover	Hub	Connectors CU	Bypass	Dimensions			Knockouts	
							D"	W"	H"	1	2
UC4964-O-WC-21-NST	6	4S	2 Piece	Blank	#14 - 4	Test Switch	5 $\frac{1}{8}$	12	20	2	1 $\frac{1}{4}$, 1 $\frac{1}{2}$
UC4965-O-WC-21-NST	8	5S	2 Piece	Blank	#14 - 4	Test Switch	5 $\frac{1}{8}$	12	20	2	1 $\frac{1}{4}$, 1 $\frac{1}{2}$
UC4966-O-WC-21-NST	13	6, 8, 9S & (ALT) 10S	2 Piece	Blank	#14 - 4	Test Switch	5 $\frac{1}{8}$	12	20	2	1 $\frac{1}{4}$, 1 $\frac{1}{2}$

Notes

- **Hubs:** For proper hub selection, see the hub suffix chart on the Accessories page.
- **Connectors:** Supplied with tin plated mechanical connectors (#4 maximum).

Please consult serving utility for their requirements prior to ordering or installing, as specifications and approvals vary by utility, and may require local electrical inspector approval. All installations must be installed by a licensed electrician and must comply with all national and local codes, laws and regulations. Milbank reserves the right to make changes in specifications and features shown without notice or obligation.



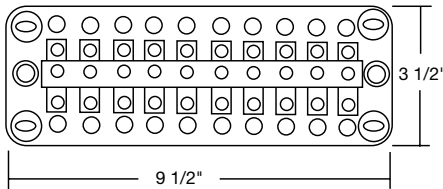
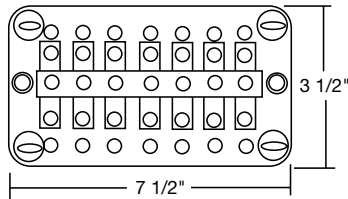
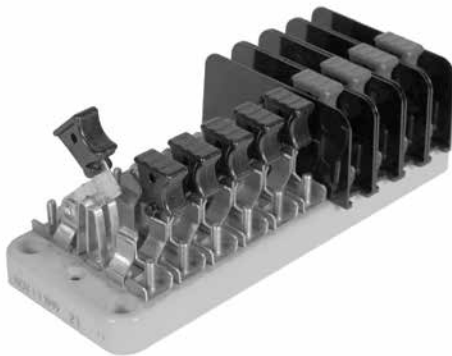

Key	
P	Potential Switch
C+	Line side current switch with short circuit assembly
C	Load side current switch with test jack assembly
N	Neutral bar (no switch)
Pn	Neutral Potential Switch
X	Unused Position on base
	Insulating barrier, isolates both sides of switch

Catalog Number	4-Pole						
TS04-0101	X	P		X	C+	C	X
TS04-0102	X		C+	C	X	Pn	X
TS04-0103	X	P		X	C	C+	X
TS04-0104	X	C+	C	X	P		X

Notes

- 4-pole switches are also available on 10-pole bases. Contact Milbank for appropriate catalog numbers.

Catalog Number	7-Pole						
TS07-0105		P		C+	C	C+	C
TS07-0106		C+	C		C+	C	
TS07-0107		P		C	C+	C	C+
TS07-0108	C+	C	C+	C		P	

Notes

- 4-pole switches are also available on 10-pole bases. Contact Milbank for appropriate catalog numbers.

Catalog Number	7-Pole on a 10-Pole Base									
TS07-0049		X		X		X	C+	C	C	C+
TS07-0018		X		X		X	C+	C	C+	C
TS07-0059	X		C+	C		C	C+		X	X
TS07-0022	P	X	P	X	Pn	X	C	C+	C	C+

Catalog Number	10-Pole									
TS10-0109	P		P		C+	C	C+	C	C+	C
TS10-0110		C+	C		C+	C		C+	C	
TS10-0111	P		P		C	C+	C	C+	C	C+
TS10-0112	C+	C	C+	C	C+	C		P		

Current Transformer Enclosures

400–1200 Amps

43

400–1200 AMP
CURRENT
TRANSFORMER
ENCLOSURES



U1855-O-NE

Current Transformer Enclosures

Catalog Number	Amperage Rating	Hub	Steel Gauge	Connectors CU/AL	Dimensions		
					D"	W"	H"
U1855-O-NE	400–800	Blank	12	3 connectors per phase	12	36	36
U1856-O-NE	800–1200	Blank	12	5 connectors per phase	12	48	48

Notes

- **Features:** These enclosures have three-point locking handles, lift-off hinges with stainless steel pins and two doors. Type 3R rated.
- **Connectors:** Minimum #4, maximum 600 mcm.
- **U1855** and **U1856** both come from the factory with isolated neutrals. Bonding straps are included but not attached with each 1855 and 1856 if isolated neutral is not needed.

Please consult serving utility for their requirements prior to ordering or installing, as specifications and approvals vary by utility, and may require local electrical inspector approval. All installations must be installed by a licensed electrician and must comply with all national and local codes, laws and regulations. Milbank reserves the right to make changes in specifications and features shown without notice or obligation.



Test Cabinet

With Pre-Drilled Test Switch Bridge

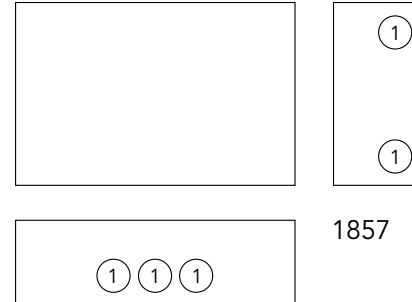
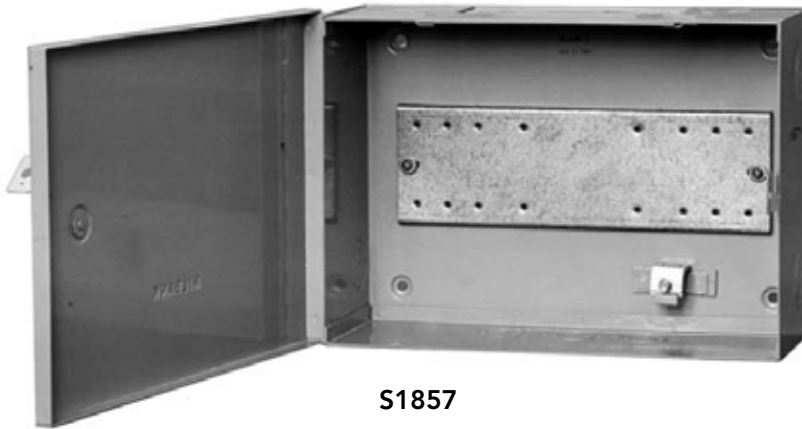

S1857

Test Cabinet

Catalog Number	Hub	Dimensions			Knockouts
		D"	W"	H"	1
S1857	Blank	4 $\frac{1}{8}$	14	10	1 $\frac{1}{4}$

Notes

- **Features:** Test cabinet has a piano-hinged cover and pre-drilled test switch bridge. The top of the enclosure has a rectangular knockout for bussing.



Please consult serving utility for their requirements prior to ordering or installing, as specifications and approvals vary by utility, and may require local electrical inspector approval. All installations must be installed by a licensed electrician and must comply with all national and local codes, laws and regulations. Milbank reserves the right to make changes in specifications and features shown without notice or obligation.

Polyphase Enclosures

For "A" Base Meters

45
POLYPHASE
ENCLOSURES



S2718-FB-XL-C



S3390-FB-XL-C7

Polyphase Enclosures

Catalog Number	Number of Positions	Hub	Dimensions		
			D"	W"	H"
S2718-FB-XL-C	1	C.P.	14	15	34 ¹¹ / ₁₆
S3390-FB-XL-C7	2	C.P.	11	28	34 ¹¹ / ₁₆

Notes

- **Features:** Units are supplied with full board and one demand reset cover per meter position. Cover holding arms included.

Please consult serving utility for their requirements prior to ordering or installing, as specifications and approvals vary by utility, and may require local electrical inspector approval. All installations must be installed by a licensed electrician and must comply with all national and local codes, laws and regulations. Milbank reserves the right to make changes in specifications and features shown without notice or obligation.



Universal Meter Pedestal Unit

For Pad Mounting Applications



S3176-O

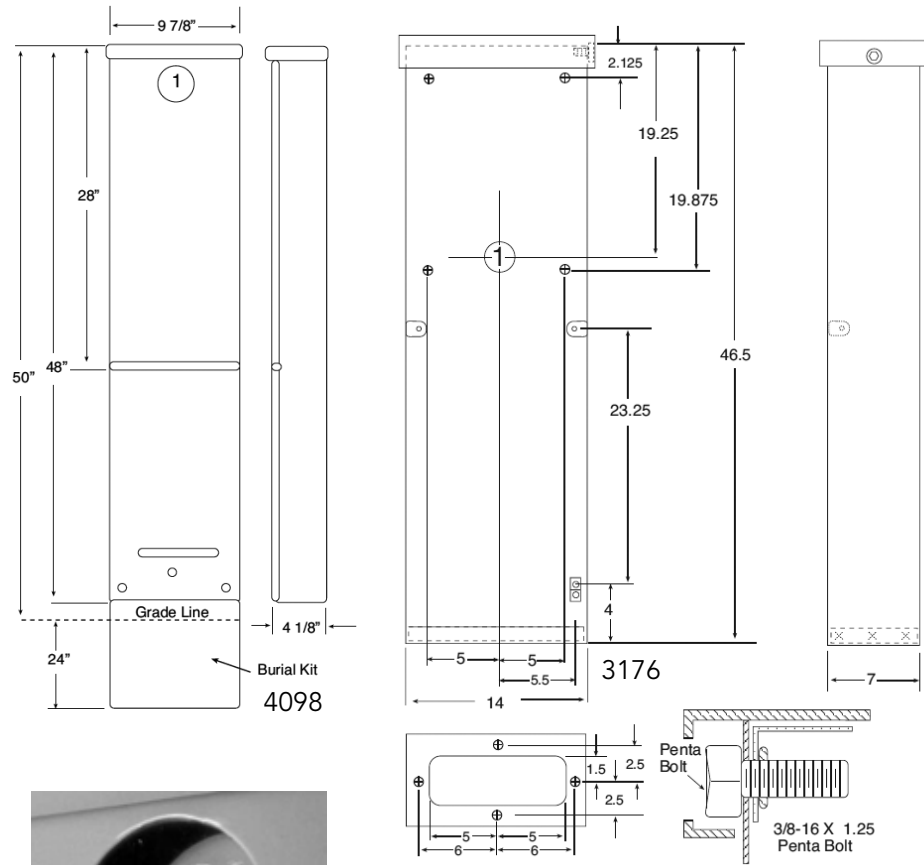

Penta Bolt locking mechanism

Universal Meter Pedestal Units for Pad Mounting

Catalog Number	Hub	Application	Service	Dimensions			Knockouts
				D"	W"	H"	1
S3176-O	Blank	Pad mounted pedestal	UG	7	14	46½"	1¼
S4098-O	Blank	See note below	UG	4⅞	9⅞	20	2½

Notes

- **Direct Burial Kit:** Direct burial kit K3236 and stabilizer foot K3188 are included. Pad mount sleeve K3237 must be ordered separately.
- **Connectors:** Supplied with tin plated mechanical connectors (#4 maximum).



Please consult serving utility for their requirements prior to ordering or installing, as specifications and approvals vary by utility, and may require local electrical inspector approval. All installations must be installed by a licensed electrician and must comply with all national and local codes, laws and regulations. Milbank reserves the right to make changes in specifications and features shown without notice or obligation.

Meter Main Pedestal

200 Amps | 4 Terminals | 120/240 VAC

47
200 AMP
METER MAIN
PEDESTAL

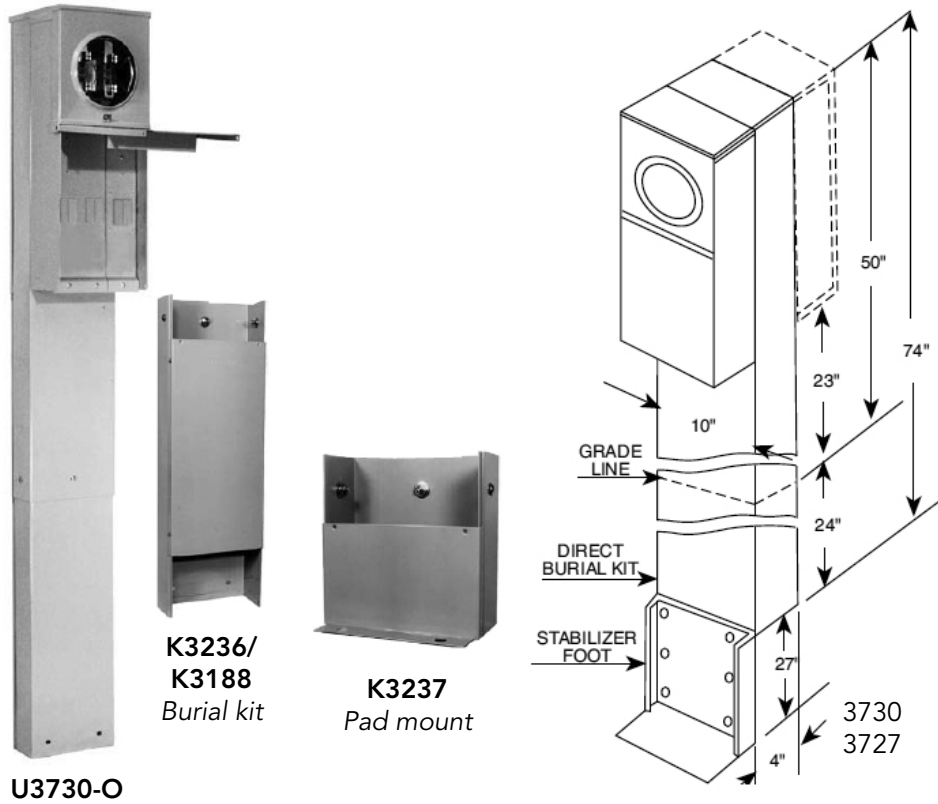

Universal Meter Pedestal Units for Pad Mounting

Catalog Number	Hub	Application	Service	Dimensions			Knockouts
				D"	W"	H"	
U3730-O	Blank	Pad mounted pedestal	UG	7	14	46½"	1¼
U3727-O	Blank	See note below	UG	4⅞	9⅞	20	2½

Notes

- **Direct Burial Kit:** Direct burial kit K3236 and stabilizer foot K3188 are included. Pad mount sleeve K3237 must be ordered separately.
- **Connectors:** Supplied with tin plated mechanical connectors (#4 maximum).

Please consult serving utility for their requirements prior to ordering or installing, as specifications and approvals vary by utility, and may require local electrical inspector approval. All installations must be installed by a licensed electrician and must comply with all national and local codes, laws and regulations. Milbank reserves the right to make changes in specifications and features shown without notice or obligation.



48

200 AMP
METER MAIN
W/ LOAD CENTER
PEDESTALS

Meter Main w/ Load Center Pedestal

200 Amps | 4 Terminals | Lever Bypass | 120/240 VAC



U4322-O-BL

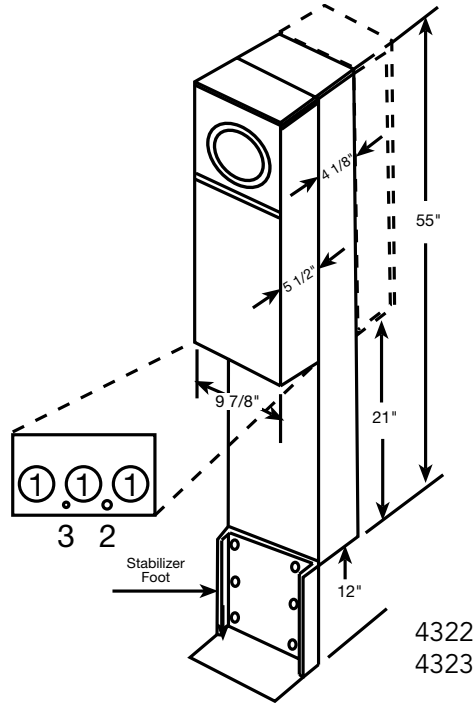

4322
4323



U4323-O-BL

200 Amps | 4 Terminals | Meter Main Pedestals | Lever Bypass | Ringless

Catalog Number	Meter Positions	Bypass	Connectors CU/AL		Circuit Provisions	Knockouts			Dimensions		
			Line	Load		1	2	3	D"	W"	H"
U4322-O-BL	Single	Lever	Twin #6-350	CB	6	2	1/2	1/4	9 5/8	9 7/8	55
U4323-O-BL	Double	Lever	Twin #6-350	CB	6	2	1/2	1/4	15 1/8	9 7/8	55

Notes

- **Lever Bypass:** Lever provides clamping action on meter spades and also operates bypass device
- **Application:** The U4322 & U4323 pedestals are suitable for use as service equipment or mobile home service equipment. K5081/K3188 for direct burial application is included with unit. K5151 for pad mount application must be ordered as extra.
- **Breakers:** These units are wired as parallel mains and have provisions for six circuits: 6 single-pole or 3 double-pole breakers.
- **Short Circuit Current Rating:** 10K AIC. However, this rating is limited to the lowest interrupting capacity of any circuit breaker installed. Watthour meter not included in short circuit current rating.



Please consult serving utility for their requirements prior to ordering or installing, as specifications and approvals vary by utility, and may require local electrical inspector approval. All installations must be installed by a licensed electrician and must comply with all national and local codes, laws and regulations. Milbank reserves the right to make changes in specifications and features shown without notice or obligation.

Temporary Power Units

125 Amp | 4 Terminal | Ringless | 120/240 VAC

49
125 AMP
TEMPORARY
POWER UNITS



U5101-XL-11GR

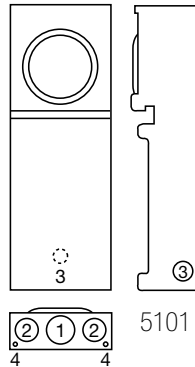

5101



U4908-O-11GR

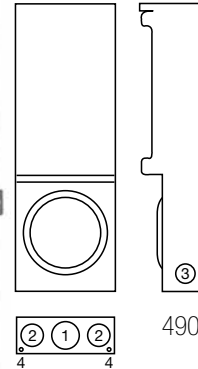

4908

4 Terminal | Temporary Power Units | Ringless | 1Ø3W

Catalog Number	Amps	Service	Hub	Connectors CU/AL		Dimensions			Knockouts				
				Line	Load	D"	W"	H"	1	2	3	4	5
U5101-XL-11GR*	125	OH	C.P.	#6-350	CB	5 ³ / ₁₆	8 ⁷ / ₈	25	2	1 ¹ / ₂	1 ¹ / ₄	1 ¹ / ₄	—
U4908-O-11GR*	125	UG	Blank	#6-2/0	CB	5 ³ / ₁₆	9	25 ¹⁵ / ₁₆	2	1 ¹ / ₂	1 ¹ / ₄	1 ¹ / ₄	—

Notes

- **Interior:** Six circuit plated copper interior accepts standard plug-in type circuit breakers.
- **Receptacle Bridge:** Three position self-grounded receptacle bridge accepts most standard NEMA receptacles with mounting plates.
- **Included Parts:** U4908 and U5101 come supplied with 2-20 amp single pole breakers and 2-20 amp GFCI receptacles (pre-wired and installed).

Please consult serving utility for their requirements prior to ordering or installing, as specifications and approvals vary by utility, and may require local electrical inspector approval. All installations must be installed by a licensed electrician and must comply with all national and local codes, laws and regulations. Milbank reserves the right to make changes in specifications and features shown without notice or obligation.





UQFP
UQFPH



UQFP-M
UQFPH-M



UQFB-X1



UQFBH

200 Amp Frame | Plug-In | 10,000 AIC & 22,000 AIC | Two-Pole - Common Trip

Amps	10K AIC Plug-In	22K AIC Plug-In	10K AIC Plug-In	22K AIC Plug-In	Wire Range	
					CU	AL
100	UQFP-100	UQFPH-100	UQFP-M-100	UQFPH-M-100	#3-#1	#1-1/0
125	UQFP-125	UQFPH-125	UQFP-M-125	UQFPH-M-125	#3-#1	#1-1/0
150	UQFP-150	UQFPH-150	UQFP-M-150	UQFPH-M-150	1/0-300	2/0-300
175	UQFP-175	UQFPH-175	UQFP-M-175	UQFPH-M-175	1/0-300	2/0-300
200	UQFP-200	UQFPH-200	UQFP-M-200	UQFPH-M-200	1/0-300	2/0-300

200 Amp Frame | Bolt-On | 10,000 AIC & 22,000 AIC | Two-Pole - Common Trip

Amps	10K AIC Bolt-On	22K AIC Bolt-On	10K AIC Bolt-On	22K AIC Bolt-On	Wire Range	
					CU	AL
100	UQFB-100	UQFBH-100	UQFB-100-X1	UQFBH-M-100	#3-#1	#1-1/0
125	UQFB-125	UQFBH-125	UQFB-125-X1	UQFBH-M-125	#3-#1	#1-1/0
150	UQFB-150	UQFBH-150	UQFB-150-X1	UQFBH-M-150	1/0-300	2/0-300
175	UQFB-175	UQFBH-175	UQFB-175-X1	UQFBH-M-175	1/0-300	2/0-300
200	UQFB-200	UQFBH-200	UQFB-200-X1	UQFBH-M-200	1/0-300	2/0-300

Notes

- **UL Listed:** For use with 60°C or 75°C wire.
- **UQFP:** For parallel main circuit breaker applications.
- **UQFP-M:** For series main circuit breaker applications Split load tab features allow for feed-through capability.
- **UQFB:** (2) 1/0-300 lugs provided on load and line side (cable-in, cable-out).
- **UQFB3:** Three-pole available. Consult factory.
- **UQFB-X:** (2) 1/0-300 lugs provided on load side and (2) line bar bus connections on line side.
- **UQFB-M:** For series main circuit breaker applications. Split load tab features allow for feed-through capability.



Please consult serving utility for their requirements prior to ordering or installing, as specifications and approvals vary by utility, and may require local electrical inspector approval. All installations must be installed by a licensed electrician and must comply with all national and local codes, laws and regulations. Milbank reserves the right to make changes in specifications and features shown without notice or obligation.

Circuit Breakers

QP (small frame) and QN (large frame) | 120/240 VAC

15–125 Amp Breaker Plug-In Type | 1" Per Pole

Amps	Poles	10K AIC Plug-In	22K AIC Plug-In
15	Single	Q115	Q115H
15	Double	Q215	Q215H
20	Single	Q120	Q120H
20	Double	Q220	Q220H
25	Single	Q125	Q125H
25	Double	Q225	Q225H
30	Single	Q130	Q130H
30	Double	Q230	Q230H
35	Single	Q135	Q135H
35	Double	Q235	Q235H
40	Single	Q140	Q140H
40	Double	Q240	Q240H
50	Single	Q150	Q150H
50	Double	Q250	Q250H
60	Single	Q160	Q160H
60	Double	Q260	Q260H
70	Single	Q170	Q170H
70	Double	Q270	Q270H
80	Double	Q280	Q280H
90	Double	Q290	Q290H
100	Double	Q2100	Q2100H
125	Double	Q2125	Q2125H



QN2200H



QN2200RH



WBJ2200



Q250

200 Amp Frame | Plug-In | 10,000 AIC & 22,000 AIC | Two-Pole, Common Trip

Amps	10K AIC Plug-In	22K AIC Plug-In	Handle Location	Wire Range	
				CU	AL
150	QN2150	QN2150H	Left facing	#4-300	#4-300
200	QN2200	QN2200H	Left facing	#4-300	#4-300
150	QN2150R	QN2150RH	Right facing	#4-300	#4-300
200	QN2200R	QN2200RH	Right facing	#4-300	#4-300
150	WBJ2150	—	Centered	#2-300	#2-300
200	WBJ2200	—	Centered	#2-300	#2-300

Notes

- Load connectors supplied with breakers.
- UL Listed for use with 60°C or 75°C wire.
- Wire sizes shown are lug capacity. Consult NEC Article #310 for specific wire sizes.

Please consult serving utility for their requirements prior to ordering or installing, as specifications and approvals vary by utility, and may require local electrical inspector approval. All installations must be installed by a licensed electrician and must comply with all national and local codes, laws and regulations. Milbank reserves the right to make changes in specifications and features shown without notice or obligation.



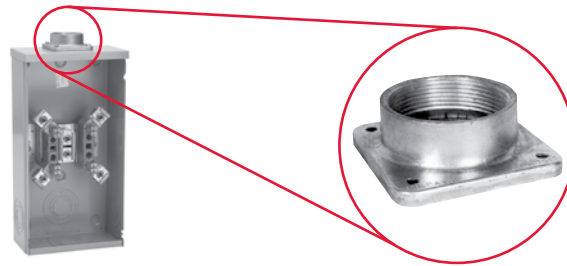
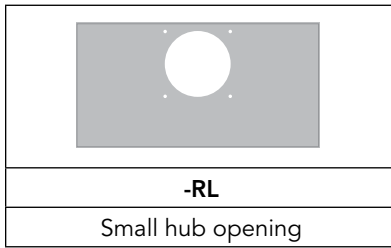

-WL A7514	-YL A7515	-ZL A7516	-DL A7517	-EL A7518	-XL A7551
1" hub	1¼" hub	1½" hub	2" hub	2½" hub	Small closing plate

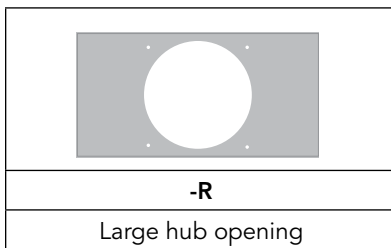

-F A8110	-G A8111	-H A8112	-X A9064	-RRL S8324
3" hub	3½" hub	4" hub	Large closing plate	Large hub opening adapted to small hub opening

Notes

- **Suffix:** Add to catalog number for factory installation of hub.
- **Packaging:** Individually packed units for field installation.
- **Abbreviations:** H.O. (hub opening), C.P. (closing plate).
- Hub Mast rated



Please consult serving utility for their requirements prior to ordering or installing, as specifications and approvals vary by utility, and may require local electrical inspector approval. All installations must be installed by a licensed electrician and must comply with all national and local codes, laws and regulations. Milbank reserves the right to make changes in specifications and features shown without notice or obligation.

Accessories

Connector Kits, Closing Kits & Generator Interlock

Connector Kits — For Use with 3/8"-16 Stud Type Units Only

Single			Twin		
Suffix	Part #	(3 per set) - 1Ø	Suffix	Part #	(3 per set) - 1Ø
K1	K1539	6-350	K2	K1350	6-350
K3	K1540	4-600 or (2) 1/0-250*	K2L	K1350L	6-350 (non rotating)
K3L	K1540L	4-600 or (2) 1/0-250* (non rotating)	K4	K1541	4-600
Suffix	Part #	(4 per set) - 3Ø	Suffix	Part #	(4 per set) - 3Ø
K5	K3082	6-350	K6	K3442	6-350
K7	K3441	4-600 or (2) 1/0-250*	K8	K3083	4-600

*For (2) 1/0-250, conductors must be of same size.

Bypass Link



K8180 (sold in pairs)

Note

Consult factory for proper connector kits for studded meter sockets.

Closing Covers

Meter Closing Plate (Ring Type / Ringless)	Metal Closing Plate (For Ringless Sockets)
6003 - Grey Plastic	CP-21
6116 - Clear Plastic	
6002 - Clear Plastic	

Disconnect Sleeve



M5-144

Do not use with lever bypass sockets

Isolated Neutral Kit



K1047

Pole Hanger Kit





850 comes with 4 pole hangers

Catalog Number	Description of pole hanger brackets
850	Two pair (4 pieces) with mounting hardware

Please consult serving utility for their requirements prior to ordering or installing, as specifications and approvals vary by utility, and may require local electrical inspector approval. All installations must be installed by a licensed electrician and must comply with all national and local codes, laws and regulations. Milbank reserves the right to make changes in specifications and features shown without notice or obligation.

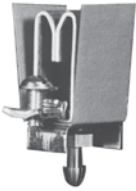
Fifth Terminals, Tap Connectors & Block Assemblies

Fifth Terminals

			
5T8K2 - 100-200 Amp "Plug-In"	K5T - 200 Amp (Block with Square Hole)	K3865 - Heavy Duty Jaw Clamping (K3866 without Neutral Wire)	K3356

Tap Connectors (3 per set)

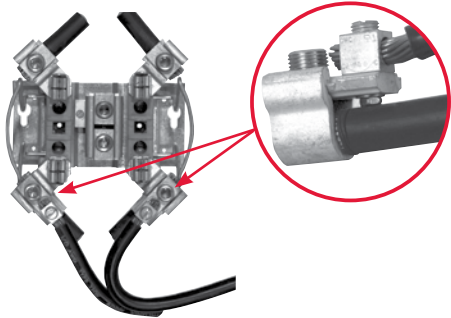
	<p>Replaces the load or line side slide-in nut assembly on Milbank 200 amp sockets. Allows for a 100 amp tap location in addition to the #6-350 kcmil load-side connector. K5022 includes safety barrier extensions for applications over 300 VAC. Three lugs per kit.</p>
K4977-INT - Internal Hex	
K4977-EXT - External Hex	
K5022-INT - Internal Hex (set of 4 w/ barrier)	

Triplex Ground

K1190 (For factory installed triplex ground, add suffix -TG to catalog number)

100 Amp Blocks *(single sockets only)*

BL7474 - Block Assembly
Z904486-AO - Slotted Nut Assembly
Z802965-AC - Neutral without Nut
Z901925-AC - Hex Nut Set Screw

200 Amp Blocks *(single sockets only)*



Commercial Pedestals

Attractive | Easy to Install | Secure | Cost-Effective

Milbank Commercial Pedestals are pad-mounted, weather resistant electrical enclosures consisting of a utility pull section with optional meter socket, and a customer section containing distribution and control equipment. Milbank Commercial Pedestals are an attractive, secure, easy to install and cost-effective solution when underground remote site power distribution and control equipment is required, replacing unsightly and inefficient strut and backboard structures.



Strut and backboard



Commercial pedestal

UL Listed as Industrial Control Equipment (File E113855)

Standard Features

- Type 3R rain resistant, vandal-resistant cabinet of polyurethane powder-coated steel (aluminum or stainless steel also available)
- UL listed as enclosed industrial control equipment (UL508)
- Isolated lockable and sealable utility metering and lug landing sections
- Lockable customer section for distribution and control equipment with internal deadfront
- Print pocket inside customer section door contains wiring schematics and installation instructions
- Most load centers are UL listed for use with various manufacturers' circuit breakers
- All stainless steel external hardware (screws, bolts, hinges, handles, hasps and sealing screws)

Note

All meter form and bypass options available to meet utility requirements.

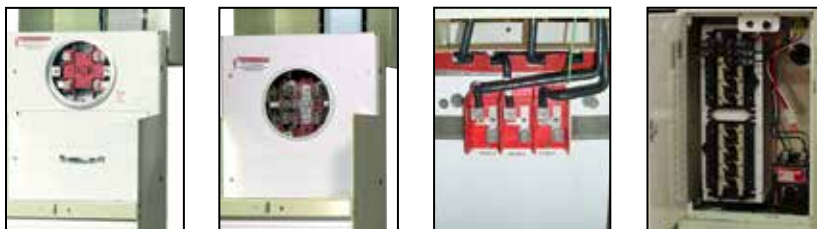

Please consult serving utility for their requirements prior to ordering or installing, as specifications and approvals vary by utility, and may require local electrical inspector approval. All installations must be installed by a licensed electrician and must comply with all national and local codes, laws and regulations. Milbank reserves the right to make changes in specifications and features shown without notice or obligation.



Attractive | Easy to Install | Secure | Cost-Effective



Applications

These units are ideal for controlling and metering:

- Traffic signals
- Street lighting
- Power distribution for EV charging stations
- Irrigation and sprinkler systems
- Cell towers and telephone vaults
- Pump stations
- Temporary power for fairgrounds, swap meets, outdoor markets, portable offices, holiday lights, etc.
- Outdoor lighting for athletic fields, tennis and basketball courts, parking lots, landscaping and subdivision entrances, etc.

Available Factory-Installed Options

- Meter sockets: ring type or ringless, up to 400 amp
- Main and branch breakers or T fuses
- Distribution: copper load centers and panel boards
- Clocks, timers and relays
- Photoelectric cells and controls
- Power receptacles: pin and sleeve, twist lock or straight blade
- Contactors: definite purpose, electrical or mechanically held, IEC and mercury types
- Surge protection and lightning arrestors
- Reserve inlet generator receptacle with interlocked circuit breakers
- Motor starters and relays
- Push button controls
- Thermostat controls, fans and heating strips
- Power blocks and terminal blocks
- Steel, aluminum and plywood backboards
- Transformers
- Interlock devices for circuit breakers
- Available in steel, aluminum (raw painted or anodized) or stainless steel construction with powder-coated finish available in eight standard colors or special-ordered RAL colors
- Available for applications up to 400 amp, 120V, 208V, 240V, 277V, 480V - 1Ø or 3Ø

Accessories



K3865
Fifth terminal kit for use with ringless meter sockets

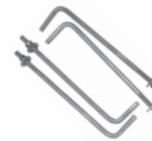

CP-ABK5/8
Anchor bolt kit (includes four 5/8 - 13 x 18" anchor bolts)



105J
Fifth terminal kit for use with ring type meter sockets



CP-TC7D
7-day time clock kit
CP-TC24H
24-hour time clock kit
CP-TCWIRE
Male 4-pin connector and wiring harness for use with time clocks other than above

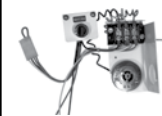

CP-PE-HOA-3POS
HOA switch for field installation



CP-16PDMNT-CALT
16" pedestal mounting base
CP-24PDMNT-CALT
24" pedestal mounting base (includes mounting hardware)



Please consult serving utility for their requirements prior to ordering or installing, as specifications and approvals vary by utility, and may require local electrical inspector approval. All installations must be installed by a licensed electrician and must comply with all national and local codes, laws and regulations. Milbank reserves the right to make changes in specifications and features shown without notice or obligation.

Commercial Pedestals

Main Load Center Series | Custom Designs Available

CP3B "ML" Series

Main Load Center Series

1Ø3 wire 120/240V or 208Y/120V

Application: remote site service for multiple loads

The **Milbank Main Load Center Commercial Pedestals** are designed to handle the vast majority of all requirements in a standard, stocked configuration.

- All units feature a load center with a plug-on, back-fed main breaker.
- Load center has 16 positions for the 100 amp pedestals and 24 circuits for the 200 amp pedestals.
- Both sizes include sub-feed lugs to allow feeding an external panel.

If your application requires turning loads on based on "dusk-to-dawn" requirements, be sure to see the Milbank Switched Load Center Commercial Pedestal products on the following page.

Features

These units include everything required for remote site service:

- NEMA 3R construction.
- Expandable: load centers allow for future expansion without costly modifications.
- All units feature 200 amp meter socket with optional field installable fifth terminal kit available.
- 22K ampere interrupting capacity (AIC) standard.
- Optional mounting base can be embedded in concrete for fast, easy installation.
- Separate sealable and lockable utility termination section.
- Separate sealable and lockable metering section.
- Separate sealable and lockable customer section with a load center for "always on" loads that include a main circuit breaker, 20 (125 or 200 amp model) or 14 (100 amp model) blank breaker spaces and a circuit directory to document configuration.



CP3B11115A22

Typical Applications

Remote site service for multiple loads.

Stocked Pedestals	Optional Fifth Terminal Kit	Main CB		Load Center Circuits	Meter Socket Type
		Amp	Spaces		
CP3B51115A22	K3865	100	1,2	16	Ringless socket with lever bypass
CP3B52119A22	K3865	200	1,2,3,4	24	Ringless socket with lever bypass

Notes

- Chart shows standard, stocked items. Other options and features are available. Contact factory for options, details and availability.

Please consult serving utility for their requirements prior to ordering or installing, as specifications and approvals vary by utility, and may require local electrical inspector approval. All installations must be installed by a licensed electrician and must comply with all national and local codes, laws and regulations. Milbank reserves the right to make changes in specifications and features shown without notice or obligation.



CP3B "SL" Series

Switched Load Center Series
1Ø3 wire 120/240V or 208Y/120V

Milbank's Switched Load Center Commercial Pedestals are designed not only to provide power for various loads, but also to switch specific loads on and off under certain conditions. A photoelectric cell is used for these controlled loads, and an optional time clock is also available.

Features

These units include everything required for remote site service:

- NEMA 3R construction.
- Expandable: load centers allow for future expansion without costly modifications.
- All units feature 200 amp meter socket with optional field installable fifth terminal kit available.
- 22K ampere interrupting capacity (AIC) standard.
- Optional mounting base can be embedded in concrete for fast, easy installation.
- Separate sealable and lockable utility termination section.
- Separate sealable and lockable metering section.
- Separate sealable and lockable customer section with a control circuit including PE receptacle, Lexan® window, glare shield, Hand-Off-Auto (HOA) switch, contractor controlling a 16-circuit load center for controlled loads, a pre-mounted DIN rail and pre-wired connector to add an optional "plug-and-play" time clock kit for PE on and TC off operation and a circuit directory to document configuration.
- A load center for "always on" loads that includes a main circuit breaker, a control power circuit breaker, a switched load center main breaker, nine (125 or 200 amp model) or 11 (100 amp model) blank breaker spaces and a circuit directory to document configuration.



CP3B11110A22SL1

Typical Applications

Traffic signals, parking lots, highways & athletic field lighting

Stocked Pedestals	Optional Fifth Terminal Kit	Main CB		Contactor Amperage	Meter Socket Type
		Amp	Spaces		
CP3B51110A22SL1	K3865	100	1,3	60	Ringless socket with lever bypass
CP3B52110A22SL1	K3865	200	1,2,3,4	100	Ringless socket with lever bypass

Notes

- Chart shows standard, stocked items. Other options and features are available. Contact factory for options, details and availability.



Please consult serving utility for their requirements prior to ordering or installing, as specifications and approvals vary by utility, and may require local electrical inspector approval. All installations must be installed by a licensed electrician and must comply with all national and local codes, laws and regulations. Milbank reserves the right to make changes in specifications and features shown without notice or obligation.

Commercial Pedestals

CP3B "400" 400 Amp Series



CP3B1411JB22

Typical Applications

Remote site service for residential and commercial job sites

Milbank's 400 Amp Commercial Pedestal is designed to provide a weather and vandal resistant metered enclosure for various loads and distribution. Each pedestal has been designed to handle a wide range of applications using standard, stocked configurations.

- Choice of a single main breaker or twin service disconnect breakers gives flexibility to the pedestal design.
- Optional distribution with feed-thru lugs below the service disconnect breakers allows the pedestal to handle numerous applications.
- Typical applications include remote homes where the metering is best located at the curb side or other remote area. The pedestal can also provide power to secondary residence, on-site business, workshop, irrigation, lighting, security or other secondary load.
- Available in custom colors to match home or landscaping.

Features

These units include everything required for remote service:

- Type 3R construction
- Main circuit breaker or dual service disconnects
- Expandable: load center units allow for future expansion without costly modifications
- Optional mounting base can be embedded in concrete for fast, easy installation
- Separate sealable and lockable utility termination section with lug termination
- Separate sealable and lockable metering section
- A separate sealable and lockable customer section with a circuit directory and a print pocket to hold all documentation
- Meter socket options include ring type with bypass studs, ringless with heavy duty lever bypass, or K-Type bolt-on

Standard Pedestals	Optional fifth Terminal Kit	Main CB	Load Center Circuits	Meter Socket Type
CP3B54120B22	K3865	2-200 amp	(2) 12 circuit	Ringless with lever bypass
CP3B5411JB22	K3865	320 amp (400 max)	0	Ringless with lever bypass

Notes

- Chart shows standard, stocked items. Other options and features are available. Contact factory for options, details and availability.
- Stud utility landing is standard. Lug kits are available from factory.
- Units with load centers have (2) #6-250 sub-feed lugs on each load center. (Each load center is 200 amp rated and UL Listed with: Siemens, General Electric and Cutler-Hammer plug-in style circuit breakers.)

Please consult serving utility for their requirements prior to ordering or installing, as specifications and approvals vary by utility, and may require local electrical inspector approval. All installations must be installed by a licensed electrician and must comply with all national and local codes, laws and regulations. Milbank reserves the right to make changes in specifications and features shown without notice or obligation.



Commercial Pedestals

CP3B "IR" Irrigation Control Series



CP3B0281UMWIR04

Milbank's "IR" Series Irrigation Pedestals install quickly and simply – often in less than an hour with a single technician – a fraction of the time typically needed for strut farm and other installation set ups. Additionally, the pedestal comes pre-wired, so the technician simply drops in the pre-drilled concrete box pad, fastens the pedestal and runs the wires. Prewired landing lugs are provided in a separate utility side so that there is no more need to wrestle with hard-to-bend wires. Simply run the utility wire up and land on the lugs. With both the motor starter and disconnect in the same enclosure, all the controls are housed in a safe, lockable pedestal that protects against vandalism and energy theft.

Features

- 3Ø4W, 480Y/277 volt
- One technician can install in under an hour with use of Milbank's pre-drilled box pad
- All units are UL listed and service entrance rated
- Fused disconnect with accessible handle through the deadfront
- HOA and push button start
- Separate accessible utility side with pre-wired landing lugs
- NEMA rated starters (sizes 1-5)
- Soft start units sizes 30HP-150HP
- 30 amp fuse block for pivot pre-wired in the unit
- White powder coated paint finish helps keep components cooler
 - Options include:
 - Hour meter
 - Chemical injection receptacle
 - Multiple injection receptacle
 - Multiple 30A fuse blocks possible

Typical Applications

Power pedestal for irrigation systems or other pump control applications

Stocked Pedestals	Exterior Cabinet	NEMA Rating
CP3B0281UMWIR04	White	4
CP3B0281UMWIR03	White	3
CP3B0181UMWIR02	White	2

Notes

- Chart shows standard, stocked items. Other options and features are available. Contact factory for options, details and availability.



Please consult serving utility for their requirements prior to ordering or installing, as specifications and approvals vary by utility, and may require local electrical inspector approval. All installations must be installed by a licensed electrician and must comply with all national and local codes, laws and regulations. Milbank reserves the right to make changes in specifications and features shown without notice or obligation.

Commercial Pedestals

CP3B "BBS" Battery Backup Series



CP3B5111TCAWSP1

Typical Applications

Metered emergency uninterrupted power for traffic intersections, wireless, phone and communications equipment, parking lots, camera and security locations

Milbank's BBS Series Commercial Pedestals are designed to provide battery backup power for various loads, and to switch specific loads on and off under certain conditions; a photoelectric cell or time clock to control lighting circuits, as an example. Metered and non-metered power distribution options are available. The back-up power pedestal is designed to handle the vast majority of today's back-up power requirements. By using 19" rack design, shelves can be adjusted to accommodate the required batteries and manufactures DC to AC inverters, transfer switches and other related equipment. This design gives the user a wide range of design and configuration options. Complete turnkey, ready to power-up pedestals are offered along with basic units ready to accept batteries and inverters supplied by others.

Features

- Type 3R construction
- 100 through 320 amp meter socket with the option of either a ring type socket (conforms to EUSERC 308) with or without test / bypass blocks or a heavy duty ringless socket with lever bypass
- Separate sealable utility termination compartment
- An isolated separate customer section with service disconnects, power distribution options and power control
- 19" wide rack in customer compartment for easy layout of equipment
- Battery trays
- Thermostat with cooling fan
- Filtered louvers for heat rise flow through ventilation
- Three point door latch (key or pad lockable)

Options

- Manual bypass switch
- Transfer switch for generator power back-up
- Generator inlet receptacles 30A through 200A
- Pad lockable provision for receptacles
- Police access door
- Metered load center distribution
- Non metered load center distribution
- Photo electric controls (for street lighting)
- Time clocks
- HOA switches
- Contactors
- GFI duplex receptacles
- Thermostat for heating control
- Heating pads or elements
- Roll out shelves for batteries
- Surge arrestors and lighting arrestors

Please consult serving utility for their requirements prior to ordering or installing, as specifications and approvals vary by utility, and may require local electrical inspector approval. All installations must be installed by a licensed electrician and must comply with all national and local codes, laws and regulations. Milbank reserves the right to make changes in specifications and features shown without notice or obligation.



Commercial Pedestals

CP3B "Power Transfer" Series



Milbank's Power Transfer Series Pedestals provide non metered AC power, distribution, surge suppression, mechanical interlock and stand-by generator receptacle all in a neat, compact pedestal.

Features

- 120/240V 1Ø3W thru 277/480V 3Ø4W ratings
- Metered or unmetered units
- Choice of EUSERC ring type or ringless meter sockets
- 60 Amp thru 400 amp ratings
- UL Listed Type 3R rated
- Pad lockable, isolated utility compartments
- 20 amp GFI convenience receptacle
- Lockable recessed generator receptacle door
- Utility and generator indicator light options
- All stainless steel hardware
- Galvanized steel, aluminum or stainless steel cabinet options
- Custom designs available



Typical Applications

Traffic intersections, cell sites, cable TV, pump and lift stations requiring utility power with backup generator power



Please consult serving utility for their requirements prior to ordering or installing, as specifications and approvals vary by utility, and may require local electrical inspector approval. All installations must be installed by a licensed electrician and must comply with all national and local codes, laws and regulations. Milbank reserves the right to make changes in specifications and features shown without notice or obligation.

Commercial Pedestals

CP3BB "CT Metered" Series

63
COMMERCIAL
PEDESTALS



Milbank's CT Metered Series

Commercial Pedestals are designed to be used where a smaller service package would be a better choice over large 3R rated combination switchboards. These pedestals have amperage ratings of 400 to 800 amp at voltages up through 480 volt three phase.

Features

- UL Listed, freestanding Type 3R service
- A low profile CT pedestal
- All utility equipment is isolated in separated pad lockable and sealable compartments
- Separate customer compartment designed to hold distribution and control equipment
- Dead front customer construction
- Optional mounting base
- Optional construction in steel, aluminum and stainless steel.
- Wide choice of powder paint colors

Typical Applications

Large homes, pumping and lift stations, motor control, water treatment plants, EV charging stations, commercial buildings, large remote service requirements, commercial and industrial control systems

Please consult serving utility for their requirements prior to ordering or installing, as specifications and approvals vary by utility, and may require local electrical inspector approval. All installations must be installed by a licensed electrician and must comply with all national and local codes, laws and regulations. Milbank reserves the right to make changes in specifications and features shown without notice or obligation.



Commercial Pedestals

CP3A "Slimline" Series



Milbank's Slimline Series Commercial Pedestals provide a sleeker, smaller footprint and wireway access on the side of the unit rather than the back, allowing maximum flexibility to place the pedestal in tighter spaces.

Features

- UL Listed as service equipment
- 100 or 200 amp
- Vandal-resistant, secure and attractive design
- Customer compartment with distribution and control equipment with swing dead front door, secured with both a hasp/latch and draw latch outer door
- Utility metering compartment protected with a hinged hood, increasing resistance to meter vandalism
- Small footprint
- Wireway located on left side of pedestal for utility incoming wire, allowing pedestal to be mounted with back very close to a wall (14")
- Available in 12" and 20" widths and 50" and 63" (metered) and 43" (nonmetered) heights
- Includes a print pocket for plans and drawings
- 200 amp main available
- Voltage range: 120V–480V
- Compatible with both ringless and ring type meter sockets, 4–7 terminals
- Available in a wide array of colors, including but not limited too all ANSI powder coated paint colors upon request
- Pedestal mounting base option saves time and labor to install on a cement pad—no anchor bolts required
- Powder-coated G90 galvanized steel, raw, anodized or powder-coated aluminum and stainless steel exterior options

"Slimline" Series Direct Bury Extension

- No need for concrete
- Bolts directly to unit
- Easy, modular design
- Ships in a smaller package
- Increases project flexibility
- Easier to handle and install
- Utilizes a stabilizer foot to prevent leaning over time
- Pedestal and extension can be installed within 30 minutes

Typical Applications

Roadway lighting and signage, wastewater treatment facilities, parks and landscaping, and any application where physical space is at a premium



Notes

- Currently only built in 14 gauge steel
- Only available for 12" pedestals



Please consult serving utility for their requirements prior to ordering or installing, as specifications and approvals vary by utility, and may require local electrical inspector approval. All installations must be installed by a licensed electrician and must comply with all national and local codes, laws and regulations. Milbank reserves the right to make changes in specifications and features shown without notice or obligation.

Watt-hour Meter Forms

Standard Forms | Transformer Rated or Self-Contained

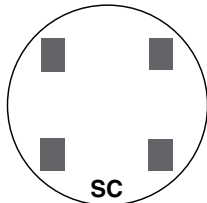

SC
2 and 3-WIRE FORMS
1S & 2S

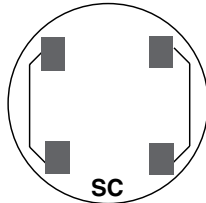

SC
2 and 3-WIRE FORMS
1S & 2S with BYPASS

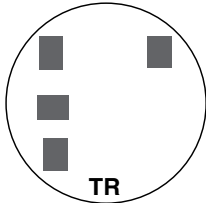

TR
2-WIRE FORM 3S
5th Term. 9 o'clock

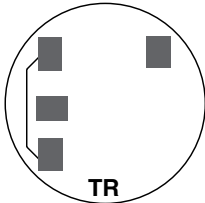

TR
2-WIRE FORM 3S
with BYPASS

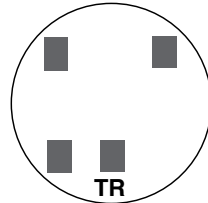

TR
2-WIRE FORM 3S
5th Term. 6 o'clock

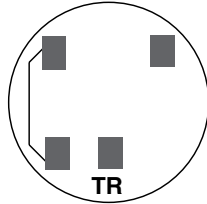

TR
2-WIRE FORM 3S
with BYPASS

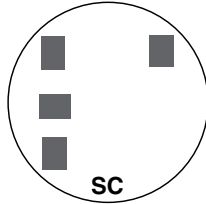

SC
2 ELEMENT
3-WIRE NETWORK
FORM 12S 5th
TERM. 9 o'clock

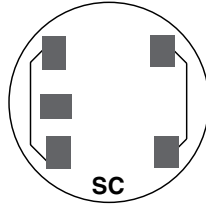

SC
2 ELEMENT 3-WIRE
NETWORK FORM 12S
with BYPASS
5th Term. 9 o'clock

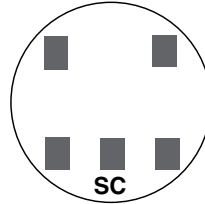

SC
2 ELEMENT
3-WIRE NETWORK
FORM 12S 5th
TERM. 6 o'clock

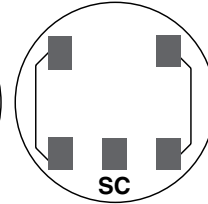

SC
2 ELEMENT 3-WIRE
NETWORK FORM 12S
with BYPASS
5th Term. 6 o'clock

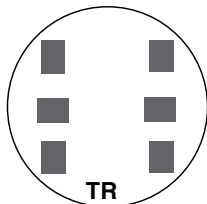

TR
3-WIRE FORM 4S

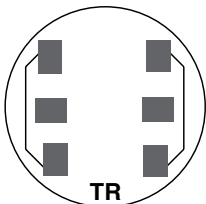

TR
3-WIRE FORM 4S
WITH BYPASS

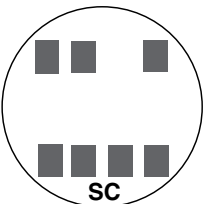

SC
2 or 3 ELEMENT
3Ø4W Y or
Y FORM 14S
FORM 15S
Y FORM 16S

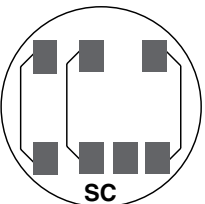

SC
2 or 3 ELEMENT
3Ø4W Y or
FORMS 14S & 15S
with BYPASS

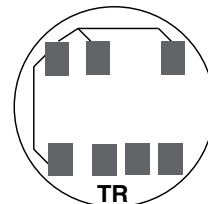

TR
2 ELEMENT
3Ø4W Y or
Y FORM 7S
FORM 24S
with BYPASS

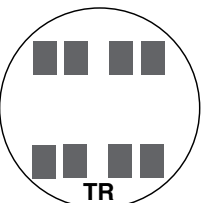

TR
2 ELEMENT
2Ø3W, 2Ø4W, 3Ø3W
FORM 5S

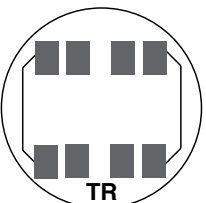

TR
2 ELEMENT 2Ø3W,
2Ø4W, 3Ø3W
FORM 5S with
BYPASS

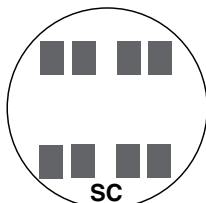

SC
2 ELEMENT
2Ø3W, 2Ø4W, 3Ø3W
FORM 13S

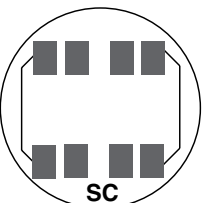

SC
2 or 3 ELEMENT
2Ø3W, 2Ø4W, 3Ø3W
FORM 13S with
BYPASS

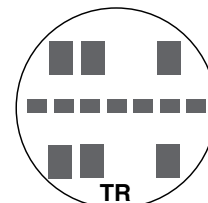

TR
2 or 3 ELEMENT
3Ø4W Y or
Y FORM 9S
FORM 8S

TR = TRANSFORMER RATED
SC = SELF CONTAINED

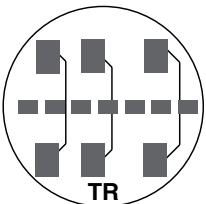

TR
2 or 3 ELEMENT
3Ø4W Y or
FORMS 8S & 9S
FORMS 8S & 9S
with BYPASS

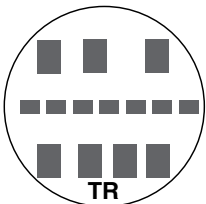

TR
2 ELEMENT
3Ø4W Y
FORM 6S

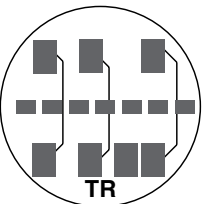

TR
2 ELEMENT
3Ø4W Y
FORM 6S
with BYPASS

Please consult serving utility for their requirements prior to ordering or installing, as specifications and approvals vary by utility, and may require local electrical inspector approval. All installations must be installed by a licensed electrician and must comply with all national and local codes, laws and regulations. Milbank reserves the right to make changes in specifications and features shown without notice or obligation.

DIAGRAM A
1 \emptyset 2W with 1 P.T.'s & 1 C.T.
Single Stator Meter (2W1 \emptyset) - Form 3S
5T Socket, Test Switch #TS04-0101

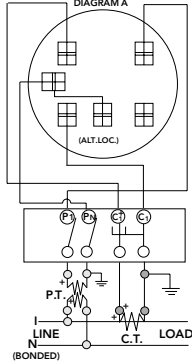

DIAGRAM B
1 \emptyset 3W with 1 C.T.
Single Stator Meter (2W1 \emptyset) - Form 3S
5T Socket, Test Switch #TS04-0101

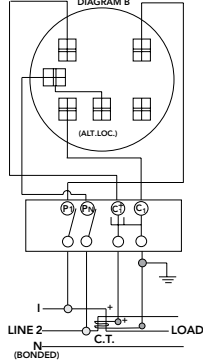

DIAGRAM C
1 \emptyset 3W with 2 C.T.'s
Single Stator Meter (3W1 \emptyset) - Form 4S
6T Socket, Test Switch #TS07-0105

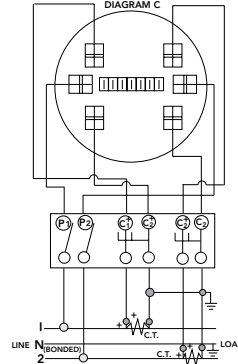

DIAGRAM D
1 \emptyset 3W or 3W Network with 2 C.T.'s
2 Stator Meter - Form 5S
8T Socket, Test Switch #TS07-0105

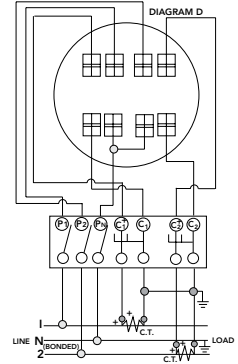

DIAGRAM E
3 \emptyset 3W "A" with 2 P.T.'s & 2 C.T.'s
2 Stator Meter - Form 5S
8T Socket, Test Switch #TS07-0105

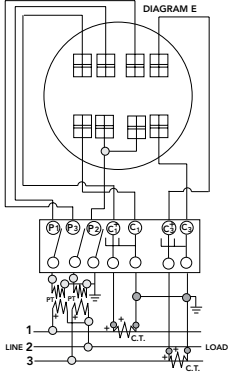

DIAGRAM F
3 \emptyset 3W "A" with 2 C.T.'s
2 Stator Meter - Form 5S
8T Socket, Test Switch #TS07-0105

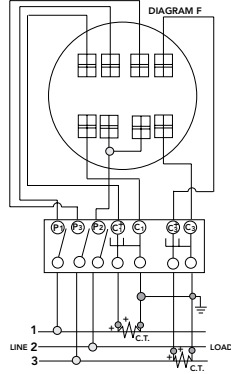

DIAGRAM G
3 \emptyset 4W "Y" with 3 C.T.'s
2 1/2 Stator Meter - Form 6S
13T Socket, Test Switch #TS10-0109

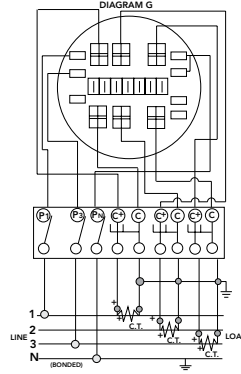

DIAGRAM H
3 \emptyset 4W "Y" with 2 P.T.'s & 3 C.T.'s
2 1/2 Stator Meter - Form 6S
13T Socket, Test Switch #TS10-0109

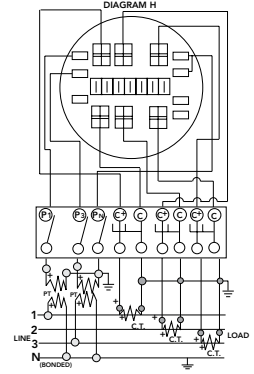

DIAGRAM I
3 \emptyset 4W "Y" or "A" with 3 C.T.'s
"Y" 3 Stator Meter - Form 9S
"A" 2 Stator Meter - Form 8S
13T Socket, Test Switch #TS10-0109

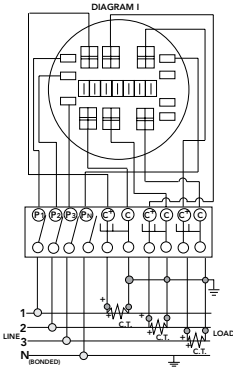
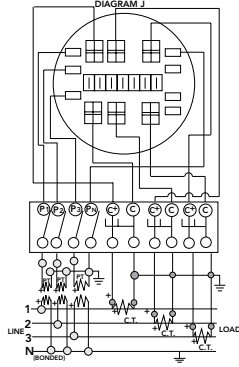

DIAGRAM J
3 \emptyset 4W "Y" with 3 P.T.'s & 3 C.T.'s
3 Stator Meter - Form 9S
13T Socket, Test Switch #TS10-0109



Prewiring: If standard factory prewiring is required, refer to wiring diagrams on this page. Determine appropriate diagram and send a copy with order. If custom factory prewiring is required, specify on order. Be sure to include meter socket catalog number, test switch make and catalog number, meter form number and provide a copy of your wiring diagram.

Conduit, Ampacity & SCCR

Reference Information

MAXIMUM NUMBER OF CONDUCTORS IN CONDUIT

Table from 2008 NEC Code Reference: Rigid Metal Conduit

Type	Conductor Size (AWG/kcmil)	Conduit Trade Sizes (Inches)									
		½	¾	1	1¼	1½	2	2½	3	3½	4
THHN, THWN, THWN-2	12	9	16	26	46	62	102	146	225	301	387
	10	6	10	17	29	39	64	92	142	189	244
	8	3	6	9	16	22	37	53	82	109	140
	6	2	4	4	12	16	27	38	59	79	101
	4	1	2	4	7	10	16	23	36	48	62
	3	1	1	3	6	8	14	20	31	41	53
	2	1	1	3	5	7	11	19	26	34	44
	1	1	1	1	4	5	8	12	19	25	35
	1/0	1	1	1	3	4	7	10	16	21	27
	2/0	0	1	1	2	3	6	8	13	18	23
3/0	0	1	1	1	3	5	7	11	15	19	
4/0	0	1	1	1	2	4	6	9	12	16	
XHH, XHHW, XHHW-2	4	1	2	4	7	10	16	24	37	49	63
	2	1	1	3	5	7	12	17	26	35	45
	1/0	1	1	1	3	4	7	10	16	22	28
	2/0	0	1	1	2	3	6	9	13	18	23
	4/0	0	1	1	1	2	4	6	9	12	16
	250	0	0	1	1	1	3	5	7	10	13
	350	0	0	1	1	1	2	3	6	7	10
	500	0	0	0	1	1	1	2	4	5	7
750	0	0	0	0	1	1	1	3	4	5	

This table is for concentric stranded conductors only. For cables with compact conductors refer to NEC. Refer to latest NEC Code or Local Codes for updated requirements.

* ALLOWABLE AMPACITIES OF INSULATED COPPER & ** ALUMINUM CONDUCTORS (3W IN CONDUIT) 75°C (167°F)

*CU		AL or **Cu-Clad AL	
A	B	A	C
18	-	-	-
16	-	-	-
14	20†	-	-
12	25†	12	20†
10	35†	10	30†
8	50	8	40
6	65	6	50
4	85	4	65
3	100	3	75
2	115	2	90
1	130	1	100
1/0	150	1/0	120
2/0	175	2/0	135
3/0	200	3/0	155
4/0	230	4/0	180
250	255	250	205
300	285	300	230
350	310	350	250
400	335	400	270
500	380	500	310
600	420	600	340
700	460	700	375
750	475	750	385

A = Size: AWG/MCM
 *B = Ampere Rating for Insulation Types:
FEPW, RH, RHW, THW, THWN, XHHW, USE, 2W.
 **C = Ampere Rating for Insulation Types:
RH, RHW, THW, THWN, XHHW, USE
 (Per NEC table 310-16)

AMPACITY CORRECTION FACTORS

AMBIENT TEMP.°C	CORRECTION FACTOR	AMBIENT TEMP.°F
21 - 25	1.05	70 - 77
26 - 30	1.00	78 - 86
31 - 35	.94	87 - 95
36 - 40	.88	96 - 104
41 - 45	.82	105 - 113
46 - 50	.75	114 - 122
51 - 55	.67	123 - 131
56 - 60	.58	132 - 140
61 - 65	.33	141 - 158

Overall ampere ratings of U/L listed Milbank multiple position meter sockets are based on 2008 N.E.C. Handbook Article 220-84 and ANSI / UL-414 (except where restricted by line connector size.) These requirements provide for a diversity factor / demand factor being utilized in determining the overall (main bus / lug) rating of a gang socket. All Milbank U/L listed gang sockets meet or exceed these diversity factor/demand factor requirements. Standard overall ampacity ratings for U/L listed and non U/L listed gang sockets are as shown in the chart below. Ampere ratings of meter sockets are based on the meter socket being wired with 75° C insulated wire conductor, sized in accordance with Table 310-16 of the National Electric Code.

GANG SOCKET OVERALL AMPACITIES

NO. OF METER POSITIONS	100A / POS. AMPACITY	125A / POS. AMPACITY	150A / POS. AMPACITY	200A / POS. AMPACITY
2	200A	200A	200A	200A #
3	200A	225A	225A	270A
4	200A	250A	270A	360A
5	225A	285A	338A	450A
6	270A	330A	396A	528A

† Unless otherwise permitted elsewhere in the Code, the overcurrent protection for conductor types marked with an obelisk (†) shall not exceed 15 amps for 14 AWG, 20 amps for 12 AWG, and 30 amps for 10 AWG copper; or 15 amps for 12 AWG and 25 amps for 10 AWG aluminum and copper-clad aluminum after any correction factors for ambient temperature and number of conductors have been applied.

Some constructions are rated at 400 amps overall. Contact your sales representative for more information. Refer to latest NEC Code or Local Codes for updated requirements.

Please consult serving utility for their requirements prior to ordering or installing, as specifications and approvals vary by utility, and may require local electrical inspector approval. All installations must be installed by a licensed electrician and must comply with all national and local codes, laws and regulations. Milbank reserves the right to make changes in specifications and features shown without notice or obligation.



MILBANK
ENERGY AT WORK

Important Note

In addition to national and local electrical codes, many utilities have specific requirements for metering equipment. Always consult the serving utility for their specifications and requirements prior to ordering or installing Milbank meter mounting equipment.

Before Energizing

1. Give equipment a thorough visual examination to determine that:
 - A. No shipping or installation damage exists.
 - B. Proper clearances have been maintained.
 - C. All connections have been made.
 - D. Equipment is clean and dry.
2. Make a thorough examination to:
 - A. Verify tightness of all bolted connections (see table below).
 - B. Manually operate all circuit breakers, switches, relays, etc.
 - C. Check rigidity of all mountings, bus bars and components.
 - D. Use test equipment to check continuity of circuitry and integrity of insulation.
3. All switches and circuit breakers should be in the "off" position.
4. Verify that manual meter bypass (if applicable) is in non-bypass position.
5. Install cover and/or close doors.
6. If installation is not being energized at this time, follow "after-energizing" steps listed below. These steps will secure the installation in case of accidental energization.

When Energizing

Use caution and follow established safety procedures:

- 1) Wear safety apparel.
- 2) Use safety equipment.
- 3) Take action to prevent injury to yourself and others in the event of failure of the installation.
- 4) Take action to prevent/decrease damage to property in the event of failure of the installation.
- 5) If you are unsure how to safely energize the installation, get someone who is knowledgeable to do it.

After Energizing

Secure the installation:

- 1) To prevent accidental contact with energized parts, cover all openings with approved filler devices.
- 2) To prevent unauthorized access, secure all covers and/or doors with approved security devices.
- 3) Attach/post information to advise others of potential hazards associated with the installation.

Recommended Torque for General Applications*

Nominal Size	Joint Description		Head Type	Torque (Inch Lbs.)
	Screw	Nut		
10	Brass	Brass Nut or Extruded Hole	All	20-25 inch lbs.
10	Steel	Copper or Aluminum Busbar $\leq 1/8"$	All	25-30 inch lbs.
10	Steel	Steel Nut or Extruded Hole; CU or AL Busbar $> 1/8"$	All	30-35 inch lbs.
12	Steel	Aluminum Extruded Hole	All	30-35 inch lbs.
12	Steel	Steel Nut or Extruded Hole	All	40-50 inch lbs.
1/4	Steel	Aluminum Extruded Hole	All	40-50 inch lbs.
1/4	Steel	Steel Nut or Extruded Hole; CU or AL Busbar	All	50-60 inch lbs.
5/16	Steel	Aluminum Extruded Hole	Hex	60-70 inch lbs.
5/16	Steel	Steel Nut or Extruded Hole; CU or AL Busbar	Hex	100-150 inch lbs.
3/8	Steel	Steel Nut	Hex	150-200 inch lbs.
1/2	Steel	Steel Nut	Hex	200-250 inch lbs.

* Interior labels typically indicate the required torque for wire connectors and studs, and should be referenced first.
CU: Copper
AL: Aluminum



Please consult serving utility for their requirements prior to ordering or installing, as specifications and approvals vary by utility, and may require local electrical inspector approval. All installations must be installed by a licensed electrician and must comply with all national and local codes, laws and regulations. Milbank reserves the right to make changes in specifications and features shown without notice or obligation.

Materials & Finishes

Reference Information

Materials

Steel Quality

The meter equipment listed in this catalog is made of galvanized steel (AISI* G90) to afford the best possible weather proofing.
*American Iron and Steel Institute.

Steel Sheet

16 gauge, galvanized, sheet: 1 1/4 oz./ sq.ft. class zinc-coated. (AISI G90)
14 gauge, galvanized, sheet: 1 1/4 oz./ sq.ft. class zinc-coated.

Aluminum Extrusion

Wire-Terminals: Alloy; 6061-T6, Tin-plated for CU/AL wire.
Bus Bar: Alloy; 6101-O & 6063-O

Aluminum Sheet

3000 series aluminum sheet, H14, or 5052 series aluminum sheet, H32. Where applicable thicknesses range from .064-.125

Copper Sheet & Bus

Electrolytic copper with tin plating in most applications.

Insulating Materials

- In most units, support bases for current-carrying components are molded from fiberglass reinforced high-strength, track resistant, thermoset polyester molding compounds.
- Clear or black safety shields and polarity barriers are molded from high-strength, track resistant, polycarbonate molding compounds.
- Various sheet insulating materials, as appropriate for the application are utilized in the fabrication of flat, formed and punched component parts and barriers.

Finish

Process

Light gray state-of-the-art electrostatically applied powder paint offers a durable, non-fading finish. For further information concerning the chemical analysis of the weather resistant finish, please contact the factory.

Metal Fasteners

Zinc-coated with a chromate dip.

Ratings & Compliance

Ratings & Compliance

All Milbank electrical enclosures in this catalog are rated "Type 3R Enclosure" unless specified otherwise on the product's page. All enclosures with a UL designation are constructed per the appropriate UL Standard and may be installed per the National Electric Code. UL procedure files associated with the UL Standards are listed as follows: Meter Sockets (UL 414, File E30202), Test Switches (UL 414, File E62531), Power Outlets (UL 231, File E90945), Panelboards (UL 67, File E32628) and Pullout Switches (UL 1429, File E133062). Additional standards are utilized as applicable: Meter Sockets (ANSI C12.7), Test Switches (ANSI C12.9) and Panelboards (NEMA PB-1).

Please consult serving utility for their requirements prior to ordering or installing, as specifications and approvals vary by utility, and may require local electrical inspector approval. All installations must be installed by a licensed electrician and must comply with all national and local codes, laws and regulations. Milbank reserves the right to make changes in specifications and features shown without notice or obligation.



850.....	53	Q135.....	51	TS04-0101.....	42
6002.....	53	Q135H.....	51	TS04-0102.....	42
6003.....	53	Q140.....	51	TS04-0103.....	42
6116.....	53	Q140H.....	51	TS04-0104.....	42
5T8K2.....	54	Q150.....	51	TS07-0018.....	42
A7514.....	52	Q150H.....	51	TS07-0022.....	42
A7515.....	52	Q160.....	51	TS07-0049.....	42
A7516.....	52	Q160H.....	51	TS07-0059.....	42
A7517.....	52	Q170.....	51	TS07-0105.....	42
A7518.....	52	Q170H.....	51	TS07-0106.....	42
A7551.....	52	Q2100.....	51	TS07-0107.....	42
A8110.....	52	Q2100H.....	51	TS07-0108.....	42
A8111.....	52	Q2125.....	51	TS10-0109.....	42
A8112.....	52	Q2125H.....	51	TS10-0110.....	42
A9064.....	52	Q215.....	51	TS10-0111.....	42
BL7474.....	54	Q215H.....	51	TS10-0112.....	42
CP-21.....	53	Q220.....	51	U1252-X-K1.....	29
K1047.....	53	Q220H.....	51	U1253-X-K3.....	29
K1190.....	54	Q225.....	51	U1254-X-K3.....	29
K1190.....	54	Q225H.....	51	U1255-X-K4.....	29
K1350.....	36	Q230.....	51	U1256-X-K4.....	29
K1350.....	53	Q230H.....	51	U1780-O.....	26
K1350L.....	53	Q235.....	51	U1855-O-NE.....	43
K1539.....	36	Q235H.....	51	U1856-O-NE.....	43
K1539.....	53	Q240.....	51	U1980-O.....	12
K1540.....	36	Q240H.....	51	U2264-XL.....	26
K1540.....	53	Q250.....	51	U2272-RL-5T9-BL.....	13
K1540L.....	53	Q250H.....	51	U2288-X.....	37
K1541.....	36	Q260.....	51	U2448-X.....	18
K1541.....	53	Q260H.....	51	U2594-X.....	19
K3082.....	53	Q270.....	51	U2601-XL.....	28
K3083.....	53	Q270H.....	51	U2692-XL.....	26
K3356.....	54	Q280.....	51	U2693-XL.....	26
K3441.....	53	Q280H.....	51	U2732-XT.....	34
K3442.....	53	Q290.....	51	U2733-XT.....	34
K3865.....	54	Q290H.....	51	U2734-XT.....	34
K3866.....	54	QN2150.....	51	U2735-XT.....	34
K4527.....	54	QN2150H.....	51	U2736-XT.....	34
K4528.....	54	QN2150R.....	51	U2752-X-5T9.....	32
K4977-EXT.....	54	QN2150RH.....	51	U2753-X-5T9.....	32
K4977-INT.....	54	QN2200.....	51	U2754-X-5T9.....	32
K5022-INT.....	54	QN2200H.....	51	U2755-X-5T9.....	32
K5T.....	54	QN2200R.....	51	U2756-X-5T9.....	32
M5-144.....	53	QN2200RH.....	51	U2852-X.....	36
Q115.....	51	-R.....	52	U2852-X.....	37
Q115H.....	51	-RL.....	52	U2853-X.....	36
Q120.....	51	S1857.....	44	U2853-X.....	37
Q120H.....	51	S2718-FB-XL-C.....	45	U2854-X.....	36
Q125.....	51	S3176-O.....	46	U2854-X.....	37
Q125H.....	51	S3390-FB-XL-C7.....	45	U2855-X.....	36
Q130.....	51	S4098-O.....	46	U2855-X.....	37
Q130H.....	51	S8324.....	52	U2856-X.....	36



Please consult serving utility for their requirements prior to ordering or installing, as specifications and approvals vary by utility, and may require local electrical inspector approval. All installations must be installed by a licensed electrician and must comply with all national and local codes, laws and regulations. Milbank reserves the right to make changes in specifications and features shown without notice or obligation.

U2856-X.....	37	U4910-O-BL.....	17	UC7478-O-81-NOE.....	41
U2860-XL-5T9-QG.....	13	U4911-X-BL.....	19	UC7532-XL.....	40
U2862-X.....	36	U5101-XL-11GR*.....	49	UC7544-RL.....	39
U2862-X.....	37	U5112-X-5T9-BL.....	31	UC7545-RL.....	39
U2863-X.....	36	U5113-X-5T9-BL.....	31	UQFB-100.....	50
U2863-X.....	37	U5140-RXL-200-BL.....	21	UQFB-100-X1.....	50
U2864-X.....	36	U5168-XTL-100-BL-NE.....	22	UQFB-125.....	50
U2864-X.....	37	U5168-XTL-200-BL-NE.....	22	UQFB-125-X1.....	50
U2865-X.....	36	U5750-RXL-200-BL.....	23	UQFB-150.....	50
U2865-X.....	37	U5757-O-200.....	20	UQFB-150-X1.....	50
U2866-X.....	36	U5767-X-200-CB-BL.....	25	UQFB-175.....	50
U2866-X.....	37	U5777-O.....	12	UQFB-175-X1.....	50
U2872-XT-5T9.....	33	U5787-O-200-CB.....	25	UQFB-200.....	50
U2873-XT-5T9.....	33	U5796-X-400-CB-BL.....	25	UQFB-200-X1.....	50
U2874-XT-5T9.....	33	U5799-O-400-CB-BL.....	25	UQFBH-100.....	50
U2875-XT-5T9.....	33	U5871-XL-200-BL.....	23	UQFBH-125.....	50
U2876-XT-5T9.....	33	U5898-O-200-BL.....	22	UQFBH-150.....	50
U3499-XL-100.....	20	U5934-XL-BLG.....	9	UQFBH-175.....	50
U3727-O.....	47	U6123-X-BL.....	35	UQFBH-200.....	50
U3730-O.....	47	U6124-X-BL.....	35	UQFBH-M-100.....	50
U3741-XL-100-BL.....	21	U6125-X-BL.....	35	UQFBH-M-125.....	50
U3763-XL.....	30	U7021-RL-TG.....	11	UQFBH-M-150.....	50
U3764-XL.....	30	U7040-O-TG.....	11	UQFBH-M-175.....	50
U3765-XL.....	30	U7040-XL-TG.....	11	UQFBH-M-200.....	50
U3771-XL-100-BL.....	23	U7362-DL.....	27	UQFP-100.....	50
U3784-RL.....	22	U7363-DL.....	27	UQFP-125.....	50
U3791N-RXL-200-BL.....	21	U7364-DL.....	27	UQFP-150.....	50
U3798-O-200.....	20	U7365-DL.....	27	UQFP-175.....	50
U3802.....	6	U7366-DL.....	27	UQFP-200.....	50
U3812.....	6	U7487-O-TG.....	10	UQFPH-100.....	50
U3822-20GWR.....	7	U7487-RL-TG.....	10	UQFPH-125.....	50
U3832.....	6	U7487-YL-TG.....	10	UQFPH-150.....	50
U3862.....	6	U7573-RL.....	13	UQFPH-175.....	50
U3924-XL.....	14	U8212-XL.....	28	UQFPH-200.....	50
U3989-XL-100.....	20	U8213-XL.....	28	UQFPH-M-100.....	50
U3990-XL-150.....	20	U8214-XL.....	28	UQFPH-M-125.....	50
U3990-XL-200.....	20	U8215-XL.....	28	UQFPH-M-150.....	50
U3995-XL-200.....	23	U8216-XL.....	28	UQFPH-M-175.....	50
U4031-O-2/200.....	24	U9318-RL.....	15	UQFPH-M-200.....	50
U4322-O-BL.....	48	U9319-XL.....	15	UQFP-M-100.....	50
U4323-O-BL.....	48	U9550-RRL-QG.....	16	UQFP-M-125.....	50
U4372-XT-5T9.....	38	U9551-RXL-QG.....	16	UQFP-M-150.....	50
U4373-XT-5T9.....	38	U9700-RRL-QG-BL.....	17	UQFP-M-175.....	50
U4374-XT-5T9.....	38	U9701-RXL-QG.....	17	UQFP-M-200.....	50
U4375-XT-5T9.....	38	U9800-RRL-QG-BL-NE.....	14	WBJ2150.....	51
U4376-XT-5T9.....	38	U9801-RXL-QG.....	14	WBJ2200.....	51
U4413-O-BL.....	12	UC1299-XL.....	39	Z802965-AC.....	54
U4611-X.....	19	UC4964-O-WC-21-NST.....	41	Z814898-AC.....	54
U4721-O-BL.....	14	UC4965-O-WC-21-NST.....	41	Z901925-AC.....	54
U4778-X-BL.....	18	UC4966-O-WC-21-NST.....	41	Z904486-AO.....	54
U4835-X-2/200-BL.....	24	UC7444-O-141-NOE.....	41	Z916264-AO.....	54
U4881-O-50GB.....	8	UC7445-O-311-NOE.....	41	Z916265-AO.....	54
U4881-O-60GB.....	8	UC7448-XL.....	40		
U4908-O-11GR*.....	49	UC7449-XL.....	40		

Please consult serving utility for their requirements prior to ordering or installing, as specifications and approvals vary by utility, and may require local electrical inspector approval. All installations must be installed by a licensed electrician and must comply with all national and local codes, laws and regulations. Milbank reserves the right to make changes in specifications and features shown without notice or obligation.



MILBANK
ENERGY AT WORK

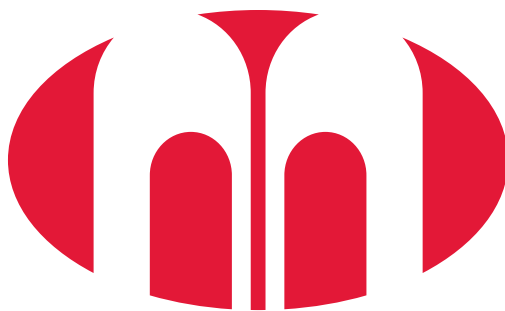

MILBANK[®]

ENERGY AT WORK

HOLBROOK-ASSOCIATED

Electrical Manufacturer's Representatives

35 Reservoir Park Drive, Rockland, MA 02370

p: 781.871.0011

1.800.322.9641 (*New England Area Only*)

f: 781.871.2956

holbrook-associated.com

