

MILBANK[®]
ENERGY AT WORK



Upper Midwest Catalog

Meter Mounting Equipment



Milbank Overview

Energy At Work since 1927

Milbank designs and manufactures electrical solutions that move and manage power for the residential, commercial, industrial, utility and transportation sectors. With 90 years of expertise in electrical engineering design and manufacturing, Milbank's portfolio includes metering equipment, enclosures and enclosed controls. Founded in 1927, Milbank is a family-owned, American manufacturer headquartered in Kansas City, Mo. For more information, please visit milbankworks.com.



METERING

As a market leader in electrical metering equipment, Milbank has set the standard for quality since 1927. Hundreds of configurations are available, including many sizes, knockout configurations, terminal configurations, bypass options, hubs, locks and connectors. Milbank has the socket you need with thousands of active products to meet your utility's requirements.



ENCLOSURES

Milbank's line of enclosures include commercial junction boxes, panel mount enclosures, transformer cabinets, wireway, trough and industrial panel mount and push-button enclosures. Built with high-quality craftsmanship and materials which meet or exceed industry standards, Milbank enclosures are made to protect controls and equipment from dust, dirt and other harmful elements found in a wide variety of environments.



ENCLOSED CONTROLS

Milbank doesn't just build empty enclosures. We can deliver the entire package, complete with custom control equipment built to your exact specifications by our engineers. Milbank commercial pedestals are an attractive, secure, easy to install and cost-effective solution when underground remote site power distribution and control equipment is required, replacing unsightly and inefficient strut and backboard structures.



Please consult serving utility for their requirements prior to ordering or installing, as specifications and approvals vary by utility, and may require local electrical inspector approval. All installations must be installed by a licensed electrician and must comply with all national and local codes, laws and regulations. Milbank reserves the right to make changes in specifications and features shown without notice or obligation.

Table of Contents

Air Conditioner Disconnects

30-60 amp AC disconnects	5
60 amp AC disconnect with 20 amp GFCI receptacle	6
Hot tub disconnects	7

Single Position Sockets

100-125 amp, 4 terminal, ringless	8
200 amp, 4 terminal, ringless	9
200 amp, 4 terminal, ringless, side wireway	10
125 & 200 amp, 7 terminal, medium duty	11

Single Position with Lever Bypass

200 amp, 4 & 5 terminal, ringless, medium duty	12
200 amp, 4 terminal, ringless	13
200 amp, 5 terminal, ringless	14
200 amp, 7 terminal, ringless	15
320 amp, 4 terminal, ringless	16
320 amp, 5 terminal, ringless	17
320 amp, 7 terminal, ringless	18

Meter Mains

100-200 amps, 4 terminal, ringless	19-21
------------------------------------------	-------

Meter Mains with Load Center

100-200 amps, 4 & 5 terminal, ringless	22
----------------------------------------------	----

Meter Mains with Lever Bypass

100-200 amp, 4, 5, & 7 terminal, ringless	23-24
200 amp, 5 terminal, ringless	25
320 amp, 4 & 5 terminal, ringless	26-27

Cold Sequence

200 amp, 4, 5, & 7 terminal, ringless	28
---------------------------------------------	----

Multi-Position Sockets

100 amp, 4 terminal, ringless	29-31
200 amp, 4 & 5 terminal, ringless	32-33
200 amp, 7 terminal, ringless, lever bypass	34
125 & 200 amp, 4 terminal, ringless	35-36
125 & 200 amp, 4 terminal, ringless	37-38

Please consult serving utility for their requirements prior to ordering or installing, as specifications and approvals vary by utility, and may require local electrical inspector approval. All installations must be installed by a licensed electrician and must comply with all national and local codes, laws and regulations. Milbank reserves the right to make changes in specifications and features shown without notice or obligation.



Multi-Position Meter Mains

200 amp, 5 terminal, ringless.....	39
200 amp, 4 & 5 terminal, ringless, demand side management.....	40
200 amp, 5 terminal, ringless, lever bypass	41

Temporary Power

125 amp, surface mount power outlet, lever bypass.....	42
125 amp, surface mount power outlet, unmetered	43
125 amp, surface mount power outlet.....	44

Power Outlet Pedestals

125 amp, unmetered power outlet pedestal.....	45
125 amp, metered power outlet pedestal.....	46
Replacement Parts.....	47

Meter Mains with Pedestals

200 amp, 4 terminal, ringless, with load center.....	48
200 amp, 5 & 7 terminal, ringless	49
200 amp, 4 & 5 terminal, ringless, lever bypass, with load center.....	50
200 amp, 5 terminal, ringless, lever bypass.....	51
200 amp, 4 terminal, ringless, lever bypass.....	52

Residential Pedestal

320 amp, 5 terminal, lever bypass.....	53
----------------------------------------	----

Transformer Rated

20 amp, 5 terminal, with bypass.....	54
20 & 80 amp, 6, 8 & 13 terminal	55
20 amp, 5-15 terminal, ringless	56-59

Miscellaneous

Connector Kits.....	60
Terminal Box.....	61
Multi-position Tap Box.....	62
Commercial Pedestals.....	63-72
Circuit Breakers	73-74
Accessories	75-77
Commercial & Industrial Enclosures.....	78
Reference Information	79-84
Index.....	85



Please consult serving utility for their requirements prior to ordering or installing, as specifications and approvals vary by utility, and may require local electrical inspector approval. All installations must be installed by a licensed electrician and must comply with all national and local codes, laws and regulations. Milbank reserves the right to make changes in specifications and features shown without notice or obligation.

Air Conditioner Disconnects

30-60 Amp | Fusible & Non-Fusible



U3802



U3812



U3832

Milbank's air conditioner disconnect has a removable hinged cover for ease of installation. Our compact design meets NEC wiring space requirements and also complies with NEC article 440-14. For safe working conditions, our disconnect pullers may be removed and reinstalled in the OFF position. Additionally, padlock provisions are included on the front cover. As with other Milbank products, our enclosure is constructed of G90U galvanized steel and electrostatically finished with an attractive, light gray, baked powder coating. Our epoxy/polyester resin blend offers a finish that is both durable and fade-resistant.

30-60 Amp | 1Ø 240 VAC | Air Conditioner Disconnects

Catalog Number	Amp	Type	Max H.P.	Weight (lbs.)	Line/Load Wire Range		Ground Wire Range CU/AL	Dimensions			Wire Rating	
					CU	AL		D"	W"	H"	CU °C	AL °C
U3802	60	Non-Fusible	10	3.25	#14-#2	#12-#2	#14-4	2½	5	7½	60°/75°	60°/75°
U3812	60	Non-Auto	10	3.25	#14-#2	#12-#2	#14-4	2½	5	7½	60°/75°	60°/75°
U3832	30	Fusible	3	2.5	#14-#3	#14-#3	#14-3	2½	5	7	60°/75°	60°/75°
U3862	60	Fusible	10	3.3	#14-#3	#14-#3	#14-3	2½	5	9	60°/75°	60°/75°

Notes

- UL listed as Enclosed Pullout Switch.
- Type 3R rain resistant.
- One-inch concentric knockouts.

Please consult serving utility for their requirements prior to ordering or installing, as specifications and approvals vary by utility, and may require local electrical inspector approval. All installations must be installed by a licensed electrician and must comply with all national and local codes, laws and regulations. Milbank reserves the right to make changes in specifications and features shown without notice or obligation.



Air Conditioner Disconnects

20 Amp GFCI Receptacle



U3822-20GWR

Specifications

- Meets NEC #210.63 requirements
- UL listed as Power Outlet
- Type 3R enclosure
- In-use cover*
- Duplex ground connector
- 1" concentric knockouts
- 1Ø, 240 volt
- 60 amp, non-fused
- 20 amp GFCI receptacle
- Reset/test button
- Weather and tamper resistant
- Meets NEC #406.8 requirements

60 Amp | 1Ø, 240 VAC | Air Conditioner Disconnect with GFCI Receptacle

Catalog Number	Type	Max H.P.	Weight (lbs.)	Line/Load Wire Range		Ground Wire Range CU/AL	Dimensions			Wire Rating	
				CU	AL		D"	W"	H"	CU °C	AL °C
U3822-20GWR	Non-Fusible	10	6	#14-#2	#12-#2	#14-4	4½	5¼	7½	60°/75°	60°/75°

Notes

- **Disconnect Pullers:** To ensure the safest conditions, Milbank disconnect pullers are reversible so they may be reinstalled in the OFF position.
 - **Padlock Provision:** All units are designed with a padlock provision on the cover for security.
- ***In-Use Cover:** Cover is rated as an in-use cover (cover may be closed with cords plugged into receptacle).



Please consult serving utility for their requirements prior to ordering or installing, as specifications and approvals vary by utility, and may require local electrical inspector approval. All installations must be installed by a licensed electrician and must comply with all national and local codes, laws and regulations. Milbank reserves the right to make changes in specifications and features shown without notice or obligation.

Hot Tub Disconnects

Type 3R Enclosures



U4881-O-50GB



U4881-O-60GB

Specifications

- 240 volt ground fault protection
- UL listed, Type 3R rain resistant
- 2-pole, 50 amp GFCI breaker protection
- Compact size
- Three or four wire installation
- 1Ø, 120/240 VAC
- Standard package of 12
- Two extra one-pole breaker spaces
- 100 amp overall rating
- Easy to install

100 Amp | Hot Tub Disconnect or Sub Panel Breaker Enclosure | Type 3R

Catalog Number	Breaker amp	Type	Weight (lbs.)	Line/Load Wire Range		Ground Wire Range CU/AL	Dimensions		
				CU	AL		D"	W"	H"
U4881-O	—	Breaker Provision	7	#14-1/0	#14-1/0	#14-1/0	3¾	7½	8½
U4881-O-50GB	50	Breaker	8	#14-1/0	#14-1/0	#14-1/0	3¾	7½	8½
U4881-O-60GB	60	Breaker	8	#14-1/0	#14-1/0	#14-1/0	3¾	7½	8½

Please consult serving utility for their requirements prior to ordering or installing, as specifications and approvals vary by utility, and may require local electrical inspector approval. All installations must be installed by a licensed electrician and must comply with all national and local codes, laws and regulations. Milbank reserves the right to make changes in specifications and features shown without notice or obligation.



8

100-125 AMP
SINGLE
POSITION

Single Position Sockets

100-125 Amp | 4 Terminal | Ringless | 600 VAC



U5934-XL-BLG

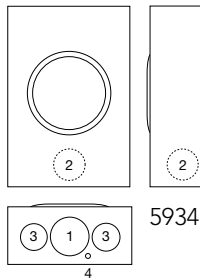

U7487-RL

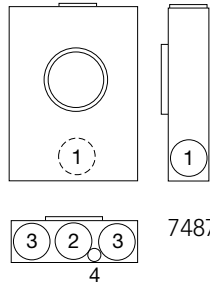

U7588-XL

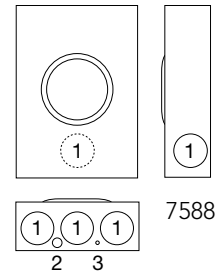

4 Terminal | Single Position | Ringless

Catalog Number	Amp	Service	Hub	Line/Load Wire Range		Bypass	Dimensions			Knockouts			
				CU	AL		D"	W"	H"	1	2	3	4
U7487-RL	125	OH/UG	H.O.	#6-2/0	#6-2/0	None	3 ⁵ / ₁₆	8	11 ¹ / ₂	2	1 ¹ / ₂	1 ¹ / ₄	1 ¹ / ₄
U7487-RL-TG-KK	125	OH/UG	H.O.	#6-2/0	#6-2/0	Horn	3 ⁵ / ₁₆	8	11 ¹ / ₂	2	1 ¹ / ₂	1 ¹ / ₄	1 ¹ / ₄
U7588-XL	125	OH/UG	C.P.	#6-2/0	#6-2/0	None	4 ¹ / ₈	11	15 ¹ / ₂	2 ¹ / ₂	1 ¹ / ₄ , 1 ¹ / ₂	1 ¹ / ₄	—

4 Terminal | Single Position | Ringless | Solar/Alternative Energy

Catalog Number	Amp	Service	Hub	Line/Load Wire Range		Bypass	Dimensions			Knockouts			
				CU	AL		D"	W"	H"	1	2	3	4
U5934-XL-BLG	100	OH/UG	C.P.	#12-1/0	#12-1/0	None	3 ⁵ / ₁₆	8	11 ¹ / ₂	2	1 ¹ / ₂	1 ¹ / ₄	1 ¹ / ₄

Notes

- **Fifth Terminal:** For field mounted fifth terminal, order catalog number **5T8K2**.
- **Hubs:** For the proper hub selection, see the hub suffix chart on the accessories page.
- **Connectors:** Extruded aluminum connectors are tin plated. Units are supplied with duplex neutral. For triplex ground, add suffix **-TG** to the catalog number.
- **Bypass:** Horn bypass is available for the ringless units. Add the suffix **-KK** to the catalog number.
- **Isolated Neutral:** **U5934** includes an isolated neutral option.



Please consult serving utility for their requirements prior to ordering or installing, as specifications and approvals vary by utility, and may require local electrical inspector approval. All installations must be installed by a licensed electrician and must comply with all national and local codes, laws and regulations. Milbank reserves the right to make changes in specifications and features shown without notice or obligation.

Single Position Sockets

200 Amp | 4 Terminal | Ringless | 600 VAC

9
200 AMP
SINGLE
POSITION



U7021-RL-TG



U7040-XL-TG

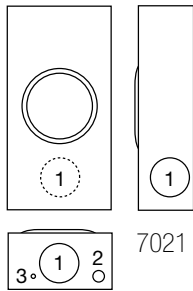

7021

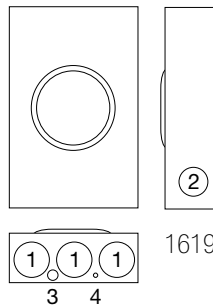

1619

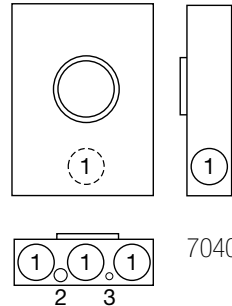

7040

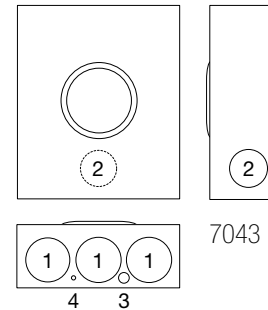

7043

200 Amp | 4 Terminal | Single Position | Ringless

Catalog Number	Service	Hub	Line/Load Wire Range		Dimensions			Knockouts			
			CU	AL	D"	W"	H"	1	2	3	4
U7021-RL-TG	OH	H.O.	#6-350	#6-350	4 $\frac{1}{8}$	8	15 $\frac{1}{2}$	2 $\frac{1}{2}$	$\frac{1}{4}$, $\frac{1}{2}$	$\frac{1}{4}$	—
U7040-0-TG	OH/UG	Blank	#6-350	#6-350	4 $\frac{1}{8}$	11	14 $\frac{5}{8}$	2 $\frac{1}{2}$	$\frac{1}{4}$, $\frac{1}{2}$	$\frac{1}{4}$	—
U7040-XL-TG	OH/UG	C.P.	#6-350	#6-350	4 $\frac{1}{8}$	11	14 $\frac{5}{8}$	2 $\frac{1}{2}$	$\frac{1}{4}$, $\frac{1}{2}$	$\frac{1}{4}$	—
U7043-XL-TG	OH/UG	C.P.	#6-350	#6-350	4 $\frac{7}{8}$	13	15 $\frac{1}{2}$	3	2 $\frac{1}{2}$	$\frac{1}{4}$, $\frac{1}{2}$	$\frac{1}{4}$
S1619-XL*	OH/UG	C.P.	$\frac{3}{8}$ " x 16 Stud	$\frac{3}{8}$ " x 16 Stud	4 $\frac{1}{8}$	11	17	2 $\frac{1}{2}$	2	$\frac{1}{4}$, $\frac{1}{2}$	$\frac{1}{4}$

Notes

- ***S1619-XL:** Non-UL listed. For UL listed units, see other items on this page.
- **Fifth Terminal:** For field mounted fifth terminal, order as extra **5KT**.
- **Hubs:** For the proper hub selection, see the hub suffix chart on the accessory page.
- **Connectors:** Extruded aluminum connectors are tin plated. Units are supplied with duplex neutral. Stud type units supplied with $\frac{3}{8}$ " - 16 hex head nuts with Belleville washers. For connector kits, order as extra **K1539**.
- **Bypass:** Horn bypass is available — add the suffix **-KK** to the catalog number.

Please consult serving utility for their requirements prior to ordering or installing, as specifications and approvals vary by utility, and may require local electrical inspector approval. All installations must be installed by a licensed electrician and must comply with all national and local codes, laws and regulations. Milbank reserves the right to make changes in specifications and features shown without notice or obligation.



Single Position Sockets

200 Amp | 4 Terminal | Side Wireway | Ringless | 600 VAC

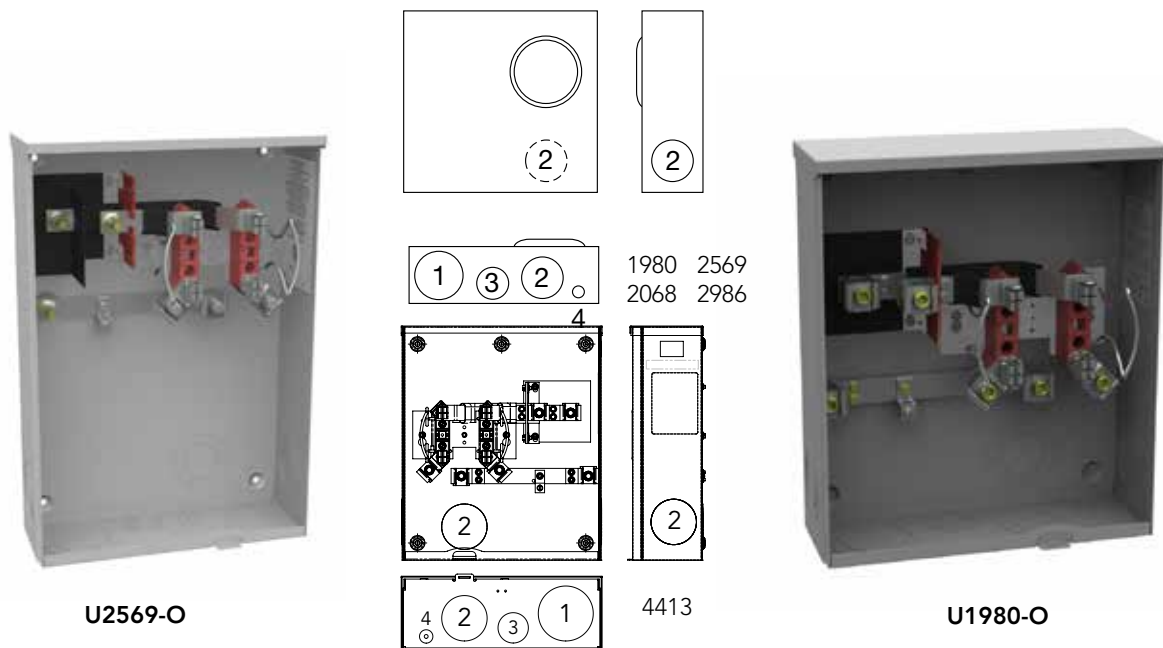

U2569-O

U1980-O

200 Amp | 4 Terminal | Side Wireway | Single Position | Ringless

Catalog Number	Service	Hub	Line/Load Wire Range		Dimensions			Knockouts			
			CU	AL	D"	W"	H"	1	2	3	4
S2068-0*	UG	Blank	3/8" x 16 Stud	#6-350	4 1/2	13	15 1/2	3	2 1/2	1 1/2	1/4, 1/2
U1980-0	UG	Blank	#6-350	#6-350	4 1/2	13	15 1/2	3	2 1/2	1 1/2	1/4, 1/2
U4413-0**	UG	Blank	#6-350	#6-350	4 1/2	13	15 1/2	3	2 1/2	1 1/2	1/4, 1/2
U2569-0	UG	Blank	3/8" x 16 Stud	#6-350	4 1/2	13	19	3	2 1/2	1 1/2	1/4, 1/2
U2986-0	UG	Blank	3/8" x 16 Studs	3/8" x 16 Studs	4 1/2	13	19	3	2 1/2	1 1/2	1/4, 1/2

Notes

- ***S2068-O:** Non-UL listed. For UL listed units, see other items on this page.
- ****U4413-O:** Design is a mirror image of U1980 with a left meter position.
- **Fifth Terminal:** For factory installed fifth terminal in the 9 o'clock position, add suffix **-5T**. For field installed fifth terminal, order catalog number **K5T**.
- **Connectors:** Extruded aluminum connectors are tin plated. Units are supplied with triplex neutral. Stud type units supplied with 3/8"-16 hex head nuts with Belleville washers. For connector kits, order as extra **K1539**.

Single Position Sockets

125 & 200 Amp | 7 Terminal | Ringless | Medium Duty | 600 VAC

1 1
125-200 AMP
SINGLE
POSITION



U3278-RL

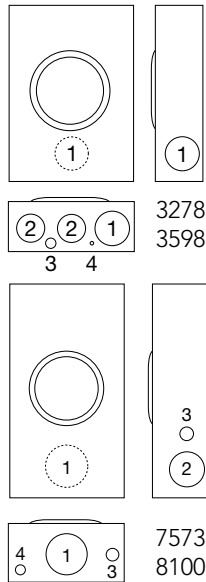

U9320-RRL

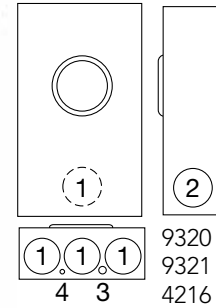

125 Amp | 7 Terminal | Single Position | Medium Duty | Ringless

Catalog Number	Service	Hub	Line/Load Wire Range		Bypass	Dimensions			Knockouts			
			CU	AL		D"	W"	H"	1	2	3	4
U7573-RL	OH	H.O.	#6-2/0	#6-2/0	Lever	4 $\frac{7}{8}$	10	18 $\frac{1}{2}$	2	2	$\frac{3}{4}$	$\frac{1}{4}, \frac{1}{2}$
U8100-RL	OH	H.O.	#6-2/0	#6-2/0	None	4 $\frac{7}{8}$	10	18 $\frac{1}{2}$	2	2	$\frac{3}{4}$	$\frac{1}{4}, \frac{1}{2}$
U9320-RRL	OH/UG	H.O.	#6-2/0	#6-2/0	Lever	4 $\frac{7}{8}$	13	19	3	2 $\frac{1}{2}$	$\frac{1}{4}, \frac{1}{2}$	$\frac{1}{2}$
U9321-RL	OH/UG	H.O.	#6-2/0	#6-2/0	None	4 $\frac{1}{2}$	13	19	3	2 $\frac{1}{2}$	$\frac{1}{4}, \frac{1}{2}$	$\frac{1}{2}$

200 Amp | 4 & 5 Terminal | Single Position | Residential Bypass | Ringless

Catalog Number	Terminals	Service	Hub	Line/Load Wire Range		Bypass	Dimensions			Knockouts			
				CU	AL		D"	W"	H"	1	2	3	4
U3278-RL	4	OH	H.O.	#6-350	#6-350	Lever	4 $\frac{7}{8}$	11	15 $\frac{1}{2}$	2 $\frac{1}{2}$	2	$\frac{1}{4}, \frac{1}{2}$	$\frac{1}{4}$
U3598-RL-TG*	5	OH	H.O.	#6-350	#6-350	Lever	4 $\frac{7}{8}$	11	15 $\frac{1}{2}$	2 $\frac{1}{2}$	2	$\frac{1}{4}, \frac{1}{2}$	$\frac{1}{4}$
U4216-RXL	4	OH/UG	C.P.	#6-350	#6-350	Lever	4 $\frac{7}{8}$	13	19	3	2 $\frac{1}{2}$	$\frac{1}{4}, \frac{1}{2}$	$\frac{1}{4}$

Notes

- **Hubs:** For the proper hub selection, see the hub suffix chart on the accessory page.
- **Connectors:** Units supplied with extruded aluminum connectors and bonded triplex neutral.
- **Bypass:** Lever operates bypass device only — does not provide clamping action on meter spades.

Please consult serving utility for their requirements prior to ordering or installing, as specifications and approvals vary by utility, and may require local electrical inspector approval. All installations must be installed by a licensed electrician and must comply with all national and local codes, laws and regulations. Milbank reserves the right to make changes in specifications and features shown without notice or obligation.



Single Position Lever Bypass

200 Amp | 4 & 5 Terminal | Ringless | 600 VAC

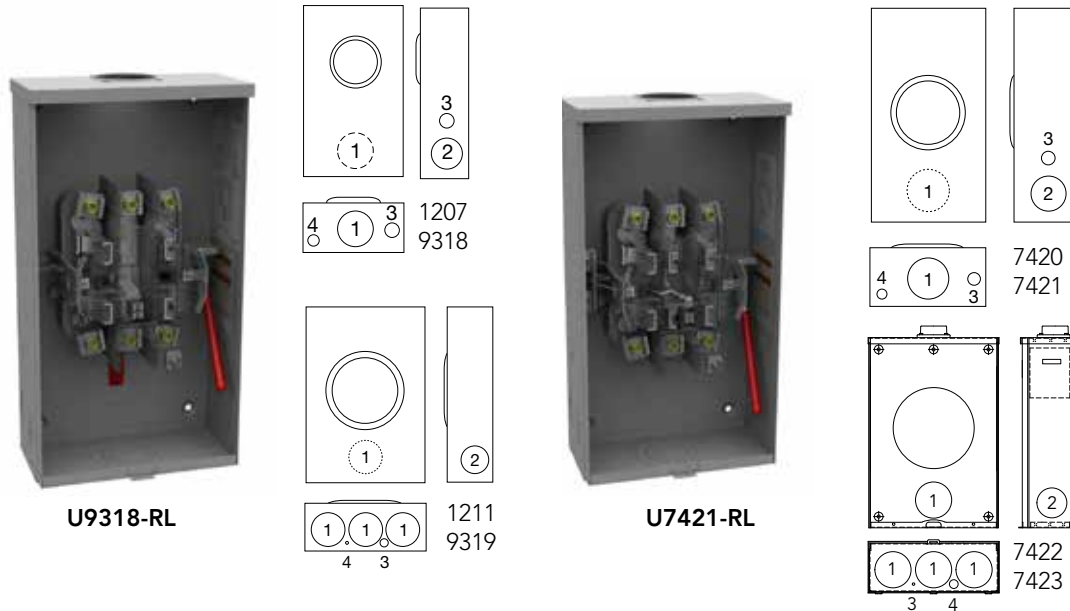

200 Amp | 4 & 5 Terminal | Single Position | Lever Bypass | Ringless

Catalog Number	Terminals	Service	Hub	Line/Load Wire Range		Bypass	Dimensions			Knockouts			
				CU	AL		D"	W"	H"	1	2	3	4
U1207-RL	4	OH	H.O.	#6-350	#6-350	Lever	4 $\frac{7}{8}$	10	18 $\frac{1}{2}$	3	2 $\frac{1}{2}$	$\frac{3}{4}$	$\frac{1}{4}, \frac{1}{2}$
U1211-RXL	4	OH/UG	C.P.	#6-350	#6-350	Lever	4 $\frac{7}{8}$	13	19	3	2 $\frac{1}{2}$	$\frac{1}{4}, \frac{1}{2}$	$\frac{1}{4}$
U9318-RL	5	OH	H.O.	#6-350	#6-350	Lever	4 $\frac{7}{8}$	10	18 $\frac{1}{2}$	3	2 $\frac{1}{2}$	$\frac{3}{4}$	$\frac{1}{4}, \frac{1}{2}$
U9319-RL	5	OH/UG	C.P.	#6-350	#6-350	Lever	4 $\frac{7}{8}$	13	19	3	2 $\frac{1}{2}$	$\frac{1}{4}, \frac{1}{2}$	$\frac{1}{4}$

200 Amp | 7 Terminal | Single Position | Medium Duty | Ringless

Catalog Number	Service	Hub	Line/Load Wire Range		Bypass	Dimensions			Knockouts			
			CU	AL		D"	W"	H"	1	2	3	4
U7420-RL	OH	H.O.	#6-350	#6-350	None	4 $\frac{7}{8}$	10	18 $\frac{1}{2}$	3	2 $\frac{1}{2}$	$\frac{3}{4}$	$\frac{1}{4}, \frac{1}{2}$
U7421-RL	OH	H.O.	#6-350	#6-350	Lever	4 $\frac{7}{8}$	10	18 $\frac{1}{2}$	3	2 $\frac{1}{2}$	$\frac{3}{4}$	$\frac{1}{4}, \frac{1}{2}$
U7422-RXL	OH/UG	C.P.	#6-350	#6-350	None	4 $\frac{7}{8}$	13	19	3	2 $\frac{1}{2}$	$\frac{1}{4}, \frac{1}{2}$	$\frac{1}{2}$
U7423-RXL	OH/UG	C.P.	#6-350	#6-350	Lever	4 $\frac{1}{2}$	13	19	3	2 $\frac{1}{2}$	$\frac{1}{4}, \frac{1}{2}$	$\frac{1}{2}$

Notes

- **Fifth Terminal:** For field-installed fifth terminal, order catalog number **K3356** for **U3278** and **U4216**. Order **K3866** for **U1207** and **U1211**.
- **Hubs:** For the proper hub selection, see the hub suffix chart on the accessory page.
- **Bypass:** Lever operates bypass device only — does not provide clamping action on meter spades.
- **Connectors:** Units are supplied with extruded aluminum connectors and bonded triplex neutral. For field installed insulated neutral in the **U7422** and **U7423** units, order kit number **K1047**.
- ***U3598-RL** is not a stock item.



Please consult serving utility for their requirements prior to ordering or installing, as specifications and approvals vary by utility, and may require local electrical inspector approval. All installations must be installed by a licensed electrician and must comply with all national and local codes, laws and regulations. Milbank reserves the right to make changes in specifications and features shown without notice or obligation.

Single Position Lever Bypass

200 Amp | 4 Terminal | Ringless | 600 VAC

13
200 AMP
SINGLE
POSITION



U4801-XL



U3924-XL



U4721-O-BL

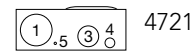
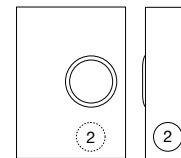
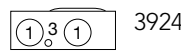
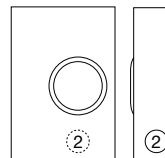
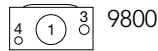
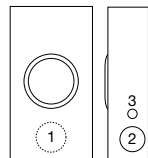
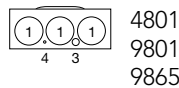
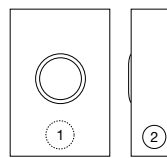

200 Amp | 4 Terminal | Single Position | Lever Bypass | Ringless

Catalog Number	Service	Hub	Line/Load Wire Range		Dimensions			Knockouts			
			CU	AL	D"	W"	H"	1	2	3	4
U9800-RRL**	OH	H.O.	#6-350	#6-350	4 ⁷ / ₈	10	18 ¹ / ₂	2	2	3/4	1/4, 1/2
U4801-XL*	OH/UG	C.P.	#6-350	#6-350	4 ⁷ / ₈	10	18 ¹ / ₂	2	2	3/4	1/4, 1/2
U9801-RXL**	OH/UG	C.P.	#6-350	#6-350	4 ⁷ / ₈	13	19	3	2 ¹ / ₂	1/4, 1/2	1/2
U9865-RRL	OH/UG	H.O.	3/8" x 16 Stud	3/8" x 16 Stud	4 ⁷ / ₈	13	19	3	2 ¹ / ₂	1/4, 1/2	1/2

200 Amp | 4 Terminal | Single Position | Side Wireway | Lever Bypass | Ringless

Catalog Number	Service	Hub	Line/Load Wire Range		Dimensions			Knockouts				
			CU	AL	D"	W"	H"	1	2	3	4	5
U3924-XL	OH/UG	C.P.	#6-350	#6-350	4 ⁷ / ₈	14	20 ¹ / ₂	3	2 ¹ / ₂	1/4, 1/2	—	—
U4721-O-BL	UG	Blank	#6-350	#6-350	5 ³ / ₄	16	22	4	3 ¹ / ₂	2 ¹ / ₂	1	1/4

Notes

- **Hubs:** For the proper hub selection, see the hub suffix chart on the accessory page.
*External hex connectors | **Internal hex connectors
- **Connectors:** Stud type units (**U9865**) supplied with 3/8"-16 hex head nuts with Belleville washers. For connector lug kits, order as extra from chart on page 76. Separate lug kits are required for line and load.
- **Bypass:** Lever supplies clamping action on meter spades and also operates bypass device.
- **Fifth Terminal:** For field installed fifth terminal, order **K3865** for **U3924**. Order **K3866** for **U4721**, **U4801**, **U9800**, **U9801** and **U9865**.

Please consult serving utility for their requirements prior to ordering or installing, as specifications and approvals vary by utility, and may require local electrical inspector approval. All installations must be installed by a licensed electrician and must comply with all national and local codes, laws and regulations. Milbank reserves the right to make changes in specifications and features shown without notice or obligation.



Single Position Lever Bypass

200 Amp | 5 Terminal | Ringless | 600 VAC



U4801-O-5T9

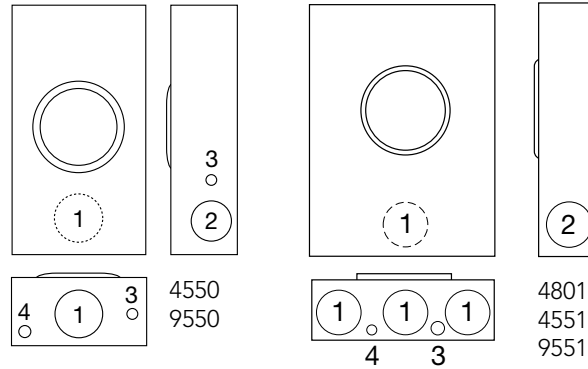

200 Amp | 5 Terminal | Single Position | Lever Bypass | Ringless

Catalog Number	Service	Hub	Line/Load Wire Range		Bypass	Dimensions			Knockouts			
			CU	AL		D"	W"	H"	1	2	3	4
U4801-XL-5T9*	OH/UG	C.P.	#6-350	#6-350	Lever	4 ⁷ / ₈	13	19	3	2 ¹ / ₂	³ / ₄	¹ / ₄ , ¹ / ₂
U4801-O-5T9*	OH/UG	Blank	#6-350	#6-350	Lever	4 ⁷ / ₈	13	19	3	2 ¹ / ₂	¹ / ₄ , ¹ / ₂	¹ / ₄
U4550-RL-5T9*	OH	H.O.	#6-350	#6-350	Lever	4 ⁷ / ₈	10	18 ¹ / ₂	3	2 ¹ / ₂	³ / ₄	¹ / ₄ , ¹ / ₂
U4551-RXL-5T9*	OH/UG	C.P.	#6-350	#6-350	Lever	4 ⁷ / ₈	13	19	3	2 ¹ / ₂	¹ / ₄ , ¹ / ₂	¹ / ₄
U9550-RRL	OH	H.O.	#6-350	#6-350	Lever	4 ⁷ / ₈	10	18 ¹ / ₂	3	2 ¹ / ₂	³ / ₄	¹ / ₄ , ¹ / ₂
U9551-RXL	OH/UG	C.P.	#6-350	#6-350	Lever	4 ⁷ / ₈	13	19	3	2 ¹ / ₂	¹ / ₄ , ¹ / ₂	¹ / ₄

Notes

- **Hubs:** For the proper hub selection, see the hub suffix chart on the accessory page.
- *External hex connectors
- **Bypass:** Lever supplies clamping action on meter spades and also operates bypass device.
- **Fifth Terminal:** Includes factory installed fifth terminal in 6 o'clock position. Unless **-5T9** is included in the part number, then the 5th terminal is located in the 9 O'clock position.
- **Insulated Neutral:** Neutral may be isolated in field by removing bonding strap per instructions on bonding strap tag.



Please consult serving utility for their requirements prior to ordering or installing, as specifications and approvals vary by utility, and may require local electrical inspector approval. All installations must be installed by a licensed electrician and must comply with all national and local codes, laws and regulations. Milbank reserves the right to make changes in specifications and features shown without notice or obligation.

Single Position Lever Bypass

200 Amp | 7 Terminal | Ringless | 600 VAC

15
200 AMP
SINGLE
POSITION
LEVER BYPASS



U4701-XL

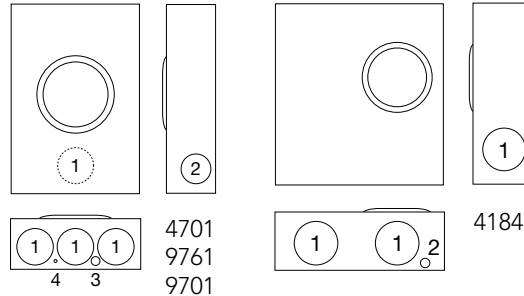

U9761-RRL

200 Amp | 7 Terminal | Single Position | Lever Bypass | Ringless | 3Ø4W

Catalog Number	Service	Hub	Line/Load Wire Range		Dimensions			Knockouts			
			CU	AL	D"	W"	H"	1	2	3	4
U4701-XL*	OH/UG	C.P.	#6-350	#6-350	4 ⁷ / ₈	13	19	3	2 ¹ / ₂	1 ¹ / ₄ , 1 ¹ / ₂	1 ¹ / ₄
U9701-RXL**	OH/UG	C.P.	#6-350	#6-350	4 ⁷ / ₈	13	19	3	2 ¹ / ₂	1 ¹ / ₄ , 1 ¹ / ₂	1 ¹ / ₄
U9761-RRL	OH/UG	H.O.	3 ⁸ / ₈ " x 16 Stud	3 ⁸ / ₈ " x 16 Stud	4 ⁷ / ₈	13	28 ¹ / ₄	3	2 ¹ / ₂	1 ¹ / ₄ , 1 ¹ / ₂	1 ¹ / ₄
U4184-X**	OH/UG	C.P.	#6-350	#6-350	6	18	19 ¹ / ₄	4	1 ¹ / ₄ , 1 ¹ / ₂	—	—

Notes

- **Hubs:** For the proper hub selection, see the hub suffix chart on the accessory page.
*External hex connectors | **Internal hex connectors
- **Connectors:** Units (excluding **U9761**) supplied with extruded aluminum connectors and bonded triplex neutral.
- **U9761** is supplied with 3⁸/₈"-16 hex head nuts with Belleville washers. For connector lug kits, order as extra from chart on page 76. Separate lug kits are required for line and load.
- **Bypass:** Lever supplies clamping action on meter spades and also operates bypass device.

Please consult serving utility for their requirements prior to ordering or installing, as specifications and approvals vary by utility, and may require local electrical inspector approval. All installations must be installed by a licensed electrician and must comply with all national and local codes, laws and regulations. Milbank reserves the right to make changes in specifications and features shown without notice or obligation.



Single Position Lever Bypass

320 Amp | 4 Terminal | Ringless | 600 VAC

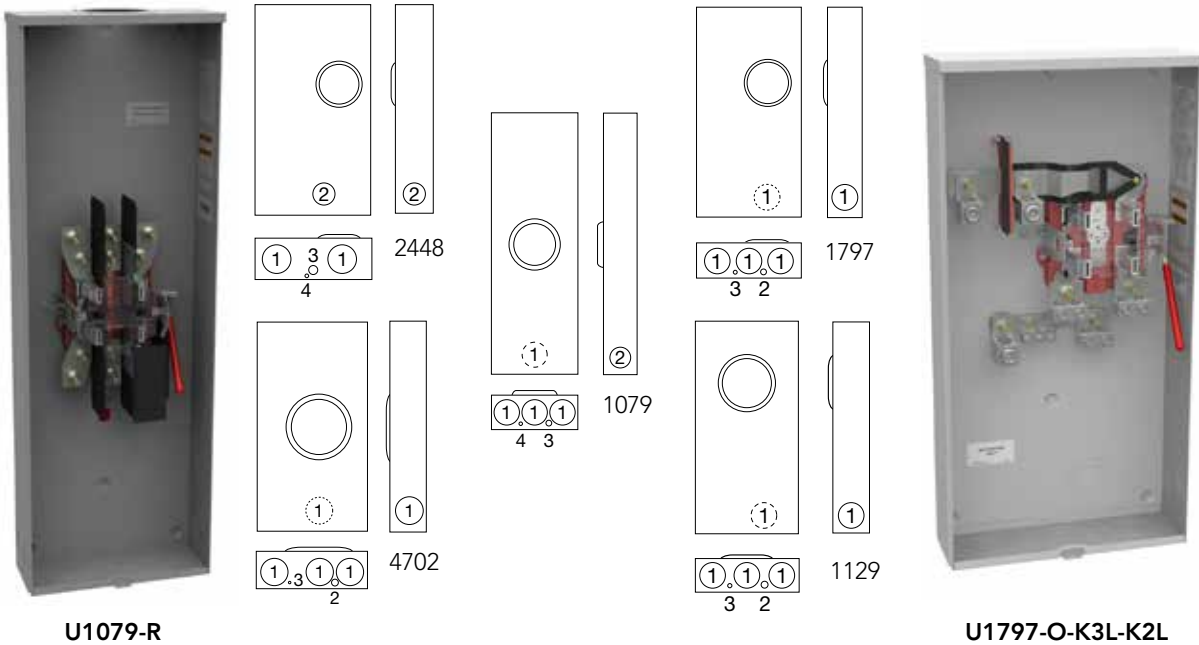

U1079-R

U1797-O-K3L-K2L

320 Amp | 4 Terminal | Single Position | Lever Bypass | Ringless

Catalog Number	Service	Hub	SW	Line/Load Wire Range		Dimensions			Knockouts			
				CU	AL	D"	W"	H"	1	2	3	4
U1079-R	OH	H.O.	N	3/8" x 16 Stud	3/8" x 16 Stud	4 7/8	13	38 3/4	3	2 1/2	1/4, 1/2	1/4
U4702-X	OH/UG	C.P.	Y	3/8" x 16 Stud	3/8" x 16 Stud	4 7/8	15	28 1/4	3	1/4, 1/2	1/4	—
U2448-X	OH/UG	C.P.	Y	3/8" x 16 Stud	3/8" x 16 Stud	6 1/2	17 3/4	34 1/8	4	3	1	1/4
U1129-O	UG	Blank	N	3/8" x 16 Stud	3/8" x 16 Stud	4 7/8	15	30	3	1/4, 1/2	1/4	—
U1797-O-K3L-K2L	UG	Blank	Y	(1) #4-600 or (2) 1/0-250	(2) #6-350	4 7/8	15	30	3	1/4, 1/2	1/4	—
U1797-O-STU-STU	UG	Blank	Y	3/8" x 16 Stud	3/8" x 16 Stud	4 7/8	15	30	3	1/4, 1/2	1/4	—

Notes

- **Hubs:** For the proper hub selection, refer to the hub suffix chart on the accessory page.
- **Fifth Terminal:** For field-installed fifth terminal, order catalog number **K3865** for **U2448**, **U1129**, and **U1797**. Order **K3866** for **U1079** and **U4702**.
- **Sideway Wire:** SW indicates side wireway models.
- **Anti-Inversion:** For field installed anti-inversion kit, order separately catalog number **K4802**.
- **Bypass:** The lever supplies clamping action on meter spades and also operates bypass device.



Please consult serving utility for their requirements prior to ordering or installing, as specifications and approvals vary by utility, and may require local electrical inspector approval. All installations must be installed by a licensed electrician and must comply with all national and local codes, laws and regulations. Milbank reserves the right to make changes in specifications and features shown without notice or obligation.

Single Position Lever Bypass

320 Amp | 5 Terminal | Ringless | 600 VAC

17
320 AMP
SINGLE
POSITION



U1079-R-5T9

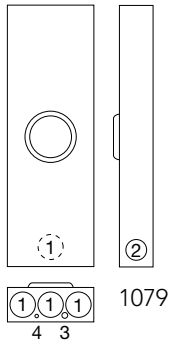

U3000-O-5T9-K3L-K2L

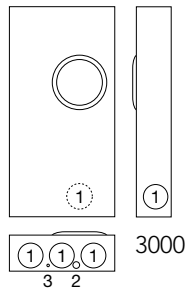

U1129-O-5T9

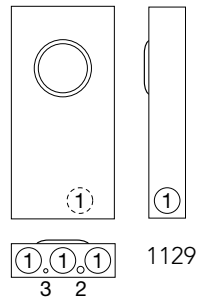

U2448-X-5T9

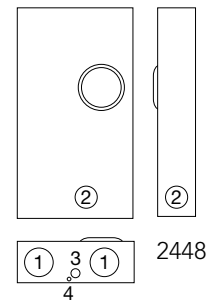

320 Amp | 5 Terminal | Single Position | Lever Bypass | Ringless

Catalog Number	Service	Hub	SW	Line/Load Wire Range		Dimensions			Knockouts			
				CU	AL	D"	W"	H"	1	2	3	4
U1079-R-5T9*	OH	H.O.	N	3/8" x 16 Stud	3/8" x 16 Stud	4 7/8	13	38 3/4	3	2 1/2	1/4, 1/2	1/4
U2448-X-5T9*	OH/UG	C.P.	Y	3/8" x 16 Stud	3/8" x 16 Stud	6 1/2	17 3/4	34 1/8	4	3	1	1/4
U1129-O-5T9	UG	Blank	N	3/8" x 16 Stud	3/8" x 16 Stud	4 7/8	15	30	3	1/4, 1/2	1/4	—
U3000-O-K3L-K2L	UG	Blank	Y	#4-600 or (2) 1/0-250	(2) #6-350	4 7/8	15	30	3	1/4, 1/2	1/4	—

Notes

- **Hubs:** For proper hub selection, refer to the hub suffix chart on the accessory page.
- **Bypass:** The lever supplies clamping action on meter spades and also operates bypass device.
- **Sideway Wire:** SW indicates side wireway models.
- ***Connectors:** U1079 and U2448 are supplied with 3/8"-16 hex head nuts with Belleville washers. For connector lug kits, order as extra from chart on page 76. Separate lug kits are required for line and load.

Please consult serving utility for their requirements prior to ordering or installing, as specifications and approvals vary by utility, and may require local electrical inspector approval. All installations must be installed by a licensed electrician and must comply with all national and local codes, laws and regulations. Milbank reserves the right to make changes in specifications and features shown without notice or obligation.



Single Position Lever Bypass

320 Amp | 7 Terminal | Ringless | 600 VAC



U2120-O



U2594-X



U4911-X-BL

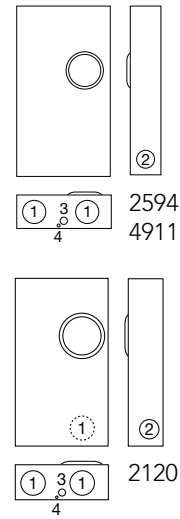

320 Amp | 7 Terminal | Single Position | Side Wireway | Lever Bypass | Ringless | 3Ø4W

Catalog Number	Service	Hub	Line/Load Wire Range		Dimensions			Knockouts			
			CU	AL	D"	W"	H"	1	2	3	4
U2594-X	OH/UG	C.P.	3/8" x 16 Stud	3/8" x 16 Stud	6 1/2	19	34 1/8	4	3	1	1/4
U4911-X-QG-BL	OH/UG	C.P.	3/8" x 16 Stud	3/8" x 16 Stud	6 1/2	17 3/4	38 3/8	4	3	1	1/4
U2120-O	UG	Blank	3/8" x 16 Stud	3/8" x 16 Stud	6 1/2	17 3/4	31 3/4	4	3	1	1/4

Notes

- **Hubs:** For the proper hub selection, refer to the hub suffix chart on the accessories page.
- **Bypass:** The lever supplies clamping action on meter spades and also operates bypass device.
- **Connectors:** Units supplied with 3/8" -16 hex head nuts with Belleville washers. For connector lug kits, order as extra from chart on page 76. Separate lug kits are required for line and load.



Please consult serving utility for their requirements prior to ordering or installing, as specifications and approvals vary by utility, and may require local electrical inspector approval. All installations must be installed by a licensed electrician and must comply with all national and local codes, laws and regulations. Milbank reserves the right to make changes in specifications and features shown without notice or obligation.

Meter Mains

100-200 Amp | 4 Terminal | Ringless | 240 VAC

19
100-200 AMP
METER MAINS



U3491-XL-200

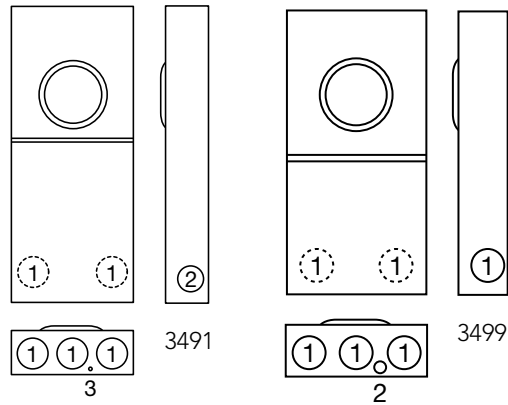

4 Terminal | Meter Main | Ringless

Catalog Number	Amp	Service	Hub	Breaker Compatibility	Line/Load Wire Range		Dimensions			Knockouts		
					CU	AL	D"	W"	H"	1	2	3
U3499-XL	100	OH/UG	H.O.	QP2100	#6-2/0	#14-1/0	3¾	11	22	2	¼, ½	—
U3491-XL-150	150	OH/UG	C.P.	UFQB-150-X1	#6-350	#1-300	4⅞	12	29	2½	2	¼
U3491-XL-200	200	OH/UG	C.P.	UFQB-200-X1	#1-300	#1-300	4⅞	12	29	2½	2	¼

Notes

- **Hubs:** For the proper hub selection, refer to the hub suffix chart on the accessory page.
- **Breakers:** Bolt-on circuit breakers are factory installed in the **U3491** series. The **U3499** do not come with breakers unless specified on order and require plug-in style.
- **Short Circuit Current Rating:** 10K AIC. However, this rating is limited to the lowest interrupting capacity of any circuit breaker installed. Watthour meter not included in short circuit current rating.

Please consult serving utility for their requirements prior to ordering or installing, as specifications and approvals vary by utility, and may require local electrical inspector approval. All installations must be installed by a licensed electrician and must comply with all national and local codes, laws and regulations. Milbank reserves the right to make changes in specifications and features shown without notice or obligation.





U5842-RL-200

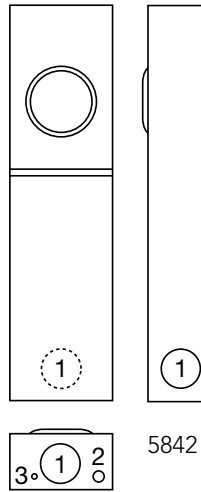

5842



U5844-PXL-200

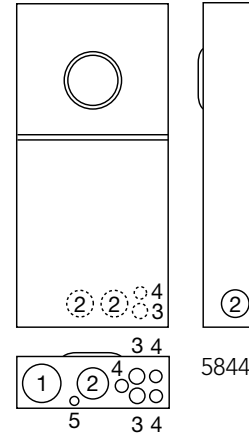

5844

200 Amp | 4 Terminal | Meter Mains | Ringless

Catalog Number	Service	Hub	Line/Load Wire Range		Bypass	Dimensions			Knockouts				
			CU	AL		D"	W"	H"	1	2	3	4	5
U5842-RL-200	OH	H.O.	#6-350	CB-200A	None	4½	8	30	2½	¼, ½	¼	—	—
U5844-PXL*	OH/UG	C.P.	#6-350	—	None	4½	14	30	3	2½	1	½, ¾	¼, ½

Notes

- **AIC Rating:** All models are rated 22K AIC when using Siemens **QPH** (100 amp) or **QNH** (200 amp) breakers.
- **Hub:** -PXL versions supplied with one (1) closing plate packed inside. Order other hubs separately.
- **Fifth Terminal:** For field-installable fifth terminal kit, order **K5T**.
- ***Breaker:** See breaker chart on page 73, 200 amp frame.



Please consult serving utility for their requirements prior to ordering or installing, as specifications and approvals vary by utility, and may require local electrical inspector approval. All installations must be installed by a licensed electrician and must comply with all national and local codes, laws and regulations. Milbank reserves the right to make changes in specifications and features shown without notice or obligation.

Meter Mains

100-200 Amp | 4 Terminal | Ringless | 240 VAC

21
100-200 AMP
METER
MAINS

Supplied with breakers



U9648-RL-100

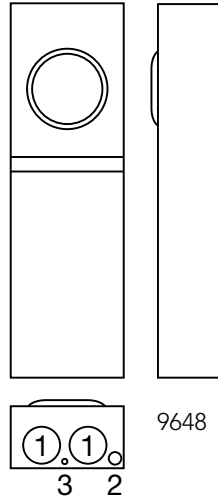

9648

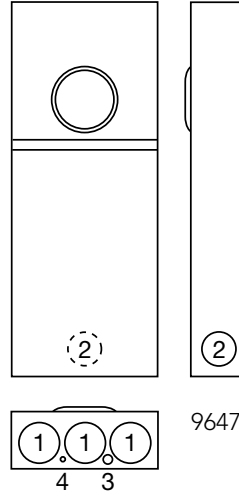

9647



U9647N-RL-200

4 Terminal | Meter Main | With Triple Tap Lugs & Load Side Distribution | Ringless

Catalog Number	Amp	Service	Hub	Line/Load Wire Range		Dimensions			Knockouts			
				CU	AL	D"	W"	H"	1	2	3	4
U9648-RL-100	100	OH/UG	H.O.	#6-350	#6-350	4 $\frac{1}{8}$	8	26	2	1/4, 1/2	1/4	—
U9647N-XL-100	100	OH/UG	C.P.	#6-350	#6-350	4 $\frac{7}{8}$	13	33	3	2 $\frac{1}{2}$	1/4, 1/2	1/4
U9647N-XL-200	200	OH/UG	C.P.	#6-350	#6-350	4 $\frac{7}{8}$	13	33	3	2 $\frac{1}{2}$	1/4, 1/2	1/4

Notes

- **Hubs:** For the proper hub selection, refer to the hub suffix chart on the accessory page.
- **Connectors:** Extruded aluminum connectors are tin plated with triplex on the load side.
- **Breakers:** Supplied with factory installed double pole circuit breakers of amperage shown.
- **Short Circuit Current Rating:** 10K AIC. However, this rating is limited to the lowest interrupting capacity of any circuit breaker installed. Watthour meter not included in short circuit current rating.

Please consult serving utility for their requirements prior to ordering or installing, as specifications and approvals vary by utility, and may require local electrical inspector approval. All installations must be installed by a licensed electrician and must comply with all national and local codes, laws and regulations. Milbank reserves the right to make changes in specifications and features shown without notice or obligation.



22

100-200 AMP
METER MAIN
WITH LOAD
CENTER

Meter Main With Load Center

100-200 Amp | 4 & 5 Terminal | Ringless | 240 VAC



U5168-XTL-200

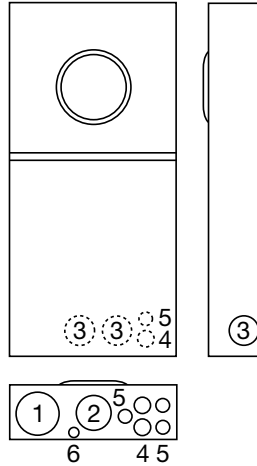

U5268-XTL-200-KK

100-200 Amp | 4 & 5 Terminal | Meter Mains | Overhead/Underground | Ringless

Catalog Number	Amp	Circuits	Hub	Connectors CU/AL -Line	Bypass	Dimensions			Knockouts					
						D"	W"	H"	1	2	3	4	5	6
U5168-XTL-100	100	10	C.P.	#6- 350	None	4½	14⅞	30	3	2½	2	1	½, ¾	¼, ½
U5168-XTL-150	150	8	C.P.	#6- 350	None	4½	14⅞	30	3	2½	2	1	½, ¾	¼, ½
U5168-XTL-200	200	8	C.P.	#6- 350	None	4½	14⅞	30	3	2½	2	1	½, ¾	¼, ½
U5168-XTL-100-KK	100	10	C.P.	#6- 350	Horn	4½	14⅞	30	3	2½	2	1	½, ¾	¼, ½
U5168-XTL-150-KK	150	8	C.P.	#6- 350	Horn	4½	14⅞	30	3	2½	2	1	½, ¾	¼, ½
U5168-XTL-200-KK	200	8	C.P.	#6- 350	Horn	4½	14⅞	30	3	2½	2	1	½, ¾	¼, ½
U5168-XTL-100-KK-5T	100	10	C.P.	#6- 350	Horn	4½	14⅞	30	3	2½	2	1	½, ¾	¼, ½
U5168-XTL-150-KK-5T	150	8	C.P.	#6- 350	Horn	4½	14⅞	30	3	2½	2	1	½, ¾	¼, ½
U5268-XTL-150	150	20	C.P.	#6- 350	None	4½	14⅞	30	3	2½	2	1	½, ¾	¼, ½
U5268-XTL-200	200	20	C.P.	#6- 350	None	4½	14⅞	30	3	2½	2	1	½, ¾	¼, ½
U5268-XTL-150-KK	150	20	C.P.	#6- 350	Horn	4½	14⅞	30	3	2½	2	1	½, ¾	¼, ½
U5268-XTL-200-KK	200	20	C.P.	#6- 350	Horn	4½	14⅞	30	3	2½	2	1	½, ¾	¼, ½

Notes

- **Hubs:** Supplied with two closing plates packed inside. Order hubs as a separate item. For proper hub selection, refer to the hub suffix chart on the accessories page.
- **Fifth Terminal:** For field installed fifth terminal, order **K5T**.
- **Breakers:** Rated 22K AIC with Milbank **QN2200RH** main installed.
- **Interlock Kit:** For generator auxiliary circuit breaker interlock, order **K5815** for large **QN** with small frame **Q**; order **K5820** for large frame **QN** with large frame **QN**; order **K5830** for small frame **Q** to small frame **Q**. See accessories on page 76.
- **Sub Feed Lugs:** #6-350 sub feed lugs provided on 8 circuit interior. **Not available on 20 circuit interior.**
- **-MLK:** For sub feed lug kit, add suffix **-MLK**.



Please consult serving utility for their requirements prior to ordering or installing, as specifications and approvals vary by utility, and may require local electrical inspector approval. All installations must be installed by a licensed electrician and must comply with all national and local codes, laws and regulations. Milbank reserves the right to make changes in specifications and features shown without notice or obligation.

Lever Bypass Meter Main

200 Amp | 5 Terminal | Lever Bypass | Ringless | 240 VAC

23
200 AMP
LEVER BYPASS
METER MAINS



U4834-XL-200-5T9
shown with optional
200 amp auxiliary breaker

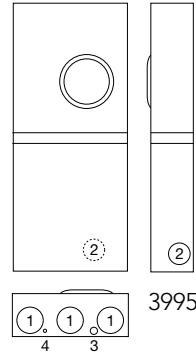
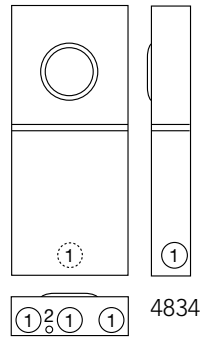

U3995-XL-200-5T9

200 Amp | 5 Terminal | Meter Main with Auxiliary Breaker | Lever Bypass | Ringless

Catalog Number	Service	Hub	Line/Load Wire Range		Dimensions			Knockouts	
			CU	AL	D"	W"	H"	1	2
U4834-XL-200-5T9	OH/UG	C.P.	#6-350	#6-350	5½	17	39	3	¼, ½

Notes

- **Auxiliary Breakers:** Must be ordered separately. Use UQFP-(AMP) from breaker chart on page 74. Includes mechanical interlock so only one breaker is energized.

200 Amp | 5 Terminal | Meter Mains with Sub Panel | Lever Bypass | Ringless

Catalog Number	Service	Hub	Line/Load Wire Range		Dimensions			Knockouts			
			CU	AL	D"	W"	H"	1	2	3	4
U3995-XL-200-5T9	OH/UG	C.P.	#6-350	1/0-300	5¾	16	37	3	2½	¼, ½	¼

Notes

- **Breakers:** Refer to breaker chart on accessory page. Unit has provisions for (2) 2-pole branch breakers or (4) 1-pole branch breakers or a combination totaling 4 branch circuits. Socket main is furnished with branch circuits wired in series with main breaker. For parallel branch circuits add "P" to breaker main amperage (ex.: **U3995-XL-200P-5T9**). Total amperage on branch circuit cannot exceed 125 amps.
- **Hubs:** For proper hub selection, refer to the hub suffix chart on the accessories page.
- **Connectors:** Extruded aluminum connectors are tin plated.
- **Short Circuit Current Rating:** 10K AIC. However, this rating is limited to the lowest interrupting capacity of any circuit breaker installed. Watthour meter not included in short circuit current rating.

Please consult serving utility for their requirements prior to ordering or installing, as specifications and approvals vary by utility, and may require local electrical inspector approval. All installations must be installed by a licensed electrician and must comply with all national and local codes, laws and regulations. Milbank reserves the right to make changes in specifications and features shown without notice or obligation.



24

100-200 AMP
LEVER BYPASS
METER MAINS

Lever Bypass Meter Main

100-200 Amp | 4, 5 & 7 Terminal | Ringless | 240 VAC



U5750-RXL-200-BL

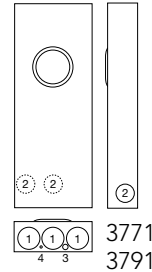
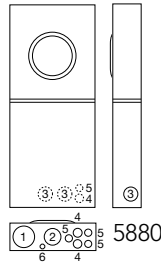
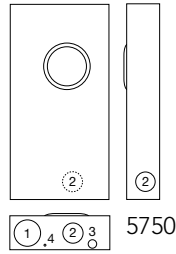

U3791N-RXL-200-5T9

100-200 Amp | 4 & 5 Terminal | Meter Main | Lever Bypass | Ringless | Overhead/Underground

Catalog Number	Terms	Amp	Hub	Line/Load Wire Range		Dimensions			Knockouts					
				CU	AL	D"	W"	H"	1	2	3	4	5	6
U5880-XL-200-5T9	4	200	C.P.	#6-350	#6-350	4½	14⅞	33½	3	2½	2	1	½, ¾	¼, ½
U3791N-RXL-(AMP)	4	100-200	C.P.	#6-350	Breaker*	4⅞	13	34	3	2½	¼, ½	¼	—	—
U3791N-RXL-(AMP)-5T9	5	100-200	C.P.	#6-350	Breaker*	4⅞	13	34	3	2½	¼, ½	¼	—	—

100-200 Amp | 7 Terminal | Meter Main with Breakers | Lever Bypass | Ringless

Catalog Number	Amp	Service	Hub	Line/Load Wire Range		Dimensions			Knockouts				
				CU	AL	D"	W"	H"	1	2	3	4	
U3771-XL-100	100	OH/UG	C.P.	#6-350	#1-300	4⅞	13	28	2½	2	¼, ½	¼	
U5750-RXL-200-BL	200	OH/UG	C.P.	#6-350	1/0-300	5¾	17⅞	34	4	3	¼, ½	¼	

Notes

- **Hubs:** For proper hub selection, refer to the hub suffix chart on the accessories page.
- **Bypass:** The lever supplies clamping action on meter spades and also operates bypass device.
- **Fifth Terminals:** For field installed fifth terminal on **U5880** and **U3791N**, order **K3865**. Units with **-5T9** suffix have fifth terminals factory installed in the 9 o'clock position.
- **Connectors:** Units supplied with ⅜"-16 hex head nuts with Belleville washers. For connector lug kits, order as extra from chart on page 76. Lug kit is required for line side only.
- **Breakers for U3791 Only:** For 100, 125, 150 or 200 amp breakers substitute desired amperage in suffix of catalog number, i.e. **U3791-RXL-(AMP)** becomes **U3791-RXL-200**. Not all units are stock.
- ***Breaker:** See breaker chart on pages 73 & 74, 200 amp frame.
- **Short Circuit Current Rating:** 10K AIC for **U3791N**, **U3771** and **U5750**. 22K for **U5880**. However, this rating is limited to the lowest interrupting capacity of any circuit breaker installed. Watthour meter not included in short circuit current rating.



Please consult serving utility for their requirements prior to ordering or installing, as specifications and approvals vary by utility, and may require local electrical inspector approval. All installations must be installed by a licensed electrician and must comply with all national and local codes, laws and regulations. Milbank reserves the right to make changes in specifications and features shown without notice or obligation.

Meter Main with Load Center

200 Amp | 5 Terminal | Ringless | Lever Bypass | 240 VAC

25
200 AMP
METER MAIN
WITH LOAD
CENTER



U6281-XL-200

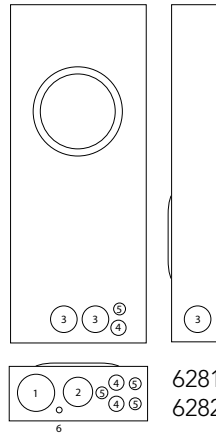

200 Amp | 5 Terminal | Meter Main with Breakers | Lever Bypass | Ringless

Catalog Number	Service	Circuits	Hub	Line/Load Wire Range		Dimensions			Knockouts					
				CU	AL	D"	W"	H"	1	2	3	4	5	6
U6281-XL-100 -5T9	OH/UG	10	C.P.	#6-350	CB	4½	14⅞	33½	3	2½	2	1	½, ¾	¼, ½
U6281-XL-150 -5T9	OH/UG	8	C.P.	#6-350	CB	4½	14⅞	33½	3	2½	2	1	½, ¾	¼, ½
U6281-XL-200 -5T9	OH/UG	8	C.P.	#6-350	CB	4½	14⅞	33½	3	2½	2	1	½, ¾	¼, ½
U6282-XL-200 -5T9	OH/UG	20	C.P.	#6-350	CB	4⅝	14⅞	34	3	2½	2	1	½, ¾	¼, ½

Notes

- **Breakers:** Rated 22K AIC with Milbank **QN2200RH** main installed.
- **Interlock Kit:** For generator auxiliary circuit breaker interlock, order **K5815** for large **QN** with small frame **Q**; order **K5820** for large frame **QN** with large frame **QN**; order **K5830** for small frame **Q** to small frame **Q**. See accessories on pages 73-74.
- **Sub Feed Lugs:** #6-350 sub feed lugs provided on 8 circuit interior. **Not available on 20 circuit interior.**
- **-MLK:** For sub feed lug kit, add suffix **-MLK**.

Please consult serving utility for their requirements prior to ordering or installing, as specifications and approvals vary by utility, and may require local electrical inspector approval. All installations must be installed by a licensed electrician and must comply with all national and local codes, laws and regulations. Milbank reserves the right to make changes in specifications and features shown without notice or obligation.



26

320 AMP
LEVER BYPASS
METER MAINS

Lever Bypass Meter Mains

320 Amp | 5 Terminal | Ringless | 240 VAC



U5059-X-2/200-K3L

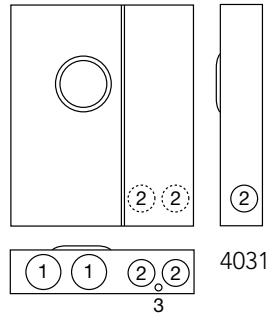
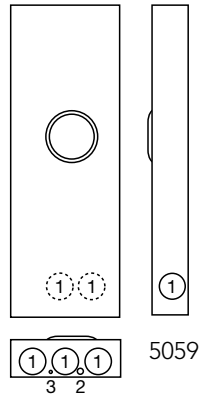

U4031-O-2/200-5T9

320 Amp | 5 Terminal | Meter Main with Breakers | Lever Bypass | Ringless

Catalog Number	Service	Hub	Line/Load Wire Range		Dimensions			Knockouts		
			CU	AL	D"	W"	H"	1	2	3
U4031-O-2/200-5T9	UG	Blank	3/8" x 16 Stud	1/0-300	5 3/4	25	30	4	3	1/4, 1/2
U5059-X-2/200-5T9	OH/UG	C.P.	3/8" x 16 Stud	#6-300	4 27/32	15	42 1/2	3	1/4, 1/2	1/4
U5059-X-5T9-K3L	OH/UG	C.P.	#4-600	#6-300	4 27/32	15	42 1/2	3	1/4, 1/2	1/4

Notes

- **Bypass:** Lever supplies clamping action on meter spades and also operates bypass device.
- **Connectors:** Units supplied with 3/8"-16 hex head nuts with Belleville washers. For connector lug kits, order as extra from chart on page 76. Lug kit is required for line side only.
- ***Breakers:** Order breakers **UQFPH** or **UQFP-100, 150** or **200** separately, see chart on page 74.
- **Short Circuit Current Rating:** 22K AIC. However, this rating is limited to the lowest interrupting capacity of any circuit breaker installed. Watthour meter not included in short circuit current rating.



Please consult serving utility for their requirements prior to ordering or installing, as specifications and approvals vary by utility, and may require local electrical inspector approval. All installations must be installed by a licensed electrician and must comply with all national and local codes, laws and regulations. Milbank reserves the right to make changes in specifications and features shown without notice or obligation.

Lever Bypass Meter Main

320 Amp | 4 Terminal | Ringless | 240 VAC

27
320 AMP
LEVER BYPASS
METER MAINS



U5890-X-2/200

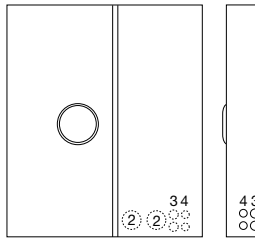
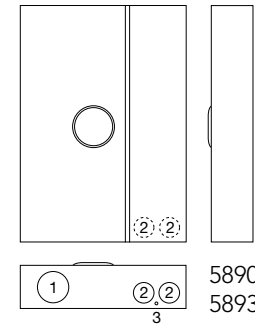

U5894-X-2/200

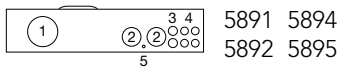

320 Amp | 4 Terminal | Meter Mains | Lever Bypass | Ringless

Catalog Number	Service	Hub	Connectors CU/AL	Branch Circuits	Dimensions			Knockouts				
			Line		D"	W"	H"	1	2	3	4	5
U5890-X-2/200	OH/UG	C.P.	#6-350	N/A	6	24½	35	4	2½	¼	—	—
U5891-X-2/200	OH/UG	C.P.	#6-350	12	6	29½	35	4	2½	1	½, ¾	¼
U5892-X-2/200	OH/UG	C.P.	#6-350	24	6	29½	35	4	2½	1	½, ¾	¼
U5893-X-2/200	OH/UG	C.P.	#6-350	N/A	6	24½	35	4	2½	¼	—	—
U5894-X-2/200	OH/UG	C.P.	#6-350	12	6	29½	35	4	2½	1	½, ¾	¼
U5895-X-2/200	OH/UG	C.P.	#6-350	24	6	29½	35	4	2½	1	½, ¾	¼

Notes

- **Hubs:** For proper hub selection refer to the hub suffix chart on the accessory page.
- **Breakers:** All units come with two 200 amp main breakers. For branch breakers, see chart on page 73.
- **Side Bussed Units: U5893, U5894 and U5895.**
- **-MLK:** Main Lug feed-through kit **K3701** factory installed.
- **Fifth Terminal:** For field mounted fifth terminal order catalog number **K3865**.
- **Short Circuit Current Rating:** 22K AIC. However, this rating is limited to the lowest interrupting capacity of any circuit breaker installed. Watthour meter not included in short circuit current rating.

Please consult serving utility for their requirements prior to ordering or installing, as specifications and approvals vary by utility, and may require local electrical inspector approval. All installations must be installed by a licensed electrician and must comply with all national and local codes, laws and regulations. Milbank reserves the right to make changes in specifications and features shown without notice or obligation.



Cold Sequence Meter Mains

200-320 Amp | 4, 5 & 7 Terminal | Ringless



U5767-X-200-CB



U5797-O-400-CB

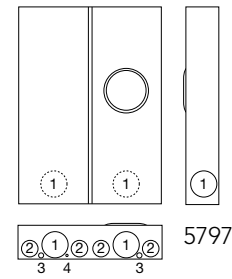
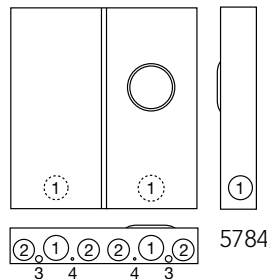
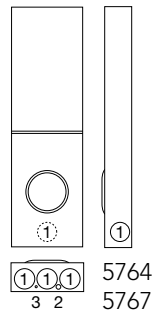
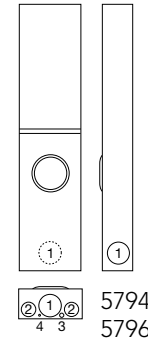

200 Amp Circuit Breaker Disconnect Ahead of Meter Socket | Lever Bypass

Catalog Number	Terminals	Service	Hub	Line/Load Wire Range		Dimensions			Knockouts			
				CU	AL	D"	W"	H"	1	2	3	4
U5764-X-200-CB	4	OH/UG	C.P.	1/0-350	#6-350	4 ^{27/32}	13	43	4	2½	¼	—
U5764-X-200-5T-CB	5	OH/UG	C.P.	1/0-350	#6-350	4 ^{27/32}	13	43	4	2½	¼	—
U5767-X-200-CB	7	OH/UG	C.P.	1/0-350	#6-350	4 ^{27/32}	13	43	4	2½	1	½, ¾
U5784-O-200-CB	5	UG	Blank	1/0-350	#6-350	4 ^{27/32}	26	28	3	2½	¼, ½	¼

320 Amp Continuous Circuit Breaker Disconnect Ahead of Meter Socket | Lever Bypass

Catalog Number	Terminals	Service	Hub	Connectors CU/AL	Dimensions			Knockouts			
				Line/Load	D"	W"	H"	1	2	3	4
U5794-X-400-CB	4	OH	C.P.	(2) 3/0-500	6	13	56	4	2½	¼, ½	¼
U5794-X-400-5T-CB	5	OH	C.P.	(2) 3/0-500	6	13	56	4	2½	¼, ½	¼
U5796-X-400-CB	7	OH	C.P.	(2) 3/0-500	6	13	56	4	2½	¼, ½	¼
U5797-O-400-CB	4	UG	Blank	(2) 3/0-500	6	26	56	4	2½	¼, ½	¼

Notes

- **Hubs:** For proper hub selection, refer to the hub suffix chart on the accessories page.
- **Voltage:** 200 amp circuit breaker units are rated 240 VAC at 65KAIC, 480 VAC at 35KAIC and 600 VAC at 22KAIC. 400 amp circuit breaker units are rated at 600 VAC at 10KAIC.



Please consult serving utility for their requirements prior to ordering or installing, as specifications and approvals vary by utility, and may require local electrical inspector approval. All installations must be installed by a licensed electrician and must comply with all national and local codes, laws and regulations. Milbank reserves the right to make changes in specifications and features shown without notice or obligation.

Multi-Position Sockets

100 Amp | 4 Terminals | Ringless | 300 VAC

29
100 AMP
MULTI-
POSITION

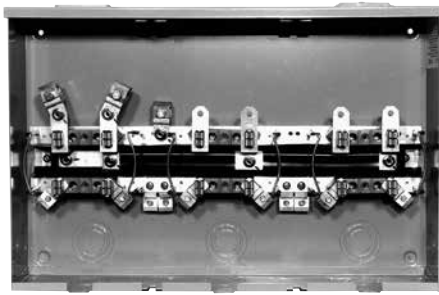

U7363-XL

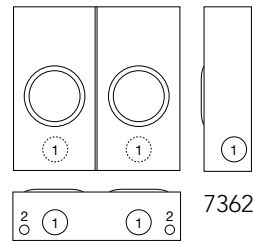

7362

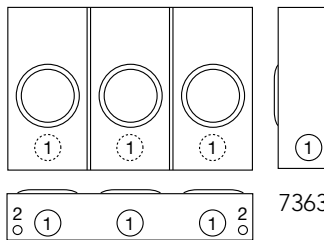

7363

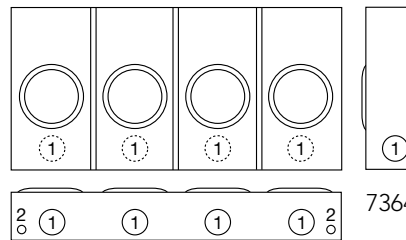

7364

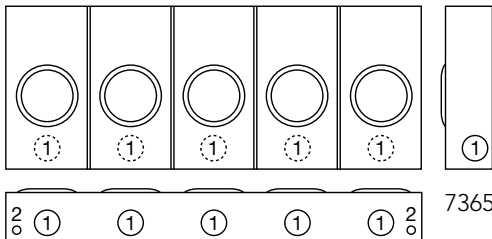

7365

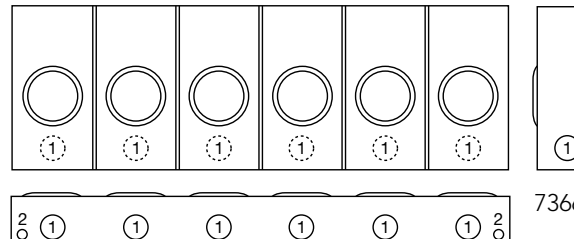

7366

100 Amp per Position | 4 Terminal | Multi-Position | Ringless

Catalog Number	Positions	Service	Hub	Connectors CU/AL		Dimensions			Knockouts	
				Line	Load	D"	W"	H"	1	2
U7362-XL	2	OH	C.P.	#6-350	#6-2/0	4½	16⅝	16	2½	¼, ½
U7363-XL	3	OH	C.P.	#6-350	#6-2/0	4½	24½	16	2½	¼, ½
U7364-XL	4	OH	C.P.	#6-350	#6-2/0	4½	32⅞	16	2½	¼, ½
U7365-XL	5	OH	C.P.	#6-350	#6-2/0	4½	40⅞	16	2½	¼, ½
U7366-XL	6	OH	C.P.	#6-350	#6-2/0	4½	49⅞	16	2½	¼, ½

Notes

- **Hub:** For proper hub selection refer to the hub suffix chart on the accessory page. A hub opening is supplied at each end and the extra opening is closed with a closing plate as standard.
- **Fifth Terminal Kit:** For field mounted fifth terminal, order **5T8K2** for 6 o'clock and **K9959** for 9 o'clock position.
- **Connectors:** Extruded aluminum connectors are tin plated.
- **Bypass:** Horn type bypass is available. Add suffix **-KK** to catalog number.

Please consult serving utility for their requirements prior to ordering or installing, as specifications and approvals vary by utility, and may require local electrical inspector approval. All installations must be installed by a licensed electrician and must comply with all national and local codes, laws and regulations. Milbank reserves the right to make changes in specifications and features shown without notice or obligation.



Multi-Position Sockets

100 Amp | 4 Terminal | Ringless | 300 VAC



U8212-XL

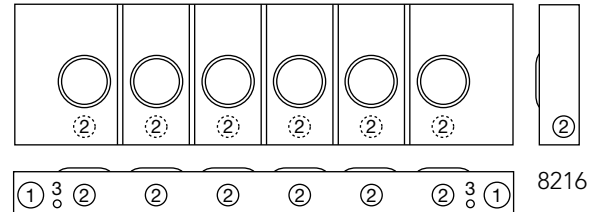
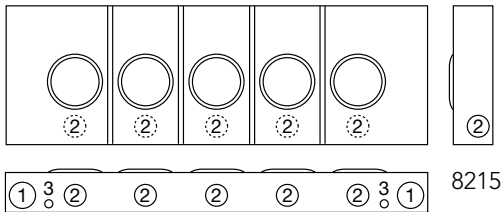
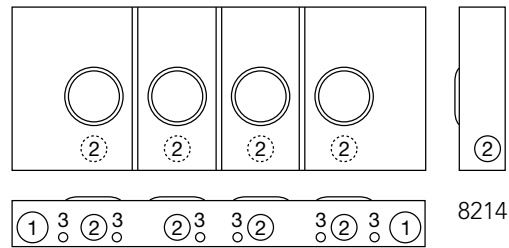
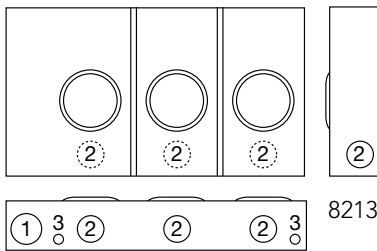
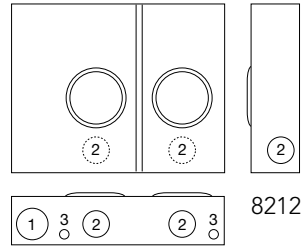

100 Amp per Position | 4 Terminal | Multi-Position | End Wireway | Ringless

Catalog Number	Positions	Service	Hub	Connectors CU/AL		Dimensions			Knockouts		
				Line	Load	D"	W"	H"	1	2	3
U8212-XL	2	OH/UG	H.O.	#6-350	#6-2/0	4½	20⅝	16	2½	2	¼, ½
U8213-XL	3	OH/UG	H.O.	#6-350	#6-2/0	4½	28⅝	16	2½	2	¼, ½
U8214-XL	4	OH/UG	H.O.	#6-350	#6-2/0	4½	40⅝	16	2½	2	¼, ½
U8215-XL	5	OH/UG	H.O.	#6-350	#6-2/0	4½	48⅝	16	2½	2	¼, ½
U8216-XL	6	OH/UG	H.O.	#6-350	#6-2/0	4½	57⅝	16	2½	2	¼, ½

Notes

- **Hub:** For proper hub selection refer to the hub suffix chart on the accessory page. A hub opening is supplied at each end and the extra opening is closed with a closing plate as standard.
- **Fifth Terminal Kit:** For field mounted fifth terminal, order **5T8K2** for 6 o'clock and **K9959** for 9 o'clock position.
- **Connectors:** Extruded aluminum connectors are tin plated.
- **Bypass:** Horn type bypass is available. Add suffix **-KK** to catalog number.



Please consult serving utility for their requirements prior to ordering or installing, as specifications and approvals vary by utility, and may require local electrical inspector approval. All installations must be installed by a licensed electrician and must comply with all national and local codes, laws and regulations. Milbank reserves the right to make changes in specifications and features shown without notice or obligation.

Multi-Position Sockets

100 Amp | 4 Terminal | Ringless | 300 VAC

31
100 AMP
MULTI-
POSITION

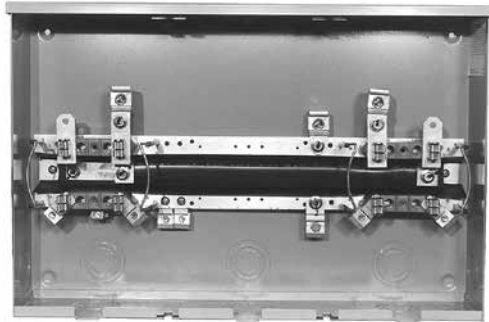

U8032-RL

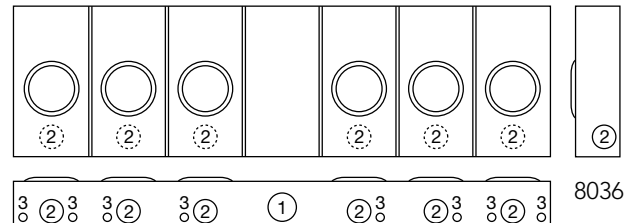
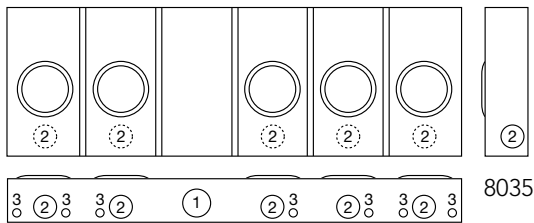
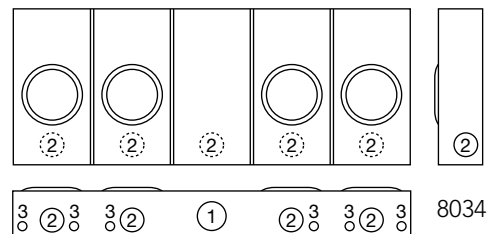
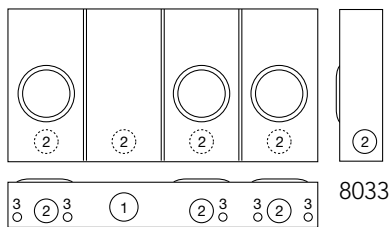
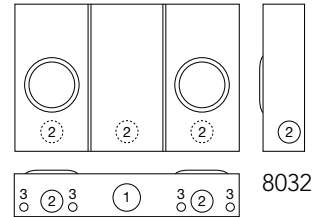

100 Amp per Position | 4 Terminal | Multi-Position | Center Wireway | Ringless

Catalog Number	Positions	Service	Hub	Connectors CU/AL		Dimensions			Knockouts		
				Line	Load	D"	W"	H"	1	2	3
U8032-RL	2	OH/UG	H.O.	#6-350	#6-2/0	4½	24½	16	2½	2	½
U8033-RL	3	OH/UG	H.O.	#6-350	#6-2/0	4½	32¼ ₆	16	3	2½	1
U8034-RL	4	OH/UG	H.O.	#6-350	#6-2/0	4½	40 ⁷ / ₈	16	3	2½	1
U8035-RL	5	OH/UG	H.O.	#6-350	#6-2/0	4½	49 ¹ / ₁₆	16	3	2½	1
U8036-RL	6	OH/UG	H.O.	#6-350	#6-2/0	4½	57¼	16	3	2½	1

Notes

- **Hubs:** For proper hub selection, refer to the hub suffix chart on the accessories page.
- **Fifth Terminal:** For field mounted fifth terminal, order catalog number **5T8K2**. Installs in 6 o'clock position only.
- **Connectors:** Extruded aluminum connectors are tin plated.
- **Bypass:** Horn bypass is available. Add suffix **-KK** to catalog number.

Please consult serving utility for their requirements prior to ordering or installing, as specifications and approvals vary by utility, and may require local electrical inspector approval. All installations must be installed by a licensed electrician and must comply with all national and local codes, laws and regulations. Milbank reserves the right to make changes in specifications and features shown without notice or obligation.



Multi-Position Sockets

200 Amp | 4 Terminal | Ringless | 300 VAC



U1254-X

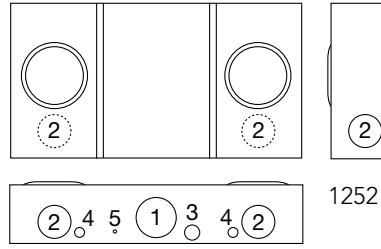

1252

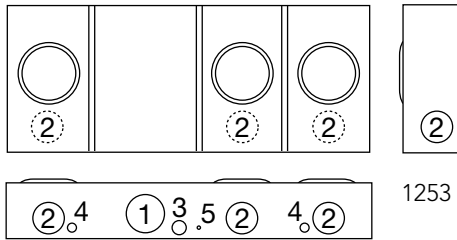

1253

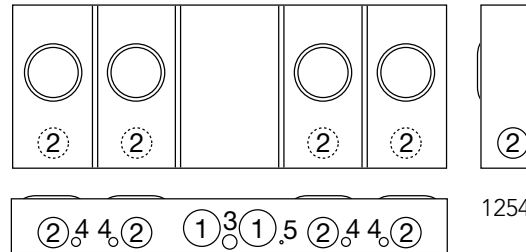

1254

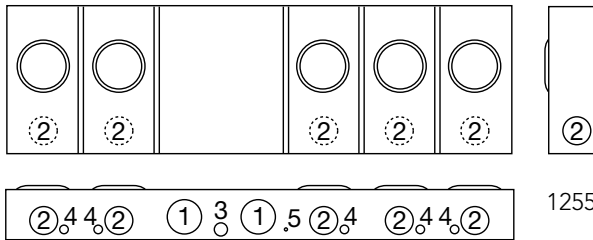

1255

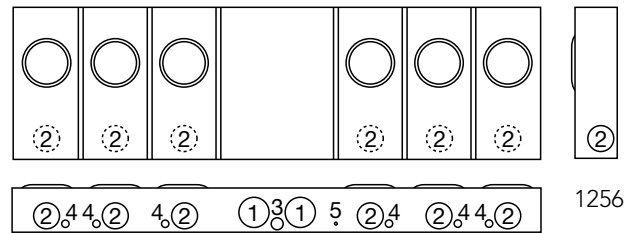

1256

200 Amp per Position | 4 Terminal | Multi-Position | Center Wireway | Ringless

Catalog Number	Positions	Service	Hub	Connectors CU/AL		Dimensions			Knockouts				
				Line	Load	D"	W"	H"	1	2	3	4	5
U1252-X	2	OH/UG	C.P.	3/8" x 16 Stud	#6-350	5 1/8	26 1/2	14	3	2 1/2	1	1/2	1/4
U1253-X	3	OH/UG	C.P.	3/8" x 16 Stud	#6-350	5 1/8	34 1/2	14	3	2 1/2	1	1/2	1/4
U1254-X	4	OH/UG	C.P.	3/8" x 16 Stud	#6-350	5 1/8	42 1/16	16	3	2 1/2	1	1/2	1/4
U1255-X	5	OH/UG	C.P.	3/8" x 16 Stud	#6-350	5 1/8	54 1/16	16	3	2 1/2	1	1/2	1/4
U1256-X	6	OH/UG	C.P.	3/8" x 16 Stud	#6-350	5 1/8	62 7/8	18	3	2 1/2	1	1/2	1/4

Notes

- **Hubs:** For proper hub selection, refer to the hub suffix chart on the accessories page. For the **U1254-6** two hub openings are supplied and the extra opening is closed with a closing plate as standard.
- **Fifth Terminal:** For field mounted fifth terminal, order catalog number **K5T** (9 o'clock position).
- **Connectors:** Extruded aluminum connectors are tin plated. For line side connector lug kits, order as extra from chart on page 76.
- **Bypass:** Horn bypass is available. Add suffix **-KK** to catalog number.



Please consult serving utility for their requirements prior to ordering or installing, as specifications and approvals vary by utility, and may require local electrical inspector approval. All installations must be installed by a licensed electrician and must comply with all national and local codes, laws and regulations. Milbank reserves the right to make changes in specifications and features shown without notice or obligation.

Lever Bypass Multi-Position Sockets

200 Amp | 5 Terminal | Ringless | 600 VAC

33
200 AMP
MULTI-
POSITION



U2873-Xt-5T9

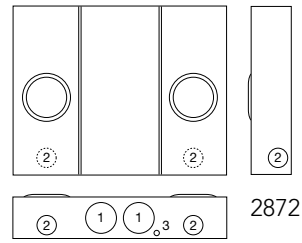

2872

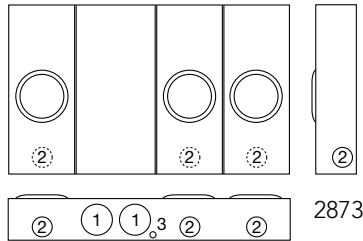

2873

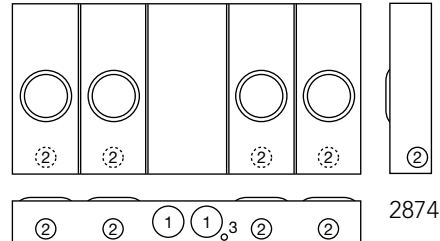

2874

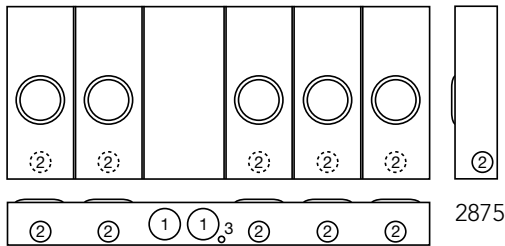

2875

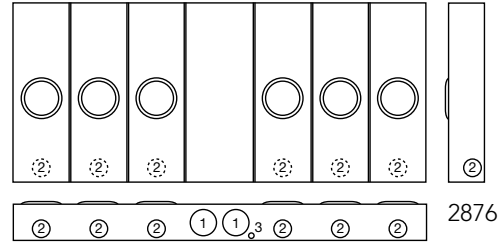

2876

200 Amp per Position | 5 Terminal | Multi-Position | Center Wireway | Ringless

Catalog Number	Positions	Service	Hub	Connectors CU/AL		Dimensions			Knockouts		
				Line	Load	D"	W"	H"	1	2	3
U2872-Xt-5T9	2	OH/UG	(2) C.P.	3/8" x 16 Stud	#6-350	6	32 1/8	25 1/4	4	2 1/2	1/4, 1/2
U2873-Xt-5T9	3	OH/UG	(2) C.P.	3/8" x 16 Stud	#6-350	6	42 3/16	25 1/4	4	2 1/2	1/4, 1/2
U2874-Xt-5T9	4	OH/UG	(2) C.P.	3/8" x 16 Stud	#6-350	6	52 1/4	25 1/4	4	2 1/2	1/4, 1/2
U2875-Xt-5T9	5	OH/UG	(2) C.P.	3/8" x 16 Stud	#6-350	6	62 3/16	25 1/4	4	2 1/2	1/4, 1/2
U2876-Xt-5T9	6	OH/UG	(2) C.P.	3/8" x 16 Stud	#6-350	6	72 3/8	31 1/4	4	2 1/2	1/4, 1/2

Notes

- **Hubs:** Units supplied with two closing plates. To order hubs as extra, refer to the hub suffix chart on the accessories page.
- **Connector Kits:** For line side connector kits, order as extra **K1539** (350 kcmil), **K1540** (600 kcmil), twin **K1350** (350 kcmil), twin **K1541** (600 kcmil). Line connectors can be reversed to change from "OH" to "UG" service. For line side connector lug kits, order as extra from chart on page 76.
- **Bypass:** Lever supplies clamping action on meter spades and also operates bypass device.

Please consult serving utility for their requirements prior to ordering or installing, as specifications and approvals vary by utility, and may require local electrical inspector approval. All installations must be installed by a licensed electrician and must comply with all national and local codes, laws and regulations. Milbank reserves the right to make changes in specifications and features shown without notice or obligation.



Lever Bypass Multi-Position Sockets

200 Amp | 7 Terminal | Ringless | 600 VAC



U2732-XT

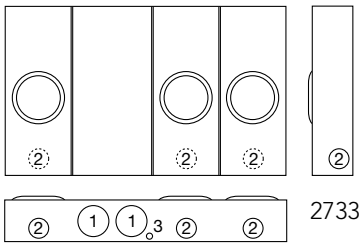
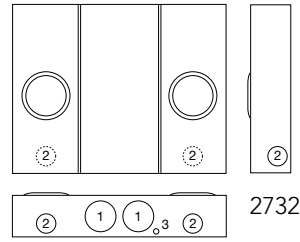

2733

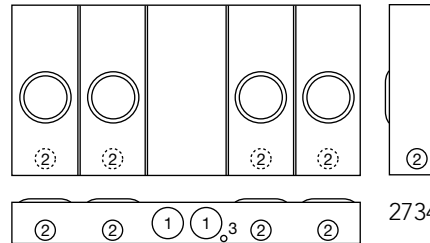

2734

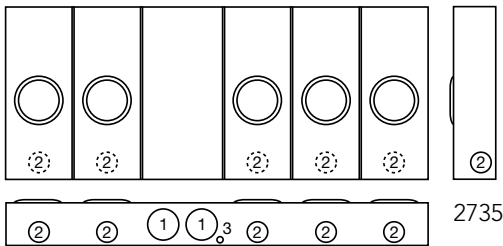

2735

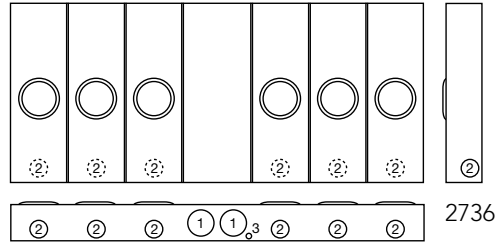

2736

200 Amp per Position | 7 Terminal | Multi-Position | Center Wireway | Ringless

Catalog Number	Positions	Service	Hub	Connectors CU/AL		Dimensions			Knockouts			
				Line	Load	D"	W"	H"	1	2	3	4
U2732-XT	2	OH/UG	(2) C.P.	3/8" x 16 Stud	#6-350	6	32 1/8	25 1/4	4	2 1/2	1/4, 1/2	1/4
U2733-XT	3	OH/UG	(2) C.P.	3/8" x 16 Stud	#6-350	6	42 3/16	25 1/4	4	2 1/2	1/4, 1/2	1/4
U2734-XT	4	OH/UG	(2) C.P.	3/8" x 16 Stud	#6-350	6	52 1/4	25 1/4	4	2 1/2	1/4, 1/2	1/4
U2735-XT	5	OH/UG	(2) C.P.	3/8" x 16 Stud	#6-350	6	62 5/16	25 1/4	4	2 1/2	1/4, 1/2	1/4
U2736-XT	6	OH/UG	(2) C.P.	3/8" x 16 Stud	#6-350	6	72 3/8	31 1/4	4	2 1/2	1/4, 1/2	1/4

Notes

- **Hubs:** Units supplied with two closing plates. To order hubs as extra, refer to the hub suffix chart on the accessories page.
- **Connector Kits:** For line side connector kits, order as extra **K3082** (350 kcmil), **K3441** (600 kcmil), twin **K3442** (350 kcmil), twin **K3083** (600 kcmil). Line connectors can be reversed to change from "OH" to "UG" service.
- **Bypass:** Lever supplies clamping action on meter spades and also operates bypass device.



Please consult serving utility for their requirements prior to ordering or installing, as specifications and approvals vary by utility, and may require local electrical inspector approval. All installations must be installed by a licensed electrician and must comply with all national and local codes, laws and regulations. Milbank reserves the right to make changes in specifications and features shown without notice or obligation.

Multi-Position Sockets

125 & 200 Amp per Position | 4 Terminal | 120/240 VAC

35
125 & 200 AMP
MULTI-
POSITION
SOCKETS



U2854-X-4/125
(Order circuit breakers as extra)



U2866-X

125 Amp per Position | Multi-Position Sockets | Ringless

Catalog Number	Amp	Positions	Main Bus Rating	Line Connector Size	Dimensions		
					D"	W"	H"
U2852-X	125	2	200 Amp	3/8" x 16 Stud*	5 13/16	18	25
U2853-X	125	3	200 Amp	3/8" x 16 Stud*	5 13/16	18	37
U2854-X	125	4	400 Amp	3/8" x 16 Stud*	4 7/8	31	25
U2855-X	125	5	400 Amp	3/8" x 16 Stud*	4 7/8	31	37
U2856-X	125	6	400 Amp	3/8" x 16 Stud*	4 7/8	31	37

200 Amp per Position | Multi-Position Sockets | Ringless

Catalog Number	Amp	Positions	Main Bus Rating	Line Connector Size	Dimensions		
					D"	W"	H"
U2862-X	200	2	250 Amp	3/8" x 16 Stud*	5 13/16	21	29
U2863-X	200	3	300 Amp	3/8" x 16 Stud*	5 13/16	21	41
U2864-X	200	4	400 Amp	3/8" x 16 Stud*	4 7/8	36	29
U2865-X	200	5	600 Amp	3/8" x 16 Stud*	4 7/8	36	41
U2866-X	200	6	600 Amp	3/8" x 16 Stud*	4 7/8	36	41

Connector Kits*

Size	Suffix	Kit Number	Compatible With	Wire Range
Single	-K1	K1539	U2852-56, U2862-66	#6-350
	-K3	K1540	U2854-56, U2864-66	#4-600
Twin	-K2	K1350	U2854-56, U2863-66	#6-350
	-K4	K1541	U2864-66	#2-600

Breaker Chart

Manufacturer	125-200 Amp	125 amps or less
Cutler Hammer	BR, BJ	Quicklag P, BR, HQP
Siemens	QNR	QP
Siemens/Murray	MD	MP
G.E.	Q Line	Q Line
Square D	—	Homeline

Notes

- **Connectors:** For line wire connector kits, order separately.
- **Fifth Terminal:** For field mounted fifth terminal, order catalog number **K2381**. Order one per meter position.
- **Breakers:** Units have provision for one double pole main per meter position. Breakers not included.
- **Short Circuit Current Rating:** 10K AIC. However, this rating is limited to the lowest interrupting capacity of any circuit breaker installed. Watthour meter not included in short circuit current rating.
- **Knockouts:** See next page for drawings and knockout configurations.

Please consult serving utility for their requirements prior to ordering or installing, as specifications and approvals vary by utility, and may require local electrical inspector approval. All installations must be installed by a licensed electrician and must comply with all national and local codes, laws and regulations. Milbank reserves the right to make changes in specifications and features shown without notice or obligation.



Catalog Number	Knockouts		
	1	2	3
U2852-X	3	1¼	¼, ½
U2853-X	3	1¼	¼, ½
U2854-X	3	1¼	¼, ½
U2855-X	3	1¼	¼, ½
U2856-X	3	1¼	¼, ½
U2862-X	3	2	¼, ½
U2863-X	3	2	¼, ½
U2864-X	3	2	¼, ½
U2865-X	3	2	¼, ½
U2866-X	3	2	¼, ½

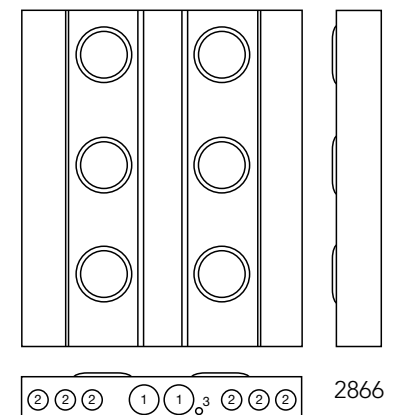
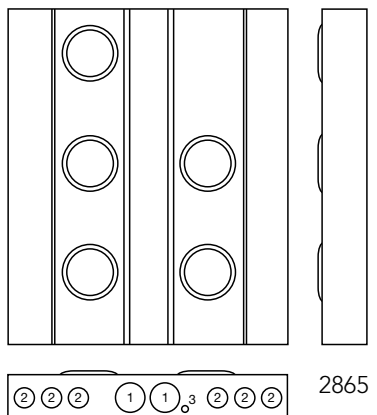
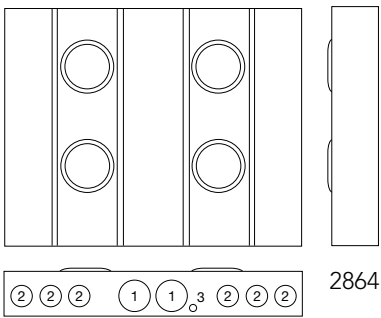
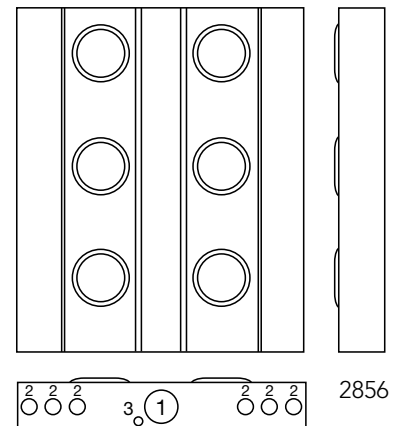
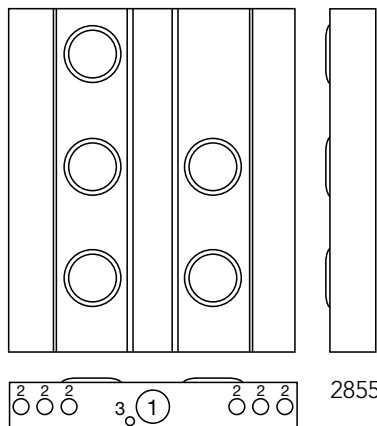
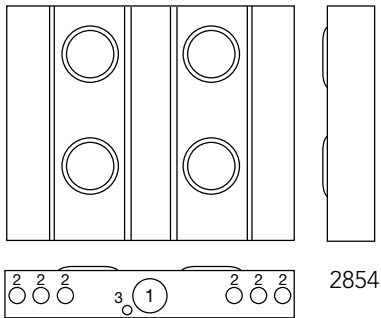
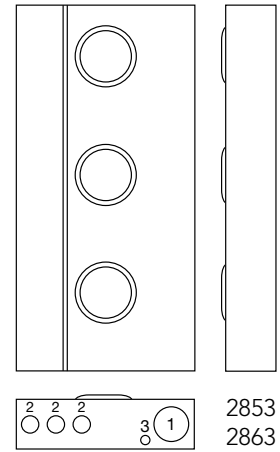
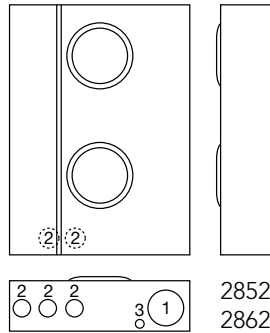

Please consult serving utility for their requirements prior to ordering or installing, as specifications and approvals vary by utility, and may require local electrical inspector approval. All installations must be installed by a licensed electrician and must comply with all national and local codes, laws and regulations. Milbank reserves the right to make changes in specifications and features shown without notice or obligation.

Multi-Position Meter Mains

125 & 200 Amp | 4 Terminal | Ringless | 120/240 VAC

37
125 & 200 AMP
MULTI-
POSITION
METER MAINS



U5882-X



U5884-X

Breaker Chart

Manufacturer	125-200 Amp	125 Amp or less
Cutler Hammer	BR, BJ	Quicklag P, BR, HQP
Siemens	QNR	QP
Siemens/Murray	MD	MP
G.E.	Q Line	Q Line
Square D	—	Homeline

125 Amp per Position | 4 Terminal | Multi-Position Meter Main | Ringless

Catalog Number	Amp	Positions	Service	Hub	Connectors CU/AL	Dimensions			Weight (lbs.)
					Line	D"	W"	H"	
U5902-X	125	2	OH/UG	C.P.	3/8" x 16 Stud	5 1/8"	26 1/2"	30"	58
U5903-X	125	3	OH/UG	C.P.	3/8" x 16 Stud	5 1/8"	34 5/8"	30"	88
U5904-X	125	4	OH/UG	C.P.	3/8" x 16 Stud	5 1/8"	42 2/5"	30"	107
U5905-X	125	5	OH/UG	C.P.	3/8" x 16 Stud	5 1/8"	51 1/20"	30"	128
U5906-X	125	6	OH/UG	C.P.	3/8" x 16 Stud	5 1/8"	59 3/10"	30"	146

200 Amp per Position | 4 Terminal | Multi-Position Meter Main | Ringless

Catalog Number	Amp	Positions	Service	Hub	Connectors CU/AL	Dimensions			Weight (lbs.)
					Line	D"	W"	H"	
U5882-X	200	2	OH/UG	C.P.	3/8" x 16 Stud	5 1/8"	26 1/2"	30"	58
U5883-X	200	3	OH/UG	C.P.	3/8" x 16 Stud	5 1/8"	34 5/8"	30"	88
U5884-X	200	4	OH/UG	C.P.	3/8" x 16 Stud	5 1/8"	42 2/5"	30"	107
U5885-X	200	5	OH/UG	C.P.	3/8" x 16 Stud	5 1/8"	51 1/20"	30"	128
U5886-X	200	6	OH/UG	C.P.	3/8" x 16 Stud	5 1/8"	59 3/10"	30"	146

Notes

- **Knockouts:** See drawings on the next page.
- **Optional:** Factory installed breakers are available - consult factory.
- **AIC Rating:** All models are rated 22K AIC. However, this rating is limited to the lowest interrupting capacity of any circuit breaker installed. Watthour meter not included in short circuit current rating.
- **Hub:** Units supplied with one (1) closing plate. Order hubs separately, see accessory page.
- **Fifth Terminal:** For field installed fifth terminal, order **K5T**.
- **Connectors:** Socket is supplied with 3/8" - 16 hex head nuts with Belleville washers. For connector lug kits, order as extra from chart on page 76. Separate lug kits are required for line and load.

Please consult serving utility for their requirements prior to ordering or installing, as specifications and approvals vary by utility, and may require local electrical inspector approval. All installations must be installed by a licensed electrician and must comply with all national and local codes, laws and regulations. Milbank reserves the right to make changes in specifications and features shown without notice or obligation.



Multi-Position Meter Mains

Dimensional Information

Knockouts				
1	2	3	4	5
3	2½	1	⅞	¼

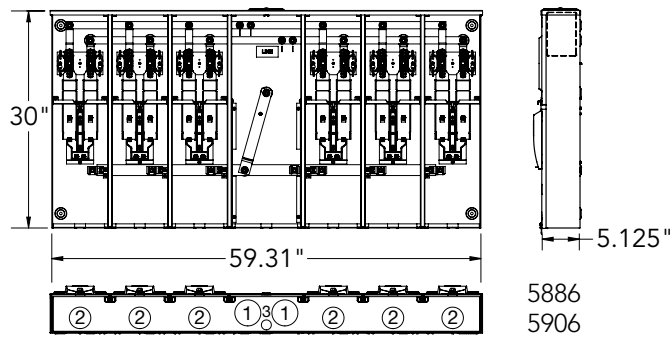
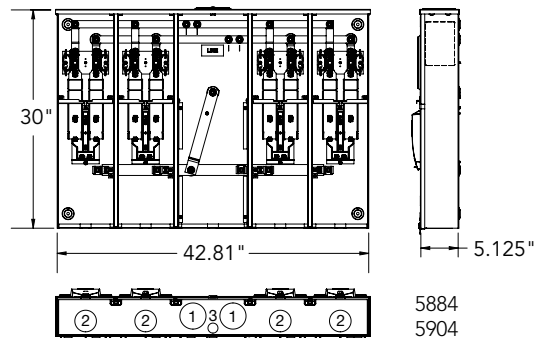
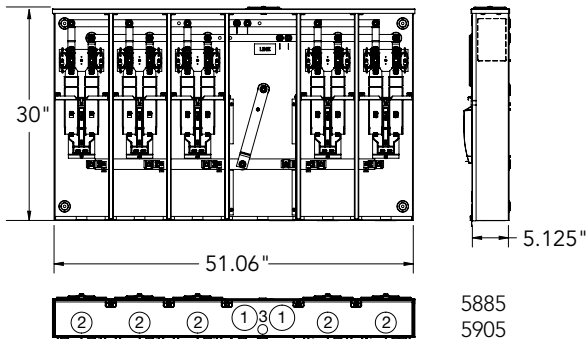
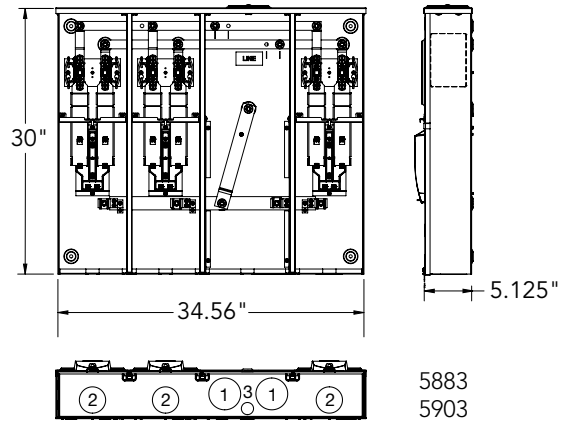
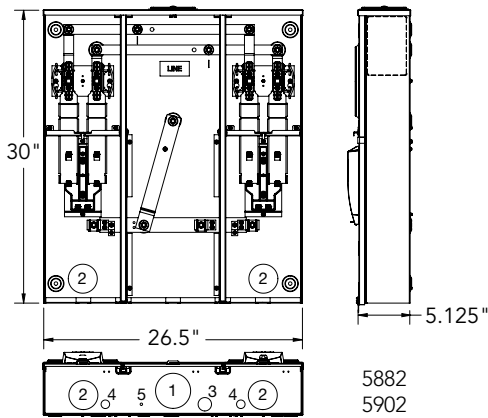

Please consult serving utility for their requirements prior to ordering or installing, as specifications and approvals vary by utility, and may require local electrical inspector approval. All installations must be installed by a licensed electrician and must comply with all national and local codes, laws and regulations. Milbank reserves the right to make changes in specifications and features shown without notice or obligation.

Lever Bypass Multi-Position Sockets

200 Amp per Position | 5 Terminal | Ringless | 120/240 VAC

39
200 AMP
LEVER BYPASS
MULTI-
POSITION



U4374-Xt-5T9

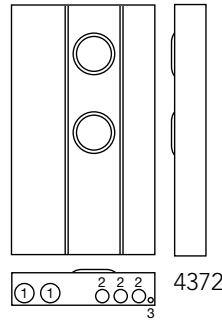

4372

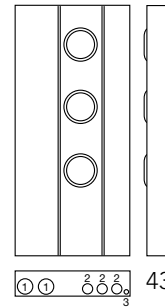

4373

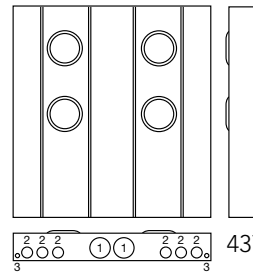

4374

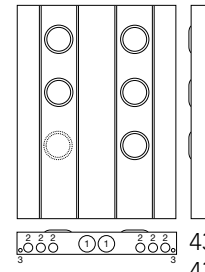

4375
4376

200 Amp per Position | 5 Terminal | Lever Bypass Multi-Position Sockets | Ringless

Catalog Number	Positions	Main Bus Rating	Line Connector Size	Dimensions			Knockouts		
				D"	W"	H"	1	2	3
U4372-Xt-5T9	2	320 amp	3/8" x 16 Stud*	6	27 3/4	48	3	2	1/4, 1/2
U4373-Xt-5T9	3	480 amp	3/8" x 16 Stud*	6	27 3/4	60	3	2	1/4, 1/2
U4374-Xt-5T9	4	640 amp	3/8" x 16 Stud*	6	45	48	4	2	1/4, 1/2
U4375-Xt-5T9	5	640 amp	3/8" x 16 Stud*	6	45	60	4	2	1/4, 1/2
U4376-Xt-5T9	6	640 amp	3/8" x 16 Stud*	6	45	60	4	2	1/4, 1/2

Connector Kits*

Size	Suffix	Kit Number	Wire Range
Single	-K3	K1540	#4-600
Twin	-K2	K1350	#6-350
	-K4	K1541	#2-600

Breaker Chart

Manufacturer	125-200 amps	125 amps or less
Cutler Hammer	BR, BJ	Quicklag P, BR, HQP
Siemens (ITE)	QN	QP
Siemens (Murray/Crouse Hinds)	MD	MP
G.E.	Q Line	Q Line
Square D	—	Homeline

Notes

- ***Connectors:** For line wire connector kits, order separately (see chart above).
- **Breakers:** Units have provision for one double pole main per meter position. Breakers not included. Order as extra (see chart above).
- **Bypass:** Lever supplies clamping action on meter spades and also operates bypass device.
- **Short Circuit Current Rating:** 10K AIC. However, this rating is limited to the lowest interrupting capacity of any circuit breaker installed. Watthour meter not included in short circuit current rating.

Please consult serving utility for their requirements prior to ordering or installing, as specifications and approvals vary by utility, and may require local electrical inspector approval. All installations must be installed by a licensed electrician and must comply with all national and local codes, laws and regulations. Milbank reserves the right to make changes in specifications and features shown without notice or obligation.



40

200 & 320 AMP
MULTI POSITION
SOCKET

Demand Side Management

200 & 320 Amp | 4 & 5 Terminal | Ringless



U4811-O-21

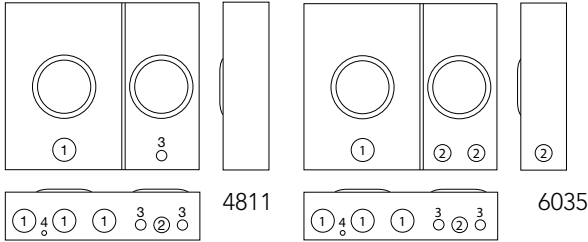

U6158-O-MNV

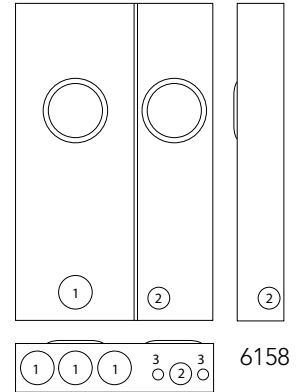

200 Amp | 4 Terminal | Two Position | Off-Peak Metering

Catalog Number	Service	Connectors/ CU		Bypass	Dimensions			Knockouts			
		Left Side (Line & Load)	Right Side		D"	W"	H"	1	2	3	4
U4811-O-21	UG	#6-350	Terminal Strip	Lever/Plunger	4 $\frac{7}{8}$	21	18	2	1 $\frac{1}{4}$	$\frac{3}{4}$	1 $\frac{1}{4}$, $\frac{1}{2}$
U6035-O	UG	#6-350	Terminal Strip	Lever/None	4 $\frac{7}{8}$	21	18	2	1	$\frac{3}{4}$	1 $\frac{1}{4}$, $\frac{1}{2}$

320 Amp | 5 Terminal | Two Position | Off-Peak Metering

Catalog Number	Service	Connectors/ CU		Bypass	Dimensions			Knockouts			
		Left Side (Line & Load)	Right Side		D"	W"	H"	1	2	3	4
U6158-O-MNV	UG	(2) #6-350	6 - 2/0	Lever/None	4 $\frac{7}{8}$	23	36	3	1 $\frac{1}{4}$	$\frac{3}{4}$	—

Notes

- **Fifth Terminal:** For field installed fifth terminal on left (200 amp) side, order catalog number **K3866**.
- Low voltage compartment in lower right corner

U4811-O-21	U6035-O	U6158-O-MNV
Left position is a 200 amp, 4 terminal heavy duty lever bypass interior - Right position is 20 amp rated with a fifth terminal in the 9 o'clock position and a plunger bypass - Right position is pre-wired to the terminal strip	Left side socket Load side wired to pull out. Left position amperage rating is a 200 Amp, 4 terminal, heavy duty lever bypass interior. right position is 100 amp 4 terminal.	Left side socket is 320 amp 4 terminal heavy duty lever bypass, and Load side wire to a two pole 20 amp fuse block. right side socket is 100 amp 5 terminal. Terminal block included on right side.



Please consult serving utility for their requirements prior to ordering or installing, as specifications and approvals vary by utility, and may require local electrical inspector approval. All installations must be installed by a licensed electrician and must comply with all national and local codes, laws and regulations. Milbank reserves the right to make changes in specifications and features shown without notice or obligation.

Lever Bypass Multi-Position Meter Main

200 Amp per Position | 5 Terminal | 120/240 VAC

4 1
LEVER BYPASS
MULTI-POSITION
METER MAINS

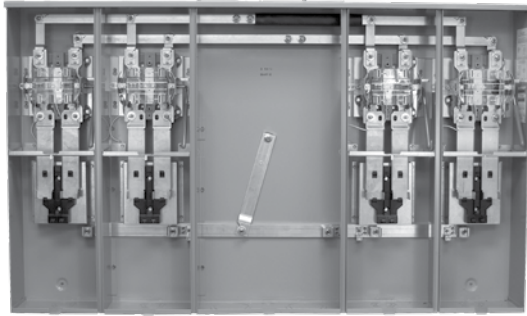

U5974-Xt-5T9-AMS

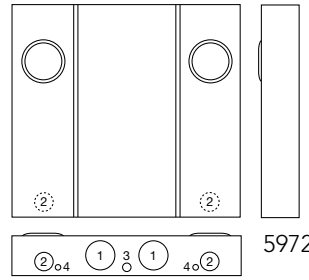

5972

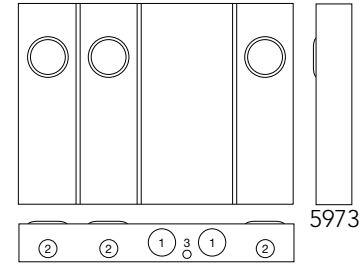

5973

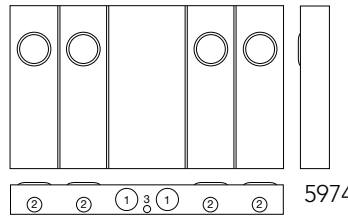

5974

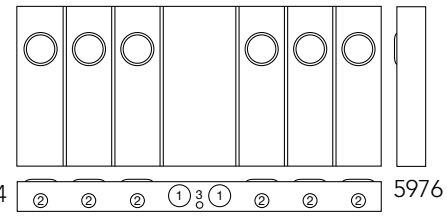

5976

NOTE

Ameren allows these units at 240 Volts and below.



200 Amp per Position | 5 Terminal | Multi-Position Meter Main | Ringless

Catalog Number	Positions	Service	Hub	Connectors CU/AL		Dimensions			Knockouts			
				Line	Load	D"	W"	H"	1	2	3	4
U5972-Xt-5T9-AMS	2	OH/UG	(2) C.P.	1/0-350	C.B.	5 ³¹ / ₃₂	36 ³ / ₈	34	4	2 ¹ / ₂	1	1/2
U5973-Xt-5T9-AMS	3	OH/UG	(2) C.P.	1/0-350	C.B.	5 ³¹ / ₃₂	46 ¹ / ₂	34	4	2 ¹ / ₂	1	-
U5974-Xt-5T9-AMS	4	OH/UG	(2) C.P.	1/0-350	C.B.	5 ³¹ / ₃₂	57 ¹ / ₁₆	34	4	2 ¹ / ₂	1	-
U5975-Xt-5T9-AMS	5	OH/UG	(2) C.P.	1/0-350	C.B.	5 ³¹ / ₃₂	67 ¹ / ₈	34	4	2 ¹ / ₂	1	-
U5976-Xt-5T9-AMS	6	OH/UG	(2) C.P.	1/0-350	C.B.	5 ³¹ / ₃₂	77 ⁹ / ₁₆	34	4	2	1	-

Notes

- **AIC Rating:** All models are rated 22K AIC.
- **Hub:** Units supplied with two closing plates. Order hubs separately from the chart below.
- **Lug Kits:** Sold separately.
- **Front Covers:** Barrel lock option available - contact factory.

Hub Chart

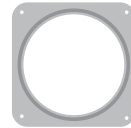
		
A8110 3" hub	A8111 3 ¹ / ₂ " hub	A8112 4" hub

Bus Chart

Catalog Number	Amp
U5972-Xt-5T9-AMS	320
U5973-Xt-5T9-AMS	450
U5974-Xt-5T9-AMS	640
U5975-Xt-5T9-AMS	640
U5976-Xt-5T9-AMS	640

Breaker Chart

Manufacturer	125-200 Amp	125 Amp or less
Cutler Hammer	BR, BJ	Quicklag P, BR, HQP
Siemens	QNR	QP
Siemens/Murray	MD	MP
G.E.	Q Line	Q Line
Square D	—	Homeline

Please consult serving utility for their requirements prior to ordering or installing, as specifications and approvals vary by utility, and may require local electrical inspector approval. All installations must be installed by a licensed electrician and must comply with all national and local codes, laws and regulations. Milbank reserves the right to make changes in specifications and features shown without notice or obligation.



Lever Bypass Temporary Power Outlet

125 Amp | 5 Terminal | Ringless | 120/240 VAC



U5091-RL-76GBGR

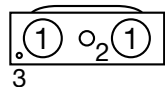
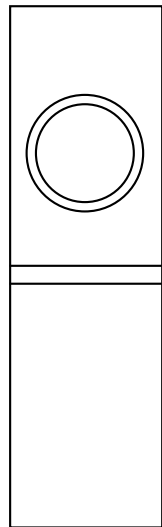

5091



U6134-RL-76GBGR

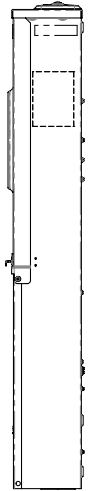
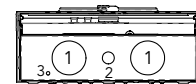
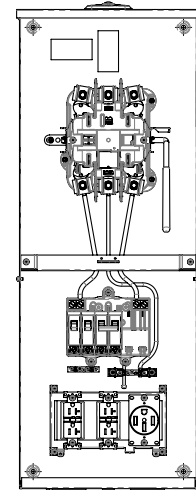

6134

125 Amp | 5 Terminal | Metered Temporary Power Outlet | Lever Bypass | Ringless

Catalog Number	Service	Hub	Line Side Connectors	Dimensions			Knockouts		
				D"	W"	H"	1	2	3
U5091-RL-76GBGR	OH	H.O.	#6-350 kcmil	4 ⁷ / ₈	10	34	2	1/2	1/4
U6134-RL-76GBGR	OH/UG	H.O.	#6-350 kcmil	4 ² / ₂₅	13	35	2	1/2	1/4

Notes

- **Breakers:** Factory wired with two (2) 20 amp/120V breakers and one (1) 50 amp/120-240V GFCI breaker.
- **Receptacles:** Includes two (2) factory installed 20 amp/120V duplex GFCI receptacles and one (1) 50 amp/120-240V receptacle.
- **Bypass:** Lever supplies clamping action on meter spades and also operates bypass device.
- **Fifth Terminal:** Includes factory installed fifth terminal at 9 o'clock.
- **Short Circuit Current Rating:** 10K AIC. However, this rating is limited to the lowest interrupting capacity of any circuit breaker installed. Watthour meter not included in short circuit current rating.



Please consult serving utility for their requirements prior to ordering or installing, as specifications and approvals vary by utility, and may require local electrical inspector approval. All installations must be installed by a licensed electrician and must comply with all national and local codes, laws and regulations. Milbank reserves the right to make changes in specifications and features shown without notice or obligation.

Surface Mount Power Outlet

U5000 "Millennium" Series | Unmetered

43
SURFACE
MOUNT
POWER
OUTLET



U5000-XL-75

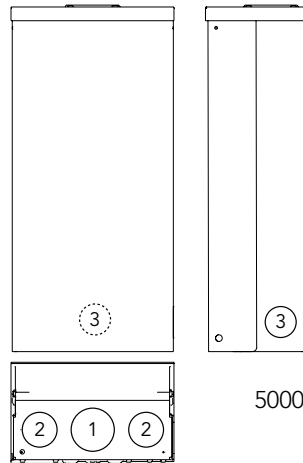

5000



U5000-XL-332

125 Amp | Unmetered Surface Mount Power Outlet

Catalog Number	Receptacle Configuration	Circuit Breaker Configuration	Loop Feed Line	Dimensions			Knockouts		
				D"	W"	H"	1	2	3
U5000-XL	—	—	(2) 1/0-#12	5½	9⅞	19¼	2	1½	1¼
U5000-XL-41	A	V	(2) 1/0-#12	5½	9⅞	19¼	2	1½	1¼
U5000-XL-332	B	W	(2) 1/0-#12	5½	9⅞	19¼	2	1½	1¼
U5000-XL-55	C	X	(2) 1/0-#12	5½	9⅞	19¼	2	1½	1¼
U5000-XL-75	D	Y	(2) 1/0-#12	5½	9⅞	19¼	2	1½	1¼
U5000-XL-75GB	E	Z	(2) 1/0-#12	5½	9⅞	19¼	2	1½	1¼

Receptacle Configurations

A	B	C	D	E
(1) TT30R, (1) 5-20R GFI	(2) TT30R, (1) 5-20R GFI	(1) 14-50R, (1) 5-20R GFI	(1) 14-50R, (1) TT30R, (1) 5-20R GFI	(1) 14-50R, (1) TT30R, (1) 5-20R

Circuit Breaker Configurations

V	W	X	Y	Z
(1) 30A, 1P, 120V (1) 20A, 1P, 120V	(2) 30A, 1P, 120V (1) 20A, 1P, 120V	(1) 50A, 2P, 120/240V (1) 20A, 1P, 120V	(1) 50A, 2P, 120/240V (1) 30A, 1P, 120V (1) 20A, 1P, 120V	(1) 50A, 2P, 120/240V (1) 30A, 1P, 120V (1) 20A, 1P, 120V GFI

Please consult serving utility for their requirements prior to ordering or installing, as specifications and approvals vary by utility, and may require local electrical inspector approval. All installations must be installed by a licensed electrician and must comply with all national and local codes, laws and regulations. Milbank reserves the right to make changes in specifications and features shown without notice or obligation.



Surface Mount Power Outlet

U5100 "Millennium" Series | Metered | Ring Type



U5100-XL-75

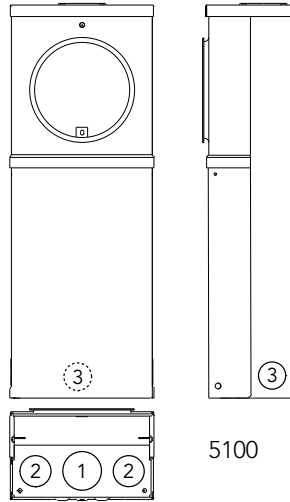

5100



U5100-XL-552GR

125 Amp | Metered Surface Mount Power Outlet

Catalog Number	Receptacle Configuration	Circuit Breaker Configuration	Line Side Connectors	Dimensions			Knockouts		
				D"	W"	H"	1	2	3
U5100-XL	—	—	#6-250	5½	9⅞	25	2	1½	1¼
U5100-XL-41	A	V	#6-250	5½	9⅞	25	2	1½	1¼
U5100-XL-55	B	W	#6-250	5½	9⅞	25	2	1½	1¼
U5100-XL-75	C	X	#6-250	5½	9⅞	25	2	1½	1¼
U5100-XL-75GB	D	Y	#6-250	5½	9⅞	25	2	1½	1¼
U5100-XL-552GR	E	Z	#6-250	5½	9⅞	25	2	1½	1¼

Receptacle Configurations

A	B	C	D	E
(1) TT30R, (1) 5-20R GFI	(1) 14-50R, (1) 5-20R GFI	(1) 14-50R, (1) TT30R, (1) 5-20R GFI	(1) 14-50R, (1) TT30R, (1) 5-20R	(1) 14-50R, (1) TT30R, (1) 5-20R

Circuit Breaker Configurations

V	W	X	Y	Z
(1) 30A, 1P, 120V (1) 20A, 1P, 120V	(1) 50A, 2P, 120/240V (1) 20A, 1P, 120V	(1) 50A, 2P, 120/240V (1) 30A, 1P, 120V (1) 20A, 1P, 120V	(1) 50A, 2P, 120/240V (1) 30A, 1P, 120V (1) 20A, 1P, 120V GFI	(2) 50A, 2P, 120/240V (1) 20A, 1P, 120V



Please consult serving utility for their requirements prior to ordering or installing, as specifications and approvals vary by utility, and may require local electrical inspector approval. All installations must be installed by a licensed electrician and must comply with all national and local codes, laws and regulations. Milbank reserves the right to make changes in specifications and features shown without notice or obligation.

Power Outlet Pedestal

U5200 "Millennium" Series | Unmetered

45
POWER
OUTLET
PEDESTAL



U5200-XL-75

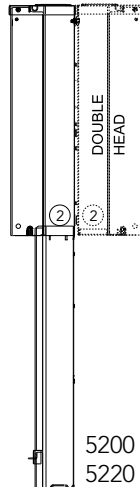
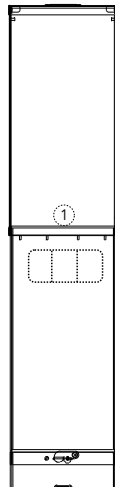

U5200-XL-55

125 Amp | Unmetered Power Outlet Pedestal

Catalog Number	Double Head Catalog Number	Receptacle Configuration	Circuit Breaker Configuration	Dimensions			Knockouts
				D"	W"	H"	1
U5200-XL	U5220-XL	—	—	5 ⁹ / ₁₆	9 ¹ / ₈	64 ¹ / ₂	1 ¹ / ₄
U5200-XL-41	U5220-XL-41	A	U	5 ⁹ / ₁₆	9 ¹ / ₈	64 ¹ / ₂	1 ¹ / ₄
U5200-XL-41GB	U5220-XL-41GB	B	V	5 ⁹ / ₁₆	9 ¹ / ₈	64 ¹ / ₂	1 ¹ / ₄
U5200-XL-55	U5220-XL-55	C	W	5 ⁹ / ₁₆	9 ¹ / ₈	64 ¹ / ₂	1 ¹ / ₄
U5200-XL-332	U5220-XL-332	D	X	5 ⁹ / ₁₆	9 ¹ / ₈	64 ¹ / ₂	1 ¹ / ₄
U5200-XL-75	U5220-XL-75	E	Y	5 ⁹ / ₁₆	9 ¹ / ₈	64 ¹ / ₂	1 ¹ / ₄
U5200-XL-75GB	U5220-XL-75GB	F	X	5 ⁹ / ₁₆	9 ¹ / ₈	64 ¹ / ₂	1 ¹ / ₄

Receptacle Configurations

A	B	C	D	E	F
(1) TT30R, (1) 5-20R GFI	(1) TT30R, (1) 5-20R	(1) 14-50R, (1) 5-20R GFI	(2) TT30R, (1) 5-20R GFI	(1) 14-50R, (1) TT30R, (1) 5-20R GFI	(1) 14-50R, (1) TT30R, (1) 5-20R

Circuit Breaker Configurations

U	V	W	X	Y	Z
(1) 30A, 1P, 120V (1) 20A, 1P, 120V	(1) 30A, 1P, 120V (1) 20A, 1P, 120V GFI	(1) 50A, 2P, 120/240V (1) 20A, 1P, 120V	(2) 30A, 1P, 120V (1) 20A, 1P, 120V	(1) 50A, 2P, 120/240V (1) 30A, 1P, 120V (1) 20A, 1P, 120V	(1) 50A, 2P, 120/240V (1) 30A, 1P, 120V (1) 20A, 1P, 120V GFI

Please consult serving utility for their requirements prior to ordering or installing, as specifications and approvals vary by utility, and may require local electrical inspector approval. All installations must be installed by a licensed electrician and must comply with all national and local codes, laws and regulations. Milbank reserves the right to make changes in specifications and features shown without notice or obligation.



Power Outlet Pedestal

U5300 "Millennium" Series | Metered | Ring Type



U5300-O-75

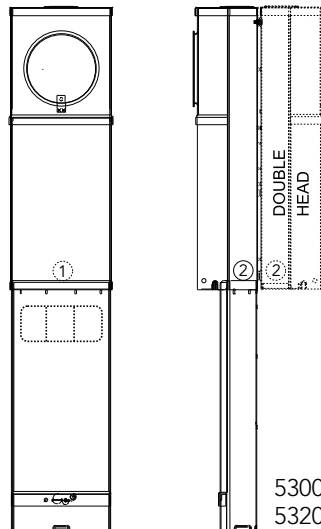

U5300-O-552GR

125 Amp | Metered Power Outlet Pedestal

Catalog Number	Double Head Catalog Number	Receptacle Configuration	Circuit Breaker Configuration	Dimensions			Knockouts
				D"	W"	H"	1
U5300-O	U5320-O	—	—	5 ⁵ / ₁₆	9 ⁷ / ₈	70 ¹ / ₄	1 ¹ / ₄
U5300-O-41	U5320-O-41	A	W	5 ⁵ / ₁₆	9 ⁷ / ₈	70 ¹ / ₄	1 ¹ / ₄
U5300-O-55	U5320-O-55	B	X	5 ⁵ / ₁₆	9 ⁷ / ₈	70 ¹ / ₄	1 ¹ / ₄
U5300-O-75	U5320-O-75	C	Y	5 ⁵ / ₁₆	9 ⁷ / ₈	70 ¹ / ₄	1 ¹ / ₄
U5300-O-552GR	U5320-O-552GR	D	Z	5 ⁵ / ₁₆	9 ⁷ / ₈	70 ¹ / ₄	1 ¹ / ₄

Receptacle Configurations

A	B	C	D
(1) TT30R, (1) 5-20R GFI	(1) 14-50R (1) 5-20R GFI	(1) 14-50R, (1) TT30R, (1) 5-20R GFI	(2) 14-50R, (1) 5-20R GFI

Circuit Breaker Configurations

W	X	Y	Z
(1) 30A, 1P, 120V (1) 20A, 1P, 120V	(1) 50A, 2P, 120/240V (1) 20A, 1P, 120V GFI	(1) 50A, 2P, 120/240V (1) 30A, 1P, 120V (1) 20A, 1P, 120V	(2) 50A, 2P, 120/240V (1) 20A, 1P, 120V



Please consult serving utility for their requirements prior to ordering or installing, as specifications and approvals vary by utility, and may require local electrical inspector approval. All installations must be installed by a licensed electrician and must comply with all national and local codes, laws and regulations. Milbank reserves the right to make changes in specifications and features shown without notice or obligation.

Replacement Receptacle Plates

For Millennium Series RV Products

47
REPLACEMENT
RECEPTACLE
PLATES

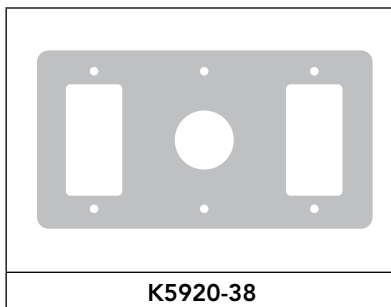
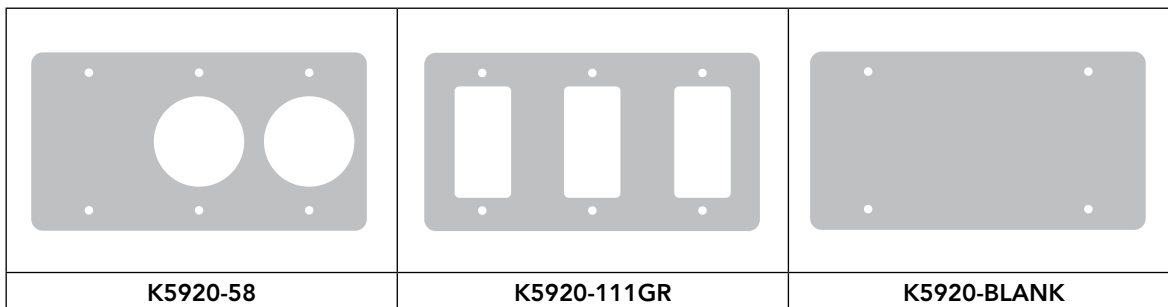
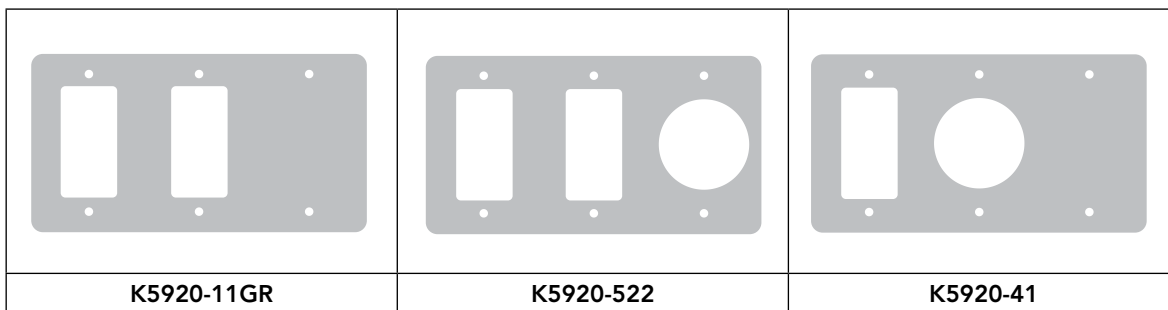
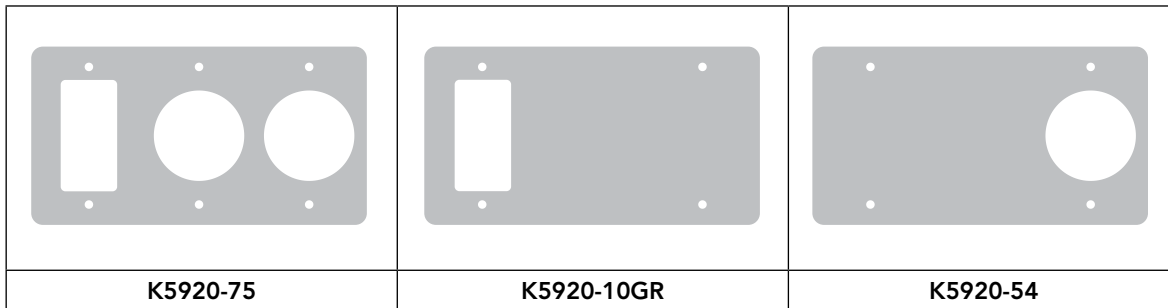

Notes

- For application details, consult factory.

Please consult serving utility for their requirements prior to ordering or installing, as specifications and approvals vary by utility, and may require local electrical inspector approval. All installations must be installed by a licensed electrician and must comply with all national and local codes, laws and regulations. Milbank reserves the right to make changes in specifications and features shown without notice or obligation.



48

200 AMP
METER MAIN
W/ LOAD
CENTER
PEDESTAL

Meter Main with Load Center Pedestal

200 Amp | 4 Terminal | Ringless | 120/240 VAC



U5136-O-200S-10GR
Picture shown with
receptacle installed

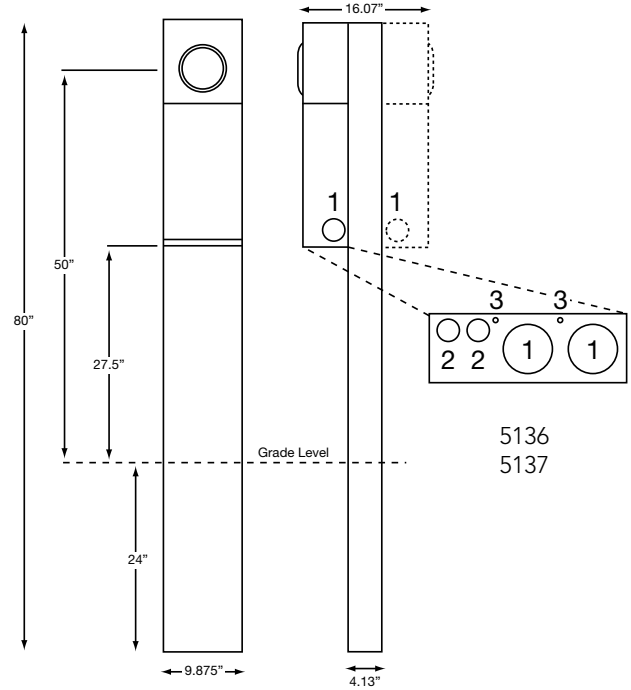

5136
5137

200 Amp | 4 Terminal | Meter Main with Pedestal | Ringless

Catalog Number	Service	Bypass	Connectors CU/AL		Dimensions			Knockouts		
			Line	Load	D"	W"	H"	1	2	3
U5136-O-200S	UG	Horn	#6-350	CB	4 $\frac{1}{8}$	9 $\frac{7}{8}$	80	2	1/2, 3/4	1/4
U5137-O-200S*	UG	Horn	#6-350	CB	4 $\frac{1}{8}$	9 $\frac{7}{8}$	80	2	1/2, 3/4	1/4

Notes

- **Parallel to Series Conversion:** For field converting from parallel wired to series wired order **K5194**.
- **Fifth Terminal:** For field installed fifth terminal, order **K5T**.
- **Stabilizer Foot:** For field installed stabilizer foot, order **K5415**.
- **Penta Bolt Locking:** For field installed pedestal fronts penta bolt locking, order **K5039**.
- **Receptacles:** Consult factory for installed receptacle assemblies.
- **Short Circuit Current Rating:** 22K AIC. However, this rating is limited to the lowest interrupting capacity of any circuit breaker installed. Watthour meter not included in short circuit current rating.
- ***U5137:** Double power head version.



Please consult serving utility for their requirements prior to ordering or installing, as specifications and approvals vary by utility, and may require local electrical inspector approval. All installations must be installed by a licensed electrician and must comply with all national and local codes, laws and regulations. Milbank reserves the right to make changes in specifications and features shown without notice or obligation.

Lever Bypass Meter Pedestals

200 Amp | 5 & 7 Terminal | Ringless | 600 VAC

49
200 AMP
LEVER BYPASS
METER
PEDESTALS



U9107-O-5T9

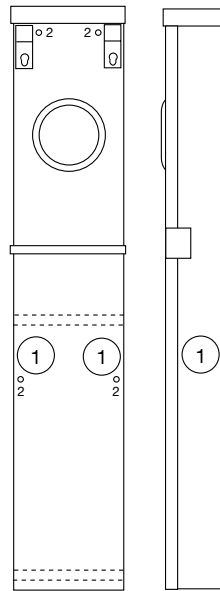

4724
9107
9108



U4724-O-5T9

200 Amp | 5 Terminal | Metered Pedestals | Lever Bypass | Ringless

Catalog Number	Service	Hub	Connectors CU/AL		Bypass	Dimensions			Knockouts	
			Line	Load		D"	W"	H"	1	2
U9108-O-5T9	UG	Blank	3/0-4/0	#6-350	Lever	6	11	58	2½	½, ¾
U4724-O-5T9	UG	Blank	3/0-4/0	#6-350	Lever	6	11	64	2½	½, ¾

Notes

- **Bypass:** Lever supplies clamping action on meter spades and also operates bypass device.
- **Neutral Disconnect:** The **U9108** has a manual neutral disconnect bolt.
- **Direct Burial:** For free standing use, order separately burial kit **S3488**.
- **Fifth Terminal:** Includes factory installed fifth terminal at 9 o'clock. For fifth terminal at 6 o'clock, substitute **-5T6** suffix in catalog number.

200 Amp | 7 Terminal | Metered Pedestals | Lever Bypass | Ringless

Catalog Number	Service	Hub	Connectors CU/AL		Bypass	Dimensions			Knockouts	
			Line	Load		D"	W"	H"	1	2
U9107-O	UG	Blank	3/0-4/0	#6-350	Lever	6	11	58	2½	¼

Notes

- **Bypass:** Lever supplies clamping action on meter spades and also operates bypass device.
- **Direct Burial:** For free standing use, order separately burial kit **S3488**.

Please consult serving utility for their requirements prior to ordering or installing, as specifications and approvals vary by utility, and may require local electrical inspector approval. All installations must be installed by a licensed electrician and must comply with all national and local codes, laws and regulations. Milbank reserves the right to make changes in specifications and features shown without notice or obligation.



50

200 AMP
METER MAIN
W/ LOAD
CENTER
PEDESTAL

Meter Main with Load Center Pedestal

200 Amp | 4 & 5 Terminal | Lever Bypass | 120/240 VAC

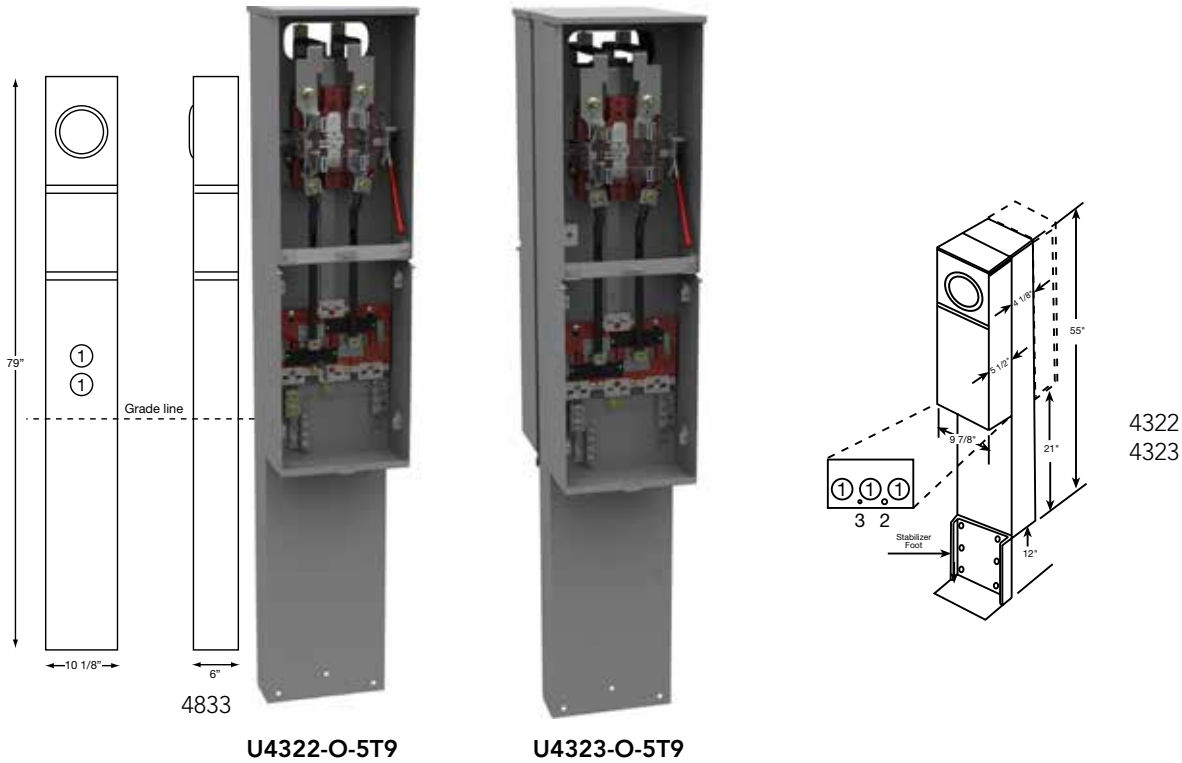

200 Amp | 4 & 5 Terminal | Meter Main Pedestals | Lever Bypass | Ringless

4-Terminal Catalog Number	5-Terminal Catalog Number	Meter Positions	Bypass	Twin Line Connectors CU/AL	Circuit Provisions	Knockouts			Dimensions		
						1	2	3	D"	W"	H"
U4322-O	U4322-O-5T9	Single	Lever	#6-350	6	2	1/2	1/4	9 5/8	9 7/8	55
U4323-O	U4323-O-5T9	Double	Lever	#6-350	6	2	1/2	1/4	15 1/8	9 7/8	55
U4833-O*	U4833-O-5T9*	Single	Lever	#6-350	6	2 1/2	—	—	6	10 1/8	79

Notes

- **Lever Bypass:** Lever provides clamping action on meter spades and also operates bypass device
- **Application:** The U4322 & U4323 pedestals are suitable for use as service equipment or mobile home service equipment. Includes direct burial kit K5081/K3188. For pad mounting, order kit K5151.
- **Breakers:** These units are wired as parallel mains and have provisions for six circuits: six single-pole or three double-pole breakers. See chart on page 73. Quadplex style breakers may be used in accordance to the NEC. If main breaker is used, there are provisions for two 2-pole breakers or four 1-pole breakers in series. ***NOTE:** The U4833 is wired as parallel main and has provisions for (1) double pole large frame UQFP-(AMP) or UQFPH-(AMP) main breaker, and (4) single pole, or (1) double pole and (2) single pole small frame branch breakers. See chart on page 74.
- **Fifth Terminal Kit:** For field installed fifth terminal order catalog number K3865 (neutral wire provided) or K3866 (no neutral wire). Units with -5T9 suffix supplied with fifth terminal factory installed at 9 o'clock.
- **Short Circuit Current Rating:** 10K AIC. However, this rating is limited to the lowest interrupting capacity of any circuit breaker installed. Watthour meter not included in short circuit current rating.



Please consult serving utility for their requirements prior to ordering or installing, as specifications and approvals vary by utility, and may require local electrical inspector approval. All installations must be installed by a licensed electrician and must comply with all national and local codes, laws and regulations. Milbank reserves the right to make changes in specifications and features shown without notice or obligation.

Meter Main with Load Center Pedestal

200 Amp | 5 Terminal | Lever Bypass | Ringless

5 1
200 AMP
METER MAIN
W/ LOAD
CENTER
PEDESTAL

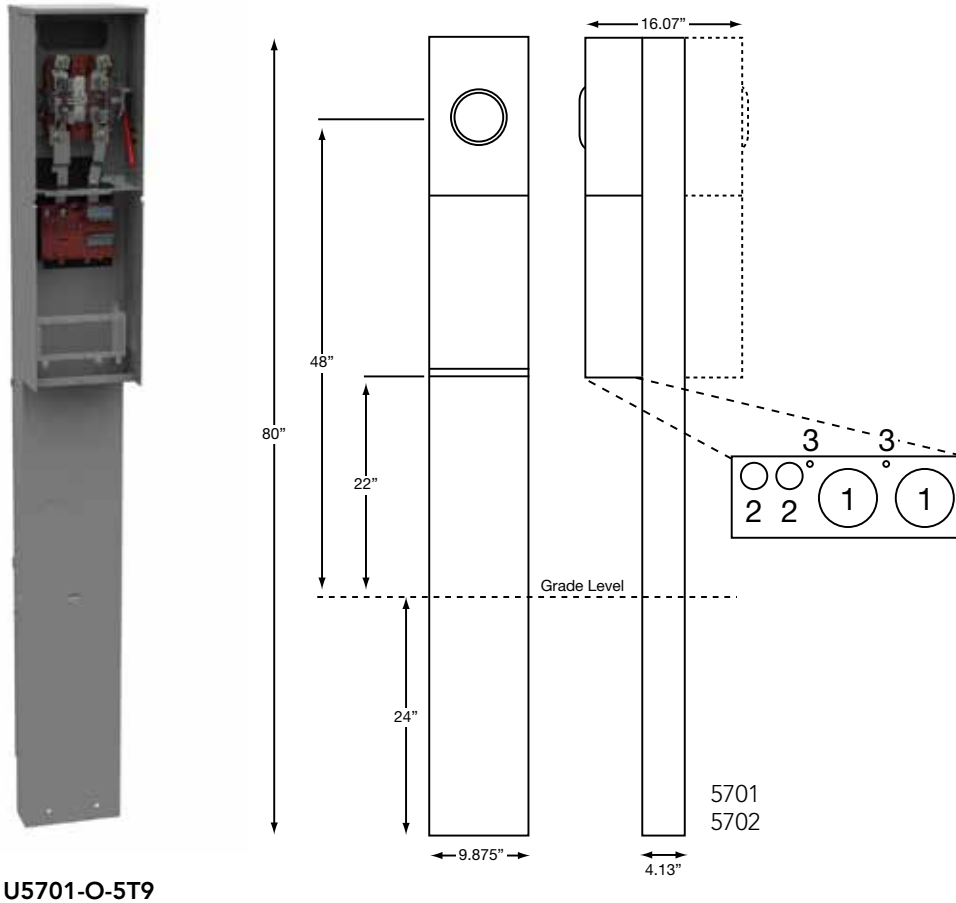

U5701-O-5T9

200 Amp | 5 Terminal | Meter Main Pedestal | Lever Bypass | Ringless

Catalog Number	Service	Connectors CU/AL		Dimensions			Knockouts		
		Line	Load	D"	W"	H"	1	2	3
U5701-O-5T9	UG	#6-350	CB	4 $\frac{1}{8}$	9 $\frac{7}{8}$	80	2	1/2, 3/4	1/4
U5702-O-5T9	UG	#6-350	CB	4 $\frac{1}{8}$	9 $\frac{7}{8}$	80	2	1/2, 3/4	1/4
U5703-O-5T9	UG	#6-350	CB	4 $\frac{1}{8}$	9 $\frac{7}{8}$	56	2	1/2, 3/4	1/4

Notes

- **Parallel to Series Conversion:** For field converting from parallel wired to series wired order **K5194**.
- **Stabilizer Foot:** For field installed stabilizer foot, order **K5415**.
- **Receptacles:** Consult factory for installed receptacle assemblies.
- **Breakers:** Units will accept Milbank UQFP or UQFPH for main breaker. These units are wired as parallel mains and have provisions for one large frame two pole breaker and four spaces for either four small frame single pole breakers or two double pole small frame breakers. Quadplex style breakers may be used in accordance to the NEC.
- **U5701:** Rated for 22K
- **Pad Mounting:** For pad mounting **U5703**, order kit **K5035**.

Please consult serving utility for their requirements prior to ordering or installing, as specifications and approvals vary by utility, and may require local electrical inspector approval. All installations must be installed by a licensed electrician and must comply with all national and local codes, laws and regulations. Milbank reserves the right to make changes in specifications and features shown without notice or obligation.



52

100 & 200 AMP
RESIDENTIAL
PEDESTAL

Meter Main with Main Breaker

100 & 200 Amp | 4 Terminal | Lever Bypass | Ringless



U6221-O-100-10GR

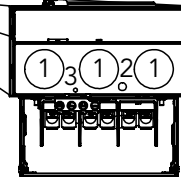
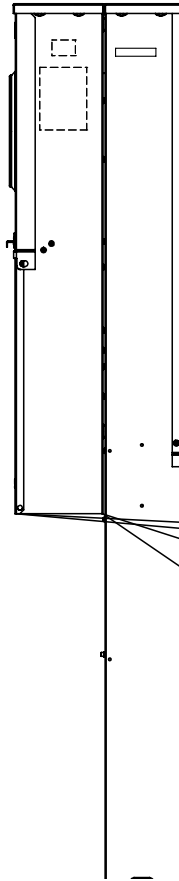
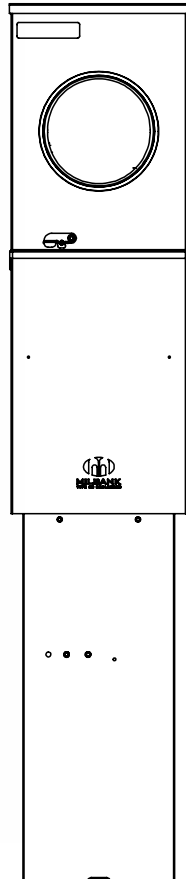

U6221-O-200-10GR

100 & 200 Amp | 4 Terminal | Meter Main Pedestal | Lever Bypass | Ringless

Catalog Number	Service	Connectors CU/AL		Dimensions			Knockouts		
		Line	Load	D"	W"	H"	1	2	3
U6221-O-100-10GR	UG	#6-350 kcmil	#6-350 kcmil	10	11	80	2	½	¼
U6221-O-200-10GR	UG	#6-350 kcmil	#6-350 kcmil	10	11	80	2	½	¼

Notes

- **Fifth Terminal:** For field installed fifth terminal, order **K5T** for **U6221** use the **K3865**.
- **Breakers:** Rated 22K AIC with Milbank **QN2200RH** main installed.
- **Interlock Kit:** For generator auxiliary circuit breaker interlock, order **K5815** for large **QN** with small frame **Q**; order **K5820** for large frame **QN** with large frame **QN**; order **K5830** for small frame **Q** to small frame **Q**.
- **Sub Feed Lugs:** #6-350 sub feed lugs provided on 8 circuit interior.
- Comes from the factory with 20 amp GFCI Receptacle installed.



Please consult serving utility for their requirements prior to ordering or installing, as specifications and approvals vary by utility, and may require local electrical inspector approval. All installations must be installed by a licensed electrician and must comply with all national and local codes, laws and regulations. Milbank reserves the right to make changes in specifications and features shown without notice or obligation.

Lever Bypass Residential Pedestal

320 Amp Continuous | 400 Amp Max | 5 Terminal

53
320 AMP
RESIDENTIAL
PEDESTAL

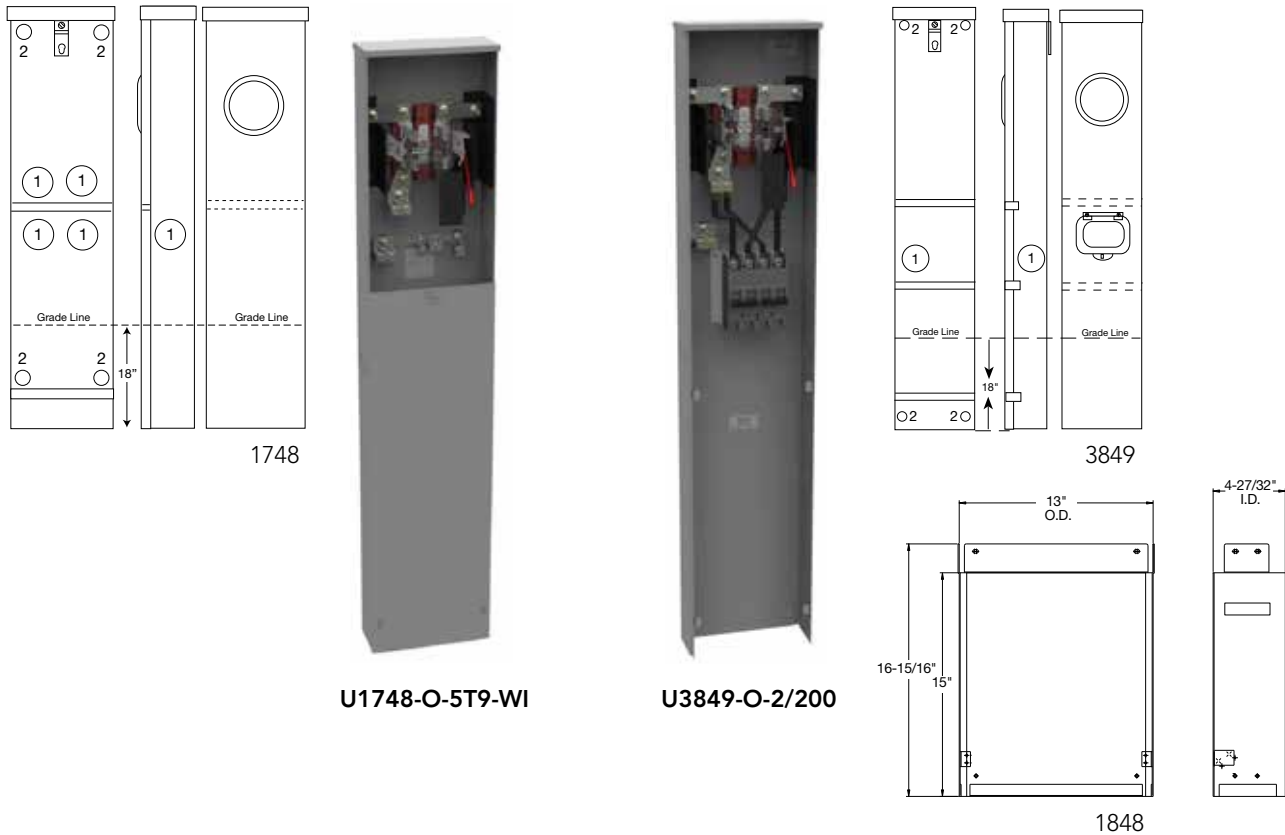

U1748-O-5T9-WI

U3849-O-2/200

1848

320 Amp | 5 Terminal | Meter Main without Breakers | Ringless | 600 VAC

Catalog Number	Service	Hub	Bypass	Connectors CU/AL		Dimensions			Knockouts	
				Line	Load	D"	W"	H"	1	2
U1748-O-5T9-WI	UG	Blank	Lever	3/8" x 16 Studs	Twin #6-350	4 7/8	13	64	2 1/2	5/16

320 Amp | 5 Terminal | Meter Main with Breakers | Ringless | 120/240 VAC

Catalog Number	Service	Hub	Bypass	Connectors CU/AL		Dimensions			Knockouts	
				Line	Load	D"	W"	H"	1	2
U3849-O-2/200-5T9* [Ⓢ]	UG	Blank	Lever	3/8" x 16 Studs	CB #1/0-300	4 7/8	13	64	2 1/2	5/16

Notes

- **Bypass:** The lever supplies clamping action on the meter spade and also operates the bypass device.
- **Connectors:** [Ⓢ]Sockets are supplied with 3/8" -16 hex head nuts with Belleville washers. For connector lug kits, order as extra from chart on page 76. Lug kit required for line side only.
- ***Breakers:** The **U3849** is supplied with (2) 200 amp Milbank type **UQFBH-200** 22K AIC circuit breakers.
- **Direct Burial:** For free standing use, order separately burial kit **S1848**.
- **Anti-Inversion Kit:** If anti-inversion kit is required, order catalog number **K4802** as extra.
- **Short Circuit Current Rating:** For **U3849** is 22K AIC. However, this rating is limited to the lowest interrupting capacity of any circuit breaker installed. Watthour meter not included in short circuit current rating.

Please consult serving utility for their requirements prior to ordering or installing, as specifications and approvals vary by utility, and may require local electrical inspector approval. All installations must be installed by a licensed electrician and must comply with all national and local codes, laws and regulations. Milbank reserves the right to make changes in specifications and features shown without notice or obligation.





S1994-WL-KK



SC2077-XL



SC2992-RL

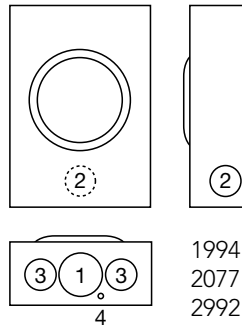

1994
2077
2992

20 Amp | Ringless | Transformer Rated | Overhead/Underground Service

Catalog Number	Terminals	Hub	Meter Form	Bypass	Connectors CU	Dimensions			Knockouts			
						D"	W"	H"	1	2	3	4
S1994-WL-KK	6	1"	4S	Horn	#12 - #10	3 ⁵ / ₁₆	8	11 ¹ / ₂	2	1 ¹ / ₂	1 ¹ / ₄	1 ¹ / ₄
SC2077-XL	6	C.P.	4S	Plunger	#14 - #10	3 ⁵ / ₁₆	8	11 ¹ / ₂	2	1 ¹ / ₂	1 ¹ / ₄	1 ¹ / ₄
SC2992-RL	5	H.O.	12S	Plunger	#14 - #10	3 ⁵ / ₁₆	8	11 ¹ / ₂	2	1 ¹ / ₂	1 ¹ / ₄	1 ¹ / ₄

Notes

- **Hub:** For proper hub selection, see the hub suffix chart on the accessories page.
- **Bypass:** Plunger type bypass automatically closes when meter is removed.



Please consult serving utility for their requirements prior to ordering or installing, as specifications and approvals vary by utility, and may require local electrical inspector approval. All installations must be installed by a licensed electrician and must comply with all national and local codes, laws and regulations. Milbank reserves the right to make changes in specifications and features shown without notice or obligation.

Lever Bypass Transformer Rated

20 & 80 Amp | 6, 8 & 13 Terminal | Ringless | 600 VAC

55
LEVER BYPASS
TRANSFORMER
RATED



U4490-XL

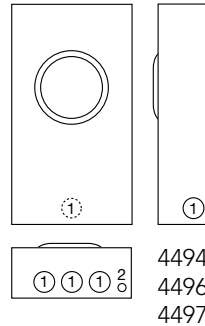
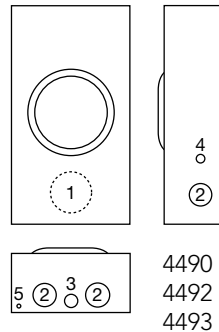

U4497-XL

*20 Amp | Ringless | Transformer Rated | Lever Bypass | With Provision for Test Switch

Catalog Number	Terminals	Hub	Service	Connectors CU	Dimensions			Knockouts	
					D"	W"	H"	1	2
U4494-XL	6	C.P.	OH/UG	#14 - #4 Max	4 ⁷ / ₈	12	22	1 ¹ / ₂	1/4, 1/2
U4496-XL	8	C.P.	OH/UG	#14 - #4 Max	4 ⁷ / ₈	12	22	1 ¹ / ₂	1/4, 1/2
U4497-XL	13	C.P.	OH/UG	#14 - #4 Max	4 ⁷ / ₈	12	22	1 ¹ / ₂	1/4, 1/2

80 Amp | Ringless | Transformer Rated | Lever Bypass

Catalog Number	Terminals	Hub	Service	Connectors CU	Dimensions			Knockouts				
					D"	W"	H"	1	2	3	4	5
U4490-XL	6	C.P.	OH/UG	#14 - #4 Max	4 ⁷ / ₈	10	18 ¹ / ₂	3	1 ¹ / ₂	1/2, 3/4	3/4	1/4
U4492-XL	8	C.P.	OH/UG	#14 - #4 Max	4 ⁷ / ₈	10	18 ¹ / ₂	3	1 ¹ / ₂	1/2, 3/4	3/4	1/4
U4493-XL	13	C.P.	OH/UG	#14 - #4 Max	4 ⁷ / ₈	10	18 ¹ / ₂	3	1 ¹ / ₂	1/2, 3/4	3/4	1/4

Notes

- **Bypass:** Lever operates current bypass devices and also supplies clamping action on current meter spades.
- ***Prewiring:** If standard factory prewiring is required, refer to wiring diagrams in the general engineering section of this catalog. Determine appropriate diagram and send copy with order. If custom factory prewiring is required, specify on order. Be sure to include meter socket catalog number, test switch model and number, and meter form number. Please be sure to provide a copy of your wiring diagram.
- ***Test Switch Cover:** Units on this page can be used with clear lexan cover. See accessories page for ordering information.
- ***Block Assembly:** Block assembly rated at 80 amps and test switch rated at 20 amps; therefore, unit defaults to test switch rating of 20 amps.
- **Connectors:** Units are supplied with mechanical type connectors (#4 max). If compression type connectors (#10) are preferred, change catalog prefix to "S" (i.e. U4494-XL becomes S4494-XL). The "S" prefix also designates non-U/L.

Please consult serving utility for their requirements prior to ordering or installing, as specifications and approvals vary by utility, and may require local electrical inspector approval. All installations must be installed by a licensed electrician and must comply with all national and local codes, laws and regulations. Milbank reserves the right to make changes in specifications and features shown without notice or obligation.



Transformer Rated

20 Amp | 5, 6, 7, 8 & 13 Terminal | 600 VAC

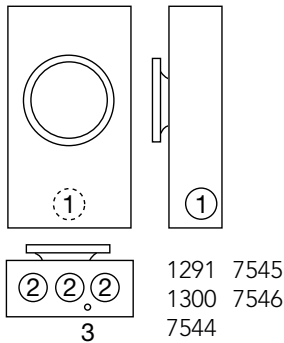

1291 7545
1300 7546
7544



UC7545-RL

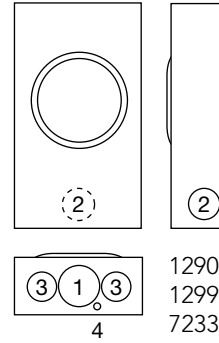

1290 7235
1299 7237
7233

20 Amp | Ringless | Plunger Bypass | Overhead/Underground Service

Catalog Number	Terminals	Hub	Meter Form	Connectors CU	Bypass	Dimensions			Knockouts			
						D"	W"	H"	1	2	3	4
UC1290-RL	5	H.O.	3S	#14 - #10	Plunger	3 ⁵ / ₁₆	8	14	2	1 ¹ / ₂	1 ¹ / ₄	1 ¹ / ₄
UC1299-RL	6	H.O.	4S	#14 - #10	Plunger	3 ⁵ / ₁₆	8	14	2	1 ¹ / ₂	1 ¹ / ₄	1 ¹ / ₄
UC7233-RL	7	H.O.	7, 14, 15 & 24S	#14 - #10	Plunger	3 ⁵ / ₁₆	8	14	2	1 ¹ / ₂	1 ¹ / ₄	1 ¹ / ₄
UC7235-RL	8	H.O.	5S	#14 - #10	Plunger	3 ⁵ / ₁₆	8	14	2	1 ¹ / ₂	1 ¹ / ₄	1 ¹ / ₄
UC7237-RL	13	H.O.	6, 8, 9S & (ALT) 10S	#14 - #10	Plunger	3 ⁵ / ₁₆	8	14	2	1 ¹ / ₂	1 ¹ / ₄	1 ¹ / ₄

20 Amp | Ring Type | Plunger Bypass | Overhead/Underground Service

Catalog Number	Terminals	Hub	Meter Form	Connectors CU	Bypass	Dimensions			Knockouts			
						D"	W"	H"	1	2	3	4
UC1291-RL	5	H.O.	3S	#14 - #4 Max	Plunger	3 ⁵ / ₁₆	8	14	2	1 ¹ / ₂	1 ¹ / ₄	1 ¹ / ₄
UC1300-RL	6	H.O.	4S	#14 - #4 Max	Plunger	3 ⁵ / ₁₆	8	14	2	1 ¹ / ₂	1 ¹ / ₄	1 ¹ / ₄
UC7546-RL	7	H.O.	7, 14, 15 & 24S	#14 - #4 Max	Plunger	3 ⁵ / ₁₆	8	14	2	1 ¹ / ₂	1 ¹ / ₄	1 ¹ / ₄
UC7544-RL	8	H.O.	5S	#14 - #4 Max	Plunger	3 ⁵ / ₁₆	8	14	2	1 ¹ / ₂	1 ¹ / ₄	1 ¹ / ₄
UC7545-XL	13	H.O.	6, 8, 9S & (ALT) 10S	#14 - #4 Max	Plunger	3 ⁵ / ₁₆	8	14	2	1 ¹ / ₂	1 ¹ / ₄	1 ¹ / ₄

Notes

- **Hubs:** For proper hub selection, see the hub suffix chart on the accessories page.
- **Bypass:** Plunger type bypass automatically closes when meter is removed.
- **Connectors:** Units are supplied with mechanical type connectors (#4 max). If compression type connectors (#10) are preferred, change catalog prefix to "S" (i.e. UC1289-XL becomes S1289-XL). The "S" prefix also designates non-U/L.



Please consult serving utility for their requirements prior to ordering or installing, as specifications and approvals vary by utility, and may require local electrical inspector approval. All installations must be installed by a licensed electrician and must comply with all national and local codes, laws and regulations. Milbank reserves the right to make changes in specifications and features shown without notice or obligation.

Transformer Rated

20 Amp | 5, 6, 8, & 13 Terminals | Test Switch Provision |
600 VAC

57
20 AMP
TRANSFORMER
RATED

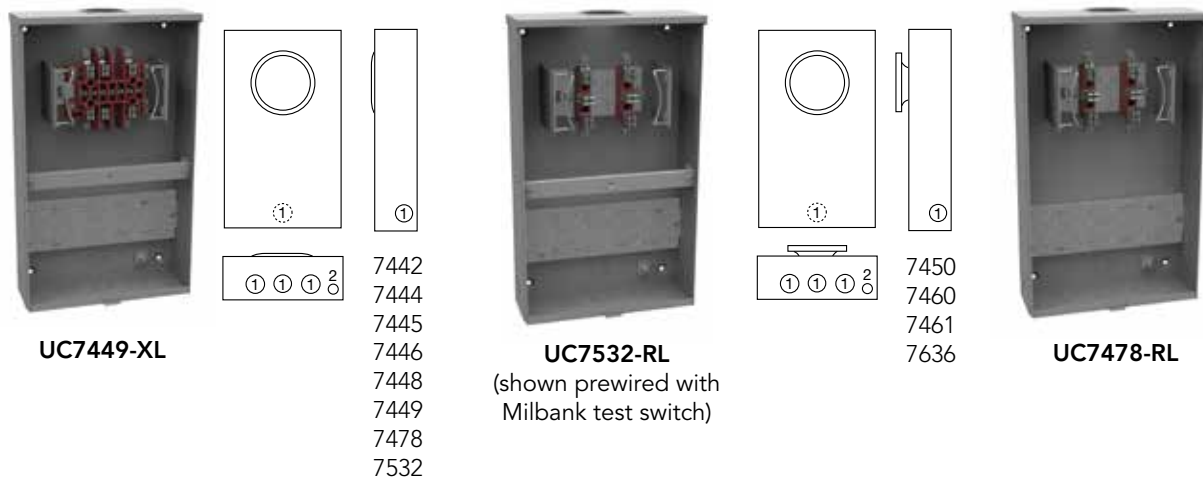

1 Piece Cover | Ringless | Overhead/Underground Service | with test switch provision*

Catalog Number	Terminals	Hub	Meter Form	Connectors CU	Bypass	Dimensions			Knockouts	
						D"	W"	H"	1	2
UC7442-RL	5	H.O.	3S	#14 - #4 Max	None	4 $\frac{1}{8}$	12	20	1 $\frac{1}{4}$	$\frac{1}{4}$, $\frac{1}{2}$
UC7478-RL	6	H.O.	4S	#14 - #4 Max	None	4 $\frac{1}{8}$	12	20	1 $\frac{1}{4}$	$\frac{1}{4}$, $\frac{1}{2}$
UC7444-RL	8	H.O.	5S	#14 - #4 Max	None	4 $\frac{1}{8}$	12	20	1 $\frac{1}{4}$	$\frac{1}{4}$, $\frac{1}{2}$
UC7445-RL	13	H.O.	6, 8, 9 & (ALT) 10S	#14 - #4 Max	None	4 $\frac{1}{8}$	12	20	1 $\frac{1}{4}$	$\frac{1}{4}$, $\frac{1}{2}$

2 Piece Cover | Overhead/Underground Service | with test switch provision*

Ringless Catalog Number	Ring Type Catalog Number	Terminals	Hub	Connectors CU	Bypass	Dimensions			Knockouts	
						D"	W"	H"	1	2
UC7446-RL	UC7450-RL	5	H.O.	#14 - #4 Max	None	4 $\frac{1}{8}$	12	20	1 $\frac{1}{4}$	$\frac{1}{4}$, $\frac{1}{2}$
UC7532-RL	UC7636-RL	6	H.O.	#14 - #4 Max	None	4 $\frac{1}{8}$	12	20	1 $\frac{1}{4}$	$\frac{1}{4}$, $\frac{1}{2}$
UC7448-RL	UC7460-RL	8	H.O.	#14 - #4 Max	None	4 $\frac{1}{8}$	12	20	1 $\frac{1}{4}$	$\frac{1}{4}$, $\frac{1}{2}$
UC7449-RL	UC7461-RL	13	H.O.	#14 - #4 Max	None	4 $\frac{1}{8}$	12	20	1 $\frac{1}{4}$	$\frac{1}{4}$, $\frac{1}{2}$

Notes

- **Hubs:** For proper hub selection see the hub suffix chart on the accessory page.
- **Sealing Rings:** Ring type units are supplied with one MR-2, snap type, sealing ring.
- **Prewiring:** If standard factory prewiring is required, refer to wiring diagrams in the general engineering section of this catalog. Determine appropriate diagram and send copy with order. If custom factory prewiring is required, specify on order. Be sure to include meter socket catalog number, test switch model and number, and meter form number. Please be sure to provide a copy of your wiring diagram.
- **Connectors:** Units are supplied with mechanical type connectors (#4 max). If compression type connectors (#10) are preferred, change catalog prefix to "S" (i.e. UC7445-XL becomes S7445-XL). The "S" prefix also designates non-U/L.
- ***Test Switch Cover:** Units on this page are not designed for use with test switch covers.

Please consult serving utility for their requirements prior to ordering or installing, as specifications and approvals vary by utility, and may require local electrical inspector approval. All installations must be installed by a licensed electrician and must comply with all national and local codes, laws and regulations. Milbank reserves the right to make changes in specifications and features shown without notice or obligation.





UC3423-XL

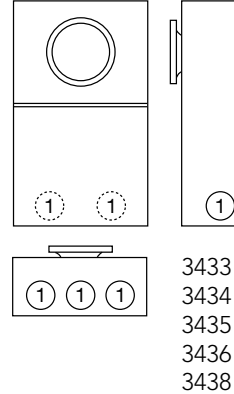
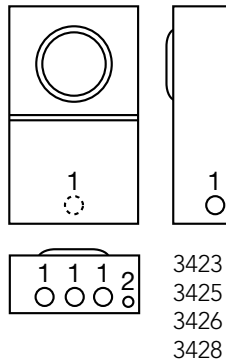

UC3428-XL

1 Piece Cover | Ringless | with test switch provision

Catalog Number	Terminals	Hub	Service	Connectors CU	Bypass	Dimensions			Knockouts	
						D"	W"	H"	1	2
UC3425-XL	5	C.P.	OH/UG	#14 - #4 Max	None	5½	12	20	1¼	¼, ½
UC3426-XL	6	C.P.	OH/UG	#14 - #4 Max	None	5½	12	20	1¼	¼, ½
UC3428-XL	8	C.P.	OH/UG	#14 - #4 Max	None	5½	12	20	1¼	¼, ½
UC3423-XL	13	C.P.	OH/UG	#14 - #4 Max	None	5½	12	20	1¼	¼, ½

2 Piece Cover | Ring Type | with test switch provision

Ringless Catalog Number	Terminals	Hub	Service	Connectors CU	Bypass	Dimensions			Knockouts
						D"	W"	H"	1
UC3435-XL	5	C.P.	OH/UG	#14 - #4 Max	None	5½	12	20	2
UC3436-XL	6	C.P.	OH/UG	#14 - #4 Max	None	5½	12	20	2
UC3438-XL	8	C.P.	OH/UG	#14 - #4 Max	None	5½	12	20	2
UC3433-XL	13	C.P.	OH/UG	#14 - #4 Max	None	5½	12	20	2
UC3434-XL	15	C.P.	OH/UG	#14 - #4 Max	None	5½	12	20	2

Notes

- **Sealing Rings:** Ring type units are supplied with one **MR-4**, snap type, sealing ring.
- **Prewiring:** If standard factory prewiring is required, refer to wiring diagrams in the general engineering section of this catalog. Determine appropriate diagram and send copy with order. If custom factory prewiring is required, specify on order. Be sure to include meter socket catalog number, test switch model and number, and meter form number. Please be sure to provide a copy of your wiring diagram.
- **Connectors:** Units are supplied with mechanical type connectors (#4 max). If compression type connectors (#10) are preferred, change catalog prefix to "S" (i.e. **UC3434-XL** becomes **S3434-XL**). The "S" prefix also designates non-U/L.
- **Test Switch Cover:** Units on this page can be used with clear lexan cover. See accessories page for ordering information.



Please consult serving utility for their requirements prior to ordering or installing, as specifications and approvals vary by utility, and may require local electrical inspector approval. All installations must be installed by a licensed electrician and must comply with all national and local codes, laws and regulations. Milbank reserves the right to make changes in specifications and features shown without notice or obligation.

Transformer Rated

20 Amp | 5, 6, 8, & 13 Terminal | Test Switch Provision |
600 VAC

59
TRANSFORMER
RATED



UC7445-XL

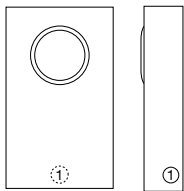

7478
7445



SC6128-XL

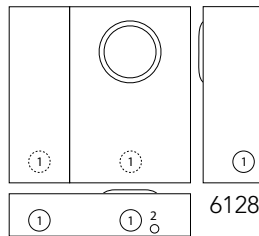

6128



SC6129-O

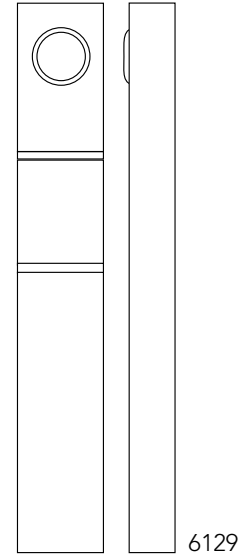

6129

1 Piece Cover | Ringless | Pre-Wired

Catalog Number	Terminals	Hub	Service	Connectors CU	Bypass	Dimensions			Knockouts	
						D"	W"	H"	1	2
UC7478-RL-WC-271	5	C.P.	OH/UG	#14 - #4 Max	None	5½	12	20	1¼	¼, ½
U7445-RL-WC-951	6	C.P.	OH/UG	#14 - #4 Max	None	5½	12	20	1¼	¼, ½
UC7445-XL-371	8	C.P.	OH/UG	#14 - #4 Max	None	5½	12	20	1¼	¼, ½

2 Piece Cover | Ringless | with test switch provision | Non UL

Ringless Catalog Number	Terminals	Hub	Service	Connectors CU	Bypass	Dimensions			Knockouts
						D"	W"	H"	1
SC6128-XL	13	C.P.	OH/UG	#14 - #4 Max	None	4¾	20	22	1¼

Pedestal | Ringless | with test switch provision | Non UL

Ringless Catalog Number	Terminals	Service	Connectors CU	Bypass	Dimensions		
					D"	W"	H"
SC6129-O	13	UG	#14 - #4 Max	None	4¾	12	84

Notes

- **Prewiring:** If standard factory prewiring is required, refer to wiring diagrams in the general engineering section of this catalog. Determine appropriate diagram and send copy with order. If custom factory prewiring is required, specify on order. Be sure to include meter socket catalog number, test switch model and number, and meter form number. Please be sure to provide a copy of your wiring diagram.
- **Connectors:** Units are supplied with mechanical type connectors (#4 max). If compression type connectors (#10) are preferred, change catalog prefix to "S" (i.e. **UC7445-XL** becomes **S7445-XL**). The "S" prefix also designates non-UL listing.
- **Test Switch Cover:** Units on this page can be used with clear lexan cover. See accessories page for ordering information.

Please consult serving utility for their requirements prior to ordering or installing, as specifications and approvals vary by utility, and may require local electrical inspector approval. All installations must be installed by a licensed electrician and must comply with all national and local codes, laws and regulations. Milbank reserves the right to make changes in specifications and features shown without notice or obligation.



Catalog Number	Single 350 kcmil	Twin 350 kcmil	Twin 350 kcmil (Anti-Rotation)	Single 600 kcmil	Twin 600 kcmil (Anti-Rotation)	Twin 600 kcmil
S2068-O	K1539					
U1079-R	K1539	K1350		K1540		
U1129-O	K1539		K1350L		K1340L	
U1252-X	K1539	K1350		K1540		K1541
U1253-X	K1539	K1350		K1540		K1541
U1254-X	K1539	K1350		K1540		K1541
U1255-X	K1539	K1350		K1540		K1541
U1256-X	K1539	K1350		K1540		K1541
U1748-O-5T9-WI	K1539			K1540		
U1797-O-STU-STU	K1539		K1350L		K1340L	
U2120-X	K3082	K3442		K3441		
U2448-X	K1539	K1350		K1540		K1541
U2569-O	K1539					
U2594-X	K3082	K3442		K3441L		
U2732-XT	K3082	K3442		K3441		K3083
U2733-XT	K3082	K3442		K3441		K3083
U2734-XT	K3082	K3442		K3441		K3083
U2735-XT	K3082	K3442		K3441		K3083
U2736-XT	K3082	K3442		K3441		K3083
U2852-X	K1539	K1350				
U2853-X	K1539	K1350				
U2854-X	K1539	K1350				
U2855-X	K1539	K1350				
U2856-X	K1539	K1350				
U2862-X	K1539	K1350				
U2863-X	K1539	K1350				
U2864-X		K1350				
U2865-X						K1541
U2866-X				K1540		K1541
U2872-XT-5T9	K1539	K1350		K1540		K1541
U2873-XT-5T9	K1539	K1350		K1540		K1541
U2874-XT-5T9	K1539	K1350		K1540		K1541
U2875-XT-5T9	K1539	K1350		K1540		K1541
U2876-XT-5T9	K1539	K1350		K1540		K1541
U2986-O	K1539					
U3849-O-2/200	K1539			K1540		
U4031-O-2/200-5T9	K1539	K1350		K1540		
U4210-XL	K1539	K1350				
U4702-X	K1539	K1350		K1540*		
U4911-X-BL	K3082	K3442		K3441		
U5059-X-2/200-5T9				K1540	K1540L	
U9761-RRL	K3082			K3441		
U9865-RRL	K1539			K1540*		



Please consult serving utility for their requirements prior to ordering or installing, as specifications and approvals vary by utility, and may require local electrical inspector approval. All installations must be installed by a licensed electrician and must comply with all national and local codes, laws and regulations. Milbank reserves the right to make changes in specifications and features shown without notice or obligation.

Terminal Box

100, 200 & 400 Amp | 120/240 VAC



U4540-XL

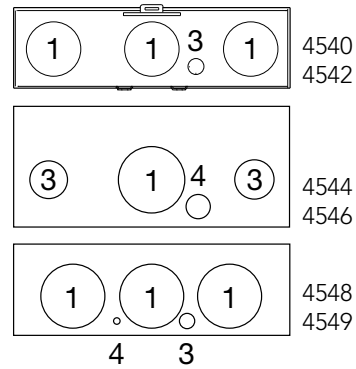
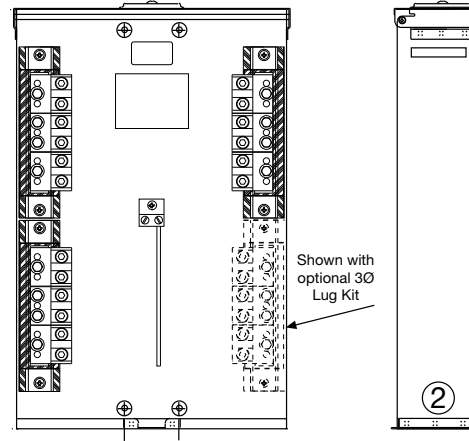

Terminal Boxes 1Ø and 3Ø 120/240 VAC

Catalog Number	Amp	Phase	Volts	Hub	Connectors CU7AL	1Ø to 3Ø Kit	Dimensions			Knockouts			
							D"	W"	H"	1	2	3	4
U4544-XL	100	1	120/240	C.P.	(6) #12-1/0	K4543	4 $\frac{1}{8}$	9 $\frac{13}{16}$	18	2	1	¼, ½	—
U4546-XL	100	3	600	C.P.	(6) #12-1/0	N/A	4 $\frac{1}{8}$	9 $\frac{13}{16}$	18	2	1	¼, ½	—
U4540-XL	200	1	120/240	C.P.	(6) #6-350	K4539	4 $\frac{1}{8}$	14 $\frac{13}{16}$	23	2½	2½	1¼	¼, ½
U4542-XL	200	3	600	C.P.	(6) #6-350	N/A	4 $\frac{1}{8}$	14 $\frac{13}{16}$	23	2½	2½	1¼	¼, ½
U4548-RXL	400	1	120/240	C.P.	(3) #6-350 or (2) #4-600	K4547	5	15½	27	3	3	¼, ½	¼
U4549-RXL	400	3	600	C.P.	(3) #6-350 or (2) #4-600	N/A	5	15½	27	3	3	¼, ½	¼

Notes

- **Hub:** Standard hub opening on top with closing plate attached.
- **Features:** UL listed pad lockable Type 3R enclosure.
- **3Ø 120/240V Application:** Field-installable 3Ø lug kit converts 1Ø unit to 3Ø unit.

Please consult serving utility for their requirements prior to ordering or installing, as specifications and approvals vary by utility, and may require local electrical inspector approval. All installations must be installed by a licensed electrician and must comply with all national and local codes, laws and regulations. Milbank reserves the right to make changes in specifications and features shown without notice or obligation.



62

MULTI-POSITION
TAP BOX

Multi-Position Tap Box

Three Phase | Aluminum Construction | Wall or Pad Mountable



Features

- **Painted Aluminum Construction:** Enclosure shells are constructed with lightweight aluminum, making wall-mount installations easier. Powder-coat paint finish helps prevent corrosion.
- **Capable of Wall or Pad Mounting:** Units feature a removable bottom, allowing an easy conversion from a wall-mount to a pad-mount.
- **Smaller Footprint:** The **UAP6094** model has a more compact footprint compared with the leading competitor.
- **Multi-port ground lugs**
- **Optional Pentabolt Secured Handle available** (see pics below): Enclosure handle can be included with an optional pentabolt locking mechanism (see photos below) for enhanced protection.



Common Applications



Apartment Buildings



Strip Malls



Housing Developments

Catalog Number	Phase	Position Lugs	Maximum Wire Size	Maximum Amperage	Dimensions		
					D"	W"	H"
UAP6094-O	3	16	500 kcmil	3000 Amps	16	25 ⁵ / ₁₆	43
UAP6095-O	3	22	500 kcmil	4000 Amps	16	32 ³ / ₁₆	43
UAP6096-O	3	14	750 kcmil	3300 Amps	16	25 ¹⁵ / ₁₆	51

Stainless steel pad mount spacing brackets included



Please consult serving utility for their requirements prior to ordering or installing, as specifications and approvals vary by utility, and may require local electrical inspector approval. All installations must be installed by a licensed electrician and must comply with all national and local codes, laws and regulations. Milbank reserves the right to make changes in specifications and features shown without notice or obligation.

Commercial Pedestals

Attractive | Easy to Install | Secure | Cost-Effective

Milbank Commercial Pedestals are pad-mounted, weather resistant electrical enclosures consisting of a utility pull section with optional meter socket, and a customer section containing distribution and control equipment. Milbank Commercial Pedestals are an attractive, secure, easy to install and cost-effective solution when underground remote site power distribution and control equipment is required, replacing unsightly and inefficient strut and backboard structures.



Strut and backboard



Commercial pedestal

UL Listed as Industrial Control Equipment (File E113855)

Standard Features

- Type 3R rain-resistant, vandal-resistant cabinet of polyurethane powder coated steel (aluminum or stainless steel also available)
- UL listed as enclosed industrial control equipment (UL508)
- Isolated lockable and sealable utility metering and lug landing sections
- Lockable customer section for distribution and control equipment with internal deadfront
- Print pocket inside customer section door contains wiring schematics and installation instructions
- Most load centers are UL listed for use with various manufacturers' circuit breakers
- All stainless steel external hardware (screws, bolts, hinges, handles, hasps and sealing screws)

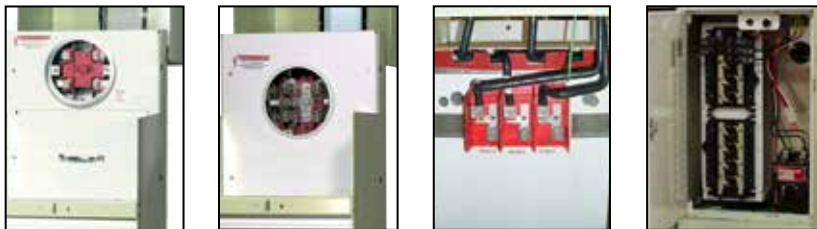

Please consult serving utility for their requirements prior to ordering or installing, as specifications and approvals vary by utility, and may require local electrical inspector approval. All installations must be installed by a licensed electrician and must comply with all national and local codes, laws and regulations. Milbank reserves the right to make changes in specifications and features shown without notice or obligation.



Attractive | Easy to Install | Secure | Cost-Effective



Applications

These units are ideal for controlling and metering:

- Traffic signals
- Street lighting
- Power distribution for EV charging stations
- Irrigation and sprinkler systems
- Cell towers and telephone vaults
- Pump stations
- Temporary power for fairgrounds, swap meets, outdoor markets, portable offices, holiday lights, etc.
- Outdoor lighting for athletic fields, tennis and basketball courts, parking lots, landscaping and subdivision entrances, etc.

Available Factory-Installed Options

- Meter sockets: ring type or ringless, up to 400 amp
- Main and branch breakers or T fuses
- Distribution: copper load centers and panel boards
- Clocks, timers and relays
- Photoelectric cells and controls
- Power receptacles: pin and sleeve, twist lock or straight blade
- Contactors: definite purpose, electrical or mechanically held, IEC and mercury types
- Surge protection and lightning arrestors
- Reserve inlet generator receptacle with interlocked circuit breakers
- Motor starters and relays
- Push button controls
- Thermostat controls, fans and heating strips
- Power blocks and terminal blocks
- Steel, aluminum and plywood backboards
- Transformers
- Interlock devices for circuit breakers
- Available in steel, aluminum (raw painted or anodized) or stainless steel construction with powder coated finish available in eight standard colors or special-ordered RAL colors
- Available for applications up to 400 amp, 120V, 208V, 240V, 277V, 480V - 1Ø or 3Ø

Accessories



K3865
Fifth terminal kit for use with ringless meter sockets

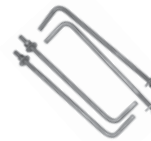

CP-ABK5/8
Anchor bolt kit (includes four 5/8 - 13 x 18" anchor bolts)



105J
Fifth terminal kit for use with ring-type meter sockets



CP-TC7D
7-day time clock kit
CP-TC24H
24-hour time clock kit
CP-TCWIRE
Male 4-pin connector and wiring harness for use with time clocks other than above



CP-PE-HOA-3POS
HOA switch for field installation



CP-16PDMNT-CALT
16" pedestal mounting base
CP-24PDMNT-CALT
24" pedestal mounting base (includes mounting hardware)



Please consult serving utility for their requirements prior to ordering or installing, as specifications and approvals vary by utility, and may require local electrical inspector approval. All installations must be installed by a licensed electrician and must comply with all national and local codes, laws and regulations. Milbank reserves the right to make changes in specifications and features shown without notice or obligation.

Commercial Pedestals

Main Load Center Series | Custom Designs Available

CP3B "ML" Series

Main Load Center Series

1Ø3 wire 120/240V or 208Y/120V

Application: remote site service for multiple loads

Milbank Main Load Center Commercial Pedestals are designed to handle the vast majority of all requirements in a standard, stocked configuration.

- All units feature a load center with a plug-on, back-fed main breaker.
- Load center has 16 positions for the 100 amp pedestals and 24 circuits for the 200 amp pedestals.
- Both sizes include sub-feed lugs to allow feeding an external panel.

If your application requires turning loads on based on "dusk-to-dawn" requirements, be sure to see the Milbank Switched Load Center Commercial Pedestal products on the following page.

Features

These units include everything required for remote site service:

- NEMA 3R construction.
- Expandable: load centers allow for future expansion without costly modifications.
- All units feature 200 amp meter socket with optional field-installable fifth terminal kit available.
- 22K amp interrupting capacity (AIC) standard.
- Optional mounting base can be embedded in concrete for fast, easy installation.
- Separate sealable and lockable utility termination section.
- Separate sealable and lockable metering section.
- Separate sealable and lockable customer section with a load center for "always on" loads that include a main circuit breaker, 20 (125 or 200 amp model) or 14 (100 amp model) blank breaker spaces and a circuit directory to document configuration.



Typical Applications

Remote site service for multiple loads.

Standard Pedestals	Optional Fifth Terminal Kit	Main CB		Load Center Circuits	Meter Socket Type
		Amp	Spaces		
CP3B11115A22	105J	100	1,2	16	Ring type with test/bypass blocks
CP3B12119A22	105J	200	1,2,3,4	24	Ring type with test/bypass blocks
CP3B51115A22	K3865	100	1,2	16	Ringless socket with lever bypass
CP3B52119A22	K3865	200	1,2,3,4	24	Ringless socket with lever bypass

Notes

- Chart shows standard, stocked items. Other options and features are available. Contact factory for options, details and availability.
- May require customization based on regional requirements

Please consult serving utility for their requirements prior to ordering or installing, as specifications and approvals vary by utility, and may require local electrical inspector approval. All installations must be installed by a licensed electrician and must comply with all national and local codes, laws and regulations. Milbank reserves the right to make changes in specifications and features shown without notice or obligation.



CP3B "SL" Series

Switched Load Center Series
1Ø3 wire 120/240V or 208Y/120V

Milbank Switched Load Center Commercial Pedestals are designed not only to provide power for various loads, but also to switch specific loads on and off under certain conditions. A photoelectric cell is used for these controlled loads, and an optional time clock is also available.

Features

These units include everything required for remote site service:

- NEMA 3R construction.
- Expandable: load centers allow for future expansion without costly modifications.
- All units feature 200 amp meter socket with optional field-installable fifth terminal kit available.
- 22K amp interrupting capacity (AIC) standard.
- Optional mounting base can be embedded in concrete for fast, easy installation.
- Separate sealable and lockable utility termination section.
- Separate sealable and lockable metering section.
- Separate sealable and lockable customer section with a control circuit including PE receptacle, Lexan® window, glare shield, Hand-Off-Auto (HOA) switch, contractor controlling a 16-circuit load center for controlled loads, a pre-mounted DIN rail and pre-wired connector to add an optional "plug-and-play" time clock kit for PE on and TC off operation and a circuit directory to document configuration.
- A load center for "always on" loads that includes a main circuit breaker, a control power circuit breaker, a switched load center main breaker, nine (125 or 200 amp model) or 11 (100 amp model) blank breaker spaces and a circuit directory to document configuration.



Typical Applications

Traffic signals, parking lots, highways & athletic field lighting

Standard Pedestals	Optional Fifth Terminal Kit	Main CB		Contactor Amperage	Meter Socket Type
		Amp	Spaces		
CP3B11110A22SL1	105J	100	1,3	60	Ring type with test/bypass blocks
CP3B12110A22SL1	105J	200	1,2,3,4	100	Ring type with test/bypass blocks
CP3B51110A22SL1	K3865	100	1,3	60	Ringless socket with lever bypass
CP3B52110A22SL1	K3865	200	1,2,3,4	100	Ringless socket with lever bypass

Notes

- Chart shows standard, stocked items. Other options and features are available. Contact factory for options, details and availability.
- May require customization based on regional requirements



Please consult serving utility for their requirements prior to ordering or installing, as specifications and approvals vary by utility, and may require local electrical inspector approval. All installations must be installed by a licensed electrician and must comply with all national and local codes, laws and regulations. Milbank reserves the right to make changes in specifications and features shown without notice or obligation.

Commercial Pedestals

CP3B "400" 400 Amp Series



Milbank 400 Amp Commercial Pedestals are designed to provide a weather and vandal resistant metered enclosure for various loads and distribution. Each pedestal has been designed to handle a wide range of applications using standard, stocked configurations.

- Choice of a single main breaker or twin service disconnect breakers gives flexibility to the pedestal design.
- Optional distribution with feed-through lugs below the service disconnect breakers allows the pedestal to handle numerous applications.
- Typical applications include remote homes where the metering is best located at the curb side or other remote area. The pedestal can also provide power to secondary residence, on-site business, workshop, irrigation, lighting, security or other secondary load.
- Available in custom colors to match home or landscaping.

Features

These units include everything required for remote service:

- Type 3R construction
- Main circuit breaker or dual service disconnects
- Expandable: load center units allow for future expansion without costly modifications
- Optional mounting base can be embedded in concrete for fast, easy installation
- Separate sealable and lockable utility termination section with lug termination
- Separate sealable and lockable metering section
- A separate sealable and lockable customer section with a circuit directory and a print pocket to hold all documentation
- Meter socket options include ring type with bypass studs, ringless with heavy duty lever bypass, or K-Type bolt-on

Typical Applications

Remote site service for residential and commercial job sites

Standard Pedestals	Optional fifth Terminal Kit	Main CB	Load Center Circuits	Meter Socket Type
CP3B1411JB	N/A	320 amp (400 max)	0	Ring-type with test/bypass studs
CP3B14120B	N/A	2-200 amp	(2) 12 circuit ¹	Ring-type with test/bypass studs
CP3B54120B22	K3865	2-200 amp	(2) 12 circuit ¹	Ringless with lever bypass
CP3B5411JB22	K3865	320 amp (400 max)	0	Ringless with lever bypass

Notes

- Chart shows standard, stocked items. Other options and features are available. Contact factory for options, details and availability.
- Stud utility landing is standard. Lug kits are available from factory.
- Units with load centers have (2) #6-250 sub-feed lugs on each load center. (Each load center is 200 amp rated and UL listed with: Siemens, General Electric and Cutler-Hammer plug-in style circuit breakers.)
- May require customization based on regional requirements

Please consult serving utility for their requirements prior to ordering or installing, as specifications and approvals vary by utility, and may require local electrical inspector approval. All installations must be installed by a licensed electrician and must comply with all national and local codes, laws and regulations. Milbank reserves the right to make changes in specifications and features shown without notice or obligation.



Commercial Pedestals

CP3B "IR" Irrigation Control Series



Milbank "IR" Series irrigation pedestals install quickly and simply – often in less than an hour with a single technician—a fraction of the time typically needed for strut farm and other installation set ups. Additionally, the pedestal comes pre-wired, so the technician simply drops in the pre-drilled concrete box pad, fastens the pedestal and runs the wires. Prewired landing lugs are provided in a separate utility side so that there is no more need to wrestle with hard-to-bend wires. Simply run the utility wire up and land on the lugs. With both the motor starter and disconnect in the same enclosure, all the controls are housed in a safe, lockable pedestal that protects against vandalism and energy theft.

Features

- 3Ø4W, 480Y/277 volt
- One technician can install in under an hour with use of Milbank’s pre-drilled box pad
- All units are UL listed and service entrance rated
- Fused disconnect with accessible handle through the deadfront
- HOA and push button start
- Separate accessible utility side with pre-wired landing lugs
- NEMA rated starters (sizes 1-5)
- Soft start units sizes 30HP-150HP
- 30 amp fuse block for pivot pre-wired in the unit
- White powder coated paint finish helps keep components cooler
 - Options include:
 - Hour meter
 - Chemical injection receptacle
 - Multiple injection receptacle
 - Multiple 30 amp fuse blocks possible

Typical Applications

Power pedestal for irrigation systems or other pump control applications

Standard Pedestals	Exterior Cabinet	NEMA Rating
CP3B0281UMWIR04	White	4
CP3B0281UMWIR03	White	3
CP3B0181UMWIR02	White	2

Notes

- Chart shows standard, stocked items. Other options and features are available. Contact factory for options, details and availability.
- May require customization based on regional requirements



Please consult serving utility for their requirements prior to ordering or installing, as specifications and approvals vary by utility, and may require local electrical inspector approval. All installations must be installed by a licensed electrician and must comply with all national and local codes, laws and regulations. Milbank reserves the right to make changes in specifications and features shown without notice or obligation.

Commercial Pedestals

CP3B "BBS" Battery Backup Series



Milbank BBS Series Commercial Pedestals are designed to provide battery backup power for various loads, and to switch specific loads on and off under certain conditions; a photoelectric cell or time clock to control lighting circuits, as an example. Metered and unmetered power distribution options are available. The back-up power pedestal is designed to handle the vast majority of today's back-up power requirements. By using 19" rack design, shelves can be adjusted to accommodate the required batteries and manufactures DC to AC inverters, transfer switches and other related equipment. This design gives the user a wide range of design and configuration options. Complete turnkey, ready to power-up pedestals are offered along with basic units ready to accept batteries and inverters supplied by others.

Features

- Type 3R construction
- 100 through 320 amp meter socket with the option of either a ring type socket (conforms to EUSERC 308) with or without test/bypass blocks or a heavy duty ringless socket with lever bypass
- Separate sealable utility termination compartment
- An isolated separate customer section with service disconnects, power distribution options and power control
- 19" wide rack in customer compartment for easy layout of equipment
- Battery trays
- Thermostat with cooling fan
- Filtered louvers for heat rise flow through ventilation
- Three point door latch (key or pad lockable)

Typical Applications

Metered emergency uninterrupted power for traffic intersections, wireless, phone and communications equipment, parking lots, camera and security locations

Note

- May require customization based on regional requirements

Options

- Manual bypass switch
- Transfer switch for generator power back-up
- Generator inlet receptacles 30 amp through 200 amp
- Pad lockable provision for receptacles
- Police access door
- Metered load center distribution
- Unmetered load center distribution
- Photo electric controls (for street lighting)
- Time clocks
- HOA switches
- Contactors
- GFI duplex receptacles
- Thermostat for heating control
- Heating pads or elements
- Roll out shelves for batteries
- Surge arrestors and lighting arrestors

Please consult serving utility for their requirements prior to ordering or installing, as specifications and approvals vary by utility, and may require local electrical inspector approval. All installations must be installed by a licensed electrician and must comply with all national and local codes, laws and regulations. Milbank reserves the right to make changes in specifications and features shown without notice or obligation.



Commercial Pedestals

CP3B "Power Transfer" Series



Milbank Power Transfer Series Pedestals provide unmetered AC power, distribution, surge suppression, mechanical interlock and stand-by generator receptacle — all in a neat, compact pedestal.

Features

- 120/240V 1Ø3W through 277/480V 3Ø4W ratings
- Metered or unmetered units
- Choice of EUSERC ring type or ringless meter sockets
- 60 amp through 400 amp ratings
- UL listed, Type 3R rated
- Pad lockable, isolated utility compartments
- 20 amp GFI convenience receptacle
- Lockable recessed generator receptacle door
- Utility and generator indicator light options
- All stainless steel hardware
- Galvanized steel, aluminum or stainless steel cabinet options
- Custom designs available

Note

- May require customization based on regional requirements



Typical Applications

Traffic intersections, cell sites, cable TV, pump and lift stations requiring utility power with backup generator power

Commercial Pedestals

CP3B "CT Metered" Series



Milbank CT Metered Series Commercial Pedestals are designed to be used where a smaller service package would be a better choice over large 3R rated combination switchboards. These pedestals have amperage ratings of 400 to 800 amp at voltages up through 480 volt three phase.

Features

- UL listed, freestanding Type 3R service
- Up to 800 amp
- A low profile CT pedestal
- All utility equipment is isolated in separated pad lockable and sealable compartments
- Separate customer compartment designed to hold distribution and control equipment
- Dead front customer construction
- Optional mounting base
- Optional construction in steel, aluminum and stainless steel.
- Wide choice of powder paint colors

Note

- May require customization based on regional requirements

Typical Applications

Large homes, pumping & lift stations, motor control, water treatment plants, EV charging stations, commercial buildings, large remote service requirements, commercial and industrial control systems

Please consult serving utility for their requirements prior to ordering or installing, as specifications and approvals vary by utility, and may require local electrical inspector approval. All installations must be installed by a licensed electrician and must comply with all national and local codes, laws and regulations. Milbank reserves the right to make changes in specifications and features shown without notice or obligation.





Milbank Slimline Series Commercial Pedestals provide a sleeker, smaller footprint, with wireway access on the side of the unit rather than the back, allowing maximum flexibility to place the pedestal in tighter spaces.

Features

- UL listed as service equipment
- 100 or 200 amp
- Vandal-resistant, secure and attractive design
- Customer compartment with distribution and control equipment with swing dead front door, secured with both a hasp/latch and draw latch outer door
- Utility metering compartment protected with a hinged hood, increasing resistance to meter vandalism
- Small footprint
- Wireway located on left side of pedestal for utility incoming wire, allowing pedestal to be mounted with back as close as 14" to walls or structures
- Available in 12" and 20" widths and 50" and 63" (metered) and 43" (unmetered) heights
- Includes a print pocket for plans and drawings
- Voltage range: 120V–480V
- Compatible with both ringless and ring type meter sockets, 4–7 terminals
- Available in a wide array of colors, including but not limited too all ANSI powder coated paint colors upon request
- Pedestal mounting base option saves time and labor to install on a cement pad—no anchor bolts required
- Powder coated G90 galvanized steel or Aluminum; raw, anodized or powder coated, as well as stainless steel exterior options

Note

- May require customization based on regional requirements

Typical Applications

Roadway lighting and signage, wastewater treatment facilities, parks and landscaping, and any application where physical space is at a premium



"Slimline" Series Direct Bury Extension

- No need for concrete
- Bolts directly to unit
- Easy, modular design
- Ships in a smaller package
- Increases project flexibility
- Easier to handle and install
- Utilizes stabilizer feet to prevent leaning over time
- Pedestal and extension can be installed within 45 minutes

Notes

- 14 gauge steel
- Only available for 12" pedestals



Please consult serving utility for their requirements prior to ordering or installing, as specifications and approvals vary by utility, and may require local electrical inspector approval. All installations must be installed by a licensed electrician and must comply with all national and local codes, laws and regulations. Milbank reserves the right to make changes in specifications and features shown without notice or obligation.

Circuit Breakers

QP (small frame) & QN (large frame) Series

15-70 Amp Breaker Plug-In Type — 1" Per Pole

Amp	Poles	10K AIC Plug-In	22K AIC Plug-In
15	Single	Q115	Q115H
15	Double	Q215	Q215H
20	Single	Q120	Q120H
20	Double	Q220	Q220H
25	Single	Q125	Q125H
25	Double	Q225	Q225H
30	Single	Q130	Q130H
30	Double	Q230	Q230H
35	Single	Q135	Q135H
35	Double	Q235	Q235H
40	Single	Q140	Q140H
40	Double	Q240	Q240H
50	Single	Q150	Q150H
50	Double	Q250	Q250H
60	Single	Q160	Q160H
60	Double	Q260	Q260H
70	Single	Q170	Q170H
70	Double	Q270	Q270H
80	Double	Q280	Q280H
90	Double	Q290	Q290H
100	Double	Q2100	Q2100H
125	Double	Q2125	Q2125H



QN2200H



QN2200RH



Q250

200 Amp Frame | Plug-In | 10,000 AIC & 22,000 AIC — Two-Pole - Common Trip

Amp	10K AIC Plug-In	22K AIC Plug-In	Handle Location	Wire Range	
				CU	AL
150	QN2150	QN2150H	Left facing	#4-300	#4-300
200	QN2200	QN2200H	Left facing	#4-300	#4-300
150	QN2150R	QN2150RH	Right facing	#4-300	#4-300
200	QN2200R	QN2200RH	Right facing	#4-300	#4-300

Notes

- Load connectors supplied with breakers.
- UL listed for use with 60°C or 75°C wire.
- Wire sizes shown are lug capacity. Consult NEC Article #310 for specific wire sizes.

Please consult serving utility for their requirements prior to ordering or installing, as specifications and approvals vary by utility, and may require local electrical inspector approval. All installations must be installed by a licensed electrician and must comply with all national and local codes, laws and regulations. Milbank reserves the right to make changes in specifications and features shown without notice or obligation.



UQFP Plug-In Series & UQFB Bolt-On Series

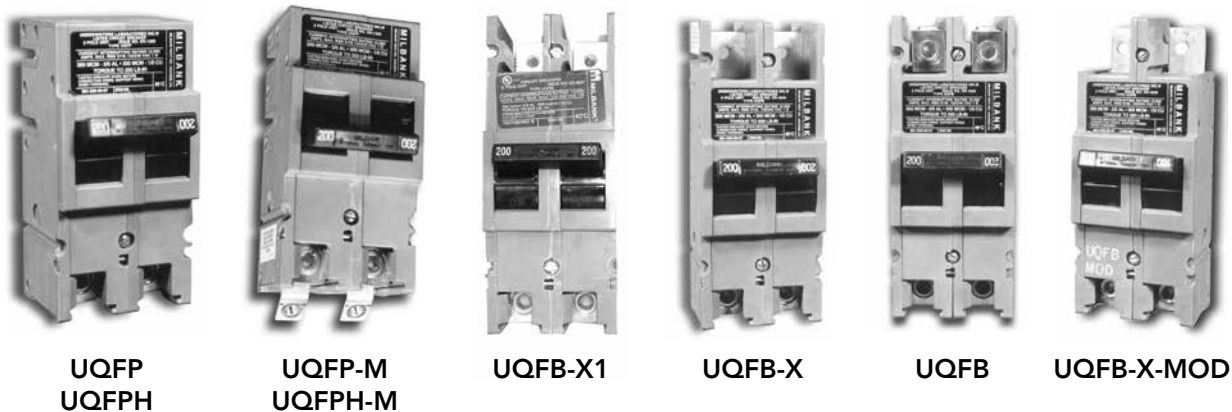

200 Amp Frame | Plug-In | 10,000 AIC & 22,000 AIC | Two-Pole - Common Trip

Amp	10K AIC Plug-In	22K AIC Plug-In	10K AIC Plug-In	22K AIC Plug-In	Wire Range	
					CU	AL
100	UQFP-100	UQFPH-100	UQFP-M-100	UQFPH-M-100	#3-#1	#1-1/0
125	UQFP-125	UQFPH-125	UQFP-M-125	UQFPH-M-125	#3-#1	#1-1/0
150	UQFP-150	UQFPH-150	UQFP-M-150	UQFPH-M-150	1/0-300	2/0-300
175	UQFP-175	UQFPH-175	UQFP-M-175	UQFPH-M-175	1/0-300	2/0-300
200	UQFP-200	UQFPH-200	UQFP-M-200	UQFPH-M-200	1/0-300	2/0-300

200 Amp Frame | Bolt-On | 10,000 AIC & 22,000 AIC | Two-Pole - Common Trip

Amp	10K AIC Bolt-On	22K AIC Bolt-On	10K AIC Bolt-On	22K AIC Bolt-On	Wire Range	
					CU	AL
100	UQFB-100	UQFBH-100	UQFB-100-X1	UQFPH-M-100	#3-#1	#1-1/0
125	UQFB-125	UQFBH-125	UQFB-125-X1	UQFPH-M-125	#3-#1	#1-1/0
150	UQFB-150	UQFBH-150	UQFB-150-X1	UQFPH-M-150	1/0-300	2/0-300
175	UQFB-175	UQFBH-175	UQFB-175-X1	UQFPH-M-175	1/0-300	2/0-300
200	UQFB-200	UQFBH-200	UQFB-200-X1	UQFPH-M-200	1/0-300	2/0-300

Notes

- UL listed: For use with 60°C or 75°C wire.
- UQFP: For parallel main circuit breaker applications.
- UQFP-M: For series main circuit breaker applications. Split load tab features allow for feed-through capability.
- UQFB: (2) 1/0-300 lugs provided on load and line side (cable-in, cable-out).
- UQFB3: Three-pole available. Consult factory.
- UQFB-X: (2) 1/0-300 lugs provided on load side and (2) line bar bus connections on line side.
- UQFB-M: For series main circuit breaker applications. Split load tab features allow for feed-through capability.
- UQFB-X-MOD: Replacement circuit breaker with line barriers removed.



Please consult serving utility for their requirements prior to ordering or installing, as specifications and approvals vary by utility, and may require local electrical inspector approval. All installations must be installed by a licensed electrician and must comply with all national and local codes, laws and regulations. Milbank reserves the right to make changes in specifications and features shown without notice or obligation.

Accessories

Hubs and Closing Plates

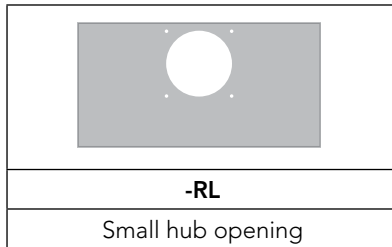

-WL	A7514	-YL	A7515	-ZL	A7516	-DL	A7517	-EL	A7518	-XL	A7551
1" hub		1¼" hub		1½" hub		2" hub		2½" hub		Small closing plate	

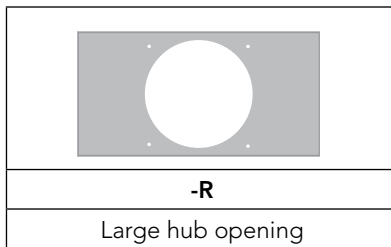

-F	A8110	-G	A8111	H	A8112	-X	A9064	-RRL	S8324
3" hub		3½" hub		4" hub		Large closing plate		Large hub opening adapted to small hub opening	

Please consult serving utility for their requirements prior to ordering or installing, as specifications and approvals vary by utility, and may require local electrical inspector approval. All installations must be installed by a licensed electrician and must comply with all national and local codes, laws and regulations. Milbank reserves the right to make changes in specifications and features shown without notice or obligation.



Connector Kits, Closing Kits and Sealing Rings

Connector Kits | For Use with 3/8"-16 Stud Type Units Only

Single			Twin		
Suffix	Part #	(3 per set) - 1Ø	Suffix	Part #	(3 per set) - 1Ø
K1	K1539	6-350	K2	K1350	6-350
K3	K1540	4-600 or (2) 1/0-250	K2L	K1350L	6-350 (non rotating)
K3L	K1540L	4-600 or (2) 1/0-250 (non rotating)	K4	K1541	4-600
Suffix	Part #	(4 per set) - 3Ø	Suffix	Part #	(4 per set) - 3Ø
K5	K3082	6-350	K6	K3442	6-350
K7	K3441	4-600 or (2) 1/0-250	K8	K3083	4-600

Bypass Link



K8180 (sold in pairs)

Closing Covers

Meter Closing Plate (Ring Type/Ringless)	Metal Closing Plate (For Ringless Sockets)
6003 - Grey Plastic	CP-21
6116 - Clear Plastic	

Generator Interlock

K5815 - large QN with small frame Q
K5820 - large frame QN with large frame QN
K5830 - small frame Q to small frame Q

Sealing Rings

MR-2 - Snap Action	MR-4 - Screw Type (Stainless Steel)
MR2-SS - Stainless Steel	

Touch-Up Paint





A-GP - Light Grey

Accessories

Fifth Terminals and Tap Connectors

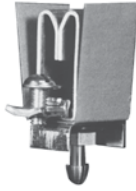
Fifth Terminals

		
5T8K2 - 100-200 Amp "Plug-In"	K5T - 200 Amp (Block with Square Hole)	K3865 - Heavy Duty Jaw Clamping (K3866 without Neutral Wire)

Tap Connectors (3 per set)

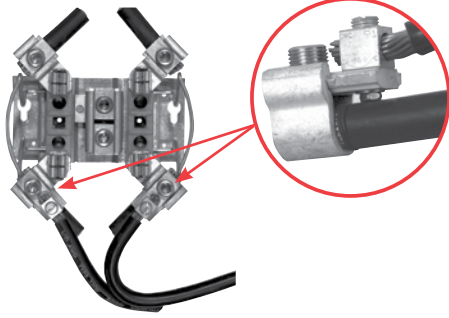
	Replaces the load or line side slide-in nut assembly on Milbank 200 amp sockets. Allows for a 100 amp tap location in addition to the #6-350 kcmil load-side connector. K5022 includes safety barrier extensions for applications over 300 VAC. Three lugs per kit.
K4977-INT - Internal Hex	
K4977-EXT - External Hex	
K5022-INT - Internal Hex (set of 4 w/ barrier)	

Triplex Ground

K1190 (For factory installed triplex ground, add suffix -TG to catalog number)

Isolated Neutral Kit

K1047*

Anti-Inversion Clip

K4802

Disconnect Sleeve

M5-144

*Isolated neutrals are specific to the meter socket. Consult factory for correct isolated neutral.

Please consult serving utility for their requirements prior to ordering or installing, as specifications and approvals vary by utility, and may require local electrical inspector approval. All installations must be installed by a licensed electrician and must comply with all national and local codes, laws and regulations. Milbank reserves the right to make changes in specifications and features shown without notice or obligation.



NEMA Commercial Enclosures

Milbank's line of commercial enclosures includes the full gamut of styles and sizes; everything from junction boxes to transformer cabinets, telephone cabinets to wireway.

Type 1 Enclosures

Milbank's Type 1 enclosures are designed for indoor use to provide a degree of protection to personnel against access to hazardous parts and to provide a degree of protection of the equipment inside the enclosure against ingress of solid foreign objects, such as falling dirt.

Type 3R Enclosures

Milbank's Type 3R enclosures are designed for either indoor or outdoor use to provide a degree of protection from harmful effects on the equipment due to the ingress of water (rain, sleet, snow) and that will be undamaged by the external formation of ice on the enclosure.

Wireway

Milbank's wide range of wireway is available in many styles and sizes and its wide range of fittings allows it to smoothly transition to and from competitors' products.

NEMA Industrial Enclosures

Milbank's line of industrial enclosures include junction boxes, wiring trough, push-button enclosures and modular enclosures. Milbank also excels in special designs; nearly any type, size or color of enclosure you need, we can make!

Type 12 Enclosures

Enclosures constructed without knockouts for indoor use to provide a degree of protection to personnel against access to hazardous parts, and protect components against falling dirt, circulating dust and lint, and dripping or splashing water.

Type 4 Enclosures

Enclosures constructed for either indoor or outdoor use to provide a degree of protection to personnel against access to hazardous parts; protect equipment against falling dirt and windblown dust; protect against rain, sleet, snow, splashing water, and hose directed water; and is resistant to damage by the external formation of ice on the enclosure.

Industrial Enclosure Specials

Milbank specializes in custom enclosure projects, offering an almost limitless amount of styles, options, colors and sizes. Milbank will meet your needs and specifications and deliver a custom enclosure that protects your crucial electric equipment.

Thermal Management

Protect components housed in enclosures from damage caused by overheating, freezing, humidity and condensation with these thermal management products.



Please consult serving utility for their requirements prior to ordering or installing, as specifications and approvals vary by utility, and may require local electrical inspector approval. All installations must be installed by a licensed electrician and must comply with all national and local codes, laws and regulations. Milbank reserves the right to make changes in specifications and features shown without notice or obligation.

Conduit, Ampacity & SCCR

Reference Information

MAXIMUM NUMBER OF CONDUCTORS IN CONDUIT

Table from 2008 NEC Code Reference: Rigid Metal Conduit

Type	Conductor Size (AWG/kcmil)	Conduit Trade Sizes (Inches)									
		½	¾	1	1¼	1½	2	2½	3	3½	4
THHN, THWN, THWN-2	12	9	16	26	46	62	102	146	225	301	387
	10	6	10	17	29	39	64	92	142	189	244
	8	3	6	9	16	22	37	53	82	109	140
	6	2	4	4	12	16	27	38	59	79	101
	4	1	2	4	7	10	16	23	36	48	62
	3	1	1	3	6	8	14	20	31	41	53
	2	1	1	3	5	7	11	19	26	34	44
	1	1	1	1	4	5	8	12	19	25	35
	1/0	1	1	1	3	4	7	10	16	21	27
	2/0	0	1	1	2	3	6	8	13	18	23
	3/0	0	1	1	1	3	5	7	11	15	19
4/0	0	1	1	1	2	4	6	9	12	16	
XHH, XHHW, XHHW-2	4	1	2	4	7	10	16	24	37	49	63
	2	1	1	3	5	7	12	17	26	35	45
	1/0	1	1	1	3	4	7	10	16	22	28
	2/0	0	1	1	2	3	6	9	13	18	23
	4/0	0	1	1	1	2	4	6	9	12	16
	250	0	0	1	1	1	3	5	7	10	13
	350	0	0	1	1	1	2	3	6	7	10
	500	0	0	0	1	1	1	2	4	5	7
750	0	0	0	0	1	1	1	3	4	5	

This table is for concentric stranded conductors only. For cables with compact conductors refer to NEC. Refer to latest NEC Code or Local Codes for updated requirements.

SAMPLE RATING LABEL

CATALOG NUMBERS U5952 & U5953
100A MAXIMUM, 120/240 VAC SINGLE PHASE, THREE WIRE
RAINFOOD NEMA TYPE 3R

SHORT CIRCUIT CURRENT RATING IS 10,000 RMS SYMMETRICAL AMPERE AT 240 VAC MAXIMUM, BUT IS LIMITED TO THE LOWEST SHORT CIRCUIT CURRENT RATING OF ANY INSTALLED CIRCUIT BREAKER. WATTHOUR METER NOT INCLUDED IN SHORT CIRCUIT CURRENT RATING. REPLACEMENT CIRCUIT BREAKER MUST BE THE SAME TYPE AND RATING. USE SIEMENS QP, QT; CUTLER-HAMMER QP, BD, BR; SQUARE D HOMELINE; G.E. TO, THQ, THQL

SUITABLE FOR USE AS RECREATIONAL VEHICLE SITE SUPPLY EQUIPMENT

UNDERGROUND FEED ONLY

ON TRIP OFF

TO RESET BREAKER MOVE TO "OFF" THEN TO "ON"

DANGER
HAZARD OF ELECTRICAL SHOCK OR BURN
TURN OFF POWER
SUPPLYING THIS EQUIPMENT BEFORE WORKING INSIDE

WIRE TERMINAL INFORMATION USE AL-CU CONDUCTORS

TERMINAL	WIRE RANGE	TORQUE LB-IN
LINE AND LINE NEUTRAL	350 KCMIL - #6	250
GROUND CONNECTOR	2/0 AWG - #14 AWG	120
LOAD NEUTRAL SLOTTED HEAD	(LARGE HOLE)	14 - 10 8 6 - 4 3 - 1/0
	(SMALL HOLE)	14 - 10 8 6
		35 40 45 50
LOAD NEUTRAL SLOTTED HEAD	(LARGE HOLE)	14 - 10 8 6
	(SMALL HOLE)	14 - 10 8 6
		20 25 35

SHIPPING TENDS TO LOOSEN BOLTED CONNECTIONS. CHECK AND TIGHTEN ALL HARDWARE BEFORE ENERGIZING UNIT

SIZE OF FIELD INSTALLED CONDUCTORS SHALL BE 60° OR 75°C SIZED TO 60°C RATING FOR 110 AMPS OR LESS AND 75°C SIZED TO 75°C FOR 125 AMPS AND ABOVE

* ALLOWABLE AMPACITIES OF INSULATED COPPER & ** ALUMINUM CONDUCTORS (3W IN CONDUIT) 75°C (167°F)

*CU		AL or **Cu-Clad AL	
A	B	A	C
18	-	-	-
16	-	-	-
14	20†	-	-
12	25†	12	20†
10	35†	10	30†
8	50	8	40
6	65	6	50
4	85	4	65
3	100	3	75
2	115	2	90
1	130	1	100
1/0	150	1/0	120
2/0	175	2/0	135
3/0	200	3/0	155
4/0	230	4/0	180
250	255	250	205
300	285	300	230
350	310	350	250
400	335	400	270
500	380	500	310
600	420	600	340
700	460	700	375
750	475	750	385

A = Size: AWG/MCM
*B = Ampere Rating for Insulation Types:
FEPW, RH, RHW, THW, THWN, XHHW, USE, 2W.
**C = Ampere Rating for Insulation Types:
RH, RHW, THW, THWN, XHHW, USE
(Per NEC table 310-16)

AMPACITY CORRECTION FACTORS

AMBIENT TEMP.°C*	CORRECTION FACTOR	AMBIENT TEMP.°F*
21 - 25	1.05	70 - 77
26 - 30	1.00	78 - 86
31 - 35	.94	87 - 95
36 - 40	.88	96 - 104
41 - 45	.82	105 - 113
46 - 50	.75	114 - 122
51 - 55	.67	123 - 131
56 - 60	.58	132 - 140
61 - 65	.33	141 - 158

Overall ampere ratings of U/L listed Milbank multiple position meter sockets are based on 2008 N.E.C. Handbook Article 220-84 and ANSI / UL-414 (except where restricted by line connector size.) These requirements provide for a diversity factor / demand factor being utilized in determining the overall (main bus / lug) rating of a gang socket. All Milbank U/L listed gang sockets meet or exceed these diversity factor/demand factor requirements. Standard overall ampacity ratings for U/L listed and non U/L listed gang sockets are as shown in the chart below. Ampere ratings of meter sockets are based on the meter socket being wired with 75° C insulated wire conductor, sized in accordance with Table 310-16 of the National Electric Code.

GANG SOCKET OVERALL AMPACITIES

NO. OF METER POSITIONS	100A / POS. AMPACITY	125A / POS. AMPACITY	150A / POS. AMPACITY	200A / POS. AMPACITY
2	200A	200A	200A	200A #
3	200A	225A	225A	270A
4	200A	250A	270A	360A
5	225A	285A	338A	450A
6	270A	330A	396A	528A

† Unless otherwise permitted elsewhere in the Code, the overcurrent protection for conductor types marked with an obelisk (†) shall not exceed 15 amps for 14 AWG, 20 amps for 12 AWG, and 30 amps for 10 AWG copper; or 15 amps for 12 AWG and 25 amps for 10 AWG aluminum and copper-clad aluminum after any correction factors for ambient temperature and number of conductors have been applied.

Some constructions are rated at 400 amps overall. Contact your sales representative for more information. Refer to latest NEC Code or Local Codes for updated requirements.

Please consult serving utility for their requirements prior to ordering or installing, as specifications and approvals vary by utility, and may require local electrical inspector approval. All installations must be installed by a licensed electrician and must comply with all national and local codes, laws and regulations. Milbank reserves the right to make changes in specifications and features shown without notice or obligation.



Important Note

In addition to national and local electrical codes, many utilities have specific requirements for metering equipment. Always consult the serving utility for their specifications and requirements prior to ordering or installing Milbank meter mounting equipment.

Before Energizing

1. Give equipment a thorough visual examination to determine that:
 - a) No shipping or installation damage exists.
 - b) Proper clearances have been maintained.
 - c) All connections have been made.
 - d) Equipment is clean and dry.
2. Make a thorough examination to:
 - a) Verify tightness of all bolted connections (see table below).
 - b) Manually operate all circuit breakers, switches, relays, etc.
 - c) Check rigidity of all mountings, bus bars and components.
 - d) Use test equipment to check continuity of circuitry and integrity of insulation.
3. All switches and circuit breakers should be in the OFF position.
4. Verify that manual meter bypass (if applicable) is in non-bypass position.
5. Install cover and/or close doors.
6. If installation is not being energized at this time, follow "after-energizing" steps listed below. These steps will secure the installation in case of accidental energization.

When Energizing

1. Use caution and follow established safety procedures:
 - a) Wear safety apparel.
 - b) Use safety equipment.
 - c) Take action to prevent injury to yourself and others in the event of failure of the installation.
 - d) Take action to prevent/decrease damage to property in the event of failure of the installation.
 - e) If you are unsure how to safely energize the installation, get someone who is knowledgeable to do it.

After Energizing

1. Secure the installation:
 - a) To prevent accidental contact with energized parts, cover all openings with approved filler devices.
 - b) To prevent unauthorized access, secure all covers and/or doors with approved security devices.
 - c) Attach/post information to advise others of potential hazards associated with the installation.

Recommended Torque for General Applications*

Nominal Size	Joint Description		Head Type	Torque (Inch Lbs.)
	Screw	Nut		
10	Brass	Brass Nut or Extruded Hole	All	20-25 inch lbs.
10	Steel	Copper or Aluminum Busbar ≤ 1/8"	All	25-30 inch lbs.
10	Steel	Steel Nut or Extruded Hole; CU or AL Busbar > 1/8"	All	30-35 inch lbs.
12	Steel	Aluminum Extruded Hole	All	30-35 inch lbs.
12	Steel	Steel Nut or Extruded Hole	All	40-50 inch lbs.
1/4	Steel	Aluminum Extruded Hole	All	40-50 inch lbs.
1/4	Steel	Steel Nut or Extruded Hole; CU or AL Busbar	All	50-60 inch lbs.
5/16	Steel	Aluminum Extruded Hole	Hex	60-70 inch lbs.
5/16	Steel	Steel Nut or Extruded Hole; CU or AL Busbar	Hex	100-150 inch lbs.
3/8	Steel	Steel Nut	Hex	150-200 inch lbs.
1/2	Steel	Steel Nut	Hex	200-250 inch lbs.

* Interior labels typically indicate the required torque for wire connectors and studs, and should be referenced first.
CU: Copper
AL: Aluminum



Please consult serving utility for their requirements prior to ordering or installing, as specifications and approvals vary by utility, and may require local electrical inspector approval. All installations must be installed by a licensed electrician and must comply with all national and local codes, laws and regulations. Milbank reserves the right to make changes in specifications and features shown without notice or obligation.

Materials & Finishes

Reference Information

Materials

Steel Quality

The meter equipment listed in this catalog is made of galvanized steel (AISI* G90) to afford the best possible weather proofing.
*American Iron and Steel Institute.

Steel Sheet

16 gauge, galvanized, sheet: 1 1/4 oz./ sq.ft. class zinc-coated. (AISI G90)
14 gauge, galvanized, sheet: 1 1/4 oz./ sq.ft. class zinc-coated.

Aluminum Extrusion

Wire-Terminals: Alloy; 6061-T6, Tin-plated for CU/AL wire.
Bus Bar: Alloy; 6101-o & 6063-O

Aluminum Sheet

3000 series aluminum sheet, H14, or 5052 series aluminum sheet, H32. Where applicable thicknesses range from .064 — .125

Copper Sheet & Bus

Electrolytic copper with tin plating in most applications.

Insulating Materials

- In most units, support bases for current-carrying components are molded from fiberglass reinforced high-strength, track resistant, thermoset polyester molding compounds.
- Clear or black safety shields and polarity barriers are molded from high-strength, track resistant, polycarbonate molding compounds.
- Various sheet insulating materials, as appropriate for the application are utilized in the fabrication of flat, formed and punched component parts and barriers.

Finish

Process

Light gray state-of-the-art electrostatically applied powder paint offers a durable, non-fading finish. For further information concerning the chemical analysis of the weather resistant finish, please contact the factory.

Metal Fasteners

Zinc-coated with a chromate dip.

Ratings & Compliance

Ratings & Compliance

All Milbank electrical enclosures in this catalog are rated Type 3R Enclosure unless otherwise specified on the product's page. All enclosures with a UL designation are constructed per the appropriate UL Standard and may be installed per the National Electric Code. UL procedure files associated with the UL Standards are listed as follows: Meter Sockets (UL 414, File E30202), Test Switches (UL 414, File E62531), Power Outlets (UL 231, File E90945), Panelboards (UL 67, File E32628) and Pullout Switches (UL 1429, File E133062). Additional standards are utilized as applicable: Meter Sockets (ANSI C12.7), Test Switches (ANSI C12.9) and Panelboards (NEMA PB-1).

Please consult serving utility for their requirements prior to ordering or installing, as specifications and approvals vary by utility, and may require local electrical inspector approval. All installations must be installed by a licensed electrician and must comply with all national and local codes, laws and regulations. Milbank reserves the right to make changes in specifications and features shown without notice or obligation.



DIAGRAM A
1∅2W with 1 P.T. & 1 C.T.
Single Stator Meter(2W1∅) - Form 3S
5T Socket, Test Switch #TS04-0101

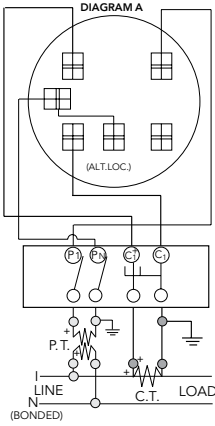

DIAGRAM B
1∅3W with 1 C.T.
Single Stator Meter(2W1∅) - Form 3S
5T Socket, Test Switch #TS04-0101

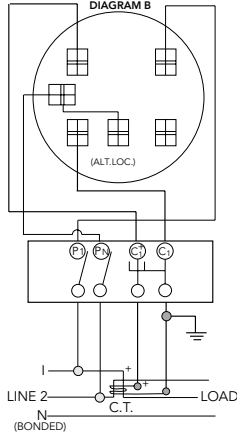

DIAGRAM C
1∅3W with 2 C.T.'s
Single Stator Meter(3W1∅) - Form 4S
6T Socket, Test Switch #TS07-0105

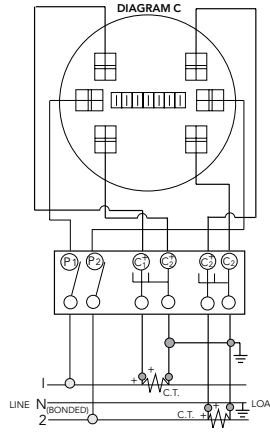

DIAGRAM D
1∅3W or 3W Network with 2 C.T.'s
2 Stator Meter - Form 5S
8T Socket, Test Switch #TS07-0105

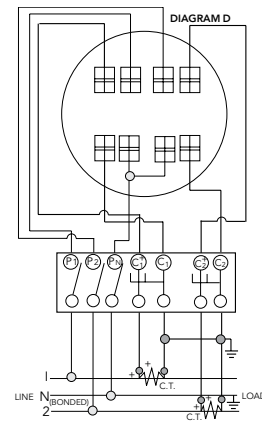

DIAGRAM E
3∅3W "Δ" with 2 P.T.'s & 2 C.T.'s
2 Stator Meter - Form 5S
8T Socket, Test Switch #TS07-0105

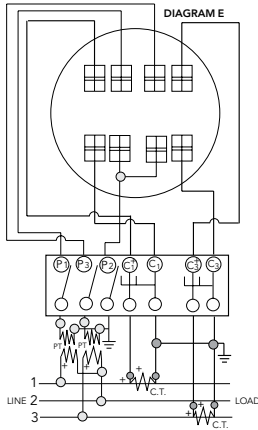

DIAGRAM F
3∅3W "Δ" with 2 C.T.'s
2 Stator Meter - Form 5S
8T Socket, Test Switch #TS07-0105

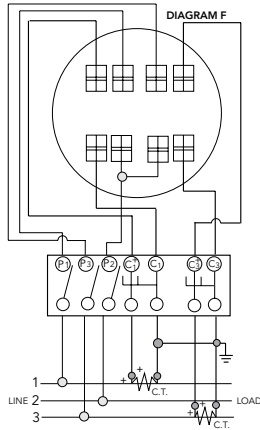

DIAGRAM G
3∅4W "Y" with 3 C.T.'s
2 1/2 Stator Meter - Form 6S
13T Socket, Test Switch #TS10-0109

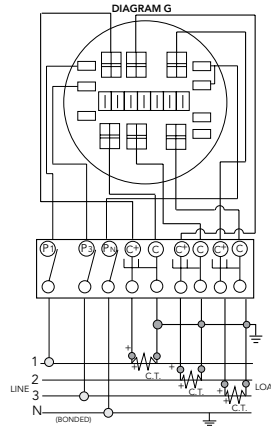

DIAGRAM H
3∅4W "Y" with 2 P.T.'s & 3 C.T.'s
2 1/2 Stator Meter - Form 6S
13T Socket, Test Switch #TS10-0109

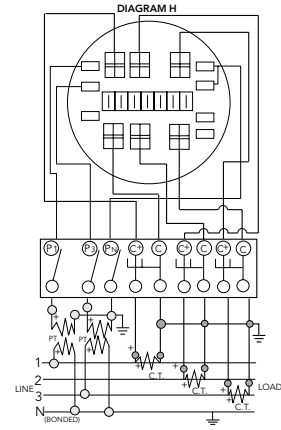

DIAGRAM I
3∅4W "Y" or "Δ" with 3 C.T.'s
"Y" 3 Stator Meter - Form 9S
"Δ" 2 Stator Meter - Form 8S
13T Socket, Test Switch #TS10-0109

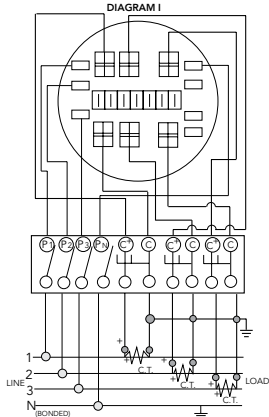
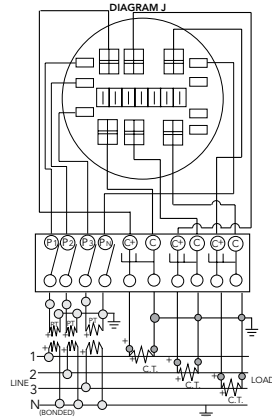

DIAGRAM J
3∅4W "Y" with 3 P.T.'s & 3 C.T.'s
3 Stator Meter - Form 9S
13T Socket, Test Switch #TS10-0109



Prewiring: If standard factory prewiring is required, refer to wiring diagrams on this page. Determine appropriate diagram and send a copy with order. If custom factory prewiring is required, specify on order. Be sure to include meter socket catalog number, test switch make and catalog number, meter form number and provide a copy of your wiring diagram.

Please consult serving utility for their requirements prior to ordering or installing, as specifications and approvals vary by utility, and may require local electrical inspector approval. All installations must be installed by a licensed electrician and must comply with all national and local codes, laws and regulations. Milbank reserves the right to make changes in specifications and features shown without notice or obligation.



Watt-hour Meter Forms

Standard Forms | Transformer Rated or Self-Contained

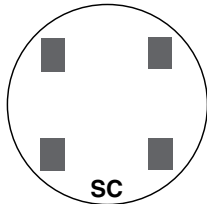

SC
2 and 3-WIRE FORMS
1S & 2S

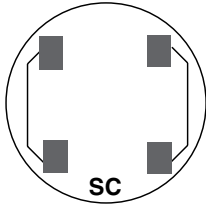

SC
2 and 3-WIRE FORMS
1S & 2S with BYPASS

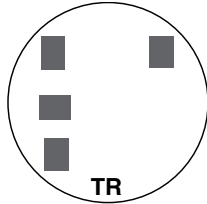

TR
2-WIRE FORM 3S
5th Term. 9 o'clock

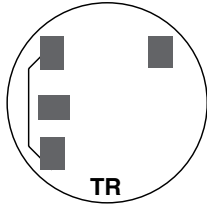

TR
2-WIRE FORM 3S
with BYPASS

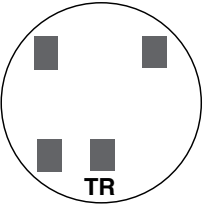

TR
2-WIRE FORM 3S
5th Term. 6 o'clock

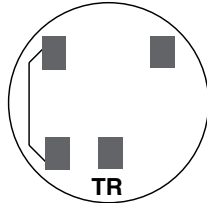

TR
2-WIRE FORM 3S
with BYPASS

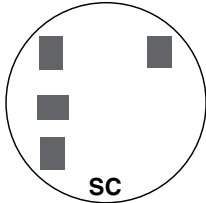

SC
2 ELEMENT
3-WIRE NETWORK
FORM 12S 5th
TERM. 9 o'clock

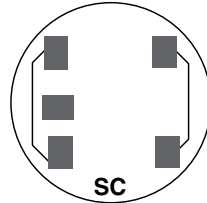

SC
2 ELEMENT 3-WIRE
NETWORK FORM 12S
with BYPASS
5th Term. 9 o'clock

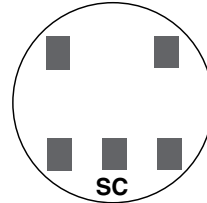

SC
2 ELEMENT
3-WIRE NETWORK
FORM 12S 5th
TERM. 6 o'clock

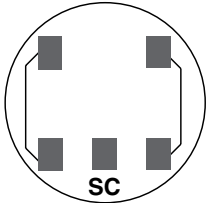

SC
2 ELEMENT 3-WIRE
NETWORK FORM 12S
with BYPASS
5th Term. 6 o'clock

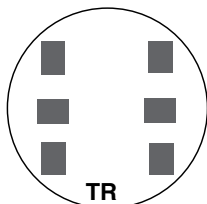

TR
3-WIRE FORM 4S

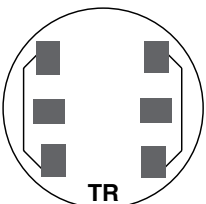

TR
3-WIRE FORM 4S
WITH BYPASS

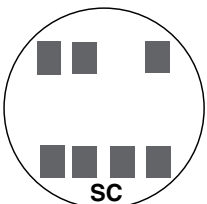

SC
2 or 3 ELEMENT
3Ø4W Y or
Y FORM 14S
FORM 15S
Y FORM 16S

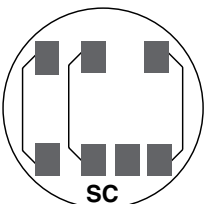

SC
2 or 3 ELEMENT
3Ø4W Y or
FORMS 14S & 15S
with BYPASS

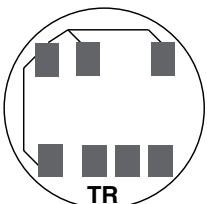

TR
2 ELEMENT
3Ø4W Y or
Y FORM 7S
FORM 24S
with BYPASS

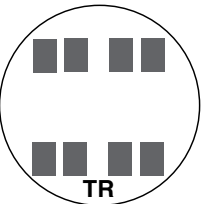

TR
2 ELEMENT
2Ø3W, 2Ø4W, 3Ø3W
FORM 5S

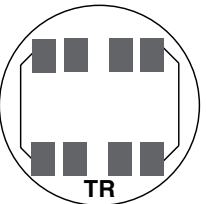

TR
2 ELEMENT Ø3W,
2Ø4W, 3Ø3W
FORM 5S with
BYPASS

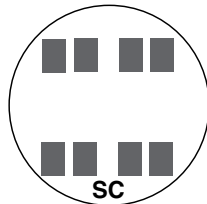

SC
2 ELEMENT
2Ø3W, 2Ø4W, 3Ø3W
FORM 13S

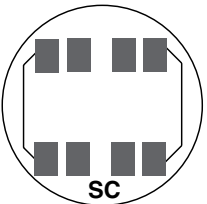

SC
2 or 3 ELEMENT
2Ø3W, 2Ø4W, 3Ø3W
FORM 13S with
BYPASS

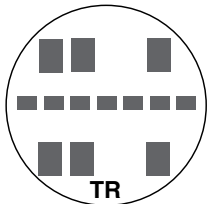

TR
2 or 3 ELEMENT
3Ø4W Y or
Y FORM 9S
FORM 8S

TR = TRANSFORMER RATED
SC = SELF CONTAINED

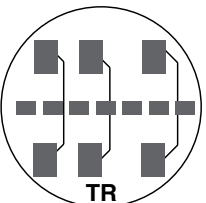

TR
2 or 3 ELEMENT
3Ø4W Y or
FORMS 8S & 9S
FORMS 8S & 9S
with BYPASS

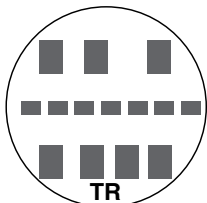

TR
2 ELEMENT
3Ø4W Y
FORM 6S

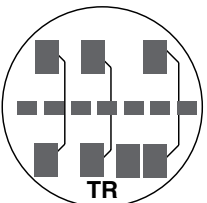

TR
2 ELEMENT
3Ø4W Y
FORM 6S
with BYPASS

Please consult serving utility for their requirements prior to ordering or installing, as specifications and approvals vary by utility, and may require local electrical inspector approval. All installations must be installed by a licensed electrician and must comply with all national and local codes, laws and regulations. Milbank reserves the right to make changes in specifications and features shown without notice or obligation.



2 Pole | 3 Wire | Grounding Receptacles

Straight Blade Wiring Devices				Twist-Lock Wiring Devices				
Volts	Code	15 Amps	20 Amps	30 Amps	50 Amps	15 Amps	20 Amps	30 Amps
125	5							
		5-15R	5-20R	5-30R	5-50R	L5-15R	L5-20R	L5-30R
250	6							
		6-15R	6-20R	6-30R	6-50R	L6-15R	L6-20R	L6-30R
277 VAC	7							
		7-15R	7-20R	7-30R	7-50R	L7-15R	L7-20R	L7-30R

3 Pole | 3 Wire | Special Applications

Straight Blade Wiring Devices			Twist-Lock Wiring Devices		
Volts	Code	20 Amps	30 Amps	50 Amps	30 Amps
125V 250V	10				
		10-20R	10-30R	10-50R	L10-20R L10-30R

3 Pole | 4 Wire | Grounding

Straight Blade Wiring Devices				Twist-Lock			
Volts	Code	15 Amps	20 Amps	30 Amps	50 Amps	20 Amps	30 Amps
125V 250V	14						
		14-15R	14-20R	14-30R	14-50R	L14-20R	L14-30R

2 Pole | 3 Wire | Grounding | NEMA Trailer

Straight Blade Wiring Devices		
Volts	Code	30 Amps
125V	TT	



Please consult serving utility for their requirements prior to ordering or installing, as specifications and approvals vary by utility, and may require local electrical inspector approval. All installations must be installed by a licensed electrician and must comply with all national and local codes, laws and regulations. Milbank reserves the right to make changes in specifications and features shown without notice or obligation.

6003.....	76	MR2-SS.....	76	QN2150RH.....	73
6116.....	76	MR-4.....	76	QN2200.....	73
5T8K2.....	77	Q115.....	73	QN2200H.....	73
A7514.....	75	Q115H.....	73	QN2200R.....	73
A7515.....	75	Q120.....	73	QN2200RH.....	73
A7516.....	75	Q120H.....	73	S1619-XL.....	9
A7517.....	75	Q125.....	73	S1994-WL-KK.....	54
A7518.....	75	Q125H.....	73	S2068-0.....	10
A7551.....	75	Q130.....	73	S8324.....	75
A8110.....	75	Q130H.....	73	SC2077-XL.....	54
A8111.....	75	Q135.....	73	SC2992-RL.....	54
A8112.....	75	Q135H.....	73	SC6128-XL.....	59
A9064.....	75	Q140.....	73	SC6129-O.....	59
A-GP.....	76	Q140H.....	73	U1079-R.....	16
CP-21.....	76	Q150.....	73	U1079-R-5T9.....	17
K1047.....	77	Q150H.....	73	U1129-O.....	16
K1190.....	77	Q160.....	73	U1129-O-5T9.....	17
K1350.....	76	Q160H.....	73	U1207-RL.....	12
K1350L.....	76	Q170.....	73	U1211-RXL.....	12
K1539.....	76	Q170H.....	73	U1252-X.....	32
K1540.....	76	Q2100.....	73	U1253-X.....	32
K1540L.....	76	Q2100H.....	73	U1254-X.....	32
K1541.....	76	Q2125.....	73	U1255-X.....	32
K3082.....	76	Q2125H.....	73	U1256-X.....	32
K3083.....	76	Q215.....	73	U1748-O-5T9-WI.....	53
K3441.....	76	Q215H.....	73	U1797-O-K3L-K2L.....	16
K3442.....	76	Q220.....	73	U1797-O-STU-STU.....	16
K3865.....	77	Q220H.....	73	U1980-0.....	10
K3866.....	77	Q225.....	73	U2120-O.....	18
K4802.....	77	Q225H.....	73	U2448-X.....	16
K4977-EXT.....	77	Q230.....	73	U2448-X-5T9.....	17
K4977-INT.....	77	Q230H.....	73	U2569-0.....	10
K5022-INT.....	77	Q235.....	73	U2594-X.....	18
K5815.....	76	Q235H.....	73	U2732-XT.....	34
K5820.....	76	Q240.....	73	U2733-XT.....	34
K5830.....	76	Q240H.....	73	U2734-XT.....	34
K5920-10GR.....	47	Q250.....	73	U2735-XT.....	34
K5920-111GR.....	47	Q250H.....	73	U2736-XT.....	34
K5920-11GR.....	47	Q260.....	73	U2852-X.....	35
K5920-38.....	47	Q260H.....	73	U2853-X.....	35
K5920-41.....	47	Q270.....	73	U2854-X.....	35
K5920-522.....	47	Q270H.....	73	U2855-X.....	35
K5920-54.....	47	Q280.....	73	U2856-X.....	35
K5920-58.....	47	Q280H.....	73	U2862-X.....	35
K5920-75.....	47	Q290.....	73	U2863-X.....	35
K5920-BLANK.....	47	Q290H.....	73	U2864-X.....	35
K5T.....	77	QN2150.....	73	U2865-X.....	35
M5-144.....	77	QN2150H.....	73	U2866-X.....	35
MR-2.....	76	QN2150R.....	73	U2872-XT-5T9.....	33

Please consult serving utility for their requirements prior to ordering or installing, as specifications and approvals vary by utility, and may require local electrical inspector approval. All installations must be installed by a licensed electrician and must comply with all national and local codes, laws and regulations. Milbank reserves the right to make changes in specifications and features shown without notice or obligation.



U2873-Xt-5T9.....	33	U4702-X.....	16	U5220-XL-55.....	45
U2874-Xt-5T9.....	33	U4721-0-BL.....	13	U5220-XL-75.....	45
U2875-Xt-5T9.....	33	U4724-O-5T9.....	49	U5220-XL-75GB.....	45
U2876-Xt-5T9.....	33	U4801-0-5T9.....	14	U5268-XTL-150.....	22
U2986-0.....	10	U4801-XL.....	13	U5268-XTL-150-KK.....	22
U3000-O-K3L-K2L.....	17	U4801-XL-5T9.....	14	U5268-XTL-200.....	22
U3278-RL.....	11	U4811-O-21.....	40	U5268-XTL-200-KK.....	22
U3491-XL-150.....	19	U4833-O.....	50	U5300-O.....	46
U3491-XL-200.....	19	U4833-O-5T9.....	50	U5300-O-41.....	46
U3499-XL.....	19	U4834-XL-200-5T9.....	23	U5300-O-55.....	46
U3598-RL-TG.....	11	U4881-O.....	7	U5300-O-552GR.....	46
U3771-XL-100.....	24	U4881-O-50GB.....	7	U5300-O-75.....	46
U3791N-RXL-(AMP).....	24	U4881-O-60GB.....	7	U5320-O.....	46
U3791N-RXL-(AMP)-5T9.....	24	U4911-X-QG-BL.....	18	U5320-O-41.....	46
U3802.....	5	U5000-XL.....	43	U5320-O-55.....	46
U3812.....	5	U5000-XL-332.....	43	U5320-O-552GR.....	46
U3822-20GWR.....	6	U5000-XL-41.....	43	U5320-O-75.....	46
U3832.....	5	U5000-XL-55.....	43	U5701-O-5T9.....	51
U3849-O-2/200-5T9.....	53	U5000-XL-75.....	43	U5702-O-5T9.....	51
U3862.....	5	U5000-XL-75GB.....	43	U5703-O-5T9.....	51
U3924-XL.....	13	U5059-X-2/200-5T9.....	26	U5750-RXL-200-BL.....	24
U3995-XL-200-5T9.....	23	U5059-X-5T9-K3L.....	26	U5764-X-200-5T-CB.....	28
U4031-O-2/200-5T9.....	26	U5091-RL-76GBGR.....	42	U5764-X-200-CB.....	28
U4184-X.....	15	U5100-XL.....	44	U5767-X-200-CB.....	28
U4216-RXL.....	11	U5100-XL-41.....	44	U5784-O-200-CB.....	28
U4322-O.....	50	U5100-XL-55.....	44	U5794-X-400-5T-CB.....	28
U4322-O-5T9.....	50	U5100-XL-552GR.....	44	U5794-X-400-CB.....	28
U4323-O.....	50	U5100-XL-75.....	44	U5796-X-400-CB.....	28
U4323-O-5T9.....	50	U5100-XL-75GB.....	44	U5797-O-400-CB.....	28
U4372-Xt-5T9.....	39	U5136-O-200S.....	48	U5842-RL-200.....	20
U4373-Xt-5T9.....	39	U5137-O-200S.....	48	U5844-PXL.....	20
U4374-Xt-5T9.....	39	U5168-XTL-100.....	22	U5880-XL-200-5T9.....	24
U4375-Xt-5T9.....	39	U5168-XTL-100-KK.....	22	U5882-X.....	37
U4376-Xt-5T9.....	39	U5168-XTL-100-KK-5T.....	22	U5883-X.....	37
U4413-0.....	10	U5168-XTL-150.....	22	U5884-X.....	37
U4490-XL.....	55	U5168-XTL-150-KK.....	22	U5885-X.....	37
U4492-XL.....	55	U5168-XTL-150-KK-5T.....	22	U5886-X.....	37
U4493-XL.....	55	U5168-XTL-200.....	22	U5890-X-2/200.....	27
U4494-XL.....	55	U5168-XTL-200-KK.....	22	U5891-X-2/200.....	27
U4496-XL.....	55	U5200-XL.....	45	U5892-X-2/200.....	27
U4497-XL.....	55	U5200-XL-332.....	45	U5893-X-2/200.....	27
U4540-XL.....	60	U5200-XL-41.....	45	U5894-X-2/200.....	27
U4542-XL.....	60	U5200-XL-41GB.....	45	U5895-X-2/200.....	27
U4544-XL.....	60	U5200-XL-55.....	45	U5902-X.....	37
U4546-XL.....	60	U5200-XL-75.....	45	U5903-X.....	37
U4548-RXL.....	60	U5200-XL-75GB.....	45	U5904-X.....	37
U4549-RXL.....	60	U5220-XL.....	45	U5905-X.....	37
U4550-RL-5T9.....	14	U5220-XL-332.....	45	U5906-X.....	37
U4551-RXL-5T9.....	14	U5220-XL-41.....	45	U5934-XL-BLG.....	8
U4701-XL.....	15	U5220-XL-41GB.....	45	U5972-Xt-5T9-AMS.....	41



Please consult serving utility for their requirements prior to ordering or installing, as specifications and approvals vary by utility, and may require local electrical inspector approval. All installations must be installed by a licensed electrician and must comply with all national and local codes, laws and regulations. Milbank reserves the right to make changes in specifications and features shown without notice or obligation.

U5973-XT-5T9-AMS	41	U9647N-XL-100	21	UQFB-175.....	74
U5974-XT-5T9-AMS	41	U9647N-XL-200	21	UQFB-175-X1	74
U5975-XT-5T9-AMS	41	U9648-RL-100	21	UQFB-200.....	74
U5976-XT-5T9-AMS	41	U9701-RXL	15	UQFB-200-X1	74
U6035-O	40	U9761-RRL	15	UQFBH-100	74
U6134-RL-76GBGR	42	U9800-RRL	13	UQFBH-125	74
U6158-O-MNV	40	U9801-RXL	13	UQFBH-150	74
U6221-O-100-10GR.....	52	U9865-RRL	13	UQFBH-175	74
U6221-O-200-10GR.....	52	UAP6094-O	61	UQFBH-200	74
U6281-XL-100 -5T9	25	UAP6095-O	61	UQFP-100.....	74
U6281-XL-150 -5T9	25	UAP6096-O	61	UQFP-125.....	74
U6281-XL-200 -5T9	25	UC1290-RL	56	UQFP-150.....	74
U6282-XL-200 -5T9	25	UC1291-RL	56	UQFP-175.....	74
U7021-RL-TG	9	UC1299-RL	56	UQFP-200.....	74
U7040-0-TG	9	UC1300-RL	56	UQFPH-100	74
U7040-XL-TG	9	UC3423-XL	58	UQFPH-125	74
U7043-XL-TG	9	UC3425-XL	58	UQFPH-150	74
U7362-XL	29	UC3426-XL	58	UQFPH-175	74
U7363-XL	29	UC3428-XL	58	UQFPH-200	74
U7364-XL	29	UC3433-XL	58	UQFPH-M-100.....	74
U7365-XL	29	UC3434-XL	58	UQFPH-M-100.....	74
U7366-XL	29	UC3435-XL	58	UQFPH-M-125.....	74
U7420-RL	12	UC3436-XL	58	UQFPH-M-125.....	74
U7421-RL	12	UC3438-XL	58	UQFPH-M-150.....	74
U7422-RXL.....	12	UC7233-RL	56	UQFPH-M-150.....	74
U7423-RXL.....	12	UC7235-RL	56	UQFPH-M-175.....	74
U7445-RL-WC-951.....	59	UC7237-RL	56	UQFPH-M-175.....	74
U7487-RL.....	8	UC7442-RL	57	UQFPH-M-200.....	74
U7487-RL-TG-KK	8	UC7444-RL	57	UQFPH-M-200.....	74
U7573-RL	11	UC7445-RL	57	UQFP-M-100	74
U7588-XL	8	UC7445-XL-371	59	UQFP-M-125	74
U8032-RL	31	UC7446-RL	57	UQFP-M-150	74
U8033-RL	31	UC7448-RL	57	UQFP-M-175	74
U8034-RL	31	UC7449-RL	57	UQFP-M-200	74
U8035-RL	31	UC7450-RL	57		
U8036-RL	31	UC7460-RL	57		
U8100-RL	11	UC7461-RL	57		
U8212-XL	30	UC7478-RL	57		
U8213-XL	30	UC7478-RL-WC-271	59		
U8214-XL	30	UC7532-RL	57		
U8215-XL	30	UC7544-RL	56		
U8216-XL	30	UC7545-XL	56		
U9107-0	49	UC7546-RL	56		
U9108-O-5T9.....	49	UC7636-RL	57		
U9318-RL	12	UQFB-100.....	74		
U9319-RL	12	UQFB-100-X1	74		
U9320-RRL	11	UQFB-125	74		
U9321-RL	11	UQFB-125-X1	74		
U9550-RRL	14	UQFB-150	74		
U9551-RXL	14	UQFB-150-X1	74		

Please consult serving utility for their requirements prior to ordering or installing, as specifications and approvals vary by utility, and may require local electrical inspector approval. All installations must be installed by a licensed electrician and must comply with all national and local codes, laws and regulations. Milbank reserves the right to make changes in specifications and features shown without notice or obligation.





MILBANK[®]

ENERGY AT WORK

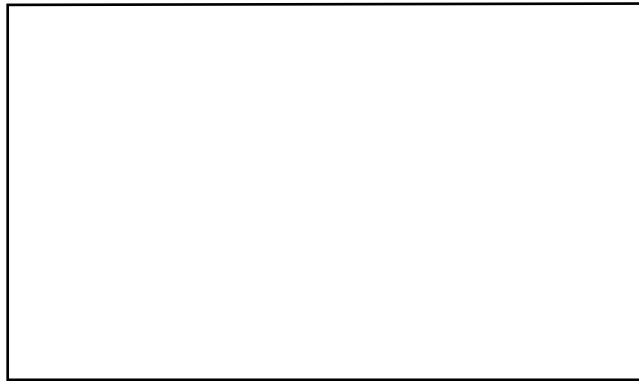

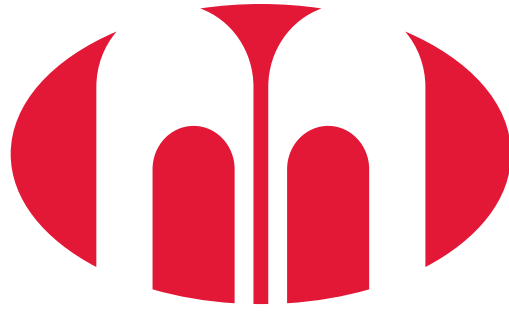

MILBANK[®]
ENERGY AT WORK



Upper Midwest Catalog

Meter Mounting Equipment



Milbank Overview

Energy At Work since 1927

Milbank designs and manufactures electrical solutions that move and manage power for the residential, commercial, industrial, utility and transportation sectors. With 90 years of expertise in electrical engineering design and manufacturing, Milbank's portfolio includes metering equipment, enclosures and enclosed controls. Founded in 1927, Milbank is a family-owned, American manufacturer headquartered in Kansas City, Mo. For more information, please visit milbankworks.com.



METERING

As a market leader in electrical metering equipment, Milbank has set the standard for quality since 1927. Hundreds of configurations are available, including many sizes, knockout configurations, terminal configurations, bypass options, hubs, locks and connectors. Milbank has the socket you need with thousands of active products to meet your utility's requirements.



ENCLOSURES

Milbank's line of enclosures include commercial junction boxes, panel mount enclosures, transformer cabinets, wireway, trough and industrial panel mount and push-button enclosures. Built with high-quality craftsmanship and materials which meet or exceed industry standards, Milbank enclosures are made to protect controls and equipment from dust, dirt and other harmful elements found in a wide variety of environments.



ENCLOSED CONTROLS

Milbank doesn't just build empty enclosures. We can deliver the entire package, complete with custom control equipment built to your exact specifications by our engineers. Milbank commercial pedestals are an attractive, secure, easy to install and cost-effective solution when underground remote site power distribution and control equipment is required, replacing unsightly and inefficient strut and backboard structures.



Please consult serving utility for their requirements prior to ordering or installing, as specifications and approvals vary by utility, and may require local electrical inspector approval. All installations must be installed by a licensed electrician and must comply with all national and local codes, laws and regulations. Milbank reserves the right to make changes in specifications and features shown without notice or obligation.

Table of Contents

Air Conditioner Disconnects

30-60 amp AC disconnects	5
60 amp AC disconnect with 20 amp GFCI receptacle	6
Hot tub disconnects	7

Single Position Sockets

100-125 amp, 4 terminal, ringless	8
200 amp, 4 terminal, ringless	9
200 amp, 4 terminal, ringless, side wireway	10
125 & 200 amp, 7 terminal, medium duty	11

Single Position with Lever Bypass

200 amp, 4 & 5 terminal, ringless, medium duty	12
200 amp, 4 terminal, ringless	13
200 amp, 5 terminal, ringless	14
200 amp, 7 terminal, ringless	15
320 amp, 4 terminal, ringless	16
320 amp, 5 terminal, ringless	17
320 amp, 7 terminal, ringless	18

Meter Mains

100-200 amps, 4 terminal, ringless	19-21
------------------------------------------	-------

Meter Mains with Load Center

100-200 amps, 4 & 5 terminal, ringless	22
----------------------------------------------	----

Meter Mains with Lever Bypass

100-200 amp, 4, 5, & 7 terminal, ringless	23-24
200 amp, 5 terminal, ringless	25
320 amp, 4 & 5 terminal, ringless	26-27

Cold Sequence

200 amp, 4, 5, & 7 terminal, ringless	28
---------------------------------------------	----

Multi-Position Sockets

100 amp, 4 terminal, ringless	29-31
200 amp, 4 & 5 terminal, ringless	32-33
200 amp, 7 terminal, ringless, lever bypass	34
125 & 200 amp, 4 terminal, ringless	35-36
125 & 200 amp, 4 terminal, ringless	37-38

Please consult serving utility for their requirements prior to ordering or installing, as specifications and approvals vary by utility, and may require local electrical inspector approval. All installations must be installed by a licensed electrician and must comply with all national and local codes, laws and regulations. Milbank reserves the right to make changes in specifications and features shown without notice or obligation.



Multi-Position Meter Mains

200 amp, 5 terminal, ringless.....	39
200 amp, 4 & 5 terminal, ringless, demand side management.....	40
200 amp, 5 terminal, ringless, lever bypass	41

Temporary Power

125 amp, surface mount power outlet, lever bypass.....	42
125 amp, surface mount power outlet, unmetered	43
125 amp, surface mount power outlet.....	44

Power Outlet Pedestals

125 amp, unmetered power outlet pedestal.....	45
125 amp, metered power outlet pedestal.....	46
Replacement Parts.....	47

Meter Mains with Pedestals

200 amp, 4 terminal, ringless, with load center.....	48
200 amp, 5 & 7 terminal, ringless	49
200 amp, 4 & 5 terminal, ringless, lever bypass, with load center.....	50
200 amp, 5 terminal, ringless, lever bypass.....	51
200 amp, 4 terminal, ringless, lever bypass.....	52

Residential Pedestal

320 amp, 5 terminal, lever bypass.....	53
----------------------------------------	----

Transformer Rated

20 amp, 5 terminal, with bypass.....	54
20 & 80 amp, 6, 8 & 13 terminal	55
20 amp, 5-15 terminal, ringless	56-59

Miscellaneous

Connector Kits.....	60
Terminal Box.....	61
Multi-position Tap Box.....	62
Commercial Pedestals.....	63-72
Circuit Breakers	73-74
Accessories	75-77
Commercial & Industrial Enclosures.....	78
Reference Information	79-84
Index.....	85



Please consult serving utility for their requirements prior to ordering or installing, as specifications and approvals vary by utility, and may require local electrical inspector approval. All installations must be installed by a licensed electrician and must comply with all national and local codes, laws and regulations. Milbank reserves the right to make changes in specifications and features shown without notice or obligation.

Air Conditioner Disconnects

30-60 Amp | Fusible & Non-Fusible



U3802



U3812



U3832

Milbank's air conditioner disconnect has a removable hinged cover for ease of installation. Our compact design meets NEC wiring space requirements and also complies with NEC article 440-14. For safe working conditions, our disconnect pullers may be removed and reinstalled in the OFF position. Additionally, padlock provisions are included on the front cover. As with other Milbank products, our enclosure is constructed of G90U galvanized steel and electrostatically finished with an attractive, light gray, baked powder coating. Our epoxy/polyester resin blend offers a finish that is both durable and fade-resistant.

30-60 Amp | 1Ø 240 VAC | Air Conditioner Disconnects

Catalog Number	Amp	Type	Max H.P.	Weight (lbs.)	Line/Load Wire Range		Ground Wire Range CU/AL	Dimensions			Wire Rating	
					CU	AL		D"	W"	H"	CU °C	AL °C
U3802	60	Non-Fusible	10	3.25	#14-#2	#12-#2	#14-4	2½	5	7½	60°/75°	60°/75°
U3812	60	Non-Auto	10	3.25	#14-#2	#12-#2	#14-4	2½	5	7½	60°/75°	60°/75°
U3832	30	Fusible	3	2.5	#14-#3	#14-#3	#14-3	2½	5	7	60°/75°	60°/75°
U3862	60	Fusible	10	3.3	#14-#3	#14-#3	#14-3	2½	5	9	60°/75°	60°/75°

Notes

- UL listed as Enclosed Pullout Switch.
- Type 3R rain resistant.
- One-inch concentric knockouts.

Please consult serving utility for their requirements prior to ordering or installing, as specifications and approvals vary by utility, and may require local electrical inspector approval. All installations must be installed by a licensed electrician and must comply with all national and local codes, laws and regulations. Milbank reserves the right to make changes in specifications and features shown without notice or obligation.



Air Conditioner Disconnects

20 Amp GFCI Receptacle



U3822-20GWR

Specifications

- Meets NEC #210.63 requirements
- UL listed as Power Outlet
- Type 3R enclosure
- In-use cover*
- Duplex ground connector
- 1" concentric knockouts
- 1Ø, 240 volt
- 60 amp, non-fused
- 20 amp GFCI receptacle
- Reset/test button
- Weather and tamper resistant
- Meets NEC #406.8 requirements

60 Amp | 1Ø, 240 VAC | Air Conditioner Disconnect with GFCI Receptacle

Catalog Number	Type	Max H.P.	Weight (lbs.)	Line/Load Wire Range		Ground Wire Range CU/AL	Dimensions			Wire Rating	
				CU	AL		D"	W"	H"	CU °C	AL °C
U3822-20GWR	Non-Fusible	10	6	#14-#2	#12-#2	#14-4	4½	5¼	7½	60°/75°	60°/75°

Notes

- **Disconnect Pullers:** To ensure the safest conditions, Milbank disconnect pullers are reversible so they may be reinstalled in the OFF position.
 - **Padlock Provision:** All units are designed with a padlock provision on the cover for security.
- ***In-Use Cover:** Cover is rated as an in-use cover (cover may be closed with cords plugged into receptacle).



Please consult serving utility for their requirements prior to ordering or installing, as specifications and approvals vary by utility, and may require local electrical inspector approval. All installations must be installed by a licensed electrician and must comply with all national and local codes, laws and regulations. Milbank reserves the right to make changes in specifications and features shown without notice or obligation.

Hot Tub Disconnects

Type 3R Enclosures



U4881-O-50GB



U4881-O-60GB

Specifications

- 240 volt ground fault protection
- UL listed, Type 3R rain resistant
- 2-pole, 50 amp GFCI breaker protection
- Compact size
- Three or four wire installation
- 1Ø, 120/240 VAC
- Standard package of 12
- Two extra one-pole breaker spaces
- 100 amp overall rating
- Easy to install

100 Amp | Hot Tub Disconnect or Sub Panel Breaker Enclosure | Type 3R

Catalog Number	Breaker amp	Type	Weight (lbs.)	Line/Load Wire Range		Ground Wire Range CU/AL	Dimensions		
				CU	AL		D"	W"	H"
U4881-O	—	Breaker Provision	7	#14-1/0	#14-1/0	#14-1/0	3¾	7½	8½
U4881-O-50GB	50	Breaker	8	#14-1/0	#14-1/0	#14-1/0	3¾	7½	8½
U4881-O-60GB	60	Breaker	8	#14-1/0	#14-1/0	#14-1/0	3¾	7½	8½

Please consult serving utility for their requirements prior to ordering or installing, as specifications and approvals vary by utility, and may require local electrical inspector approval. All installations must be installed by a licensed electrician and must comply with all national and local codes, laws and regulations. Milbank reserves the right to make changes in specifications and features shown without notice or obligation.



8

100-125 AMP
SINGLE
POSITION

Single Position Sockets

100-125 Amp | 4 Terminal | Ringless | 600 VAC



U5934-XL-BLG

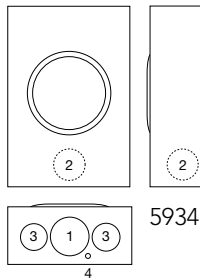

U7487-RL

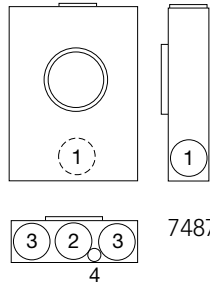

U7588-XL

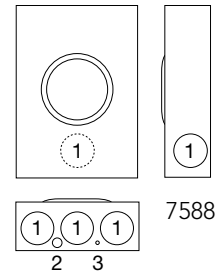

4 Terminal | Single Position | Ringless

Catalog Number	Amp	Service	Hub	Line/Load Wire Range		Bypass	Dimensions			Knockouts			
				CU	AL		D"	W"	H"	1	2	3	4
U7487-RL	125	OH/UG	H.O.	#6-2/0	#6-2/0	None	3 ⁵ / ₁₆	8	11 ¹ / ₂	2	1 ¹ / ₂	1 ¹ / ₄	1 ¹ / ₄
U7487-RL-TG-KK	125	OH/UG	H.O.	#6-2/0	#6-2/0	Horn	3 ⁵ / ₁₆	8	11 ¹ / ₂	2	1 ¹ / ₂	1 ¹ / ₄	1 ¹ / ₄
U7588-XL	125	OH/UG	C.P.	#6-2/0	#6-2/0	None	4 ¹ / ₈	11	15 ¹ / ₂	2 ¹ / ₂	1 ¹ / ₄ , 1 ¹ / ₂	1 ¹ / ₄	—

4 Terminal | Single Position | Ringless | Solar/Alternative Energy

Catalog Number	Amp	Service	Hub	Line/Load Wire Range		Bypass	Dimensions			Knockouts			
				CU	AL		D"	W"	H"	1	2	3	4
U5934-XL-BLG	100	OH/UG	C.P.	#12-1/0	#12-1/0	None	3 ⁵ / ₁₆	8	11 ¹ / ₂	2	1 ¹ / ₂	1 ¹ / ₄	1 ¹ / ₄

Notes

- **Fifth Terminal:** For field mounted fifth terminal, order catalog number **5T8K2**.
- **Hubs:** For the proper hub selection, see the hub suffix chart on the accessories page.
- **Connectors:** Extruded aluminum connectors are tin plated. Units are supplied with duplex neutral. For triplex ground, add suffix **-TG** to the catalog number.
- **Bypass:** Horn bypass is available for the ringless units. Add the suffix **-KK** to the catalog number.
- **Isolated Neutral:** **U5934** includes an isolated neutral option.



Please consult serving utility for their requirements prior to ordering or installing, as specifications and approvals vary by utility, and may require local electrical inspector approval. All installations must be installed by a licensed electrician and must comply with all national and local codes, laws and regulations. Milbank reserves the right to make changes in specifications and features shown without notice or obligation.

Single Position Sockets

200 Amp | 4 Terminal | Ringless | 600 VAC

9
200 AMP
SINGLE
POSITION



U7021-RL-TG



U7040-XL-TG

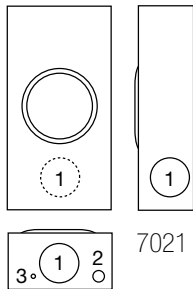

7021

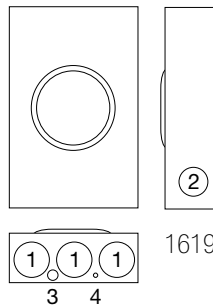

1619

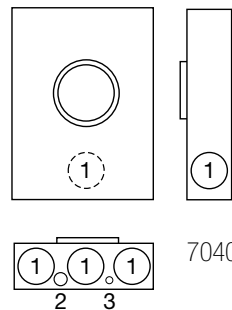

7040

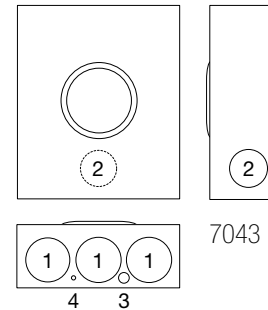

7043

200 Amp | 4 Terminal | Single Position | Ringless

Catalog Number	Service	Hub	Line/Load Wire Range		Dimensions			Knockouts			
			CU	AL	D"	W"	H"	1	2	3	4
U7021-RL-TG	OH	H.O.	#6-350	#6-350	4 $\frac{1}{8}$	8	15 $\frac{1}{2}$	2 $\frac{1}{2}$	$\frac{1}{4}$, $\frac{1}{2}$	$\frac{1}{4}$	—
U7040-0-TG	OH/UG	Blank	#6-350	#6-350	4 $\frac{1}{8}$	11	14 $\frac{5}{8}$	2 $\frac{1}{2}$	$\frac{1}{4}$, $\frac{1}{2}$	$\frac{1}{4}$	—
U7040-XL-TG	OH/UG	C.P.	#6-350	#6-350	4 $\frac{1}{8}$	11	14 $\frac{5}{8}$	2 $\frac{1}{2}$	$\frac{1}{4}$, $\frac{1}{2}$	$\frac{1}{4}$	—
U7043-XL-TG	OH/UG	C.P.	#6-350	#6-350	4 $\frac{1}{8}$	13	15 $\frac{1}{2}$	3	2 $\frac{1}{2}$	$\frac{1}{4}$, $\frac{1}{2}$	$\frac{1}{4}$
S1619-XL*	OH/UG	C.P.	$\frac{3}{8}$ " x 16 Stud	$\frac{3}{8}$ " x 16 Stud	4 $\frac{1}{8}$	11	17	2 $\frac{1}{2}$	2	$\frac{1}{4}$, $\frac{1}{2}$	$\frac{1}{4}$

Notes

- ***S1619-XL:** Non-UL listed. For UL listed units, see other items on this page.
- **Fifth Terminal:** For field mounted fifth terminal, order as extra **5KT**.
- **Hubs:** For the proper hub selection, see the hub suffix chart on the accessory page.
- **Connectors:** Extruded aluminum connectors are tin plated. Units are supplied with duplex neutral. Stud type units supplied with $\frac{3}{8}$ " - 16 hex head nuts with Belleville washers. For connector kits, order as extra **K1539**.
- **Bypass:** Horn bypass is available — add the suffix **-KK** to the catalog number.

Please consult serving utility for their requirements prior to ordering or installing, as specifications and approvals vary by utility, and may require local electrical inspector approval. All installations must be installed by a licensed electrician and must comply with all national and local codes, laws and regulations. Milbank reserves the right to make changes in specifications and features shown without notice or obligation.



Single Position Sockets

200 Amp | 4 Terminal | Side Wireway | Ringless | 600 VAC

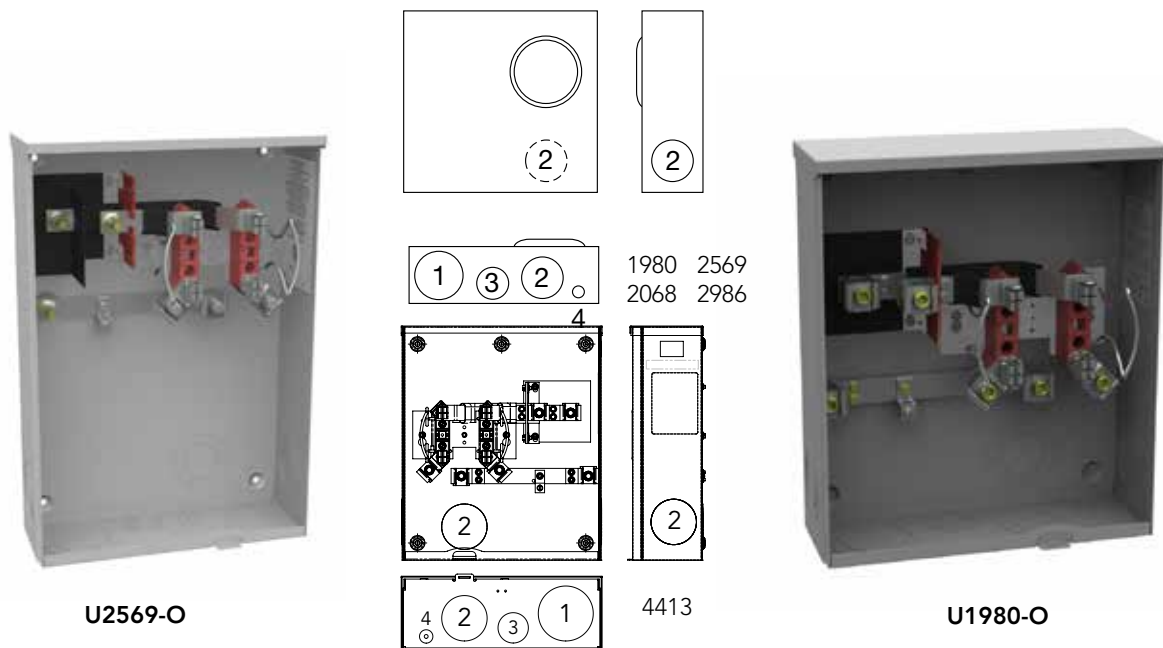

U2569-O

U1980-O

200 Amp | 4 Terminal | Side Wireway | Single Position | Ringless

Catalog Number	Service	Hub	Line/Load Wire Range		Dimensions			Knockouts			
			CU	AL	D"	W"	H"	1	2	3	4
S2068-0*	UG	Blank	3/8" x 16 Stud	#6-350	4 1/2	13	15 1/2	3	2 1/2	1 1/2	1/4, 1/2
U1980-0	UG	Blank	#6-350	#6-350	4 1/2	13	15 1/2	3	2 1/2	1 1/2	1/4, 1/2
U4413-0**	UG	Blank	#6-350	#6-350	4 1/2	13	15 1/2	3	2 1/2	1 1/2	1/4, 1/2
U2569-0	UG	Blank	3/8" x 16 Stud	#6-350	4 1/2	13	19	3	2 1/2	1 1/2	1/4, 1/2
U2986-0	UG	Blank	3/8" x 16 Studs	3/8" x 16 Studs	4 1/2	13	19	3	2 1/2	1 1/2	1/4, 1/2

Notes

- ***S2068-O:** Non-UL listed. For UL listed units, see other items on this page.
- ****U4413-O:** Design is a mirror image of U1980 with a left meter position.
- **Fifth Terminal:** For factory installed fifth terminal in the 9 o'clock position, add suffix **-5T**. For field installed fifth terminal, order catalog number **K5T**.
- **Connectors:** Extruded aluminum connectors are tin plated. Units are supplied with triplex neutral. Stud type units supplied with 3/8"-16 hex head nuts with Belleville washers. For connector kits, order as extra **K1539**.

Single Position Sockets

125 & 200 Amp | 7 Terminal | Ringless | Medium Duty | 600 VAC

1 1
125-200 AMP
SINGLE
POSITION



U3278-RL

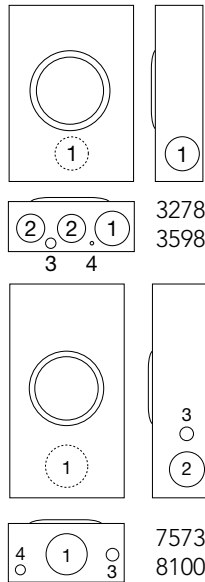

U9320-RRL

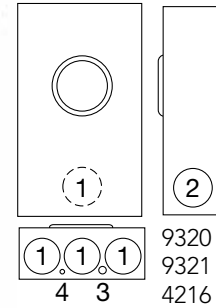

125 Amp | 7 Terminal | Single Position | Medium Duty | Ringless

Catalog Number	Service	Hub	Line/Load Wire Range		Bypass	Dimensions			Knockouts			
			CU	AL		D"	W"	H"	1	2	3	4
U7573-RL	OH	H.O.	#6-2/0	#6-2/0	Lever	4 ⁷ / ₈	10	18 ¹ / ₂	2	2	3/4	1/4, 1/2
U8100-RL	OH	H.O.	#6-2/0	#6-2/0	None	4 ⁷ / ₈	10	18 ¹ / ₂	2	2	3/4	1/4, 1/2
U9320-RRL	OH/UG	H.O.	#6-2/0	#6-2/0	Lever	4 ⁷ / ₈	13	19	3	2 ¹ / ₂	1/4, 1/2	1/2
U9321-RL	OH/UG	H.O.	#6-2/0	#6-2/0	None	4 ¹ / ₂	13	19	3	2 ¹ / ₂	1/4, 1/2	1/2

200 Amp | 4 & 5 Terminal | Single Position | Residential Bypass | Ringless

Catalog Number	Terminals	Service	Hub	Line/Load Wire Range		Bypass	Dimensions			Knockouts			
				CU	AL		D"	W"	H"	1	2	3	4
U3278-RL	4	OH	H.O.	#6-350	#6-350	Lever	4 ⁷ / ₈	11	15 ¹ / ₂	2 ¹ / ₂	2	1/4, 1/2	1/4
U3598-RL-TG*	5	OH	H.O.	#6-350	#6-350	Lever	4 ⁷ / ₈	11	15 ¹ / ₂	2 ¹ / ₂	2	1/4, 1/2	1/4
U4216-RXL	4	OH/UG	C.P.	#6-350	#6-350	Lever	4 ⁷ / ₈	13	19	3	2 ¹ / ₂	1/4, 1/2	1/4

Notes

- **Hubs:** For the proper hub selection, see the hub suffix chart on the accessory page.
- **Connectors:** Units supplied with extruded aluminum connectors and bonded triplex neutral.
- **Bypass:** Lever operates bypass device only — does not provide clamping action on meter spades.

Please consult serving utility for their requirements prior to ordering or installing, as specifications and approvals vary by utility, and may require local electrical inspector approval. All installations must be installed by a licensed electrician and must comply with all national and local codes, laws and regulations. Milbank reserves the right to make changes in specifications and features shown without notice or obligation.



Single Position Lever Bypass

200 Amp | 4 & 5 Terminal | Ringless | 600 VAC

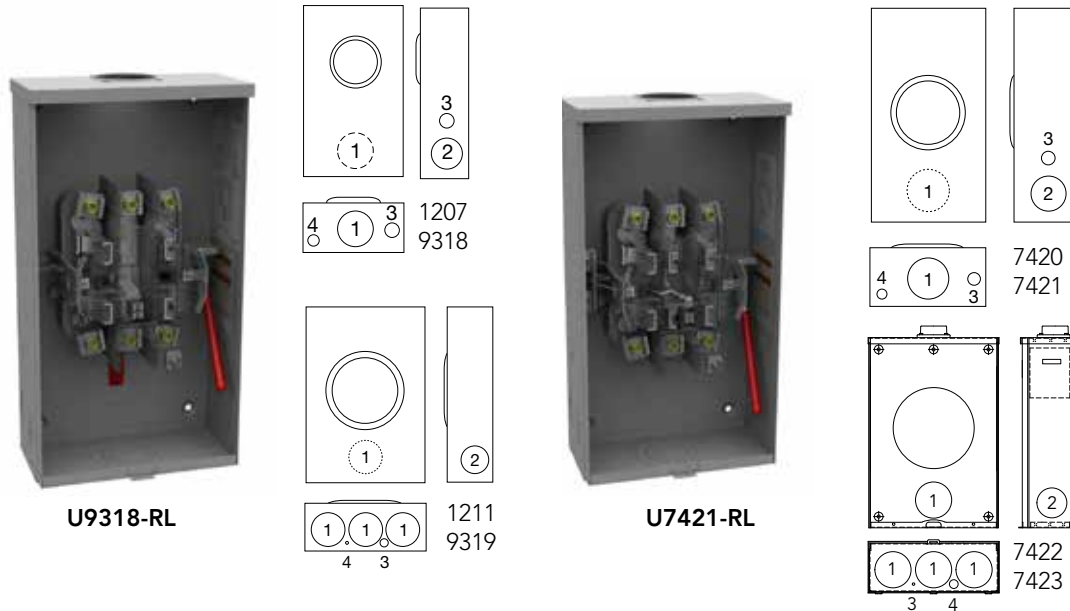

200 Amp | 4 & 5 Terminal | Single Position | Lever Bypass | Ringless

Catalog Number	Terminals	Service	Hub	Line/Load Wire Range		Bypass	Dimensions			Knockouts			
				CU	AL		D"	W"	H"	1	2	3	4
U1207-RL	4	OH	H.O.	#6-350	#6-350	Lever	4 $\frac{7}{8}$	10	18 $\frac{1}{2}$	3	2 $\frac{1}{2}$	$\frac{3}{4}$	$\frac{1}{4}, \frac{1}{2}$
U1211-RXL	4	OH/UG	C.P.	#6-350	#6-350	Lever	4 $\frac{7}{8}$	13	19	3	2 $\frac{1}{2}$	$\frac{1}{4}, \frac{1}{2}$	$\frac{1}{4}$
U9318-RL	5	OH	H.O.	#6-350	#6-350	Lever	4 $\frac{7}{8}$	10	18 $\frac{1}{2}$	3	2 $\frac{1}{2}$	$\frac{3}{4}$	$\frac{1}{4}, \frac{1}{2}$
U9319-RL	5	OH/UG	C.P.	#6-350	#6-350	Lever	4 $\frac{7}{8}$	13	19	3	2 $\frac{1}{2}$	$\frac{1}{4}, \frac{1}{2}$	$\frac{1}{4}$

200 Amp | 7 Terminal | Single Position | Medium Duty | Ringless

Catalog Number	Service	Hub	Line/Load Wire Range		Bypass	Dimensions			Knockouts			
			CU	AL		D"	W"	H"	1	2	3	4
U7420-RL	OH	H.O.	#6-350	#6-350	None	4 $\frac{7}{8}$	10	18 $\frac{1}{2}$	3	2 $\frac{1}{2}$	$\frac{3}{4}$	$\frac{1}{4}, \frac{1}{2}$
U7421-RL	OH	H.O.	#6-350	#6-350	Lever	4 $\frac{7}{8}$	10	18 $\frac{1}{2}$	3	2 $\frac{1}{2}$	$\frac{3}{4}$	$\frac{1}{4}, \frac{1}{2}$
U7422-RXL	OH/UG	C.P.	#6-350	#6-350	None	4 $\frac{7}{8}$	13	19	3	2 $\frac{1}{2}$	$\frac{1}{4}, \frac{1}{2}$	$\frac{1}{2}$
U7423-RXL	OH/UG	C.P.	#6-350	#6-350	Lever	4 $\frac{1}{2}$	13	19	3	2 $\frac{1}{2}$	$\frac{1}{4}, \frac{1}{2}$	$\frac{1}{2}$

Notes

- **Fifth Terminal:** For field-installed fifth terminal, order catalog number **K3356** for **U3278** and **U4216**. Order **K3866** for **U1207** and **U1211**.
- **Hubs:** For the proper hub selection, see the hub suffix chart on the accessory page.
- **Bypass:** Lever operates bypass device only — does not provide clamping action on meter spades.
- **Connectors:** Units are supplied with extruded aluminum connectors and bonded triplex neutral. For field installed insulated neutral in the **U7422** and **U7423** units, order kit number **K1047**.
- ***U3598-RL** is not a stock item.



Please consult serving utility for their requirements prior to ordering or installing, as specifications and approvals vary by utility, and may require local electrical inspector approval. All installations must be installed by a licensed electrician and must comply with all national and local codes, laws and regulations. Milbank reserves the right to make changes in specifications and features shown without notice or obligation.

Single Position Lever Bypass

200 Amp | 4 Terminal | Ringless | 600 VAC

13
200 AMP
SINGLE
POSITION



U4801-XL



U3924-XL



U4721-O-BL

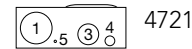
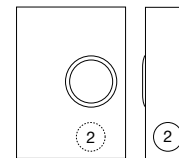
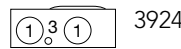
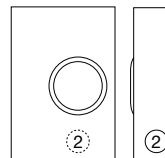
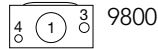
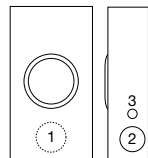
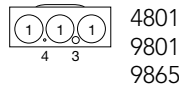
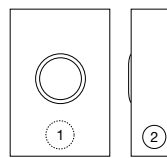

200 Amp | 4 Terminal | Single Position | Lever Bypass | Ringless

Catalog Number	Service	Hub	Line/Load Wire Range		Dimensions			Knockouts			
			CU	AL	D"	W"	H"	1	2	3	4
U9800-RRL**	OH	H.O.	#6-350	#6-350	4 ⁷ / ₈	10	18 ¹ / ₂	2	2	3/4	1/4, 1/2
U4801-XL*	OH/UG	C.P.	#6-350	#6-350	4 ⁷ / ₈	10	18 ¹ / ₂	2	2	3/4	1/4, 1/2
U9801-RXL**	OH/UG	C.P.	#6-350	#6-350	4 ⁷ / ₈	13	19	3	2 ¹ / ₂	1/4, 1/2	1/2
U9865-RRL	OH/UG	H.O.	3/8" x 16 Stud	3/8" x 16 Stud	4 ⁷ / ₈	13	19	3	2 ¹ / ₂	1/4, 1/2	1/2

200 Amp | 4 Terminal | Single Position | Side Wireway | Lever Bypass | Ringless

Catalog Number	Service	Hub	Line/Load Wire Range		Dimensions			Knockouts				
			CU	AL	D"	W"	H"	1	2	3	4	5
U3924-XL	OH/UG	C.P.	#6-350	#6-350	4 ⁷ / ₈	14	20 ¹ / ₂	3	2 ¹ / ₂	1/4, 1/2	—	—
U4721-O-BL	UG	Blank	#6-350	#6-350	5 ³ / ₄	16	22	4	3 ¹ / ₂	2 ¹ / ₂	1	1/4

Notes

- **Hubs:** For the proper hub selection, see the hub suffix chart on the accessory page.
*External hex connectors | **Internal hex connectors
- **Connectors:** Stud type units (**U9865**) supplied with 3/8"-16 hex head nuts with Belleville washers. For connector lug kits, order as extra from chart on page 76. Separate lug kits are required for line and load.
- **Bypass:** Lever supplies clamping action on meter spades and also operates bypass device.
- **Fifth Terminal:** For field installed fifth terminal, order **K3865** for **U3924**. Order **K3866** for **U4721**, **U4801**, **U9800**, **U9801** and **U9865**.

Please consult serving utility for their requirements prior to ordering or installing, as specifications and approvals vary by utility, and may require local electrical inspector approval. All installations must be installed by a licensed electrician and must comply with all national and local codes, laws and regulations. Milbank reserves the right to make changes in specifications and features shown without notice or obligation.



Single Position Lever Bypass

200 Amp | 5 Terminal | Ringless | 600 VAC



U4801-O-5T9

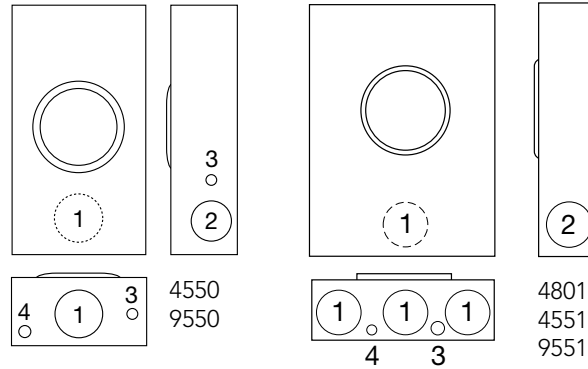

200 Amp | 5 Terminal | Single Position | Lever Bypass | Ringless

Catalog Number	Service	Hub	Line/Load Wire Range		Bypass	Dimensions			Knockouts			
			CU	AL		D"	W"	H"	1	2	3	4
U4801-XL-5T9*	OH/UG	C.P.	#6-350	#6-350	Lever	4 ⁷ / ₈	13	19	3	2 ¹ / ₂	³ / ₄	¹ / ₄ , ¹ / ₂
U4801-O-5T9*	OH/UG	Blank	#6-350	#6-350	Lever	4 ⁷ / ₈	13	19	3	2 ¹ / ₂	¹ / ₄ , ¹ / ₂	¹ / ₄
U4550-RL-5T9*	OH	H.O.	#6-350	#6-350	Lever	4 ⁷ / ₈	10	18 ¹ / ₂	3	2 ¹ / ₂	³ / ₄	¹ / ₄ , ¹ / ₂
U4551-RXL-5T9*	OH/UG	C.P.	#6-350	#6-350	Lever	4 ⁷ / ₈	13	19	3	2 ¹ / ₂	¹ / ₄ , ¹ / ₂	¹ / ₄
U9550-RRL	OH	H.O.	#6-350	#6-350	Lever	4 ⁷ / ₈	10	18 ¹ / ₂	3	2 ¹ / ₂	³ / ₄	¹ / ₄ , ¹ / ₂
U9551-RXL	OH/UG	C.P.	#6-350	#6-350	Lever	4 ⁷ / ₈	13	19	3	2 ¹ / ₂	¹ / ₄ , ¹ / ₂	¹ / ₄

Notes

- **Hubs:** For the proper hub selection, see the hub suffix chart on the accessory page.
- *External hex connectors
- **Bypass:** Lever supplies clamping action on meter spades and also operates bypass device.
- **Fifth Terminal:** Includes factory installed fifth terminal in 6 o'clock position. Unless **-5T9** is included in the part number, then the 5th terminal is located in the 9 O'clock position.
- **Insulated Neutral:** Neutral may be isolated in field by removing bonding strap per instructions on bonding strap tag.



Please consult serving utility for their requirements prior to ordering or installing, as specifications and approvals vary by utility, and may require local electrical inspector approval. All installations must be installed by a licensed electrician and must comply with all national and local codes, laws and regulations. Milbank reserves the right to make changes in specifications and features shown without notice or obligation.

Single Position Lever Bypass

200 Amp | 7 Terminal | Ringless | 600 VAC

15
200 AMP
SINGLE
POSITION
LEVER BYPASS



U4701-XL

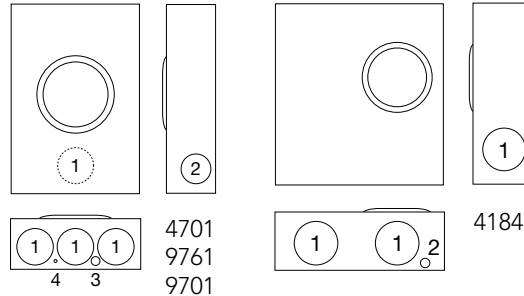

U9761-RRL

200 Amp | 7 Terminal | Single Position | Lever Bypass | Ringless | 3Ø4W

Catalog Number	Service	Hub	Line/Load Wire Range		Dimensions			Knockouts			
			CU	AL	D"	W"	H"	1	2	3	4
U4701-XL*	OH/UG	C.P.	#6-350	#6-350	4 ⁷ / ₈	13	19	3	2 ¹ / ₂	1 ¹ / ₄ , 1 ¹ / ₂	1 ¹ / ₄
U9701-RXL**	OH/UG	C.P.	#6-350	#6-350	4 ⁷ / ₈	13	19	3	2 ¹ / ₂	1 ¹ / ₄ , 1 ¹ / ₂	1 ¹ / ₄
U9761-RRL	OH/UG	H.O.	3 ⁸ / ₈ " x 16 Stud	3 ⁸ / ₈ " x 16 Stud	4 ⁷ / ₈	13	28 ¹ / ₄	3	2 ¹ / ₂	1 ¹ / ₄ , 1 ¹ / ₂	1 ¹ / ₄
U4184-X**	OH/UG	C.P.	#6-350	#6-350	6	18	19 ¹ / ₄	4	1 ¹ / ₄ , 1 ¹ / ₂	—	—

Notes

- **Hubs:** For the proper hub selection, see the hub suffix chart on the accessory page.
*External hex connectors | **Internal hex connectors
- **Connectors:** Units (excluding **U9761**) supplied with extruded aluminum connectors and bonded triplex neutral.
- **U9761** is supplied with 3⁸/₈"-16 hex head nuts with Belleville washers. For connector lug kits, order as extra from chart on page 76. Separate lug kits are required for line and load.
- **Bypass:** Lever supplies clamping action on meter spades and also operates bypass device.

Please consult serving utility for their requirements prior to ordering or installing, as specifications and approvals vary by utility, and may require local electrical inspector approval. All installations must be installed by a licensed electrician and must comply with all national and local codes, laws and regulations. Milbank reserves the right to make changes in specifications and features shown without notice or obligation.



Single Position Lever Bypass

320 Amp | 4 Terminal | Ringless | 600 VAC

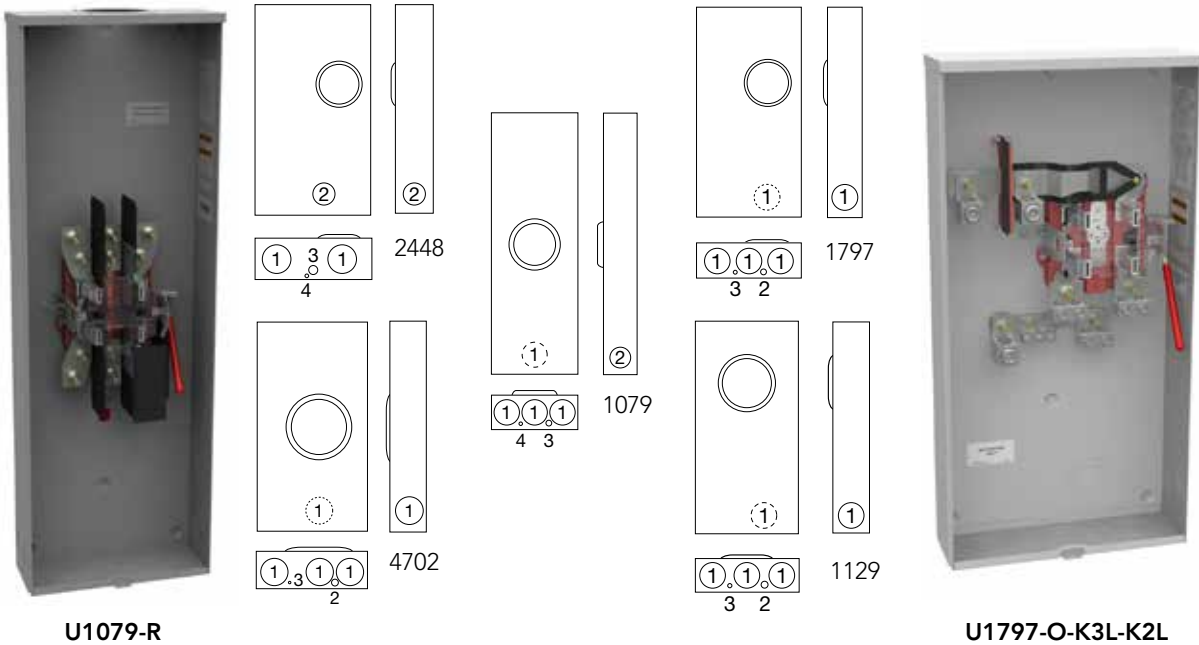

U1079-R

U1797-O-K3L-K2L

320 Amp | 4 Terminal | Single Position | Lever Bypass | Ringless

Catalog Number	Service	Hub	SW	Line/Load Wire Range		Dimensions			Knockouts			
				CU	AL	D"	W"	H"	1	2	3	4
U1079-R	OH	H.O.	N	3/8" x 16 Stud	3/8" x 16 Stud	4 7/8	13	38 3/4	3	2 1/2	1/4, 1/2	1/4
U4702-X	OH/UG	C.P.	Y	3/8" x 16 Stud	3/8" x 16 Stud	4 7/8	15	28 1/4	3	1/4, 1/2	1/4	—
U2448-X	OH/UG	C.P.	Y	3/8" x 16 Stud	3/8" x 16 Stud	6 1/2	17 3/4	34 1/8	4	3	1	1/4
U1129-O	UG	Blank	N	3/8" x 16 Stud	3/8" x 16 Stud	4 7/8	15	30	3	1/4, 1/2	1/4	—
U1797-O-K3L-K2L	UG	Blank	Y	(1) #4-600 or (2) 1/0-250	(2) #6-350	4 7/8	15	30	3	1/4, 1/2	1/4	—
U1797-O-STU-STU	UG	Blank	Y	3/8" x 16 Stud	3/8" x 16 Stud	4 7/8	15	30	3	1/4, 1/2	1/4	—

Notes

- **Hubs:** For the proper hub selection, refer to the hub suffix chart on the accessory page.
- **Fifth Terminal:** For field-installed fifth terminal, order catalog number **K3865** for **U2448**, **U1129**, and **U1797**. Order **K3866** for **U1079** and **U4702**.
- **Sideway Wire:** SW indicates side wireway models.
- **Anti-Inversion:** For field installed anti-inversion kit, order separately catalog number **K4802**.
- **Bypass:** The lever supplies clamping action on meter spades and also operates bypass device.



Please consult serving utility for their requirements prior to ordering or installing, as specifications and approvals vary by utility, and may require local electrical inspector approval. All installations must be installed by a licensed electrician and must comply with all national and local codes, laws and regulations. Milbank reserves the right to make changes in specifications and features shown without notice or obligation.

Single Position Lever Bypass

320 Amp | 5 Terminal | Ringless | 600 VAC

17
320 AMP
SINGLE
POSITION



U1079-R-5T9

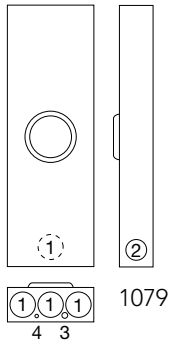

U3000-O-5T9-K3L-K2L

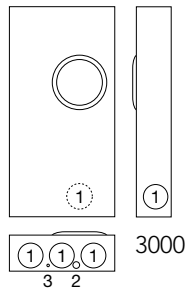

U1129-O-5T9

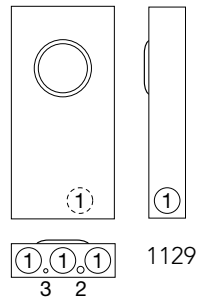

U2448-X-5T9

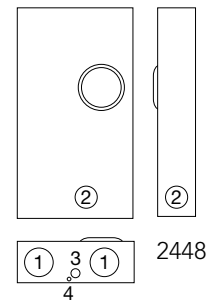

320 Amp | 5 Terminal | Single Position | Lever Bypass | Ringless

Catalog Number	Service	Hub	SW	Line/Load Wire Range		Dimensions			Knockouts			
				CU	AL	D"	W"	H"	1	2	3	4
U1079-R-5T9*	OH	H.O.	N	3/8" x 16 Stud	3/8" x 16 Stud	4 7/8"	13	38 3/4"	3	2 1/2"	1/4, 1/2"	1/4"
U2448-X-5T9*	OH/UG	C.P.	Y	3/8" x 16 Stud	3/8" x 16 Stud	6 1/2"	17 3/4"	34 1/8"	4	3"	1"	1/4"
U1129-O-5T9	UG	Blank	N	3/8" x 16 Stud	3/8" x 16 Stud	4 7/8"	15	30"	3	1/4, 1/2"	1/4"	—
U3000-O-K3L-K2L	UG	Blank	Y	#4-600 or (2) 1/0-250	(2) #6-350	4 7/8"	15	30"	3	1/4, 1/2"	1/4"	—

Notes

- **Hubs:** For proper hub selection, refer to the hub suffix chart on the accessory page.
- **Bypass:** The lever supplies clamping action on meter spades and also operates bypass device.
- **Sideway Wire:** SW indicates side wireway models.
- ***Connectors:** U1079 and U2448 are supplied with 3/8"-16 hex head nuts with Belleville washers. For connector lug kits, order as extra from chart on page 76. Separate lug kits are required for line and load.

Please consult serving utility for their requirements prior to ordering or installing, as specifications and approvals vary by utility, and may require local electrical inspector approval. All installations must be installed by a licensed electrician and must comply with all national and local codes, laws and regulations. Milbank reserves the right to make changes in specifications and features shown without notice or obligation.



Single Position Lever Bypass

320 Amp | 7 Terminal | Ringless | 600 VAC



U2120-O



U2594-X



U4911-X-BL

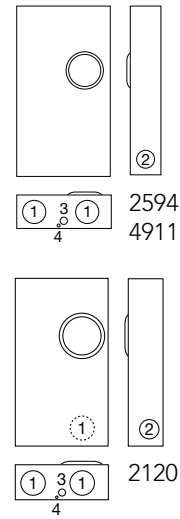

320 Amp | 7 Terminal | Single Position | Side Wireway | Lever Bypass | Ringless | 3Ø4W

Catalog Number	Service	Hub	Line/Load Wire Range		Dimensions			Knockouts			
			CU	AL	D"	W"	H"	1	2	3	4
U2594-X	OH/UG	C.P.	3/8" x 16 Stud	3/8" x 16 Stud	6 1/2	19	34 1/8	4	3	1	1/4
U4911-X-QG-BL	OH/UG	C.P.	3/8" x 16 Stud	3/8" x 16 Stud	6 1/2	17 3/4	38 3/8	4	3	1	1/4
U2120-O	UG	Blank	3/8" x 16 Stud	3/8" x 16 Stud	6 1/2	17 3/4	31 3/4	4	3	1	1/4

Notes

- **Hubs:** For the proper hub selection, refer to the hub suffix chart on the accessories page.
- **Bypass:** The lever supplies clamping action on meter spades and also operates bypass device.
- **Connectors:** Units supplied with 3/8" -16 hex head nuts with Belleville washers. For connector lug kits, order as extra from chart on page 76. Separate lug kits are required for line and load.



Please consult serving utility for their requirements prior to ordering or installing, as specifications and approvals vary by utility, and may require local electrical inspector approval. All installations must be installed by a licensed electrician and must comply with all national and local codes, laws and regulations. Milbank reserves the right to make changes in specifications and features shown without notice or obligation.

Meter Mains

100-200 Amp | 4 Terminal | Ringless | 240 VAC

19
100-200 AMP
METER MAINS



U3491-XL-200

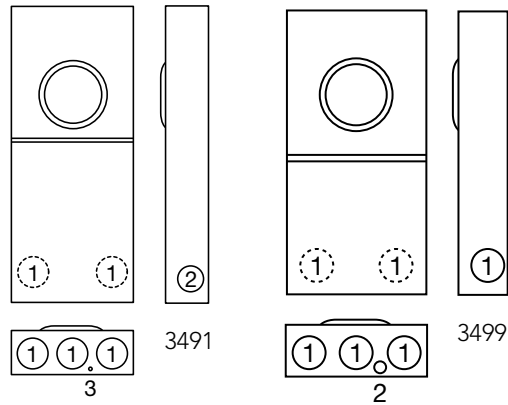

4 Terminal | Meter Main | Ringless

Catalog Number	Amp	Service	Hub	Breaker Compatibility	Line/Load Wire Range		Dimensions			Knockouts		
					CU	AL	D"	W"	H"	1	2	3
U3499-XL	100	OH/UG	H.O.	QP2100	#6-2/0	#14-1/0	3¾	11	22	2	¼, ½	—
U3491-XL-150	150	OH/UG	C.P.	UFQB-150-X1	#6-350	#1-300	4⅞	12	29	2½	2	¼
U3491-XL-200	200	OH/UG	C.P.	UFQB-200-X1	#1-300	#1-300	4⅞	12	29	2½	2	¼

Notes

- **Hubs:** For the proper hub selection, refer to the hub suffix chart on the accessory page.
- **Breakers:** Bolt-on circuit breakers are factory installed in the **U3491** series. The **U3499** do not come with breakers unless specified on order and require plug-in style.
- **Short Circuit Current Rating:** 10K AIC. However, this rating is limited to the lowest interrupting capacity of any circuit breaker installed. Watthour meter not included in short circuit current rating.

Please consult serving utility for their requirements prior to ordering or installing, as specifications and approvals vary by utility, and may require local electrical inspector approval. All installations must be installed by a licensed electrician and must comply with all national and local codes, laws and regulations. Milbank reserves the right to make changes in specifications and features shown without notice or obligation.





U5842-RL-200

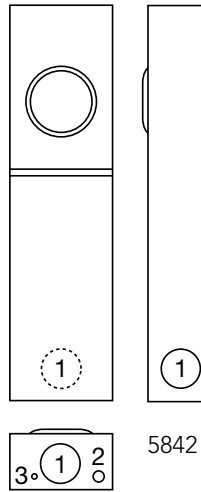

5842



U5844-PXL-200

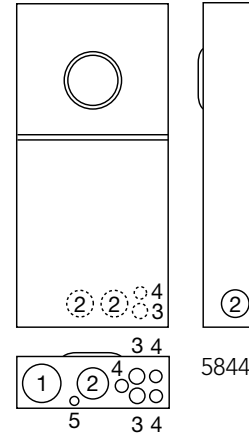

5844

200 Amp | 4 Terminal | Meter Mains | Ringless

Catalog Number	Service	Hub	Line/Load Wire Range		Bypass	Dimensions			Knockouts				
			CU	AL		D"	W"	H"	1	2	3	4	5
U5842-RL-200	OH	H.O.	#6-350	CB-200A	None	4½	8	30	2½	¼, ½	¼	—	—
U5844-PXL*	OH/UG	C.P.	#6-350	—	None	4½	14	30	3	2½	1	½, ¾	¼, ½

Notes

- **AIC Rating:** All models are rated 22K AIC when using Siemens **QPH** (100 amp) or **QNH** (200 amp) breakers.
- **Hub:** -PXL versions supplied with one (1) closing plate packed inside. Order other hubs separately.
- **Fifth Terminal:** For field-installable fifth terminal kit, order **K5T**.
- ***Breaker:** See breaker chart on page 73, 200 amp frame.



Please consult serving utility for their requirements prior to ordering or installing, as specifications and approvals vary by utility, and may require local electrical inspector approval. All installations must be installed by a licensed electrician and must comply with all national and local codes, laws and regulations. Milbank reserves the right to make changes in specifications and features shown without notice or obligation.

Meter Mains

100-200 Amp | 4 Terminal | Ringless | 240 VAC

21
100-200 AMP
METER
MAINS

Supplied with breakers



U9648-RL-100

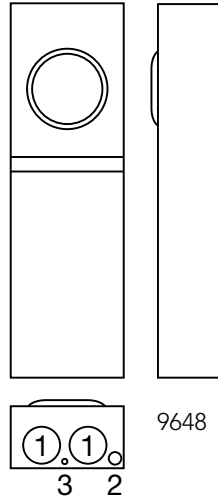

9648

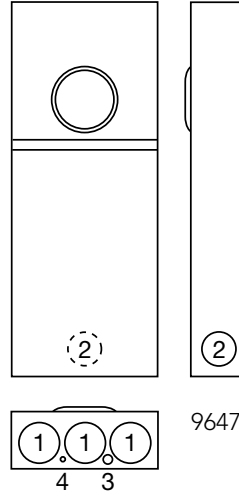

9647



U9647N-RL-200

4 Terminal | Meter Main | With Triple Tap Lugs & Load Side Distribution | Ringless

Catalog Number	Amp	Service	Hub	Line/Load Wire Range		Dimensions			Knockouts			
				CU	AL	D"	W"	H"	1	2	3	4
U9648-RL-100	100	OH/UG	H.O.	#6-350	#6-350	4 $\frac{1}{8}$	8	26	2	1/4, 1/2	1/4	—
U9647N-XL-100	100	OH/UG	C.P.	#6-350	#6-350	4 $\frac{7}{8}$	13	33	3	2 $\frac{1}{2}$	1/4, 1/2	1/4
U9647N-XL-200	200	OH/UG	C.P.	#6-350	#6-350	4 $\frac{7}{8}$	13	33	3	2 $\frac{1}{2}$	1/4, 1/2	1/4

Notes

- **Hubs:** For the proper hub selection, refer to the hub suffix chart on the accessory page.
- **Connectors:** Extruded aluminum connectors are tin plated with triplex on the load side.
- **Breakers:** Supplied with factory installed double pole circuit breakers of amperage shown.
- **Short Circuit Current Rating:** 10K AIC. However, this rating is limited to the lowest interrupting capacity of any circuit breaker installed. Watthour meter not included in short circuit current rating.

Please consult serving utility for their requirements prior to ordering or installing, as specifications and approvals vary by utility, and may require local electrical inspector approval. All installations must be installed by a licensed electrician and must comply with all national and local codes, laws and regulations. Milbank reserves the right to make changes in specifications and features shown without notice or obligation.



22

100-200 AMP
METER MAIN
WITH LOAD
CENTER

Meter Main With Load Center

100-200 Amp | 4 & 5 Terminal | Ringless | 240 VAC



U5168-XTL-200

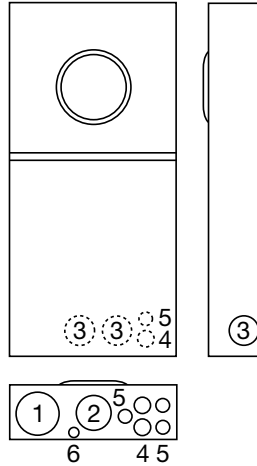

U5268-XTL-200-KK

100-200 Amp | 4 & 5 Terminal | Meter Mains | Overhead/Underground | Ringless

Catalog Number	Amp	Circuits	Hub	Connectors CU/AL -Line	Bypass	Dimensions			Knockouts					
						D"	W"	H"	1	2	3	4	5	6
U5168-XTL-100	100	10	C.P.	#6- 350	None	4½	14⅞	30	3	2½	2	1	½, ¾	¼, ½
U5168-XTL-150	150	8	C.P.	#6- 350	None	4½	14⅞	30	3	2½	2	1	½, ¾	¼, ½
U5168-XTL-200	200	8	C.P.	#6- 350	None	4½	14⅞	30	3	2½	2	1	½, ¾	¼, ½
U5168-XTL-100-KK	100	10	C.P.	#6- 350	Horn	4½	14⅞	30	3	2½	2	1	½, ¾	¼, ½
U5168-XTL-150-KK	150	8	C.P.	#6- 350	Horn	4½	14⅞	30	3	2½	2	1	½, ¾	¼, ½
U5168-XTL-200-KK	200	8	C.P.	#6- 350	Horn	4½	14⅞	30	3	2½	2	1	½, ¾	¼, ½
U5168-XTL-100-KK-5T	100	10	C.P.	#6- 350	Horn	4½	14⅞	30	3	2½	2	1	½, ¾	¼, ½
U5168-XTL-150-KK-5T	150	8	C.P.	#6- 350	Horn	4½	14⅞	30	3	2½	2	1	½, ¾	¼, ½
U5268-XTL-150	150	20	C.P.	#6- 350	None	4½	14⅞	30	3	2½	2	1	½, ¾	¼, ½
U5268-XTL-200	200	20	C.P.	#6- 350	None	4½	14⅞	30	3	2½	2	1	½, ¾	¼, ½
U5268-XTL-150-KK	150	20	C.P.	#6- 350	Horn	4½	14⅞	30	3	2½	2	1	½, ¾	¼, ½
U5268-XTL-200-KK	200	20	C.P.	#6- 350	Horn	4½	14⅞	30	3	2½	2	1	½, ¾	¼, ½

Notes

- **Hubs:** Supplied with two closing plates packed inside. Order hubs as a separate item. For proper hub selection, refer to the hub suffix chart on the accessories page.
- **Fifth Terminal:** For field installed fifth terminal, order **K5T**.
- **Breakers:** Rated 22K AIC with Milbank **QN2200RH** main installed.
- **Interlock Kit:** For generator auxiliary circuit breaker interlock, order **K5815** for large **QN** with small frame **Q**; order **K5820** for large frame **QN** with large frame **QN**; order **K5830** for small frame **Q** to small frame **Q**. See accessories on page 76.
- **Sub Feed Lugs:** #6-350 sub feed lugs provided on 8 circuit interior. **Not available on 20 circuit interior.**
- **-MLK:** For sub feed lug kit, add suffix **-MLK**.



Please consult serving utility for their requirements prior to ordering or installing, as specifications and approvals vary by utility, and may require local electrical inspector approval. All installations must be installed by a licensed electrician and must comply with all national and local codes, laws and regulations. Milbank reserves the right to make changes in specifications and features shown without notice or obligation.

Lever Bypass Meter Main

200 Amp | 5 Terminal | Lever Bypass | Ringless | 240 VAC

23
200 AMP
LEVER BYPASS
METER MAINS



U4834-XL-200-5T9
shown with optional
200 amp auxiliary breaker

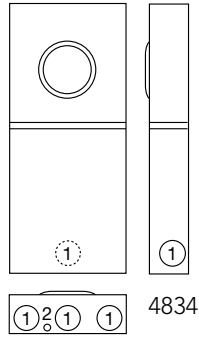

4834

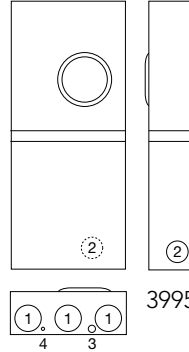

3995



U3995-XL-200-5T9

200 Amp | 5 Terminal | Meter Main with Auxiliary Breaker | Lever Bypass | Ringless

Catalog Number	Service	Hub	Line/Load Wire Range		Dimensions			Knockouts	
			CU	AL	D"	W"	H"	1	2
U4834-XL-200-5T9	OH/UG	C.P.	#6-350	#6-350	5½	17	39	3	¼, ½

Notes

- **Auxiliary Breakers:** Must be ordered separately. Use UQFP-(AMP) from breaker chart on page 74. Includes mechanical interlock so only one breaker is energized.

200 Amp | 5 Terminal | Meter Mains with Sub Panel | Lever Bypass | Ringless

Catalog Number	Service	Hub	Line/Load Wire Range		Dimensions			Knockouts			
			CU	AL	D"	W"	H"	1	2	3	4
U3995-XL-200-5T9	OH/UG	C.P.	#6-350	1/0-300	5¾	16	37	3	2½	¼, ½	¼

Notes

- **Breakers:** Refer to breaker chart on accessory page. Unit has provisions for (2) 2-pole branch breakers or (4) 1-pole branch breakers or a combination totaling 4 branch circuits. Socket main is furnished with branch circuits wired in series with main breaker. For parallel branch circuits add "P" to breaker main amperage (ex.: **U3995-XL-200P-5T9**). Total amperage on branch circuit cannot exceed 125 amps.
- **Hubs:** For proper hub selection, refer to the hub suffix chart on the accessories page.
- **Connectors:** Extruded aluminum connectors are tin plated.
- **Short Circuit Current Rating:** 10K AIC. However, this rating is limited to the lowest interrupting capacity of any circuit breaker installed. Watthour meter not included in short circuit current rating.

Please consult serving utility for their requirements prior to ordering or installing, as specifications and approvals vary by utility, and may require local electrical inspector approval. All installations must be installed by a licensed electrician and must comply with all national and local codes, laws and regulations. Milbank reserves the right to make changes in specifications and features shown without notice or obligation.



24

100-200 AMP
LEVER BYPASS
METER MAINS

Lever Bypass Meter Main

100-200 Amp | 4, 5 & 7 Terminal | Ringless | 240 VAC



U5750-RXL-200-BL

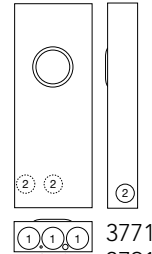
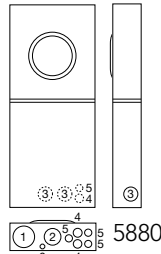
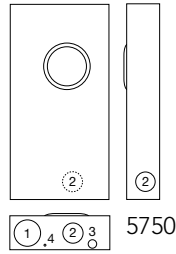

U3791N-RXL-200-5T9

100-200 Amp | 4 & 5 Terminal | Meter Main | Lever Bypass | Ringless | Overhead/Underground

Catalog Number	Terms	Amp	Hub	Line/Load Wire Range		Dimensions			Knockouts					
				CU	AL	D"	W"	H"	1	2	3	4	5	6
U5880-XL-200-5T9	4	200	C.P.	#6-350	#6-350	4½	14⅞	33½	3	2½	2	1	½, ¾	¼, ½
U3791N-RXL-(AMP)	4	100-200	C.P.	#6-350	Breaker*	4⅞	13	34	3	2½	¼, ½	¼	—	—
U3791N-RXL-(AMP)-5T9	5	100-200	C.P.	#6-350	Breaker*	4⅞	13	34	3	2½	¼, ½	¼	—	—

100-200 Amp | 7 Terminal | Meter Main with Breakers | Lever Bypass | Ringless

Catalog Number	Amp	Service	Hub	Line/Load Wire Range		Dimensions			Knockouts				
				CU	AL	D"	W"	H"	1	2	3	4	
U3771-XL-100	100	OH/UG	C.P.	#6-350	#1-300	4⅞	13	28	2½	2	¼, ½	¼	
U5750-RXL-200-BL	200	OH/UG	C.P.	#6-350	1/0-300	5¾	17⅞	34	4	3	¼, ½	¼	

Notes

- **Hubs:** For proper hub selection, refer to the hub suffix chart on the accessories page.
- **Bypass:** The lever supplies clamping action on meter spades and also operates bypass device.
- **Fifth Terminals:** For field installed fifth terminal on **U5880** and **U3791N**, order **K3865**. Units with **-5T9** suffix have fifth terminals factory installed in the 9 o'clock position.
- **Connectors:** Units supplied with ⅜"-16 hex head nuts with Belleville washers. For connector lug kits, order as extra from chart on page 76. Lug kit is required for line side only.
- **Breakers for U3791 Only:** For 100, 125, 150 or 200 amp breakers substitute desired amperage in suffix of catalog number, i.e. **U3791-RXL-(AMP)** becomes **U3791-RXL-200**. Not all units are stock.
- ***Breaker:** See breaker chart on pages 73 & 74, 200 amp frame.
- **Short Circuit Current Rating:** 10K AIC for **U3791N**, **U3771** and **U5750**. 22K for **U5880**. However, this rating is limited to the lowest interrupting capacity of any circuit breaker installed. Watthour meter not included in short circuit current rating.



Please consult serving utility for their requirements prior to ordering or installing, as specifications and approvals vary by utility, and may require local electrical inspector approval. All installations must be installed by a licensed electrician and must comply with all national and local codes, laws and regulations. Milbank reserves the right to make changes in specifications and features shown without notice or obligation.

Meter Main with Load Center

200 Amp | 5 Terminal | Ringless | Lever Bypass | 240 VAC

25
200 AMP
METER MAIN
WITH LOAD
CENTER



U6281-XL-200

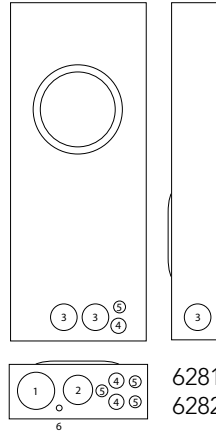

200 Amp | 5 Terminal | Meter Main with Breakers | Lever Bypass | Ringless

Catalog Number	Service	Circuits	Hub	Line/Load Wire Range		Dimensions			Knockouts					
				CU	AL	D"	W"	H"	1	2	3	4	5	6
U6281-XL-100 -5T9	OH/UG	10	C.P.	#6-350	CB	4½	14⅞	33½	3	2½	2	1	½, ¾	¼, ½
U6281-XL-150 -5T9	OH/UG	8	C.P.	#6-350	CB	4½	14⅞	33½	3	2½	2	1	½, ¾	¼, ½
U6281-XL-200 -5T9	OH/UG	8	C.P.	#6-350	CB	4½	14⅞	33½	3	2½	2	1	½, ¾	¼, ½
U6282-XL-200 -5T9	OH/UG	20	C.P.	#6-350	CB	4⅝	14⅞	34	3	2½	2	1	½, ¾	¼, ½

Notes

- **Breakers:** Rated 22K AIC with Milbank **QN2200RH** main installed.
- **Interlock Kit:** For generator auxiliary circuit breaker interlock, order **K5815** for large **QN** with small frame **Q**; order **K5820** for large frame **QN** with large frame **QN**; order **K5830** for small frame **Q** to small frame **Q**. See accessories on pages 73-74.
- **Sub Feed Lugs:** #6-350 sub feed lugs provided on 8 circuit interior. **Not available on 20 circuit interior.**
- **-MLK:** For sub feed lug kit, add suffix **-MLK**.

Please consult serving utility for their requirements prior to ordering or installing, as specifications and approvals vary by utility, and may require local electrical inspector approval. All installations must be installed by a licensed electrician and must comply with all national and local codes, laws and regulations. Milbank reserves the right to make changes in specifications and features shown without notice or obligation.



26

320 AMP
LEVER BYPASS
METER MAINS

Lever Bypass Meter Mains

320 Amp | 5 Terminal | Ringless | 240 VAC



U5059-X-2/200-K3L

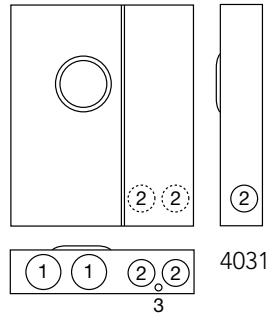
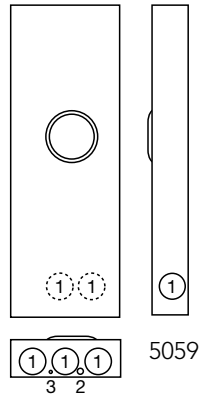

U4031-O-2/200-5T9

320 Amp | 5 Terminal | Meter Main with Breakers | Lever Bypass | Ringless

Catalog Number	Service	Hub	Line/Load Wire Range		Dimensions			Knockouts		
			CU	AL	D"	W"	H"	1	2	3
U4031-O-2/200-5T9	UG	Blank	3/8" x 16 Stud	1/0-300	5 3/4	25	30	4	3	1/4, 1/2
U5059-X-2/200-5T9	OH/UG	C.P.	3/8" x 16 Stud	#6-300	4 27/32	15	42 1/2	3	1/4, 1/2	1/4
U5059-X-5T9-K3L	OH/UG	C.P.	#4-600	#6-300	4 27/32	15	42 1/2	3	1/4, 1/2	1/4

Notes

- **Bypass:** Lever supplies clamping action on meter spades and also operates bypass device.
- **Connectors:** Units supplied with 3/8"-16 hex head nuts with Belleville washers. For connector lug kits, order as extra from chart on page 76. Lug kit is required for line side only.
- ***Breakers:** Order breakers **UQFPH** or **UQFP-100, 150** or **200** separately, see chart on page 74.
- **Short Circuit Current Rating:** 22K AIC. However, this rating is limited to the lowest interrupting capacity of any circuit breaker installed. Watthour meter not included in short circuit current rating.



Please consult serving utility for their requirements prior to ordering or installing, as specifications and approvals vary by utility, and may require local electrical inspector approval. All installations must be installed by a licensed electrician and must comply with all national and local codes, laws and regulations. Milbank reserves the right to make changes in specifications and features shown without notice or obligation.

Lever Bypass Meter Main

320 Amp | 4 Terminal | Ringless | 240 VAC

27
320 AMP
LEVER BYPASS
METER MAINS



U5890-X-2/200

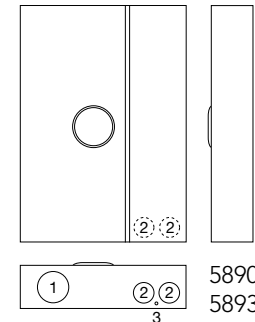

5890
5893

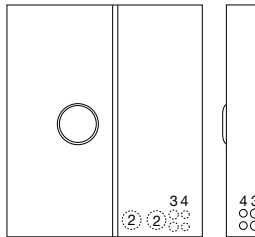

U5894-X-2/200

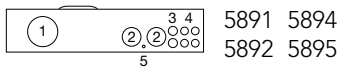

5891 5894
5892 5895

320 Amp | 4 Terminal | Meter Mains | Lever Bypass | Ringless

Catalog Number	Service	Hub	Connectors CU/AL	Branch Circuits	Dimensions			Knockouts				
			Line		D"	W"	H"	1	2	3	4	5
U5890-X-2/200	OH/UG	C.P.	#6-350	N/A	6	24½	35	4	2½	¼	—	—
U5891-X-2/200	OH/UG	C.P.	#6-350	12	6	29½	35	4	2½	1	½, ¾	¼
U5892-X-2/200	OH/UG	C.P.	#6-350	24	6	29½	35	4	2½	1	½, ¾	¼
U5893-X-2/200	OH/UG	C.P.	#6-350	N/A	6	24½	35	4	2½	¼	—	—
U5894-X-2/200	OH/UG	C.P.	#6-350	12	6	29½	35	4	2½	1	½, ¾	¼
U5895-X-2/200	OH/UG	C.P.	#6-350	24	6	29½	35	4	2½	1	½, ¾	¼

Notes

- **Hubs:** For proper hub selection refer to the hub suffix chart on the accessory page.
- **Breakers:** All units come with two 200 amp main breakers. For branch breakers, see chart on page 73.
- **Side Bussed Units: U5893, U5894 and U5895.**
- **-MLK:** Main Lug feed-through kit **K3701** factory installed.
- **Fifth Terminal:** For field mounted fifth terminal order catalog number **K3865**.
- **Short Circuit Current Rating:** 22K AIC. However, this rating is limited to the lowest interrupting capacity of any circuit breaker installed. Watthour meter not included in short circuit current rating.

Please consult serving utility for their requirements prior to ordering or installing, as specifications and approvals vary by utility, and may require local electrical inspector approval. All installations must be installed by a licensed electrician and must comply with all national and local codes, laws and regulations. Milbank reserves the right to make changes in specifications and features shown without notice or obligation.



Cold Sequence Meter Mains

200-320 Amp | 4, 5 & 7 Terminal | Ringless



U5767-X-200-CB



U5797-O-400-CB

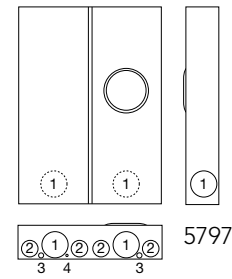
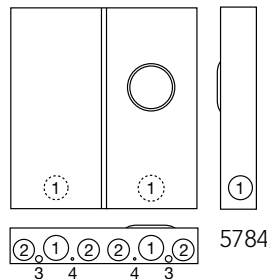
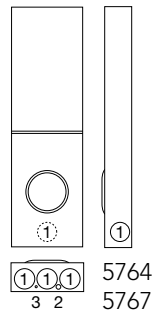
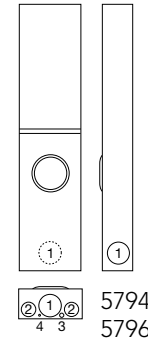

200 Amp Circuit Breaker Disconnect Ahead of Meter Socket | Lever Bypass

Catalog Number	Terminals	Service	Hub	Line/Load Wire Range		Dimensions			Knockouts			
				CU	AL	D"	W"	H"	1	2	3	4
U5764-X-200-CB	4	OH/UG	C.P.	1/0-350	#6-350	4 ^{27/32}	13	43	4	2½	¼	—
U5764-X-200-5T-CB	5	OH/UG	C.P.	1/0-350	#6-350	4 ^{27/32}	13	43	4	2½	¼	—
U5767-X-200-CB	7	OH/UG	C.P.	1/0-350	#6-350	4 ^{27/32}	13	43	4	2½	1	½, ¾
U5784-O-200-CB	5	UG	Blank	1/0-350	#6-350	4 ^{27/32}	26	28	3	2½	¼, ½	¼

320 Amp Continuous Circuit Breaker Disconnect Ahead of Meter Socket | Lever Bypass

Catalog Number	Terminals	Service	Hub	Connectors CU/AL	Dimensions			Knockouts			
				Line/Load	D"	W"	H"	1	2	3	4
U5794-X-400-CB	4	OH	C.P.	(2) 3/0-500	6	13	56	4	2½	¼, ½	¼
U5794-X-400-5T-CB	5	OH	C.P.	(2) 3/0-500	6	13	56	4	2½	¼, ½	¼
U5796-X-400-CB	7	OH	C.P.	(2) 3/0-500	6	13	56	4	2½	¼, ½	¼
U5797-O-400-CB	4	UG	Blank	(2) 3/0-500	6	26	56	4	2½	¼, ½	¼

Notes

- **Hubs:** For proper hub selection, refer to the hub suffix chart on the accessories page.
- **Voltage:** 200 amp circuit breaker units are rated 240 VAC at 65KAIC, 480 VAC at 35KAIC and 600 VAC at 22KAIC. 400 amp circuit breaker units are rated at 600 VAC at 10KAIC.



Please consult serving utility for their requirements prior to ordering or installing, as specifications and approvals vary by utility, and may require local electrical inspector approval. All installations must be installed by a licensed electrician and must comply with all national and local codes, laws and regulations. Milbank reserves the right to make changes in specifications and features shown without notice or obligation.

Multi-Position Sockets

100 Amp | 4 Terminals | Ringless | 300 VAC

29
100 AMP
MULTI-
POSITION

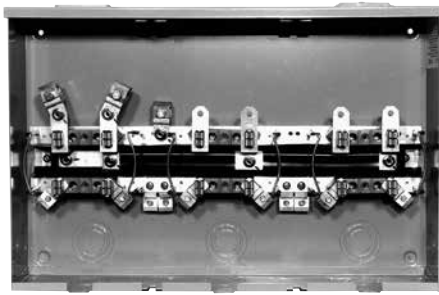

U7363-XL

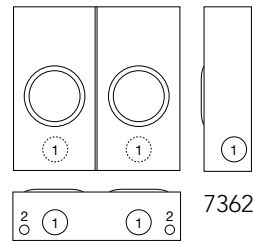

7362

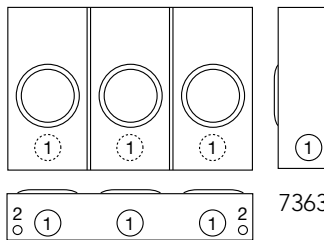

7363

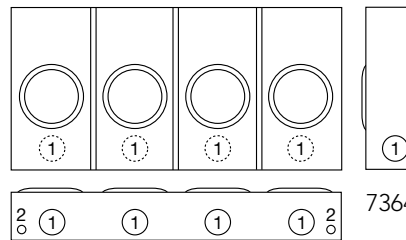

7364

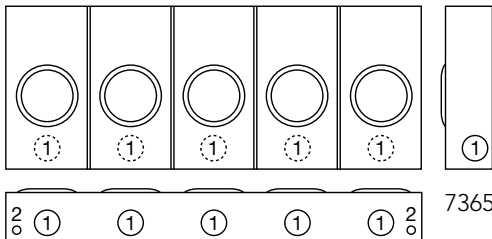

7365

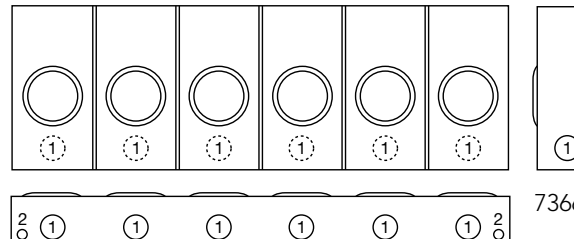

7366

100 Amp per Position | 4 Terminal | Multi-Position | Ringless

Catalog Number	Positions	Service	Hub	Connectors CU/AL		Dimensions			Knockouts	
				Line	Load	D"	W"	H"	1	2
U7362-XL	2	OH	C.P.	#6-350	#6-2/0	4½	16⅝	16	2½	¼, ½
U7363-XL	3	OH	C.P.	#6-350	#6-2/0	4½	24½	16	2½	¼, ½
U7364-XL	4	OH	C.P.	#6-350	#6-2/0	4½	32⅞	16	2½	¼, ½
U7365-XL	5	OH	C.P.	#6-350	#6-2/0	4½	40⅞	16	2½	¼, ½
U7366-XL	6	OH	C.P.	#6-350	#6-2/0	4½	49⅞	16	2½	¼, ½

Notes

- **Hub:** For proper hub selection refer to the hub suffix chart on the accessory page. A hub opening is supplied at each end and the extra opening is closed with a closing plate as standard.
- **Fifth Terminal Kit:** For field mounted fifth terminal, order **5T8K2** for 6 o'clock and **K9959** for 9 o'clock position.
- **Connectors:** Extruded aluminum connectors are tin plated.
- **Bypass:** Horn type bypass is available. Add suffix **-KK** to catalog number.

Please consult serving utility for their requirements prior to ordering or installing, as specifications and approvals vary by utility, and may require local electrical inspector approval. All installations must be installed by a licensed electrician and must comply with all national and local codes, laws and regulations. Milbank reserves the right to make changes in specifications and features shown without notice or obligation.



Multi-Position Sockets

100 Amp | 4 Terminal | Ringless | 300 VAC



U8212-XL

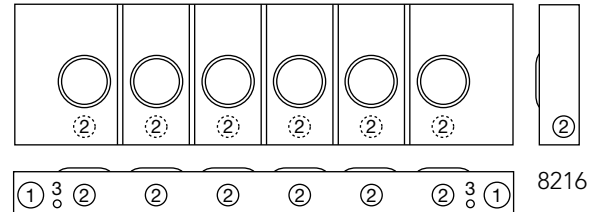
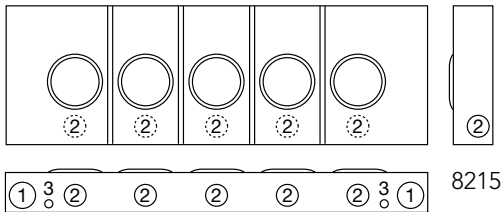
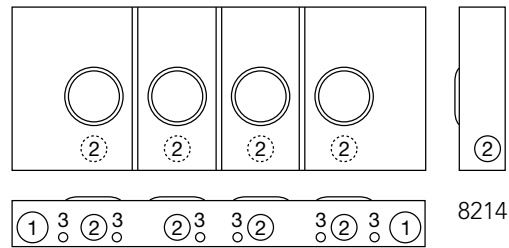
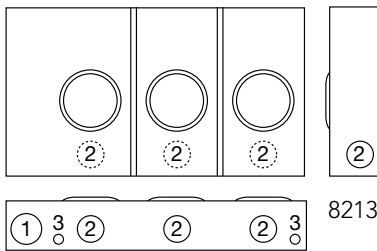
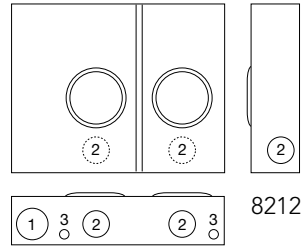

100 Amp per Position | 4 Terminal | Multi-Position | End Wireway | Ringless

Catalog Number	Positions	Service	Hub	Connectors CU/AL		Dimensions			Knockouts		
				Line	Load	D"	W"	H"	1	2	3
U8212-XL	2	OH/UG	H.O.	#6-350	#6-2/0	4½	20⅝	16	2½	2	¼, ½
U8213-XL	3	OH/UG	H.O.	#6-350	#6-2/0	4½	28⅝	16	2½	2	¼, ½
U8214-XL	4	OH/UG	H.O.	#6-350	#6-2/0	4½	40⅝	16	2½	2	¼, ½
U8215-XL	5	OH/UG	H.O.	#6-350	#6-2/0	4½	48⅝	16	2½	2	¼, ½
U8216-XL	6	OH/UG	H.O.	#6-350	#6-2/0	4½	57⅝	16	2½	2	¼, ½

Notes

- **Hub:** For proper hub selection refer to the hub suffix chart on the accessory page. A hub opening is supplied at each end and the extra opening is closed with a closing plate as standard.
- **Fifth Terminal Kit:** For field mounted fifth terminal, order **5T8K2** for 6 o'clock and **K9959** for 9 o'clock position.
- **Connectors:** Extruded aluminum connectors are tin plated.
- **Bypass:** Horn type bypass is available. Add suffix **-KK** to catalog number.



Please consult serving utility for their requirements prior to ordering or installing, as specifications and approvals vary by utility, and may require local electrical inspector approval. All installations must be installed by a licensed electrician and must comply with all national and local codes, laws and regulations. Milbank reserves the right to make changes in specifications and features shown without notice or obligation.

Multi-Position Sockets

100 Amp | 4 Terminal | Ringless | 300 VAC

31
100 AMP
MULTI-
POSITION

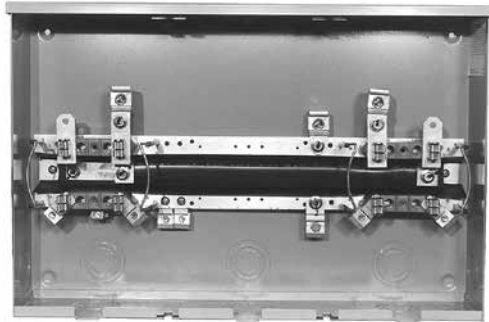

U8032-RL

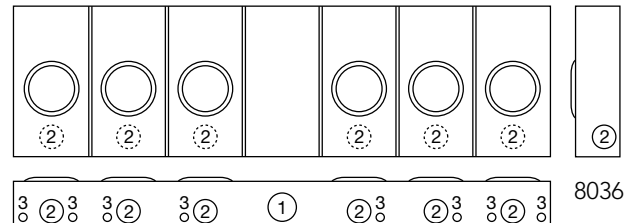
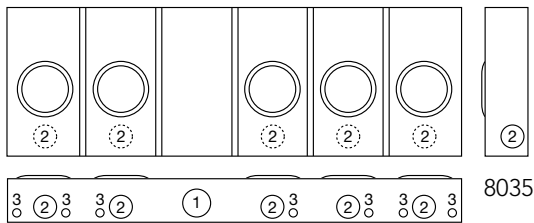
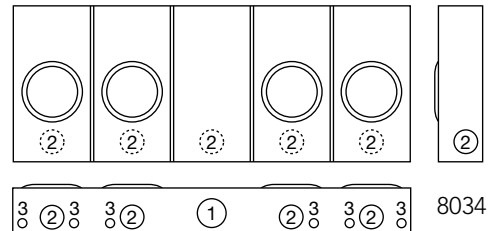
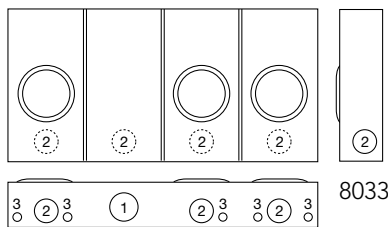
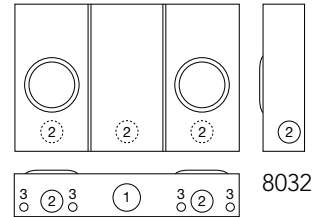

100 Amp per Position | 4 Terminal | Multi-Position | Center Wireway | Ringless

Catalog Number	Positions	Service	Hub	Connectors CU/AL		Dimensions			Knockouts		
				Line	Load	D"	W"	H"	1	2	3
U8032-RL	2	OH/UG	H.O.	#6-350	#6-2/0	4½	24½	16	2½	2	½
U8033-RL	3	OH/UG	H.O.	#6-350	#6-2/0	4½	32¼ ₆	16	3	2½	1
U8034-RL	4	OH/UG	H.O.	#6-350	#6-2/0	4½	40 ₈	16	3	2½	1
U8035-RL	5	OH/UG	H.O.	#6-350	#6-2/0	4½	49¼ ₁₆	16	3	2½	1
U8036-RL	6	OH/UG	H.O.	#6-350	#6-2/0	4½	57¼	16	3	2½	1

Notes

- **Hubs:** For proper hub selection, refer to the hub suffix chart on the accessories page.
- **Fifth Terminal:** For field mounted fifth terminal, order catalog number **5T8K2**. Installs in 6 o'clock position only.
- **Connectors:** Extruded aluminum connectors are tin plated.
- **Bypass:** Horn bypass is available. Add suffix **-KK** to catalog number.

Please consult serving utility for their requirements prior to ordering or installing, as specifications and approvals vary by utility, and may require local electrical inspector approval. All installations must be installed by a licensed electrician and must comply with all national and local codes, laws and regulations. Milbank reserves the right to make changes in specifications and features shown without notice or obligation.



Multi-Position Sockets

200 Amp | 4 Terminal | Ringless | 300 VAC



U1254-X

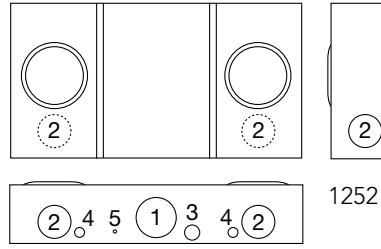

1252

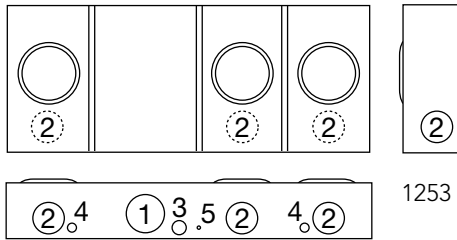

1253

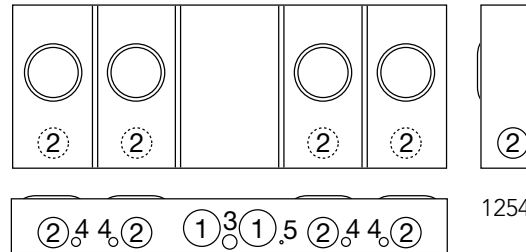

1254

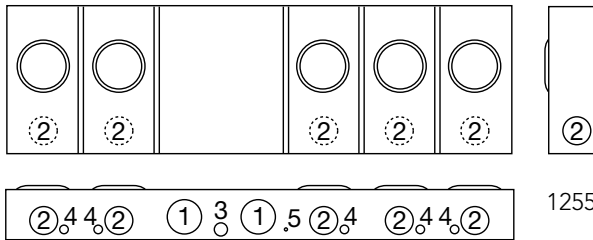

1255

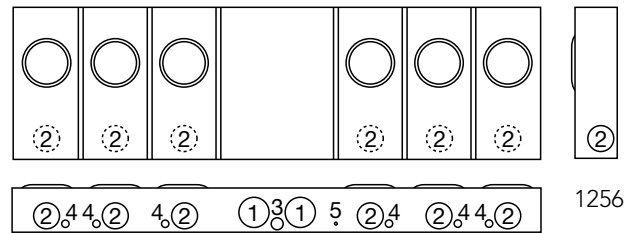

1256

200 Amp per Position | 4 Terminal | Multi-Position | Center Wireway | Ringless

Catalog Number	Positions	Service	Hub	Connectors CU/AL		Dimensions			Knockouts				
				Line	Load	D"	W"	H"	1	2	3	4	5
U1252-X	2	OH/UG	C.P.	3/8" x 16 Stud	#6-350	5 1/8	26 1/2	14	3	2 1/2	1	1/2	1/4
U1253-X	3	OH/UG	C.P.	3/8" x 16 Stud	#6-350	5 1/8	34 1/2	14	3	2 1/2	1	1/2	1/4
U1254-X	4	OH/UG	C.P.	3/8" x 16 Stud	#6-350	5 1/8	42 1/16	16	3	2 1/2	1	1/2	1/4
U1255-X	5	OH/UG	C.P.	3/8" x 16 Stud	#6-350	5 1/8	54 1/16	16	3	2 1/2	1	1/2	1/4
U1256-X	6	OH/UG	C.P.	3/8" x 16 Stud	#6-350	5 1/8	62 7/8	18	3	2 1/2	1	1/2	1/4

Notes

- **Hubs:** For proper hub selection, refer to the hub suffix chart on the accessories page. For the **U1254-6** two hub openings are supplied and the extra opening is closed with a closing plate as standard.
- **Fifth Terminal:** For field mounted fifth terminal, order catalog number **K5T** (9 o'clock position).
- **Connectors:** Extruded aluminum connectors are tin plated. For line side connector lug kits, order as extra from chart on page 76.
- **Bypass:** Horn bypass is available. Add suffix **-KK** to catalog number.



Please consult serving utility for their requirements prior to ordering or installing, as specifications and approvals vary by utility, and may require local electrical inspector approval. All installations must be installed by a licensed electrician and must comply with all national and local codes, laws and regulations. Milbank reserves the right to make changes in specifications and features shown without notice or obligation.

Lever Bypass Multi-Position Sockets

200 Amp | 5 Terminal | Ringless | 600 VAC

33
200 AMP
MULTI-
POSITION



U2873-Xt-5T9

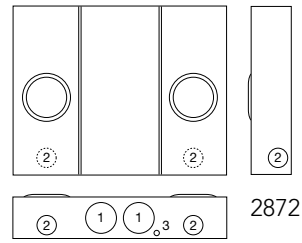

2872

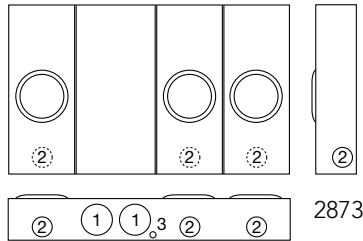

2873

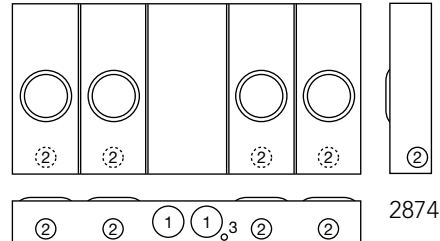

2874

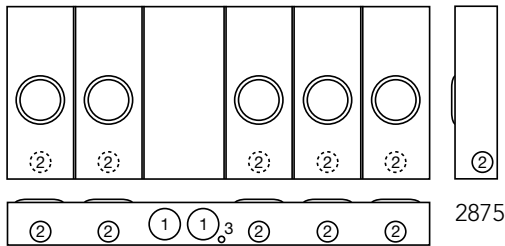

2875

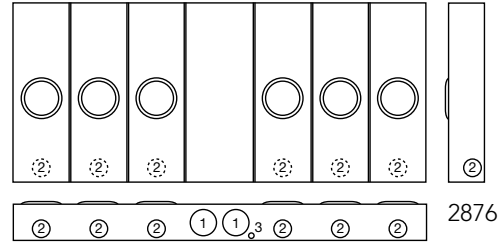

2876

200 Amp per Position | 5 Terminal | Multi-Position | Center Wireway | Ringless

Catalog Number	Positions	Service	Hub	Connectors CU/AL		Dimensions			Knockouts		
				Line	Load	D"	W"	H"	1	2	3
U2872-Xt-5T9	2	OH/UG	(2) C.P.	3/8" x 16 Stud	#6-350	6	32 1/8	25 1/4	4	2 1/2	1/4, 1/2
U2873-Xt-5T9	3	OH/UG	(2) C.P.	3/8" x 16 Stud	#6-350	6	42 3/16	25 1/4	4	2 1/2	1/4, 1/2
U2874-Xt-5T9	4	OH/UG	(2) C.P.	3/8" x 16 Stud	#6-350	6	52 1/4	25 1/4	4	2 1/2	1/4, 1/2
U2875-Xt-5T9	5	OH/UG	(2) C.P.	3/8" x 16 Stud	#6-350	6	62 3/16	25 1/4	4	2 1/2	1/4, 1/2
U2876-Xt-5T9	6	OH/UG	(2) C.P.	3/8" x 16 Stud	#6-350	6	72 3/8	31 1/4	4	2 1/2	1/4, 1/2

Notes

- **Hubs:** Units supplied with two closing plates. To order hubs as extra, refer to the hub suffix chart on the accessories page.
- **Connector Kits:** For line side connector kits, order as extra **K1539** (350 kcmil), **K1540** (600 kcmil), twin **K1350** (350 kcmil), twin **K1541** (600 kcmil). Line connectors can be reversed to change from "OH" to "UG" service. For line side connector lug kits, order as extra from chart on page 76.
- **Bypass:** Lever supplies clamping action on meter spades and also operates bypass device.

Please consult serving utility for their requirements prior to ordering or installing, as specifications and approvals vary by utility, and may require local electrical inspector approval. All installations must be installed by a licensed electrician and must comply with all national and local codes, laws and regulations. Milbank reserves the right to make changes in specifications and features shown without notice or obligation.



Lever Bypass Multi-Position Sockets

200 Amp | 7 Terminal | Ringless | 600 VAC



U2732-XT

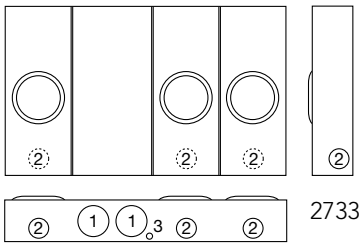
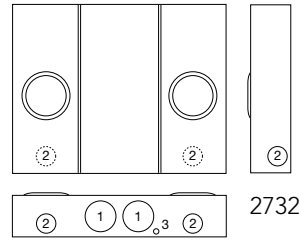

2733

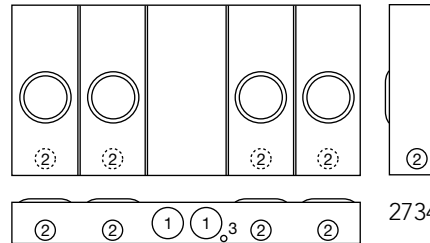

2734

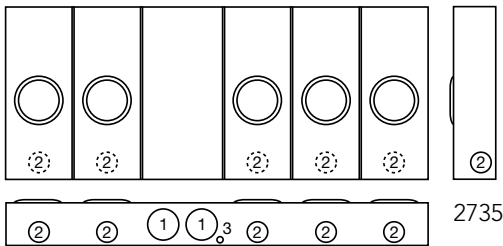

2735

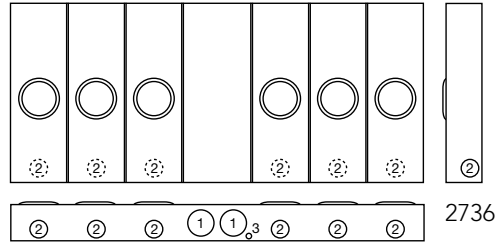

2736

200 Amp per Position | 7 Terminal | Multi-Position | Center Wireway | Ringless

Catalog Number	Positions	Service	Hub	Connectors CU/AL		Dimensions			Knockouts			
				Line	Load	D"	W"	H"	1	2	3	4
U2732-XT	2	OH/UG	(2) C.P.	3/8" x 16 Stud	#6-350	6	32 1/8	25 1/4	4	2 1/2	1/4, 1/2	1/4
U2733-XT	3	OH/UG	(2) C.P.	3/8" x 16 Stud	#6-350	6	42 3/16	25 1/4	4	2 1/2	1/4, 1/2	1/4
U2734-XT	4	OH/UG	(2) C.P.	3/8" x 16 Stud	#6-350	6	52 1/4	25 1/4	4	2 1/2	1/4, 1/2	1/4
U2735-XT	5	OH/UG	(2) C.P.	3/8" x 16 Stud	#6-350	6	62 5/16	25 1/4	4	2 1/2	1/4, 1/2	1/4
U2736-XT	6	OH/UG	(2) C.P.	3/8" x 16 Stud	#6-350	6	72 3/8	31 1/4	4	2 1/2	1/4, 1/2	1/4

Notes

- **Hubs:** Units supplied with two closing plates. To order hubs as extra, refer to the hub suffix chart on the accessories page.
- **Connector Kits:** For line side connector kits, order as extra **K3082** (350 kcmil), **K3441** (600 kcmil), twin **K3442** (350 kcmil), twin **K3083** (600 kcmil). Line connectors can be reversed to change from "OH" to "UG" service.
- **Bypass:** Lever supplies clamping action on meter spades and also operates bypass device.



Please consult serving utility for their requirements prior to ordering or installing, as specifications and approvals vary by utility, and may require local electrical inspector approval. All installations must be installed by a licensed electrician and must comply with all national and local codes, laws and regulations. Milbank reserves the right to make changes in specifications and features shown without notice or obligation.

Multi-Position Sockets

125 & 200 Amp per Position | 4 Terminal | 120/240 VAC

35
125 & 200 AMP
MULTI-
POSITION
SOCKETS



U2854-X-4/125

(Order circuit breakers as extra)



U2866-X

125 Amp per Position | Multi-Position Sockets | Ringless

Catalog Number	Amp	Positions	Main Bus Rating	Line Connector Size	Dimensions		
					D"	W"	H"
U2852-X	125	2	200 Amp	3/8" x 16 Stud*	5 13/16	18	25
U2853-X	125	3	200 Amp	3/8" x 16 Stud*	5 13/16	18	37
U2854-X	125	4	400 Amp	3/8" x 16 Stud*	4 7/8	31	25
U2855-X	125	5	400 Amp	3/8" x 16 Stud*	4 7/8	31	37
U2856-X	125	6	400 Amp	3/8" x 16 Stud*	4 7/8	31	37

200 Amp per Position | Multi-Position Sockets | Ringless

Catalog Number	Amp	Positions	Main Bus Rating	Line Connector Size	Dimensions		
					D"	W"	H"
U2862-X	200	2	250 Amp	3/8" x 16 Stud*	5 13/16	21	29
U2863-X	200	3	300 Amp	3/8" x 16 Stud*	5 13/16	21	41
U2864-X	200	4	400 Amp	3/8" x 16 Stud*	4 7/8	36	29
U2865-X	200	5	600 Amp	3/8" x 16 Stud*	4 7/8	36	41
U2866-X	200	6	600 Amp	3/8" x 16 Stud*	4 7/8	36	41

Connector Kits*

Size	Suffix	Kit Number	Compatible With	Wire Range
Single	-K1	K1539	U2852-56, U2862-66	#6-350
	-K3	K1540	U2854-56, U2864-66	#4-600
Twin	-K2	K1350	U2854-56, U2863-66	#6-350
	-K4	K1541	U2864-66	#2-600

Breaker Chart

Manufacturer	125-200 Amp	125 amps or less
Cutler Hammer	BR, BJ	Quicklag P, BR, HQP
Siemens	QNR	QP
Siemens/Murray	MD	MP
G.E.	Q Line	Q Line
Square D	—	Homeline

Notes

- **Connectors:** For line wire connector kits, order separately.
- **Fifth Terminal:** For field mounted fifth terminal, order catalog number **K2381**. Order one per meter position.
- **Breakers:** Units have provision for one double pole main per meter position. Breakers not included.
- **Short Circuit Current Rating:** 10K AIC. However, this rating is limited to the lowest interrupting capacity of any circuit breaker installed. Watthour meter not included in short circuit current rating.
- **Knockouts:** See next page for drawings and knockout configurations.

Please consult serving utility for their requirements prior to ordering or installing, as specifications and approvals vary by utility, and may require local electrical inspector approval. All installations must be installed by a licensed electrician and must comply with all national and local codes, laws and regulations. Milbank reserves the right to make changes in specifications and features shown without notice or obligation.



Catalog Number	Knockouts		
	1	2	3
U2852-X	3	1¼	¼, ½
U2853-X	3	1¼	¼, ½
U2854-X	3	1¼	¼, ½
U2855-X	3	1¼	¼, ½
U2856-X	3	1¼	¼, ½
U2862-X	3	2	¼, ½
U2863-X	3	2	¼, ½
U2864-X	3	2	¼, ½
U2865-X	3	2	¼, ½
U2866-X	3	2	¼, ½

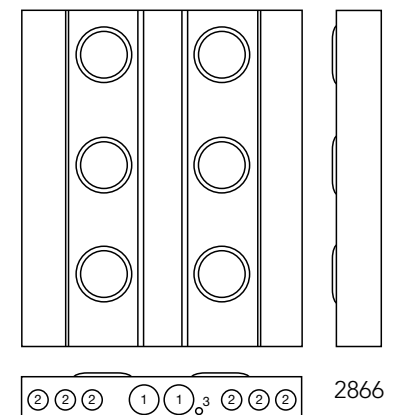
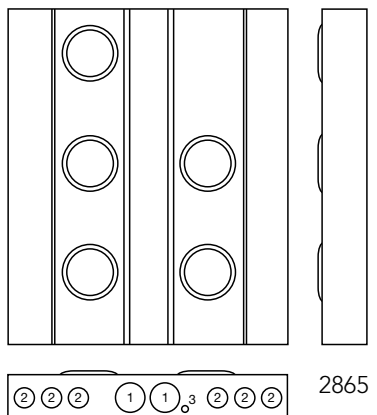
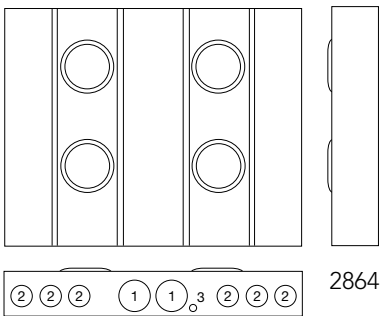
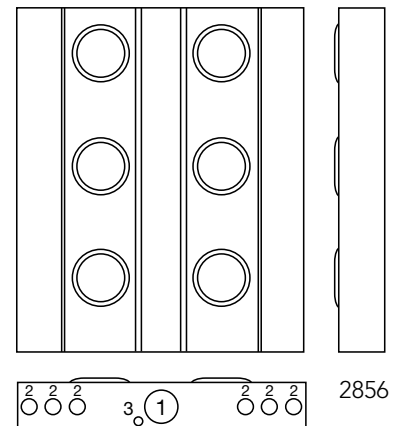
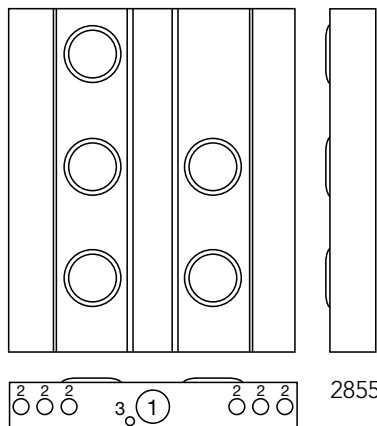
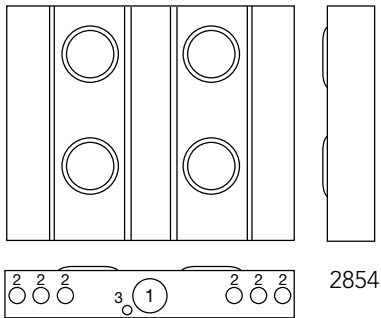
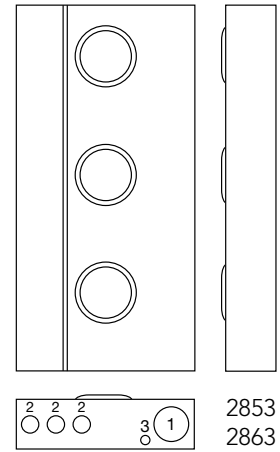
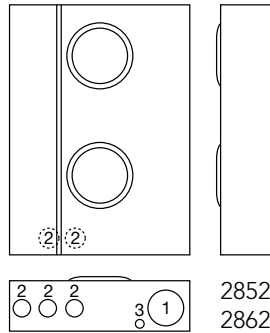

Please consult serving utility for their requirements prior to ordering or installing, as specifications and approvals vary by utility, and may require local electrical inspector approval. All installations must be installed by a licensed electrician and must comply with all national and local codes, laws and regulations. Milbank reserves the right to make changes in specifications and features shown without notice or obligation.

Multi-Position Meter Mains

125 & 200 Amp | 4 Terminal | Ringless | 120/240 VAC

37
125 & 200 AMP
MULTI-
POSITION
METER MAINS



U5882-X



U5884-X

Breaker Chart

Manufacturer	125-200 Amp	125 Amp or less
Cutler Hammer	BR, BJ	Quicklag P, BR, HQP
Siemens	QNR	QP
Siemens/Murray	MD	MP
G.E.	Q Line	Q Line
Square D	—	Homeline

125 Amp per Position | 4 Terminal | Multi-Position Meter Main | Ringless

Catalog Number	Amp	Positions	Service	Hub	Connectors CU/AL	Dimensions			Weight (lbs.)
					Line	D"	W"	H"	
U5902-X	125	2	OH/UG	C.P.	3/8" x 16 Stud	5 1/8"	26 1/2"	30"	58
U5903-X	125	3	OH/UG	C.P.	3/8" x 16 Stud	5 1/8"	34 5/8"	30"	88
U5904-X	125	4	OH/UG	C.P.	3/8" x 16 Stud	5 1/8"	42 5/8"	30"	107
U5905-X	125	5	OH/UG	C.P.	3/8" x 16 Stud	5 1/8"	51 1/20"	30"	128
U5906-X	125	6	OH/UG	C.P.	3/8" x 16 Stud	5 1/8"	59 3/10"	30"	146

200 Amp per Position | 4 Terminal | Multi-Position Meter Main | Ringless

Catalog Number	Amp	Positions	Service	Hub	Connectors CU/AL	Dimensions			Weight (lbs.)
					Line	D"	W"	H"	
U5882-X	200	2	OH/UG	C.P.	3/8" x 16 Stud	5 1/8"	26 1/2"	30"	58
U5883-X	200	3	OH/UG	C.P.	3/8" x 16 Stud	5 1/8"	34 5/8"	30"	88
U5884-X	200	4	OH/UG	C.P.	3/8" x 16 Stud	5 1/8"	42 5/8"	30"	107
U5885-X	200	5	OH/UG	C.P.	3/8" x 16 Stud	5 1/8"	51 1/20"	30"	128
U5886-X	200	6	OH/UG	C.P.	3/8" x 16 Stud	5 1/8"	59 3/10"	30"	146

Notes

- **Knockouts:** See drawings on the next page.
- **Optional:** Factory installed breakers are available - consult factory.
- **AIC Rating:** All models are rated 22K AIC. However, this rating is limited to the lowest interrupting capacity of any circuit breaker installed. Watthour meter not included in short circuit current rating.
- **Hub:** Units supplied with one (1) closing plate. Order hubs separately, see accessory page.
- **Fifth Terminal:** For field installed fifth terminal, order **K5T**.
- **Connectors:** Socket is supplied with 3/8" - 16 hex head nuts with Belleville washers. For connector lug kits, order as extra from chart on page 76. Separate lug kits are required for line and load.

Please consult serving utility for their requirements prior to ordering or installing, as specifications and approvals vary by utility, and may require local electrical inspector approval. All installations must be installed by a licensed electrician and must comply with all national and local codes, laws and regulations. Milbank reserves the right to make changes in specifications and features shown without notice or obligation.



Multi-Position Meter Mains

Dimensional Information

Knockouts				
1	2	3	4	5
3	2½	1	⅞	¼

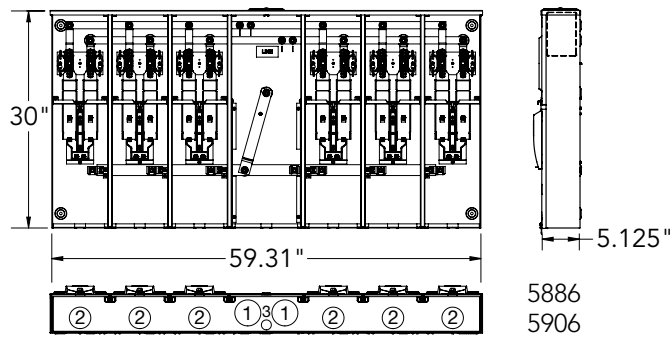
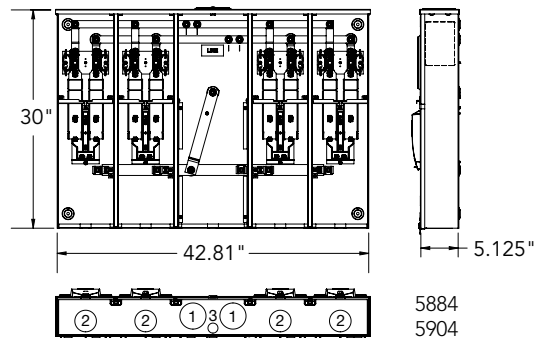
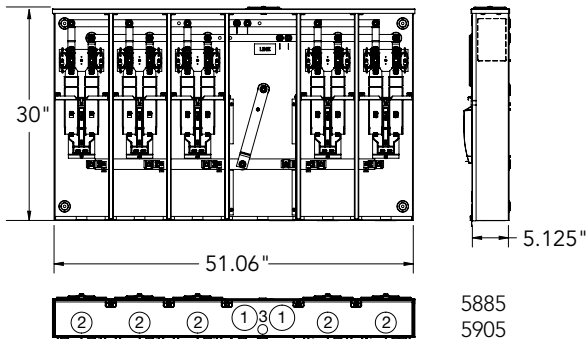
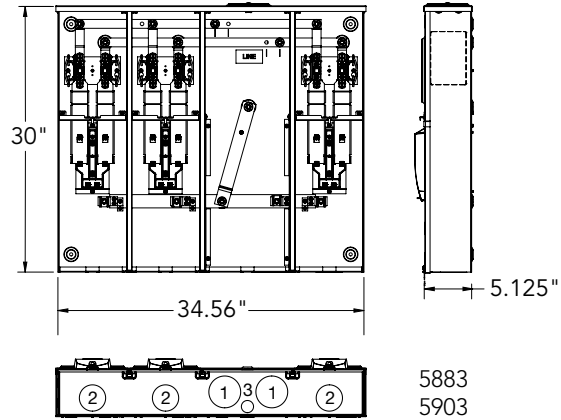
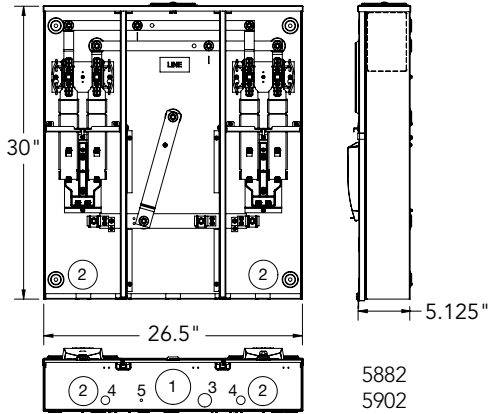

Please consult serving utility for their requirements prior to ordering or installing, as specifications and approvals vary by utility, and may require local electrical inspector approval. All installations must be installed by a licensed electrician and must comply with all national and local codes, laws and regulations. Milbank reserves the right to make changes in specifications and features shown without notice or obligation.

Lever Bypass Multi-Position Sockets

200 Amp per Position | 5 Terminal | Ringless | 120/240 VAC

39
200 AMP
LEVER BYPASS
MULTI-
POSITION



U4374-Xt-5T9

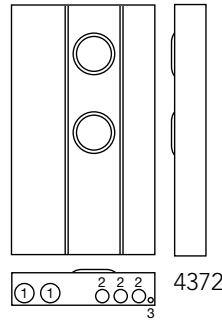

4372

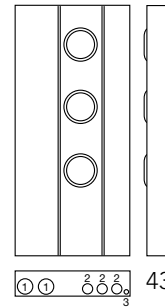

4373

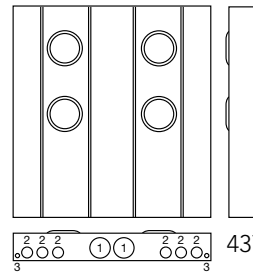

4374

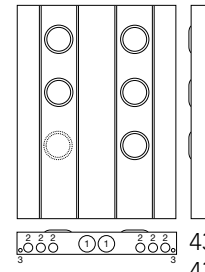

4375
4376

200 Amp per Position | 5 Terminal | Lever Bypass Multi-Position Sockets | Ringless

Catalog Number	Positions	Main Bus Rating	Line Connector Size	Dimensions			Knockouts		
				D"	W"	H"	1	2	3
U4372-Xt-5T9	2	320 amp	3/8" x 16 Stud*	6	27 3/4	48	3	2	1/4, 1/2
U4373-Xt-5T9	3	480 amp	3/8" x 16 Stud*	6	27 3/4	60	3	2	1/4, 1/2
U4374-Xt-5T9	4	640 amp	3/8" x 16 Stud*	6	45	48	4	2	1/4, 1/2
U4375-Xt-5T9	5	640 amp	3/8" x 16 Stud*	6	45	60	4	2	1/4, 1/2
U4376-Xt-5T9	6	640 amp	3/8" x 16 Stud*	6	45	60	4	2	1/4, 1/2

Connector Kits*

Size	Suffix	Kit Number	Wire Range
Single	-K3	K1540	#4-600
Twin	-K2	K1350	#6-350
	-K4	K1541	#2-600

Breaker Chart

Manufacturer	125-200 amps	125 amps or less
Cutler Hammer	BR, BJ	Quicklag P, BR, HQP
Siemens (ITE)	QN	QP
Siemens (Murray/Crouse Hinds)	MD	MP
G.E.	Q Line	Q Line
Square D	—	Homeline

Notes

- ***Connectors:** For line wire connector kits, order separately (see chart above).
- **Breakers:** Units have provision for one double pole main per meter position. Breakers not included. Order as extra (see chart above).
- **Bypass:** Lever supplies clamping action on meter spades and also operates bypass device.
- **Short Circuit Current Rating:** 10K AIC. However, this rating is limited to the lowest interrupting capacity of any circuit breaker installed. Watthour meter not included in short circuit current rating.

Please consult serving utility for their requirements prior to ordering or installing, as specifications and approvals vary by utility, and may require local electrical inspector approval. All installations must be installed by a licensed electrician and must comply with all national and local codes, laws and regulations. Milbank reserves the right to make changes in specifications and features shown without notice or obligation.



40

200 & 320 AMP
MULTI POSITION
SOCKET

Demand Side Management

200 & 320 Amp | 4 & 5 Terminal | Ringless



U4811-O-21

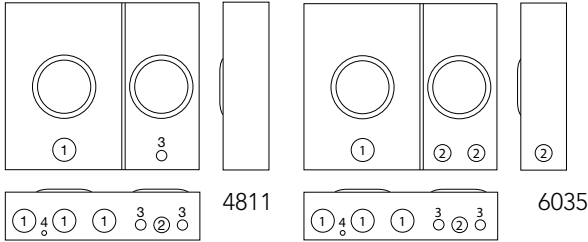

U6158-O-MNV

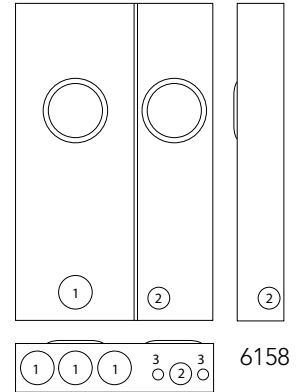

6158

200 Amp | 4 Terminal | Two Position | Off-Peak Metering

Catalog Number	Service	Connectors/ CU		Bypass	Dimensions			Knockouts			
		Left Side (Line & Load)	Right Side		D"	W"	H"	1	2	3	4
U4811-O-21	UG	#6-350	Terminal Strip	Lever/Plunger	4 ⁷ / ₈	21	18	2	1 ¹ / ₄	³ / ₄	1 ¹ / ₄ , 1 ¹ / ₂
U6035-O	UG	#6-350	Terminal Strip	Lever/None	4 ⁷ / ₈	21	18	2	1	³ / ₄	1 ¹ / ₄ , 1 ¹ / ₂

320 Amp | 5 Terminal | Two Position | Off-Peak Metering

Catalog Number	Service	Connectors/ CU		Bypass	Dimensions			Knockouts			
		Left Side (Line & Load)	Right Side		D"	W"	H"	1	2	3	4
U6158-O-MNV	UG	(2) #6-350	6 - 2/0	Lever/None	4 ⁷ / ₈	23	36	3	1 ¹ / ₄	³ / ₄	—

Notes

- **Fifth Terminal:** For field installed fifth terminal on left (200 amp) side, order catalog number **K3866**.
- Low voltage compartment in lower right corner

U4811-O-21	U6035-O	U6158-O-MNV
Left position is a 200 amp, 4 terminal heavy duty lever bypass interior - Right position is 20 amp rated with a fifth terminal in the 9 o'clock position and a plunger bypass - Right position is pre-wired to the terminal strip	Left side socket Load side wired to pull out. Left position amperage rating is a 200 Amp, 4 terminal, heavy duty lever bypass interior. right position is 100 amp 4 terminal.	Left side socket is 320 amp 4 terminal heavy duty lever bypass, and Load side wire to a two pole 20 amp fuse block. right side socket is 100 amp 5 terminal. Terminal block included on right side.



Please consult serving utility for their requirements prior to ordering or installing, as specifications and approvals vary by utility, and may require local electrical inspector approval. All installations must be installed by a licensed electrician and must comply with all national and local codes, laws and regulations. Milbank reserves the right to make changes in specifications and features shown without notice or obligation.

Lever Bypass Multi-Position Meter Main

200 Amp per Position | 5 Terminal | 120/240 VAC

4 1
LEVER BYPASS
MULTI-POSITION
METER MAINS

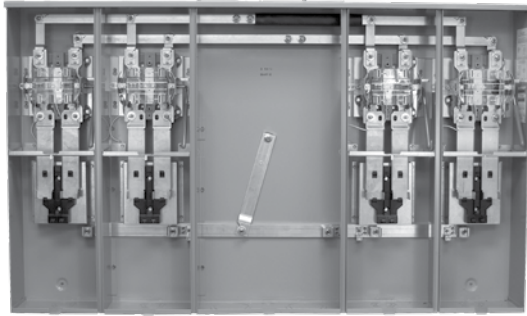

U5974-Xt-5T9-AMS

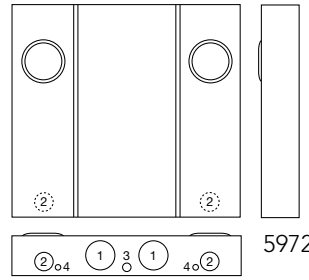

5972

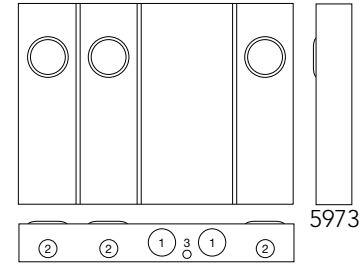

5973

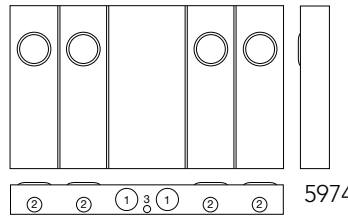

5974

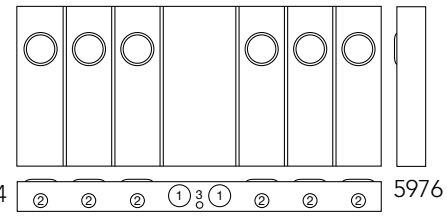

5976

NOTE

Ameren allows these units at 240 Volts and below.



200 Amp per Position | 5 Terminal | Multi-Position Meter Main | Ringless

Catalog Number	Positions	Service	Hub	Connectors CU/AL		Dimensions			Knockouts			
				Line	Load	D"	W"	H"	1	2	3	4
U5972-Xt-5T9-AMS	2	OH/UG	(2) C.P.	1/0-350	C.B.	5 ³¹ / ₃₂	36 ³ / ₈	34	4	2 ¹ / ₂	1	1/2
U5973-Xt-5T9-AMS	3	OH/UG	(2) C.P.	1/0-350	C.B.	5 ³¹ / ₃₂	46 ¹ / ₂	34	4	2 ¹ / ₂	1	-
U5974-Xt-5T9-AMS	4	OH/UG	(2) C.P.	1/0-350	C.B.	5 ³¹ / ₃₂	57 ¹ / ₁₆	34	4	2 ¹ / ₂	1	-
U5975-Xt-5T9-AMS	5	OH/UG	(2) C.P.	1/0-350	C.B.	5 ³¹ / ₃₂	67 ¹ / ₈	34	4	2 ¹ / ₂	1	-
U5976-Xt-5T9-AMS	6	OH/UG	(2) C.P.	1/0-350	C.B.	5 ³¹ / ₃₂	77 ⁹ / ₁₆	34	4	2	1	-

Notes

- **AIC Rating:** All models are rated 22K AIC.
- **Hub:** Units supplied with two closing plates. Order hubs separately from the chart below.
- **Lug Kits:** Sold separately.
- **Front Covers:** Barrel lock option available - contact factory.

Hub Chart

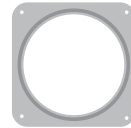
		
A8110 3" hub	A8111 3 ¹ / ₂ " hub	A8112 4" hub

Bus Chart

Catalog Number	Amp
U5972-Xt-5T9-AMS	320
U5973-Xt-5T9-AMS	450
U5974-Xt-5T9-AMS	640
U5975-Xt-5T9-AMS	640
U5976-Xt-5T9-AMS	640

Breaker Chart

Manufacturer	125-200 Amp	125 Amp or less
Cutler Hammer	BR, BJ	Quicklag P, BR, HQP
Siemens	QNR	QP
Siemens/Murray	MD	MP
G.E.	Q Line	Q Line
Square D	—	Homeline

Please consult serving utility for their requirements prior to ordering or installing, as specifications and approvals vary by utility, and may require local electrical inspector approval. All installations must be installed by a licensed electrician and must comply with all national and local codes, laws and regulations. Milbank reserves the right to make changes in specifications and features shown without notice or obligation.



Lever Bypass Temporary Power Outlet

125 Amp | 5 Terminal | Ringless | 120/240 VAC



U5091-RL-76GBGR

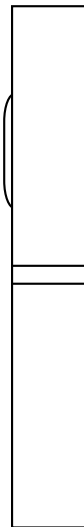
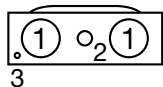
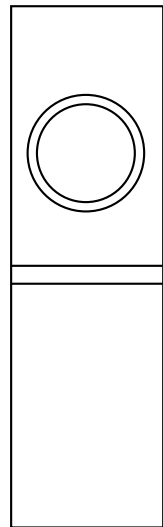

5091



U6134-RL-76GBGR

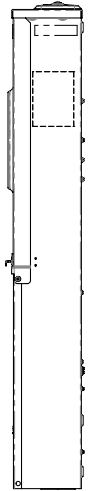
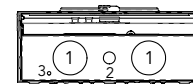
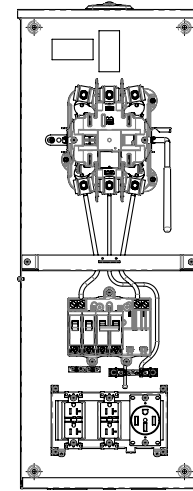

6134

125 Amp | 5 Terminal | Metered Temporary Power Outlet | Lever Bypass | Ringless

Catalog Number	Service	Hub	Line Side Connectors	Dimensions			Knockouts		
				D"	W"	H"	1	2	3
U5091-RL-76GBGR	OH	H.O.	#6-350 kcmil	4 ⁷ / ₈	10	34	2	1/2	1/4
U6134-RL-76GBGR	OH/UG	H.O.	#6-350 kcmil	4 ² / ₂₅	13	35	2	1/2	1/4

Notes

- **Breakers:** Factory wired with two (2) 20 amp/120V breakers and one (1) 50 amp/120-240V GFCI breaker.
- **Receptacles:** Includes two (2) factory installed 20 amp/120V duplex GFCI receptacles and one (1) 50 amp/120-240V receptacle.
- **Bypass:** Lever supplies clamping action on meter spades and also operates bypass device.
- **Fifth Terminal:** Includes factory installed fifth terminal at 9 o'clock.
- **Short Circuit Current Rating:** 10K AIC. However, this rating is limited to the lowest interrupting capacity of any circuit breaker installed. Watthour meter not included in short circuit current rating.



Please consult serving utility for their requirements prior to ordering or installing, as specifications and approvals vary by utility, and may require local electrical inspector approval. All installations must be installed by a licensed electrician and must comply with all national and local codes, laws and regulations. Milbank reserves the right to make changes in specifications and features shown without notice or obligation.

Surface Mount Power Outlet

U5000 "Millennium" Series | Unmetered

43
SURFACE
MOUNT
POWER
OUTLET



U5000-XL-75

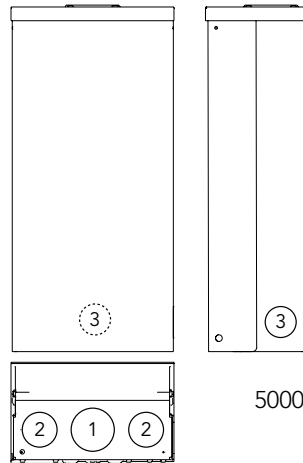

5000



U5000-XL-332

125 Amp | Unmetered Surface Mount Power Outlet

Catalog Number	Receptacle Configuration	Circuit Breaker Configuration	Loop Feed Line	Dimensions			Knockouts		
				D"	W"	H"	1	2	3
U5000-XL	—	—	(2) 1/0-#12	5½	9⅞	19¼	2	1½	1¼
U5000-XL-41	A	V	(2) 1/0-#12	5½	9⅞	19¼	2	1½	1¼
U5000-XL-332	B	W	(2) 1/0-#12	5½	9⅞	19¼	2	1½	1¼
U5000-XL-55	C	X	(2) 1/0-#12	5½	9⅞	19¼	2	1½	1¼
U5000-XL-75	D	Y	(2) 1/0-#12	5½	9⅞	19¼	2	1½	1¼
U5000-XL-75GB	E	Z	(2) 1/0-#12	5½	9⅞	19¼	2	1½	1¼

Receptacle Configurations

A	B	C	D	E
(1) TT30R, (1) 5-20R GFI	(2) TT30R, (1) 5-20R GFI	(1) 14-50R, (1) 5-20R GFI	(1) 14-50R, (1) TT30R, (1) 5-20R GFI	(1) 14-50R, (1) TT30R, (1) 5-20R

Circuit Breaker Configurations

V	W	X	Y	Z
(1) 30A, 1P, 120V (1) 20A, 1P, 120V	(2) 30A, 1P, 120V (1) 20A, 1P, 120V	(1) 50A, 2P, 120/240V (1) 20A, 1P, 120V	(1) 50A, 2P, 120/240V (1) 30A, 1P, 120V (1) 20A, 1P, 120V	(1) 50A, 2P, 120/240V (1) 30A, 1P, 120V (1) 20A, 1P, 120V GFI

Please consult serving utility for their requirements prior to ordering or installing, as specifications and approvals vary by utility, and may require local electrical inspector approval. All installations must be installed by a licensed electrician and must comply with all national and local codes, laws and regulations. Milbank reserves the right to make changes in specifications and features shown without notice or obligation.



Surface Mount Power Outlet

U5100 "Millennium" Series | Metered | Ring Type



U5100-XL-75

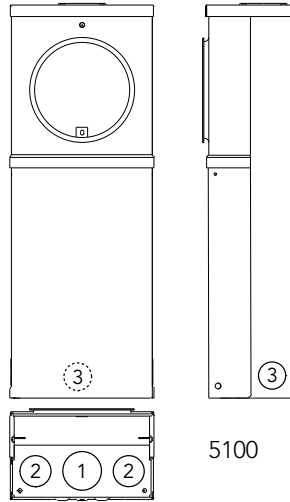

5100



U5100-XL-552GR

125 Amp | Metered Surface Mount Power Outlet

Catalog Number	Receptacle Configuration	Circuit Breaker Configuration	Line Side Connectors	Dimensions			Knockouts		
				D"	W"	H"	1	2	3
U5100-XL	—	—	#6-250	5½	9⅞	25	2	1½	1¼
U5100-XL-41	A	V	#6-250	5½	9⅞	25	2	1½	1¼
U5100-XL-55	B	W	#6-250	5½	9⅞	25	2	1½	1¼
U5100-XL-75	C	X	#6-250	5½	9⅞	25	2	1½	1¼
U5100-XL-75GB	D	Y	#6-250	5½	9⅞	25	2	1½	1¼
U5100-XL-552GR	E	Z	#6-250	5½	9⅞	25	2	1½	1¼

Receptacle Configurations

A	B	C	D	E
(1) TT30R, (1) 5-20R GFI	(1) 14-50R, (1) 5-20R GFI	(1) 14-50R, (1) TT30R, (1) 5-20R GFI	(1) 14-50R, (1) TT30R, (1) 5-20R	(1) 14-50R, (1) TT30R, (1) 5-20R

Circuit Breaker Configurations

V	W	X	Y	Z
(1) 30A, 1P, 120V (1) 20A, 1P, 120V	(1) 50A, 2P, 120/240V (1) 20A, 1P, 120V	(1) 50A, 2P, 120/240V (1) 30A, 1P, 120V (1) 20A, 1P, 120V	(1) 50A, 2P, 120/240V (1) 30A, 1P, 120V (1) 20A, 1P, 120V GFI	(2) 50A, 2P, 120/240V (1) 20A, 1P, 120V



Please consult serving utility for their requirements prior to ordering or installing, as specifications and approvals vary by utility, and may require local electrical inspector approval. All installations must be installed by a licensed electrician and must comply with all national and local codes, laws and regulations. Milbank reserves the right to make changes in specifications and features shown without notice or obligation.

Power Outlet Pedestal

U5200 "Millennium" Series | Unmetered

45
POWER
OUTLET
PEDESTAL



U5200-XL-75

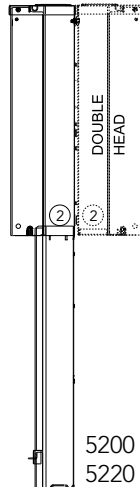
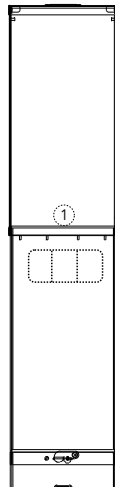

U5200-XL-55

125 Amp | Unmetered Power Outlet Pedestal

Catalog Number	Double Head Catalog Number	Receptacle Configuration	Circuit Breaker Configuration	Dimensions			Knockouts
				D"	W"	H"	1
U5200-XL	U5220-XL	—	—	5 ⁹ / ₁₆	9 ¹ / ₈	64 ¹ / ₂	1 ¹ / ₄
U5200-XL-41	U5220-XL-41	A	U	5 ⁹ / ₁₆	9 ¹ / ₈	64 ¹ / ₂	1 ¹ / ₄
U5200-XL-41GB	U5220-XL-41GB	B	V	5 ⁹ / ₁₆	9 ¹ / ₈	64 ¹ / ₂	1 ¹ / ₄
U5200-XL-55	U5220-XL-55	C	W	5 ⁹ / ₁₆	9 ¹ / ₈	64 ¹ / ₂	1 ¹ / ₄
U5200-XL-332	U5220-XL-332	D	X	5 ⁹ / ₁₆	9 ¹ / ₈	64 ¹ / ₂	1 ¹ / ₄
U5200-XL-75	U5220-XL-75	E	Y	5 ⁹ / ₁₆	9 ¹ / ₈	64 ¹ / ₂	1 ¹ / ₄
U5200-XL-75GB	U5220-XL-75GB	F	X	5 ⁹ / ₁₆	9 ¹ / ₈	64 ¹ / ₂	1 ¹ / ₄

Receptacle Configurations

A	B	C	D	E	F
(1) TT30R, (1) 5-20R GFI	(1) TT30R, (1) 5-20R	(1) 14-50R, (1) 5-20R GFI	(2) TT30R, (1) 5-20R GFI	(1) 14-50R, (1) TT30R, (1) 5-20R GFI	(1) 14-50R, (1) TT30R, (1) 5-20R

Circuit Breaker Configurations

U	V	W	X	Y	Z
(1) 30A, 1P, 120V (1) 20A, 1P, 120V	(1) 30A, 1P, 120V (1) 20A, 1P, 120V GFI	(1) 50A, 2P, 120/240V (1) 20A, 1P, 120V	(2) 30A, 1P, 120V (1) 20A, 1P, 120V	(1) 50A, 2P, 120/240V (1) 30A, 1P, 120V (1) 20A, 1P, 120V	(1) 50A, 2P, 120/240V (1) 30A, 1P, 120V (1) 20A, 1P, 120V GFI

Please consult serving utility for their requirements prior to ordering or installing, as specifications and approvals vary by utility, and may require local electrical inspector approval. All installations must be installed by a licensed electrician and must comply with all national and local codes, laws and regulations. Milbank reserves the right to make changes in specifications and features shown without notice or obligation.



Power Outlet Pedestal

U5300 "Millennium" Series | Metered | Ring Type



U5300-O-75

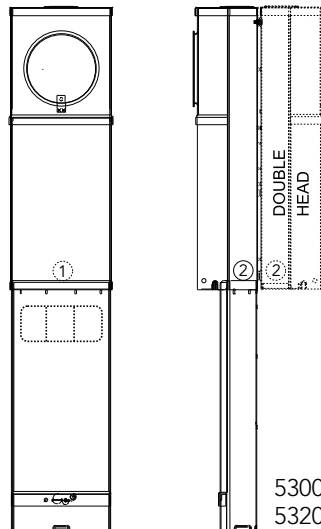

5300
5320



U5300-O-552GR

125 Amp | Metered Power Outlet Pedestal

Catalog Number	Double Head Catalog Number	Receptacle Configuration	Circuit Breaker Configuration	Dimensions			Knockouts
				D"	W"	H"	1
U5300-O	U5320-O	—	—	5 ⁵ / ₁₆	9 ⁷ / ₈	70 ¹ / ₄	1 ¹ / ₄
U5300-O-41	U5320-O-41	A	W	5 ⁵ / ₁₆	9 ⁷ / ₈	70 ¹ / ₄	1 ¹ / ₄
U5300-O-55	U5320-O-55	B	X	5 ⁵ / ₁₆	9 ⁷ / ₈	70 ¹ / ₄	1 ¹ / ₄
U5300-O-75	U5320-O-75	C	Y	5 ⁵ / ₁₆	9 ⁷ / ₈	70 ¹ / ₄	1 ¹ / ₄
U5300-O-552GR	U5320-O-552GR	D	Z	5 ⁵ / ₁₆	9 ⁷ / ₈	70 ¹ / ₄	1 ¹ / ₄

Receptacle Configurations

A	B	C	D
(1) TT30R, (1) 5-20R GFI	(1) 14-50R (1) 5-20R GFI	(1) 14-50R, (1) TT30R, (1) 5-20R GFI	(2) 14-50R, (1) 5-20R GFI

Circuit Breaker Configurations

W	X	Y	Z
(1) 30A, 1P, 120V (1) 20A, 1P, 120V	(1) 50A, 2P, 120/240V (1) 20A, 1P, 120V GFI	(1) 50A, 2P, 120/240V (1) 30A, 1P, 120V (1) 20A, 1P, 120V	(2) 50A, 2P, 120/240V (1) 20A, 1P, 120V



Please consult serving utility for their requirements prior to ordering or installing, as specifications and approvals vary by utility, and may require local electrical inspector approval. All installations must be installed by a licensed electrician and must comply with all national and local codes, laws and regulations. Milbank reserves the right to make changes in specifications and features shown without notice or obligation.

Replacement Receptacle Plates

For Millennium Series RV Products

47
REPLACEMENT
RECEPTACLE
PLATES

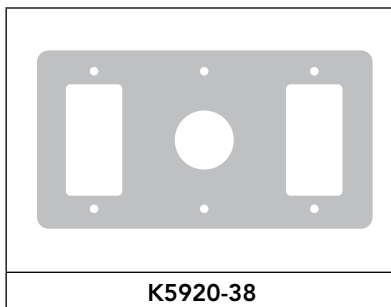
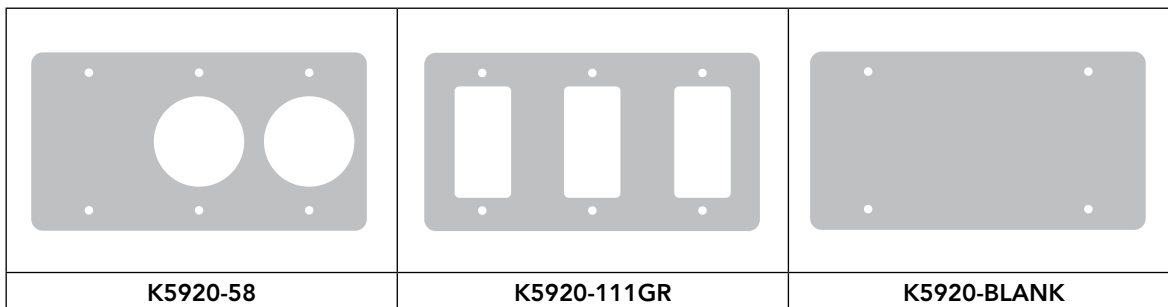
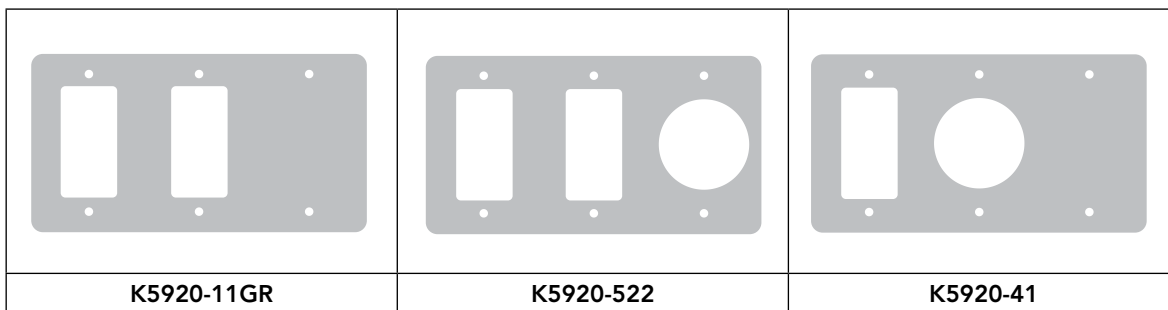
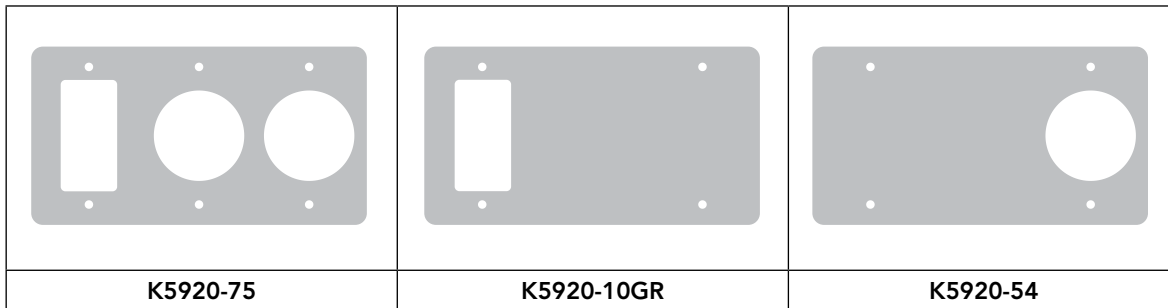

Notes

- For application details, consult factory.

Please consult serving utility for their requirements prior to ordering or installing, as specifications and approvals vary by utility, and may require local electrical inspector approval. All installations must be installed by a licensed electrician and must comply with all national and local codes, laws and regulations. Milbank reserves the right to make changes in specifications and features shown without notice or obligation.



48

200 AMP
METER MAIN
W/ LOAD
CENTER
PEDESTAL

Meter Main with Load Center Pedestal

200 Amp | 4 Terminal | Ringless | 120/240 VAC



U5136-O-200S-10GR
Picture shown with
receptacle installed

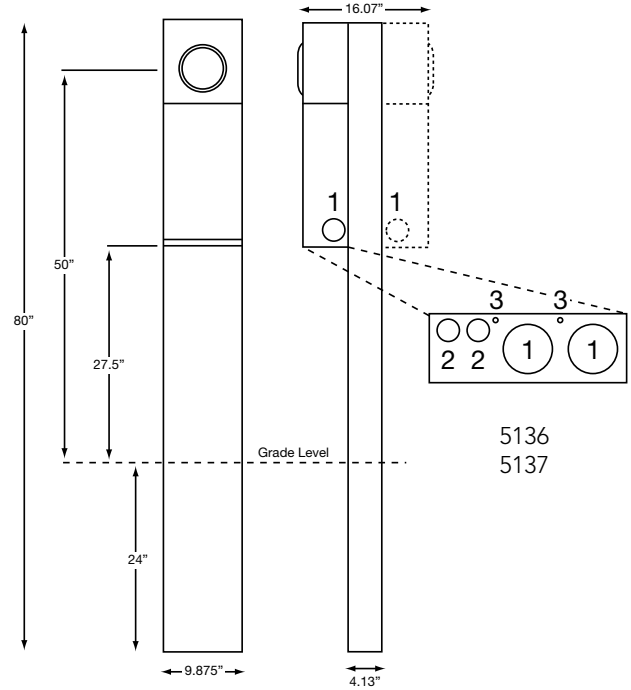

5136
5137

200 Amp | 4 Terminal | Meter Main with Pedestal | Ringless

Catalog Number	Service	Bypass	Connectors CU/AL		Dimensions			Knockouts		
			Line	Load	D"	W"	H"	1	2	3
U5136-O-200S	UG	Horn	#6-350	CB	4 $\frac{1}{8}$	9 $\frac{7}{8}$	80	2	1/2, 3/4	1/4
U5137-O-200S*	UG	Horn	#6-350	CB	4 $\frac{1}{8}$	9 $\frac{7}{8}$	80	2	1/2, 3/4	1/4

Notes

- **Parallel to Series Conversion:** For field converting from parallel wired to series wired order **K5194**.
- **Fifth Terminal:** For field installed fifth terminal, order **K5T**.
- **Stabilizer Foot:** For field installed stabilizer foot, order **K5415**.
- **Penta Bolt Locking:** For field installed pedestal fronts penta bolt locking, order **K5039**.
- **Receptacles:** Consult factory for installed receptacle assemblies.
- **Short Circuit Current Rating:** 22K AIC. However, this rating is limited to the lowest interrupting capacity of any circuit breaker installed. Watthour meter not included in short circuit current rating.
- ***U5137:** Double power head version.



Please consult serving utility for their requirements prior to ordering or installing, as specifications and approvals vary by utility, and may require local electrical inspector approval. All installations must be installed by a licensed electrician and must comply with all national and local codes, laws and regulations. Milbank reserves the right to make changes in specifications and features shown without notice or obligation.

Lever Bypass Meter Pedestals

200 Amp | 5 & 7 Terminal | Ringless | 600 VAC

49
200 AMP
LEVER BYPASS
METER
PEDESTALS



U9107-O-5T9

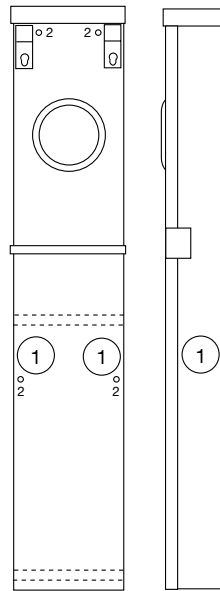

4724
9107
9108



U4724-O-5T9

200 Amp | 5 Terminal | Metered Pedestals | Lever Bypass | Ringless

Catalog Number	Service	Hub	Connectors CU/AL		Bypass	Dimensions			Knockouts	
			Line	Load		D"	W"	H"	1	2
U9108-O-5T9	UG	Blank	3/0-4/0	#6-350	Lever	6	11	58	2½	½, ¾
U4724-O-5T9	UG	Blank	3/0-4/0	#6-350	Lever	6	11	64	2½	½, ¾

Notes

- **Bypass:** Lever supplies clamping action on meter spades and also operates bypass device.
- **Neutral Disconnect:** The **U9108** has a manual neutral disconnect bolt.
- **Direct Burial:** For free standing use, order separately burial kit **S3488**.
- **Fifth Terminal:** Includes factory installed fifth terminal at 9 o'clock. For fifth terminal at 6 o'clock, substitute **-5T6** suffix in catalog number.

200 Amp | 7 Terminal | Metered Pedestals | Lever Bypass | Ringless

Catalog Number	Service	Hub	Connectors CU/AL		Bypass	Dimensions			Knockouts	
			Line	Load		D"	W"	H"	1	2
U9107-O	UG	Blank	3/0-4/0	#6-350	Lever	6	11	58	2½	¼

Notes

- **Bypass:** Lever supplies clamping action on meter spades and also operates bypass device.
- **Direct Burial:** For free standing use, order separately burial kit **S3488**.

Please consult serving utility for their requirements prior to ordering or installing, as specifications and approvals vary by utility, and may require local electrical inspector approval. All installations must be installed by a licensed electrician and must comply with all national and local codes, laws and regulations. Milbank reserves the right to make changes in specifications and features shown without notice or obligation.



50

200 AMP
METER MAIN
W/ LOAD
CENTER
PEDESTAL

Meter Main with Load Center Pedestal

200 Amp | 4 & 5 Terminal | Lever Bypass | 120/240 VAC

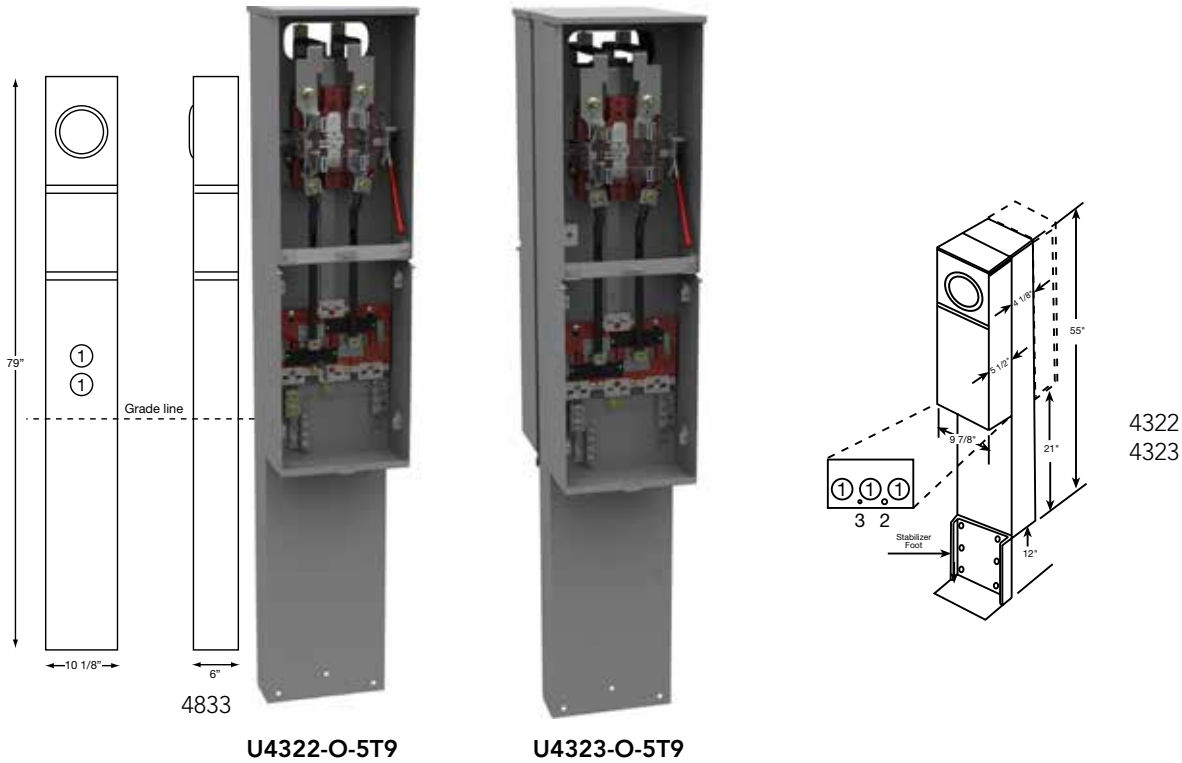

200 Amp | 4 & 5 Terminal | Meter Main Pedestals | Lever Bypass | Ringless

4-Terminal Catalog Number	5-Terminal Catalog Number	Meter Positions	Bypass	Twin Line Connectors CU/AL	Circuit Provisions	Knockouts			Dimensions		
						1	2	3	D"	W"	H"
U4322-O	U4322-O-5T9	Single	Lever	#6-350	6	2	1/2	1/4	9 5/8	9 7/8	55
U4323-O	U4323-O-5T9	Double	Lever	#6-350	6	2	1/2	1/4	15 1/8	9 7/8	55
U4833-O*	U4833-O-5T9*	Single	Lever	#6-350	6	2 1/2	—	—	6	10 1/8	79

Notes

- **Lever Bypass:** Lever provides clamping action on meter spades and also operates bypass device
- **Application:** The U4322 & U4323 pedestals are suitable for use as service equipment or mobile home service equipment. Includes direct burial kit K5081/K3188. For pad mounting, order kit K5151.
- **Breakers:** These units are wired as parallel mains and have provisions for six circuits: six single-pole or three double-pole breakers. See chart on page 73. Quadplex style breakers may be used in accordance to the NEC. If main breaker is used, there are provisions for two 2-pole breakers or four 1-pole breakers in series. ***NOTE:** The U4833 is wired as parallel main and has provisions for (1) double pole large frame UQFP-(AMP) or UQFPH-(AMP) main breaker, and (4) single pole, or (1) double pole and (2) single pole small frame branch breakers. See chart on page 74.
- **Fifth Terminal Kit:** For field installed fifth terminal order catalog number K3865 (neutral wire provided) or K3866 (no neutral wire). Units with -5T9 suffix supplied with fifth terminal factory installed at 9 o'clock.
- **Short Circuit Current Rating:** 10K AIC. However, this rating is limited to the lowest interrupting capacity of any circuit breaker installed. Watthour meter not included in short circuit current rating.



Please consult serving utility for their requirements prior to ordering or installing, as specifications and approvals vary by utility, and may require local electrical inspector approval. All installations must be installed by a licensed electrician and must comply with all national and local codes, laws and regulations. Milbank reserves the right to make changes in specifications and features shown without notice or obligation.

Meter Main with Load Center Pedestal

200 Amp | 5 Terminal | Lever Bypass | Ringless

5 1
200 AMP
METER MAIN
W/ LOAD
CENTER
PEDESTAL



U5701-O-5T9

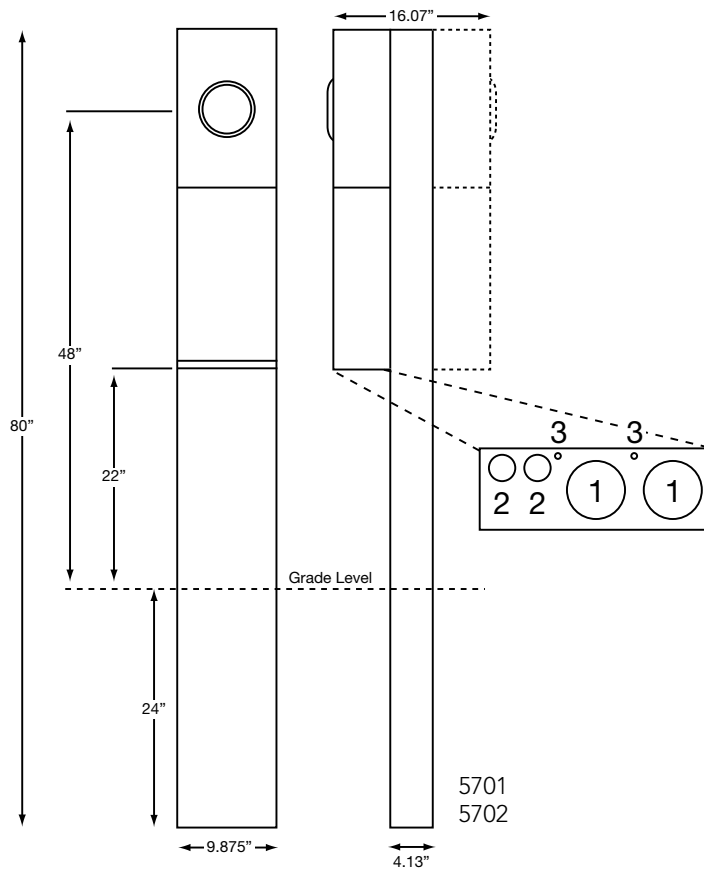

5701
5702

200 Amp | 5 Terminal | Meter Main Pedestal | Lever Bypass | Ringless

Catalog Number	Service	Connectors CU/AL		Dimensions			Knockouts		
		Line	Load	D"	W"	H"	1	2	3
U5701-O-5T9	UG	#6-350	CB	4 $\frac{1}{8}$	9 $\frac{7}{8}$	80	2	$\frac{1}{2}$, $\frac{3}{4}$	$\frac{1}{4}$
U5702-O-5T9	UG	#6-350	CB	4 $\frac{1}{8}$	9 $\frac{7}{8}$	80	2	$\frac{1}{2}$, $\frac{3}{4}$	$\frac{1}{4}$
U5703-O-5T9	UG	#6-350	CB	4 $\frac{1}{8}$	9 $\frac{7}{8}$	56	2	$\frac{1}{2}$, $\frac{3}{4}$	$\frac{1}{4}$

Notes

- **Parallel to Series Conversion:** For field converting from parallel wired to series wired order **K5194**.
- **Stabilizer Foot:** For field installed stabilizer foot, order **K5415**.
- **Receptacles:** Consult factory for installed receptacle assemblies.
- **Breakers:** Units will accept Milbank UQFP or UQFPH for main breaker. These units are wired as parallel mains and have provisions for one large frame two pole breaker and four spaces for either four small frame single pole breakers or two double pole small frame breakers. Quadplex style breakers may be used in accordance to the NEC.
- **U5701:** Rated for 22K
- **Pad Mounting:** For pad mounting **U5703**, order kit **K5035**.

Please consult serving utility for their requirements prior to ordering or installing, as specifications and approvals vary by utility, and may require local electrical inspector approval. All installations must be installed by a licensed electrician and must comply with all national and local codes, laws and regulations. Milbank reserves the right to make changes in specifications and features shown without notice or obligation.



52

100 & 200 AMP
RESIDENTIAL
PEDESTAL

Meter Main with Main Breaker

100 & 200 Amp | 4 Terminal | Lever Bypass | Ringless



U6221-O-100-10GR

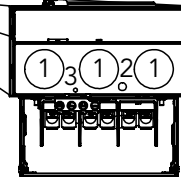
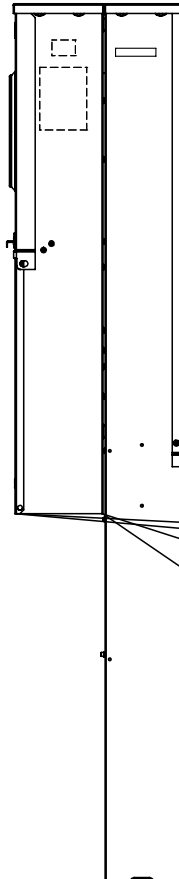
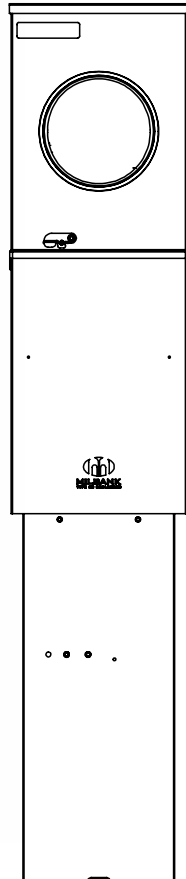

U6221-O-200-10GR

100 & 200 Amp | 4 Terminal | Meter Main Pedestal | Lever Bypass | Ringless

Catalog Number	Service	Connectors CU/AL		Dimensions			Knockouts		
		Line	Load	D"	W"	H"	1	2	3
U6221-O-100-10GR	UG	#6-350 kcmil	#6-350 kcmil	10	11	80	2	1/2	1/4
U6221-O-200-10GR	UG	#6-350 kcmil	#6-350 kcmil	10	11	80	2	1/2	1/4

Notes

- **Fifth Terminal:** For field installed fifth terminal, order **K5T** for **U6221** use the **K3865**.
- **Breakers:** Rated 22K AIC with Milbank **QN2200RH** main installed.
- **Interlock Kit:** For generator auxiliary circuit breaker interlock, order **K5815** for large **QN** with small frame **Q**; order **K5820** for large frame **QN** with large frame **QN**; order **K5830** for small frame **Q** to small frame **Q**.
- **Sub Feed Lugs:** #6-350 sub feed lugs provided on 8 circuit interior.
- Comes from the factory with 20 amp GFCI Receptacle installed.



Please consult serving utility for their requirements prior to ordering or installing, as specifications and approvals vary by utility, and may require local electrical inspector approval. All installations must be installed by a licensed electrician and must comply with all national and local codes, laws and regulations. Milbank reserves the right to make changes in specifications and features shown without notice or obligation.

Lever Bypass Residential Pedestal

320 Amp Continuous | 400 Amp Max | 5 Terminal

53
320 AMP
RESIDENTIAL
PEDESTAL

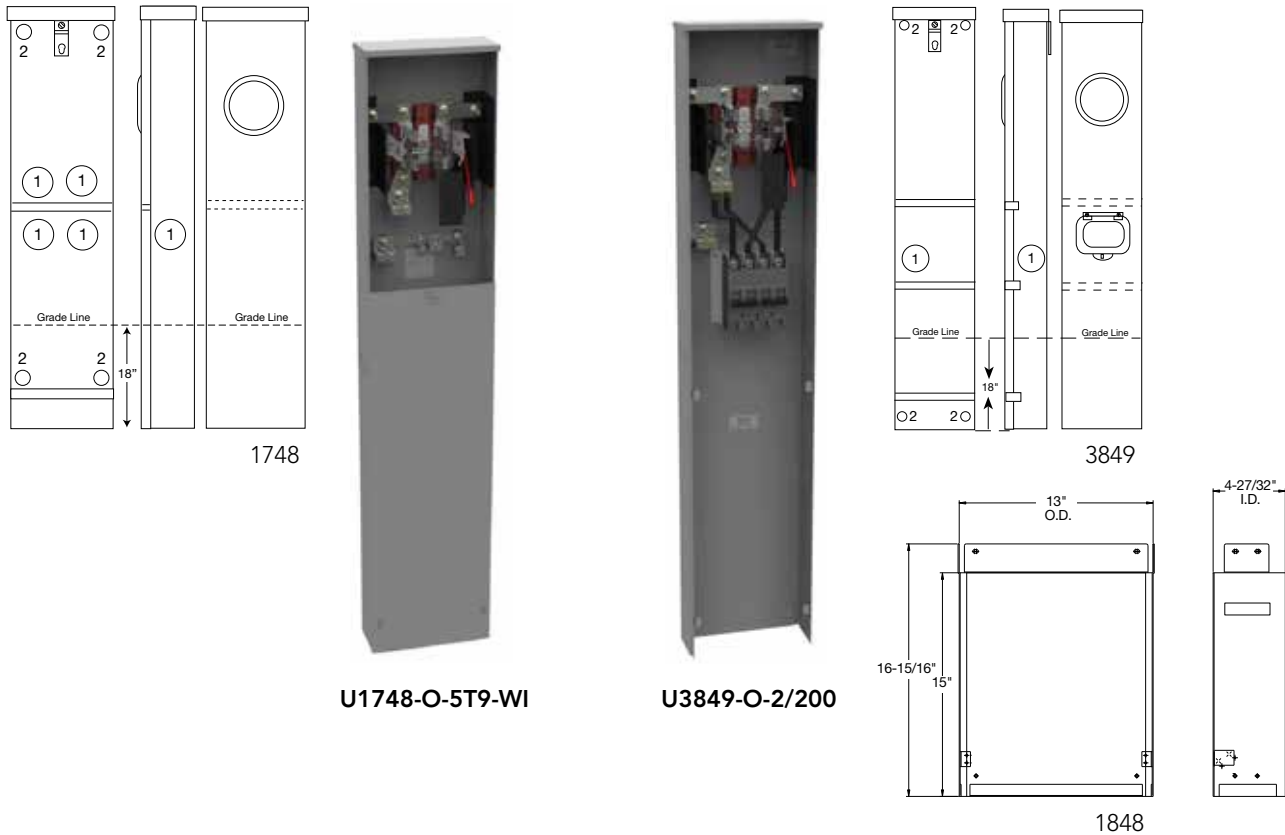

320 Amp | 5 Terminal | Meter Main without Breakers | Ringless | 600 VAC

Catalog Number	Service	Hub	Bypass	Connectors CU/AL		Dimensions			Knockouts	
				Line	Load	D"	W"	H"	1	2
U1748-O-5T9-WI	UG	Blank	Lever	3/8" x 16 Studs	Twin #6-350	4 7/8	13	64	2 1/2	5/16

320 Amp | 5 Terminal | Meter Main with Breakers | Ringless | 120/240 VAC

Catalog Number	Service	Hub	Bypass	Connectors CU/AL		Dimensions			Knockouts	
				Line	Load	D"	W"	H"	1	2
U3849-O-2/200-5T9* [Ⓢ]	UG	Blank	Lever	3/8" x 16 Studs	CB #1/0-300	4 7/8	13	64	2 1/2	5/16

Notes

- **Bypass:** The lever supplies clamping action on the meter spade and also operates the bypass device.
- **Connectors:** [Ⓢ]Sockets are supplied with 3/8" -16 hex head nuts with Belleville washers. For connector lug kits, order as extra from chart on page 76. Lug kit required for line side only.
- ***Breakers:** The **U3849** is supplied with (2) 200 amp Milbank type **UQFBH-200** 22K AIC circuit breakers.
- **Direct Burial:** For free standing use, order separately burial kit **S1848**.
- **Anti-Inversion Kit:** If anti-inversion kit is required, order catalog number **K4802** as extra.
- **Short Circuit Current Rating:** For **U3849** is 22K AIC. However, this rating is limited to the lowest interrupting capacity of any circuit breaker installed. Watthour meter not included in short circuit current rating.

Please consult serving utility for their requirements prior to ordering or installing, as specifications and approvals vary by utility, and may require local electrical inspector approval. All installations must be installed by a licensed electrician and must comply with all national and local codes, laws and regulations. Milbank reserves the right to make changes in specifications and features shown without notice or obligation.





S1994-WL-KK



SC2077-XL



SC2992-RL

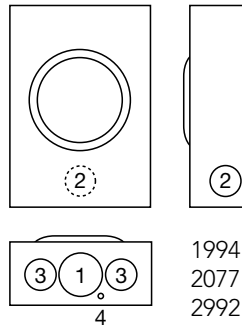

1994
2077
2992

20 Amp | Ringless | Transformer Rated | Overhead/Underground Service

Catalog Number	Terminals	Hub	Meter Form	Bypass	Connectors CU	Dimensions			Knockouts			
						D"	W"	H"	1	2	3	4
S1994-WL-KK	6	1"	4S	Horn	#12 - #10	3 ⁵ / ₁₆	8	11 ¹ / ₂	2	1 ¹ / ₂	1 ¹ / ₄	1 ¹ / ₄
SC2077-XL	6	C.P.	4S	Plunger	#14 - #10	3 ⁵ / ₁₆	8	11 ¹ / ₂	2	1 ¹ / ₂	1 ¹ / ₄	1 ¹ / ₄
SC2992-RL	5	H.O.	12S	Plunger	#14 - #10	3 ⁵ / ₁₆	8	11 ¹ / ₂	2	1 ¹ / ₂	1 ¹ / ₄	1 ¹ / ₄

Notes

- **Hub:** For proper hub selection, see the hub suffix chart on the accessories page.
- **Bypass:** Plunger type bypass automatically closes when meter is removed.



Please consult serving utility for their requirements prior to ordering or installing, as specifications and approvals vary by utility, and may require local electrical inspector approval. All installations must be installed by a licensed electrician and must comply with all national and local codes, laws and regulations. Milbank reserves the right to make changes in specifications and features shown without notice or obligation.

Lever Bypass Transformer Rated

20 & 80 Amp | 6, 8 & 13 Terminal | Ringless | 600 VAC

55
LEVER BYPASS
TRANSFORMER
RATED



U4490-XL

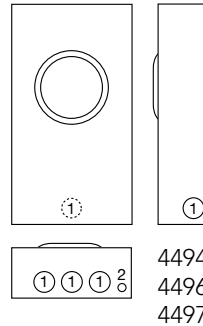
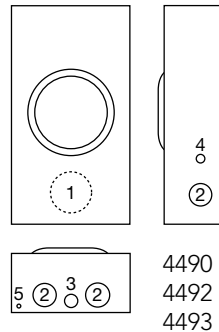

U4497-XL

*20 Amp | Ringless | Transformer Rated | Lever Bypass | With Provision for Test Switch

Catalog Number	Terminals	Hub	Service	Connectors CU	Dimensions			Knockouts	
					D"	W"	H"	1	2
U4494-XL	6	C.P.	OH/UG	#14 - #4 Max	4 ⁷ / ₈	12	22	1 ¹ / ₂	1/4, 1/2
U4496-XL	8	C.P.	OH/UG	#14 - #4 Max	4 ⁷ / ₈	12	22	1 ¹ / ₂	1/4, 1/2
U4497-XL	13	C.P.	OH/UG	#14 - #4 Max	4 ⁷ / ₈	12	22	1 ¹ / ₂	1/4, 1/2

80 Amp | Ringless | Transformer Rated | Lever Bypass

Catalog Number	Terminals	Hub	Service	Connectors CU	Dimensions			Knockouts				
					D"	W"	H"	1	2	3	4	5
U4490-XL	6	C.P.	OH/UG	#14 - #4 Max	4 ⁷ / ₈	10	18 ¹ / ₂	3	1 ¹ / ₂	1/2, 3/4	3/4	1/4
U4492-XL	8	C.P.	OH/UG	#14 - #4 Max	4 ⁷ / ₈	10	18 ¹ / ₂	3	1 ¹ / ₂	1/2, 3/4	3/4	1/4
U4493-XL	13	C.P.	OH/UG	#14 - #4 Max	4 ⁷ / ₈	10	18 ¹ / ₂	3	1 ¹ / ₂	1/2, 3/4	3/4	1/4

Notes

- **Bypass:** Lever operates current bypass devices and also supplies clamping action on current meter spades.
- ***Prewiring:** If standard factory prewiring is required, refer to wiring diagrams in the general engineering section of this catalog. Determine appropriate diagram and send copy with order. If custom factory prewiring is required, specify on order. Be sure to include meter socket catalog number, test switch model and number, and meter form number. Please be sure to provide a copy of your wiring diagram.
- ***Test Switch Cover:** Units on this page can be used with clear lexan cover. See accessories page for ordering information.
- ***Block Assembly:** Block assembly rated at 80 amps and test switch rated at 20 amps; therefore, unit defaults to test switch rating of 20 amps.
- **Connectors:** Units are supplied with mechanical type connectors (#4 max). If compression type connectors (#10) are preferred, change catalog prefix to "S" (i.e. U4494-XL becomes S4494-XL). The "S" prefix also designates non-U/L.

Please consult serving utility for their requirements prior to ordering or installing, as specifications and approvals vary by utility, and may require local electrical inspector approval. All installations must be installed by a licensed electrician and must comply with all national and local codes, laws and regulations. Milbank reserves the right to make changes in specifications and features shown without notice or obligation.



Transformer Rated

20 Amp | 5, 6, 7, 8 & 13 Terminal | 600 VAC

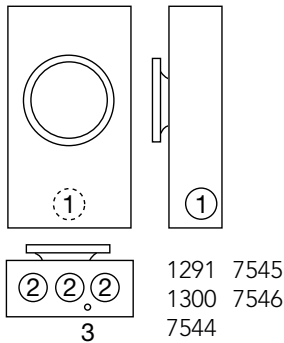

1291 7545
1300 7546
7544



UC7545-RL

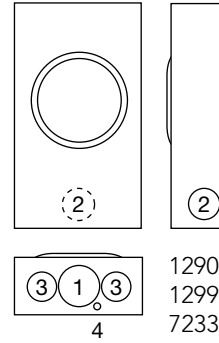

1290 7235
1299 7237
7233

20 Amp | Ringless | Plunger Bypass | Overhead/Underground Service

Catalog Number	Terminals	Hub	Meter Form	Connectors CU	Bypass	Dimensions			Knockouts			
						D"	W"	H"	1	2	3	4
UC1290-RL	5	H.O.	3S	#14 - #10	Plunger	3 ⁵ / ₁₆	8	14	2	1 ¹ / ₂	1 ¹ / ₄	1 ¹ / ₄
UC1299-RL	6	H.O.	4S	#14 - #10	Plunger	3 ⁵ / ₁₆	8	14	2	1 ¹ / ₂	1 ¹ / ₄	1 ¹ / ₄
UC7233-RL	7	H.O.	7, 14, 15 & 24S	#14 - #10	Plunger	3 ⁵ / ₁₆	8	14	2	1 ¹ / ₂	1 ¹ / ₄	1 ¹ / ₄
UC7235-RL	8	H.O.	5S	#14 - #10	Plunger	3 ⁵ / ₁₆	8	14	2	1 ¹ / ₂	1 ¹ / ₄	1 ¹ / ₄
UC7237-RL	13	H.O.	6, 8, 9S & (ALT) 10S	#14 - #10	Plunger	3 ⁵ / ₁₆	8	14	2	1 ¹ / ₂	1 ¹ / ₄	1 ¹ / ₄

20 Amp | Ring Type | Plunger Bypass | Overhead/Underground Service

Catalog Number	Terminals	Hub	Meter Form	Connectors CU	Bypass	Dimensions			Knockouts			
						D"	W"	H"	1	2	3	4
UC1291-RL	5	H.O.	3S	#14 - #4 Max	Plunger	3 ⁵ / ₁₆	8	14	2	1 ¹ / ₂	1 ¹ / ₄	1 ¹ / ₄
UC1300-RL	6	H.O.	4S	#14 - #4 Max	Plunger	3 ⁵ / ₁₆	8	14	2	1 ¹ / ₂	1 ¹ / ₄	1 ¹ / ₄
UC7546-RL	7	H.O.	7, 14, 15 & 24S	#14 - #4 Max	Plunger	3 ⁵ / ₁₆	8	14	2	1 ¹ / ₂	1 ¹ / ₄	1 ¹ / ₄
UC7544-RL	8	H.O.	5S	#14 - #4 Max	Plunger	3 ⁵ / ₁₆	8	14	2	1 ¹ / ₂	1 ¹ / ₄	1 ¹ / ₄
UC7545-XL	13	H.O.	6, 8, 9S & (ALT) 10S	#14 - #4 Max	Plunger	3 ⁵ / ₁₆	8	14	2	1 ¹ / ₂	1 ¹ / ₄	1 ¹ / ₄

Notes

- **Hubs:** For proper hub selection, see the hub suffix chart on the accessories page.
- **Bypass:** Plunger type bypass automatically closes when meter is removed.
- **Connectors:** Units are supplied with mechanical type connectors (#4 max). If compression type connectors (#10) are preferred, change catalog prefix to "S" (i.e. UC1289-XL becomes S1289-XL). The "S" prefix also designates non-U/L.



Please consult serving utility for their requirements prior to ordering or installing, as specifications and approvals vary by utility, and may require local electrical inspector approval. All installations must be installed by a licensed electrician and must comply with all national and local codes, laws and regulations. Milbank reserves the right to make changes in specifications and features shown without notice or obligation.

Transformer Rated

20 Amp | 5, 6, 8, & 13 Terminals | Test Switch Provision |
600 VAC

57
20 AMP
TRANSFORMER
RATED

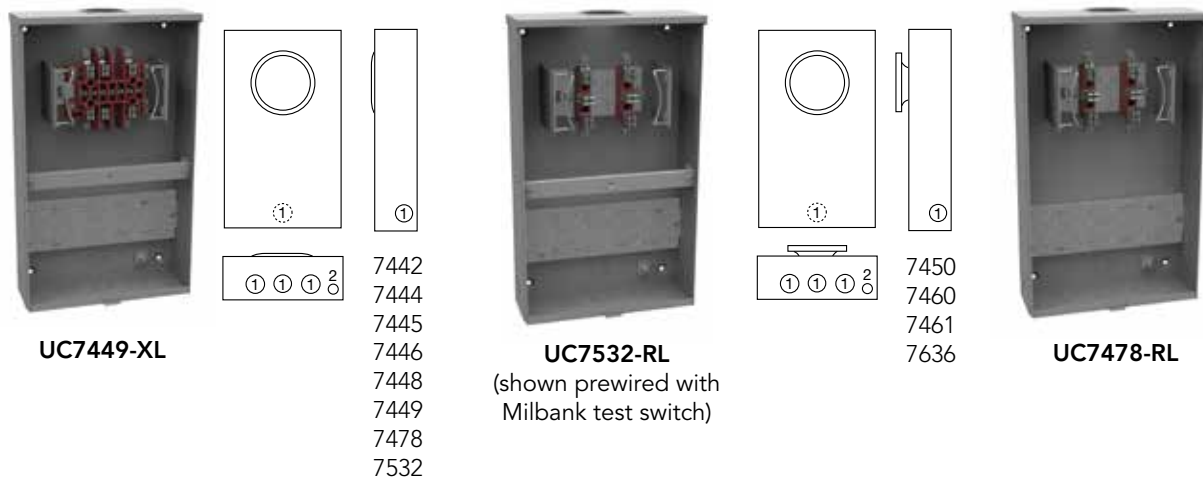

1 Piece Cover | Ringless | Overhead/Underground Service | with test switch provision*

Catalog Number	Terminals	Hub	Meter Form	Connectors CU	Bypass	Dimensions			Knockouts	
						D"	W"	H"	1	2
UC7442-RL	5	H.O.	3S	#14 - #4 Max	None	4½	12	20	1¼	¼, ½
UC7478-RL	6	H.O.	4S	#14 - #4 Max	None	4½	12	20	1¼	¼, ½
UC7444-RL	8	H.O.	5S	#14 - #4 Max	None	4½	12	20	1¼	¼, ½
UC7445-RL	13	H.O.	6, 8, 9 & (ALT) 10S	#14 - #4 Max	None	4½	12	20	1¼	¼, ½

2 Piece Cover | Overhead/Underground Service | with test switch provision*

Ringless Catalog Number	Ring Type Catalog Number	Terminals	Hub	Connectors CU	Bypass	Dimensions			Knockouts	
						D"	W"	H"	1	2
UC7446-RL	UC7450-RL	5	H.O.	#14 - #4 Max	None	4½	12	20	1¼	¼, ½
UC7532-RL	UC7636-RL	6	H.O.	#14 - #4 Max	None	4½	12	20	1¼	¼, ½
UC7448-RL	UC7460-RL	8	H.O.	#14 - #4 Max	None	4½	12	20	1¼	¼, ½
UC7449-RL	UC7461-RL	13	H.O.	#14 - #4 Max	None	4½	12	20	1¼	¼, ½

Notes

- **Hubs:** For proper hub selection see the hub suffix chart on the accessory page.
- **Sealing Rings:** Ring type units are supplied with one MR-2, snap type, sealing ring.
- **Prewiring:** If standard factory prewiring is required, refer to wiring diagrams in the general engineering section of this catalog. Determine appropriate diagram and send copy with order. If custom factory prewiring is required, specify on order. Be sure to include meter socket catalog number, test switch model and number, and meter form number. Please be sure to provide a copy of your wiring diagram.
- **Connectors:** Units are supplied with mechanical type connectors (#4 max). If compression type connectors (#10) are preferred, change catalog prefix to "S" (i.e. UC7445-XL becomes S7445-XL). The "S" prefix also designates non-U/L.
- ***Test Switch Cover:** Units on this page are not designed for use with test switch covers.

Please consult serving utility for their requirements prior to ordering or installing, as specifications and approvals vary by utility, and may require local electrical inspector approval. All installations must be installed by a licensed electrician and must comply with all national and local codes, laws and regulations. Milbank reserves the right to make changes in specifications and features shown without notice or obligation.





UC3423-XL

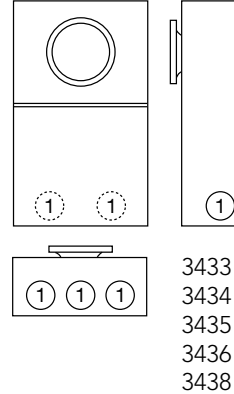
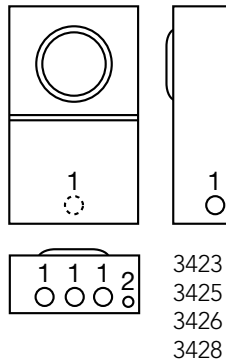

UC3428-XL

1 Piece Cover | Ringless | with test switch provision

Catalog Number	Terminals	Hub	Service	Connectors CU	Bypass	Dimensions			Knockouts	
						D"	W"	H"	1	2
UC3425-XL	5	C.P.	OH/UG	#14 - #4 Max	None	5½	12	20	1¼	¼, ½
UC3426-XL	6	C.P.	OH/UG	#14 - #4 Max	None	5½	12	20	1¼	¼, ½
UC3428-XL	8	C.P.	OH/UG	#14 - #4 Max	None	5½	12	20	1¼	¼, ½
UC3423-XL	13	C.P.	OH/UG	#14 - #4 Max	None	5½	12	20	1¼	¼, ½

2 Piece Cover | Ring Type | with test switch provision

Ringless Catalog Number	Terminals	Hub	Service	Connectors CU	Bypass	Dimensions			Knockouts
						D"	W"	H"	1
UC3435-XL	5	C.P.	OH/UG	#14 - #4 Max	None	5½	12	20	2
UC3436-XL	6	C.P.	OH/UG	#14 - #4 Max	None	5½	12	20	2
UC3438-XL	8	C.P.	OH/UG	#14 - #4 Max	None	5½	12	20	2
UC3433-XL	13	C.P.	OH/UG	#14 - #4 Max	None	5½	12	20	2
UC3434-XL	15	C.P.	OH/UG	#14 - #4 Max	None	5½	12	20	2

Notes

- **Sealing Rings:** Ring type units are supplied with one **MR-4**, snap type, sealing ring.
- **Prewiring:** If standard factory prewiring is required, refer to wiring diagrams in the general engineering section of this catalog. Determine appropriate diagram and send copy with order. If custom factory prewiring is required, specify on order. Be sure to include meter socket catalog number, test switch model and number, and meter form number. Please be sure to provide a copy of your wiring diagram.
- **Connectors:** Units are supplied with mechanical type connectors (#4 max). If compression type connectors (#10) are preferred, change catalog prefix to "S" (i.e. **UC3434-XL** becomes **S3434-XL**). The "S" prefix also designates non-U/L.
- **Test Switch Cover:** Units on this page can be used with clear lexan cover. See accessories page for ordering information.



Please consult serving utility for their requirements prior to ordering or installing, as specifications and approvals vary by utility, and may require local electrical inspector approval. All installations must be installed by a licensed electrician and must comply with all national and local codes, laws and regulations. Milbank reserves the right to make changes in specifications and features shown without notice or obligation.

Transformer Rated

20 Amp | 5, 6, 8, & 13 Terminal | Test Switch Provision |
600 VAC

59
TRANSFORMER
RATED



UC7445-XL

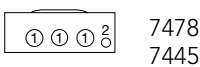
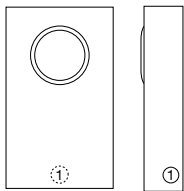

SC6128-XL

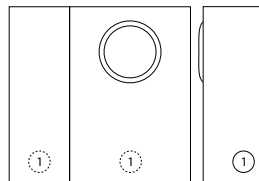

SC6129-O

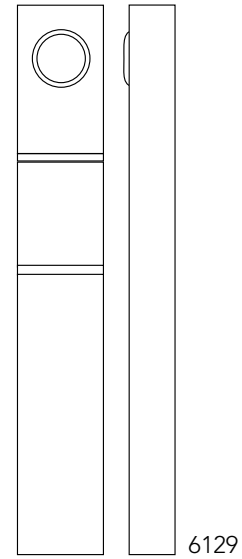

1 Piece Cover | Ringless | Pre-Wired

Catalog Number	Terminals	Hub	Service	Connectors CU	Bypass	Dimensions			Knockouts	
						D"	W"	H"	1	2
UC7478-RL-WC-271	5	C.P.	OH/UG	#14 - #4 Max	None	5½	12	20	1¼	¼, ½
U7445-RL-WC-951	6	C.P.	OH/UG	#14 - #4 Max	None	5½	12	20	1¼	¼, ½
UC7445-XL-371	8	C.P.	OH/UG	#14 - #4 Max	None	5½	12	20	1¼	¼, ½

2 Piece Cover | Ringless | with test switch provision | Non UL

Ringless Catalog Number	Terminals	Hub	Service	Connectors CU	Bypass	Dimensions			Knockouts
						D"	W"	H"	1
SC6128-XL	13	C.P.	OH/UG	#14 - #4 Max	None	4¾	20	22	1¼

Pedestal | Ringless | with test switch provision | Non UL

Ringless Catalog Number	Terminals	Service	Connectors CU	Bypass	Dimensions		
					D"	W"	H"
SC6129-O	13	UG	#14 - #4 Max	None	4¾	12	84

Notes

- **Prewiring:** If standard factory prewiring is required, refer to wiring diagrams in the general engineering section of this catalog. Determine appropriate diagram and send copy with order. If custom factory prewiring is required, specify on order. Be sure to include meter socket catalog number, test switch model and number, and meter form number. Please be sure to provide a copy of your wiring diagram.
- **Connectors:** Units are supplied with mechanical type connectors (#4 max). If compression type connectors (#10) are preferred, change catalog prefix to "S" (i.e. **UC7445-XL** becomes **S7445-XL**). The "S" prefix also designates non-UL listing.
- **Test Switch Cover:** Units on this page can be used with clear lexan cover. See accessories page for ordering information.

Please consult serving utility for their requirements prior to ordering or installing, as specifications and approvals vary by utility, and may require local electrical inspector approval. All installations must be installed by a licensed electrician and must comply with all national and local codes, laws and regulations. Milbank reserves the right to make changes in specifications and features shown without notice or obligation.



Catalog Number	Single 350 kcmil	Twin 350 kcmil	Twin 350 kcmil (Anti-Rotation)	Single 600 kcmil	Twin 600 kcmil (Anti-Rotation)	Twin 600 kcmil
S2068-O	K1539					
U1079-R	K1539	K1350		K1540		
U1129-O	K1539		K1350L		K1340L	
U1252-X	K1539	K1350		K1540		K1541
U1253-X	K1539	K1350		K1540		K1541
U1254-X	K1539	K1350		K1540		K1541
U1255-X	K1539	K1350		K1540		K1541
U1256-X	K1539	K1350		K1540		K1541
U1748-O-5T9-WI	K1539			K1540		
U1797-O-STU-STU	K1539		K1350L		K1340L	
U2120-X	K3082	K3442		K3441		
U2448-X	K1539	K1350		K1540		K1541
U2569-O	K1539					
U2594-X	K3082	K3442		K3441L		
U2732-XT	K3082	K3442		K3441		K3083
U2733-XT	K3082	K3442		K3441		K3083
U2734-XT	K3082	K3442		K3441		K3083
U2735-XT	K3082	K3442		K3441		K3083
U2736-XT	K3082	K3442		K3441		K3083
U2852-X	K1539	K1350				
U2853-X	K1539	K1350				
U2854-X	K1539	K1350				
U2855-X	K1539	K1350				
U2856-X	K1539	K1350				
U2862-X	K1539	K1350				
U2863-X	K1539	K1350				
U2864-X		K1350				
U2865-X						K1541
U2866-X				K1540		K1541
U2872-XT-5T9	K1539	K1350		K1540		K1541
U2873-XT-5T9	K1539	K1350		K1540		K1541
U2874-XT-5T9	K1539	K1350		K1540		K1541
U2875-XT-5T9	K1539	K1350		K1540		K1541
U2876-XT-5T9	K1539	K1350		K1540		K1541
U2986-O	K1539					
U3849-O-2/200	K1539			K1540		
U4031-O-2/200-5T9	K1539	K1350		K1540		
U4210-XL	K1539	K1350				
U4702-X	K1539	K1350		K1540*		
U4911-X-BL	K3082	K3442		K3441		
U5059-X-2/200-5T9				K1540	K1540L	
U9761-RRL	K3082			K3441		
U9865-RRL	K1539			K1540*		



Please consult serving utility for their requirements prior to ordering or installing, as specifications and approvals vary by utility, and may require local electrical inspector approval. All installations must be installed by a licensed electrician and must comply with all national and local codes, laws and regulations. Milbank reserves the right to make changes in specifications and features shown without notice or obligation.

Terminal Box

100, 200 & 400 Amp | 120/240 VAC



U4540-XL

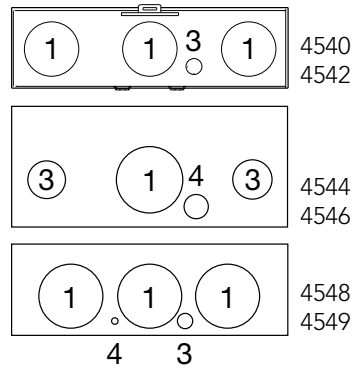
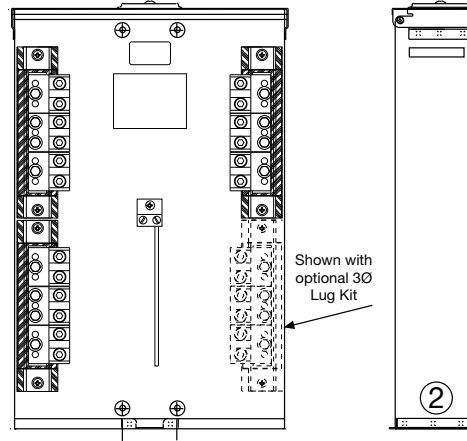

Terminal Boxes 1Ø and 3Ø 120/240 VAC

Catalog Number	Amp	Phase	Volts	Hub	Connectors CU7AL	1Ø to 3Ø Kit	Dimensions			Knockouts			
							D"	W"	H"	1	2	3	4
U4544-XL	100	1	120/240	C.P.	(6) #12-1/0	K4543	4 $\frac{1}{8}$	9 $\frac{13}{16}$	18	2	1	¼, ½	—
U4546-XL	100	3	600	C.P.	(6) #12-1/0	N/A	4 $\frac{1}{8}$	9 $\frac{13}{16}$	18	2	1	¼, ½	—
U4540-XL	200	1	120/240	C.P.	(6) #6-350	K4539	4 $\frac{1}{8}$	14 $\frac{13}{16}$	23	2½	2½	¼	¼, ½
U4542-XL	200	3	600	C.P.	(6) #6-350	N/A	4 $\frac{1}{8}$	14 $\frac{13}{16}$	23	2½	2½	¼	¼, ½
U4548-RXL	400	1	120/240	C.P.	(3) #6-350 or (2) #4-600	K4547	5	15½	27	3	3	¼, ½	¼
U4549-RXL	400	3	600	C.P.	(3) #6-350 or (2) #4-600	N/A	5	15½	27	3	3	¼, ½	¼

Notes

- **Hub:** Standard hub opening on top with closing plate attached.
- **Features:** UL listed pad lockable Type 3R enclosure.
- **3Ø 120/240V Application:** Field-installable 3Ø lug kit converts 1Ø unit to 3Ø unit.

Please consult serving utility for their requirements prior to ordering or installing, as specifications and approvals vary by utility, and may require local electrical inspector approval. All installations must be installed by a licensed electrician and must comply with all national and local codes, laws and regulations. Milbank reserves the right to make changes in specifications and features shown without notice or obligation.



62

MULTI-POSITION
TAP BOX

Multi-Position Tap Box

Three Phase | Aluminum Construction | Wall or Pad Mountable



Features

- **Painted Aluminum Construction:** Enclosure shells are constructed with lightweight aluminum, making wall-mount installations easier. Powder-coat paint finish helps prevent corrosion.
- **Capable of Wall or Pad Mounting:** Units feature a removable bottom, allowing an easy conversion from a wall-mount to a pad-mount.
- **Smaller Footprint:** The **UAP6094** model has a more compact footprint compared with the leading competitor.
- **Multi-port ground lugs**
- **Optional Pentabolt Secured Handle available** (see pics below): Enclosure handle can be included with an optional pentabolt locking mechanism (see photos below) for enhanced protection.



Common Applications



Apartment Buildings



Strip Malls



Housing Developments

Catalog Number	Phase	Position Lugs	Maximum Wire Size	Maximum Amperage	Dimensions		
					D"	W"	H"
UAP6094-O	3	16	500 kcmil	3000 Amps	16	25 $\frac{5}{8}$	43
UAP6095-O	3	22	500 kcmil	4000 Amps	16	32 $\frac{3}{8}$	43
UAP6096-O	3	14	750 kcmil	3300 Amps	16	25 $\frac{15}{16}$	51

Stainless steel pad mount spacing brackets included



Please consult serving utility for their requirements prior to ordering or installing, as specifications and approvals vary by utility, and may require local electrical inspector approval. All installations must be installed by a licensed electrician and must comply with all national and local codes, laws and regulations. Milbank reserves the right to make changes in specifications and features shown without notice or obligation.

Commercial Pedestals

Attractive | Easy to Install | Secure | Cost-Effective

Milbank Commercial Pedestals are pad-mounted, weather resistant electrical enclosures consisting of a utility pull section with optional meter socket, and a customer section containing distribution and control equipment. Milbank Commercial Pedestals are an attractive, secure, easy to install and cost-effective solution when underground remote site power distribution and control equipment is required, replacing unsightly and inefficient strut and backboard structures.



Strut and backboard



Commercial pedestal

UL Listed as Industrial Control Equipment (File E113855)

Standard Features

- Type 3R rain-resistant, vandal-resistant cabinet of polyurethane powder coated steel (aluminum or stainless steel also available)
- UL listed as enclosed industrial control equipment (UL508)
- Isolated lockable and sealable utility metering and lug landing sections
- Lockable customer section for distribution and control equipment with internal deadfront
- Print pocket inside customer section door contains wiring schematics and installation instructions
- Most load centers are UL listed for use with various manufacturers' circuit breakers
- All stainless steel external hardware (screws, bolts, hinges, handles, hasps and sealing screws)

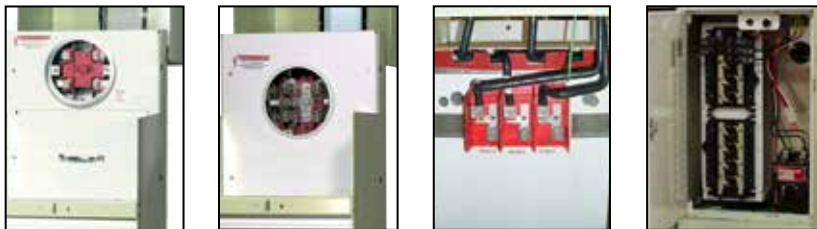

Please consult serving utility for their requirements prior to ordering or installing, as specifications and approvals vary by utility, and may require local electrical inspector approval. All installations must be installed by a licensed electrician and must comply with all national and local codes, laws and regulations. Milbank reserves the right to make changes in specifications and features shown without notice or obligation.



Attractive | Easy to Install | Secure | Cost-Effective



Applications

These units are ideal for controlling and metering:

- Traffic signals
- Street lighting
- Power distribution for EV charging stations
- Irrigation and sprinkler systems
- Cell towers and telephone vaults
- Pump stations
- Temporary power for fairgrounds, swap meets, outdoor markets, portable offices, holiday lights, etc.
- Outdoor lighting for athletic fields, tennis and basketball courts, parking lots, landscaping and subdivision entrances, etc.

Available Factory-Installed Options

- Meter sockets: ring type or ringless, up to 400 amp
- Main and branch breakers or T fuses
- Distribution: copper load centers and panel boards
- Clocks, timers and relays
- Photoelectric cells and controls
- Power receptacles: pin and sleeve, twist lock or straight blade
- Contactors: definite purpose, electrical or mechanically held, IEC and mercury types
- Surge protection and lightning arrestors
- Reserve inlet generator receptacle with interlocked circuit breakers
- Motor starters and relays
- Push button controls
- Thermostat controls, fans and heating strips
- Power blocks and terminal blocks
- Steel, aluminum and plywood backboards
- Transformers
- Interlock devices for circuit breakers
- Available in steel, aluminum (raw painted or anodized) or stainless steel construction with powder coated finish available in eight standard colors or special-ordered RAL colors
- Available for applications up to 400 amp, 120V, 208V, 240V, 277V, 480V - 1Ø or 3Ø

Accessories



K3865
Fifth terminal kit for use with ringless meter sockets

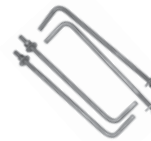

CP-ABK5/8
Anchor bolt kit (includes four 5/8 - 13 x 18" anchor bolts)



105J
Fifth terminal kit for use with ring-type meter sockets



CP-TC7D
7-day time clock kit
CP-TC24H
24-hour time clock kit
CP-TCWIRE
Male 4-pin connector and wiring harness for use with time clocks other than above



CP-PE-HOA-3POS
HOA switch for field installation



CP-16PDMNT-CALT
16" pedestal mounting base
CP-24PDMNT-CALT
24" pedestal mounting base (includes mounting hardware)



Please consult serving utility for their requirements prior to ordering or installing, as specifications and approvals vary by utility, and may require local electrical inspector approval. All installations must be installed by a licensed electrician and must comply with all national and local codes, laws and regulations. Milbank reserves the right to make changes in specifications and features shown without notice or obligation.

Commercial Pedestals

Main Load Center Series | Custom Designs Available

CP3B "ML" Series

Main Load Center Series

1Ø3 wire 120/240V or 208Y/120V

Application: remote site service for multiple loads

Milbank Main Load Center Commercial Pedestals are designed to handle the vast majority of all requirements in a standard, stocked configuration.

- All units feature a load center with a plug-on, back-fed main breaker.
- Load center has 16 positions for the 100 amp pedestals and 24 circuits for the 200 amp pedestals.
- Both sizes include sub-feed lugs to allow feeding an external panel.

If your application requires turning loads on based on "dusk-to-dawn" requirements, be sure to see the Milbank Switched Load Center Commercial Pedestal products on the following page.

Features

These units include everything required for remote site service:

- NEMA 3R construction.
- Expandable: load centers allow for future expansion without costly modifications.
- All units feature 200 amp meter socket with optional field-installable fifth terminal kit available.
- 22K amp interrupting capacity (AIC) standard.
- Optional mounting base can be embedded in concrete for fast, easy installation.
- Separate sealable and lockable utility termination section.
- Separate sealable and lockable metering section.
- Separate sealable and lockable customer section with a load center for "always on" loads that include a main circuit breaker, 20 (125 or 200 amp model) or 14 (100 amp model) blank breaker spaces and a circuit directory to document configuration.



Typical Applications

Remote site service for multiple loads.

Standard Pedestals	Optional Fifth Terminal Kit	Main CB		Load Center Circuits	Meter Socket Type
		Amp	Spaces		
CP3B11115A22	105J	100	1,2	16	Ring type with test/bypass blocks
CP3B12119A22	105J	200	1,2,3,4	24	Ring type with test/bypass blocks
CP3B51115A22	K3865	100	1,2	16	Ringless socket with lever bypass
CP3B52119A22	K3865	200	1,2,3,4	24	Ringless socket with lever bypass

Notes

- Chart shows standard, stocked items. Other options and features are available. Contact factory for options, details and availability.
- May require customization based on regional requirements

Please consult serving utility for their requirements prior to ordering or installing, as specifications and approvals vary by utility, and may require local electrical inspector approval. All installations must be installed by a licensed electrician and must comply with all national and local codes, laws and regulations. Milbank reserves the right to make changes in specifications and features shown without notice or obligation.



CP3B "SL" Series

Switched Load Center Series
1Ø3 wire 120/240V or 208Y/120V

Milbank Switched Load Center Commercial Pedestals are designed not only to provide power for various loads, but also to switch specific loads on and off under certain conditions. A photoelectric cell is used for these controlled loads, and an optional time clock is also available.

Features

These units include everything required for remote site service:

- NEMA 3R construction.
- Expandable: load centers allow for future expansion without costly modifications.
- All units feature 200 amp meter socket with optional field-installable fifth terminal kit available.
- 22K amp interrupting capacity (AIC) standard.
- Optional mounting base can be embedded in concrete for fast, easy installation.
- Separate sealable and lockable utility termination section.
- Separate sealable and lockable metering section.
- Separate sealable and lockable customer section with a control circuit including PE receptacle, Lexan® window, glare shield, Hand-Off-Auto (HOA) switch, contractor controlling a 16-circuit load center for controlled loads, a pre-mounted DIN rail and pre-wired connector to add an optional "plug-and-play" time clock kit for PE on and TC off operation and a circuit directory to document configuration.
- A load center for "always on" loads that includes a main circuit breaker, a control power circuit breaker, a switched load center main breaker, nine (125 or 200 amp model) or 11 (100 amp model) blank breaker spaces and a circuit directory to document configuration.



Typical Applications

Traffic signals, parking lots, highways & athletic field lighting

Standard Pedestals	Optional Fifth Terminal Kit	Main CB		Contactor Amperage	Meter Socket Type
		Amp	Spaces		
CP3B11110A22SL1	105J	100	1,3	60	Ring type with test/bypass blocks
CP3B12110A22SL1	105J	200	1,2,3,4	100	Ring type with test/bypass blocks
CP3B51110A22SL1	K3865	100	1,3	60	Ringless socket with lever bypass
CP3B52110A22SL1	K3865	200	1,2,3,4	100	Ringless socket with lever bypass

Notes

- Chart shows standard, stocked items. Other options and features are available. Contact factory for options, details and availability.
- May require customization based on regional requirements



Please consult serving utility for their requirements prior to ordering or installing, as specifications and approvals vary by utility, and may require local electrical inspector approval. All installations must be installed by a licensed electrician and must comply with all national and local codes, laws and regulations. Milbank reserves the right to make changes in specifications and features shown without notice or obligation.

Commercial Pedestals

CP3B "400" 400 Amp Series



Milbank 400 Amp Commercial Pedestals are designed to provide a weather and vandal resistant metered enclosure for various loads and distribution. Each pedestal has been designed to handle a wide range of applications using standard, stocked configurations.

- Choice of a single main breaker or twin service disconnect breakers gives flexibility to the pedestal design.
- Optional distribution with feed-through lugs below the service disconnect breakers allows the pedestal to handle numerous applications.
- Typical applications include remote homes where the metering is best located at the curb side or other remote area. The pedestal can also provide power to secondary residence, on-site business, workshop, irrigation, lighting, security or other secondary load.
- Available in custom colors to match home or landscaping.

Features

These units include everything required for remote service:

- Type 3R construction
- Main circuit breaker or dual service disconnects
- Expandable: load center units allow for future expansion without costly modifications
- Optional mounting base can be embedded in concrete for fast, easy installation
- Separate sealable and lockable utility termination section with lug termination
- Separate sealable and lockable metering section
- A separate sealable and lockable customer section with a circuit directory and a print pocket to hold all documentation
- Meter socket options include ring type with bypass studs, ringless with heavy duty lever bypass, or K-Type bolt-on

Typical Applications

Remote site service for residential and commercial job sites

Standard Pedestals	Optional fifth Terminal Kit	Main CB	Load Center Circuits	Meter Socket Type
CP3B1411JB	N/A	320 amp (400 max)	0	Ring-type with test/bypass studs
CP3B14120B	N/A	2-200 amp	(2) 12 circuit ¹	Ring-type with test/bypass studs
CP3B54120B22	K3865	2-200 amp	(2) 12 circuit ¹	Ringless with lever bypass
CP3B5411JB22	K3865	320 amp (400 max)	0	Ringless with lever bypass

Notes

- Chart shows standard, stocked items. Other options and features are available. Contact factory for options, details and availability.
- Stud utility landing is standard. Lug kits are available from factory.
- Units with load centers have (2) #6-250 sub-feed lugs on each load center. (Each load center is 200 amp rated and UL listed with: Siemens, General Electric and Cutler-Hammer plug-in style circuit breakers.)
- May require customization based on regional requirements

Please consult serving utility for their requirements prior to ordering or installing, as specifications and approvals vary by utility, and may require local electrical inspector approval. All installations must be installed by a licensed electrician and must comply with all national and local codes, laws and regulations. Milbank reserves the right to make changes in specifications and features shown without notice or obligation.



Commercial Pedestals

CP3B "IR" Irrigation Control Series



Milbank "IR" Series irrigation pedestals install quickly and simply – often in less than an hour with a single technician—a fraction of the time typically needed for strut farm and other installation set ups. Additionally, the pedestal comes pre-wired, so the technician simply drops in the pre-drilled concrete box pad, fastens the pedestal and runs the wires. Prewired landing lugs are provided in a separate utility side so that there is no more need to wrestle with hard-to-bend wires. Simply run the utility wire up and land on the lugs. With both the motor starter and disconnect in the same enclosure, all the controls are housed in a safe, lockable pedestal that protects against vandalism and energy theft.

Features

- 3Ø4W, 480Y/277 volt
- One technician can install in under an hour with use of Milbank’s pre-drilled box pad
- All units are UL listed and service entrance rated
- Fused disconnect with accessible handle through the deadfront
- HOA and push button start
- Separate accessible utility side with pre-wired landing lugs
- NEMA rated starters (sizes 1-5)
- Soft start units sizes 30HP-150HP
- 30 amp fuse block for pivot pre-wired in the unit
- White powder coated paint finish helps keep components cooler
 - Options include:
 - Hour meter
 - Chemical injection receptacle
 - Multiple injection receptacle
 - Multiple 30 amp fuse blocks possible

Typical Applications

Power pedestal for irrigation systems or other pump control applications

Standard Pedestals	Exterior Cabinet	NEMA Rating
CP3B0281UMWIR04	White	4
CP3B0281UMWIR03	White	3
CP3B0181UMWIR02	White	2

Notes

- Chart shows standard, stocked items. Other options and features are available. Contact factory for options, details and availability.
- May require customization based on regional requirements



Please consult serving utility for their requirements prior to ordering or installing, as specifications and approvals vary by utility, and may require local electrical inspector approval. All installations must be installed by a licensed electrician and must comply with all national and local codes, laws and regulations. Milbank reserves the right to make changes in specifications and features shown without notice or obligation.

Commercial Pedestals

CP3B "BBS" Battery Backup Series



Milbank BBS Series Commercial Pedestals are designed to provide battery backup power for various loads, and to switch specific loads on and off under certain conditions; a photoelectric cell or time clock to control lighting circuits, as an example. Metered and unmetered power distribution options are available. The back-up power pedestal is designed to handle the vast majority of today's back-up power requirements. By using 19" rack design, shelves can be adjusted to accommodate the required batteries and manufactures DC to AC inverters, transfer switches and other related equipment. This design gives the user a wide range of design and configuration options. Complete turnkey, ready to power-up pedestals are offered along with basic units ready to accept batteries and inverters supplied by others.

Features

- Type 3R construction
- 100 through 320 amp meter socket with the option of either a ring type socket (conforms to EUSERC 308) with or without test/bypass blocks or a heavy duty ringless socket with lever bypass
- Separate sealable utility termination compartment
- An isolated separate customer section with service disconnects, power distribution options and power control
- 19" wide rack in customer compartment for easy layout of equipment
- Battery trays
- Thermostat with cooling fan
- Filtered louvers for heat rise flow through ventilation
- Three point door latch (key or pad lockable)

Typical Applications

Metered emergency uninterrupted power for traffic intersections, wireless, phone and communications equipment, parking lots, camera and security locations

Note

- May require customization based on regional requirements

Options

- Manual bypass switch
- Transfer switch for generator power back-up
- Generator inlet receptacles 30 amp through 200 amp
- Pad lockable provision for receptacles
- Police access door
- Metered load center distribution
- Unmetered load center distribution
- Photo electric controls (for street lighting)
- Time clocks
- HOA switches
- Contactors
- GFI duplex receptacles
- Thermostat for heating control
- Heating pads or elements
- Roll out shelves for batteries
- Surge arrestors and lighting arrestors

Please consult serving utility for their requirements prior to ordering or installing, as specifications and approvals vary by utility, and may require local electrical inspector approval. All installations must be installed by a licensed electrician and must comply with all national and local codes, laws and regulations. Milbank reserves the right to make changes in specifications and features shown without notice or obligation.



Commercial Pedestals

CP3B "Power Transfer" Series



Milbank Power Transfer Series Pedestals provide unmetered AC power, distribution, surge suppression, mechanical interlock and stand-by generator receptacle — all in a neat, compact pedestal.

Features

- 120/240V 1Ø3W through 277/480V 3Ø4W ratings
- Metered or unmetered units
- Choice of EUSERC ring type or ringless meter sockets
- 60 amp through 400 amp ratings
- UL listed, Type 3R rated
- Pad lockable, isolated utility compartments
- 20 amp GFI convenience receptacle
- Lockable recessed generator receptacle door
- Utility and generator indicator light options
- All stainless steel hardware
- Galvanized steel, aluminum or stainless steel cabinet options
- Custom designs available

Note

- May require customization based on regional requirements



Typical Applications

Traffic intersections, cell sites, cable TV, pump and lift stations requiring utility power with backup generator power

Commercial Pedestals

CP3B "CT Metered" Series



Milbank CT Metered Series Commercial Pedestals are designed to be used where a smaller service package would be a better choice over large 3R rated combination switchboards. These pedestals have amperage ratings of 400 to 800 amp at voltages up through 480 volt three phase.

Features

- UL listed, freestanding Type 3R service
- Up to 800 amp
- A low profile CT pedestal
- All utility equipment is isolated in separated pad lockable and sealable compartments
- Separate customer compartment designed to hold distribution and control equipment
- Dead front customer construction
- Optional mounting base
- Optional construction in steel, aluminum and stainless steel.
- Wide choice of powder paint colors

Note

- May require customization based on regional requirements

Typical Applications

Large homes, pumping & lift stations, motor control, water treatment plants, EV charging stations, commercial buildings, large remote service requirements, commercial and industrial control systems

Please consult serving utility for their requirements prior to ordering or installing, as specifications and approvals vary by utility, and may require local electrical inspector approval. All installations must be installed by a licensed electrician and must comply with all national and local codes, laws and regulations. Milbank reserves the right to make changes in specifications and features shown without notice or obligation.





Milbank Slimline Series Commercial Pedestals provide a sleeker, smaller footprint, with wireway access on the side of the unit rather than the back, allowing maximum flexibility to place the pedestal in tighter spaces.

Features

- UL listed as service equipment
- 100 or 200 amp
- Vandal-resistant, secure and attractive design
- Customer compartment with distribution and control equipment with swing dead front door, secured with both a hasp/latch and draw latch outer door
- Utility metering compartment protected with a hinged hood, increasing resistance to meter vandalism
- Small footprint
- Wireway located on left side of pedestal for utility incoming wire, allowing pedestal to be mounted with back as close as 14" to walls or structures
- Available in 12" and 20" widths and 50" and 63" (metered) and 43" (unmetered) heights
- Includes a print pocket for plans and drawings
- Voltage range: 120V–480V
- Compatible with both ringless and ring type meter sockets, 4–7 terminals
- Available in a wide array of colors, including but not limited too all ANSI powder coated paint colors upon request
- Pedestal mounting base option saves time and labor to install on a cement pad—no anchor bolts required
- Powder coated G90 galvanized steel or Aluminum; raw, anodized or powder coated, as well as stainless steel exterior options

Note

- May require customization based on regional requirements

Typical Applications

Roadway lighting and signage, wastewater treatment facilities, parks and landscaping, and any application where physical space is at a premium



"Slimline" Series Direct Bury Extension

- No need for concrete
- Bolts directly to unit
- Easy, modular design
- Ships in a smaller package
- Increases project flexibility
- Easier to handle and install
- Utilizes stabilizer feet to prevent leaning over time
- Pedestal and extension can be installed within 45 minutes

Notes

- 14 gauge steel
- Only available for 12" pedestals



Please consult serving utility for their requirements prior to ordering or installing, as specifications and approvals vary by utility, and may require local electrical inspector approval. All installations must be installed by a licensed electrician and must comply with all national and local codes, laws and regulations. Milbank reserves the right to make changes in specifications and features shown without notice or obligation.

Circuit Breakers

QP (small frame) & QN (large frame) Series

15-70 Amp Breaker Plug-In Type — 1" Per Pole

Amp	Poles	10K AIC Plug-In	22K AIC Plug-In
15	Single	Q115	Q115H
15	Double	Q215	Q215H
20	Single	Q120	Q120H
20	Double	Q220	Q220H
25	Single	Q125	Q125H
25	Double	Q225	Q225H
30	Single	Q130	Q130H
30	Double	Q230	Q230H
35	Single	Q135	Q135H
35	Double	Q235	Q235H
40	Single	Q140	Q140H
40	Double	Q240	Q240H
50	Single	Q150	Q150H
50	Double	Q250	Q250H
60	Single	Q160	Q160H
60	Double	Q260	Q260H
70	Single	Q170	Q170H
70	Double	Q270	Q270H
80	Double	Q280	Q280H
90	Double	Q290	Q290H
100	Double	Q2100	Q2100H
125	Double	Q2125	Q2125H



QN2200H



QN2200RH



Q250

200 Amp Frame | Plug-In | 10,000 AIC & 22,000 AIC — Two-Pole - Common Trip

Amp	10K AIC Plug-In	22K AIC Plug-In	Handle Location	Wire Range	
				CU	AL
150	QN2150	QN2150H	Left facing	#4-300	#4-300
200	QN2200	QN2200H	Left facing	#4-300	#4-300
150	QN2150R	QN2150RH	Right facing	#4-300	#4-300
200	QN2200R	QN2200RH	Right facing	#4-300	#4-300

Notes

- Load connectors supplied with breakers.
- UL listed for use with 60°C or 75°C wire.
- Wire sizes shown are lug capacity. Consult NEC Article #310 for specific wire sizes.

Please consult serving utility for their requirements prior to ordering or installing, as specifications and approvals vary by utility, and may require local electrical inspector approval. All installations must be installed by a licensed electrician and must comply with all national and local codes, laws and regulations. Milbank reserves the right to make changes in specifications and features shown without notice or obligation.



UQFP Plug-In Series & UQFB Bolt-On Series

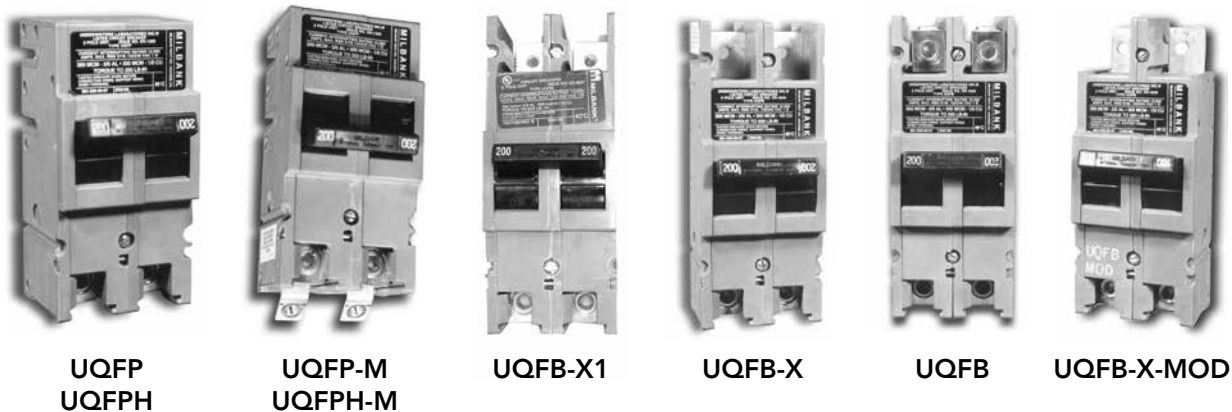

200 Amp Frame | Plug-In | 10,000 AIC & 22,000 AIC | Two-Pole - Common Trip

Amp	10K AIC Plug-In	22K AIC Plug-In	10K AIC Plug-In	22K AIC Plug-In	Wire Range	
					CU	AL
100	UQFP-100	UQFPH-100	UQFP-M-100	UQFPH-M-100	#3-#1	#1-1/0
125	UQFP-125	UQFPH-125	UQFP-M-125	UQFPH-M-125	#3-#1	#1-1/0
150	UQFP-150	UQFPH-150	UQFP-M-150	UQFPH-M-150	1/0-300	2/0-300
175	UQFP-175	UQFPH-175	UQFP-M-175	UQFPH-M-175	1/0-300	2/0-300
200	UQFP-200	UQFPH-200	UQFP-M-200	UQFPH-M-200	1/0-300	2/0-300

200 Amp Frame | Bolt-On | 10,000 AIC & 22,000 AIC | Two-Pole - Common Trip

Amp	10K AIC Bolt-On	22K AIC Bolt-On	10K AIC Bolt-On	22K AIC Bolt-On	Wire Range	
					CU	AL
100	UQFB-100	UQFBH-100	UQFB-100-X1	UQFPH-M-100	#3-#1	#1-1/0
125	UQFB-125	UQFBH-125	UQFB-125-X1	UQFPH-M-125	#3-#1	#1-1/0
150	UQFB-150	UQFBH-150	UQFB-150-X1	UQFPH-M-150	1/0-300	2/0-300
175	UQFB-175	UQFBH-175	UQFB-175-X1	UQFPH-M-175	1/0-300	2/0-300
200	UQFB-200	UQFBH-200	UQFB-200-X1	UQFPH-M-200	1/0-300	2/0-300

Notes

- UL listed: For use with 60°C or 75°C wire.
- UQFP: For parallel main circuit breaker applications.
- UQFP-M: For series main circuit breaker applications Split load tab features allow for feed-through capability.
- UQFB: (2) 1/0-300 lugs provided on load and line side (cable-in, cable-out).
- UQFB3: Three-pole available. Consult factory.
- UQFB-X: (2) 1/0-300 lugs provided on load side and (2) line bar bus connections on line side.
- UQFB-M: For series main circuit breaker applications. Split load tab features allow for feed-through capability.
- UQFB-X-MOD: Replacement circuit breaker with line barriers removed.



Please consult serving utility for their requirements prior to ordering or installing, as specifications and approvals vary by utility, and may require local electrical inspector approval. All installations must be installed by a licensed electrician and must comply with all national and local codes, laws and regulations. Milbank reserves the right to make changes in specifications and features shown without notice or obligation.

Accessories

Hubs and Closing Plates

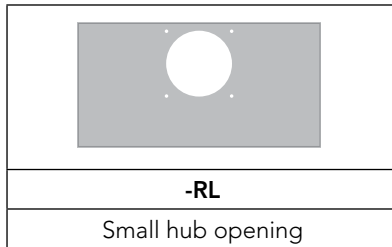

-WL	A7514	-YL	A7515	-ZL	A7516	-DL	A7517	-EL	A7518	-XL	A7551
1" hub		1¼" hub		1½" hub		2" hub		2½" hub		Small closing plate	

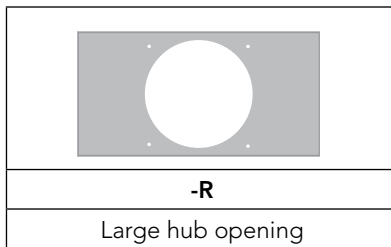

-F	A8110	-G	A8111	H	A8112	-X	A9064	-RRL	S8324
3" hub		3½" hub		4" hub		Large closing plate		Large hub opening adapted to small hub opening	

Please consult serving utility for their requirements prior to ordering or installing, as specifications and approvals vary by utility, and may require local electrical inspector approval. All installations must be installed by a licensed electrician and must comply with all national and local codes, laws and regulations. Milbank reserves the right to make changes in specifications and features shown without notice or obligation.



Connector Kits, Closing Kits and Sealing Rings

Connector Kits | For Use with 3/8"-16 Stud Type Units Only

Single			Twin		
Suffix	Part #	(3 per set) - 1Ø	Suffix	Part #	(3 per set) - 1Ø
K1	K1539	6-350	K2	K1350	6-350
K3	K1540	4-600 or (2) 1/0-250	K2L	K1350L	6-350 (non rotating)
K3L	K1540L	4-600 or (2) 1/0-250 (non rotating)	K4	K1541	4-600
Suffix	Part #	(4 per set) - 3Ø	Suffix	Part #	(4 per set) - 3Ø
K5	K3082	6-350	K6	K3442	6-350
K7	K3441	4-600 or (2) 1/0-250	K8	K3083	4-600

Bypass Link



K8180 (sold in pairs)

Closing Covers

Meter Closing Plate (Ring Type/Ringless)	Metal Closing Plate (For Ringless Sockets)
6003 - Grey Plastic	CP-21
6116 - Clear Plastic	

Generator Interlock

K5815 - large QN with small frame Q
K5820 - large frame QN with large frame QN
K5830 - small frame Q to small frame Q

Sealing Rings

MR-2 - Snap Action	MR-4 - Screw Type (Stainless Steel)
MR2-SS - Stainless Steel	

Touch-Up Paint





A-GP - Light Grey

Accessories

Fifth Terminals and Tap Connectors

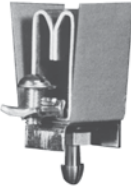
Fifth Terminals

		
5T8K2 - 100-200 Amp "Plug-In"	K5T - 200 Amp (Block with Square Hole)	K3865 - Heavy Duty Jaw Clamping (K3866 without Neutral Wire)

Tap Connectors (3 per set)

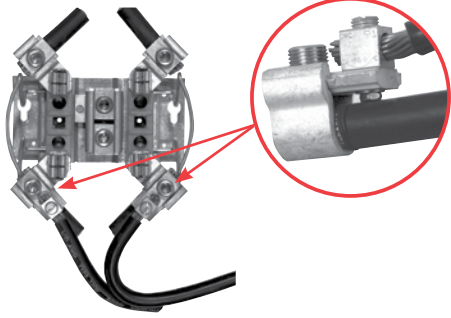
	Replaces the load or line side slide-in nut assembly on Milbank 200 amp sockets. Allows for a 100 amp tap location in addition to the #6-350 kcmil load-side connector. K5022 includes safety barrier extensions for applications over 300 VAC. Three lugs per kit.
K4977-INT - Internal Hex	
K4977-EXT - External Hex	
K5022-INT - Internal Hex (set of 4 w/ barrier)	

Triplex Ground

K1190 (For factory installed triplex ground, add suffix -TG to catalog number)

Isolated Neutral Kit

K1047*

Anti-Inversion Clip

K4802

Disconnect Sleeve

M5-144

*Isolated neutrals are specific to the meter socket. Consult factory for correct isolated neutral.

Please consult serving utility for their requirements prior to ordering or installing, as specifications and approvals vary by utility, and may require local electrical inspector approval. All installations must be installed by a licensed electrician and must comply with all national and local codes, laws and regulations. Milbank reserves the right to make changes in specifications and features shown without notice or obligation.



NEMA Commercial Enclosures

Milbank's line of commercial enclosures includes the full gamut of styles and sizes; everything from junction boxes to transformer cabinets, telephone cabinets to wireway.

Type 1 Enclosures

Milbank's Type 1 enclosures are designed for indoor use to provide a degree of protection to personnel against access to hazardous parts and to provide a degree of protection of the equipment inside the enclosure against ingress of solid foreign objects, such as falling dirt.

Type 3R Enclosures

Milbank's Type 3R enclosures are designed for either indoor or outdoor use to provide a degree of protection from harmful effects on the equipment due to the ingress of water (rain, sleet, snow) and that will be undamaged by the external formation of ice on the enclosure.

Wireway

Milbank's wide range of wireway is available in many styles and sizes and its wide range of fittings allows it to smoothly transition to and from competitors' products.

NEMA Industrial Enclosures

Milbank's line of industrial enclosures include junction boxes, wiring trough, push-button enclosures and modular enclosures. Milbank also excels in special designs; nearly any type, size or color of enclosure you need, we can make!

Type 12 Enclosures

Enclosures constructed without knockouts for indoor use to provide a degree of protection to personnel against access to hazardous parts, and protect components against falling dirt, circulating dust and lint, and dripping or splashing water.

Type 4 Enclosures

Enclosures constructed for either indoor or outdoor use to provide a degree of protection to personnel against access to hazardous parts; protect equipment against falling dirt and windblown dust; protect against rain, sleet, snow, splashing water, and hose directed water; and is resistant to damage by the external formation of ice on the enclosure.

Industrial Enclosure Specials

Milbank specializes in custom enclosure projects, offering an almost limitless amount of styles, options, colors and sizes. Milbank will meet your needs and specifications and deliver a custom enclosure that protects your crucial electric equipment.

Thermal Management

Protect components housed in enclosures from damage caused by overheating, freezing, humidity and condensation with these thermal management products.



Please consult serving utility for their requirements prior to ordering or installing, as specifications and approvals vary by utility, and may require local electrical inspector approval. All installations must be installed by a licensed electrician and must comply with all national and local codes, laws and regulations. Milbank reserves the right to make changes in specifications and features shown without notice or obligation.

Conduit, Ampacity & SCCR

Reference Information

MAXIMUM NUMBER OF CONDUCTORS IN CONDUIT

Table from 2008 NEC Code Reference: Rigid Metal Conduit

Type	Conductor Size (AWG/kcmil)	Conduit Trade Sizes (Inches)									
		1/2	3/4	1	1 1/4	1 1/2	2	2 1/2	3	3 1/2	4
THHN, THWN, THWN-2	12	9	16	26	46	62	102	146	225	301	387
	10	6	10	17	29	39	64	92	142	189	244
	8	3	6	9	16	22	37	53	82	109	140
	6	2	4	4	12	16	27	38	59	79	101
	4	1	2	4	7	10	16	23	36	48	62
	3	1	1	3	6	8	14	20	31	41	53
	2	1	1	3	5	7	11	19	26	34	44
	1	1	1	1	4	5	8	12	19	25	35
	1/0	1	1	1	3	4	7	10	16	21	27
	2/0	0	1	1	2	3	6	8	13	18	23
3/0	0	1	1	1	3	5	7	11	15	19	
4/0	0	1	1	1	2	4	6	9	12	16	
XHH, XHHW, XHHW-2	4	1	2	4	7	10	16	24	37	49	63
	2	1	1	3	5	7	12	17	26	35	45
	1/0	1	1	1	3	4	7	10	16	22	28
	2/0	0	1	1	2	3	6	9	13	18	23
	4/0	0	1	1	1	2	4	6	9	12	16
	250	0	0	1	1	1	3	5	7	10	13
	350	0	0	1	1	1	2	3	6	7	10
500	0	0	0	1	1	1	2	4	5	7	
750	0	0	0	0	1	1	1	3	4	5	

This table is for concentric stranded conductors only. For cables with compact conductors refer to NEC. Refer to latest NEC Code or Local Codes for updated requirements.

SAMPLE RATING LABEL

CATALOG NUMBERS U5952 & U5953
100A MAXIMUM, 120/240 VAC SINGLE PHASE, THREE WIRE
RAINFOOD NEMA TYPE 3R

SHORT CIRCUIT CURRENT RATING IS 10,000 RMS SYMMETRICAL AMPERE AT 240 VAC MAXIMUM, BUT IS LIMITED TO THE LOWEST SHORT CIRCUIT CURRENT RATING OF ANY INSTALLED CIRCUIT BREAKER. WATTHOUR METER NOT INCLUDED IN SHORT CIRCUIT CURRENT RATING. REPLACEMENT CIRCUIT BREAKER MUST BE THE SAME TYPE AND RATING. USE SIEMENS QP, QT; CUTLER-HAMMER QP, BD, BR; SQUARE D HOMELINE; G.E. TO, THQ, THQL

SUITABLE FOR USE AS RECREATIONAL VEHICLE SITE SUPPLY EQUIPMENT

UNDERGROUND FEED ONLY

ON TRIP OFF

TO RESET BREAKER MOVE TO "OFF" THEN TO "ON"

DANGER
HAZARD OF ELECTRICAL SHOCK OR BURN
TURN OFF POWER
SUPPLYING THIS EQUIPMENT BEFORE WORKING INSIDE

WIRE TERMINAL INFORMATION USE AL-CU CONDUCTORS

TERMINAL	WIRE RANGE	TORQUE LB-IN
LINE AND LINE NEUTRAL	350 KCMIL - #6	250
GROUND CONNECTOR	2/0 AWG - #14 AWG	120
LOAD NEUTRAL SLOTTED HEAD (LARGE HOLE)	14 - 10	35
	8	40
	6 - 4	45
LOAD NEUTRAL SLOTTED HEAD (SMALL HOLE)	14 - 10	20
	8	25
	6	35

SHIPPING TENDS TO LOOSEN BOLTED CONNECTIONS. CHECK AND TIGHTEN ALL HARDWARE BEFORE ENERGIZING UNIT

SIZE OF FIELD INSTALLED CONDUCTORS SHALL BE 60° OR 75°C SIZED TO 60°C RATING FOR 110 AMPS OR LESS AND 75°C SIZED TO 75°C FOR 125 AMPS AND ABOVE

* ALLOWABLE AMPACITIES OF INSULATED COPPER & ** ALUMINUM CONDUCTORS (3W IN CONDUIT) 75°C (167°F)

*CU		AL or **Cu-Clad AL	
A	B	A	C
18	-	-	-
16	-	-	-
14	20†	-	-
12	25†	12	20†
10	35†	10	30†
8	50	8	40
6	65	6	50
4	85	4	65
3	100	3	75
2	115	2	90
1	130	1	100
1/0	150	1/0	120
2/0	175	2/0	135
3/0	200	3/0	155
4/0	230	4/0	180
250	255	250	205
300	285	300	230
350	310	350	250
400	335	400	270
500	380	500	310
600	420	600	340
700	460	700	375
750	475	750	385

A = Size: AWG/MCM
*B = Ampere Rating for Insulation Types:
FEPW, RH, RHW, THW, THWN, XHHW, USE, 2W.
**C = Ampere Rating for Insulation Types:
RH, RHW, THW, THWN, XHHW, USE
(Per NEC table 310-16)

AMPACITY CORRECTION FACTORS

AMBIENT TEMP. C°	CORRECTION FACTOR	AMBIENT TEMP. F°
21 - 25	1.05	70 - 77
26 - 30	1.00	78 - 86
31 - 35	.94	87 - 95
36 - 40	.88	96 - 104
41 - 45	.82	105 - 113
46 - 50	.75	114 - 122
51 - 55	.67	123 - 131
56 - 60	.58	132 - 140
61 - 65	.33	141 - 158

Overall ampere ratings of U/L listed Milbank multiple position meter sockets are based on 2008 N.E.C. Handbook Article 220-84 and ANSI / UL-414 (except where restricted by line connector size.) These requirements provide for a diversity factor / demand factor being utilized in determining the overall (main bus / lug) rating of a gang socket. All Milbank U/L listed gang sockets meet or exceed these diversity factor/demand factor requirements. Standard overall ampacity ratings for U/L listed and non U/L listed gang sockets are as shown in the chart below. Ampere ratings of meter sockets are based on the meter socket being wired with 75° C insulated wire conductor, sized in accordance with Table 310-16 of the National Electric Code.

GANG SOCKET OVERALL AMPACITIES

NO. OF METER POSITIONS	100A / POS. AMPACITY	125A / POS. AMPACITY	150A / POS. AMPACITY	200A / POS. AMPACITY
2	200A	200A	200A	200A #
3	200A	225A	225A	270A
4	200A	250A	270A	360A
5	225A	285A	338A	450A
6	270A	330A	396A	528A

† Unless otherwise permitted elsewhere in the Code, the overcurrent protection for conductor types marked with an obelisk (†) shall not exceed 15 amps for 14 AWG, 20 amps for 12 AWG, and 30 amps for 10 AWG copper; or 15 amps for 12 AWG and 25 amps for 10 AWG aluminum and copper-clad aluminum after any correction factors for ambient temperature and number of conductors have been applied.

Some constructions are rated at 400 amps overall. Contact your sales representative for more information. Refer to latest NEC Code or Local Codes for updated requirements.

Please consult serving utility for their requirements prior to ordering or installing, as specifications and approvals vary by utility, and may require local electrical inspector approval. All installations must be installed by a licensed electrician and must comply with all national and local codes, laws and regulations. Milbank reserves the right to make changes in specifications and features shown without notice or obligation.



Important Note

In addition to national and local electrical codes, many utilities have specific requirements for metering equipment. Always consult the serving utility for their specifications and requirements prior to ordering or installing Milbank meter mounting equipment.

Before Energizing

1. Give equipment a thorough visual examination to determine that:
 - a) No shipping or installation damage exists.
 - b) Proper clearances have been maintained.
 - c) All connections have been made.
 - d) Equipment is clean and dry.
2. Make a thorough examination to:
 - a) Verify tightness of all bolted connections (see table below).
 - b) Manually operate all circuit breakers, switches, relays, etc.
 - c) Check rigidity of all mountings, bus bars and components.
 - d) Use test equipment to check continuity of circuitry and integrity of insulation.
3. All switches and circuit breakers should be in the OFF position.
4. Verify that manual meter bypass (if applicable) is in non-bypass position.
5. Install cover and/or close doors.
6. If installation is not being energized at this time, follow "after-energizing" steps listed below. These steps will secure the installation in case of accidental energization.

When Energizing

1. Use caution and follow established safety procedures:
 - a) Wear safety apparel.
 - b) Use safety equipment.
 - c) Take action to prevent injury to yourself and others in the event of failure of the installation.
 - d) Take action to prevent/decrease damage to property in the event of failure of the installation.
 - e) If you are unsure how to safely energize the installation, get someone who is knowledgeable to do it.

After Energizing

1. Secure the installation:
 - a) To prevent accidental contact with energized parts, cover all openings with approved filler devices.
 - b) To prevent unauthorized access, secure all covers and/or doors with approved security devices.
 - c) Attach/post information to advise others of potential hazards associated with the installation.

Recommended Torque for General Applications*

Nominal Size	Joint Description		Head Type	Torque (Inch Lbs.)
	Screw	Nut		
10	Brass	Brass Nut or Extruded Hole	All	20-25 inch lbs.
10	Steel	Copper or Aluminum Busbar ≤ 1/8"	All	25-30 inch lbs.
10	Steel	Steel Nut or Extruded Hole; CU or AL Busbar > 1/8"	All	30-35 inch lbs.
12	Steel	Aluminum Extruded Hole	All	30-35 inch lbs.
12	Steel	Steel Nut or Extruded Hole	All	40-50 inch lbs.
1/4	Steel	Aluminum Extruded Hole	All	40-50 inch lbs.
1/4	Steel	Steel Nut or Extruded Hole; CU or AL Busbar	All	50-60 inch lbs.
5/16	Steel	Aluminum Extruded Hole	Hex	60-70 inch lbs.
5/16	Steel	Steel Nut or Extruded Hole; CU or AL Busbar	Hex	100-150 inch lbs.
3/8	Steel	Steel Nut	Hex	150-200 inch lbs.
1/2	Steel	Steel Nut	Hex	200-250 inch lbs.

* Interior labels typically indicate the required torque for wire connectors and studs, and should be referenced first.
CU: Copper
AL: Aluminum



Please consult serving utility for their requirements prior to ordering or installing, as specifications and approvals vary by utility, and may require local electrical inspector approval. All installations must be installed by a licensed electrician and must comply with all national and local codes, laws and regulations. Milbank reserves the right to make changes in specifications and features shown without notice or obligation.

Materials & Finishes

Reference Information

Materials

Steel Quality

The meter equipment listed in this catalog is made of galvanized steel (AISI* G90) to afford the best possible weather proofing.
*American Iron and Steel Institute.

Steel Sheet

16 gauge, galvanized, sheet: 1 1/4 oz./ sq.ft. class zinc-coated. (AISI G90)
14 gauge, galvanized, sheet: 1 1/4 oz./ sq.ft. class zinc-coated.

Aluminum Extrusion

Wire-Terminals: Alloy; 6061-T6, Tin-plated for CU/AL wire.
Bus Bar: Alloy; 6101-o & 6063-O

Aluminum Sheet

3000 series aluminum sheet, H14, or 5052 series aluminum sheet, H32. Where applicable thicknesses range from .064 — .125

Copper Sheet & Bus

Electrolytic copper with tin plating in most applications.

Insulating Materials

- In most units, support bases for current-carrying components are molded from fiberglass reinforced high-strength, track resistant, thermoset polyester molding compounds.
- Clear or black safety shields and polarity barriers are molded from high-strength, track resistant, polycarbonate molding compounds.
- Various sheet insulating materials, as appropriate for the application are utilized in the fabrication of flat, formed and punched component parts and barriers.

Finish

Process

Light gray state-of-the-art electrostatically applied powder paint offers a durable, non-fading finish. For further information concerning the chemical analysis of the weather resistant finish, please contact the factory.

Metal Fasteners

Zinc-coated with a chromate dip.

Ratings & Compliance

Ratings & Compliance

All Milbank electrical enclosures in this catalog are rated Type 3R Enclosure unless otherwise specified on the product's page. All enclosures with a UL designation are constructed per the appropriate UL Standard and may be installed per the National Electric Code. UL procedure files associated with the UL Standards are listed as follows: Meter Sockets (UL 414, File E30202), Test Switches (UL 414, File E62531), Power Outlets (UL 231, File E90945), Panelboards (UL 67, File E32628) and Pullout Switches (UL 1429, File E133062). Additional standards are utilized as applicable: Meter Sockets (ANSI C12.7), Test Switches (ANSI C12.9) and Panelboards (NEMA PB-1).

Please consult serving utility for their requirements prior to ordering or installing, as specifications and approvals vary by utility, and may require local electrical inspector approval. All installations must be installed by a licensed electrician and must comply with all national and local codes, laws and regulations. Milbank reserves the right to make changes in specifications and features shown without notice or obligation.



DIAGRAM A
1 \emptyset 2W with 1 P.T. & 1 C.T.
Single Stator Meter(2W1 \emptyset) - Form 3S
5T Socket, Test Switch #TS04-0101

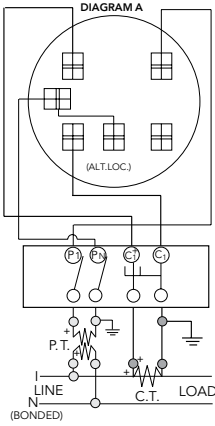

DIAGRAM B
1 \emptyset 3W with 1 C.T.
Single Stator Meter(2W1 \emptyset) - Form 3S
5T Socket, Test Switch #TS04-0101

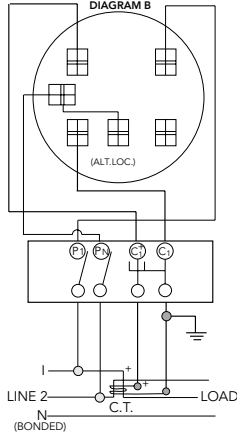

DIAGRAM C
1 \emptyset 3W with 2 C.T.'s
Single Stator Meter(3W1 \emptyset) - Form 4S
6T Socket, Test Switch #TS07-0105

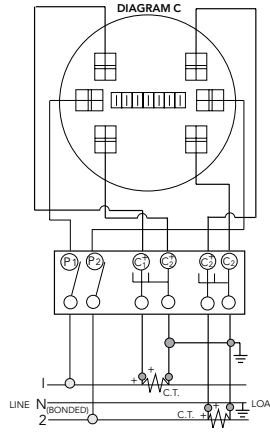

DIAGRAM D
1 \emptyset 3W or 3W Network with 2 C.T.'s
2 Stator Meter - Form 5S
8T Socket, Test Switch #TS07-0105

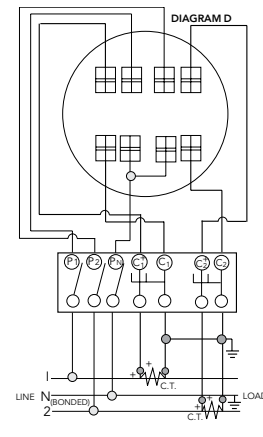

DIAGRAM E
3 \emptyset 3W "A" with 2 P.T.'s & 2 C.T.'s
2 Stator Meter - Form 5S
8T Socket, Test Switch #TS07-0105

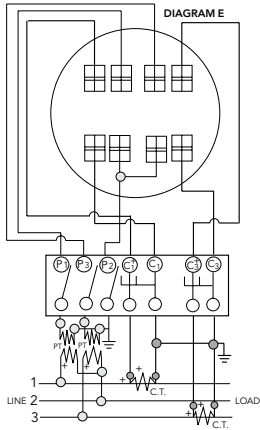

DIAGRAM F
3 \emptyset 3W "A" with 2 C.T.'s
2 Stator Meter - Form 5S
8T Socket, Test Switch #TS07-0105

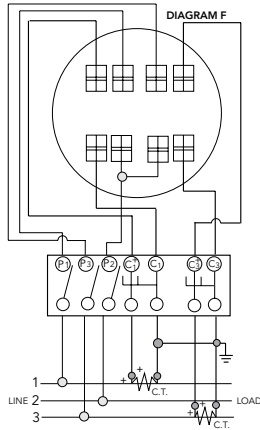

DIAGRAM G
3 \emptyset 4W "Y" with 3 C.T.'s
2 1/2 Stator Meter - Form 6S
13T Socket, Test Switch #TS10-0109

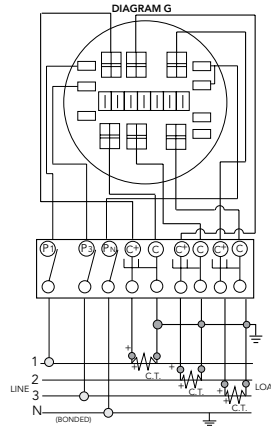

DIAGRAM H
3 \emptyset 4W "Y" with 2 P.T.'s & 3 C.T.'s
2 1/2 Stator Meter - Form 6S
13T Socket, Test Switch #TS10-0109

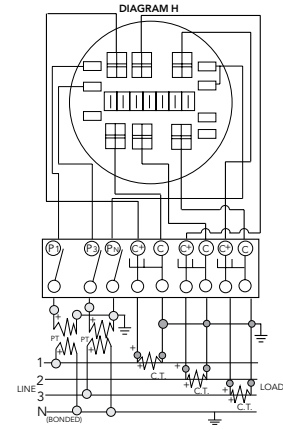

DIAGRAM I
3 \emptyset 4W "Y" or "A" with 3 C.T.'s
"Y" 3 Stator Meter - Form 9S
"A" 2 Stator Meter - Form 8S
13T Socket, Test Switch #TS10-0109

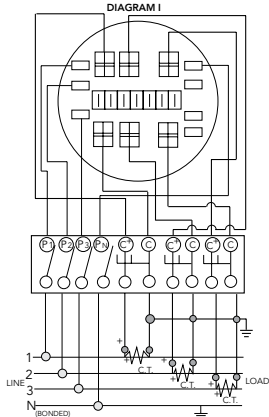
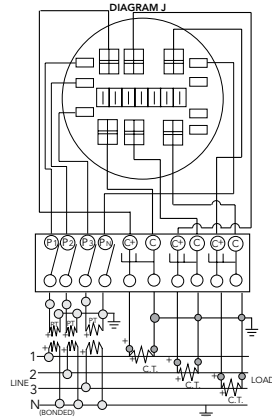

DIAGRAM J
3 \emptyset 4W "Y" with 3 P.T.'s & 3 C.T.'s
3 Stator Meter - Form 9S
13T Socket, Test Switch #TS10-0109



Prewiring: If standard factory prewiring is required, refer to wiring diagrams on this page. Determine appropriate diagram and send a copy with order. If custom factory prewiring is required, specify on order. Be sure to include meter socket catalog number, test switch make and catalog number, meter form number and provide a copy of your wiring diagram.

Please consult serving utility for their requirements prior to ordering or installing, as specifications and approvals vary by utility, and may require local electrical inspector approval. All installations must be installed by a licensed electrician and must comply with all national and local codes, laws and regulations. Milbank reserves the right to make changes in specifications and features shown without notice or obligation.



Watt-hour Meter Forms

Standard Forms | Transformer Rated or Self-Contained

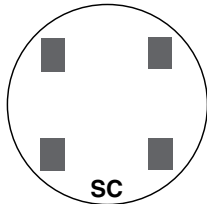

SC
2 and 3-WIRE FORMS
1S & 2S

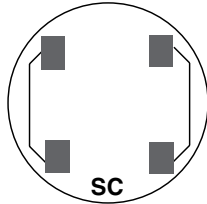

SC
2 and 3-WIRE FORMS
1S & 2S with BYPASS

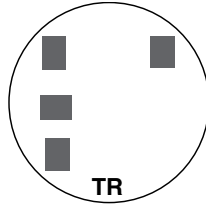

TR
2-WIRE FORM 3S
5th Term. 9 o'clock

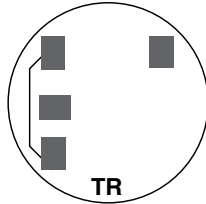

TR
2-WIRE FORM 3S
with BYPASS

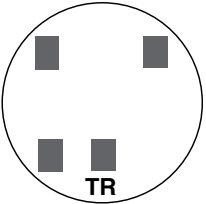

TR
2-WIRE FORM 3S
5th Term. 6 o'clock

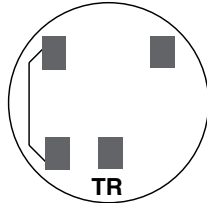

TR
2-WIRE FORM 3S
with BYPASS

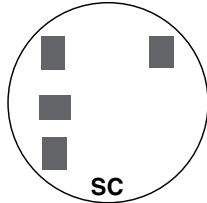

SC
2 ELEMENT
3-WIRE NETWORK
FORM 12S 5th
TERM. 9 o'clock

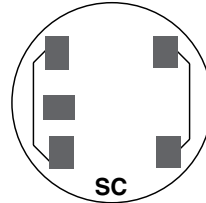

SC
2 ELEMENT 3-WIRE
NETWORK FORM 12S
with BYPASS
5th Term. 9 o'clock

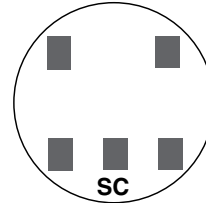

SC
2 ELEMENT
3-WIRE NETWORK
FORM 12S 5th
TERM. 6 o'clock

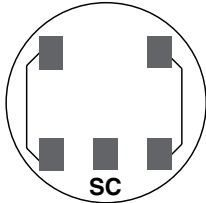

SC
2 ELEMENT 3-WIRE
NETWORK FORM 12S
with BYPASS
5th Term. 6 o'clock

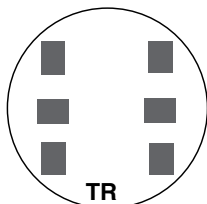

TR
3-WIRE FORM 4S

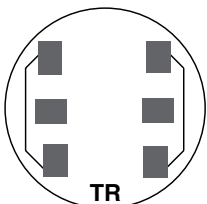

TR
3-WIRE FORM 4S
WITH BYPASS

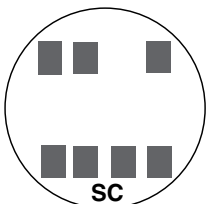

SC
2 or 3 ELEMENT
3Ø4W Y or
Y FORM 14S
FORM 15S
Y FORM 16S

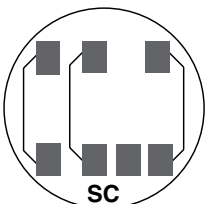

SC
2 or 3 ELEMENT
3Ø4W Y or
FORMS 14S & 15S
with BYPASS

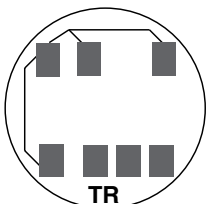

TR
2 ELEMENT
3Ø4W Y or
Y FORM 7S
FORM 24S
with BYPASS

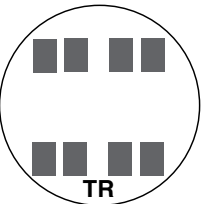

TR
2 ELEMENT
2Ø3W, 2Ø4W, 3Ø3W
FORM 5S

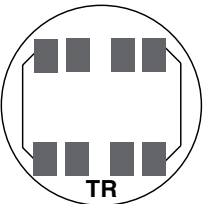

TR
2 ELEMENT Ø3W,
2Ø4W, 3Ø3W
FORM 5S with
BYPASS

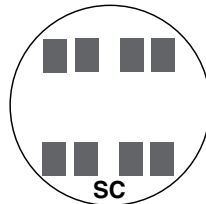

SC
2 ELEMENT
2Ø3W, 2Ø4W, 3Ø3W
FORM 13S

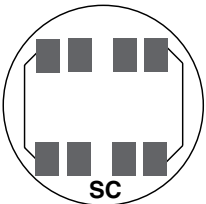

SC
2 or 3 ELEMENT
2Ø3W, 2Ø4W, 3Ø3W
FORM 13S with
BYPASS

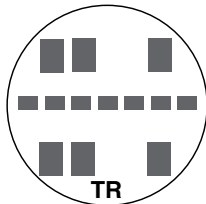

TR
2 or 3 ELEMENT
3Ø4W Y or
Y FORM 9S
FORM 8S

TR = TRANSFORMER RATED
SC = SELF CONTAINED

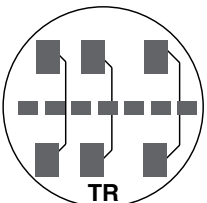

TR
2 or 3 ELEMENT
3Ø4W Y or
FORMS 8S & 9S
FORMS 8S & 9S
with BYPASS

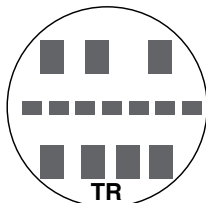

TR
2 ELEMENT
3Ø4W Y
FORM 6S

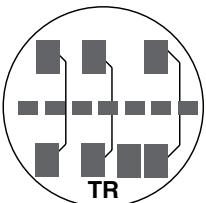

TR
2 ELEMENT
3Ø4W Y
FORM 6S
with BYPASS

Please consult serving utility for their requirements prior to ordering or installing, as specifications and approvals vary by utility, and may require local electrical inspector approval. All installations must be installed by a licensed electrician and must comply with all national and local codes, laws and regulations. Milbank reserves the right to make changes in specifications and features shown without notice or obligation.



2 Pole | 3 Wire | Grounding Receptacles

Straight Blade Wiring Devices				Twist-Lock Wiring Devices				
Volts	Code	15 Amps	20 Amps	30 Amps	50 Amps	15 Amps	20 Amps	30 Amps
125	5							
		5-15R	5-20R	5-30R	5-50R	L5-15R	L5-20R	L5-30R
250	6							
		6-15R	6-20R	6-30R	6-50R	L6-15R	L6-20R	L6-30R
277 VAC	7							
		7-15R	7-20R	7-30R	7-50R	L7-15R	L7-20R	L7-30R

3 Pole | 3 Wire | Special Applications

Straight Blade Wiring Devices			Twist-Lock Wiring Devices		
Volts	Code	20 Amps	30 Amps	50 Amps	30 Amps
125V 250V	10				
		10-20R	10-30R	10-50R	L10-20R L10-30R

3 Pole | 4 Wire | Grounding

Straight Blade Wiring Devices				Twist-Lock			
Volts	Code	15 Amps	20 Amps	30 Amps	50 Amps	20 Amps	30 Amps
125V 250V	14						
		14-15R	14-20R	14-30R	14-50R	L14-20R	L14-30R

2 Pole | 3 Wire | Grounding | NEMA Trailer

Straight Blade Wiring Devices		
Volts	Code	30 Amps
125V	TT	



Please consult serving utility for their requirements prior to ordering or installing, as specifications and approvals vary by utility, and may require local electrical inspector approval. All installations must be installed by a licensed electrician and must comply with all national and local codes, laws and regulations. Milbank reserves the right to make changes in specifications and features shown without notice or obligation.

6003.....	76	MR2-SS.....	76	QN2150RH.....	73
6116.....	76	MR-4.....	76	QN2200.....	73
5T8K2.....	77	Q115.....	73	QN2200H.....	73
A7514.....	75	Q115H.....	73	QN2200R.....	73
A7515.....	75	Q120.....	73	QN2200RH.....	73
A7516.....	75	Q120H.....	73	S1619-XL.....	9
A7517.....	75	Q125.....	73	S1994-WL-KK.....	54
A7518.....	75	Q125H.....	73	S2068-0.....	10
A7551.....	75	Q130.....	73	S8324.....	75
A8110.....	75	Q130H.....	73	SC2077-XL.....	54
A8111.....	75	Q135.....	73	SC2992-RL.....	54
A8112.....	75	Q135H.....	73	SC6128-XL.....	59
A9064.....	75	Q140.....	73	SC6129-O.....	59
A-GP.....	76	Q140H.....	73	U1079-R.....	16
CP-21.....	76	Q150.....	73	U1079-R-5T9.....	17
K1047.....	77	Q150H.....	73	U1129-O.....	16
K1190.....	77	Q160.....	73	U1129-O-5T9.....	17
K1350.....	76	Q160H.....	73	U1207-RL.....	12
K1350L.....	76	Q170.....	73	U1211-RXL.....	12
K1539.....	76	Q170H.....	73	U1252-X.....	32
K1540.....	76	Q2100.....	73	U1253-X.....	32
K1540L.....	76	Q2100H.....	73	U1254-X.....	32
K1541.....	76	Q2125.....	73	U1255-X.....	32
K3082.....	76	Q2125H.....	73	U1256-X.....	32
K3083.....	76	Q215.....	73	U1748-O-5T9-WI.....	53
K3441.....	76	Q215H.....	73	U1797-O-K3L-K2L.....	16
K3442.....	76	Q220.....	73	U1797-O-STU-STU.....	16
K3865.....	77	Q220H.....	73	U1980-0.....	10
K3866.....	77	Q225.....	73	U2120-O.....	18
K4802.....	77	Q225H.....	73	U2448-X.....	16
K4977-EXT.....	77	Q230.....	73	U2448-X-5T9.....	17
K4977-INT.....	77	Q230H.....	73	U2569-0.....	10
K5022-INT.....	77	Q235.....	73	U2594-X.....	18
K5815.....	76	Q235H.....	73	U2732-XT.....	34
K5820.....	76	Q240.....	73	U2733-XT.....	34
K5830.....	76	Q240H.....	73	U2734-XT.....	34
K5920-10GR.....	47	Q250.....	73	U2735-XT.....	34
K5920-111GR.....	47	Q250H.....	73	U2736-XT.....	34
K5920-11GR.....	47	Q260.....	73	U2852-X.....	35
K5920-38.....	47	Q260H.....	73	U2853-X.....	35
K5920-41.....	47	Q270.....	73	U2854-X.....	35
K5920-522.....	47	Q270H.....	73	U2855-X.....	35
K5920-54.....	47	Q280.....	73	U2856-X.....	35
K5920-58.....	47	Q280H.....	73	U2862-X.....	35
K5920-75.....	47	Q290.....	73	U2863-X.....	35
K5920-BLANK.....	47	Q290H.....	73	U2864-X.....	35
K5T.....	77	QN2150.....	73	U2865-X.....	35
M5-144.....	77	QN2150H.....	73	U2866-X.....	35
MR-2.....	76	QN2150R.....	73	U2872-XT-5T9.....	33

Please consult serving utility for their requirements prior to ordering or installing, as specifications and approvals vary by utility, and may require local electrical inspector approval. All installations must be installed by a licensed electrician and must comply with all national and local codes, laws and regulations. Milbank reserves the right to make changes in specifications and features shown without notice or obligation.



U2873-Xt-5T9.....	33	U4702-X.....	16	U5220-XL-55.....	45
U2874-Xt-5T9.....	33	U4721-0-BL.....	13	U5220-XL-75.....	45
U2875-Xt-5T9.....	33	U4724-O-5T9.....	49	U5220-XL-75GB.....	45
U2876-Xt-5T9.....	33	U4801-0-5T9.....	14	U5268-XTL-150.....	22
U2986-0.....	10	U4801-XL.....	13	U5268-XTL-150-KK.....	22
U3000-O-K3L-K2L.....	17	U4801-XL-5T9.....	14	U5268-XTL-200.....	22
U3278-RL.....	11	U4811-O-21.....	40	U5268-XTL-200-KK.....	22
U3491-XL-150.....	19	U4833-O.....	50	U5300-O.....	46
U3491-XL-200.....	19	U4833-O-5T9.....	50	U5300-O-41.....	46
U3499-XL.....	19	U4834-XL-200-5T9.....	23	U5300-O-55.....	46
U3598-RL-TG.....	11	U4881-O.....	7	U5300-O-552GR.....	46
U3771-XL-100.....	24	U4881-O-50GB.....	7	U5300-O-75.....	46
U3791N-RXL-(AMP).....	24	U4881-O-60GB.....	7	U5320-O.....	46
U3791N-RXL-(AMP)-5T9.....	24	U4911-X-QG-BL.....	18	U5320-O-41.....	46
U3802.....	5	U5000-XL.....	43	U5320-O-55.....	46
U3812.....	5	U5000-XL-332.....	43	U5320-O-552GR.....	46
U3822-20GWR.....	6	U5000-XL-41.....	43	U5320-O-75.....	46
U3832.....	5	U5000-XL-55.....	43	U5701-O-5T9.....	51
U3849-O-2/200-5T9.....	53	U5000-XL-75.....	43	U5702-O-5T9.....	51
U3862.....	5	U5000-XL-75GB.....	43	U5703-O-5T9.....	51
U3924-XL.....	13	U5059-X-2/200-5T9.....	26	U5750-RXL-200-BL.....	24
U3995-XL-200-5T9.....	23	U5059-X-5T9-K3L.....	26	U5764-X-200-5T-CB.....	28
U4031-O-2/200-5T9.....	26	U5091-RL-76GBGR.....	42	U5764-X-200-CB.....	28
U4184-X.....	15	U5100-XL.....	44	U5767-X-200-CB.....	28
U4216-RXL.....	11	U5100-XL-41.....	44	U5784-O-200-CB.....	28
U4322-O.....	50	U5100-XL-55.....	44	U5794-X-400-5T-CB.....	28
U4322-O-5T9.....	50	U5100-XL-552GR.....	44	U5794-X-400-CB.....	28
U4323-O.....	50	U5100-XL-75.....	44	U5796-X-400-CB.....	28
U4323-O-5T9.....	50	U5100-XL-75GB.....	44	U5797-O-400-CB.....	28
U4372-Xt-5T9.....	39	U5136-O-200S.....	48	U5842-RL-200.....	20
U4373-Xt-5T9.....	39	U5137-O-200S.....	48	U5844-PXL.....	20
U4374-Xt-5T9.....	39	U5168-XTL-100.....	22	U5880-XL-200-5T9.....	24
U4375-Xt-5T9.....	39	U5168-XTL-100-KK.....	22	U5882-X.....	37
U4376-Xt-5T9.....	39	U5168-XTL-100-KK-5T.....	22	U5883-X.....	37
U4413-0.....	10	U5168-XTL-150.....	22	U5884-X.....	37
U4490-XL.....	55	U5168-XTL-150-KK.....	22	U5885-X.....	37
U4492-XL.....	55	U5168-XTL-150-KK-5T.....	22	U5886-X.....	37
U4493-XL.....	55	U5168-XTL-200.....	22	U5890-X-2/200.....	27
U4494-XL.....	55	U5168-XTL-200-KK.....	22	U5891-X-2/200.....	27
U4496-XL.....	55	U5200-XL.....	45	U5892-X-2/200.....	27
U4497-XL.....	55	U5200-XL-332.....	45	U5893-X-2/200.....	27
U4540-XL.....	60	U5200-XL-41.....	45	U5894-X-2/200.....	27
U4542-XL.....	60	U5200-XL-41GB.....	45	U5895-X-2/200.....	27
U4544-XL.....	60	U5200-XL-55.....	45	U5902-X.....	37
U4546-XL.....	60	U5200-XL-75.....	45	U5903-X.....	37
U4548-RXL.....	60	U5200-XL-75GB.....	45	U5904-X.....	37
U4549-RXL.....	60	U5220-XL.....	45	U5905-X.....	37
U4550-RL-5T9.....	14	U5220-XL-332.....	45	U5906-X.....	37
U4551-RXL-5T9.....	14	U5220-XL-41.....	45	U5934-XL-BLG.....	8
U4701-XL.....	15	U5220-XL-41GB.....	45	U5972-Xt-5T9-AMS.....	41



Please consult serving utility for their requirements prior to ordering or installing, as specifications and approvals vary by utility, and may require local electrical inspector approval. All installations must be installed by a licensed electrician and must comply with all national and local codes, laws and regulations. Milbank reserves the right to make changes in specifications and features shown without notice or obligation.

U5973-XT-5T9-AMS	41	U9647N-XL-100	21	UQFB-175.....	74
U5974-XT-5T9-AMS	41	U9647N-XL-200	21	UQFB-175-X1	74
U5975-XT-5T9-AMS	41	U9648-RL-100	21	UQFB-200.....	74
U5976-XT-5T9-AMS	41	U9701-RXL	15	UQFB-200-X1	74
U6035-O	40	U9761-RRL	15	UQFBH-100	74
U6134-RL-76GBGR	42	U9800-RRL	13	UQFBH-125	74
U6158-O-MNV	40	U9801-RXL	13	UQFBH-150	74
U6221-O-100-10GR.....	52	U9865-RRL	13	UQFBH-175	74
U6221-O-200-10GR.....	52	UAP6094-O	61	UQFBH-200	74
U6281-XL-100 -5T9	25	UAP6095-O	61	UQFP-100.....	74
U6281-XL-150 -5T9	25	UAP6096-O	61	UQFP-125.....	74
U6281-XL-200 -5T9	25	UC1290-RL	56	UQFP-150.....	74
U6282-XL-200 -5T9	25	UC1291-RL	56	UQFP-175.....	74
U7021-RL-TG	9	UC1299-RL	56	UQFP-200.....	74
U7040-0-TG	9	UC1300-RL	56	UQFPH-100	74
U7040-XL-TG	9	UC3423-XL	58	UQFPH-125	74
U7043-XL-TG	9	UC3425-XL	58	UQFPH-150	74
U7362-XL	29	UC3426-XL	58	UQFPH-175	74
U7363-XL	29	UC3428-XL	58	UQFPH-200	74
U7364-XL	29	UC3433-XL	58	UQFPH-M-100.....	74
U7365-XL	29	UC3434-XL	58	UQFPH-M-100.....	74
U7366-XL	29	UC3435-XL	58	UQFPH-M-125.....	74
U7420-RL	12	UC3436-XL	58	UQFPH-M-125.....	74
U7421-RL	12	UC3438-XL	58	UQFPH-M-150.....	74
U7422-RXL.....	12	UC7233-RL	56	UQFPH-M-150.....	74
U7423-RXL.....	12	UC7235-RL	56	UQFPH-M-175.....	74
U7445-RL-WC-951.....	59	UC7237-RL	56	UQFPH-M-175.....	74
U7487-RL.....	8	UC7442-RL	57	UQFPH-M-200.....	74
U7487-RL-TG-KK	8	UC7444-RL	57	UQFPH-M-200.....	74
U7573-RL	11	UC7445-RL	57	UQFP-M-100	74
U7588-XL	8	UC7445-XL-371	59	UQFP-M-125	74
U8032-RL	31	UC7446-RL	57	UQFP-M-150	74
U8033-RL	31	UC7448-RL	57	UQFP-M-175	74
U8034-RL	31	UC7449-RL	57	UQFP-M-200	74
U8035-RL	31	UC7450-RL	57		
U8036-RL	31	UC7460-RL	57		
U8100-RL	11	UC7461-RL	57		
U8212-XL	30	UC7478-RL	57		
U8213-XL	30	UC7478-RL-WC-271	59		
U8214-XL	30	UC7532-RL	57		
U8215-XL	30	UC7544-RL	56		
U8216-XL	30	UC7545-XL	56		
U9107-0	49	UC7546-RL	56		
U9108-O-5T9.....	49	UC7636-RL	57		
U9318-RL	12	UQFB-100.....	74		
U9319-RL	12	UQFB-100-X1	74		
U9320-RRL	11	UQFB-125	74		
U9321-RL	11	UQFB-125-X1	74		
U9550-RRL	14	UQFB-150	74		
U9551-RXL	14	UQFB-150-X1	74		

Please consult serving utility for their requirements prior to ordering or installing, as specifications and approvals vary by utility, and may require local electrical inspector approval. All installations must be installed by a licensed electrician and must comply with all national and local codes, laws and regulations. Milbank reserves the right to make changes in specifications and features shown without notice or obligation.



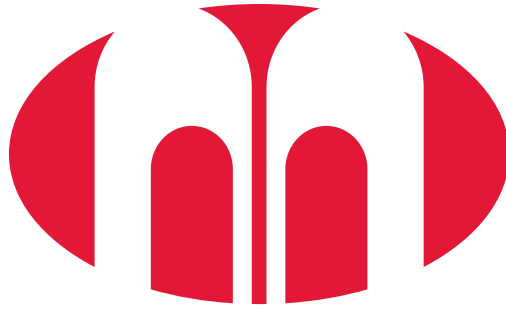

MILBANK[®]

ENERGY AT WORK

