

## WALL PLATES & SPECIALTIES



### SWP26LA

#### Screwless Polycarbonate Wall Plates

- A. Molded of rugged .065" thick polycarbonate.**
- B. Seamless, sleek, super smooth construction** provides no dirt-catching channel around plate's perimeter.
- C. Two-piece plastic subplate** bridges recessed boxes and uneven sheet rock. Fixes floating installations.
- D. Automatic alignment pins** ensure that devices are properly positioned so that wall plates fit perfectly.
- E. Oversized opening** to accommodate all NEMA 26 decorator-style openings.
- F. An extra 1/8" width and height than standard size wall plates** for more tolerance in covering ragged sheet rock openings.

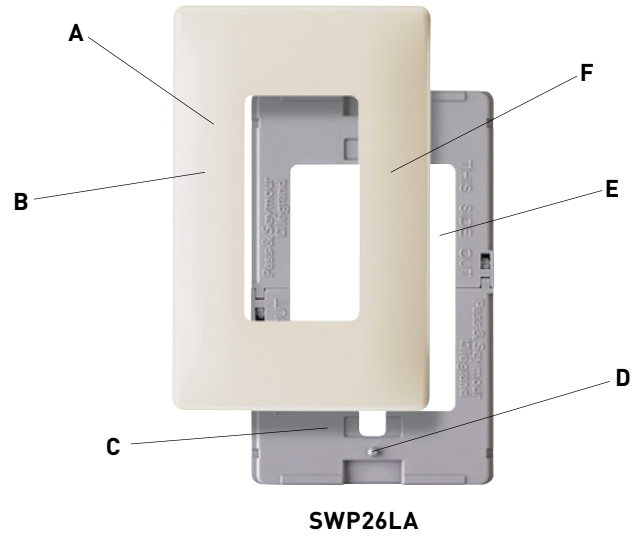

# WALL PLATES

## Specifications



**Thermoset  
SP Series**



**Nylon  
TP Series**



**Screwless  
Polycarbonate  
SWP Series**



**302/304  
Stainless  
Steel**



**Polished  
Brass**

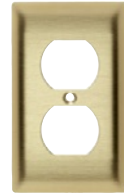

**Brushed  
Brass**



**Aluminum**

## Application

Legrand's broad line of Pass & Seymour® Standard Size Plastic and Metal Wall Plates features the most complete range of types, sizes, colors, and finishes available. Choose from more than 1,900 standard plates in non-combustible thermoset plastic material, self-extinguishing nylon material, screwless polycarbonate material, or attractively finished metal, for residential, commercial, institutional, and industrial applications. All plastic wall plates color match to Pass & Seymour devices.

### Thermoset Plastic Wall Plates

- Molded of non-combustible mar-proof material.
- Available in "SP" series in Standard, Junior-Jumbo, and Jumbo sizes.
- Seven standard colors available – Ivory, White, Brown, Gray, Black, Red, and Light Almond.
- Individually wrapped with color-matching screws.
- Resistant to discoloration, grease, oil, solvent and moisture.
- Nominal thickness, .070"

### TradeMaster® Thermoplastic Wall Plates

- Molded of rugged, practically indestructible self-extinguishing nylon. ("TP" series only)
- Available in "TP" series, extra 3/16" width and height than Standard size plates; and "TPJ" series, extra 3/16" width and height than Junior-Jumbo size plates.
- Available in Ivory, White, Brown, Gray, Black, Blue, Orange, Red, and Light Almond.
- Preferred for hospital, industrial, institutional, and other high-abuse applications.
- Nominal thickness, .070"

### Screwless Polycarbonate Wall Plates

- Molded of .065" thick polycarbonate, matte finish.
- 2-piece plastic subplate made of polycarbonate.
- Extra 1/8" width and height than Standard size plates.
- Available in Ivory, White, Brown, Gray, Black, and Light Almond; and three metallic finishes.

### Metal Wall Plates

- Constructed of corrosion-resistant stainless steel, brass, aluminum, chrome, brushed bronze or galvanized steel.
- Standard, Jumbo, and Tandem size plates available, as well as special Panel size plates up to 5-gangs high and 10-gangs wide.
- Packaged in protective film, with finish-matching screws.
- Variety of special plated finishes. Paintable to match plastic plates.
- Can be silk-screened or engraved, and custom punched with over 300 opening styles.

### Materials

- Type 302/304 Stainless Steel, non-magnetic, .032" nominal thickness, brushed finish. This alloy contains 18% chromium and 8% nickel for superior resistance to corrosion. Recommended for use in food processing plants, dairies, chemical plants, and other industrial, institutional, and commercial applications where corrosive atmospheres exist.
- Type 430 Stainless Steel, magnetic, .032" nominal thickness, brushed finish. Less corrosion-resistant than Type 302/304, but ideal for general service in high abuse applications in industrial plants, commercial, and institutional buildings.
- Chrome, Brushed and Polished Brass, .040" thick. 70% copper, 30% zinc alloy gives warm, appealing finish to modern decor as well as retrofit applications. Lacquered to prevent corrosion.
- Aluminum, .040" thick. Lustrous satin finish. Lacquered to prevent corrosion.
- Galvanized Steel. Used only for Handy Box Plates.
- Brushed Bronze, .040" thick. 90% copper, 10% zinc. Lacquered to prevent corrosion.

# WALL PLATES

## Dimensions

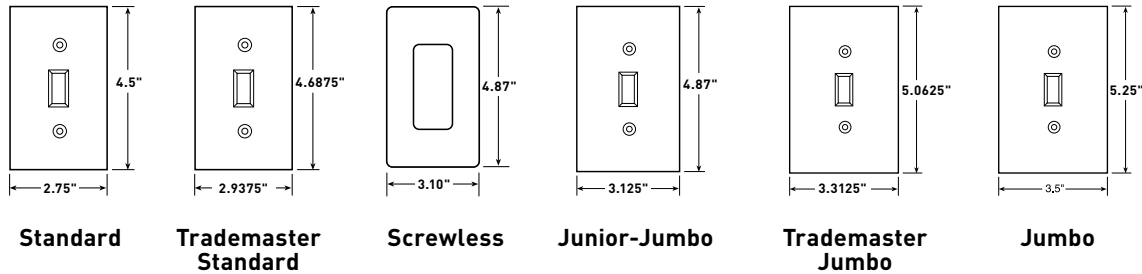

### Standard Size Wall Plates

- Standard size wall plates for all applications.
- Best fit for surface mount boxes.
- Available in plastic and metal only.

#### Dimensions

<b>1 gang</b>	2.75" x 4.5"
<b>2 gang</b>	4.56" x 4.5"
<b>3 gang</b>	6.375" x 4.5"
<b>4 gang</b>	8.125" x 4.5"
<b>5 gang</b>	10" x 4.5"
<b>6 gang</b>	11.812" x 4.5"
<b>7 gang</b>	13.62" x 4.5"
<b>8 gang</b>	15.44" x 4.5"

### TradeMaster® Wall Plates

- Extra 3/16" width and height than Standard size wall plates.
- Provide better sheet rock coverage with standard size appearance.
- Available in unbreakable nylon 6 construction only.
- Screws pre-installed in the duplex, toggle and decorator single gang plates.

#### Dimensions

<b>1 gang</b>	2.9375" x 4.6875"
<b>2 gang</b>	4.75" x 4.6875"
<b>3 gang</b>	6.563" x 4.6875"
<b>4 gang</b>	8.375" x 4.6875"
<b>5 gang</b>	10.188" x 4.6875"
<b>6 gang</b>	12" x 4.6875"

### Screwless Polycarbonate Wall Plates

- Available in decorator openings.
- Extra 1/8" width and height than Standard size wall plates.
- Provide better sheet rock coverage with standard size appearance.
- Molded of .065" thick polycarbonate.
- 2-piece plastic subplate made of polycarbonate.
- Available in 3 metallic finishes and 6 standard colors.

#### Wall Plate Dimensions

<b>1 gang</b>	3.10" x 4.87"
<b>2 gang</b>	4.912" x 4.87"
<b>3 gang</b>	6.724" x 4.87"
<b>4 gang</b>	8.536" x 4.87"

#### Subplate Dimensions

<b>1 gang</b>	2.85" x 4.62"
<b>2 gang</b>	4.662" x 4.62"
<b>3 gang</b>	6.474" x 4.62"
<b>4 gang</b>	8.286" x 4.62"

### Junior-Jumbo Wall Plates

- Extra 3/8" width and height than Standard size wall plates.
- Additional coverage for sheet rock gaps.
- Available in plastic and metal only.

#### Dimensions

<b>1 gang</b>	3.125" x 4.87"
<b>2 gang</b>	4.93" x 4.87"
<b>3 gang</b>	6.75" x 4.87"
<b>4 gang</b>	8.56" x 4.87"

### TradeMaster® Jumbo Wall Plates

- Extra 3/16" width and height than Junior-Jumbo size wall plates.
- Provide additional coverage for sheet rock gaps, matching the appearance of the TradeMaster Plates.
- Available in unbreakable nylon 6 construction only.
- Screws pre-installed in the duplex, toggle, and decorator single gang plates.

#### Dimensions

<b>1 gang</b>	3.3125" x 5.0625"
<b>2 gang</b>	5.125" x 5.0625"
<b>3 gang</b>	6.9375" x 5.0625"
<b>4 gang</b>	8.75" x 5.0625"

### Jumbo Wall Plates

- Extra 3/4" width and height than Standard size wall plates.
- Largest size wall plates to cover larger wall damage.
- Available in plastic and metal only.

#### Dimensions

<b>1 gang</b>	3.5" x 5.25"
<b>2 gang</b>	5.31" x 5.25"
<b>3 gang</b>	7.12" x 5.25"
<b>4 gang</b>	8.93" x 5.25"

# WALL PLATES

## Dimensions

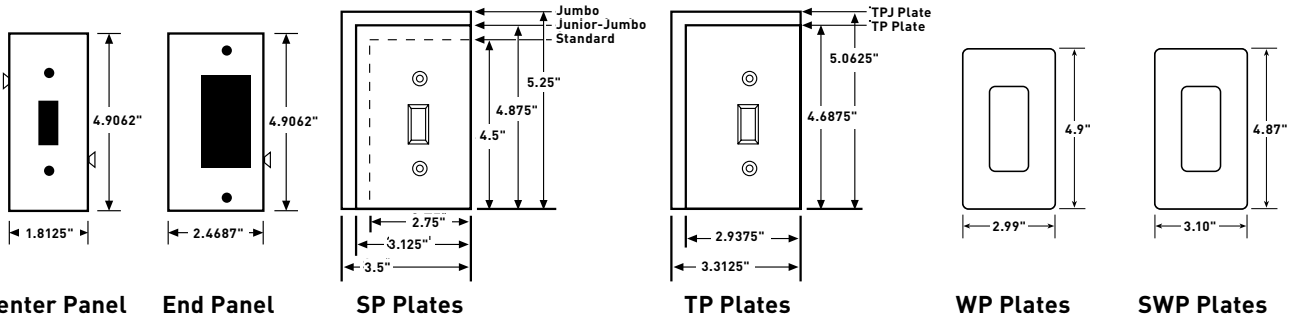

Center Panel   End Panel   SP Plates   TP Plates   WP Plates   SWP Plates

## Sectional Wall Plates

End and center panels with each of five most-used configurations make it possible to improvise custom wall plates on the job. Panels lock securely together on installation. Blank sections furnished with mounting strap.

## Wall Plate Mountings

Illustrated are the five standard methods of plate mounting. There are many other non-standard methods which depend upon the special device used. Exact mounting hole specifications for every device appear in the Selector Guide.

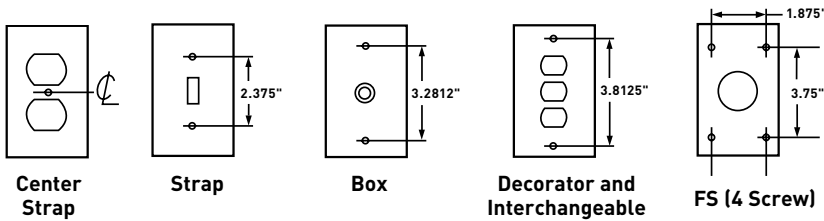

Center Strap   Strap   Box   Decorator and Interchangeable   FS (4 Screw)

## Wall Plate Sizes

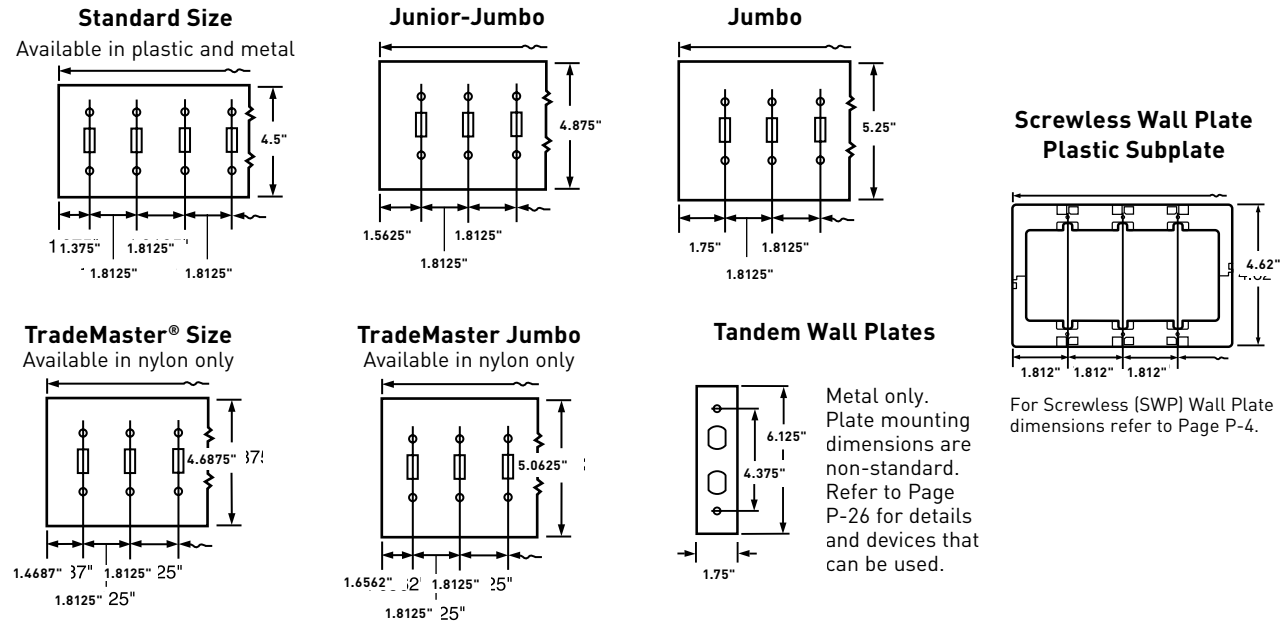

# WALL PLATES

## Decorative Finish Screwless Wall Plates Polycarbonate







**One Gang  
Nickel**

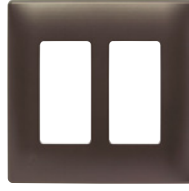

**One Gang  
Antique Brass**



**Two Gang  
Dark Bronze**

DESCRIPTION	COLOR	DECORATOR OPENINGS
<b>SCREWLESS DECORATOR OPENINGS PLASTIC SUBPLATE INCLUDED</b>		
<b>One Gang</b> 	Nickel Antique Brass Dark Bronze	SWP26NI SWP26ABBPCC10 SWP26DBBPCC10
<b>Two Gang</b> 	Nickel Antique Brass Dark Bronze	SWP262NI SWP262ABBPCC10 SWP262DBBPCC10
<b>Three Gang</b> 	Nickel Antique Brass Dark Bronze	SWP263NI SWP263ABBPCC10 SWP263DBBPCC10
<b>Four Gang</b> 	Nickel Antique Brass Dark Bronze	SWP264NI SWP264ABBPCC10 SWP264DBBPCC10

For Screwless Wall Plate and Plastic Subplate dimensions, see Pages P-4 and P-5.

These products listed to UL514, Cover Plates for Flush-Mounted Wiring Devices, CSA Certified.

# WALL PLATES

## Screwless Wall Plates Polycarbonate

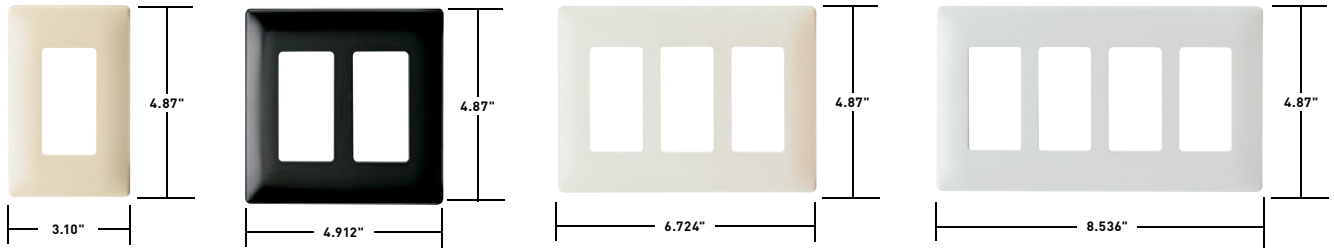

One Gang

Two Gang

Three Gang

Four Gang

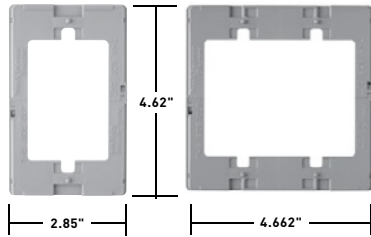

One Gang  
Plastic Subplate

Two Gang  
Plastic Subplate

DESCRIPTION	COLOR	DECORATOR OPENINGS
		
<b>SCREWLESS WALL PLATES PLASTIC SUBPLATE INCLUDED</b>		
<b>One Gang</b>	Ivory	SWP261
	White	SWP26W
	Brown	SWP26
	Gray	SWP26GRY
	Black	SWP26BK
<b>Two Gang</b>	Light Almond	SWP26LA
	Ivory	SWP2621
	White	SWP262W
	Brown	SWP262
	Gray	SWP262GRY
<b>Three Gang</b>	Black	SWP262BK
	Light Almond	SWP262LA
	Ivory	SWP2631
	White	SWP263W
	Brown	SWP263
<b>Four Gang</b>	Gray	SWP263GRY
	Black	SWP263BK
	Light Almond	SWP263LA
	Ivory	SWP2641
	White	SWP264W
<b>Plastic Subplate</b>	Brown	SWP264
	Gray	SWP264GRY
	Black	SWP264BK
	Light Almond	SWP264LA

DESCRIPTION	HEIGHT	WIDTH
<b>SCREWLESS DECORATOR OPENINGS PLASTIC SUBPLATE INCLUDED</b>		
<b>One Gang</b>	4.87"	3.10"
<b>Two Gang</b>	4.87"	4.912"
<b>Three Gang</b>	4.87"	6.724"
<b>Four Gang</b>	4.87"	8.536"

DESCRIPTION	HEIGHT	WIDTH
<b>SCREWLESS PLASTIC SUBPLATE DIMENSIONS</b>		
<b>One Gang</b>	4.62"	2.85"
<b>Two Gang</b>	4.62"	4.662"
<b>Three Gang</b>	4.62"	6.474"
<b>Four Gang</b>	4.62"	8.286"

# DEVICES & WALL PLATES

## Color Selection Chart

### Devices & Plastic Wall Plate Colors

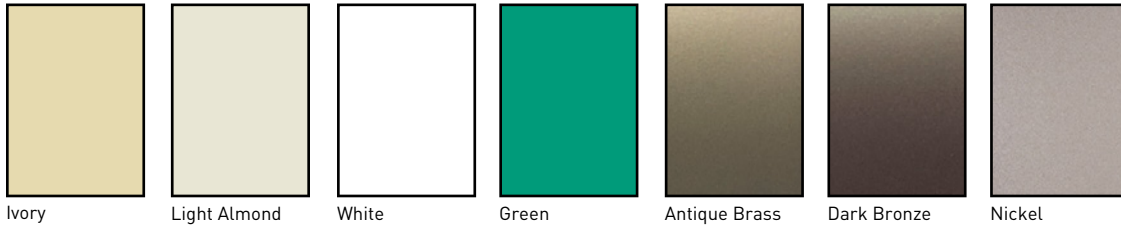

Ivory    Light Almond    White    Green    Antique Brass    Dark Bronze    Nickel



Black    Blue    Brown    Gray    Orange    Red

See specific device and wall plate catalog charts for particular color availabilities.

### Metal Wall Plates

Metal Finish

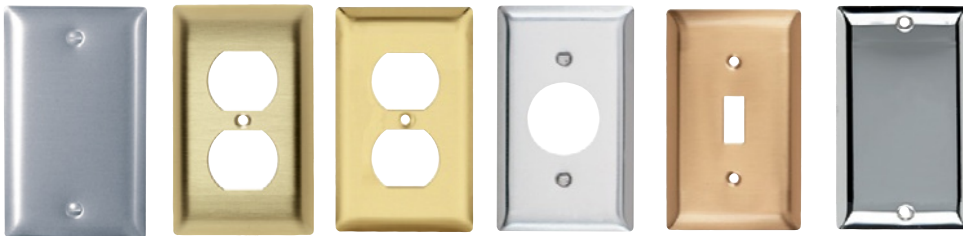

Aluminum    Brass (Brushed)    Polished Brass    Stainless Steel    Brushed Bronze    Chrome

### Custom Metal Wall Plates Paint Finish Colors

Paint Color

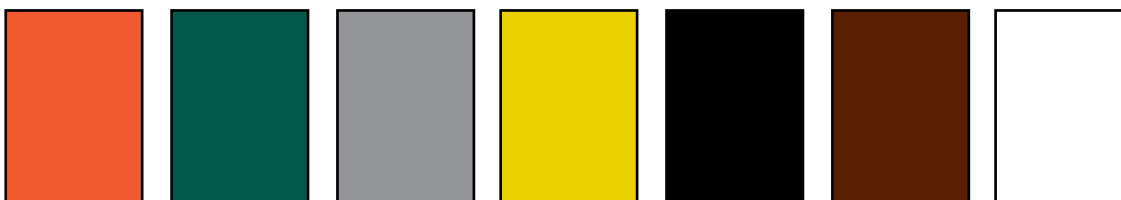

Orange    Green    Gray    Yellow    Glossy Black    Brown    White



Primer    Red    Pink    Flat Black    Ivory    Light Almond    Blue

To order custom metal wall plates, see Pages P-40 – P-42.  
**For additional colors consult factory.**

## WALL PLATES & SPECIALTIES



### SWP26LA Screwless Polycarbonate Wall Plates

- A. Molded of rugged .065" thick polycarbonate.**
- B. Seamless, sleek, super smooth construction** provides no dirt-catching channel around plate's perimeter.
- C. Two-piece plastic subplate** bridges recessed boxes and uneven sheet rock. Fixes floating installations.
- D. Automatic alignment pins** ensure that devices are properly positioned so that wall plates fit perfectly.
- E. Oversized opening** to accommodate all NEMA 26 decorator-style openings.
- F. An extra 1/8" width and height than standard size wall plates** for more tolerance in covering ragged sheet rock openings.

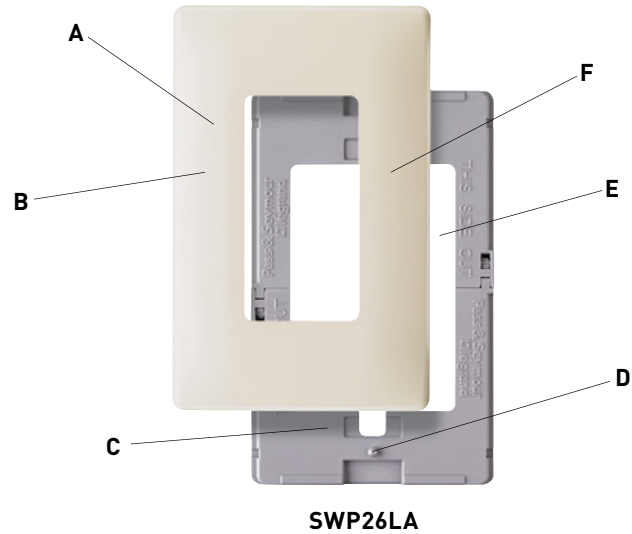



# WALL PLATES

## Specifications



**Thermoset  
SP Series**



**Nylon  
TP Series**



**Screwless  
Polycarbonate  
SWP Series**



**302/304  
Stainless  
Steel**



**Polished  
Brass**

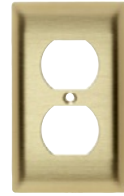

**Brushed  
Brass**



**Aluminum**

## Application

Legrand's broad line of Pass & Seymour® Standard Size Plastic and Metal Wall Plates features the most complete range of types, sizes, colors, and finishes available. Choose from more than 1,900 standard plates in non-combustible thermoset plastic material, self-extinguishing nylon material, screwless polycarbonate material, or attractively finished metal, for residential, commercial, institutional, and industrial applications. All plastic wall plates color match to Pass & Seymour devices.

### Thermoset Plastic Wall Plates

- Molded of non-combustible mar-proof material.
- Available in "SP" series in Standard, Junior-Jumbo, and Jumbo sizes.
- Seven standard colors available – Ivory, White, Brown, Gray, Black, Red, and Light Almond.
- Individually wrapped with color-matching screws.
- Resistant to discoloration, grease, oil, solvent and moisture.
- Nominal thickness, .070"

### TradeMaster® Thermoplastic Wall Plates

- Molded of rugged, practically indestructible self-extinguishing nylon. ("TP" series only)
- Available in "TP" series, extra 3/16" width and height than Standard size plates; and "TPJ" series, extra 3/16" width and height than Junior-Jumbo size plates.
- Available in Ivory, White, Brown, Gray, Black, Blue, Orange, Red, and Light Almond.
- Preferred for hospital, industrial, institutional, and other high-abuse applications.
- Nominal thickness, .070"

### Screwless Polycarbonate Wall Plates

- Molded of .065" thick polycarbonate, matte finish.
- 2-piece plastic subplate made of polycarbonate.
- Extra 1/8" width and height than Standard size plates.
- Available in Ivory, White, Brown, Gray, Black, and Light Almond; and three metallic finishes.

### Metal Wall Plates

- Constructed of corrosion-resistant stainless steel, brass, aluminum, chrome, brushed bronze or galvanized steel.
- Standard, Jumbo, and Tandem size plates available, as well as special Panel size plates up to 5-gangs high and 10-gangs wide.
- Packaged in protective film, with finish-matching screws.
- Variety of special plated finishes. Paintable to match plastic plates.
- Can be silk-screened or engraved, and custom punched with over 300 opening styles.

### Materials

- Type 302/304 Stainless Steel, non-magnetic, .032" nominal thickness, brushed finish. This alloy contains 18% chromium and 8% nickel for superior resistance to corrosion. Recommended for use in food processing plants, dairies, chemical plants, and other industrial, institutional, and commercial applications where corrosive atmospheres exist.
- Type 430 Stainless Steel, magnetic, .032" nominal thickness, brushed finish. Less corrosion-resistant than Type 302/304, but ideal for general service in high abuse applications in industrial plants, commercial, and institutional buildings.
- Chrome, Brushed and Polished Brass, .040" thick. 70% copper, 30% zinc alloy gives warm, appealing finish to modern decor as well as retrofit applications. Lacquered to prevent corrosion.
- Aluminum, .040" thick. Lustrous satin finish. Lacquered to prevent corrosion.
- Galvanized Steel. Used only for Handy Box Plates.
- Brushed Bronze, .040" thick. 90% copper, 10% zinc. Lacquered to prevent corrosion.

# WALL PLATES

## Dimensions

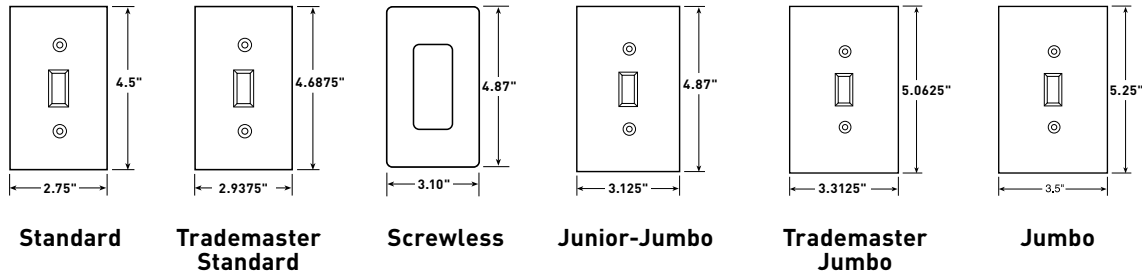

### Standard Size Wall Plates

- Standard size wall plates for all applications.
- Best fit for surface mount boxes.
- Available in plastic and metal only.

#### Dimensions

<b>1 gang</b>	2.75" x 4.5"
<b>2 gang</b>	4.56" x 4.5"
<b>3 gang</b>	6.375" x 4.5"
<b>4 gang</b>	8.125" x 4.5"
<b>5 gang</b>	10" x 4.5"
<b>6 gang</b>	11.812" x 4.5"
<b>7 gang</b>	13.62" x 4.5"
<b>8 gang</b>	15.44" x 4.5"

### TradeMaster® Wall Plates

- Extra 3/16" width and height than Standard size wall plates.
- Provide better sheet rock coverage with standard size appearance.
- Available in unbreakable nylon 6 construction only.
- Screws pre-installed in the duplex, toggle and decorator single gang plates.

#### Dimensions

<b>1 gang</b>	2.9375" x 4.6875"
<b>2 gang</b>	4.75" x 4.6875"
<b>3 gang</b>	6.563" x 4.6875"
<b>4 gang</b>	8.375" x 4.6875"
<b>5 gang</b>	10.188" x 4.6875"
<b>6 gang</b>	12" x 4.6875"

### Screwless Polycarbonate Wall Plates

- Available in decorator openings.
- Extra 1/8" width and height than Standard size wall plates.
- Provide better sheet rock coverage with standard size appearance.
- Molded of .065" thick polycarbonate.
- 2-piece plastic subplate made of polycarbonate.
- Available in 3 metallic finishes and 6 standard colors.

#### Wall Plate Dimensions

<b>1 gang</b>	3.10" x 4.87"
<b>2 gang</b>	4.912" x 4.87"
<b>3 gang</b>	6.724" x 4.87"
<b>4 gang</b>	8.536" x 4.87"

#### Subplate Dimensions

<b>1 gang</b>	2.85" x 4.62"
<b>2 gang</b>	4.662" x 4.62"
<b>3 gang</b>	6.474" x 4.62"
<b>4 gang</b>	8.286" x 4.62"

### Junior-Jumbo Wall Plates

- Extra 3/8" width and height than Standard size wall plates.
- Additional coverage for sheet rock gaps.
- Available in plastic and metal only.

#### Dimensions

<b>1 gang</b>	3.125" x 4.87"
<b>2 gang</b>	4.93" x 4.87"
<b>3 gang</b>	6.75" x 4.87"
<b>4 gang</b>	8.56" x 4.87"

### TradeMaster® Jumbo Wall Plates

- Extra 3/16" width and height than Junior-Jumbo size wall plates.
- Provide additional coverage for sheet rock gaps, matching the appearance of the TradeMaster Plates.
- Available in unbreakable nylon 6 construction only.
- Screws pre-installed in the duplex, toggle, and decorator single gang plates.

#### Dimensions

<b>1 gang</b>	3.3125" x 5.0625"
<b>2 gang</b>	5.125" x 5.0625"
<b>3 gang</b>	6.9375" x 5.0625"
<b>4 gang</b>	8.75" x 5.0625"

### Jumbo Wall Plates

- Extra 3/4" width and height than Standard size wall plates.
- Largest size wall plates to cover larger wall damage.
- Available in plastic and metal only.

#### Dimensions

<b>1 gang</b>	3.5" x 5.25"
<b>2 gang</b>	5.31" x 5.25"
<b>3 gang</b>	7.12" x 5.25"
<b>4 gang</b>	8.93" x 5.25"

# WALL PLATES

## Dimensions

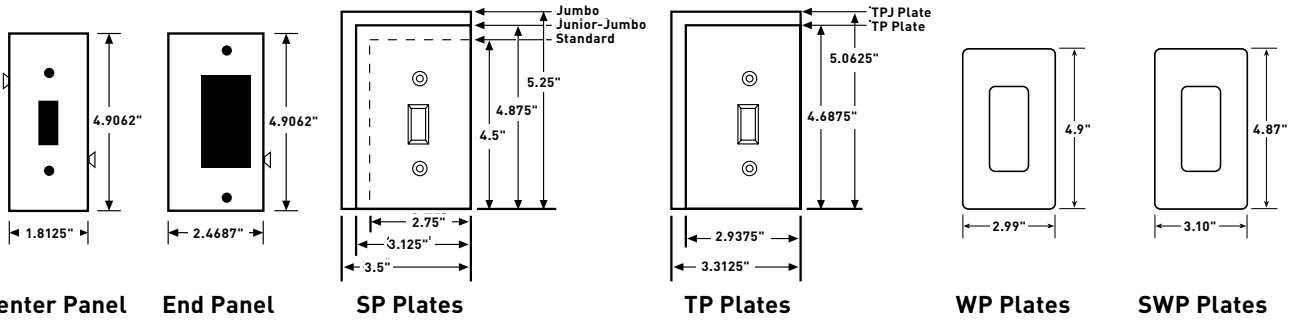

Center Panel   End Panel   SP Plates   TP Plates   WP Plates   SWP Plates

## Sectional Wall Plates

End and center panels with each of five most-used configurations make it possible to improvise custom wall plates on the job. Panels lock securely together on installation. Blank sections furnished with mounting strap.

## Wall Plate Mountings

Illustrated are the five standard methods of plate mounting. There are many other non-standard methods which depend upon the special device used. Exact mounting hole specifications for every device appear in the Selector Guide.

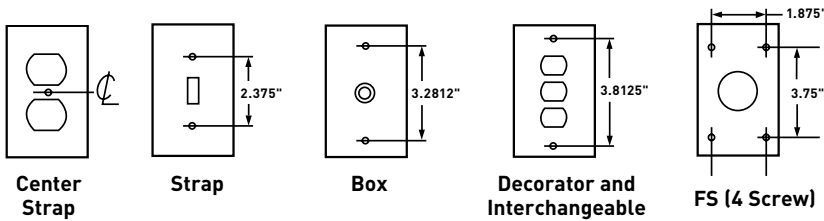

Center Strap   Strap   Box   Decorator and Interchangeable   FS (4 Screw)

## Wall Plate Sizes

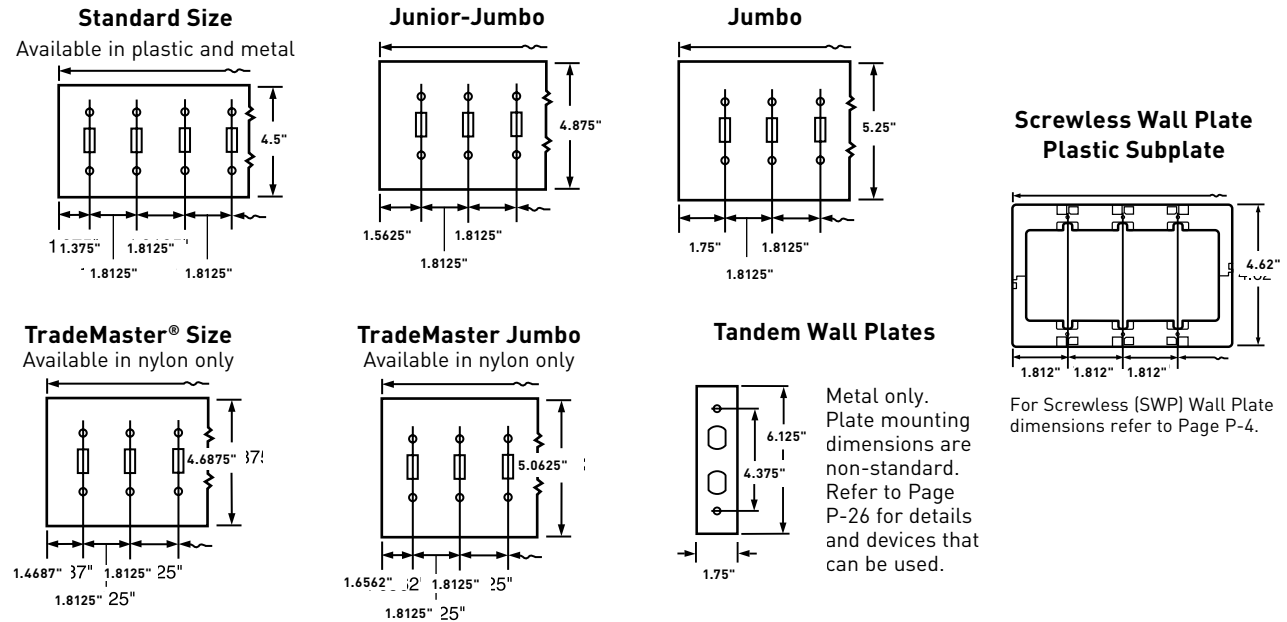

# WALL PLATES

## Decorative Finish Screwless Wall Plates Polycarbonate







**One Gang  
Nickel**

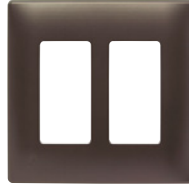

**One Gang  
Antique Brass**



**Two Gang  
Dark Bronze**

DESCRIPTION	COLOR	DECORATOR OPENINGS
<b>SCREWLESS DECORATOR OPENINGS PLASTIC SUBPLATE INCLUDED</b>		
<b>One Gang</b> 	Nickel Antique Brass Dark Bronze	SWP26NI SWP26ABBPCC10 SWP26DBBPCC10
<b>Two Gang</b> 	Nickel Antique Brass Dark Bronze	SWP262NI SWP262ABBPCC10 SWP262DBBPCC10
<b>Three Gang</b> 	Nickel Antique Brass Dark Bronze	SWP263NI SWP263ABBPCC10 SWP263DBBPCC10
<b>Four Gang</b> 	Nickel Antique Brass Dark Bronze	SWP264NI SWP264ABBPCC10 SWP264DBBPCC10

For Screwless Wall Plate and Plastic Subplate dimensions, see Pages P-4 and P-5.

These products listed to UL514, Cover Plates for Flush-Mounted Wiring Devices, CSA Certified.

# WALL PLATES

## Screwless Wall Plates Polycarbonate

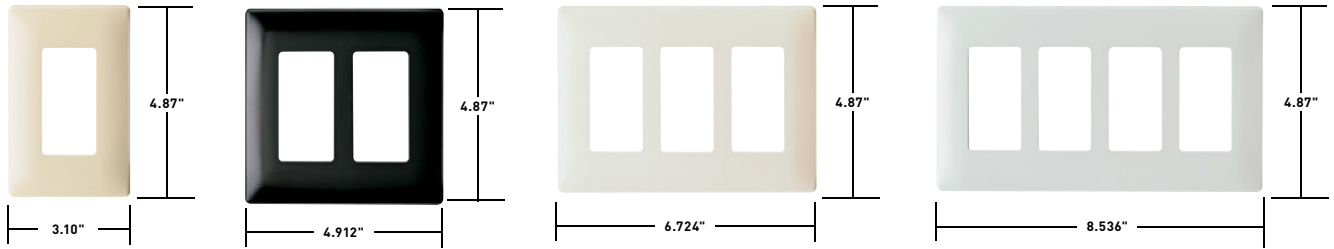

One Gang

Two Gang

Three Gang

Four Gang

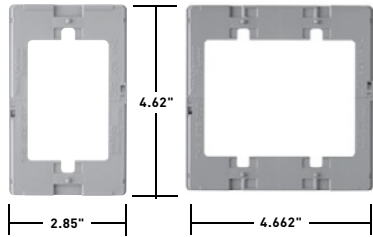

One Gang  
Plastic Subplate

Two Gang  
Plastic Subplate

DESCRIPTION	COLOR	DECORATOR OPENINGS
<b>SCREWLESS WALL PLATES PLASTIC SUBPLATE INCLUDED</b>		
<b>One Gang</b>	Ivory	SWP261
	White	SWP26W
	Brown	SWP26
	Gray	SWP26GRY
	Black	SWP26BK
<b>Two Gang</b>	Light Almond	SWP26LA
	Ivory	SWP2621
	White	SWP262W
	Brown	SWP262
	Gray	SWP262GRY
<b>Three Gang</b>	Black	SWP262BK
	Light Almond	SWP262LA
	Ivory	SWP2631
	White	SWP263W
	Brown	SWP263
<b>Four Gang</b>	Gray	SWP263GRY
	Black	SWP263BK
	Light Almond	SWP263LA
	Ivory	SWP2641
	White	SWP264W
<b>Plastic Subplate</b>	Brown	SWP264
	Gray	SWP264GRY
	Black	SWP264BK
	Light Almond	SWP264LA

DESCRIPTION	HEIGHT	WIDTH
<b>SCREWLESS DECORATOR OPENINGS PLASTIC SUBPLATE INCLUDED</b>		
<b>One Gang</b>	4.87"	3.10"
<b>Two Gang</b>	4.87"	4.912"
<b>Three Gang</b>	4.87"	6.724"
<b>Four Gang</b>	4.87"	8.536"

DESCRIPTION	HEIGHT	WIDTH
<b>SCREWLESS PLASTIC SUBPLATE DIMENSIONS</b>		
<b>One Gang</b>	4.62"	2.85"
<b>Two Gang</b>	4.62"	4.662"
<b>Three Gang</b>	4.62"	6.474"
<b>Four Gang</b>	4.62"	8.286"

# DEVICES & WALL PLATES

## Color Selection Chart

### Devices & Plastic Wall Plate Colors

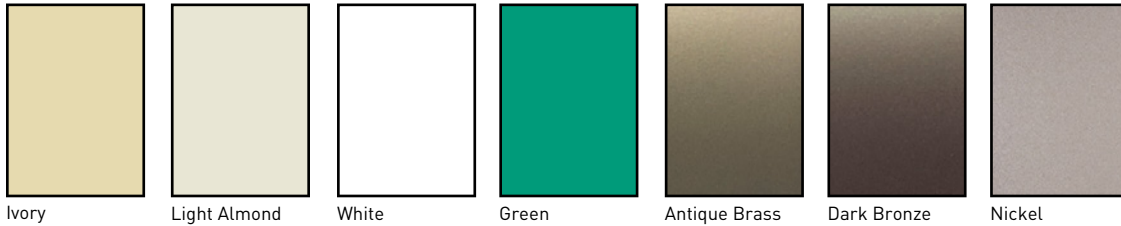

Ivory    Light Almond    White    Green    Antique Brass    Dark Bronze    Nickel

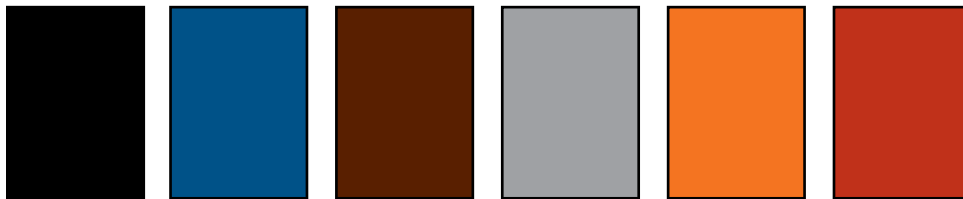

Black    Blue    Brown    Gray    Orange    Red

See specific device and wall plate catalog charts for particular color availabilities.

### Metal Wall Plates

Metal Finish

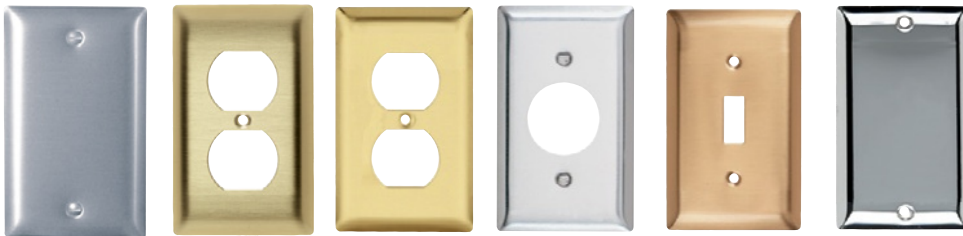

Aluminum    Brass (Brushed)    Polished Brass    Stainless Steel    Brushed Bronze    Chrome

### Custom Metal Wall Plates Paint Finish Colors

Paint Color

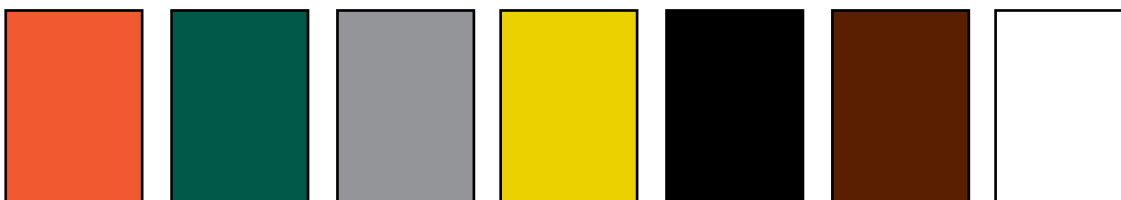

Orange    Green    Gray    Yellow    Glossy Black    Brown    White

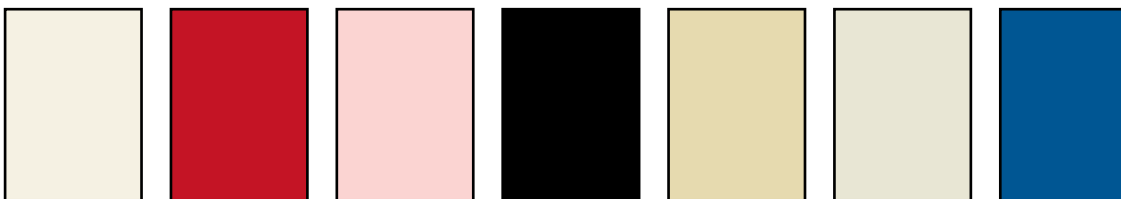

Primer    Red    Pink    Flat Black    Ivory    Light Almond    Blue

To order custom metal wall plates, see Pages P-40 – P-42.  
**For additional colors consult factory.**