

Project		Catalog #		Type	
Prepared by		Notes		Date	



HALO

SMD6 Series

6" Round and Square Surface Mount
Downlight
SMD6R & SMD6S

Typical Applications
Residential

Interactive Menu

- Order Information page 2
- Product Specifications page 5
- Photometric Data page 6
- Energy Data page 5
- Product Warranty

Top Product Features

- Ultra-low profile surface luminaire with wide distribution
- Ceiling or wall mounting in compatible junction boxes
- 600 & 1200 lumen; 2700K, 3000K, 3500K, 4000K or 5000K CCT; 90 CRI
- 120V only and Universal Voltage 120V – 277V options
- Dimmable with 120V dimmers

Product Certification



Refer to ENERGY STAR® Certified Products List.
Can be used to comply with California Title 24 High Efficacy requirements.
Certified to California Appliance Efficiency Database under JAB.

Product Features



Dimensional and Mounting Details

SMD6RXXXWH

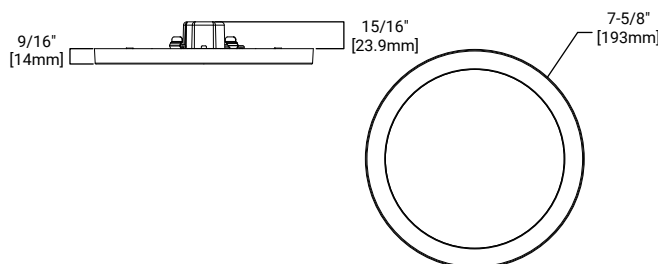

SMD6SXXXWH

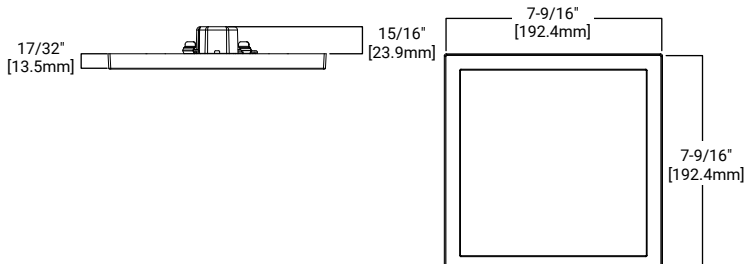

[additional product diagrams](#)

Dimensional and Mounting Details Continued

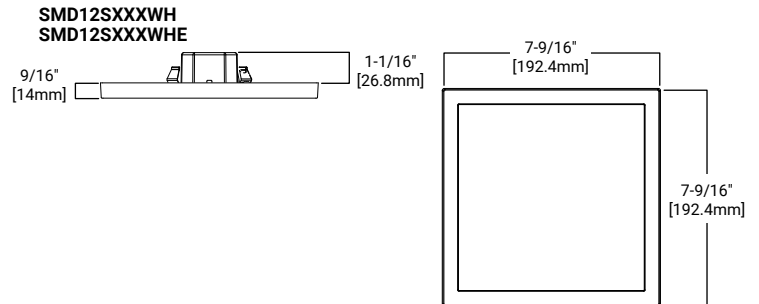
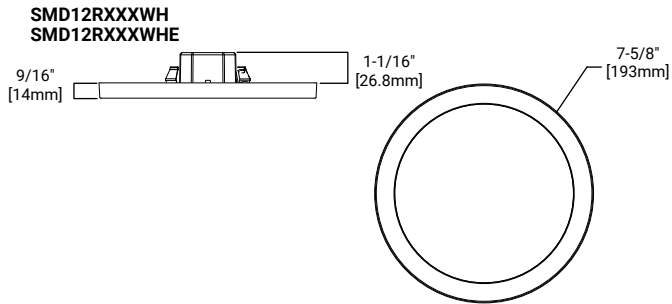

Ordering Information

SAMPLE NUMBER: **SMD6R6930WH** = 6" Round Surface Mount Downlight, 90CRI, 3000K

Junction Box Installation: Order junction box separately, as supplied by others, to complete installation.

Recessed Installation: Order Halo recessed housing separately to complete installation.

Models	Lumens	CRI/CCT	Finish	Voltage
Models SMD6R = 6" Round Surface Mount Downlight SMD6S = 6" Square Surface Mount Downlight	Lumens 6 = 600 lumen series (120V only) 12 = 1200 lumen series	CRI/CCT 927 = 90 CRI, 2700K 930 = 90 CRI, 3000K 935 = 90 CRI, 3500K 940 = 90 CRI, 4000K 950 = 90 CRI, 5000K	Finish WH = Matte White	Voltage Blank = 120V standard E = UNV Universal 120-277V*

Accessories

Accessories	
<p>Designer Trims SMD6RTRMSN = 6" Round SMD Satin Nickel SMD6RTRMTBZ = 6" Round SMD Tuscan Bronze SMD6RTRMWH = 6" Round SMD White (paintable)</p> <p>SMD6STRMSN = 6" Square SMD Satin Nickel SMD6STRMTBZ = 6" Square SMD Tuscan Bronze SMD6STRMWH = 6" Square SMD White (paintable)</p> <p>T24HWKIT = Title 24 Cable harness kit used to convert incandescent and low voltage housings to LED HE26LED = E26 Screw base adapter for retrofit (included)</p>	<p>T24HWKIT</p> <p>HE26LED E26 Screw base adapter for retrofit (included)</p>

* UNV voltage configuration is offered only in the 1200 lumen series

Housing Compatibility

The SMD6 is UL Certified in Halo recessed housings and for use with **any** 5 or 6 inch diameter recessed housing constructed of steel or aluminum with an internal volume that exceeds 107.9 in3 in addition to those noted below. **Note:** Some other's housings require installation with included friction clips.

Housings	Housings
Compatible Halo LED Housings with LED luminaire connector (high-efficacy compliant)	Compatible Halo Incandescent E26 Screwbase Housings
<p>Halo LED 5-inch H550ICAT = 5" LED, Insulated Ceiling, Air-Tite, New Construction Housing H550RICAT = 5" LED, Insulated Ceiling, Air-Tite, Remodel Housing E550ICAT = 5" LED, Insulated Ceiling, Air-Tite, New Construction Housing E550RICAT = 5" LED, Insulated Ceiling, Air-Tite, Remodel Housing</p> <p>Halo LED 6-inch H750ICAT = 6" LED, Insulated Ceiling, Air-Tite, New Construction Housing H750RICAT = 6" LED, Insulated Ceiling, Air-Tite, Remodel Housing H750T = 6" LED, Non-IC, Air-Tite, New Construction Housing H750TCP = 6" LED, Non-IC, New Construction/Remodel Chicago Plenum Housing H2750ICAT = 6" LED, Shallow, Insulated Ceiling, Air-Tite, New Construction (use with 691X, 694X, 696X trims only) H2750RICAT = 6" LED, Shallow, Insulated Ceiling, Air-Tite, Remodel (use with 691X, 694X, 696X trims only) E750ICAT = 6" LED, Insulated Ceiling, Air-Tite, New Construction Housing E750RICAT = 6" LED, Insulated Ceiling, Air-Tite, Remodel Housing</p> <p>Halo LED retrofit ML7E26RFK = 6" Retrofit Enclosure, Non-IC, E26 Screw base Interface ML7BXFK = 6" Retrofit Enclosure, Non-IC, BX Whip</p>	<p>Halo Standard Housings 5-inch H5ICAT = 5" Insulated Ceiling, Air-Tite New Construction Housing H5RICAT = 5" Insulated Ceiling, Air-Tite Remodel Housing H5ICATNB = 5" Insulated Ceiling, Air-Tite New Construction Housing, No Socket Bracket H5T = 5" Non-IC, New Construction Housing H5RT = 5" Non-IC, Remodel Housing H5TNB = 5" Non-IC, New Construction Housing, No Socket Bracket H25ICAT = 5" Shallow, Insulated Ceiling, Air-Tite New Construction H25RICAT = 5" Shallow, Insulated Ceiling, Air-Tite Remodel H25ICATNB = 5" Shallow, Insulated Ceiling, Air-Tite New Construction, No Socket Bracket E5ICAT = 5" Insulated Ceiling, Air-Tite New Construction Housing E5RICAT = 5" Insulated Ceiling, Air-Tite Remodel Housing E5ICATNB = 5" Insulated Ceiling, Air-Tite New Construction Housing, No Socket Bracket E5TAT = 5" Non-IC, New Construction Housing E5RTAT = 5" Non-IC, Remodel Housing E5TATNB = 5" Non-IC, New Construction Housing, No Socket Bracket</p> <p>Halo Standard Housings 6-inch H7ICAT = 6" Insulated Ceiling, Air-Tite New Construction Housing H7RICAT = 6" Insulated Ceiling, Air-Tite Remodel Housing H7ICT = 6" Insulated Ceiling, New Construction Housing H7RICT = 6" Insulated Ceiling, Remodel Housing H7ICATNB = 6" Insulated Ceiling, Air-Tite New Construction Housing, No Socket Bracket H7ICTNB = 6" Insulated Ceiling, New Construction Housing, No Socket Bracket H7T = 6" Non-IC, New Construction Housing H7RT = 6" Non-IC, Remodel Housing H7TNB = 6" Non-IC, New Construction Housing, No Socket Bracket H7TCP = 6" Non-IC, Chicago Plenum, New Construction/Remodel Housing H7UICAT = 6" Insulated Ceiling, Universal, Air-Tite, New Construction Housing E7ICAT = 6" Insulated Ceiling, Air-Tite New Construction Housing E7RICAT = 6" Insulated Ceiling, Air-Tite Remodel Housing E7ICATNB = 6" Insulated Ceiling, Air-Tite New Construction Housing, No Socket Bracket E7TAT = 6" Non-IC, New Construction Housing E7RTAT = 6" Non-IC, Remodel Housing E7TATNB = 6" Non-IC, New Construction Housing, No Socket Bracket E27TAT = 6" Shallow, Non-IC, New Construction Housing E27RTAT = 6" Shallow, Non-IC, Remodel Housing</p>

JUNCTION BOX COMPATIBILITY

***Note:** SMD 120-277V UNV configuration is only compatible with junction boxes that provide a minimum depth of 2-1/8". Junction boxes meeting these requirements listed below.

EATON'S CROUSE-HINDS JUNCTION BOXES



TP316*
for non-metallic cable
4" x 4" x 2-1/8"
(102mm x 102mm x 54mm)



TP317*
for metal clad cable
4" x 4" x 2-1/8"
(102mm x 102mm x 54mm)

- **TP316** - for non-metallic cable
- **TP317** - for metal clad cable
- UL Listed
- Refer to www.crouse-hinds.com

OTHER'S JUNCTION BOXES*



4" octagon light fixture/fan steel box*
4" x 4" x 2-1/8"
(102mm x 102mm x 54mm)



4" octagon steel box
4" x 4" x 1-1/2"
(102mm x 102mm x 38mm)



4" square deep steel box*
4" x 4" x 2-1/8"
(102mm x 102mm x 54mm)



4" square standard steel box
4" x 4" x 1-1/2"
(102mm x 102mm x 38mm)



4" round new work non-metallic light fixture/fan box*
4" diameter x 2-3/16"
(102mm x 56mm)



3-1/2" round new work non-metallic ceiling box*
3-1/2" diameter x 2-3/4"
(89mm x 70mm)



3-1/2" round old work* non-metallic box
4-1/4" O.D. flange, 3-1/2" I.D. x 2-5/8"
(108mm O.D., 89mm I.D. x 67mm)



4" round surface mount box
4" diameter x 1-1/2"
(102mm x 38mm)
Requires SLD6RAD adapter



4" round new work non-metallic box with hanger bar assembly
4" diameter x 2-3/16" (102mm x 56mm)

*This is a representative list of compatible junction boxes only. Information contained in this literature about other manufacturers' products is from published information made available by the manufacturer and is deemed to be reliable, but has not been verified. Cooper Lighting Solutions makes no specific recommendation on product selection and there are no warranties of performance or compatibility implied. Installer must determine that site conditions are suitable to allow proper installation of the mounting bracket in the box.

Energy Data

SMD6R6 SMD6S6

	Round	Square
Lumens (5000K models)	788	815
Input Power	9.6 W	9.9 W
Input Current	0.0811 A	0.085 A
Efficiency	82 lm/W	82 lm/W
THD	13.9	14.7
Input Voltage	120V	
Frequency	50/60 Hz	
CRI	90 CRI	
Power Factor	0.99	
T Ambient	-30 - +40°C	
Sound Rating	Class A	

SMD6R12 SMD6S12

	Round	Square
Lumens (5000K models)	1252	1235
Input Power	15.3	15.7
Input Current	0.133 A	0.132 A
Efficiency	82 lm/W	79 lm/W
THD	15.3	15.7
Input Voltage	120V	
Frequency	50/60 Hz	
CRI	92 CRI	
Power Factor	0.98	
T Ambient	-30 - +40°C	
Sound Rating	Class A	

SMD6R12-E SMD6S12-E

	Round	Square
Lumens (5000K models)	1200	1180
Input Power	15.3	16
Input Current	0.133 A – (120V) 0.061 A – (277V)	0.132 A – (120V) 0.061 A – (277V)
Efficiency	78	73
THD	15.3	15.7
Input Voltage	120 - 277V	
Frequency	60 Hz	
CRI	92 CRI	
Power Factor	0.99	
T Ambient	-30 - +40°C	
Sound Rating	Class A	

Product Specifications

Housing

- Non-electrically conductive polycarbonate frame.
- High impact diffuse polystyrene lens provides shielding to the light guide with no pixilation
- Stamped aluminum housing provides thermal cooling achieving L70 at 50,000 hours in IC and non-IC applications

Gaskets

- Closed cell gasket achieves restrictive airflow and wet location requirements without additional caulking

Optics

- Precision acrylic light guide organizes source flux into wide distribution with 1.2 – 1.4 spacing criteria useful for general area illumination

LED

- Mid power LED array provide a uniform source with high efficiency and long life
- Available in 90 CRI minimum, R9 greater than 50 and color accuracy within 3 SDCM provide color accuracy and uniformity

Driver

SMD 120V

- Integral 120V 50/60Hz constant current driver provides noise free operation
- Continuous, flicker-free dimming from 100% to 5% with select leading or trailing edge 120V phase cut dimmers
- Dimming to 5% is best assured using dimmers with low end trim adjustment. Consult dimmer manufacturer for compatibility and conditions of use. (Note some dimmers require a neutral in the wallbox.)
- Inline electrical quick connect and E26 adapter (provided) provides mains connections

SMD 120-277V

- Integrated 120-277V 60Hz constant current driver provides noise free operation
- SMD Universal Voltage (120-277V) configurations are recommended for use with compatible 0-10V DC
- low voltage dimmers only

Mounting/Retention

- Adjustable spider plate allows for quick installation into both junction boxes and recessed housings
- Torsion springs and friction blades included

Electrical Junction Box Mounting

- The SMD may be used in compatible electrical junction boxes in direct contact with insulation including spray foam insulation
- Suitable for installation in many 3-1/2" and 4" square, octagon, and round electrical junction boxes
Note: SMD120-277V UNV is only compatible with junction boxes that provide minimum depth of 2-1/8"
- Installer must ensure compatibility of fit, wiring and proper mounting in the electrical junction box. This includes all applicable national and local electrical and building coded

Recessed Housing Mounting

- May be installed in IC recessed housings in direct contact with insulation
Note: Not for use in recessed housing in direct contact with spray foam insulation. Refer to NEMA LSD 57-2013

Torsion Spring 5" & 6"

- Precision formed torsion spring bracket kit included
- The torsion springs adjust on the mounting plate to fit 5" or 6" compatible housings

Friction Blade 5" & 6"

- Precision formed friction blades included
- For retrofit in 5" and 6" housings without torsion springs mounting tabs
- Friction blade design allows the SMD to be installed in any position within the housing aperture (360 degrees)

DESIGNER SKINS (SOLD SEPARATELY)

- SMD skins are accessory rings in both round and square. These skins attach to the SMD for a permanent finish. Refer to the SMD accessories specification sheet for details
 - Matte White (Paintable)
 - Satin Nickel
 - Tuscan Bronze

Compliance

- cULus Certified for use with Halo housings and for use with other's housings, see instruction sheet for conditions of acceptability
- Wet and Damp Location listed, airtight per ASTM-E283
- Suitable for use in closets, compliant with NFPA® 70, NEC® Section 410.16 (A)(3) and 410.16 (C)(5)
- EMI/RFI emissions per FCC 47CFR Part 15B
- Contains no mercury or lead and RoHS compliant.
- Photometric testing in accordance with IES LM-79-08
- Lumen maintenance projections in accordance with IES LM-80-08 and TM-21-11
- Can be used for State of California Title 24 high efficacy luminaire compliance, reference the California Energy Commission Title 20 Appliance Efficiency Database for current listings
- Can be used for International Energy Conservation Code (IECC) and high efficiency luminaire compliance
- ENERGY STAR® listed, reference database for current listings

Warranty

- Five year limited warranty, consult website for details. www.cooperlighting.com/warranty

Photometric Data – SMD6 (120V)

SMD6R6927WH		
Luminaire lumens	750	
Input watts	9.4	
LER (LPW)	80	
Spacing Criteria	0-180	1.26
	90-270	1.26
	Diagonal	1.38
Beam angle (degrees)	112	
Field angle (degrees)	162	
Max. Candela	264	
Zonal lumen	Lumens	% Lumens
0-30	204	27.2%
0-40	334	44.5%
0-60	590	78.6%
0-90	750	100.00%

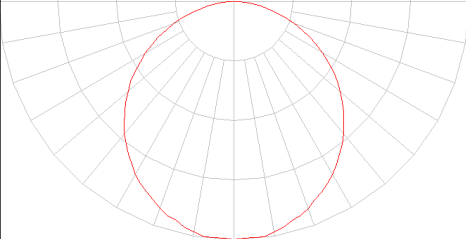

SMD6S6927WH		
Luminaire lumens	750	
Input watts	10.0	
LER (LPW)	75	
Spacing Criteria	0-180	1.24
	90-270	1.24
	Diagonal	1.36
Beam angle (degrees)	112	
Field angle (degrees)	162	
Max. Candela	271	
Zonal lumen	Lumens	% Lumens
0-30	207	27.6%
0-40	337	44.9%
0-60	590	78.6%
0-90	750	100.00%

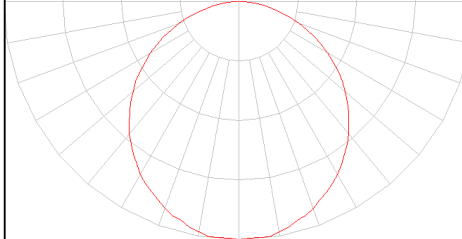

Cat. No.	CRI	CCT	Lumens	Power (W)	LPW
SMD6R6927WH	93	2700	754	9.6	78.5
SMD6R6930WH	92	3000	758	9.6	78.7
SMD6R6935WH	95	3500	740	9.6	77.0
SMD6R6940WH	94	4000	792	9.8	80.5
SMD6R6950WH	92	5000	788	9.6	81.9
SMD6S6927WH	92	2700	750	10.0	75.0
SMD6S6930WH	92	3000	790	9.9	79.8
SMD6S6935WH	93	3500	740	10.0	74.0
SMD6S6940WH	93	4000	760	10.3	73.8
SMD6S6950WH	90	5000	815	9.9	82.3

Foot-candle Values at Nadir 0 degree Aiming Angle			
DD (FT)	SMD6R6927WH (FC)	SMD6S6927WH (FC)	DIA (FT)
5.5	8.7	9.0	16.3
7	5.4	5.5	20.9
8	4.1	4.2	23.8
9	3.3	3.3	26.8
10	2.6	2.7	29.7
12	1.8	1.9	35.7

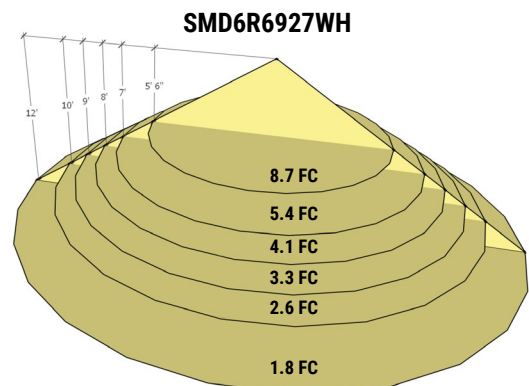

Multiplier Table					
CCT Option	2700K	3000K	3500K	4000K	5000K
CCT Multiplier	1.00	1.014	1.042	1.083	1.083

DD = distance down to illuminated work plane
 FC = initial foot-candles at nadir
 DIA = diameter

Photometric Data – SMD6-1200 (120V)

SMD6S12927WH		
Luminaire lumens	1187	
Input watts	15.9	
LER (LPW)	75	
Spacing Criteria	0-180	1.26
	90-270	1.26
	Diagonal	1.38
Beam angle (degrees)	113	
Field angle (degrees)	165	
Max. Candela	408	
Zonal lumen	Lumens	% Lumens
0-30	316	26.6%
0-40	518	43.7%
0-60	920	77.5%
0-90	1187	100.00%

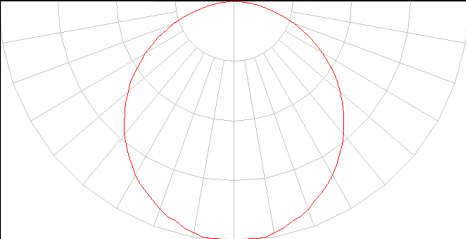

SMD6R12927WH		
Luminaire lumens	1235	
Input watts	15.9	
LER (LPW)	78	
Spacing Criteria	0-180	1.26
	90-270	1.26
	Diagonal	1.38
Beam angle (degrees)	113	
Field angle (degrees)	164	
Max. Candela	426	
Zonal lumen	Lumens	% Lumens
0-30	336	27.2%
0-40	550	44.5%
0-60	971	78.6%
0-90	1235	100.00%

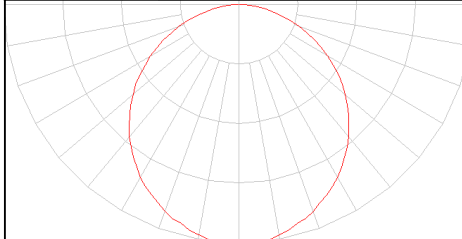

Cat. No.	CRI	CCT	Lumens	Power (W)	LPW
SMD6R12927WH	92	2700	1244	15.7	79.0
SMD6R12930WH	92	3000	1242.0	15.1	82.1
SMD6R12935WH	92	3500	1264.1	15.3	82.8
SMD6R12940WH	92	4000	1223.0	15.3	79.9
SMD6R12950WH	92	5000	1252.0	15.3	81.9
SMD6S12927WH	92	2700	1190	15.7	76.0
SMD6S12930WH	92	3000	1180.3	15.6	75.6
SMD6S12935WH	92	3500	1237.3	15.6	79.5
SMD6S12940WH	92	4000	1215.9	15.8	76.9
SMD6S12950WH	92	5000	1235.6	15.7	78.9

Foot-candle Values at Nadir 0 degree Aiming Angle			
DD (FT)	SMD6R12927WH (FC)	SMD6S12927WH (FC)	DIA (FT)
5.5	15.8	15.1	16.6
7	9.5	9.1	21.1
8	7.2	6.9	24.2
9	5.6	5.4	27.2
10	4.5	4.3	30.2
12	3.1	3.0	36.2

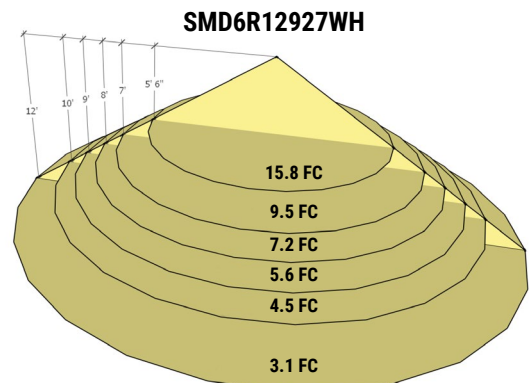

DD = distance down to illuminated work plane
 FC = initial foot-candles at nadir
 DIA = diameter

Multiplier Table					
CCT Option	2700K	3000K	3500K	4000K	5000K
CCT Multiplier	1.000	0.997	1.039	1.021	1.037

Photometric Data – SMD6-1200-E (120V-277V)

SMD6R12927WHE		
Luminaire lumens	1210	
Input watts	15.4	
LER (LPW)	78.6	
Spacing Criteria	0-180	1.26
	90-270	1.26
	Diagonal	1.38
Beam angle (degrees)	112.8	
Field angle (degrees)	164	
Max. Candela	418.7	
Zonal lumen	Lumens	% Lumens
0-30	324	26.8%
0-40	531	43.9%
0-60	941	77.8%
0-90	1210	100.00%

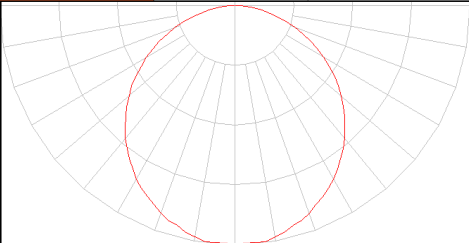

SMD6S12927WHE		
Luminaire lumens	1167	
Input watts	15.6	
LER (LPW)	74.8	
Spacing Criteria	0-180	1.26
	90-270	1.26
	Diagonal	1.38
Beam angle (degrees)	113.5	
Field angle (degrees)	165	
Max. Candela	402.1	
Zonal lumen	Lumens	% Lumens
0-30	284	24.3%
0-40	467	40.0%
0-60	838	71.8%
0-90	1167	100.00%

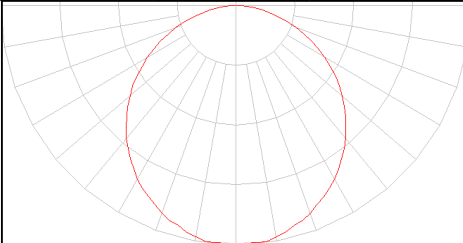

Cat. No.	CRI	CCT	Lumens	Power (W)	LPW
SMD6R12927WHE	92	2700	1210	15.4	78.6
SMD6R12930WHE	92	3000	1203.0	15.3	78.6
SMD6R12935WHE	92	3500	1200.0	15.4	77.9
SMD6R12940WHE	92	4000	1260.0	15.3	82.4
SMD6R12950WHE	92	5000	1200.0	15.3	78.4
SMD6S12927WHE	92	2700	1167	15.6	74.8
SMD6S12930WHE	92	3000	1135.0	15.9	71.4
SMD6S12935WHE	92	3500	1140.0	16.0	71.2
SMD6S12940WHE	92	4000	1155.0	15.9	72.6
SMD6S12950WHE	92	5000	1180.0	16.0	73.7

Foot-candle Values at Nadir 0 degree Aiming Angle			
DD (FT)	SMD6R12927WHE (FC)	SMD6S12927WHE (FC)	DIA (FT)
5.5	13.8	13.3	6.8
7	8.5	8.2	8.6
8	6.5	6.3	10
9	5.2	5.0	11.2
10	4.2	4.0	12.4
12	2.9	2.8	15

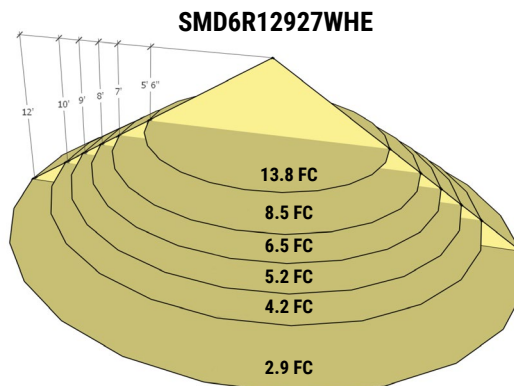

DD = distance down to illuminated work plane
 FC = initial foot-candles at nadir
 DIA = diameter

Multiplier Table					
CCT Option	2700K	3000K	3500K	4000K	5000K
CCT Multiplier	1.0000	0.994	0.992	1.041	0.992