

DESCRIPTION

The Halo Surface Mount LED Downlight (SMD) is an low profile surface mounting luminaire with a modern look and high performance. SMD4 (4") is designed for installation in many 3-1/2" and 4" square, octagon, or round junction boxes. Supply wire adapter with LED quick wiring connector included. The SMD4 may also retrofit in 4" aperture IC and Non-IC recessed housings.

| | | |
|-------------|--|------|
| Catalog # | | Type |
| Project | | |
| Comments | | Date |
| Prepared by | | |

SPECIFICATION FEATURES

HOUSING

- Non-electrically conductive polycarbonate frame.
- High impact diffuse polystyrene lens provides shielding to the light guide with no pixilation
- Stamped aluminum housing provides thermal cooling achieving L70 at 50,000 hours in IC and non-IC applications

GASKETS

- Closed cell gasket achieves restrictive airflow and wet location requirements without additional caulking

OPTICS

- Precision acrylic light guide organizes source flux into wide distribution with 1.2 – 1.4 spacing criteria useful for general area illumination

LED

- Mid power led array provide a uniform source with high efficiency and long life.
- Available in 90 CRI minimum, R9 greater than 50 and color accuracy within 3 SDCM provide color accuracy and uniformity

DRIVER

- Integral 120V 50/60Hz constant current driver provides noise free operation.
- Continuous, flicker-free dimming from 100% to 5% with select leading or trailing edge 120V phase cut dimmers.
- Dimming to 5% is best assured using dimmers with low end trim adjustment. Consult dimmer manufacturer for compatibility and conditions of use. (Note some dimmers require a neutral in the wallbox.)
- Inline electrical quick connect and E26 adapter (provided) provides mains connections.

MOUNTING/RETENTION

- Adjustable spider plate allows for quick installation into both junction boxes and recessed housings.
- Torsion springs or friction blades included

ELECTRICAL JUNCTION BOX MOUNTING

- The SMD may be used in compatible electrical junction boxes in direct contact with insulation including spray foam insulation.
- Suitable for installation in many 3-1/2" and 4" square, octagon, and round electrical junction boxes.
- Surface mounting in a fire-rated ceiling using an appropriate fire rated electrical box .
Note: Fire-rating is per the rating of the ceiling and applicable junction box, not the SMD.
- Installer must ensure compatibility of fit, wiring and proper mounting in the electrical junction box. This includes all applicable national and local electrical and building coded

RECESSED HOUSING MOUNTING

- May be installed in IC recessed housings in direct contact with insulation
Note: Not for use in recessed housing in direct contact with spray foam insulation. Refer to NEMA LSD 57-2013.

Friction Blade 4"

- Precision formed friction blades included
- For retrofit in 4" nominal housings
- Friction blade design allows the SMD to be installed in any position within the housing aperture (360 degrees)

DESIGNER SKINS (SOLD SEPARATELY)

- SMD skins are accessory rings in both round and square. These skins attach to the SMD for a permanent finish. Refer to the SMD accessories specification sheet for details.
- Matte White (Paintable)
- Satin Nickel
- Tuscan Bronze

WARRANTY

- Five year limited warranty, consult website for details.
www.eaton.com/lighting/legal

COMPLIANCE

- cULus listed / certified for use with Halo housings, classified for use with other's housings, see instruction sheet for conditions of acceptability.
- Wet and Damp Location listed, airtight per ASTM-E283
- Suitable for use in clothes closets when installed in accordance with the NEC 410.16 spacing requirements.
- EMI/RFI emissions per FCC 47CFR Part 15B
- Contains no mercury or lead and RoHS compliant.
- Photometric testing in accordance with IES LM-79-08
- Lumen maintenance projections in accordance with IES LM-80-08 and TM-21-11.
- Can be used for State of California Title 24 high efficacy luminaire compliance, reference the California Energy Commission Title 20 Appliance Efficiency Database for current listings.
- Can be used for International Energy Conservation Coe (IECC) and Washington State Energy Code high efficiency luminaire compliance

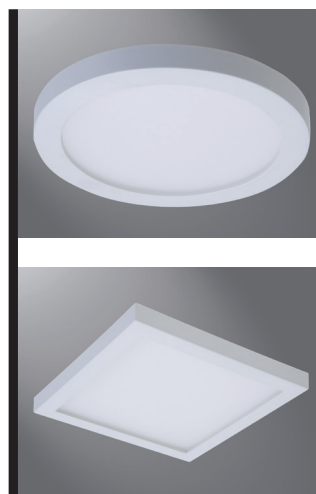

SMD4 Series

4 inch Round and Square

SMD4R
SMD4S

4" Surface Mount Downlight

Suitable for ceiling or wall electrical junction boxes

Suitable for 4" recessed housing retrofit

ENERGY DATA

| | Round | Square |
|-----------------------|-------------|----------|
| Lumens (5000K models) | 786 | 810 |
| Input Power | 9.7 W | 10 W |
| Input Current | 0.0811 A | 0.0829 A |
| Efficiency | 81 lm/W | 81 lm/W |
| THD | 13.3 | 13.2 |
| Input Voltage | 120V | |
| Frequency | 50/60 Hz | |
| CRI | 90 CRI | |
| Power Factor | 0.99 | |
| T Ambient | -30 - +40°C | |
| Sound Rating | Class A | |



Refer to ENERGY STAR® Qualified Products List.
Can be used to comply with California Title 24 High Efficacy requirements.
Certified to California Appliance Efficiency Database under JA8.

DIMENSIONS

SMD4RXXWH



SMD4SXXWH



ORDERING INFORMATION

SAMPLE NUMBER: SMD4R6930WH=4" Round Surface Mount Downlight, 90CRI, 3000K

Junction Box Installation: Order junction box separately, as supplied by others, to complete installation.

Recessed Installation: Order Halo recessed housing separately to complete installation.

| Models | Lumens | CRI / CCT | Finish | Accessories |
|---|----------------------------|--|-----------------------|--|
| SMD4R = 4" Round Surface Mount Downlight, 120V SMD4S = 4" Square Surface Mount Downlight, 120V | 6 =600 lumen series | 927 =90CRI, 2700K 930 =90CRI, 3000K 935 =90CRI, 3500K 940 =90CRI, 4000K 950 =90CRI, 5000K | WH =Mate White | <u>Designer Trims</u> SMD4RTRMSN =4" Round SMD Satin Nickel SMD4RTRMTBZ =4" Round SMD Tuscan Bronze SMD4RTRMWH =4" Round SMD White (paintable) SMD4STRMSN =4" Square SMD Satin Nickel SMD4STRMTBZ =4" Square SMD Tuscan Bronze SMD4STRMWH =4" Square SMD White (paintable) |

ACCESSORIES

Designer Trims



SMD4STRMWH
square, white (paintable)



SMD4STRMSN
square, satin nickel

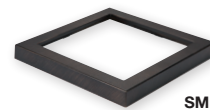

SMD4STRMTBZ
square, tuscan bronze



SMD4RTRMWH
round, white (paintable)



SMD4RTRMSN
round, satin nickel



SMD4RTRMTBZ
round, tuscan bronze

HOUSING COMPATIBILITY

The SMD4 is UL Listed in Halo and All-Pro recessed housings, and is UL Classified for use with any 4 inch diameter recessed housing constructed of steel or aluminum with an internal volume that exceeds 62.3 in³ in addition to those noted below:

| Compatible Halo LED Housings with LED luminaire connector (high-efficacy compliant) | | |
|---|-------------------|---|
| HALO LED | Recessed Can Size | Catalog Number |
| | | 4" |
| Compatible Halo Incandescent E26 Screwbase Housings | | |
| HALO | Recessed Can Size | Catalog Number |
| | 4" | H99ICAT, H99TAT, H99RTAT, E4ICATSB, E4TATSB, E4RTATSB |
| Compatible All-Pro Incandescent E26 Screwbase Housings | | |
| ALL-PRO | Recessed Can Size | Catalog Number |
| | 4" | EI400ATSB, ET400ATSB, ET400RATSB |

COMPATIBLE WITH EATON'S CROUSE-HINDS JUNCTION BOXES

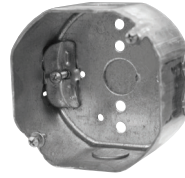

TP316
for non-metallic cable
4" x 4" x 2-1/8"
(102mm x 102mm x 54mm)

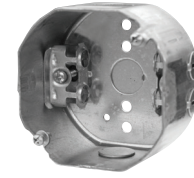

TP317
for metal clad cable
4" x 4" x 2-1/8"
(102mm x 102mm x 54mm)

- **TP316** - for non-metallic cable
- **TP317** - for metal clad cable
- UL Listed
- Suitable for two-hour fire-rated ANSI/UL 263 when properly installed in a fire-rated ceiling or wall
- Refer to www.crouse-hinds.com

COMPATIBLE WITH MANY OTHER JUNCTION BOXES*



4" octagon light fixture/fan steel box
4" x 4" x 2-1/8"
(102mm x 102mm x 54mm)

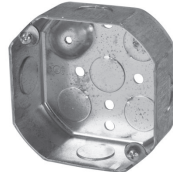

4" octagon steel box
4" x 4" x 1-1/2"
(102mm x 102mm x 38mm)



4" square deep steel box
4" x 4" x 2-1/8"
(102mm x 102mm x 54mm)



4" square standard steel box
4" x 4" x 1-1/2"
(102mm x 102mm x 38mm)



4" round new work non-metallic light fixture/fan box
4" diameter x 2-3/16"
(102mm x 56mm)



3-1/2" round new work non-metallic ceiling box
3-1/2" diameter x 2-3/4"
(89mm x 70mm)



3-1/2" round old work non-metallic box
4-1/4" O.D. flange, 3-1/2" I.D. x 2-5/8"
(108mm O.D., 89mm I.D. x 67mm)



4" round surface mount box
4" diameter x 1-1/2"
(102mm x 38mm)
Requires SLD4RAD adapter



4" round new work non-metallic box with hanger bar assembly
4" diameter x 2-3/16" (102mm x 56mm)

Surface mounting in a fire-rated ceiling using an appropriate electrical box offers a cost-effective alternative to fire-rated recessed housings.

Note: Fire-rating is per the rating of the ceiling and applicable junction box, not the SMD.

*This is a representative list of compatible junction boxes only. Information contained in this literature about other manufacturers' products is from published information made available by the manufacturer and is deemed to be reliable, but has not been verified. Eaton makes no specific recommendation on product selection and there are no warranties of performance or compatibility implied. Installer must determine that site conditions are suitable to allow proper installation of the mounting bracket in the box.

PHOTOMETRIC DATA

| SMD4R6927WH | | |
|-----------------------|----------|----------|
| Luminaire lumens | 690 | |
| Input watts | 9.5 | |
| LER (LPW) | 73 | |
| Spacing Criteria | 0-180 | 1.26 |
| | 90-270 | 1.26 |
| | Diagonal | 1.38 |
| Beam angle (degrees) | 112 | |
| Field angle (degrees) | 162 | |
| Max. Candela | 243 | |
| Zonal lumen | Lumens | % Lumens |
| 0-30 | 187 | 27.2% |
| 0-40 | 306 | 44.5% |
| 0-60 | 542 | 78.6% |
| 0-90 | 690 | 100.00% |

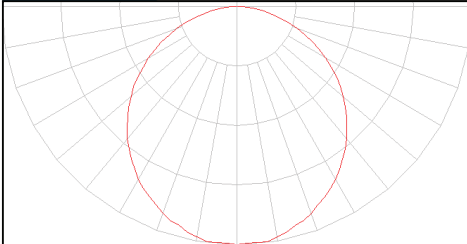

| SMD4S6927WH | | |
|-----------------------|----------|----------|
| Luminaire lumens | 750 | |
| Input watts | 9.5 | |
| LER (LPW) | 79 | |
| Spacing Criteria | 0-180 | 1.24 |
| | 90-270 | 1.24 |
| | Diagonal | 1.36 |
| Beam angle (degrees) | 109 | |
| Field angle (degrees) | 162 | |
| Max. Candela | 278 | |
| Zonal lumen | Lumens | % Lumens |
| 0-30 | 207 | 27.6% |
| 0-40 | 336 | 44.9% |
| 0-60 | 589 | 78.6% |
| 0-90 | 750 | 100.00% |

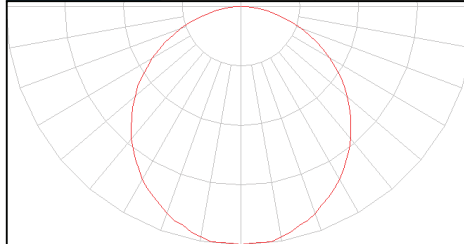

| Cat. No. | CRI | CCT | Lumens | Power (W) | LPW |
|-------------|-----|------|--------|-----------|------|
| SMD4R6927WH | 93 | 2700 | 690 | 9.50 | 72.6 |
| SMD4R6930WH | 93 | 3000 | 700 | 9.70 | 72.2 |
| SMD4R6935WH | 94 | 3500 | 740 | 9.70 | 76.3 |
| SMD4R6940WH | 94 | 4000 | 760 | 9.80 | 77.6 |
| SMD4R6950WH | 91 | 5000 | 786 | 9.70 | 81.0 |
| SMD4S6927WH | 92 | 2700 | 750 | 9.50 | 78.9 |
| SMD4S6930WH | 92 | 3000 | 790 | 9.90 | 79.8 |
| SMD4S6935WH | 93 | 3500 | 740 | 9.90 | 74.7 |
| SMD4S6940WH | 93 | 4000 | 800 | 10.10 | 79.2 |
| SMD4S6950WH | 90 | 5000 | 810 | 10.00 | 81.0 |

| Foot-candle Values at Nadir 0 degree Aiming Angle | | | |
|--|---------------------|---------------------|-------------|
| DD (FT) | SMD4R6927WH (FC) | SMD4S6927WH (FC) | DIA (FT) |
| 5.5 | 8.0 | 9.2 | 16.3 |
| 7 | 5.0 | 5.7 | 20.9 |
| 8 | 3.8 | 4.3 | 23.8 |
| 9 | 3.0 | 3.4 | 26.8 |
| 10 | 2.4 | 2.8 | 29.7 |
| 12 | 1.7 | 1.9 | 35.7 |

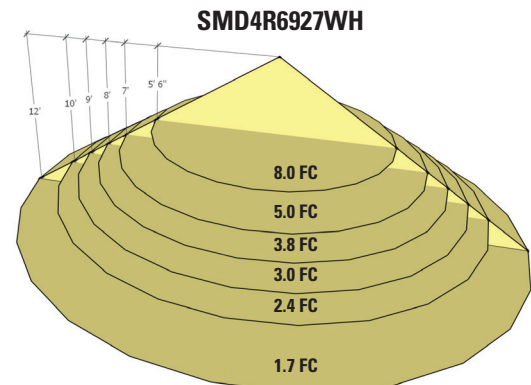

DD = distance down to illuminated work plane
FC = initial foot-candles at nadir
DIA = diameter

| Multiplier Table | | | | | |
|------------------|-------|-------|-------|-------|-------|
| CCT Option | 2700K | 3000K | 3500K | 4000K | 5000K |
| CCT Multiplier | 1.00 | 1.014 | 1.042 | 1.083 | 1.083 |

DESCRIPTION

The Halo Surface Mount LED Downlight (SMD) is an low profile surface mounting luminaire with a modern look and high performance. SMD4 (4") is designed for installation in many 3-1/2" and 4" square, octagon, or round junction boxes. Supply wire adapter with LED quick wiring connector included. The SMD4 may also retrofit in 4" aperture IC and Non-IC recessed housings.

| | | |
|-------------|--|------|
| Catalog # | | Type |
| Project | | |
| Comments | | Date |
| Prepared by | | |

SPECIFICATION FEATURES

HOUSING

- Non-electrically conductive polycarbonate frame.
- High impact diffuse polystyrene lens provides shielding to the light guide with no pixilation
- Stamped aluminum housing provides thermal cooling achieving L70 at 50,000 hours in IC and non-IC applications

GASKETS

- Closed cell gasket achieves restrictive airflow and wet location requirements without additional caulking

OPTICS

- Precision acrylic light guide organizes source flux into wide distribution with 1.2 – 1.4 spacing criteria useful for general area illumination

LED

- Mid power led array provide a uniform source with high efficiency and long life.
- Available in 90 CRI minimum, R9 greater than 50 and color accuracy within 3 SDCM provide color accuracy and uniformity

DRIVER

- Integral 120V 50/60Hz constant current driver provides noise free operation.
- Continuous, flicker-free dimming from 100% to 5% with select leading or trailing edge 120V phase cut dimmers.
- Dimming to 5% is best assured using dimmers with low end trim adjustment. Consult dimmer manufacturer for compatibility and conditions of use. (Note some dimmers require a neutral in the wallbox.)
- Inline electrical quick connect and E26 adapter (provided) provides mains connections.

MOUNTING/RETENTION

- Adjustable spider plate allows for quick installation into both junction boxes and recessed housings.
- Torsion springs or friction blades included

ELECTRICAL JUNCTION BOX MOUNTING

- The SMD may be used in compatible electrical junction boxes in direct contact with insulation including spray foam insulation.
- Suitable for installation in many 3-1/2" and 4" square, octagon, and round electrical junction boxes.
- Surface mounting in a fire-rated ceiling using an appropriate fire rated electrical box .
Note: Fire-rating is per the rating of the ceiling and applicable junction box, not the SMD.
- Installer must ensure compatibility of fit, wiring and proper mounting in the electrical junction box. This includes all applicable national and local electrical and building coded

RECESSED HOUSING MOUNTING

- May be installed in IC recessed housings in direct contact with insulation
Note: Not for use in recessed housing in direct contact with spray foam insulation. Refer to NEMA LSD 57-2013.

Friction Blade 4"

- Precision formed friction blades included
- For retrofit in 4" nominal housings
- Friction blade design allows the SMD to be installed in any position within the housing aperture (360 degrees)

DESIGNER SKINS (SOLD SEPARATELY)

- SMD skins are accessory rings in both round and square. These skins attach to the SMD for a permanent finish. Refer to the SMD accessories specification sheet for details.
- Matte White (Paintable)
- Satin Nickel
- Tuscan Bronze

WARRANTY

- Five year limited warranty, consult website for details.
www.eaton.com/lighting/legal

COMPLIANCE

- cULus listed / certified for use with Halo housings, classified for use with other's housings, see instruction sheet for conditions of acceptability.
- Wet and Damp Location listed, airtight per ASTM-E283
- Suitable for use in clothes closets when installed in accordance with the NEC 410.16 spacing requirements.
- EMI/RFI emissions per FCC 47CFR Part 15B
- Contains no mercury or lead and RoHS compliant.
- Photometric testing in accordance with IES LM-79-08
- Lumen maintenance projections in accordance with IES LM-80-08 and TM-21-11.
- Can be used for State of California Title 24 high efficacy luminaire compliance, reference the California Energy Commission Title 20 Appliance Efficiency Database for current listings.
- Can be used for International Energy Conservation Coe (IECC) and Washington State Energy Code high efficiency luminaire compliance

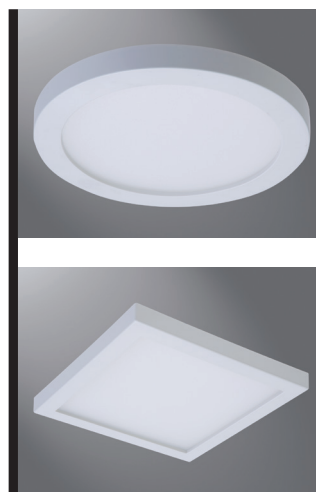

SMD4 Series

4 inch Round and Square

**SMD4R
SMD4S**

4" Surface Mount Downlight

Suitable for ceiling or wall electrical junction boxes

Suitable for 4" recessed housing retrofit

ENERGY DATA

| | Round | Square |
|-----------------------|-------------|----------|
| Lumens (5000K models) | 786 | 810 |
| Input Power | 9.7 W | 10 W |
| Input Current | 0.0811 A | 0.0829 A |
| Efficiency | 81 lm/W | 81 lm/W |
| THD | 13.3 | 13.2 |
| Input Voltage | 120V | |
| Frequency | 50/60 Hz | |
| CRI | 90 CRI | |
| Power Factor | 0.99 | |
| T Ambient | -30 - +40°C | |
| Sound Rating | Class A | |



Refer to ENERGY STAR® Qualified Products List.
Can be used to comply with California Title 24 High Efficacy requirements.
Certified to California Appliance Efficiency Database under JA8.

DIMENSIONS

SMD4RXXWH

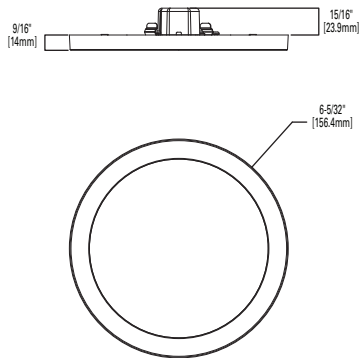

SMD4SXXWH

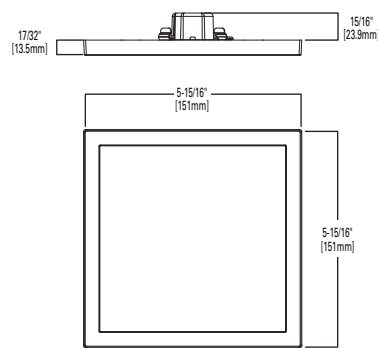

ORDERING INFORMATION

SAMPLE NUMBER: SMD4R6930WH=4" Round Surface Mount Downlight, 90CRI, 3000K

Junction Box Installation: Order junction box separately, as supplied by others, to complete installation.

Recessed Installation: Order Halo recessed housing separately to complete installation.

| Models | Lumens | CRI / CCT | Finish | Accessories |
|---|----------------------------|--|-----------------------|--|
| SMD4R = 4" Round Surface Mount Downlight, 120V SMD4S = 4" Square Surface Mount Downlight, 120V | 6 =600 lumen series | 927 =90CRI, 2700K 930 =90CRI, 3000K 935 =90CRI, 3500K 940 =90CRI, 4000K 950 =90CRI, 5000K | WH =Mate White | <u>Designer Trims</u> SMD4RTRMSN =4" Round SMD Satin Nickel SMD4RTRMTBZ =4" Round SMD Tuscan Bronze SMD4RTRMWH =4" Round SMD White (paintable) SMD4STRMSN =4" Square SMD Satin Nickel SMD4STRMTBZ =4" Square SMD Tuscan Bronze SMD4STRMWH =4" Square SMD White (paintable) |

ACCESSORIES

Designer Trims



SMD4STRMWH
square, white (paintable)

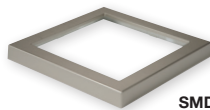

SMD4STRMSN
square, satin nickel

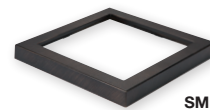

SMD4STRMTBZ
square, tuscan bronze



SMD4RTRMWH
round, white (paintable)



SMD4RTRMSN
round, satin nickel



SMD4RTRMTBZ
round, tuscan bronze

HOUSING COMPATIBILITY

The SMD4 is UL Listed in Halo and All-Pro recessed housings, and is UL Classified for use with any 4 inch diameter recessed housing constructed of steel or aluminum with an internal volume that exceeds 62.3 in³ in addition to those noted below:

| Compatible Halo LED Housings with LED luminaire connector (high-efficacy compliant) | | |
|---|-------------------|---|
| HALO LED | Recessed Can Size | Catalog Number |
| | | 4" |
| Compatible Halo Incandescent E26 Screwbase Housings | | |
| HALO | Recessed Can Size | Catalog Number |
| | 4" | H99ICAT, H99TAT, H99RTAT, E4ICATSB, E4TATSB, E4RTATSB |
| Compatible All-Pro Incandescent E26 Screwbase Housings | | |
| ALL-PRO | Recessed Can Size | Catalog Number |
| | 4" | EI400ATSB, ET400ATSB, ET400RATSB |

COMPATIBLE WITH EATON'S CROUSE-HINDS JUNCTION BOXES

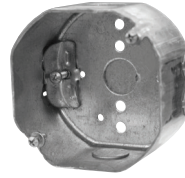

TP316
for non-metallic cable
4" x 4" x 2-1/8"
(102mm x 102mm x 54mm)

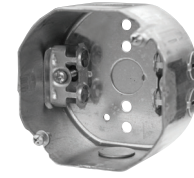

TP317
for metal clad cable
4" x 4" x 2-1/8"
(102mm x 102mm x 54mm)

- **TP316** - for non-metallic cable
- **TP317** - for metal clad cable
- UL Listed
- Suitable for two-hour fire-rated ANSI/UL 263 when properly installed in a fire-rated ceiling or wall
- Refer to www.crouse-hinds.com

COMPATIBLE WITH MANY OTHER JUNCTION BOXES*



4" octagon light fixture/fan steel box
4" x 4" x 2-1/8"
(102mm x 102mm x 54mm)

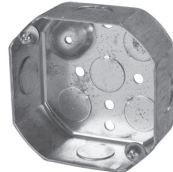

4" octagon steel box
4" x 4" x 1-1/2"
(102mm x 102mm x 38mm)



4" square deep steel box
4" x 4" x 2-1/8"
(102mm x 102mm x 54mm)



4" square standard steel box
4" x 4" x 1-1/2"
(102mm x 102mm x 38mm)



4" round new work non-metallic light fixture/fan box
4" diameter x 2-3/16"
(102mm x 56mm)



3-1/2" round new work non-metallic ceiling box
3-1/2" diameter x 2-3/4"
(89mm x 70mm)



3-1/2" round old work non-metallic box
4-1/4" O.D. flange, 3-1/2" I.D. x 2-5/8"
(108mm O.D., 89mm I.D. x 67mm)



4" round surface mount box
4" diameter x 1-1/2"
(102mm x 38mm)
Requires SLD4RAD adapter



4" round new work non-metallic box with hanger bar assembly
4" diameter x 2-3/16" (102mm x 56mm)

Surface mounting in a fire-rated ceiling using an appropriate electrical box offers a cost-effective alternative to fire-rated recessed housings.

Note: Fire-rating is per the rating of the ceiling and applicable junction box, not the SMD.

*This is a representative list of compatible junction boxes only. Information contained in this literature about other manufacturers' products is from published information made available by the manufacturer and is deemed to be reliable, but has not been verified. Eaton makes no specific recommendation on product selection and there are no warranties of performance or compatibility implied. Installer must determine that site conditions are suitable to allow proper installation of the mounting bracket in the box.

PHOTOMETRIC DATA

| SMD4R6927WH | | |
|-----------------------|----------|----------|
| Luminaire lumens | 690 | |
| Input watts | 9.5 | |
| LER (LPW) | 73 | |
| Spacing Criteria | 0-180 | 1.26 |
| | 90-270 | 1.26 |
| | Diagonal | 1.38 |
| Beam angle (degrees) | 112 | |
| Field angle (degrees) | 162 | |
| Max. Candela | 243 | |
| Zonal lumen | Lumens | % Lumens |
| 0-30 | 187 | 27.2% |
| 0-40 | 306 | 44.5% |
| 0-60 | 542 | 78.6% |
| 0-90 | 690 | 100.00% |

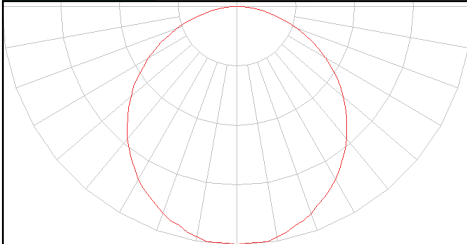

| SMD4S6927WH | | |
|-----------------------|----------|----------|
| Luminaire lumens | 750 | |
| Input watts | 9.5 | |
| LER (LPW) | 79 | |
| Spacing Criteria | 0-180 | 1.24 |
| | 90-270 | 1.24 |
| | Diagonal | 1.36 |
| Beam angle (degrees) | 109 | |
| Field angle (degrees) | 162 | |
| Max. Candela | 278 | |
| Zonal lumen | Lumens | % Lumens |
| 0-30 | 207 | 27.6% |
| 0-40 | 336 | 44.9% |
| 0-60 | 589 | 78.6% |
| 0-90 | 750 | 100.00% |

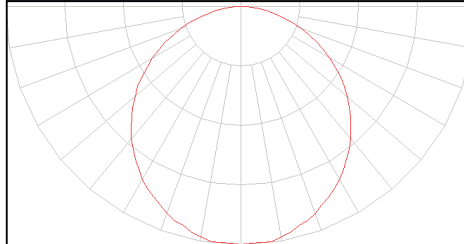

| Cat. No. | CRI | CCT | Lumens | Power (W) | LPW |
|-------------|-----|------|--------|-----------|------|
| SMD4R6927WH | 93 | 2700 | 690 | 9.50 | 72.6 |
| SMD4R6930WH | 93 | 3000 | 700 | 9.70 | 72.2 |
| SMD4R6935WH | 94 | 3500 | 740 | 9.70 | 76.3 |
| SMD4R6940WH | 94 | 4000 | 760 | 9.80 | 77.6 |
| SMD4R6950WH | 91 | 5000 | 786 | 9.70 | 81.0 |
| SMD4S6927WH | 92 | 2700 | 750 | 9.50 | 78.9 |
| SMD4S6930WH | 92 | 3000 | 790 | 9.90 | 79.8 |
| SMD4S6935WH | 93 | 3500 | 740 | 9.90 | 74.7 |
| SMD4S6940WH | 93 | 4000 | 800 | 10.10 | 79.2 |
| SMD4S6950WH | 90 | 5000 | 810 | 10.00 | 81.0 |

| Foot-candle Values at Nadir 0 degree Aiming Angle | | | |
|--|---------------------|---------------------|-------------|
| DD (FT) | SMD4R6927WH (FC) | SMD4S6927WH (FC) | DIA (FT) |
| 5.5 | 8.0 | 9.2 | 16.3 |
| 7 | 5.0 | 5.7 | 20.9 |
| 8 | 3.8 | 4.3 | 23.8 |
| 9 | 3.0 | 3.4 | 26.8 |
| 10 | 2.4 | 2.8 | 29.7 |
| 12 | 1.7 | 1.9 | 35.7 |

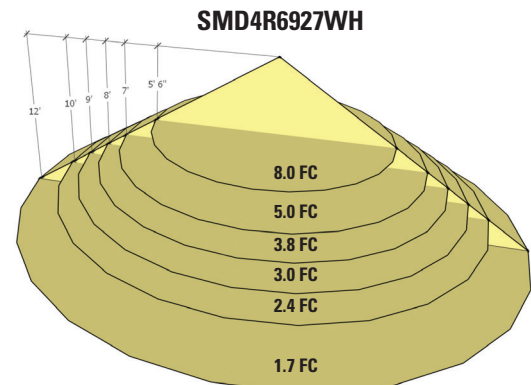

DD = distance down to illuminated work plane
FC = initial foot-candles at nadir
DIA = diameter

| Multiplier Table | | | | | |
|------------------|-------|-------|-------|-------|-------|
| CCT Option | 2700K | 3000K | 3500K | 4000K | 5000K |
| CCT Multiplier | 1.00 | 1.014 | 1.042 | 1.083 | 1.083 |