

SMD
Surface Mount LED Downlight

Halo



EATON

Powering Business Worldwide

SMD

Surface Mount Downlighting

The Halo Surface Mount LED Downlight (SMD) is an ultra-low profile surface mounting luminaire with a modern look and high performance. SMD4 (4") and SMD6 (6") are designed for installation in recessed housings and many 3-1/2" and 4" square, octagon, or round junction boxes. Supply wire adapter with LED quick wiring connector included. Suitable for residential or commercial installations. Ideal for closets, storage areas, attics and basements. The SMD4 and SMD6 may also retrofit in a 4" or 5" and 6" aperture IC and Non-IC recessed housings. Dedicated LED wiring connector meets high efficacy code requirement when used in recessed downlighting. Suitable for use in clothes closets when installed with NEC® 410.16 spacing requirements. The SMD series offers modern and elegant stylings with exceptional value.

The SMD4 and SMD6 series also offers a direct mount (DM) version which can be installed directly into the ceiling with no additional junction box or housing required. Utilizing the integral Halo enclosure, this version of the SMD provides a quick installation and flush finish with the ceiling.



Innovation you can rely on



Features

- 4" and 6" ultra-low profile surface mounting
 - Recessed Housings or Junction Box installations (approx. 0.5" thick below ceiling)
 - Direct Mount (DM) version that installs directly into ceiling
- 4" SMD4 Round and Square (600 lumen series)
 - Lumens: up to 810 lumens
 - Wattage: 9.5W – 10.1W
 - Voltage: 120V, 50/60Hz
- 6" SMD6 Round and Square (600 lumen series)
 - Lumens: up to 815 lumens
 - Wattage: 9.6W – 10.5W
 - Voltage: 120V, 50/60Hz
- 6" SMD6 Round and Square (1200 lumen series)
 - Lumens: up to 1252 lumens
 - Wattage: 15.1W – 15.8W
 - Voltage: 120V, 50/60Hz

*LED connector on SMD meets CA Title 24

** Retrofit only - not for CA Title 24

Compliances



Refer to ENERGY STAR® Certified Products List.

Can be used to comply with California Title 24 High Efficacy requirements. Certified to California Title 20 Appliance Efficiency Database.

SMD

LED Surface Mount Downlight

- 4-inch and 6-inch aperture, round and square
- Fits most j-boxes and 5-inch or 6-inch recessed housings
- Replaces bulbs, flush mounts and recessed trims
- Rated for wet location
- Dimmable



Mounting methods

Junction box bracket



Torsion springs for recessed housings



Friction clips for recessed housings





Easy Installation^Δ

^ΔImages show junction box installation. Refer to the instructions provided with the product for other mounting options.



1. Install the junction box bracket onto the jbox.



2. Wire the connector to the house wiring and attach to the fixture.



3. Align the two bracket tabs with the slots on the back of the fixture.



4. Push the fixture up into place.

SMD4RXXXWH

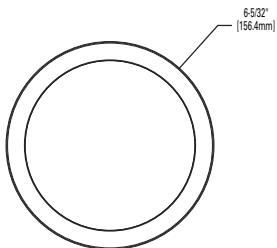

SMD4SXXXWH

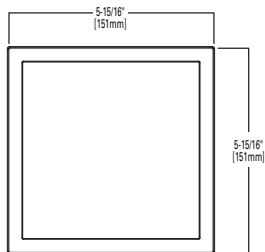

SMD6RXXXWH

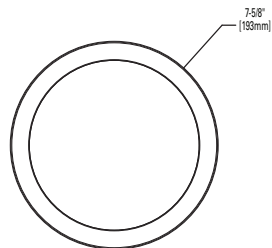

SMD6SXXXWH

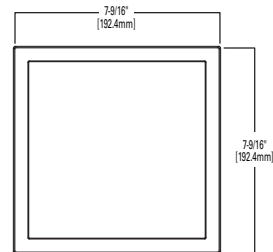

SMD Designer Trims

- exclusively for use with Halo SMD4 and SMD6 LED modules
- round or square trims
- finishes: white (paintable), satin nickel, tuscan bronze



square
white (paintable)
SMD4STRMWH
SMD6STRMWH

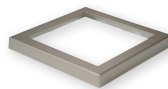

square
satin nickel
SMD4STRMSN
SMD6STRMSN

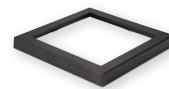

square
tuscan bronze
SMD4STRMTBZ
SMD6STRMTBZ



round
white (paintable)
SMD4RTRMWH
SMD6RTRMWH



round
satin nickel
SMD4RTRMSN
SMD6RTRMSN



round
tuscan bronze
SMD4RTRMTBZ
SMD6RTRMTBZ

SMD Ordering Information

SMD4 Sample Number: **SMD4R6930WH=4"** Round Surface Mount Downlight, 90CRI, 3000K

Models	Lumens	CRI / CCT	Finish	Accessories
SMD4R= 4" Round Surface Mount Downlight, 120V SMD4S= 4" Square Surface Mount Downlight, 120V	6=600 lumen series (nominal)	927=90CRI, 2700K 930=90CRI, 3000K 935=90CRI, 3500K 940=90CRI, 4000K 950=90CRI, 5000K	WH=Matte White	<u>Designer Trims</u> SMD4RTRMSN= 4" Round SMD Satin Nickel SMD4RTRMTBZ= 4" Round SMD Tuscan Bronze SMD4RTRMWH= 4" Round SMD White (paintable) SMD4STRMSN= 4" Square SMD Satin Nickel SMD4STRMTBZ= 4" Square SMD Tuscan Bronze SMD4STRMWH= 4" Square SMD White (paintable)



*supply wire adapter with LED connector

SMD6 Sample Number: **SMD6R6930WH=6"** Round Surface Mount Downlight, 90CRI, 3000K

Models	Lumens	CRI / CCT	Finish	Accessories
SMD6R= 6" Round Surface Mount Downlight, 120V SMD6S= 6" Square Surface Mount Downlight, 120V	6=600 lumen series (nominal) 12=1200 lumen series (nominal)	927=90CRI, 2700K 930=90CRI, 3000K 935=90CRI, 3500K 940=90CRI, 4000K 950=90CRI, 5000K	WH=Matte White	<u>Designer Trims</u> SMD6RTRMSN= 6" Round SMD Satin Nickel SMD6RTRMTBZ= 6" Round SMD Tuscan Bronze SMD6RTRMWH= 6" Round SMD White (paintable) SMD6STRMSN= 6" Square SMD Satin Nickel SMD6STRMTBZ= 6" Square SMD Tuscan Bronze SMD6STRMWH= 6" Square SMD White (paintable)



**screwbase adapter with LED connector

Junction Box Installation: Order junction box separately, as supplied by others, to complete installation.

Recessed Installation: Order Halo recessed housing separately to complete installation.

See compatibility sections for more information.

Junction box Compatibility

Eaton's Crouse-Hinds junction boxes



TP316, TP288
Octagonal steel

w/ non-metallic cable clamps
4" x 4" x 2-1/8"



TP317, TP320
Octagonal steel

w/ metal clad cable clamps
4" x 4" x 2-1/8"



Octagonal steel

- 4" x 2-1/8"
- 4" x 1-1/2"



Square steel

- 4" x 4" x 2-1/8"
- 4" x 4" x 1-1/2"



Round - new work fixture box (plastic)

- 4" diameter x 2-3/16"
- 3-1/2" diameter x 2-3/4"



Round - old work fixture box (plastic)

- 4-1/4" flange x 2-5/8",
3-1/2" I.D.



Round surface mount

- 4" diameter x 1-1/2"

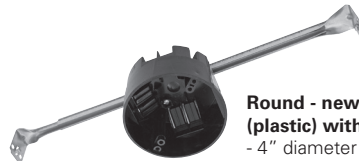

Round - new work fixture box (plastic) with bar hanger

- 4" diameter x 2-3/16"

Housing Compatibility

Housings

Halo LED 4-inch

H995ICAT= 4" LED, Insulated Ceiling, Air-Tite, New Construction Housing

H995RICAT= 4" LED, Insulated Ceiling, Air-Tite, Remodel Housing

Halo Ultra-Shallow LED 4-inch

H245RICAT= 4" LED, Insulated Ceiling, Air-Tite, Ultra-Shallow Remodel Housing

Halo Standard Housings 4-inch*

H99ICAT= 4" IC, Air-Tite, Shallow New Construction Housing

H99TAT= 4" Non-IC, Air-Tite, Shallow New Construction Housing

H99RTAT= 4" Non-IC, Air-Tite, Shallow Remodel Housing

E4ICATSB= 4" IC, Air-Tite, Shallow New Construction Housing

E4TATSB= 4" Non-IC, Air-Tite, Shallow New Construction Housing

E4RTATSB= 4" Non-IC, Air-Tite, Shallow Remodel Housing

Halo Low Voltage Housings 4-inch*

H1499ICAT= 4" IC, Air-Tite, New Construction Housing, 120V - 12V Low Voltage MR16

H1499TAT= 4" Non-IC, Air-Tite, Shallow New Construction Housing, 120V - 12V Low Voltage MR16

H1499RTAT= 4" Non-IC, Air-Tite, Shallow Remodel Housing,

120V - 12V Low Voltage MR16

H1499T75= 4" Non-IC, New Construction Housing, 120V/277V - 12V Low Voltage, MR16

Accessories

T24HWKIT= Title 24 Cable harness kit used to convert incandescent and low voltage housings to LED.



*Use T24HWKIT, Title 24 Cable Harness Kit, to convert incandescent and low voltage housings to LED.

Housings

Halo LED 6-inch

H750ICAT= 6" LED, Insulated Ceiling, Air-Tite, New Construction Housing
H750RICAT= 6" LED, Insulated Ceiling, Air-Tite, Remodel Housing
H750T= 6" LED, Non-IC, Air-Tite, New Construction Housing
H750TCP= 6" LED, Non-IC, New Construction/Remodel Chicago Plenum Housing
H2750ICAT= 6" LED, Shallow, Insulated Ceiling, Air-Tite, New Construction (use with 691X, 694X, 696X trims only)
H2750RICAT= 6" LED, Shallow, Insulated Ceiling, Air-Tite, Remodel (use with 691X, 694X, 696X trims only)

Halo LED 5-inch

H550ICAT= 5" LED, Insulated Ceiling, Air-Tite, New Construction Housing
H550RICAT= 5" LED, Insulated Ceiling, Air-Tite, Remodel Housing

Halo LED retrofit

ML7E26RFK= 6" Retrofit Enclosure, Non-IC, E26 Screw base Interface
ML7BXFK= 6" Retrofit Enclosure, Non-IC, BX Whip

Halo Standard Housings 6-inch

H7ICAT= 6" Insulated Ceiling, Air-Tite New Construction Housing
H7RICAT= 6" Insulated Ceiling, Air-Tite Remodel Housing
H7ICT= 6" Insulated Ceiling, New Construction Housing
H7RICT= 6" Insulated Ceiling, Remodel Housing
H7ICATNB= 6" Insulated Ceiling, Air-Tite New Construction Housing, No Socket Bracket
H7ICTNB= 6" Insulated Ceiling, New Construction Housing, No Socket Bracket

Halo Standard Housings 6-inch (continued)

H7T= 6" Non-IC, New Construction Housing
H7RT= 6" Non-IC, Remodel Housing
H7TNB= 6" Non-IC, New Construction Housing, No Socket Bracket
H7TCP= 6" Non-IC, Chicago Plenum, New Construction/Remodel Housing
H7UICAT= 6" Insulated Ceiling, Universal, Air-Tite, New Construction Housing
E7ICAT= 6" Insulated Ceiling, Air-Tite New Construction Housing
E7RICAT= 6" Insulated Ceiling, Air-Tite Remodel Housing
E7ICATNB= 6" Insulated Ceiling, Air-Tite New Construction Housing, No Socket Bracket
E7TAT= 6" Non-IC, New Construction Housing
E7RTAT= 6" Non-IC, Remodel Housing
E7TATNB= 6" Non-IC, New Construction Housing, No Socket Bracket

Halo Standard Housings 5-inch

H5ICAT= 5" Insulated Ceiling, Air-Tite New Construction Housing
H5RICAT= 5" Insulated Ceiling, Air-Tite Remodel Housing
H5ICATNB= 5" Insulated Ceiling, Air-Tite New Construction Housing, No Socket Bracket
H5T= 5" Non-IC, New Construction Housing
H5RT= 5" Non-IC, Remodel Housing
H5TNB= 5" Non-IC, New Construction Housing, No Socket Bracket
E5ICAT= 5" Insulated Ceiling, Air-Tite New Construction Housing
E5RICAT= 5" Insulated Ceiling, Air-Tite Remodel Housing
E5ICATNB= 5" Insulated Ceiling, Air-Tite New Construction Housing, No Socket Bracket
E5TAT= 5" Non-IC, New Construction Housing
E5RTAT= 5" Non-IC, Remodel Housing
E5TATNB= 5" Non-IC, New Construction Housing, No Socket Bracket

Halo Shallow Housings 6-inch

H27ICAT= 6" Shallow, Insulated Ceiling, Air-Tite New Construction
H27RICAT= 6" Shallow, Insulated Ceiling, Air-Tite Remodel Housing
H27T= 6" Shallow, Non-IC, New Construction Housing
H27RT= 6" Shallow, Non-IC, Remodel Housing
E27ICAT= 6" Shallow, Insulated Ceiling, Air-Tite New Construction
E27RICAT= 6" Shallow, Insulated Ceiling, Air-Tite Remodel Housing
E27TAT= 6" Shallow, Non-IC, New Construction Housing
E27RTAT= 6" Shallow, Non-IC, Remodel Housing

Halo Shallow Housings 5-inch

H25ICAT= 5" Shallow, Insulated Ceiling, Air-Tite New Construction
H25RICAT= 5" Shallow, Insulated Ceiling, Air-Tite Remodel
H25ICATNB= 5" Shallow, Insulated Ceiling, Air-Tite New Construction, No Socket Bracket

SMD-DM

Direct Ceiling Mount

- 4-inch and 6-inch aperture, round and square
- No housng or junction box required
- Rated for wet location
- Dimmable

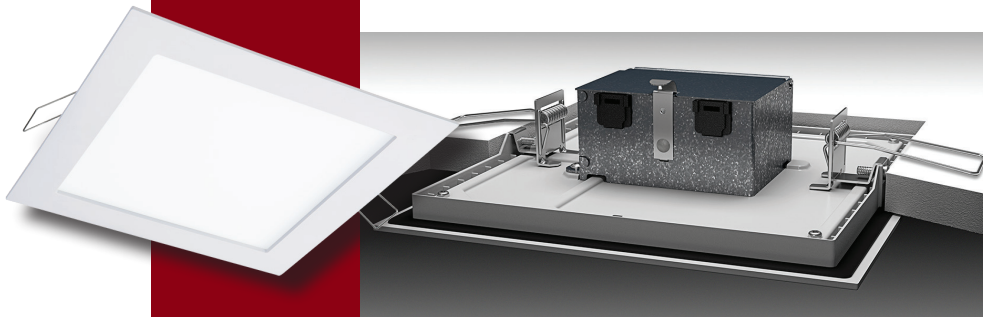



Easy Installation*

*Images show installation of the square SMD-DM.
Follow the same steps for the round products.

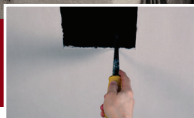

1. Cut a hole in drywall with the provided template.



2. Wire to the integrated fixture junction box.



3. Fold both of the spring clips upward.



4. Push the fixture up into place.

SMD4RXXWHDM

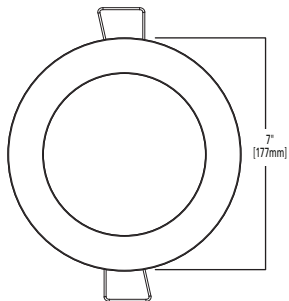
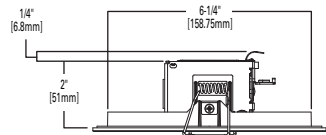

SMD4SXXWHDM

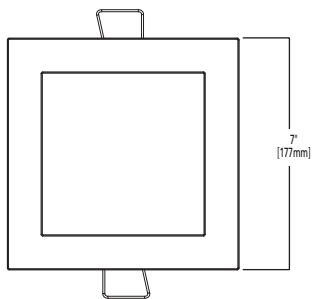
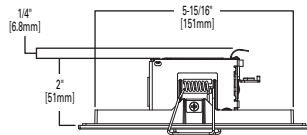

SMD6RXXWHDM

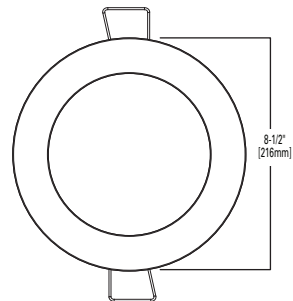
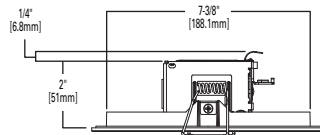

SMD6SXXWHDM

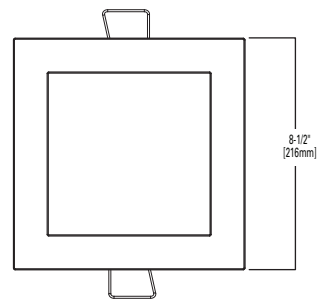
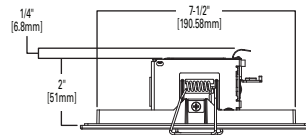

SMD-DM Ordering Information

SMD4-DM Sample Number: **SMD4R6930WHDM=4"** Round Surface Mount Downlight, 90CRI, 3000K, Spring Clips

Models	Lumens	CRI / CCT	Finish	Mounting
SMD4R= 4" Round Surface Mount Downlight, 120V SMD4S= 4" Square Surface Mount Downlight, 120V	6=600 lumen series (nominal)	927=90CRI, 2700K 930=90CRI, 3000K 935=90CRI, 3500K 940=90CRI, 4000K 950=90CRI, 5000K	WH=Matte White	DM=Direct Mount

SMD6-DM Sample Number: **SMD6R6930WHDM=6"** Round Surface Mount Downlight, 90CRI, 3000K, Spring Clips

Models	Lumens	CRI / CCT	Finish	Mounting
SMD6R= 6" Round Surface Mount Downlight, 120V SMD6S= 6" Square Surface Mount Downlight, 120V	6=600 lumen series (nominal)	927=90CRI, 2700K 930=90CRI, 3000K 935=90CRI, 3500K 940=90CRI, 4000K 950=90CRI, 5000K	WH=Matte White	DM=Direct Mount

Energy Data

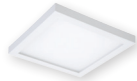

SMD4 Energy Data	Round	Square
Lumens (5000K)	786	810
Input Power	9.7 W	10 W
Input Current	0.0811 A	0.0829 A
Efficiency	81 lm/W	81 lm/W
THD	13.3	13.2
Input Voltage	120V	120V
Input Frequency	50/60 Hz	50/60 Hz
CRI	90 CRI	90 CRI
Power Factor	≥ 0.99	≥ 0.99
T Ambient	-30°C - +40°C	-30°C - +40°C
Sound Rating	Class A	Class A



SMD6 Energy Data	600 lumen		1200 lumen	
	Round	Square	Round	Square
Lumens (5000K)	788	815	1252	1235
Input Power	9.6 W	9.9 W	15.3 W	15.7 W
Input Current	0.0811 A	0.085 A	0.133 A	0.132 A
Efficiency	82 lm/W	82 lm/W	81 lm/W	78 lm/W
THD	13.9	14.7	15.3	15.7
Input Voltage	120V	120V	120V	120V
Input Frequency	50/60 Hz	50/60 Hz	50/60 Hz	50/60 Hz
CRI	90 CRI	90 CRI	90 CRI	90 CRI
Power Factor	≥ 0.99	≥ 0.99	≥ 0.98	≥ 0.98
T Ambient	-30°C - +40°C	-30°C - +40°C	-30°C - +40°C	-30°C - +40°C
Sound Rating	Class A	Class A	Class A	Class A



Lighting Control Solution

Set the mood

Eaton dimmers offer versatile options to set the mood and reduce energy consumption. These compatible LED dimmers are ideal for both residential and light commercial applications and are compatible with decorator (screwless) style devices and wallplates.

Refer to www.eaton.com for additional information.



Dimmer Features	Decorator (DAL06P)	Slide (SAL06P)	Toggle (TAL06P)
Rapid Start feature	Fully adjustable	Fixed ON	Fully adjustable
Adjustable high-end trim			
Adjustable low-end trim	•	•	•
Wiring configurations	Single-pole or three-way	Single-pole or three-way	Single-pole or three-way
Color change kits	•		•

Eaton

1121 Highway 74 South
Peachtree City, GA 30269
P: 770-486-4800
www.eaton.com/lighting

Canada Sales
5925 McLaughlin Road
Mississauga, Ontario L5R 1B8
P: 905-501-3000
F: 905-501-3172

Our Lighting Product Lines

Halo
Halo Commercial
Portfolio
IRiS
RSA
Metalux
Corelite
Neo-Ray
Fail-Safe
MWS
Ametrix
Shaper
io
Lumark
McGraw-Edison
Invue
Ephesus
Lumière
Streetworks
AtLite
Sure-Lites

Our Controls Product Lines

Greengate
iLumin
Zero 88
Fifth Light Technology
iLight (International Only)



Powering Business Worldwide

Eaton

1121 Highway 74 South
Peachtree City, GA 30269
P: 770-486-4800
www.eaton.com/lighting

© 2017 Eaton
All Rights Reserved
Printed in USA
Publication No. BR518031EN
February 2017

Eaton is a registered trademark.

All other trademarks are property
of their respective owners.

SMD
Surface Mount LED Downlight

Halo



EATON

Powering Business Worldwide

SMD

Surface Mount Downlighting

The Halo Surface Mount LED Downlight (SMD) is an ultra-low profile surface mounting luminaire with a modern look and high performance. SMD4 (4") and SMD6 (6") are designed for installation in recessed housings and many 3-1/2" and 4" square, octagon, or round junction boxes. Supply wire adapter with LED quick wiring connector included. Suitable for residential or commercial installations. Ideal for closets, storage areas, attics and basements. The SMD4 and SMD6 may also retrofit in a 4" or 5" and 6" aperture IC and Non-IC recessed housings. Dedicated LED wiring connector meets high efficacy code requirement when used in recessed downlighting. Suitable for use in clothes closets when installed with NEC® 410.16 spacing requirements. The SMD series offers modern and elegant stylings with exceptional value.

The SMD4 and SMD6 series also offers a direct mount (DM) version which can be installed directly into the ceiling with no additional junction box or housing required. Utilizing the integral Halo enclosure, this version of the SMD provides a quick installation and flush finish with the ceiling.



Innovation you can rely on



Features

- 4" and 6" ultra-low profile surface mounting
 - Recessed Housings or Junction Box installations (approx. 0.5" thick below ceiling)
 - Direct Mount (DM) version that installs directly into ceiling
- 4" SMD4 Round and Square (600 lumen series)
 - Lumens: up to 810 lumens
 - Wattage: 9.5W – 10.1W
 - Voltage: 120V, 50/60Hz
- 6" SMD6 Round and Square (600 lumen series)
 - Lumens: up to 815 lumens
 - Wattage: 9.6W – 10.5W
 - Voltage: 120V, 50/60Hz
- 6" SMD6 Round and Square (1200 lumen series)
 - Lumens: up to 1252 lumens
 - Wattage: 15.1W – 15.8W
 - Voltage: 120V, 50/60Hz

*LED connector on SMD meets CA Title 24

** Retrofit only - not for CA Title 24

Compliances



Refer to ENERGY STAR® Certified Products List.

Can be used to comply with California Title 24 High Efficacy requirements. Certified to California Title 20 Appliance Efficiency Database.

SMD

LED Surface Mount Downlight

- 4-inch and 6-inch aperture, round and square
- Fits most j-boxes and 5-inch or 6-inch recessed housings
- Replaces bulbs, flush mounts and recessed trims
- Rated for wet location
- Dimmable



Mounting methods

Junction box bracket



Torsion springs for recessed housings



Friction clips for recessed housings





Easy Installation^Δ

^ΔImages show junction box installation. Refer to the instructions provided with the product for other mounting options.



1. Install the junction box bracket onto the jbox.



2. Wire the connector to the house wiring and attach to the fixture.



3. Align the two bracket tabs with the slots on the back of the fixture.



4. Push the fixture up into place.

SMD4RXXXWH

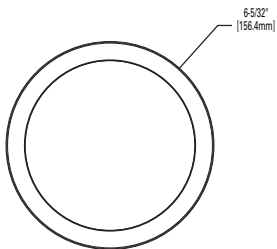

SMD4SXXXWH

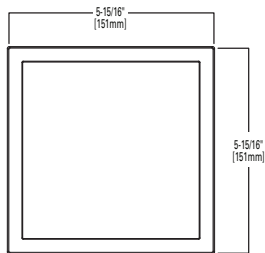

SMD6RXXXWH

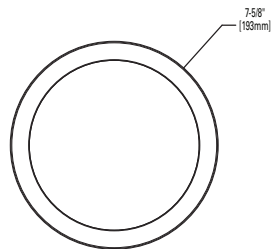

SMD6SXXXWH

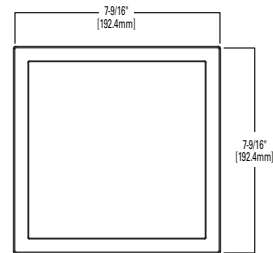

SMD Designer Trims

- exclusively for use with Halo SMD4 and SMD6 LED modules
- round or square trims
- finishes: white (paintable), satin nickel, tuscan bronze



square
white (paintable)
SMD4STRMWH
SMD6STRMWH

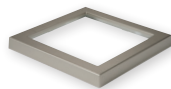

square
satin nickel
SMD4STRMSN
SMD6STRMSN

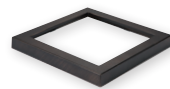

square
tuscan bronze
SMD4STRMTBZ
SMD6STRMTBZ



round
white (paintable)
SMD4RTRMWH
SMD6RTRMWH



round
satin nickel
SMD4RTRMSN
SMD6RTRMSN



round
tuscan bronze
SMD4RTRMTBZ
SMD6RTRMTBZ

SMD Ordering Information

SMD4 Sample Number: **SMD4R6930WH=4"** Round Surface Mount Downlight, 90CRI, 3000K

Models	Lumens	CRI / CCT	Finish	Accessories
SMD4R= 4" Round Surface Mount Downlight, 120V SMD4S= 4" Square Surface Mount Downlight, 120V	6=600 lumen series (nominal)	927=90CRI, 2700K 930=90CRI, 3000K 935=90CRI, 3500K 940=90CRI, 4000K 950=90CRI, 5000K	WH=Matte White	<u>Designer Trims</u> SMD4RTRMSN= 4" Round SMD Satin Nickel SMD4RTRMTBZ= 4" Round SMD Tuscan Bronze SMD4RTRMWH= 4" Round SMD White (paintable) SMD4STRMSN= 4" Square SMD Satin Nickel SMD4STRMTBZ= 4" Square SMD Tuscan Bronze SMD4STRMWH= 4" Square SMD White (paintable)



*supply wire adapter with LED connector

SMD6 Sample Number: **SMD6R6930WH=6"** Round Surface Mount Downlight, 90CRI, 3000K

Models	Lumens	CRI / CCT	Finish	Accessories
SMD6R= 6" Round Surface Mount Downlight, 120V SMD6S= 6" Square Surface Mount Downlight, 120V	6=600 lumen series (nominal) 12=1200 lumen series (nominal)	927=90CRI, 2700K 930=90CRI, 3000K 935=90CRI, 3500K 940=90CRI, 4000K 950=90CRI, 5000K	WH=Matte White	<u>Designer Trims</u> SMD6RTRMSN= 6" Round SMD Satin Nickel SMD6RTRMTBZ= 6" Round SMD Tuscan Bronze SMD6RTRMWH= 6" Round SMD White (paintable) SMD6STRMSN= 6" Square SMD Satin Nickel SMD6STRMTBZ= 6" Square SMD Tuscan Bronze SMD6STRMWH= 6" Square SMD White (paintable)



**screwbase adapter with LED connector

Junction Box Installation: Order junction box separately, as supplied by others, to complete installation.

Recessed Installation: Order Halo recessed housing separately to complete installation.

See compatibility sections for more information.

Junction box Compatibility

Eaton's Crouse-Hinds junction boxes



TP316, TP288
Octagonal steel

w/ non-metallic cable clamps
4" x 4" x 2-1/8"



TP317, TP320
Octagonal steel

w/ metal clad cable clamps
4" x 4" x 2-1/8"



Octagonal steel

- 4" x 2-1/8"
- 4" x 1-1/2"



Square steel

- 4" x 4" x 2-1/8"
- 4" x 4" x 1-1/2"



Round - new work fixture box (plastic)

- 4" diameter x 2-3/16"
- 3-1/2" diameter x 2-3/4"



Round - old work fixture box (plastic)

- 4-1/4" flange x 2-5/8",
3-1/2" I.D.



Round surface mount

- 4" diameter x 1-1/2"

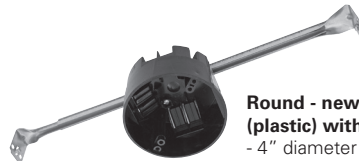

Round - new work fixture box (plastic) with bar hanger

- 4" diameter x 2-3/16"

Housing Compatibility

Housings

Halo LED 4-inch

H995ICAT= 4" LED, Insulated Ceiling, Air-Tite, New Construction Housing

H995RICAT= 4" LED, Insulated Ceiling, Air-Tite, Remodel Housing

Halo Ultra-Shallow LED 4-inch

H245RICAT= 4" LED, Insulated Ceiling, Air-Tite, Ultra-Shallow Remodel Housing

Halo Standard Housings 4-inch*

H99ICAT= 4" IC, Air-Tite, Shallow New Construction Housing

H99TAT= 4" Non-IC, Air-Tite, Shallow New Construction Housing

H99RTAT= 4" Non-IC, Air-Tite, Shallow Remodel Housing

E4ICATSB= 4" IC, Air-Tite, Shallow New Construction Housing

E4TATSB= 4" Non-IC, Air-Tite, Shallow New Construction Housing

E4RTATSB= 4" Non-IC, Air-Tite, Shallow Remodel Housing

Halo Low Voltage Housings 4-inch*

H1499ICAT= 4" IC, Air-Tite, New Construction Housing, 120V - 12V Low Voltage MR16

H1499TAT= 4" Non-IC, Air-Tite, Shallow New Construction Housing, 120V - 12V Low Voltage MR16

H1499RTAT= 4" Non-IC, Air-Tite, Shallow Remodel Housing,

120V - 12V Low Voltage MR16

H1499T75= 4" Non-IC, New Construction Housing, 120V/277V - 12V Low Voltage, MR16

Accessories

T24HWKIT= Title 24 Cable harness kit used to convert incandescent and low voltage housings to LED.



*Use T24HWKIT, Title 24 Cable Harness Kit, to convert incandescent and low voltage housings to LED.

Housings

Halo LED 6-inch

H750ICAT= 6" LED, Insulated Ceiling, Air-Tite, New Construction Housing
H750RICAT= 6" LED, Insulated Ceiling, Air-Tite, Remodel Housing
H750T= 6" LED, Non-IC, Air-Tite, New Construction Housing
H750TCP= 6" LED, Non-IC, New Construction/Remodel Chicago Plenum Housing
H2750ICAT= 6" LED, Shallow, Insulated Ceiling, Air-Tite, New Construction (use with 691X, 694X, 696X trims only)
H2750RICAT= 6" LED, Shallow, Insulated Ceiling, Air-Tite, Remodel (use with 691X, 694X, 696X trims only)

Halo LED 5-inch

H550ICAT= 5" LED, Insulated Ceiling, Air-Tite, New Construction Housing
H550RICAT= 5" LED, Insulated Ceiling, Air-Tite, Remodel Housing

Halo LED retrofit

ML7E26RFK= 6" Retrofit Enclosure, Non-IC, E26 Screw base Interface
ML7BXFK= 6" Retrofit Enclosure, Non-IC, BX Whip

Halo Standard Housings 6-inch

H7ICAT= 6" Insulated Ceiling, Air-Tite New Construction Housing
H7RICAT= 6" Insulated Ceiling, Air-Tite Remodel Housing
H7ICT= 6" Insulated Ceiling, New Construction Housing
H7RICT= 6" Insulated Ceiling, Remodel Housing
H7ICATNB= 6" Insulated Ceiling, Air-Tite New Construction Housing, No Socket Bracket
H7ICTNB= 6" Insulated Ceiling, New Construction Housing, No Socket Bracket

Halo Standard Housings 6-inch (continued)

H7T= 6" Non-IC, New Construction Housing
H7RT= 6" Non-IC, Remodel Housing
H7TNB= 6" Non-IC, New Construction Housing, No Socket Bracket
H7TCP= 6" Non-IC, Chicago Plenum, New Construction/Remodel Housing
H7UICAT= 6" Insulated Ceiling, Universal, Air-Tite, New Construction Housing
E7ICAT= 6" Insulated Ceiling, Air-Tite New Construction Housing
E7RICAT= 6" Insulated Ceiling, Air-Tite Remodel Housing
E7ICATNB= 6" Insulated Ceiling, Air-Tite New Construction Housing, No Socket Bracket
E7TAT= 6" Non-IC, New Construction Housing
E7RTAT= 6" Non-IC, Remodel Housing
E7TATNB= 6" Non-IC, New Construction Housing, No Socket Bracket

Halo Standard Housings 5-inch

H5ICAT= 5" Insulated Ceiling, Air-Tite New Construction Housing
H5RICAT= 5" Insulated Ceiling, Air-Tite Remodel Housing
H5ICATNB= 5" Insulated Ceiling, Air-Tite New Construction Housing, No Socket Bracket
H5T= 5" Non-IC, New Construction Housing
H5RT= 5" Non-IC, Remodel Housing
H5TNB= 5" Non-IC, New Construction Housing, No Socket Bracket
E5ICAT= 5" Insulated Ceiling, Air-Tite New Construction Housing
E5RICAT= 5" Insulated Ceiling, Air-Tite Remodel Housing
E5ICATNB= 5" Insulated Ceiling, Air-Tite New Construction Housing, No Socket Bracket
E5TAT= 5" Non-IC, New Construction Housing
E5RTAT= 5" Non-IC, Remodel Housing
E5TATNB= 5" Non-IC, New Construction Housing, No Socket Bracket

Halo Shallow Housings 6-inch

H27ICAT= 6" Shallow, Insulated Ceiling, Air-Tite New Construction
H27RICAT= 6" Shallow, Insulated Ceiling, Air-Tite Remodel Housing
H27T= 6" Shallow, Non-IC, New Construction Housing
H27RT= 6" Shallow, Non-IC, Remodel Housing
E27ICAT= 6" Shallow, Insulated Ceiling, Air-Tite New Construction
E27RICAT= 6" Shallow, Insulated Ceiling, Air-Tite Remodel Housing
E27TAT= 6" Shallow, Non-IC, New Construction Housing
E27RTAT= 6" Shallow, Non-IC, Remodel Housing

Halo Shallow Housings 5-inch

H25ICAT= 5" Shallow, Insulated Ceiling, Air-Tite New Construction
H25RICAT= 5" Shallow, Insulated Ceiling, Air-Tite Remodel
H25ICATNB= 5" Shallow, Insulated Ceiling, Air-Tite New Construction, No Socket Bracket

SMD-DM

Direct Ceiling Mount

- 4-inch and 6-inch aperture, round and square
- No housng or junction box required
- Rated for wet location
- Dimmable

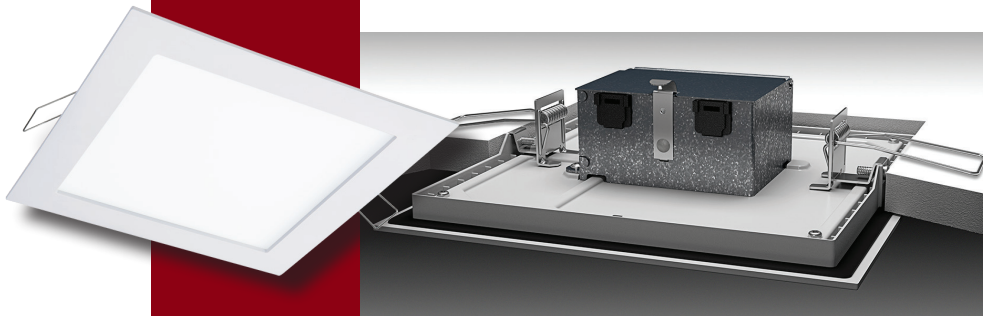



Easy Installation*

*Images show installation of the square SMD-DM.
Follow the same steps for the round products.

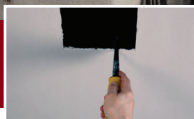

1. Cut a hole in drywall with the provided template.



2. Wire to the integrated fixture junction box.



3. Fold both of the spring clips upward.



4. Push the fixture up into place.

SMD4RXXWHDM

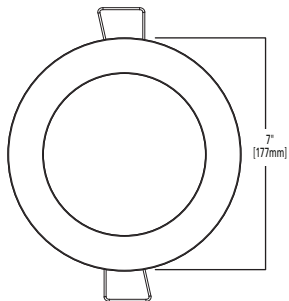
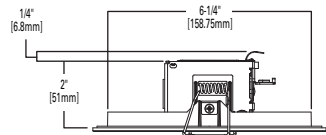

SMD4SXXWHDM

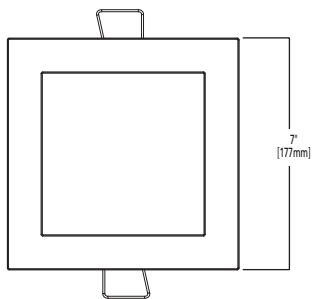
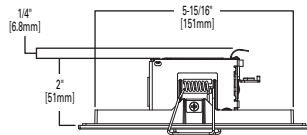

SMD6RXXWHDM

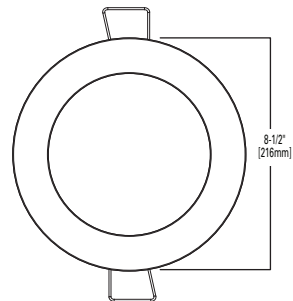
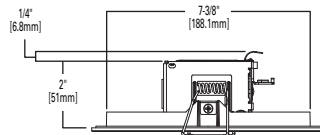

SMD6SXXWHDM

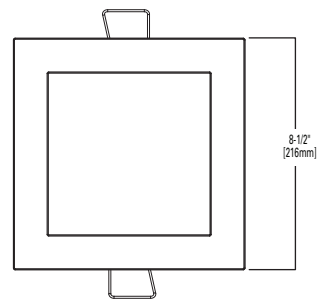
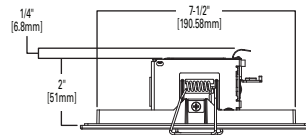

SMD-DM Ordering Information

SMD4-DM Sample Number: **SMD4R6930WHDM=4"** Round Surface Mount Downlight, 90CRI, 3000K, Spring Clips

Models	Lumens	CRI / CCT	Finish	Mounting
SMD4R= 4" Round Surface Mount Downlight, 120V SMD4S= 4" Square Surface Mount Downlight, 120V	6=600 lumen series (nominal)	927=90CRI, 2700K 930=90CRI, 3000K 935=90CRI, 3500K 940=90CRI, 4000K 950=90CRI, 5000K	WH=Matte White	DM=Direct Mount

SMD6-DM Sample Number: **SMD6R6930WHDM=6"** Round Surface Mount Downlight, 90CRI, 3000K, Spring Clips

Models	Lumens	CRI / CCT	Finish	Mounting
SMD6R= 6" Round Surface Mount Downlight, 120V SMD6S= 6" Square Surface Mount Downlight, 120V	6=600 lumen series (nominal)	927=90CRI, 2700K 930=90CRI, 3000K 935=90CRI, 3500K 940=90CRI, 4000K 950=90CRI, 5000K	WH=Matte White	DM=Direct Mount

Energy Data

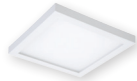

SMD4 Energy Data	Round	Square
Lumens (5000K)	786	810
Input Power	9.7 W	10 W
Input Current	0.0811 A	0.0829 A
Efficiency	81 lm/W	81 lm/W
THD	13.3	13.2
Input Voltage	120V	120V
Input Frequency	50/60 Hz	50/60 Hz
CRI	90 CRI	90 CRI
Power Factor	≥ 0.99	≥ 0.99
T Ambient	-30°C - +40°C	-30°C - +40°C
Sound Rating	Class A	Class A



SMD6 Energy Data	600 lumen		1200 lumen	
	Round	Square	Round	Square
Lumens (5000K)	788	815	1252	1235
Input Power	9.6 W	9.9 W	15.3 W	15.7 W
Input Current	0.0811 A	0.085 A	0.133 A	0.132 A
Efficiency	82 lm/W	82 lm/W	81 lm/W	78 lm/W
THD	13.9	14.7	15.3	15.7
Input Voltage	120V	120V	120V	120V
Input Frequency	50/60 Hz	50/60 Hz	50/60 Hz	50/60 Hz
CRI	90 CRI	90 CRI	90 CRI	90 CRI
Power Factor	≥ 0.99	≥ 0.99	≥ 0.98	≥ 0.98
T Ambient	-30°C - +40°C	-30°C - +40°C	-30°C - +40°C	-30°C - +40°C
Sound Rating	Class A	Class A	Class A	Class A



Lighting Control Solution

Set the mood

Eaton dimmers offer versatile options to set the mood and reduce energy consumption. These compatible LED dimmers are ideal for both residential and light commercial applications and are compatible with decorator (screwless) style devices and wallplates.

Refer to www.eaton.com for additional information.



Dimmer Features	Decorator (DAL06P)	Slide (SAL06P)	Toggle (TAL06P)
Rapid Start feature	Fully adjustable	Fixed ON	Fully adjustable
Adjustable high-end trim			
Adjustable low-end trim	•	•	•
Wiring configurations	Single-pole or three-way	Single-pole or three-way	Single-pole or three-way
Color change kits	•		•

Eaton

1121 Highway 74 South
Peachtree City, GA 30269
P: 770-486-4800
www.eaton.com/lighting

Canada Sales
5925 McLaughlin Road
Mississauga, Ontario L5R 1B8
P: 905-501-3000
F: 905-501-3172

Our Lighting Product Lines

Halo
Halo Commercial
Portfolio
IRiS
RSA
Metalux
Corelite
Neo-Ray
Fail-Safe
MWS
Ametrix
Shaper
io
Lumark
McGraw-Edison
Invue
Ephesus
Lumière
Streetworks
AtLite
Sure-Lites

Our Controls Product Lines

Greengate
iLumin
Zero 88
Fifth Light Technology
iLight (International Only)



Powering Business Worldwide

Eaton

1121 Highway 74 South
Peachtree City, GA 30269
P: 770-486-4800
www.eaton.com/lighting

© 2017 Eaton
All Rights Reserved
Printed in USA
Publication No. BR518031EN
February 2017

Eaton is a registered trademark.

All other trademarks are property
of their respective owners.