

Surface LED Downlight  
SLD Series

**HALO**



**EATON**

*Powering Business Worldwide*

# SLD Surface LED Downlight Luminaire



## WaveStream™ LED

*Taking Control of Light.*

Halo **SLD Series** Surface LED Downlight luminaires incorporate WaveStream™ LED technology to create an ultra-low profile, surface-mounting luminaire with the performance and look of traditional downlights. The SLD Series 4" and 6" luminaires are designed for installation in many 3-1/2" and 4" electrical junction boxes, and may be retrofit in 4", 5", or 6" aperture IC and Non-IC recessed housings. A dedicated LED wiring connector meets high-efficacy code requirements when in recessed downlight housings and prevents substitution of lower efficacy sources. Perfect for residential or commercial installations and ideal for closets, storage areas, attics and basements. For closets, compliant with NFPA® 70, NEC® Section 410.16 (A)(3) and 410.16 (C)(5). The SLD Series offers unparalleled design freedom with mainstream value.

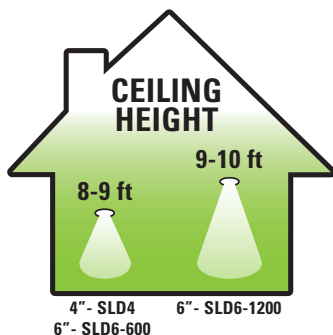

## LUMEN SERIES

**Innovation** you can rely on™

## Features

- 4" and 6" ultra-low profile surface mounting
- WaveStream™ LED Technology
  - Downlight cone-of-light performance
  - AccuAim™ optics for directional control
- 4" SLD4 and 6" SLD6 - 600 Series
  - Lumens: up to 800
  - Wattage: 12.2W (13.2W SLD6 90CRI)
  - Voltage: 120V, 50/60 Hz
- 6" SLD6 - 1200 Series
  - Lumens: up to 1215
  - Wattage: 14.8W
  - Voltage: 120V, 50/60 Hz
- 2700K, 3000K, 3500K, and 4000K CCT
- 80 CRI and 90 CRI options
- Dimmable to 5% with many 120V leading-edge and trailing-edge phase control dimmers
- Installs in many 3-1/2" and 4" ceiling junction boxes
- Retrofits 4", 5", or 6" recessed downlight housings
- cULus Listed for Halo housings
- UL Classified for other housings
- Damp Location Listed for walls
- Wet Location Listed for showers and outdoor protected ceilings
- Plug-in LED connector for easy installation
  - Supply wire adapter connection, for junction box wiring\*
  - Screwbase adapter for recessed housing retrofit\*\*



\*LED connector on SLD meets CA Title 24

\*\* Retrofit only - not for CA Title 24

## Compliances

### 90 CRI



Can be used to comply with California Title 24 High Efficacy requirements. Certified to California Title 20 Appliance Efficiency Database.

### 80 CRI



Can be used to comply with California Title 24 Non-Residential Lighting Controls requirements as a LED Luminaire.



Refer to ENERGY STAR® Certified Products List.

# SLD4 4" LED Surface Downlight Luminaire



## SLD4 Designer Trims (Order Separately)



**SLD4TRMSN**  
Satin Nickel

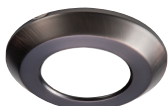

**SLD4TRMTBZ**  
Tuscan Bronze



**SLD4TRMWH**  
White (Paintable)

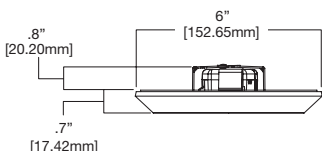
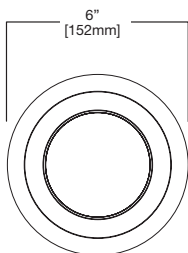

### SLD4 Energy Data

	80 CRI	90 CRI
<b>Lumens (4000K)</b>	800	710
<b>Input Voltage</b>	120V	120V
<b>Input Frequency</b>	50/60 Hz	50/60 Hz
<b>Input Current</b>	0.10 A	0.10 A
<b>Input Power</b>	12.2 W	12 W
<b>Efficiency (4000K)</b>	66 lm/W	59 lm/W
<b>THD</b>	≤ 20%	≤ 20%
<b>Power Factor</b>	≥ 0.90	≥ 0.90
<b>T Ambient</b>	-30 - +40°C	-30 - +40°C
<b>Sound Rating</b>	Class A	Class A

**OVER \$460<sup>A</sup>**  
**SAVINGS**

**LASTS 22<sup>\*</sup>**  
**YEARS**

\* Based on average six hours use per day.

<sup>A</sup> Savings are over the life of the Halo SLD4 luminaire.

Energy savings: \$367

Replacement lamp savings: \$95

Savings based on \$0.155 per kilowatt hour, average six hours use per day, 50,000 hours of lamp usage, and 60W PAR16 Halogen lamp lumen equivalent.



# SLD6 6" LED Surface Downlight Luminaire



## SLD6 Designer Trims (Order Separately)



**SLD6TRMSN**  
Satin Nickel



**SLD6TRMTBZ**  
Tuscan Bronze



**SLD6TRMWH**  
White (Paintable)

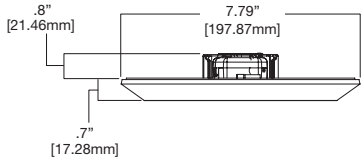
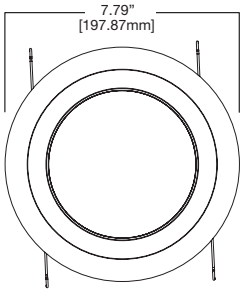

SLD6 Energy Data	600 Series		1200 Series	
	80 CRI	90 CRI	80 CRI	90 CRI
<b>Lumens (4000K)</b>	800	780	1215	1000
<b>Input Voltage</b>	120V	120V	120V	120V
<b>Input Frequency</b>	50/60 Hz	50/60 Hz	50/60 Hz	50/60 Hz
<b>Input Current</b>	0.10 A	0.11 A	0.12 A	0.12 A
<b>Input Power</b>	12.2 W	13.2 W	14.8 W	14.8 W
<b>Efficiency (4000K)</b>	66 lm/W	59 lm/W	82 lm/W	68 lm/W
<b>THD</b>	≤ 20%	≤ 20%	≤ 20%	≤ 20%
<b>Power Factor</b>	≥ 0.90	≥ 0.90	≥ 0.90	≥ 0.90
<b>T Ambient</b>	-30 - +40°C	-30 - +40°C	-30 - +40°C	-30 - +40°C
<b>Sound Rating</b>	Class A	Class A	Class A	Class A

OVER **\$475\*\***  
**SAVINGS**

LASTS **22\***  
**YEARS**

\* Based on average six hours use per day.

\*\* Savings are over the life of the Halo SLD6-600 Series luminaire.

Energy savings: \$406

Replacement lamp savings: \$77

Savings based on \$0.155 per kilowatt hour, average six hours use per day, 50,000 hours of lamp usage, and 65W BR30 lamp lumen equivalent.

# SLD Designer Trim Rings

SLD trims provide the ultimate in design freedom to match décor and interior fittings in a space with an offering of satin nickel and tuscan bronze plated trims, plus a white trim that may be field painted prior to installation to an alternate color choice.



**White  
(Paintable)**

**Satin Nickel**

**Tuscan  
Bronze**



The versatile SLD trims are optional accessories that snap over the SLD. Note that use of the pre-installed thin film tape on the back side of the trim is required to secure the trim and prevent rotation when installing the SLD unit.

[www.eaton.com/lighting](http://www.eaton.com/lighting)

# Junction Box Accessories

## Spacer Extension Ring

The spacer extension ring adds 15/16" depth when the SLD driver cannot fit into a junction box due to excess wire fill or other obstruction. The spacer extension ring is also a problem solver for installations with shallow pancake boxes or plaster rings.



### SLD4EXT

4" Surface LED Space Ring

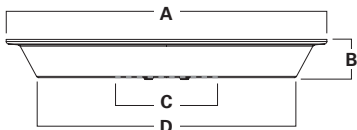

	A	B	C	D
SLD4EXT	7.75"	0.925"	3.88"	6.25"
SLD6EXT	9.5"	0.925"	3.88"	8"



### SLD6EXT

6" Surface LED Spacer Ring

Standard J-box

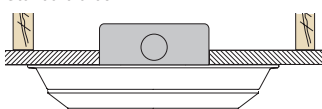

Standard J-box with plaster ring

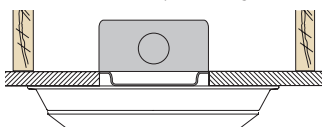

Shallow J-box (pancake)

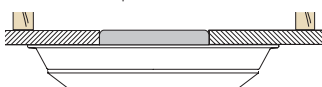

## Surface Box Adapter

The surface box adapter allows the user to install the SLD to a junction box that is mounted flat on a ceiling or beam surface (not recessed in the ceiling).



### SLD4RAD

4" SLD Round Surface J-box Adapter

For 4" round and octagon junction boxes.



### SLD6RAD

6" SLD Round Surface J-box Adapter

For 4" round, octagon, and square junction boxes.

(\*use SLD6SADPLT for square J-box)

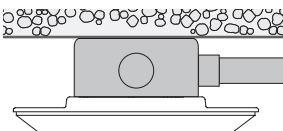

### \*SLD6SADPLT

6" SLD Square Surface J-box Adapter Plate (use with SLD6RAD)

## Concrete

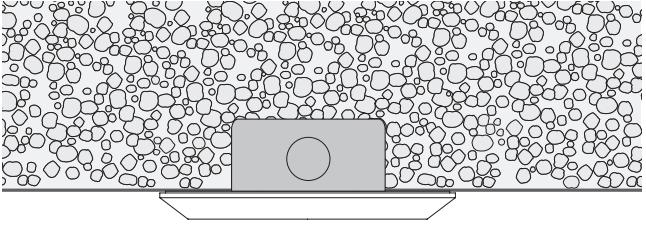

## Fire-rated

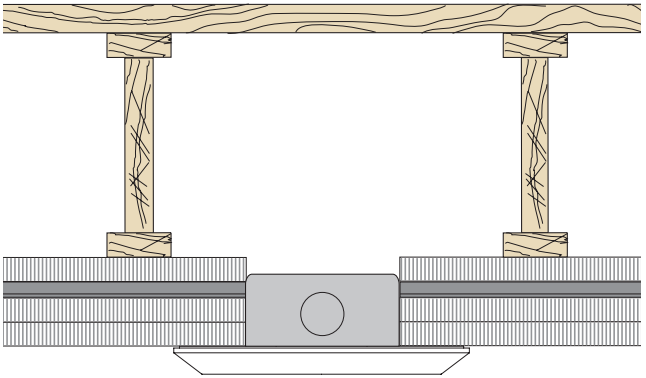

**Shallow plenum? —————**  
**No problem.**



Halo SLD

## Insulation - batting or spray foam

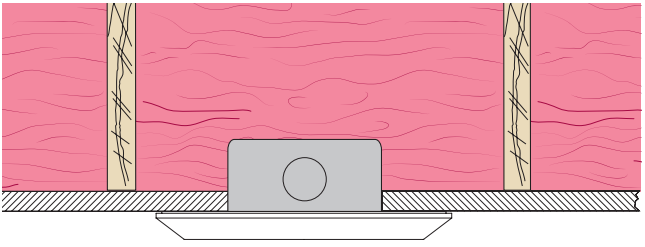

## Framing

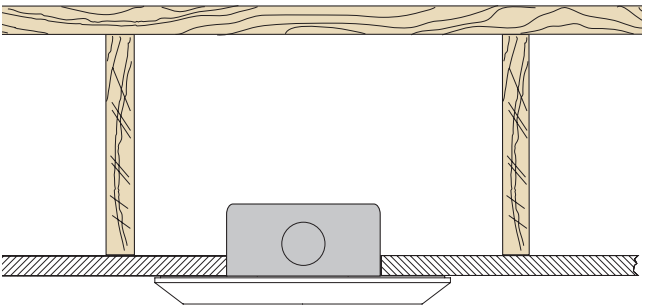

Junction box mounting applications are generalized for illustrative concept only. These are not for construction or specification. Refer to appropriate professional and code authority for specific box and installation requirements.

The perfect solution where there is no plenum space for a recessed downlight.



## SLD6 Junction Box Installation

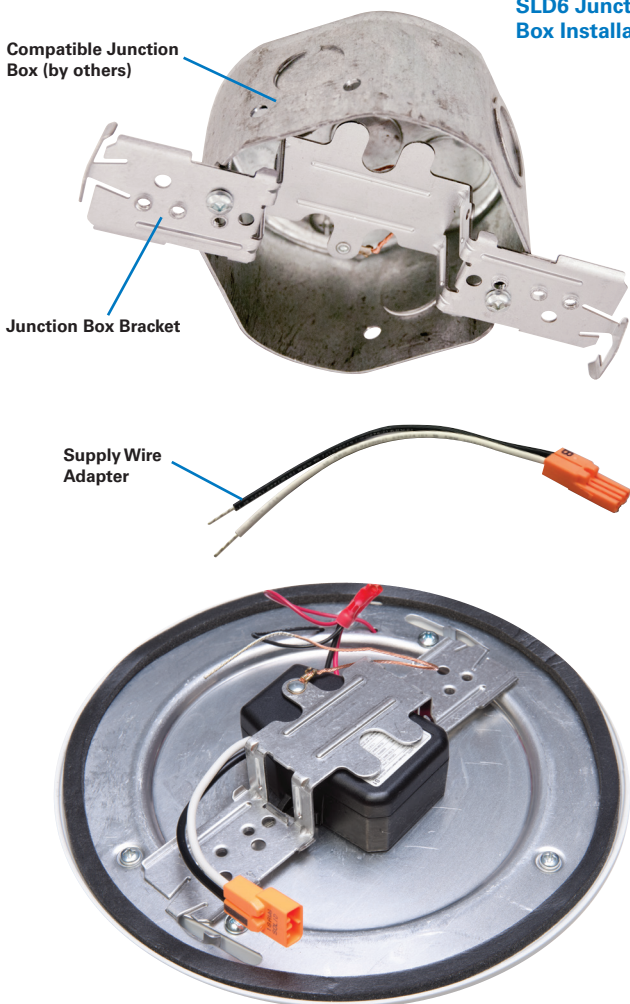

SLD6 with junction box bracket installed.

### Junction Box Mounting Summary

1. Install junction box bracket.
2. Unplug supply wire adapter from SLD. Connect black and white wires from the supply wire adapter to house wiring (black to black and white to white).
3. Locate the supply wire adapter behind the junction box bracket.
4. Plug matching orange LED connector from supply wire adapter to SLD.
5. Align two bracket tabs with slots on back of SLD fixture.
6. Turn clockwise to lock in place.

Note that this is only a summary. Read and follow the instructions included with the product for full details.

Compatible Junction  
Box (by others)

## SLD4 Junction Box Installation

Junction Box Bracket

Supply Wire  
Adapter

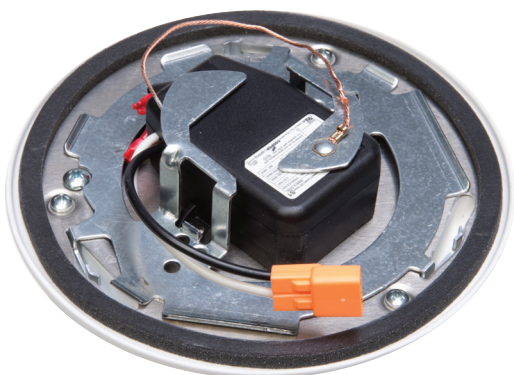

SLD4 with junction box bracket installed.





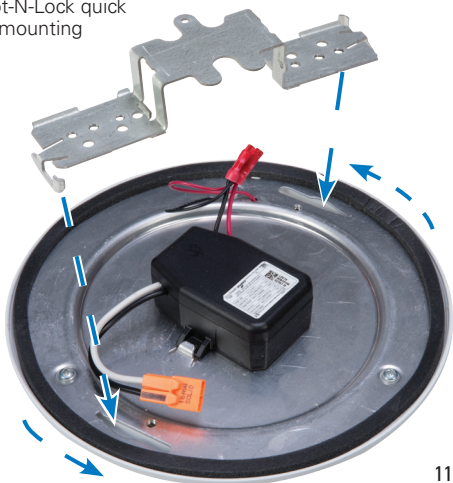

## Slot-N-Lock™

Halo SLD proprietary Slot-N-Lock quick  
installation system with mounting  
bracket.



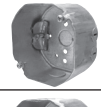

# Compatible Junction Boxes\*

		SLD4	SLD6	SLD4RAD adapter	SLD6RAD adapter
	<b>Octagon - steel light fixture / fan box</b>				
	4" x 4" x 2-1/8"	✓	✓	✓	✓
	4" x 4" x 1-1/2"	✓	✓	✓	✓
	<b>Square - steel deep box</b>				
	4" x 4" x 2-1/8"		✓		✓
	4" x 4" x 1-1/2"		✓		✓
	<b>Round - new work fixture box (plastic)</b>				
	4" diameter x 2-3/16"	✓	✓	✓	✓
	3-1/2" diameter x 2-3/4"	✓	✓	✓	
	<b>Round - old work fixture box (plastic)</b>				
	4-1/4" flange x 2-5/8", 3-1/2" I.D.	✓	✓	✓	
	<b>Round - new work fixture box (plastic) with bar hanger</b>				
	4" diameter x 2-3/16"	✓	✓	✓	✓
	<b>Round surface mount</b>				
	4" diameter x 1-1/2"	△	△	✓	✓
	<b>TP316 - Eaton's Crouse-Hinds junction box for non-metallic cable</b>				
	4" x 4" x 2-1/8"	✓	✓		
	<b>TP317 - Eaton's Crouse-Hinds junction box for metal clad cable</b>				
	4" x 4" x 2-1/8"	△	△		

△ when used with SLD4RAD (SLD4) or SLD6RAD (SLD6)

\*This is a representative list of compatible junction boxes only. Information contained in this literature about other manufacturers' products is from published information made available by the manufacturer and is deemed to be reliable, but has not been verified. Eaton makes no specific recommendation on product selection and there are no warranties of performance or compatibility implied. Installer must determine that site conditions are suitable to allow proper installation of the SLD mounting bracket in the box.

# Recessed Housing Mounting

## Retrofits 4", 5", or 6" recessed housings.

1. Install screwbase adapter to fixture socket. (LED housings skip Step 1)
2. Attach torsion springs or friction clips to SLD following the instructions included with the SLD.
3. Install SLD into recessed can.

Note that this is only a summary. Read the instructions included with the product for full details.

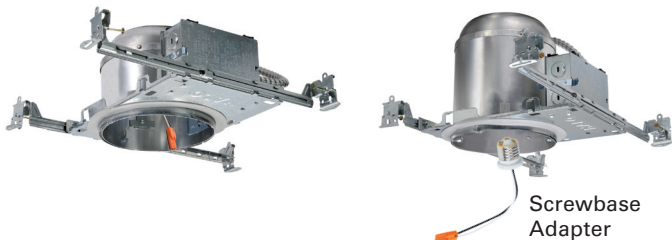

## SLD4 Series Friction Clip Installation



4-inch friction clip

## SLD6 Series Friction Clip Installation



6-inch friction clip position



5-inch friction clip position

## SLD6 Series Torsion Spring Installation

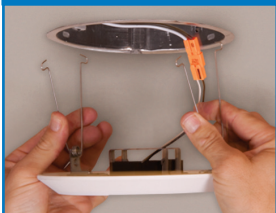

6-inch torsion spring position



5-inch torsion spring position

# Ordering Information

## 4" SLD4

Sample Number: **SLD405927WH + SLD4TRMSN**

**Junction Box Installation:** Order junction box separately, as supplied by others, to complete installation.

**Recessed Installation:** Order Halo recessed housing separately to complete installation.

Standard Models	Color Rendering Index (CRI)	Color Temperature (CCT)	Finish
SLD405= 4" Surface LED Downlight, 120V with recessed retrofit and junction box hardware kits	8= 80 CRI	27= 2700K	WH= White
	9= 90 CRI	30= 3000K	
		35= 3500K	
		40= 4000K	

"JB" Models	Color Rendering Index (CRI)	Color Temperature (CCT)	Finish	JB
SLD405= 4" Surface LED Downlight, 120V with junction box hardware kit only	8= 80 CRI	27= 2700K	WH= White	JB= Junction Box Kit
	9= 90 CRI	30= 3000K		
		35= 3500K		
		40= 4000K		

### Accessories (Order Separately)

**Designer Trims:** fit over the SLD4 for a designer finish, 6" O.D.

**SLD4TRMSN**= 4" SLD Satin Nickel Trim Ring

**SLD4TRMTBZ**= 4" SLD Tuscan Bronze Trim Ring

**SLD4TRMWH**= 4" SLD White Paintable Trim Ring

**J-box Spacer Extension Ring:** add 15/16" depth when SLD driver cannot fit into installed junction box, 7.75" O.D.

**SLD4EXT**= 4" Surface LED J-box Extender

**RAD Adapters:** when junction box is mounted flat on a ceiling or beam surface

**SLD4RAD**= 4" SLD Round Surface J-box Adapter (compatible with 4" round and octagon junction boxes)

**Spare Parts**

**SLD4ACCKIT**= 4" Accessory Parts Replacement Kit (screwbase adapter, and friction blades)

**SLD4BRKT**= 4" Junction Box Bracket and Screws



## 6" SLD6 - 600 Series

Sample Number: **SLD606927WH + SLD6TRMSN**

**Junction Box Installation:** Order junction box separately, as supplied by others, to complete installation.

**Recessed Installation:** Order Halo recessed housing separately to complete installation.

Models	Color Rendering Index (CRI)	Color Temperature (CCT)	Finish
<b>SLD606</b> = 6" Surface LED Downlight, 120V, 600 Series with recessed retrofit and junction box hardware kits	<b>8</b> = 80 CRI	<b>27</b> = 2700K	<b>WH</b> = White
	<b>9</b> = 90 CRI	<b>30</b> = 3000K	
		<b>35</b> = 3500K	
		<b>40</b> = 4000K	

"JB" Models	Color Rendering Index (CRI)	Color Temperature (CCT)	Finish	JB
<b>SLD606</b> = 6" Surface LED Downlight, 120V, 600 Series with junction box hardware kit only	<b>8</b> = 80 CRI	<b>27</b> = 2700K	<b>WH</b> = White	<b>JB</b> = Junction Box Kit
	<b>9</b> = 90 CRI	<b>30</b> = 3000K		
		<b>35</b> = 3500K		
		<b>40</b> = 4000K		

### Accessories (Order Separately)

Designer Trims: fit over the SLD6 for a designer finish, 7.79" O.D.

**SLD6TRMSN**= 6" SLD Satin Nickel Trim Ring

**SLD6TRMTBZ**= 6" SLD Tuscan Bronze Trim Ring

**SLD6TRMWH**= 6" SLD White Paintable Trim Ring

J-box Spacer Extension Ring: add 15/16" depth when SLD driver cannot fit into installed junction box, 9.5" O.D.

**SLD6EXT**= 6" Surface LED J-box Extender

RAD Adapters: when junction box is mounted flat on a ceiling or beam surface

**SLD6RAD**= 6" SLD Round Surface J-box Adapter (compatible with 4" round, octagon, and square junction boxes)

**SLD6SADPLT**= 6" SLD Square Surface J-box Adapter Plate (use with SLD6RAD)

Spare Parts

**SLD6ACCKIT**= 6" Accessory Parts Replacement Kit (screwbase adapter, torsion springs, friction blades)

**SLD6BRKT**= 6" Junction Box Bracket and Screws



# Ordering Information

## 6" SLD6 - 1200 Series

Sample Number: **SLD612927WH + SLD6TRMSN**

**Junction Box Installation:** Order junction box separately, as supplied by others, to complete installation.

**Recessed Installation:** Order Halo recessed housing separately to complete installation.

<b>Models</b>	<b>Color Rendering Index (CRI)</b>	<b>Color Temperature (CCT)</b>	<b>Finish</b>
<b>SLD612</b> = 6" Surface LED Downlight, 120V, 1200 Series with recessed retrofit and junction box hardware kits	<b>8</b> = 80 CRI <b>9</b> = 90 CRI	<b>27</b> = 2700K <b>30</b> = 3000K <b>35</b> = 3500K <b>40</b> = 4000K	<b>WH</b> = White

### Accessories (Order Separately)

Designer Trims: fit over the SLD6 for a designer finish, 7.79" O.D.

**SLD6TRMSN**= 6" SLD Satin Nickel Trim Ring

**SLD6TRMTBZ**= 6" SLD Tuscan Bronze Trim Ring

**SLD6TRMWH**= 6" SLD White Paintable Trim Ring

J-box Spacer Extension Ring: add 15/16" depth when SLD driver cannot fit into installed junction box, 9.5" O.D.

**SLD6EXT**= 6" Surface LED J-box Extender

RAD Adapters: when junction box is mounted flat on a ceiling or beam surface

**SLD6RAD**= 6" SLD Round Surface J-box Adapter (compatible with 4" round, octagon, and square junction boxes)

**SLD6SADPLT**= 6" SLD Square Surface J-box Adapter Plate (use with SLD6RAD)

Spare Parts

**SLD6ACCKIT**= 6" Accessory Parts Replacement Kit (screwbase adapter, torsion springs, friction blades)

**SLD6BRKT**= 6" Junction Box Bracket and Screws

# Housing Compatibility

## 4" Housings - Halo and All-Pro UL Listed Compatibility

### Recessed Can Size    Catalog Number

Compatible Halo LED Housings with LED Luminaire High-efficacy Compliant Connector (Meets CA Title 24 requirements)

**4"**

H995ICAT, H995RICAT

Compatible Halo Incandescent E26 Screwbase Housings

**4"**

H99ICAT, H99TAT, H99RTAT

Compatible All-Pro Incandescent E26 Screwbase Housings

**4"**

EI400ATSB, ET400ATSB, ET400RATSB

## 6" Housings - Halo and All-Pro UL Listed Compatibility

### Recessed Can Size    Catalog Number

Compatible Halo LED Housings with LED Luminaire High-efficacy Compliant Connector (Meets CA Title 24 requirements)

**5"**

H550ICAT, H550RICAT

**6"**

H750ICAT, H750RICAT, H750T, H750RINTD010, H750TCP, H2750ICAT

Halo LED Retrofit Enclosures

**6"**

ML7BXRFK, ML7E26RFK

Compatible Halo Incandescent E26 Screwbase Housings

**5"**

H5ICAT, H5RICAT, H5T, H5RT, H5TM, H25ICAT

**6"**

H7ICAT, H7RICAT, H7ICT, H7RICT, H7ICATNB, H7ICTNB, H7T, H7RT, H7TNB, H7TCP, H7UICAT, H7UICAT, H27ICAT, H27RICAT, H27ICT, H27RICT, H27T, H27RT

Compatible All-Pro Incandescent E26 Screwbase Housings

**5"**

EI500AT, EI500RAT, ET500, ET500R

**6"**

EI700AT, EI700RAT, EI700, EI700R, EI700ATNB, EI700NB, EI700U, EI700UAT, ET700, ET700R, EI2700AT, EI2700, EI2700R, ET2700, ET2700R

The SLD Series surface LED downlight luminaire is cULus Listed or UL Classified for use with any 4" (SLD4) or 5"/6" (SLD6) diameter recessed housings constructed of steel or aluminum with an internal volume that exceeds 62.3 in<sup>3</sup> (SLD4) or 107.9 in<sup>3</sup> (SLD6) in addition to those noted above.



# Replacement Parts Kits



## **SLD4ACCKIT**

SLD4 Retrofit Kit

SLD4 screwbase adapter, friction blades, ground wire, mounting screws, wire nuts

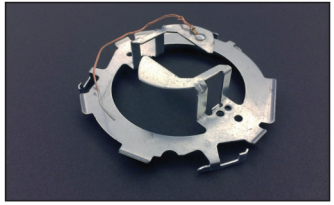

## **SLD4BRKT**

SLD4 Junction box mounting bracket and mounting screws

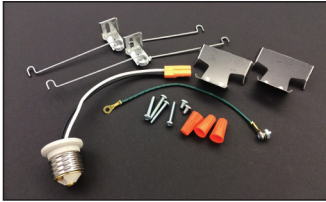

## **SLD6ACCKIT**

SLD6 Retrofit Kit

SLD6 screwbase adapter, friction blades, torsion springs, ground wire, mounting screws, wire nuts

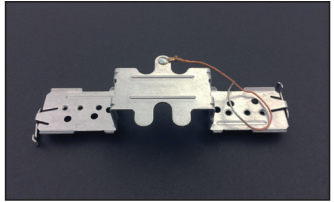

## **SLD6BRKT**

SLD6 Junction box mounting bracket and mounting screws





# Lighting Control Solutions



Powering Business Worldwide

Eaton dimmers offer versatile options to set the mood and reduce energy consumption. These compatible LED dimmers are ideal for both residential and light commercial applications and are compatible with decorator (screwless) style devices and wallplates.

Refer to [www.eaton.com](http://www.eaton.com) for additional information.



Dimmer Features	Smart (AAL06P)	Decorator (DAL06P)
<b>Rapid Start feature</b>	Selectable ON or OFF	Fully adjustable
<b>Adjustable high-end trim</b>	•	
<b>Adjustable low-end trim</b>	•	•
<b>Wiring configurations</b>	Single-pole or multi-location	Single-pole or three-way
<b>Color change kits</b>	•	•



Dimmer Features	Slide (SAL06P)	Toggle (TAL06P)
<b>Rapid Start feature</b>	Fixed ON	Fully adjustable
<b>Adjustable high-end trim</b>		
<b>Adjustable low-end trim</b>	•	•
<b>Wiring configurations</b>	Single-pole or three-way	Single-pole or three-way
<b>Color change kits</b>		•

**Note:** The Rapid Start feature is used to ensure the right amount of power boost during start-up. When a dimmer with Rapid Start is turned on from a low dimmer setting, the LED lighting may exhibit a momentary flash. Designated dimmer models offer an adjustment of the Rapid Start feature. The user may wish to adjust this setting to reduce the boost and resulting momentary flash. If this capability is desired, the user should select dimmer models noted as "fully adjustable" or "selectable ON or OFF".

# Product and Photometric Data

- Downlight cone-of-light distribution
- Maximum spacing criteria
- Optimized design for general downlighting
- Exceeds 83% of light between 0-60° cone-of-light zone
- ENERGY STAR® and California Title 24 - zonal and efficacy requirements

## SLD4

Cat No.	CRI	CCT	Lumens	Power (W)	LPW
SLD405827WH (JB)	80	2700	720	12.2	59
SLD405830WH (JB)	80	3000	750	12.2	61
SLD405835WH (JB)	80	3500	780	12.2	64
SLD405840WH (JB)	80	4000	800	12.2	66
SLD405927WH (JB)	90	2700	650	12	54
SLD405930WH (JB)	90	3000	670	12	56
SLD405935WH (JB)	90	3500	690	12	58
SLD405940WH (JB)	90	4000	710	12	59

SLD405830WH		
Luminaire lumens		750
Input watts		12.2
LER (LPW)		61
Spacing Criteria	0-180	1.4
	90-270	1.4
	Diagonal	1.5
Beam angle (degrees)		107
Field angle (degrees)		159
Zonal lumen	Lumens	% Lumens
0-30	212	28%
0-40	357	48%
0-60	623	83%
0-90	750	100%

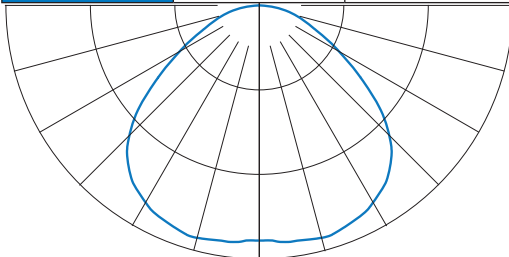



## SLD6 - 600 Series

Cat No.	CRI	CCT	Lumens	Power (W)	LPW
SLD606827WH (JB)	80	2700	727	12.2	60
SLD606830WH (JB)	80	3000	760	12.2	62
SLD606835WH (JB)	80	3500	780	12.2	64
SLD606840WH (JB)	80	4000	800	12.2	66
SLD606927WH (JB)	90	2700	710	13.2	54
SLD606930WH (JB)	90	3000	735	13.2	56
SLD606935WH (JB)	90	3500	760	13.2	58
SLD606940WH (JB)	90	4000	780	13.2	59

SLD606830WH		
Luminaire lumens		760
Input watts		12.2
LER (LPW)		62
Spacing Criteria	0-180	1.5
	90-270	1.5
	Diagonal	1.5
Beam angle (degrees)		103
Field angle (degrees)		159
Zonal lumen	Lumens	% Lumens
0-30	215	28%
0-40	364	48%
0-60	631	83%
0-90	760	100%

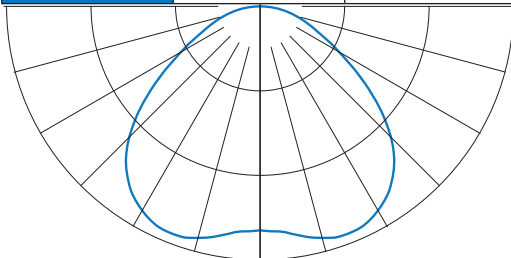

# Product and Photometric Data

## SLD6 - 1200 Series

Cat No.	CRI	CCT	Lumens	Power (W)	LPW
SLD612827WH	80	2700	1100	14.8	74
SLD612830WH	80	3000	1150	14.8	78
SLD612835WH	80	3500	1200	14.8	81
SLD612840WH	80	4000	1215	14.8	82
SLD612927WH	90	2700	880	14.8	59
SLD612930WH	90	3000	925	14.8	63
SLD612935WH	90	3500	965	14.8	65
SLD612940WH	90	4000	1000	14.8	68

SLD612830WH		
Luminaire lumens		1150
Input watts		14.8
LER (LPW)		78
Spacing Criteria	0-180	1.4
	90-270	1.4
	Diagonal	1.5
Beam angle (degrees)		107
Field angle (degrees)		159
Zonal lumen	Lumens	% Lumens
0-30	320	28%
0-40	541	47%
0-60	952	83%
0-90	1150	100%

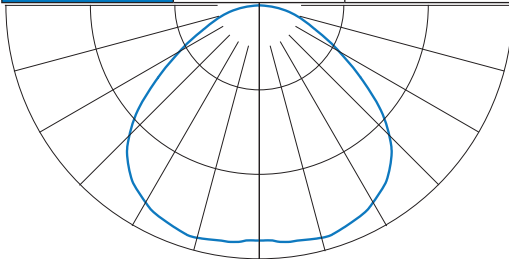



## Eaton

1121 Highway 74 South  
Peachtree City, GA 30269  
P: 770-486-4800  
[www.eaton.com/lighting](http://www.eaton.com/lighting)

Canada Sales  
5925 McLaughlin Road  
Mississauga, Ontario L5R 1B8  
P: 905-501-3000  
F: 905-501-3172

### Our Lighting Product Lines

Halo  
Halo Commercial  
Portfolio  
IRiS  
RSA  
Metalux  
Corelite  
Neo-Ray  
Fail-Safe  
MWS  
Ametrix  
Shaper  
io  
Lumark  
McGraw-Edison  
Invue  
Lumière  
Streetworks  
AtLite  
Sure-Lites

### Our Controls Product Lines

Greengate  
iLumin  
Zero 88  
Fifth Light Technology  
iLight (International Only)

#### Eaton

1121 Highway 74 South  
Peachtree City, GA 30269  
P: 770-486-4800  
[www.eaton.com/lighting](http://www.eaton.com/lighting)

© 2015 Eaton  
All Rights Reserved  
Printed in USA  
Publication No. BR518010EN  
July 2015

Products, specifications and  
compliances are subject to  
change without notice.

Eaton is a registered trademark.

All other trademarks are property  
of their respective owners.



*Powering Business Worldwide*

Surface LED Downlight  
SLD Series

**HALO**



**EATON**

*Powering Business Worldwide*



# SLD Surface LED Downlight Luminaire



## WaveStream™ LED

*Taking Control of Light.*

Halo **SLD Series** Surface LED Downlight luminaires incorporate WaveStream™ LED technology to create an ultra-low profile, surface-mounting luminaire with the performance and look of traditional downlights. The SLD Series 4" and 6" luminaires are designed for installation in many 3-1/2" and 4" electrical junction boxes, and may be retrofit in 4", 5", or 6" aperture IC and Non-IC recessed housings. A dedicated LED wiring connector meets high-efficacy code requirements when in recessed downlight housings and prevents substitution of lower efficacy sources. Perfect for residential or commercial installations and ideal for closets, storage areas, attics and basements. For closets, compliant with NFPA® 70, NEC® Section 410.16 (A)(3) and 410.16 (C)(5). The SLD Series offers unparalleled design freedom with mainstream value.

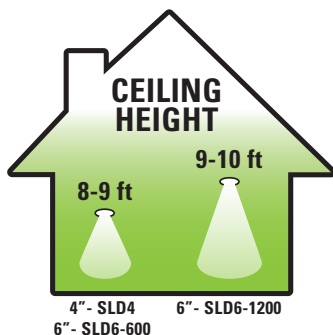

## LUMEN SERIES

**Innovation** you can rely on™

## Features

- 4" and 6" ultra-low profile surface mounting
- WaveStream™ LED Technology
  - Downlight cone-of-light performance
  - AccuAim™ optics for directional control
- 4" SLD4 and 6" SLD6 - 600 Series
  - Lumens: up to 800
  - Wattage: 12.2W (13.2W SLD6 90CRI)
  - Voltage: 120V, 50/60 Hz
- 6" SLD6 - 1200 Series
  - Lumens: up to 1215
  - Wattage: 14.8W
  - Voltage: 120V, 50/60 Hz
- 2700K, 3000K, 3500K, and 4000K CCT
- 80 CRI and 90 CRI options
- Dimmable to 5% with many 120V leading-edge and trailing-edge phase control dimmers
- Installs in many 3-1/2" and 4" ceiling junction boxes
- Retrofits 4", 5", or 6" recessed downlight housings
- cULus Listed for Halo housings
- UL Classified for other housings
- Damp Location Listed for walls
- Wet Location Listed for showers and outdoor protected ceilings
- Plug-in LED connector for easy installation
  - Supply wire adapter connection, for junction box wiring\*
  - Screwbase adapter for recessed housing retrofit\*\*



\*LED connector on SLD meets CA Title 24

\*\* Retrofit only - not for CA Title 24

## Compliances

### 90 CRI



Can be used to comply with California Title 24 High Efficacy requirements. Certified to California Title 20 Appliance Efficiency Database.

### 80 CRI



Can be used to comply with California Title 24 Non-Residential Lighting Controls requirements as a LED Luminaire.



Refer to ENERGY STAR® Certified Products List.

# SLD4 4" LED Surface Downlight Luminaire



## SLD4 Designer Trims (Order Separately)



**SLD4TRMSN**  
Satin Nickel

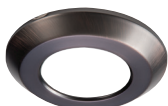

**SLD4TRMTBZ**  
Tuscan Bronze



**SLD4TRMWH**  
White (Paintable)

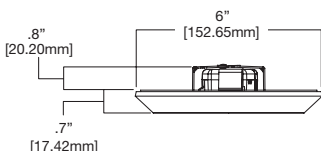
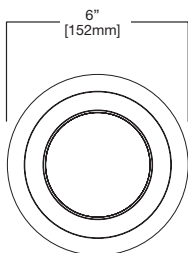

### SLD4 Energy Data

	80 CRI	90 CRI
<b>Lumens (4000K)</b>	800	710
<b>Input Voltage</b>	120V	120V
<b>Input Frequency</b>	50/60 Hz	50/60 Hz
<b>Input Current</b>	0.10 A	0.10 A
<b>Input Power</b>	12.2 W	12 W
<b>Efficiency (4000K)</b>	66 lm/W	59 lm/W
<b>THD</b>	≤ 20%	≤ 20%
<b>Power Factor</b>	≥ 0.90	≥ 0.90
<b>T Ambient</b>	-30 - +40°C	-30 - +40°C
<b>Sound Rating</b>	Class A	Class A

**OVER \$460<sup>A</sup>**  
**SAVINGS**

**LASTS 22<sup>\*</sup>**  
**YEARS**

\* Based on average six hours use per day.

<sup>A</sup> Savings are over the life of the Halo SLD4 luminaire.

Energy savings: \$367

Replacement lamp savings: \$95

Savings based on \$0.155 per kilowatt hour, average six hours use per day, 50,000 hours of lamp usage, and 60W PAR16 Halogen lamp lumen equivalent.

# SLD6 6" LED Surface Downlight Luminaire



## SLD6 Designer Trims (Order Separately)



**SLD6TRMSN**  
Satin Nickel



**SLD6TRMTBZ**  
Tuscan Bronze



**SLD6TRMWH**  
White (Paintable)

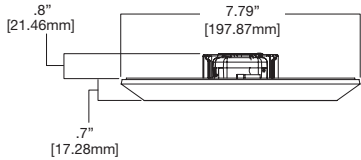
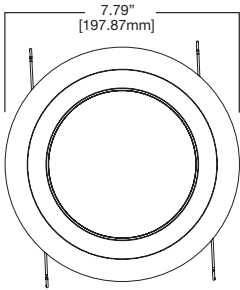

SLD6 Energy Data	600 Series		1200 Series	
	80 CRI	90 CRI	80 CRI	90 CRI
<b>Lumens (4000K)</b>	800	780	1215	1000
<b>Input Voltage</b>	120V	120V	120V	120V
<b>Input Frequency</b>	50/60 Hz	50/60 Hz	50/60 Hz	50/60 Hz
<b>Input Current</b>	0.10 A	0.11 A	0.12 A	0.12 A
<b>Input Power</b>	12.2 W	13.2 W	14.8 W	14.8 W
<b>Efficiency (4000K)</b>	66 lm/W	59 lm/W	82 lm/W	68 lm/W
<b>THD</b>	≤ 20%	≤ 20%	≤ 20%	≤ 20%
<b>Power Factor</b>	≥ 0.90	≥ 0.90	≥ 0.90	≥ 0.90
<b>T Ambient</b>	-30 - +40°C	-30 - +40°C	-30 - +40°C	-30 - +40°C
<b>Sound Rating</b>	Class A	Class A	Class A	Class A

**OVER \$475\*\*  
SAVINGS**

**LASTS 22\*  
YEARS**

\* Based on average six hours use per day.

\*\* Savings are over the life of the Halo SLD6-600 Series luminaire.

Energy savings: \$406

Replacement lamp savings: \$77

Savings based on \$0.155 per kilowatt hour, average six hours use per day, 50,000 hours of lamp usage, and 65W BR30 lamp lumen equivalent.

# SLD Designer Trim Rings

SLD trims provide the ultimate in design freedom to match décor and interior fittings in a space with an offering of satin nickel and tuscan bronze plated trims, plus a white trim that may be field painted prior to installation to an alternate color choice.



**White  
(Paintable)**

**Satin Nickel**

**Tuscan  
Bronze**



The versatile SLD trims are optional accessories that snap over the SLD. Note that use of the pre-installed thin film tape on the back side of the trim is required to secure the trim and prevent rotation when installing the SLD unit.

[www.eaton.com/lighting](http://www.eaton.com/lighting)

# Junction Box Accessories

## Spacer Extension Ring

The spacer extension ring adds 15/16" depth when the SLD driver cannot fit into a junction box due to excess wire fill or other obstruction. The spacer extension ring is also a problem solver for installations with shallow pancake boxes or plaster rings.



### SLD4EXT

4" Surface LED Space Ring

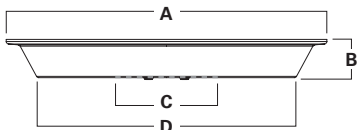

	A	B	C	D
SLD4EXT	7.75"	0.925"	3.88"	6.25"
SLD6EXT	9.5"	0.925"	3.88"	8"



### SLD6EXT

6" Surface LED Spacer Ring

Standard J-box

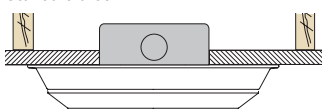

Standard J-box with plaster ring

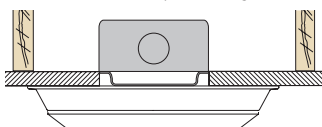

Shallow J-box (pancake)

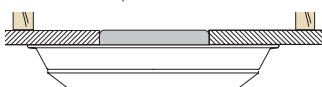

## Surface Box Adapter

The surface box adapter allows the user to install the SLD to a junction box that is mounted flat on a ceiling or beam surface (not recessed in the ceiling).



### SLD4RAD

4" SLD Round Surface J-box Adapter

For 4" round and octagon junction boxes.



### SLD6RAD

6" SLD Round Surface J-box Adapter

For 4" round, octagon, and square junction boxes.

(\*use SLD6SADPLT for square J-box)

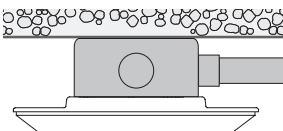

### \*SLD6SADPLT

6" SLD Square Surface J-box Adapter Plate (use with SLD6RAD)

## Concrete

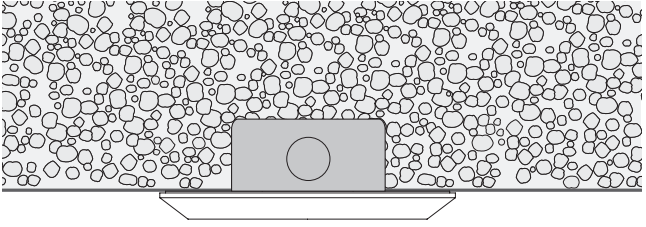

## Fire-rated

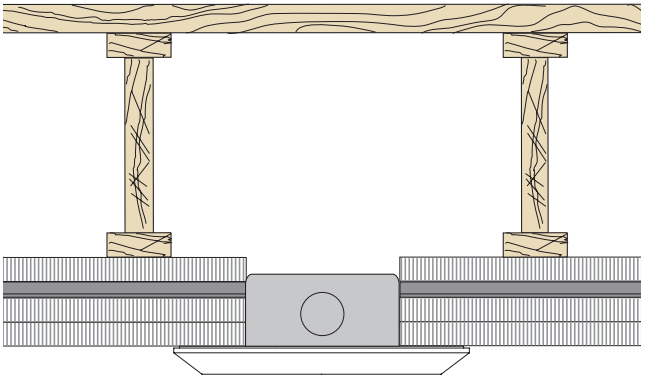

**Shallow plenum? —————**  
**No problem.**



Halo SLD



## Insulation - batting or spray foam

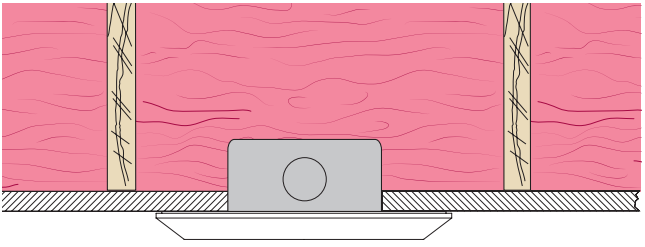

## Framing

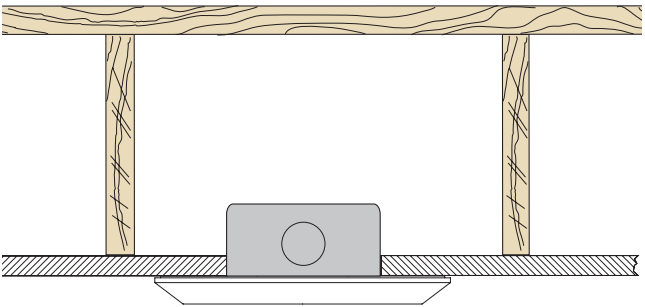

Junction box mounting applications are generalized for illustrative concept only. These are not for construction or specification. Refer to appropriate professional and code authority for specific box and installation requirements.

The perfect solution where there is no plenum space for a recessed downlight.



## SLD6 Junction Box Installation

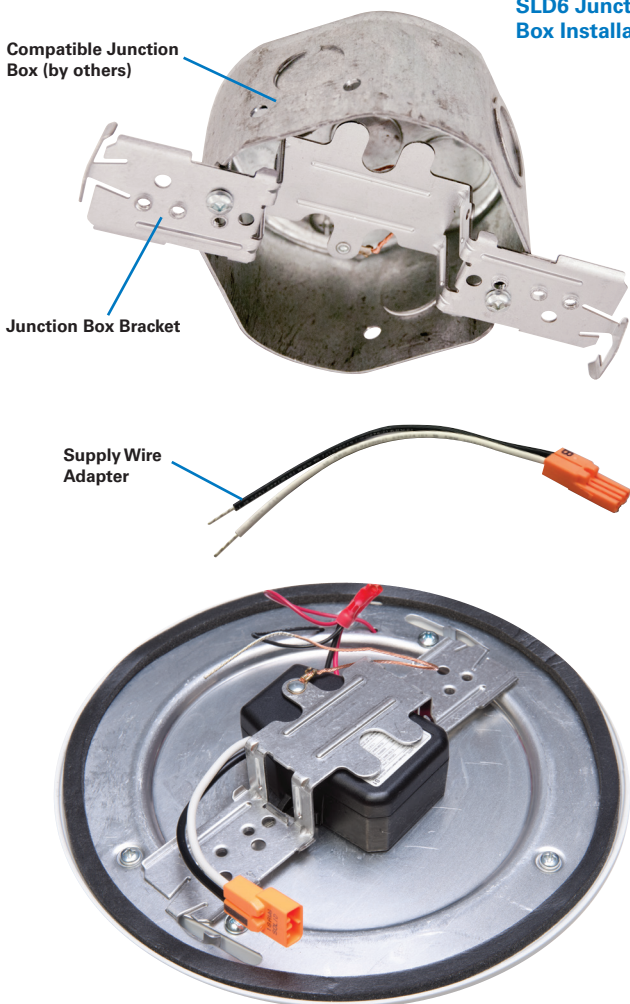

SLD6 with junction box bracket installed.

### Junction Box Mounting Summary

1. Install junction box bracket.
2. Unplug supply wire adapter from SLD. Connect black and white wires from the supply wire adapter to house wiring (black to black and white to white).
3. Locate the supply wire adapter behind the junction box bracket.
4. Plug matching orange LED connector from supply wire adapter to SLD.
5. Align two bracket tabs with slots on back of SLD fixture.
6. Turn clockwise to lock in place.

Note that this is only a summary. Read and follow the instructions included with the product for full details.

Compatible Junction  
Box (by others)

## SLD4 Junction Box Installation

Junction Box Bracket

Supply Wire  
Adapter

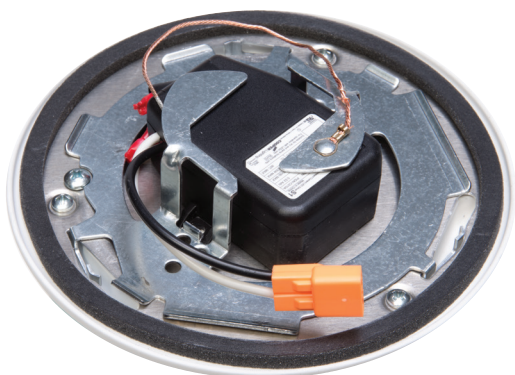







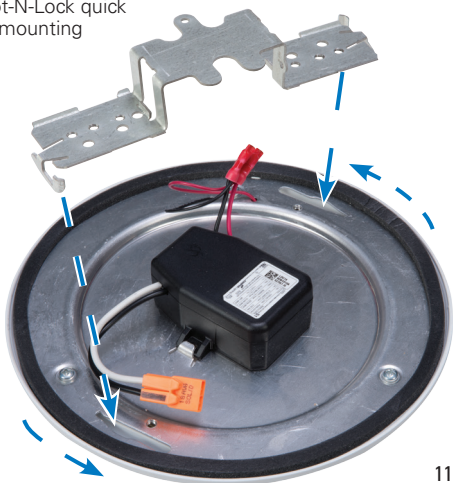

SLD4 with junction box bracket installed.

## Slot-N-Lock™

Halo SLD proprietary Slot-N-Lock quick  
installation system with mounting  
bracket.

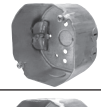

# Compatible Junction Boxes\*

		SLD4	SLD6	SLD4RAD adapter	SLD6RAD adapter
	<b>Octagon - steel light fixture / fan box</b>				
	4" x 4" x 2-1/8"	✓	✓	✓	✓
	4" x 4" x 1-1/2"	✓	✓	✓	✓
	<b>Square - steel deep box</b>				
	4" x 4" x 2-1/8"		✓		✓
	4" x 4" x 1-1/2"		✓		✓
	<b>Round - new work fixture box (plastic)</b>				
	4" diameter x 2-3/16"	✓	✓	✓	✓
	3-1/2" diameter x 2-3/4"	✓	✓	✓	
	<b>Round - old work fixture box (plastic)</b>				
	4-1/4" flange x 2-5/8", 3-1/2" I.D.	✓	✓	✓	
	<b>Round - new work fixture box (plastic) with bar hanger</b>				
	4" diameter x 2-3/16"	✓	✓	✓	✓
	<b>Round surface mount</b>				
	4" diameter x 1-1/2"	△	△	✓	✓
	<b>TP316 - Eaton's Crouse-Hinds junction box for non-metallic cable</b>				
	4" x 4" x 2-1/8"	✓	✓		
	<b>TP317 - Eaton's Crouse-Hinds junction box for metal clad cable</b>				
	4" x 4" x 2-1/8"	△	△		

△ when used with SLD4RAD (SLD4) or SLD6RAD (SLD6)

\*This is a representative list of compatible junction boxes only. Information contained in this literature about other manufacturers' products is from published information made available by the manufacturer and is deemed to be reliable, but has not been verified. Eaton makes no specific recommendation on product selection and there are no warranties of performance or compatibility implied. Installer must determine that site conditions are suitable to allow proper installation of the SLD mounting bracket in the box.

# Recessed Housing Mounting

## Retrofits 4", 5", or 6" recessed housings.

1. Install screwbase adapter to fixture socket. (LED housings skip Step 1)
2. Attach torsion springs or friction clips to SLD following the instructions included with the SLD.
3. Install SLD into recessed can.

Note that this is only a summary. Read the instructions included with the product for full details.

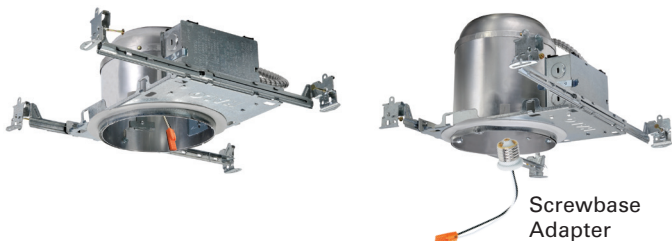

## SLD4 Series Friction Clip Installation

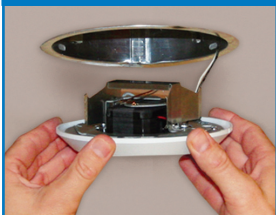

4-inch friction clip

## SLD6 Series Friction Clip Installation



6-inch friction clip position



5-inch friction clip position

## SLD6 Series Torsion Spring Installation

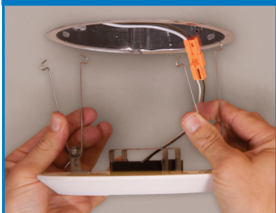

6-inch torsion spring position



5-inch torsion spring position

# Ordering Information

## 4" SLD4

Sample Number: **SLD405927WH + SLD4TRMSN**

**Junction Box Installation:** Order junction box separately, as supplied by others, to complete installation.

**Recessed Installation:** Order Halo recessed housing separately to complete installation.

Standard Models	Color Rendering Index (CRI)	Color Temperature (CCT)	Finish
SLD405= 4" Surface LED Downlight, 120V with recessed retrofit and junction box hardware kits	8= 80 CRI	27= 2700K	WH= White
	9= 90 CRI	30= 3000K	
		35= 3500K	
		40= 4000K	

"JB" Models	Color Rendering Index (CRI)	Color Temperature (CCT)	Finish	JB
SLD405= 4" Surface LED Downlight, 120V with junction box hardware kit only	8= 80 CRI	27= 2700K	WH= White	JB= Junction Box Kit
	9= 90 CRI	30= 3000K		
		35= 3500K		
		40= 4000K		

### Accessories (Order Separately)

**Designer Trims:** fit over the SLD4 for a designer finish, 6" O.D.

**SLD4TRMSN**= 4" SLD Satin Nickel Trim Ring

**SLD4TRMTBZ**= 4" SLD Tuscan Bronze Trim Ring

**SLD4TRMWH**= 4" SLD White Paintable Trim Ring

**J-box Spacer Extension Ring:** add 15/16" depth when SLD driver cannot fit into installed junction box, 7.75" O.D.

**SLD4EXT**= 4" Surface LED J-box Extender

**RAD Adapters:** when junction box is mounted flat on a ceiling or beam surface

**SLD4RAD**= 4" SLD Round Surface J-box Adapter (compatible with 4" round and octagon junction boxes)

**Spare Parts**

**SLD4ACCKIT**= 4" Accessory Parts Replacement Kit (screwbase adapter, and friction blades)

**SLD4BRKT**= 4" Junction Box Bracket and Screws





## 6" SLD6 - 600 Series

Sample Number: **SLD606927WH + SLD6TRMSN**

**Junction Box Installation:** Order junction box separately, as supplied by others, to complete installation.

**Recessed Installation:** Order Halo recessed housing separately to complete installation.

Models	Color Rendering Index (CRI)	Color Temperature (CCT)	Finish
<b>SLD606</b> = 6" Surface LED Downlight, 120V, 600 Series with recessed retrofit and junction box hardware kits	<b>8</b> = 80 CRI	<b>27</b> = 2700K	<b>WH</b> = White
	<b>9</b> = 90 CRI	<b>30</b> = 3000K	
		<b>35</b> = 3500K	
		<b>40</b> = 4000K	

"JB" Models	Color Rendering Index (CRI)	Color Temperature (CCT)	Finish	JB
<b>SLD606</b> = 6" Surface LED Downlight, 120V, 600 Series with junction box hardware kit only	<b>8</b> = 80 CRI	<b>27</b> = 2700K	<b>WH</b> = White	<b>JB</b> = Junction Box Kit
	<b>9</b> = 90 CRI	<b>30</b> = 3000K		
		<b>35</b> = 3500K		
		<b>40</b> = 4000K		

### Accessories (Order Separately)

Designer Trims: fit over the SLD6 for a designer finish, 7.79" O.D.

**SLD6TRMSN**= 6" SLD Satin Nickel Trim Ring

**SLD6TRMTBZ**= 6" SLD Tuscan Bronze Trim Ring

**SLD6TRMWH**= 6" SLD White Paintable Trim Ring

J-box Spacer Extension Ring: add 15/16" depth when SLD driver cannot fit into installed junction box, 9.5" O.D.

**SLD6EXT**= 6" Surface LED J-box Extender

RAD Adapters: when junction box is mounted flat on a ceiling or beam surface

**SLD6RAD**= 6" SLD Round Surface J-box Adapter (compatible with 4" round, octagon, and square junction boxes)

**SLD6SADPLT**= 6" SLD Square Surface J-box Adapter Plate (use with SLD6RAD)

Spare Parts

**SLD6ACCKIT**= 6" Accessory Parts Replacement Kit (screwbase adapter, torsion springs, friction blades)

**SLD6BRKT**= 6" Junction Box Bracket and Screws





# Ordering Information

## 6" SLD6 - 1200 Series

Sample Number: **SLD612927WH + SLD6TRMSN**

**Junction Box Installation:** Order junction box separately, as supplied by others, to complete installation.

**Recessed Installation:** Order Halo recessed housing separately to complete installation.

<b>Models</b>	<b>Color Rendering Index (CRI)</b>	<b>Color Temperature (CCT)</b>	<b>Finish</b>
<b>SLD612</b> = 6" Surface LED Downlight, 120V, 1200 Series with recessed retrofit and junction box hardware kits	<b>8</b> = 80 CRI <b>9</b> = 90 CRI	<b>27</b> = 2700K <b>30</b> = 3000K <b>35</b> = 3500K <b>40</b> = 4000K	<b>WH</b> = White

### Accessories (Order Separately)

Designer Trims: fit over the SLD6 for a designer finish, 7.79" O.D.

**SLD6TRMSN**= 6" SLD Satin Nickel Trim Ring

**SLD6TRMTBZ**= 6" SLD Tuscan Bronze Trim Ring

**SLD6TRMWH**= 6" SLD White Paintable Trim Ring

J-box Spacer Extension Ring: add 15/16" depth when SLD driver cannot fit into installed junction box, 9.5" O.D.

**SLD6EXT**= 6" Surface LED J-box Extender

RAD Adapters: when junction box is mounted flat on a ceiling or beam surface

**SLD6RAD**= 6" SLD Round Surface J-box Adapter (compatible with 4" round, octagon, and square junction boxes)

**SLD6SADPLT**= 6" SLD Square Surface J-box Adapter Plate (use with SLD6RAD)

Spare Parts

**SLD6ACCKIT**= 6" Accessory Parts Replacement Kit (screwbase adapter, torsion springs, friction blades)

**SLD6BRKT**= 6" Junction Box Bracket and Screws

# Housing Compatibility

## 4" Housings - Halo and All-Pro UL Listed Compatibility

### Recessed Can Size    Catalog Number

Compatible Halo LED Housings with LED Luminaire High-efficacy Compliant Connector (Meets CA Title 24 requirements)

**4"**

H995ICAT, H995RICAT

Compatible Halo Incandescent E26 Screwbase Housings

**4"**

H99ICAT, H99TAT, H99RTAT

Compatible All-Pro Incandescent E26 Screwbase Housings

**4"**

EI400ATSB, ET400ATSB, ET400RATSB

## 6" Housings - Halo and All-Pro UL Listed Compatibility

### Recessed Can Size    Catalog Number

Compatible Halo LED Housings with LED Luminaire High-efficacy Compliant Connector (Meets CA Title 24 requirements)

**5"**

H550ICAT, H550RICAT

**6"**

H750ICAT, H750RICAT, H750T, H750RINTD010, H750TCP, H2750ICAT

Halo LED Retrofit Enclosures

**6"**

ML7BXRFK, ML7E26RFK

Compatible Halo Incandescent E26 Screwbase Housings

**5"**

H5ICAT, H5RICAT, H5T, H5RT, H5TM, H25ICAT

**6"**

H7ICAT, H7RICAT, H7ICT, H7RICT, H7ICATNB, H7ICTNB, H7T, H7RT, H7TNB, H7TCP, H7UICAT, H7UICAT, H27ICAT, H27RICAT, H27ICT, H27RICT, H27T, H27RT

Compatible All-Pro Incandescent E26 Screwbase Housings

**5"**

EI500AT, EI500RAT, ET500, ET500R

**6"**

EI700AT, EI700RAT, EI700, EI700R, EI700ATNB, EI700NB, EI700U, EI700UAT, ET700, ET700R, EI2700AT, EI2700, EI2700R, ET2700, ET2700R

The SLD Series surface LED downlight luminaire is cULus Listed or UL Classified for use with any 4" (SLD4) or 5"/6" (SLD6) diameter recessed housings constructed of steel or aluminum with an internal volume that exceeds 62.3 in<sup>3</sup> (SLD4) or 107.9 in<sup>3</sup> (SLD6) in addition to those noted above.

# Replacement Parts Kits



## **SLD4ACCKIT**

SLD4 Retrofit Kit

SLD4 screwbase adapter, friction blades, ground wire, mounting screws, wire nuts

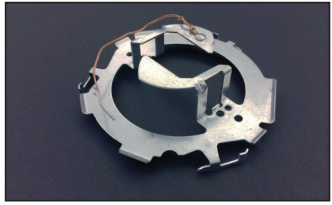

## **SLD4BRKT**

SLD4 Junction box mounting bracket and mounting screws

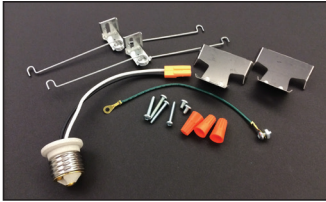

## **SLD6ACCKIT**

SLD6 Retrofit Kit

SLD6 screwbase adapter, friction blades, torsion springs, ground wire, mounting screws, wire nuts

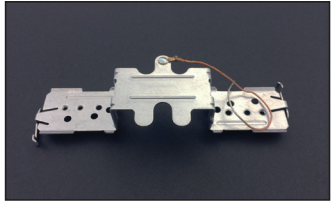

## **SLD6BRKT**

SLD6 Junction box mounting bracket and mounting screws



# Lighting Control Solutions



Powering Business Worldwide

Eaton dimmers offer versatile options to set the mood and reduce energy consumption. These compatible LED dimmers are ideal for both residential and light commercial applications and are compatible with decorator (screwless) style devices and wallplates.

Refer to [www.eaton.com](http://www.eaton.com) for additional information.



Dimmer Features	Smart (AAL06P)	Decorator (DAL06P)
<b>Rapid Start feature</b>	Selectable ON or OFF	Fully adjustable
<b>Adjustable high-end trim</b>	•	
<b>Adjustable low-end trim</b>	•	•
<b>Wiring configurations</b>	Single-pole or multi-location	Single-pole or three-way
<b>Color change kits</b>	•	•



Dimmer Features	Slide (SAL06P)	Toggle (TAL06P)
<b>Rapid Start feature</b>	Fixed ON	Fully adjustable
<b>Adjustable high-end trim</b>		
<b>Adjustable low-end trim</b>	•	•
<b>Wiring configurations</b>	Single-pole or three-way	Single-pole or three-way
<b>Color change kits</b>		•

**Note:** The Rapid Start feature is used to ensure the right amount of power boost during start-up. When a dimmer with Rapid Start is turned on from a low dimmer setting, the LED lighting may exhibit a momentary flash. Designated dimmer models offer an adjustment of the Rapid Start feature. The user may wish to adjust this setting to reduce the boost and resulting momentary flash. If this capability is desired, the user should select dimmer models noted as "fully adjustable" or "selectable ON or OFF".

# Product and Photometric Data

- Downlight cone-of-light distribution
- Maximum spacing criteria
- Optimized design for general downlighting
- Exceeds 83% of light between 0-60° cone-of-light zone
- ENERGY STAR® and California Title 24 - zonal and efficacy requirements

## SLD4

Cat No.	CRI	CCT	Lumens	Power (W)	LPW
SLD405827WH (JB)	80	2700	720	12.2	59
SLD405830WH (JB)	80	3000	750	12.2	61
SLD405835WH (JB)	80	3500	780	12.2	64
SLD405840WH (JB)	80	4000	800	12.2	66
SLD405927WH (JB)	90	2700	650	12	54
SLD405930WH (JB)	90	3000	670	12	56
SLD405935WH (JB)	90	3500	690	12	58
SLD405940WH (JB)	90	4000	710	12	59

SLD405830WH		
Luminaire lumens		750
Input watts		12.2
LER (LPW)		61
Spacing Criteria	0-180	1.4
	90-270	1.4
	Diagonal	1.5
Beam angle (degrees)		107
Field angle (degrees)		159
Zonal lumen	Lumens	% Lumens
0-30	212	28%
0-40	357	48%
0-60	623	83%
0-90	750	100%

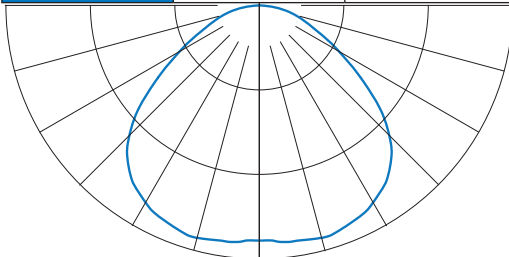



## SLD6 - 600 Series

Cat No.	CRI	CCT	Lumens	Power (W)	LPW
SLD606827WH (JB)	80	2700	727	12.2	60
SLD606830WH (JB)	80	3000	760	12.2	62
SLD606835WH (JB)	80	3500	780	12.2	64
SLD606840WH (JB)	80	4000	800	12.2	66
SLD606927WH (JB)	90	2700	710	13.2	54
SLD606930WH (JB)	90	3000	735	13.2	56
SLD606935WH (JB)	90	3500	760	13.2	58
SLD606940WH (JB)	90	4000	780	13.2	59

SLD606830WH		
Luminaire lumens		760
Input watts		12.2
LER (LPW)		62
Spacing Criteria	0-180	1.5
	90-270	1.5
	Diagonal	1.5
Beam angle (degrees)		103
Field angle (degrees)		159
Zonal lumen	Lumens	% Lumens
0-30	215	28%
0-40	364	48%
0-60	631	83%
0-90	760	100%

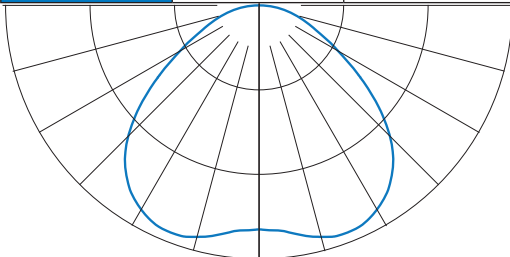

# Product and Photometric Data

## SLD6 - 1200 Series

Cat No.	CRI	CCT	Lumens	Power (W)	LPW
SLD612827WH	80	2700	1100	14.8	74
SLD612830WH	80	3000	1150	14.8	78
SLD612835WH	80	3500	1200	14.8	81
SLD612840WH	80	4000	1215	14.8	82
SLD612927WH	90	2700	880	14.8	59
SLD612930WH	90	3000	925	14.8	63
SLD612935WH	90	3500	965	14.8	65
SLD612940WH	90	4000	1000	14.8	68

SLD612830WH		
Luminaire lumens		1150
Input watts		14.8
LER (LPW)		78
Spacing Criteria	0-180	1.4
	90-270	1.4
	Diagonal	1.5
Beam angle (degrees)		107
Field angle (degrees)		159
Zonal lumen	Lumens	% Lumens
0-30	320	28%
0-40	541	47%
0-60	952	83%
0-90	1150	100%

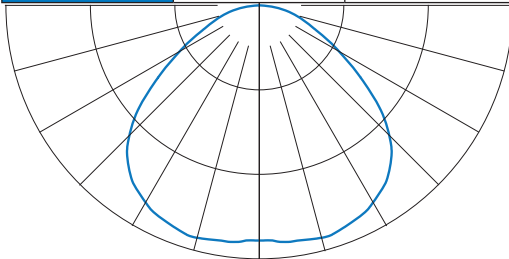





## Eaton

1121 Highway 74 South  
Peachtree City, GA 30269  
P: 770-486-4800  
[www.eaton.com/lighting](http://www.eaton.com/lighting)

Canada Sales  
5925 McLaughlin Road  
Mississauga, Ontario L5R 1B8  
P: 905-501-3000  
F: 905-501-3172

### Our Lighting Product Lines

Halo  
Halo Commercial  
Portfolio  
IRiS  
RSA  
Metalux  
Corelite  
Neo-Ray  
Fail-Safe  
MWS  
Ametrix  
Shaper  
io  
Lumark  
McGraw-Edison  
Invue  
Lumière  
Streetworks  
AtLite  
Sure-Lites

### Our Controls Product Lines

Greengate  
iLumin  
Zero 88  
Fifth Light Technology  
iLight (International Only)

#### Eaton

1121 Highway 74 South  
Peachtree City, GA 30269  
P: 770-486-4800  
[www.eaton.com/lighting](http://www.eaton.com/lighting)

© 2015 Eaton  
All Rights Reserved  
Printed in USA  
Publication No. BR518010EN  
July 2015

Products, specifications and  
compliances are subject to  
change without notice.

Eaton is a registered trademark.

All other trademarks are property  
of their respective owners.



*Powering Business Worldwide*