

7P Cable-Gard™ Static Discharge Reels

Applications:

Static discharge reels are used for grounding portable machines and equipment in hazardous areas, such as fuel transfer trucks, grain elevators, dockside loading facilities and barges. When properly clamped to ground the static discharge reel safely dissipates static electrical build-up and reduces the chance of sparking and the potential for explosion.

Features:

- Automatic rewinding
- Rugged steel construction
- Compact enclosed design
- Positive ratchet lock
- Lock on/lock off switch
- Steel cable installed
- 100 amp universal jaw-type grounding clamp
- Safety orange polyester baked-on finish

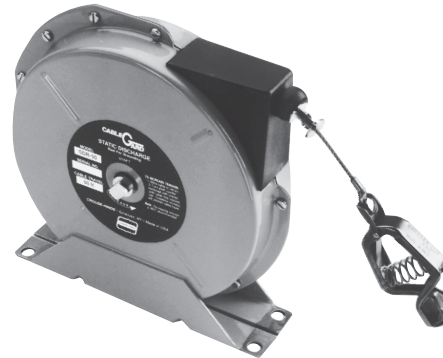

SDR-50

Standard Materials:

- Housing – steel construction

Standard Finishes:

- Housing – orange polyester; baked on finish

Ordering Information:

Cable Length (Feet)	Description	Weight Complete		Cat. #
		lbs.	(Kg)	
50	Single 7 × 30 steel*	12	(5.4)	SDR 50
50	35' plus 2 × 15' for Y (steel*)	13	(5.9)	SDR 50Y
50	Nylon covered cable*	12	(5.4)	SDR 50N

*Static discharge reels are supplied complete with 3/32" steel aircraft cable. DC resistance is approximately one ohm per 50 ft. of steel cable.

Dimensions

In Inches:

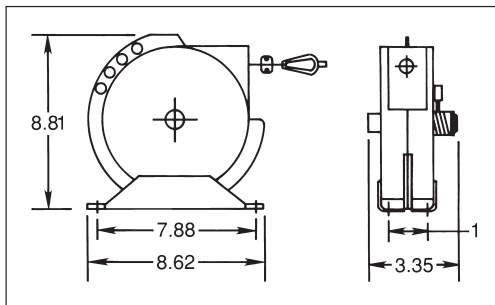

7P

Applications:

Cable-Gard cable reels are designed for the constant, predictable pull of a machine and are designed for reliable operation in many applications. Typical uses include travelling cars, mobile hoists and various objects being lifted under power such as lifting magnets on cranes.

Features:

- Unitized slip ring assembly transfers current from stationary to rotary. Brushes are an integral part of the slip ring assembly.
- Safe to change spring motor that is sized per application, clock type spring with window shade type action. Sealed in disposable housing, spring is never exposed to unravel and possibly harm.
- Watertight cable entrance terminates cord to reel spool with positive grip, watertight seal.
- Large junction box with 3/4" NPT conduit entrance may be positioned in choice of four directions.
- Multi-position roller guide is adjustable to 4 different positions. Allows easy adaptation of reel to positioning requirements of the application and controlled uniform retraction of cable onto spool. Roller guides are optional; consult factory.
- Baked-on powder epoxy finish provides tightly bonded, homogenous shield to abrasion and corrosion.
- Ratchet lock is provided for window shade type action. May be easily disengaged in field for constant tension applications.

Certifications and Compliances:

- ANSI/UL 355
- CSA C22.2
- NEMA 3, 3R

Standard Materials:

- Frame, spool – steel

Standard Finishes:

- Baked on powder epoxy – orange

Options:

- Description** **Suffix**
- Ball stop – keeps cable from rewinding out of reach in hand-pull applications.

Cable Range O.D. Min./Max.	Suffix
.38 – .50	C1
.50 – .75	C2
.75 – 1.00	C3

Ball stop may be ordered separately; use suffix number as catalog number.

- Pivot base – Pivot base allows 340° rotation of reel. Required for applications demanding reel self-alignment to direction of the cable run.

To order separately:

Series	Pivot Base Cat. #
W14	PB14
W16	PB16
W19	PB19

- Reel supplied less cable..... NS



Electrical Ranges:

- 600 VAC (cable reel)
- Cord: #16 – #10, Type "SO", #8, Type "W", or Type "G" (see listings).

Dimensions In Inches:

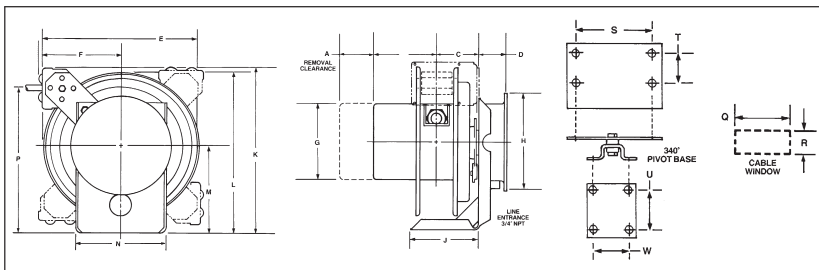

Frame

Size	C	D	E	F	G	H	J	K	L	M	N	P	Q	R
W14	3.75	2.75	13.75	8.25	7.00	9.25	6.12	16.25	15.00	8.12	8.00	14.25	2.50	1.25
W16	5.50	2.75	15.75	9.31	7.00	9.25	7.94	18.25	17.00	9.12	8.50	16.25	3.00	1.25
W19	5.75	2.75	19.00	10.00	10.50	9.25	7.00	20.50	20.25	10.75	11.00	18.50	3.50	1.25

Slip Ring Housing Dimensions:

Poles/Amps	W14		W16		W19		A	B
	A	B	A	B	A	B		
1-4; 30 Amps	4.50	5.69	1-4; 30 Amps	4.50	5.94	1-4; 30 Amps	3.25	5.44
5-8; 30 Amps	6.00	7.19	5-8; 30 Amps	6.00	7.44	5-8; 30 Amps	4.50	6.69
9-12; 30 Amps	7.50	8.69	9-12; 30 Amps	7.50	8.94	9-12; 30 Amps	6.00	8.19
1-4; 55 Amps	6.00	7.19	1-4; 54 Amps	6.00	7.44	1-4; 55 Amps	4.50	6.69

Catalog Numbering System:

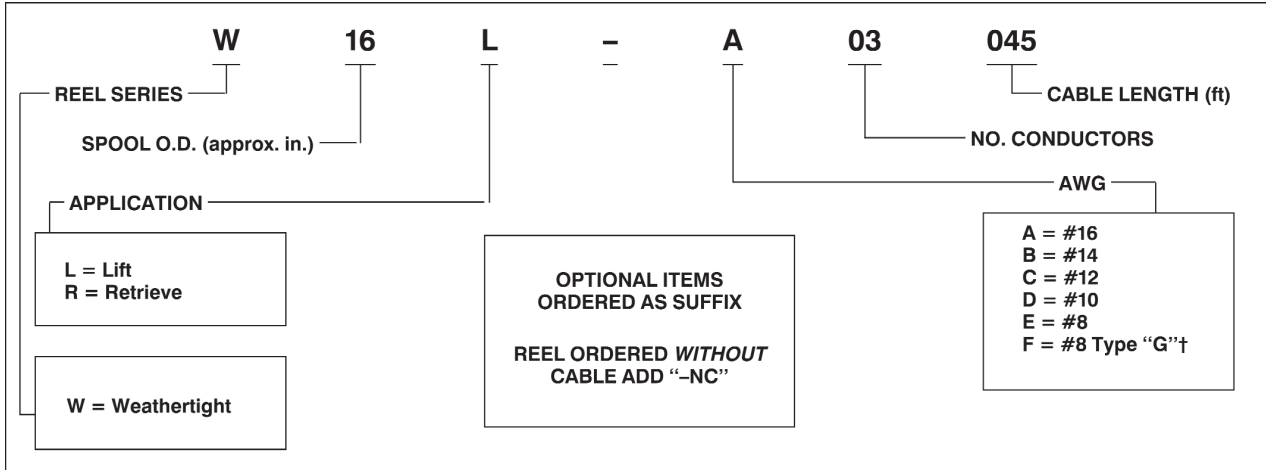

† Type “G” cable is supplied with a ground conductor.

Reel Selection Process:

Determine:

- 1. Cable Size and No. of Conductors**
Be sure to choose cable that will adequately handle the current load (include ground when stating number of conductors). If the desired cable is not listed, consult factory.
- 2. Cable Length**
Reels in this brochure will handle up to 150 feet of cable. Decide how far your equipment will travel from the reel and choose the appropriate column. The amount of cable needed to install the cable on the reel has been included. However, you must add:
1) the amount of cable needed for Hook-Up to your equipment, and
2) Cable Sag Allowance if “Stretch” applications (see footnote*). Round up to the nearest footage on the selection chart.
Cable Length Needed = Equipment Travel Distance Plus Hook-Up Plus Sag Allowance. (Sag allowance needed for “stretch” applications only.)
- 3. Type Of Cable**
This is important as stranding and construction vary. Cable-Gard reels are provided with cable as listed in the electrical ranges listed on previous page.
- 4. Application**

Retrieving, Horizontal

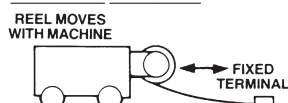

A horizontal retrieve application is identified when the reel is mounted on the moving equipment. The reel pays out and picks up the cable from a tray or other support.

Retrieving, Vertical

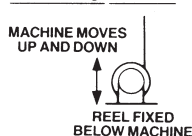

This application requires the reel to wind and unwind the cable but not lift or support the cable. A typical example is where the reel is mounted to the ground and the cable is attached to an elevating machine. In some cases the cable is anchored above and the reel rides up and down on an elevating machine.

Lifting, Vertical

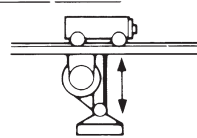

Any application where cable is simply hoisted vertically with the reel lifting only the weight of the cable. Special considerations must be given to any weight added to the end of the cable such as a push-button station. Listed spring tension is not designed to accommodate added weight. Consult the manufacturer for a specific recommendation.

Stretching*, Horizontal

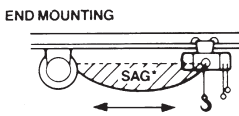

In addition to being capable of lifting cables vertically, all reels listed will stretch cables horizontally as shown. When stretching horizontally (unsupported, except at the reel and the moving current consumer) the sag or droop of the cable may be important. Spring tension on these reels is designed to provide for 8 - 10% sag at the midpoint of travel when fully extended. Stronger tension could be a problem for light, free moving loads which tend to be pulled toward the reel. The cable weight alone can pull a light load.

CENTER MOUNTING (Remove Cable Guide)

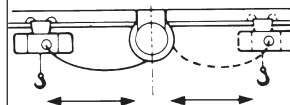

CENTER MOUNTING (cable guide is removed) can save over the cost of end mounting. For example, a machine traveling 50 ft. can be serviced by a center-mounted reel equipped with 25 ft. of cable. A comparable end-mounted reel would require the full 50 ft. of cable.

Dragging Cable

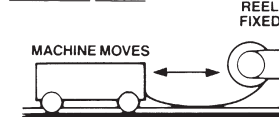

Drag applications refer to a reel mounted in a fixed (non-moving) position and the cable terminated on a moving machine. As the machine moves, the cable is pulled off of the reel and “dragged” over the surface. This is **NOT** a recommended application because of abuse to the cable resulting in shortened life.

*Sag allowance must be considered when figuring cable length for STRETCH applications. Add 1 ft. of cable for each 50 ft. of working cable calculated for your application. (Working cable excludes hook-up length.)

Reels for Lifting/Stretching:

EXAMPLES:

A hoist is to travel 52 feet along an I-beam – this is a Stretch application. Required cable is 4 Conductor/No. 14. Hook-up is 2 feet.

The following EXAMPLES appear in bold type in the selection charts.

1. If the reel must be END MOUNTED, the required cable length would be 52 feet, plus 2 feet for the hook-up plus 2 feet for sag consideration*. Round up to 60 feet per the available footage in the chart below. The correct model to choose would be **W16L-B04060**.

2. If the reel may be CENTER MOUNTED, only half as much cable is required – it will be used in both directions. Half of the required length would be 26 feet, plus 2 feet for the hook-up plus 1 foot for sag consideration for a total of 29 feet. Round up to 30 feet and choose model **W14L-B04030**. A savings will be realized because less cable was used and, thus, a smaller reel was required.

Selection Chart:

Wire Size	No. of Cond.	20 Feet	30 Feet	40 Feet	50 Feet	60 Feet	70 Feet
16	3	W14L A03020	W14L A03030	W14L A03040	W16L A03050	W16L A03060	W19L A03070
	4	W14L A04020	W14L A04030	W14L A04040	W16L A04050	W16L A04060	W19L A04070
	6	W14L A06020	W14L A06030	W14L A06040	W14L A06050	W16L A06060	W19L A06070
	8	W16L A08020	W16L A08030	W16L A08040	W16L A08050	W16L A08060	W19L A08070
	10	W16L A10020	W16L A10030	W16L A10040	W16L A10050	W19L A10060	W19L A10070
	12	W16L A12020	W16L A12030	W16L A12040	W16L A12050	W19L A12060	W19L A12070
14	3	W14L B03020	W14L B03030	W14L B03040	W14L B03050	W16L B03060	W16L B03070
	4	W14L B04020	W14L B04030	W14L B04040	W14L B04050	W16L B04060	W16L B04070
	6	W14L B06020	W14L B06030	W16L B06040	W16L B06050	W16L B06060	W19L B06070
	8	W14L B08020	W16L B08030	W16L B08040	W16L B08050	W19L B08060	W19L B08070
	10	W14L B10020	W16L B10030	W19L B10040			
	12	W16L B12020	W16L B12030	W19L B12040			
12	3	W14L C03020	W14L C03030	W14L C03040	W14L C03050	W16L C03060	W19L C03070
	4	W14L C04020	W14L C04030	W14L C04040	W16L C04050	W16L C04060	W19L C04070
	6	W14L C06020	W16L C06030	W16L C06040	W19L C06050	W19L C06060	
	8	W14L C08020	W16L C08030	W19L C08040			
10	3	W14L D03020	W14L D03030	W14L D03040	W16L D03050	W16L D03060	W19L D03070
	4	W14L D04020	W14L D04030	W16L D04040	W16L D04050	W19L D04060	W19L D04070
	6	W16L D06020					
8	2	W14L E02020	W16L E02030	W16L E02040	W19L E02050		
	3	W16L E03020	W16L E03030	W19L E03040			
	3†	W14L F03020	W16L F03030	W19L F03040			
	4	W16L E04020	W16L E04030	W19L E04040			

*Sag allowance must be considered when figuring cable length for Stretch applications. Add 1 foot of cable for each 50 feet of working cable calculated for your application. (Working cable excludes hook-up length.)

†Type "G" cable.

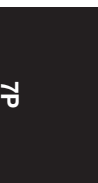

7P Retrieve Reels

Reels for Retrieving:

EXAMPLES:

A moving car is to travel 55 feet. Required cable is 4 Conductor/No. 10. Extra cables needed to hook up to the car is 2 feet. The following EXAMPLES appear in bold type in the selection charts.

1. If the reel must be END MOUNTED, the required cable length would be 55 feet, plus 2 feet for the hook-up. Round up to 60 feet per the available footage in the chart below. The correct model to choose would be **W19R-D04060**.

2. If the reel may be CENTER MOUNTED, only half as much cable is required – it will be used in both directions. Half of the required length would be 27.5 feet, plus 2 feet for the hook-up for a total of 29.5 feet. Round up to 30 feet and choose model **W14R-D04030**. A savings will be realized because less cable was used and, thus, a smaller reel was required.

Selection Chart:

Wire Size	No. of Cond.	20 Feet	30 Feet	40 Feet	50 Feet	60 Feet	70 Feet
16	3	W14R A03020	W14R A03030	W14R A03040	W16R A03050	W16R A03060	W19R A03070
	4	W14R A04020	W14R A04030	W14R A04040	W16R A04050	W16R A04060	W19R A04070
	6	W14R A06020	W14R A06030	W14R A06040	W14R A06050	W16R A06060	W19R A06070
	8	W14R A08020	W14R A08030	W16R A08040	W16R A08050	W16R A08060	W19R A08070
	10	W14R A10020	W14R A10030	W16R A10040	W16R A10050	W19R A10060	W19R A10070
	12	W14R A12020	W14R A12030	W16R A12040	W16R A12050	W19R A12060	W19R A12070
14	3	W14R B03020	W14R B03030	W14R B03040	W14R B03050	W16R B03060	W19R B03070
	4	W14R B04020	W14R B04030	W14R B04040	W14R B04050	W16R B04060	W19R B04070
	6	W14R B06020	W14R B06030	W16R B06040	W16R B06050	W16R B06060	W19R B06070
	8	W14R B08020	W16R B08030	W16R B08040	W19R B08050	W19R B08060	W19R B08070
	10	W14R B10020	W16R B10030	W19R B10040			
	12	W16R B12020	W16R B12030	W19R B12040			
12	3	W14R C03020	W14R C03030	W14R C03040	W14R C03050	W16R C03060	W16R C03070
	4	W14R C04020	W14R C04030	W14R C04040	W16R C04050	W16R C04060	W19R C04070
	6	W14R C06020	W16R C06030	W16R C06040	W19R C06050	W19R C06060	W19R 06070
	8	W14R C08020	W16R C08030	W19R C08040			
	10						
	12						
10	3	W14R D03020	W14R D03030	W14R D03040	W16R D03050	W16R D03060	W16R D03070
	4	W14R D04020	W14R D04030	W16R D04040	W16R D04050	W19R D04060	W19R D04070
	6	W14R D06020	W19R D06030	W19R D06040			
	8	W19R D08020	W19R D08030				
8	2	W14R E02020	W16R E02030	W16R E02040	W19R E02050	W20AR E02060	
	3	W14R E03020	W16R E03030	W19R E03040			
	3†	W14R F03020	W16R F03030	W19R F03040			
	4	W16R E04020	W16R E04030	W19R E04040			

†Type "G" cable.

7P Cable-Gard™ Static Discharge Reels

Applications:

Static discharge reels are used for grounding portable machines and equipment in hazardous areas, such as fuel transfer trucks, grain elevators, dockside loading facilities and barges. When properly clamped to ground the static discharge reel safely dissipates static electrical build-up and reduces the chance of sparking and the potential for explosion.

Features:

- Automatic rewinding
- Rugged steel construction
- Compact enclosed design
- Positive ratchet lock
- Lock on/lock off switch
- Steel cable installed
- 100 amp universal jaw-type grounding clamp
- Safety orange polyester baked-on finish

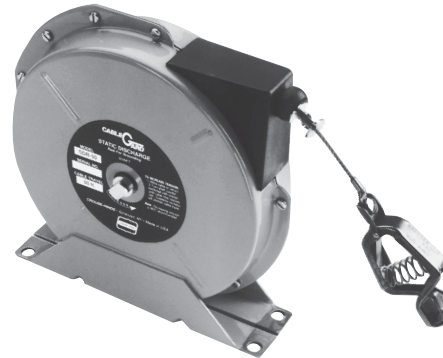

SDR-50

Standard Materials:

- Housing – steel construction

Standard Finishes:

- Housing – orange polyester; baked on finish

Ordering Information:

Cable Length (Feet)	Description	Weight Complete		Cat. #
		lbs.	(Kg)	
50	Single 7 × 30 steel*	12	(5.4)	SDR 50
50	35' plus 2 × 15' for Y (steel*)	13	(5.9)	SDR 50Y
50	Nylon covered cable*	12	(5.4)	SDR 50N

*Static discharge reels are supplied complete with 3/32" steel aircraft cable. DC resistance is approximately one ohm per 50 ft. of steel cable.

Dimensions

In Inches:

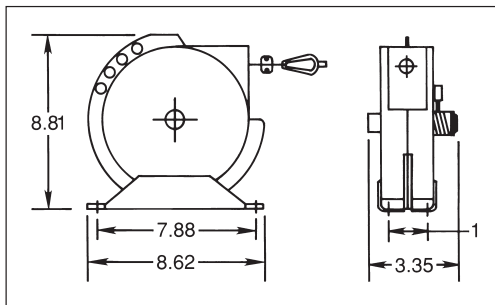

7P

Applications:

Cable-Gard cable reels are designed for the constant, predictable pull of a machine and are designed for reliable operation in many applications. Typical uses include travelling cars, mobile hoists and various objects being lifted under power such as lifting magnets on cranes.

Features:

- Unitized slip ring assembly transfers current from stationary to rotary. Brushes are an integral part of the slip ring assembly.
- Safe to change spring motor that is sized per application, clock type spring with window shade type action. Sealed in disposable housing, spring is never exposed to unravel and possibly harm.
- Watertight cable entrance terminates cord to reel spool with positive grip, watertight seal.
- Large junction box with 3/4" NPT conduit entrance may be positioned in choice of four directions.
- Multi-position roller guide is adjustable to 4 different positions. Allows easy adaptation of reel to positioning requirements of the application and controlled uniform retraction of cable onto spool. Roller guides are optional; consult factory.
- Baked-on powder epoxy finish provides tightly bonded, homogenous shield to abrasion and corrosion.
- Ratchet lock is provided for window shade type action. May be easily disengaged in field for constant tension applications.

Certifications and Compliances:

- ANSI/UL 355
- CSA C22.2
- NEMA 3, 3R

Standard Materials:

- Frame, spool – steel

Standard Finishes:

- Baked on powder epoxy – orange

Options:

- Description** **Suffix**
- Ball stop – keeps cable from rewinding out of reach in hand-pull applications.

Cable Range O.D. Min./Max.	Suffix
.38 – .50	C1
.50 – .75	C2
.75 – 1.00	C3

Ball stop may be ordered separately; use suffix number as catalog number.

- Pivot base – Pivot base allows 340° rotation of reel. Required for applications demanding reel self-alignment to direction of the cable run.

To order separately:

Series	Pivot Base Cat. #
W14	PB14
W16	PB16
W19	PB19

- Reel supplied less cable..... NS



Electrical Ranges:

- 600 VAC (cable reel)
- Cord: #16 – #10, Type "SO", #8, Type "W", or Type "G" (see listings).

Dimensions In Inches:

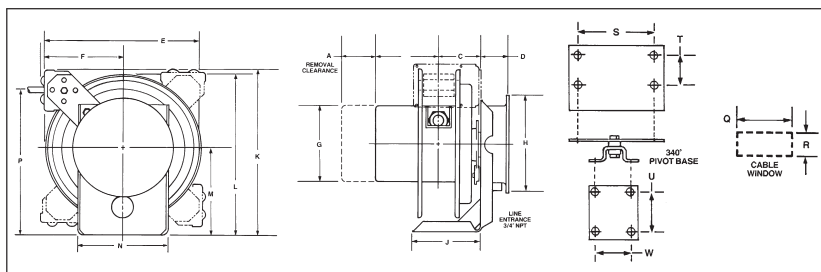

Frame

Size	C	D	E	F	G	H	J	K	L	M	N	P	Q	R
W14	3.75	2.75	13.75	8.25	7.00	9.25	6.12	16.25	15.00	8.12	8.00	14.25	2.50	1.25
W16	5.50	2.75	15.75	9.31	7.00	9.25	7.94	18.25	17.00	9.12	8.50	16.25	3.00	1.25
W19	5.75	2.75	19.00	10.00	10.50	9.25	7.00	20.50	20.25	10.75	11.00	18.50	3.50	1.25

Slip Ring Housing Dimensions:

Poles/Amps	W14		W16		W19			
	A	B	A	B	A	B	A	B
1-4; 30 Amps	4.50	5.69	4.50	5.94	4.50	5.94	3.25	5.44
5-8; 30 Amps	6.00	7.19	6.00	7.44	6.00	7.44	4.50	6.69
9-12; 30 Amps	7.50	8.69	7.50	8.94	7.50	8.94	6.00	8.19
1-4; 55 Amps	6.00	7.19	6.00	7.44	6.00	7.44	4.50	6.69

Catalog Numbering System:

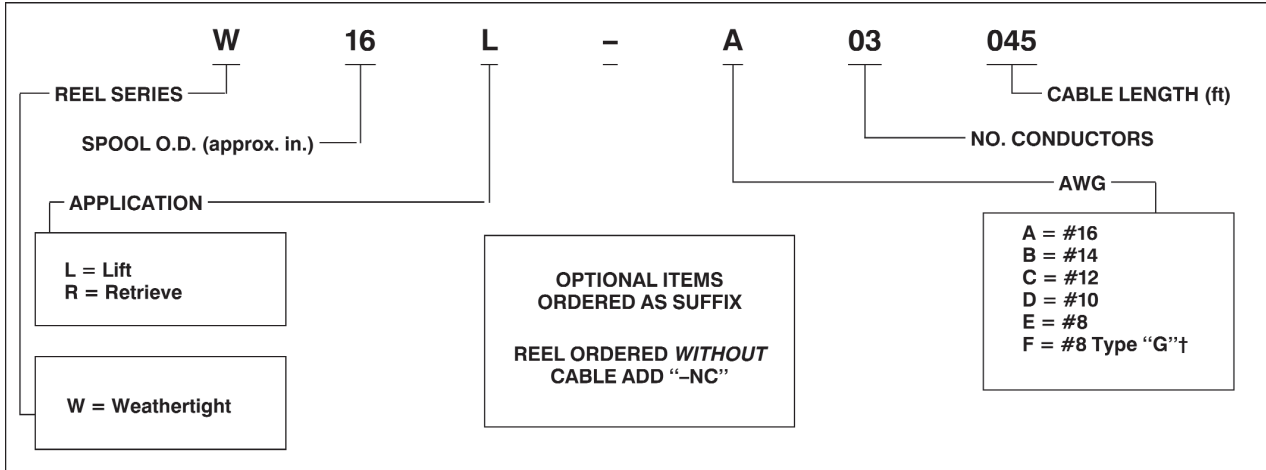

† Type “G” cable is supplied with a ground conductor.

Reel Selection Process:

Determine:

- 1. Cable Size and No. of Conductors**
Be sure to choose cable that will adequately handle the current load (include ground when stating number of conductors). If the desired cable is not listed, consult factory.
- 2. Cable Length**
Reels in this brochure will handle up to 150 feet of cable. Decide how far your equipment will travel from the reel and choose the appropriate column. The amount of cable needed to install the cable on the reel has been included. However, you must add:
1) the amount of cable needed for Hook-Up to your equipment, and
2) Cable Sag Allowance if “Stretch” applications (see footnote*). Round up to the nearest footage on the selection chart.
Cable Length Needed = Equipment Travel Distance Plus Hook-Up Plus Sag Allowance. (Sag allowance needed for “stretch” applications only.)
- 3. Type Of Cable**
This is important as stranding and construction vary. Cable-Gard reels are provided with cable as listed in the electrical ranges listed on previous page.
- 4. Application**

Retrieving, Horizontal

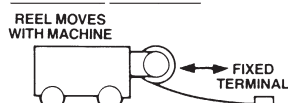

A horizontal retrieve application is identified when the reel is mounted on the moving equipment. The reel pays out and picks up the cable from a tray or other support.

Retrieving, Vertical

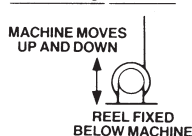

This application requires the reel to wind and unwind the cable but not lift or support the cable. A typical example is where the reel is mounted to the ground and the cable is attached to an elevating machine. In some cases the cable is anchored above and the reel rides up and down on an elevating machine.

Lifting, Vertical

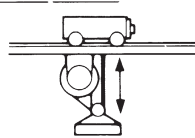

Any application where cable is simply hoisted vertically with the reel lifting only the weight of the cable. Special considerations must be given to any weight added to the end of the cable such as a push-button station. Listed spring tension is not designed to accommodate added weight. Consult the manufacturer for a specific recommendation.

Stretching*, Horizontal

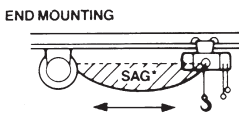

In addition to being capable of lifting cables vertically, all reels listed will stretch cables horizontally as shown. When stretching horizontally (unsupported, except at the reel and the moving current consumer) the sag or droop of the cable may be important. Spring tension on these reels is designed to provide for 8 - 10% sag at the midpoint of travel when fully extended. Stronger tension could be a problem for light, free moving loads which tend to be pulled toward the reel. The cable weight alone can pull a light load.

CENTER MOUNTING (Remove Cable Guide)

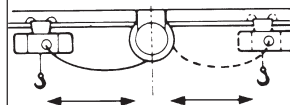

CENTER MOUNTING (cable guide is removed) can save over the cost of end mounting. For example, a machine traveling 50 ft. can be serviced by a center-mounted reel equipped with 25 ft. of cable. A comparable end-mounted reel would require the full 50 ft. of cable.

Dragging Cable

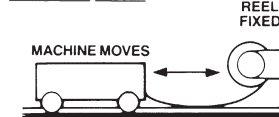

Drag applications refer to a reel mounted in a fixed (non-moving) position and the cable terminated on a moving machine. As the machine moves, the cable is pulled off of the reel and “dragged” over the surface. This is **NOT** a recommended application because of abuse to the cable resulting in shortened life.

*Sag allowance must be considered when figuring cable length for STRETCH applications. Add 1 ft. of cable for each 50 ft. of working cable calculated for your application. (Working cable excludes hook-up length.)

Reels for Lifting/Stretching:

EXAMPLES:

A hoist is to travel 52 feet along an I-beam – this is a Stretch application. Required cable is 4 Conductor/No. 14. Hook-up is 2 feet.

The following EXAMPLES appear in bold type in the selection charts.

1. If the reel must be END MOUNTED, the required cable length would be 52 feet, plus 2 feet for the hook-up plus 2 feet for sag consideration*. Round up to 60 feet per the available footage in the chart below. The correct model to choose would be **W16L-B04060**.

2. If the reel may be CENTER MOUNTED, only half as much cable is required – it will be used in both directions. Half of the required length would be 26 feet, plus 2 feet for the hook-up plus 1 foot for sag consideration for a total of 29 feet. Round up to 30 feet and choose model **W14L-B04030**. A savings will be realized because less cable was used and, thus, a smaller reel was required.

Selection Chart:

Wire Size	No. of Cond.	20 Feet	30 Feet	40 Feet	50 Feet	60 Feet	70 Feet
16	3	W14L A03020	W14L A03030	W14L A03040	W16L A03050	W16L A03060	W19L A03070
	4	W14L A04020	W14L A04030	W14L A04040	W16L A04050	W16L A04060	W19L A04070
	6	W14L A06020	W14L A06030	W14L A06040	W14L A06050	W16L A06060	W19L A06070
	8	W16L A08020	W16L A08030	W16L A08040	W16L A08050	W16L A08060	W19L A08070
	10	W16L A10020	W16L A10030	W16L A10040	W16L A10050	W19L A10060	W19L A10070
	12	W16L A12020	W16L A12030	W16L A12040	W16L A12050	W19L A12060	W19L A12070
14	3	W14L B03020	W14L B03030	W14L B03040	W14L B03050	W16L B03060	W16L B03070
	4	W14L B04020	W14L B04030	W14L B04040	W14L B04050	W16L B04060	W16L B04070
	6	W14L B06020	W14L B06030	W16L B06040	W16L B06050	W16L B06060	W19L B06070
	8	W14L B08020	W16L B08030	W16L B08040	W16L B08050	W19L B08060	W19L B08070
	10	W14L B10020	W16L B10030	W19L B10040			
	12	W16L B12020	W16L B12030	W19L B12040			
12	3	W14L C03020	W14L C03030	W14L C03040	W14L C03050	W16L C03060	W19L C03070
	4	W14L C04020	W14L C04030	W14L C04040	W16L C04050	W16L C04060	W19L C04070
	6	W14L C06020	W16L C06030	W16L C06040	W19L C06050	W19L C06060	
	8	W14L C08020	W16L C08030	W19L C08040			
10	3	W14L D03020	W14L D03030	W14L D03040	W16L D03050	W16L D03060	W19L D03070
	4	W14L D04020	W14L D04030	W16L D04040	W16L D04050	W19L D04060	W19L D04070
	6	W16L D06020					
8	2	W14L E02020	W16L E02030	W16L E02040	W19L E02050		
	3	W16L E03020	W16L E03030	W19L E03040			
	3†	W14L F03020	W16L F03030	W19L F03040			
	4	W16L E04020	W16L E04030	W19L E04040			

*Sag allowance must be considered when figuring cable length for Stretch applications. Add 1 foot of cable for each 50 feet of working cable calculated for your application. (Working cable excludes hook-up length.)

†Type "G" cable.

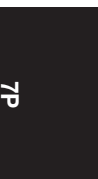

7P Retrieve Reels

Reels for Retrieving:

EXAMPLES:

A moving car is to travel 55 feet. Required cable is 4 Conductor/No. 10. Extra cables needed to hook up to the car is 2 feet. The following EXAMPLES appear in bold type in the selection charts.

1. If the reel must be END MOUNTED, the required cable length would be 55 feet, plus 2 feet for the hook-up. Round up to 60 feet per the available footage in the chart below. The correct model to choose would be **W19R-D04060**.

2. If the reel may be CENTER MOUNTED, only half as much cable is required – it will be used in both directions. Half of the required length would be 27.5 feet, plus 2 feet for the hook-up for a total of 29.5 feet. Round up to 30 feet and choose model **W14R-D04030**. A savings will be realized because less cable was used and, thus, a smaller reel was required.

Selection Chart:

Wire Size	No. of Cond.	20 Feet	30 Feet	40 Feet	50 Feet	60 Feet	70 Feet
16	3	W14R A03020	W14R A03030	W14R A03040	W16R A03050	W16R A03060	W19R A03070
	4	W14R A04020	W14R A04030	W14R A04040	W16R A04050	W16R A04060	W19R A04070
	6	W14R A06020	W14R A06030	W14R A06040	W14R A06050	W16R A06060	W19R A06070
	8	W14R A08020	W14R A08030	W16R A08040	W16R A08050	W16R A08060	W19R A08070
	10	W14R A10020	W14R A10030	W16R A10040	W16R A10050	W19R A10060	W19R A10070
	12	W14R A12020	W14R A12030	W16R A12040	W16R A12050	W19R A12060	W19R A12070
14	3	W14R B03020	W14R B03030	W14R B03040	W14R B03050	W16R B03060	W19R B03070
	4	W14R B04020	W14R B04030	W14R B04040	W14R B04050	W16R B04060	W19R B04070
	6	W14R B06020	W14R B06030	W16R B06040	W16R B06050	W16R B06060	W19R B06070
	8	W14R B08020	W16R B08030	W16R B08040	W19R B08050	W19R B08060	W19R B08070
	10	W14R B10020	W16R B10030	W19R B10040			
	12	W16R B12020	W16R B12030	W19R B12040			
12	3	W14R C03020	W14R C03030	W14R C03040	W14R C03050	W16R C03060	W16R C03070
	4	W14R C04020	W14R C04030	W14R C04040	W16R C04050	W16R C04060	W19R C04070
	6	W14R C06020	W16R C06030	W16R C06040	W19R C06050	W19R C06060	W19R 06070
	8	W14R C08020	W16R C08030	W19R C08040			
	10						
	12						
10	3	W14R D03020	W14R D03030	W14R D03040	W16R D03050	W16R D03060	W16R D03070
	4	W14R D04020	W14R D04030	W16R D04040	W16R D04050	W19R D04060	W19R D04070
	6	W14R D06020	W19R D06030	W19R D06040			
	8	W19R D08020	W19R D08030				
8	2	W14R E02020	W16R E02030	W16R E02040	W19R E02050	W20AR E02060	
	3	W14R E03020	W16R E03030	W19R E03040			
	3†	W14R F03020	W16R F03030	W19R F03040			
	4	W16R E04020	W16R E04030	W19R E04040			

†Type "G" cable.