

RR2KP Series Latch Relays

**Self-maintained Latch Relays
DPDT — 10A contact capacity**

The RR2KP series latch relays have a self-holding function using permanent magnets in the magnetic circuit. Applying a voltage on the set (or reset) coil operates the armature and retains the contacts in that position until the opposite coil is energized, hence the latch relays are ideal for memory and flip-flop circuit applications.



- Enhanced self-holding functions, and vibration and shock resistance.
- The self-holding mechanism is not subject to wear unlike mechanical latch relays.
- Recognized by UL and certified by CSA



Part Number Selection



Contact	Model	Part Number	
		Pin Terminal	Coil Voltage Code
DPDT 	Basic	RR2KP-U	AC6, AC12, AC24, AC110, AC120, AC220, AC240 DC6, DC12, DC24, DC48, DC110
	With Check Button	RR2KP-UC	

Ordering Information

When ordering, specify the Part No. and coil voltage code:

(example) **RR2KP-U** **AC120**
Part No. Coil Voltage Code

Sockets

Relay	DIN Rail Mount	Finger-safe DIN Rail Mount	Panel Mount
RR2KP	SR3P-05 SR3P-06	SR3P-05C	SR3P-51
			

Springs & Clips (optional)	
Part Number	Description
SR3P-06F3	use with SR3P-05 SR3P-05C SR3P-06
SR3P-51F3	use with SR3P-51

Switches & Pilot Lights

Display Lights

Relays & Sockets

Timers

Terminal Blocks

Circuit Breakers

Specifications

Contact Material	Silver	
Contact Resistance	30 mΩ maximum (initial value)	
Operate Time	25 ms maximum (at the rated voltage)	
Power Consumption (approx.)	AC: 2.4 VA (50 Hz), 2.2 VA (60 Hz) DC: 1.5W	
Insulation Resistance	100 MΩ minimum (500V DC megger)	
Dielectric Strength	Between live and dead parts: 1,500V AC, 1 minute Between contact and coil: 1,500V AC, 1 minute Between contacts of different poles: 1,500V AC, 1 minute Between contacts of the same pole: 1,000V AC, 1 minute	
Operating Frequency	Electrical:	1800 operations/h maximum
	Mechanical:	18,000 operations/h maximum
Temperature Rise	Coil: 85°C maximum, Contact: 65°C maximum	
Vibration Resistance	0 to 60 m/s ² (maximum frequency: 55 Hz), Frequency: 5 to 55 Hz, Amplitude: 0.5 mm	
Shock Resistance	100 m/s ² minimum	
Mechanical Life	5,000,000 operations minimum	
Electrical Life	500,000 operations minimum (110V AC, 10A)	
Operating Temperature	-5 to +40°C (no freezing)	
Operating Humidity	45 to 85% RH (no condensation)	
Weight (approx.)	170g	

Coil Ratings

Rated Voltage (V)	Rated Current (mA) ±15% at 20°C		Coil Resistance (Ω) ±10% at 20°C	Operation Characteristics (values at 20°C)	
	50Hz	60Hz		Maximum Continuous Applied Voltage	Set and Reset Voltage
AC (50/60Hz)	6	467	429	110%	80% maximum
	12	200	184		
	24	100	92		
	110	23	21		
	120	24	22		
	220	10.9	10		
	240	11.5	10.6		
DC	6	240		110%	80% maximum
	12	120			
	24	60			
	48	30			
	110	13.8			

Contact Ratings

Switching Voltage	Continuous Current	Maximum Contact Capacity				
		Allowable Contact Power		Rated Load		
		Resistive Load	Inductive Load	Voltage (V)	Res. Load	Ind. Load
250V AC 125V DC	10A	1650VA AC 300W DC	1100VA AC 225W DC	110 AC	10A	7.5A
				220 AC	7.5A	5A
				30 DC	10A	5A
				100V DC	0.5A	0.3A

Note: Inductive load for the rated load — cos φ = 0.3, L/R = 7 ms

UL Ratings

Voltage	Resistive	General use	Motor Load
240V AC	10A	7A	1/3 HP
120V AC	10A	7.5A	1/4 HP
30V DC	10A	7A	—

CSA Ratings

Voltage	Resistive	General use	Motor Load
240V AC	10A	7A	1/3 HP
120V AC	10A	7.5A	1/4 HP
100V DC	—	0.5A	—
30V DC	10A	7.5A	—

Switches & Pilot Lights

Display Lights

Relays & Sockets

Timers

Terminal Blocks

Circuit Breakers

Socket Specifications

	Relays	Terminal	Electrical Rating	Wire Size	Torque
DIN Rail Mount Sockets	SR3P-05	M3 screw with captive wire clamp	300V, 10A	2-#12AWG	9 - 11.5 in•lbs
	SR3P-05C	M3 screw with captive wire clamp, fingersafe	300V, 10A	2-#12AWG	9 - 11.5 in•lbs
	SR3P-06	M3 screw with captive wire clamp	300V, 10A	2-#12AWG	9 - 11.5 in•lbs
Through Panel Mount Socket	SR3P-51	Solder	300V, 10A	—	—

Electrical Life Curve
AC Load

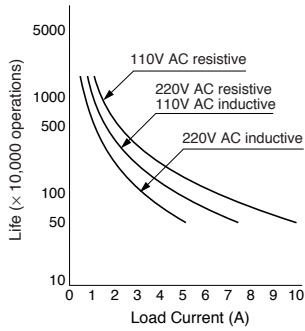

DC Load

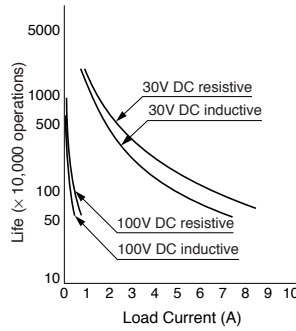

Internal Connection (View from Bottom)
(Shown in unlatched/reset position)

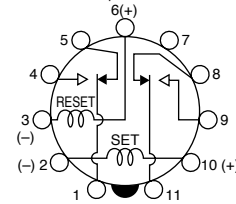

Dimensions (mm)

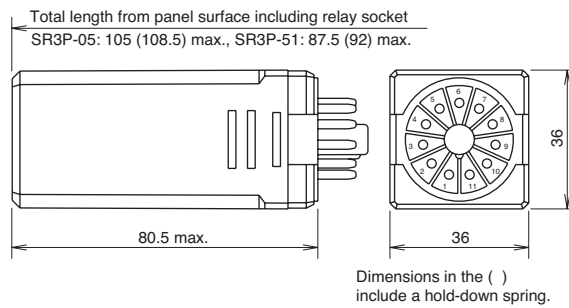

Standard DIN Rail Mount Sockets
SR3P-05

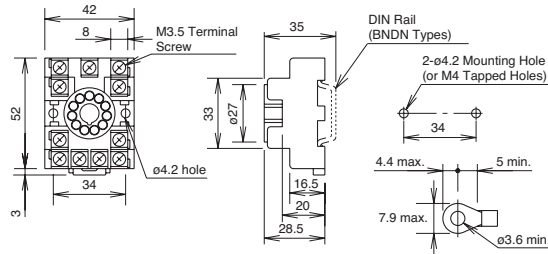

SR3P-06

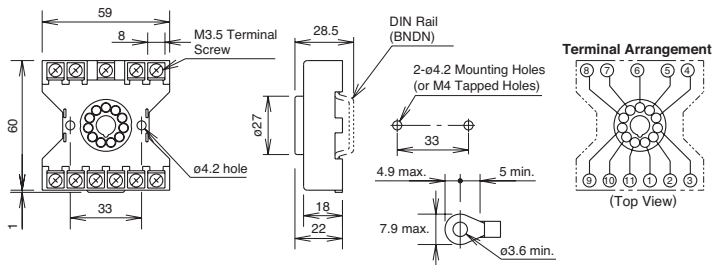

Finger-safe DIN Rail Mount Sockets
SR3P-05C

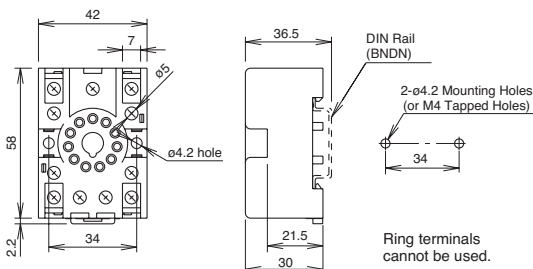

Through Panel Mount Socket
SR3P-51

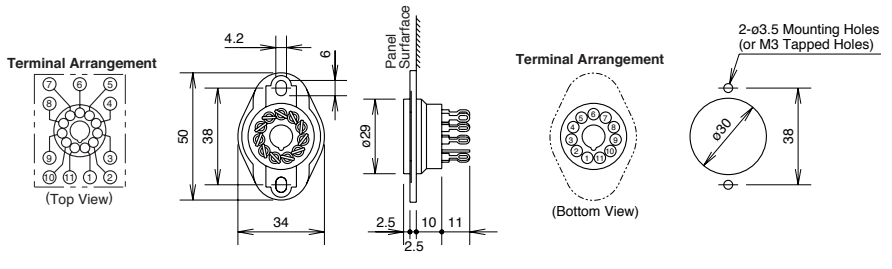

Switches & Pilot Lights

Display Lights

Relays & Sockets

Timers

Terminal Blocks

Circuit Breakers

RR2KP Series Latch Relays

**Self-maintained Latch Relays
DPDT — 10A contact capacity**

The RR2KP series latch relays have a self-holding function using permanent magnets in the magnetic circuit. Applying a voltage on the set (or reset) coil operates the armature and retains the contacts in that position until the opposite coil is energized, hence the latch relays are ideal for memory and flip-flop circuit applications.



- Enhanced self-holding functions, and vibration and shock resistance.
- The self-holding mechanism is not subject to wear unlike mechanical latch relays.
- Recognized by UL and certified by CSA



Part Number Selection



Contact	Model	Part Number	
		Pin Terminal	Coil Voltage Code
DPDT 	Basic	RR2KP-U	AC6, AC12, AC24, AC110, AC120, AC220, AC240 DC6, DC12, DC24, DC48, DC110
	With Check Button	RR2KP-UC	

Ordering Information

When ordering, specify the Part No. and coil voltage code:

(example) **RR2KP-U** **AC120**
Part No. Coil Voltage Code

Sockets

Relay	DIN Rail Mount	Finger-safe DIN Rail Mount	Panel Mount
RR2KP	SR3P-05 SR3P-06	SR3P-05C	SR3P-51
			

Springs & Clips (optional)	
Part Number	Description
SR3P-06F3	use with SR3P-05 SR3P-05C SR3P-06
SR3P-51F3	use with SR3P-51

Switches & Pilot Lights

Display Lights

Relays & Sockets

Timers

Terminal Blocks

Circuit Breakers

Specifications

Contact Material	Silver
Contact Resistance	30 mΩ maximum (initial value)
Operate Time	25 ms maximum (at the rated voltage)
Power Consumption (approx.)	AC: 2.4 VA (50 Hz), 2.2 VA (60 Hz) DC: 1.5W
Insulation Resistance	100 MΩ minimum (500V DC megger)
Dielectric Strength	Between live and dead parts: 1,500V AC, 1 minute Between contact and coil: 1,500V AC, 1 minute Between contacts of different poles: 1,500V AC, 1 minute Between contacts of the same pole: 1,000V AC, 1 minute
Operating Frequency	Electrical: 1800 operations/h maximum Mechanical: 18,000 operations/h maximum
Temperature Rise	Coil: 85°C maximum, Contact: 65°C maximum
Vibration Resistance	0 to 60 m/s ² (maximum frequency: 55 Hz), Frequency: 5 to 55 Hz, Amplitude: 0.5 mm
Shock Resistance	100 m/s ² minimum
Mechanical Life	5,000,000 operations minimum
Electrical Life	500,000 operations minimum (110V AC, 10A)
Operating Temperature	-5 to +40°C (no freezing)
Operating Humidity	45 to 85% RH (no condensation)
Weight (approx.)	170g

Coil Ratings

Rated Voltage (V)	Rated Current (mA) ±15% at 20°C		Coil Resistance (Ω) ±10% at 20°C	Operation Characteristics (values at 20°C)	
	50Hz	60Hz		Maximum Continuous Applied Voltage	Set and Reset Voltage
AC (50/60Hz)	6	467	429	110%	80% maximum
	12	200	184		
	24	100	92		
	110	23	21		
	120	24	22		
	220	10.9	10		
	240	11.5	10.6		
DC	6	240		110%	80% maximum
	12	120			
	24	60			
	48	30			
	110	13.8			

Contact Ratings

Switching Voltage	Continuous Current	Maximum Contact Capacity				
		Allowable Contact Power		Rated Load		
		Resistive Load	Inductive Load	Voltage (V)	Res. Load	Ind. Load
250V AC 125V DC	10A	1650VA AC 300W DC	1100VA AC 225W DC	110 AC	10A	7.5A
				220 AC	7.5A	5A
				30 DC	10A	5A
				100V DC	0.5A	0.3A

Note: Inductive load for the rated load — cos φ = 0.3, L/R = 7 ms

UL Ratings

Voltage	Resistive	General use	Motor Load
240V AC	10A	7A	1/3 HP
120V AC	10A	7.5A	1/4 HP
30V DC	10A	7A	—

CSA Ratings

Voltage	Resistive	General use	Motor Load
240V AC	10A	7A	1/3 HP
120V AC	10A	7.5A	1/4 HP
100V DC	—	0.5A	—
30V DC	10A	7.5A	—

Switches & Pilot Lights

Display Lights

Relays & Sockets

Timers

Terminal Blocks

Circuit Breakers

Socket Specifications

	Relays	Terminal	Electrical Rating	Wire Size	Torque
DIN Rail Mount Sockets	SR3P-05	M3 screw with captive wire clamp	300V, 10A	2-#12AWG	9 - 11.5 in•lbs
	SR3P-05C	M3 screw with captive wire clamp, fingersafe	300V, 10A	2-#12AWG	9 - 11.5 in•lbs
	SR3P-06	M3 screw with captive wire clamp	300V, 10A	2-#12AWG	9 - 11.5 in•lbs
Through Panel Mount Socket	SR3P-51	Solder	300V, 10A	—	—

Electrical Life Curve
AC Load

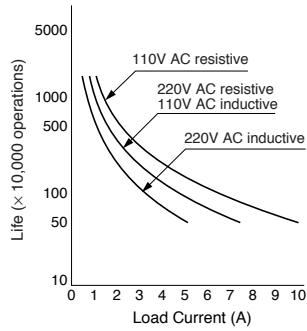

DC Load

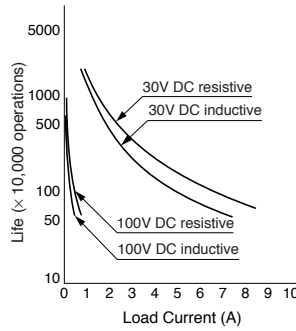

Internal Connection (View from Bottom)
(Shown in unlatched/reset position)

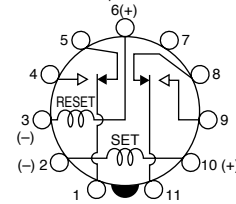

Dimensions (mm)

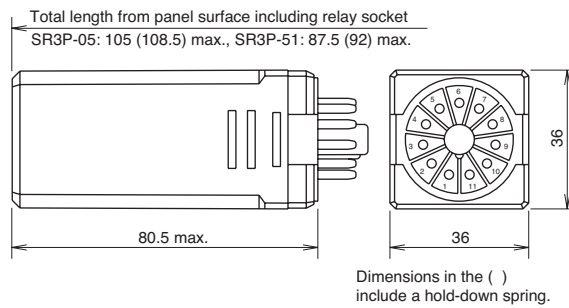

Standard DIN Rail Mount Sockets
SR3P-05

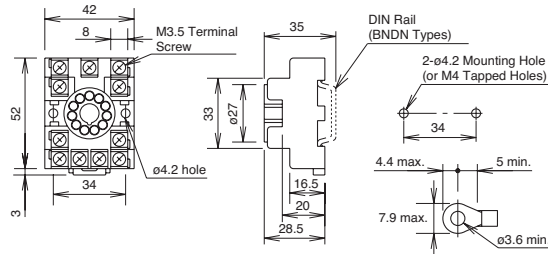

SR3P-06

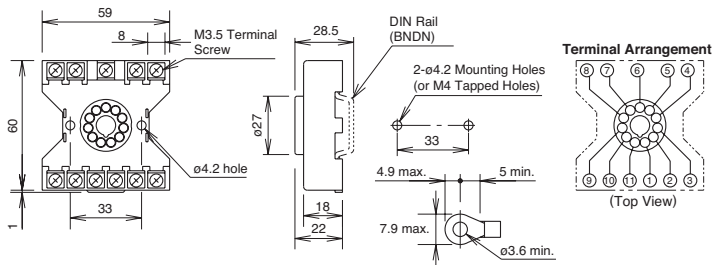

Finger-safe DIN Rail Mount Sockets
SR3P-05C

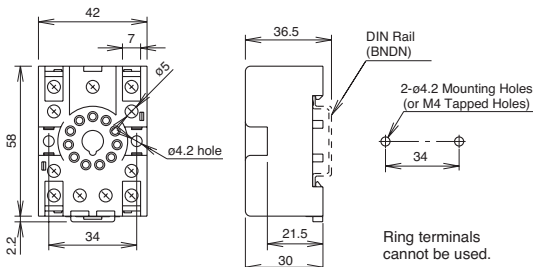

Through Panel Mount Socket
SR3P-51

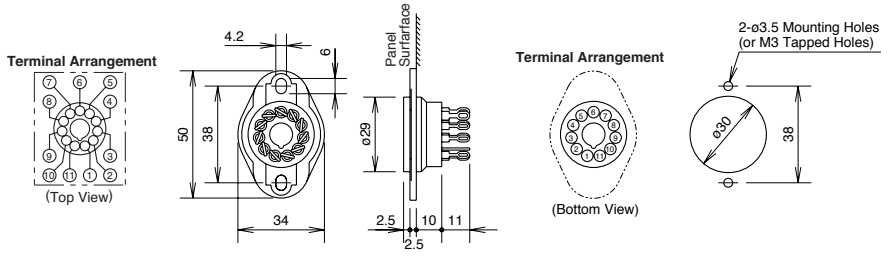

Switches & Pilot Lights

Display Lights

Relays & Sockets

Timers

Terminal Blocks

Circuit Breakers