

Midwest Electric Products

General Products Catalog



Markets



Contents

Introduction	i-1 – i-4
Service Equipment	1-1 – 1-28
Single Socket Metering	2-1 – 2-16
Horizontal Meter Sockets	3-1 – 3-10
Load Centers / Circuit Breakers	4-1 – 4-14
Spa Panels	5-1 – 5-2
Safety Switches	6-1 – 6-10
AC Disconnects	7-1 – 7-8
Transfer Switches / Power Inlets	8-1 – 8-8
Temporary Power	9-1 – 9-12
Power Outlets	10-1 – 10-14
RV Park Equipment	11-1 – 11-34
Terminal Boxes	12-1 – 12-4
Transformers	13-1 – 13-32
Parts/Accessories / Application Data	14-1 – 14-18
Authorized Reps	15-1 – 15-2
Product Index	16-1 – 16-15

Introduction

How To Use This Catalog

Midwest Electric Products is pleased to offer our product catalog. Model numbers are illustrated with a layout drawing and data table. (See Fig. 1 as an example.) A technical table (see Fig. 2) at the end of each section shows specific information including replacement parts, cabinet dimensions, enclosure styles and knockout configurations. Also, for quick reference, a Product Index is located on pages 16-1–16-12.

Each of the indexed sections of the catalog are clearly marked with tabs on each page contained within that section.

For quick reference, heads clearly identify model type, amp range and voltage of product group shown.

An easy to understand diagram illustrates the model's internal component configuration.

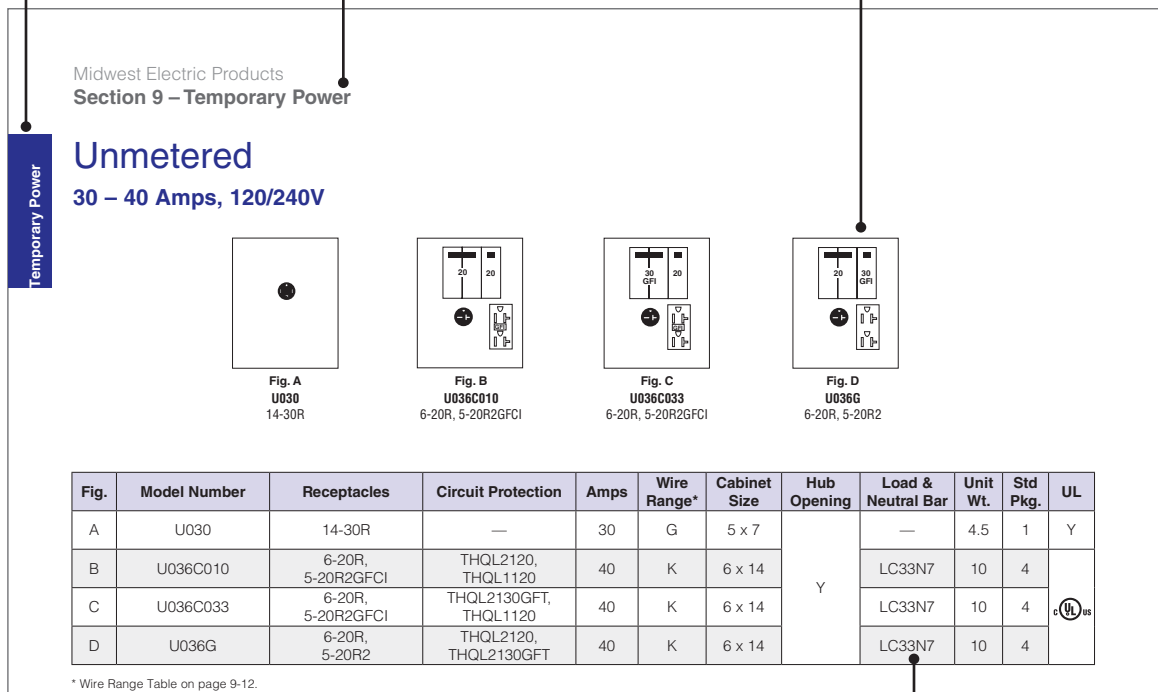

Fig. 1
 Partial catalog page showing model layout drawings and data table.

Each diagram corresponds to defining data in an accompanying table. Tables are arranged in ascending amperage order for each product group and contain all necessary ordering information.

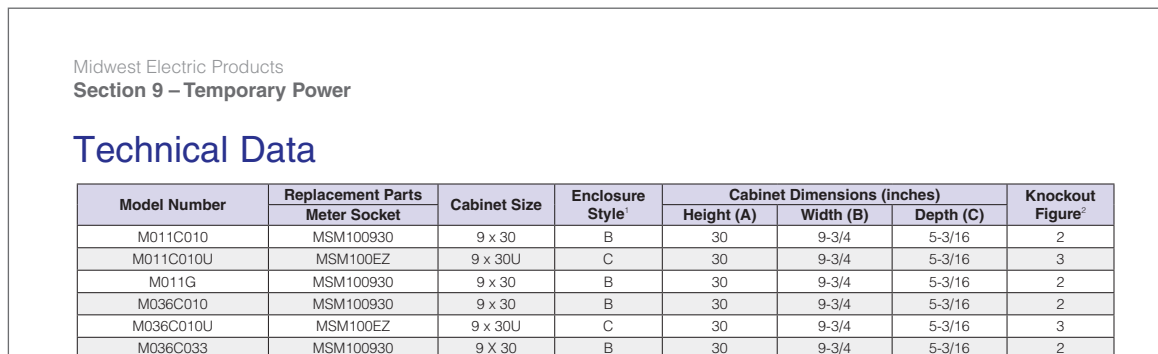
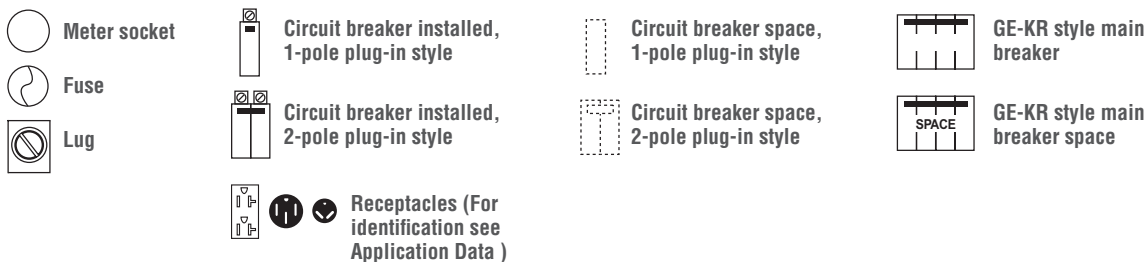

Fig. 2
 Partial catalog page showing a Technical Data table.

Catalog Keys

Model Diagram Symbols



Model Number System

Model numbers are based on the following system.
Example: Model Number U041CP6010.

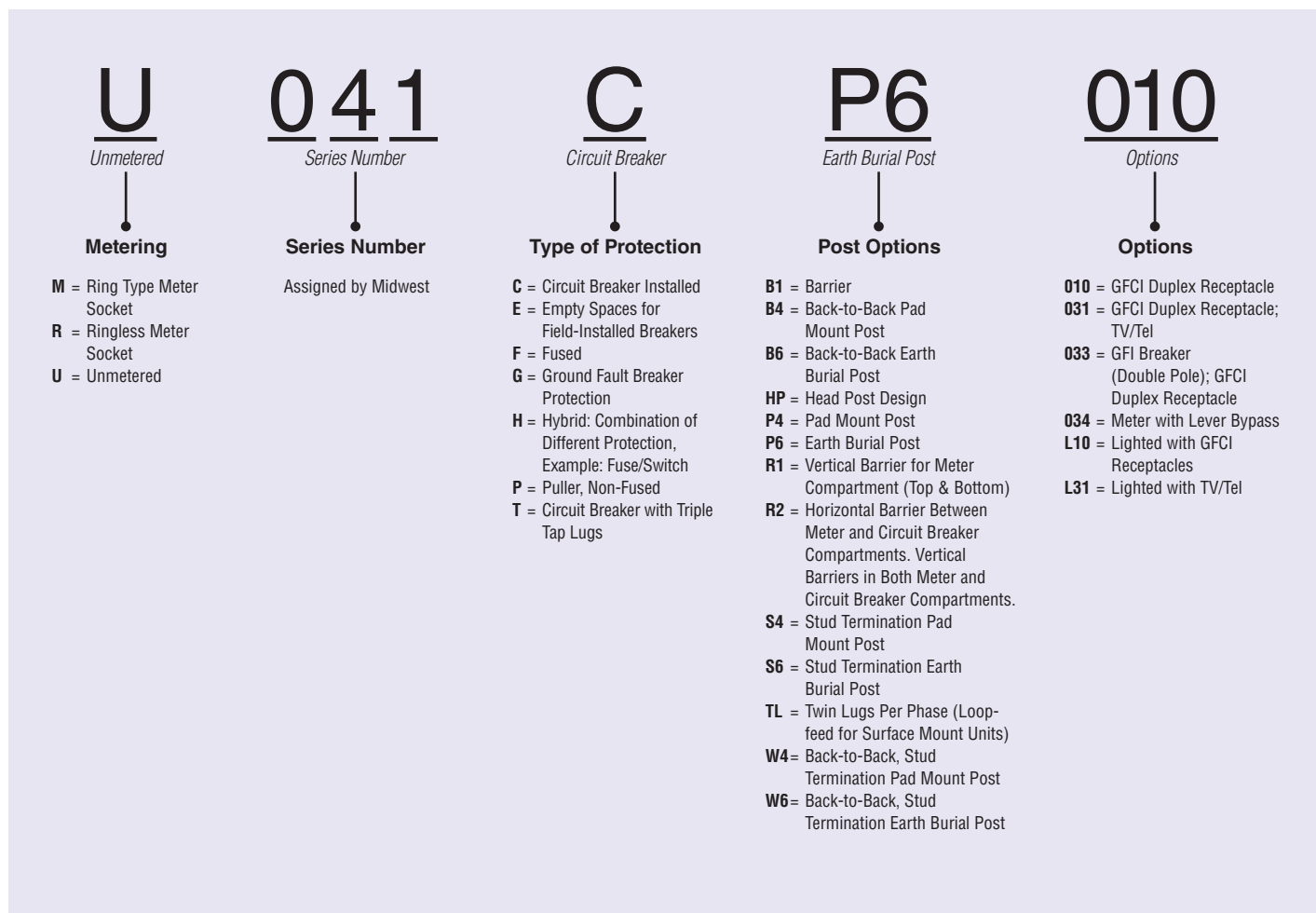

Introduction

Product Features

Surface Unit

- NEMA 3R weatherproof construction
- G90 galvanized steel construction for superior corrosion resistance
- Durable polyester powder coat finish resists chipping and fading
- All components factory wired and assembled, reducing installation time
- Door removable for installation ease; stay open position for user convenience
- All terminals accept copper or aluminum wire for added installation flexibility
- Wide range of receptacle configurations
- Broad range of concentric knockouts to accommodate varied wiring needs
- All units with factory installed Cu/Al equipment ground lug
- Dead front construction prevents accidental contact with live parts
- Padlock provision to prevent unauthorized access
- Rolled edge door for cord protection
- Conforms to NEC and NEMA standards



U055C010

Pedestal Unit

- NEMA 3R weatherproof construction
- G90 galvanized steel construction for superior corrosion resistance
- Durable polyester powder coat finish resists chipping and fading
- All components factory wired and assembled, reducing installation time
- Door removable for installation ease; stay open position for user convenience
- All terminals accept copper or aluminum wire for added installation flexibility
- Loop-feed terminals for maximum flexibility
- Single or double cabinet posts for fast and economical multiple site applications
- Barriers available for line, load and meter socket isolation
- Utility accepted meter sealing accommodations
- Pad mount posts available
- Dead front construction prevents accidental contact with live parts
- Padlock provision to prevent unauthorized access
- Rolled edges on all post wire entry points
- Conforms to NEC and NEMA standards



M255GP6

Electrical Data and Wiring Information

All equipment manufactured by Midwest Electric Products contains a label located on the inside of the door which gives electrical data and wiring information for the unit. On select models the label also lists the renewal parts for the unit. Pictured below is a sample label.

CAT No. **UG412RMW250**
TYPE 3R OUTDOOR ENCLOSURE

TYPICAL WIRING DIAGRAM
8 POLES MAX 6-20 AWG CU/AL

MAX BRANCH OR MAIN CIRCUIT BREAKER RATING 125 AMP

SEE NOTE 1:

INSULATED NEUTRAL
BOND WHEN USED AS SERVICE EQUIPMENT

CLASS CTL PANELBOARD LOAD CENTER
E68341 Vol 1
ISSUE NUMBER C-3024

NOTE 1:
* THERE ARE 3 LUGS ON THE BREAKER
* INSERT WHITE LOAD WIRE IN LUG MARKED
* WIREW 2001
* SEE DIAGRAM

USE ONLY WITH GE TYPE THQP, THQP, THQL, THQL, THXL, THXL, THQL-QFCL, THQL-QFCL, SIEMENS TYPE QFF OR MIDWEST TYPE MHQL BREAKERS 50 AMP MAX

MAIN RATINGS 120/240 VAC 3-WIRE, 125 AMPERES
ADDITIONAL RATING: 240V 1 PHASE 2-WIRE, FOR THIS SYSTEM NEUTRAL IS NOT USED AND ONLY BREAKER 240V ARE TO BE USED

WARNING

THE CIRCUIT BREAKER IN THIS BOX HAVE BEEN SELECTED TO PROTECT THE WIRING, TO AVOID DAMAGE AND LOSS OF PROTECTION, DO NOT REPLACE WITH HIGHER AMPERE RATED BREAKERS, IF CHANGES ARE NECESSARY CALL A QUALIFIED ELECTRICAL CONTRACTOR

IF BREAKER TRIPS HANDLE WILL BE IN INTERMEDIATE POSITION TO RESTORE SERVICE
1. MOVE HANDLE TO "OFF" POSITION
2. THEN TO "ON" POSITION

WHEN INSTALLED IN ACCORDANCE WITH THE NEC, UNIT IS NOT SUITABLE FOR USE AS SERVICE EQUIPMENT. MAXIMUM CONTINUOUS LOADS ON BRANCH CIRCUITS NOT TO EXCEED 80% OF THE RATINGS OF THE CIRCUIT BREAKERS EMPLOYED IN OTHER THAN MOTOR CIRCUITS. LES CHARGES CONTINUES MAXIMALES POUR LES DERIVATIONS NE COUVRENT PAS ETRE SUPERIEURES A 80% DU COURANT NOMINAL DES DISJONCTEURS UTILISES POUR DES CIRCUITS AUTES QUE DES CIRCUITS DE MOTEURS.

USE COPPER OR ALUMINUM WIRE

USE 60°C OR 75°C AMPACITY SIZED WIRE ON LINE AND NEUTRAL TERMINALS. SEE CIRCUIT BREAKERS FOR THEIR WIRE TEMPERATURE RATING

ALUMINUM TERMINATIONS TO HELP GUARD AGAINST OVER-HEATING WHEN CONNECTING ALUMINUM WIRE IN CU/AL LUG, REMOVE OXIDE FILM FROM WIRE AND PROTECT IT WITH OXIDE INHIBITING COMPOUND.

SUITABLE FOR USE AS SERVICE EQUIPMENT WHEN NOT MORE THAN 6 MAIN DISCONNECTS ARE PROVIDED WHEN NOT USED AS A LIGHTING AND APPLIANCE BRANCH CIRCUIT PANELBOARD. SEE ARTICLE 384-14 OF THE NEC.

THE SHORT CIRCUIT RATING OF THIS PANELBOARD IS EQUAL TO THE LOWEST INTERRUPTING RATING OF ANY INSTALLED CIRCUIT BREAKER BUT NOT MORE THAN 10,000 RMS SYMMETRICAL AMPERES AT 240V SINGLE PHASE

⚡ DANGER
HAZARD OF ELECTRICAL SHOCK OR BURN. TURN OFF POWER BEFORE WORKING INSIDE THIS EQUIPMENT.

RAINPROOF CONDUIT HUBS

CONDUIT SIZE	3/4	1	1 1/4	1 1/2	2	2 1/2
CAT No.	807	810	813	815	820	825

NEUTRAL AND EQUIPMENT GROUND WIRE

	SOLID	STRANDED
LARGE HOLES	14-8 AWG CU	10-4 AWG CU
	12-6 AWG AL	10-4 AWG AL
SMALL HOLES	14-8 AWG CU	12-8 AWG CU
	12-6 AWG AL	12-8 AWG AL

SLOTTED WIRE

AWG WIRE	MIN LB-IN	MAX LB-IN
14-12	32	35
8	38	40
8-4	41	45
2-20	45	50

WIRE CONNECTOR TERMINAL SCREW TIGHTENING TORQUE APPLIES ONLY TO LINE, NEUTRAL AND EQUIPMENT GROUND TERMINALS

SAL

MNP801903

MADE IN MEXICO
PLANT SAL

MIDWEST ELECTRIC PRODUCTS
41 WOODFORD AVENUE
PLAINVILLE, CT 06062
WWW.MIDWESTELECTRIC.COM

Warranty

The Company warrants to the Purchaser that the equipment to be delivered hereunder will be free from defects in material or workmanship and will be of the kind and quality designated or specified in the contract.

This warranty shall apply only to defects appearing within *one year from the date of shipment* by the Company.

If the equipment delivered hereunder does not meet the above warranty, and if the Purchaser promptly notifies the Company, the Company shall thereupon correct any defect including nonconformance with the specifications either (at its option), by repairing any defective or damaged parts of the equipment, or by making available at the Company's plant necessary repaired or replacement parts. The liability of the Company under this warranty (except as to title), or for any loss or damage to the equipment whether the claim is based on contract or negligence, shall not in any case exceed the cost of correcting defects in the equipment as herein provided and upon the expiration of the warranty period all such liability shall terminate. The foregoing shall constitute the exclusive remedy of the Purchaser and the exclusive liability of the Company.

The foregoing warranty is exclusive and in lieu of all other warranties, whether written, oral, implied, or statutory (except as to title). **No warranty of merchantability or fitness for purpose shall apply.** The Company does not warrant any equipment of other manufacture designated by Purchaser.

Section 1

Service Equipment



Application Information

Where electrical power enters a building or other structure, the National Electrical Code (NEC) requires electrical distribution equipment rated as “Service Entrance.” Such service equipment usually consists of one main breaker disconnect or space for up to 6 main disconnects. Midwest models meet these NEC requirements and are UL listed as service entrance equipment.

Service entrance products are typically utilized on single family residences and mobile homes. Additionally, service entrance for mobile homes is generally located within 30 feet of the mobile home. This location requirement by the NEC and the common use of underground service feeders, combine to make service entrance on a pedestal the preferred installation method by many park owners. Midwest offers a broad range of pedestal units, factory assembled and wired, with loop feed lugs to reduce installation time and labor expense. Midwest also offers a wide selection of surface units for single family residences and mobile home sites.

Specifications and Features

- Rated for use as service equipment
- NEMA 3R weatherproof enclosure
- G90 galvanized steel construction for superior corrosion protection
- Durable polyester powder coat finish resists chipping and fading
- Metered and unmetered construction available up to 200 Amps
- All-in-one construction available up to 400 Amps
- Available in surface or pedestal mount construction
- Segregated meter compartment for utility power protection
- Weather resistant and tamper resistant GFCI receptacles
- Horn bypass comes standard on ringless metered units
- Cu/Al rated field terminations
- Factory installed Cu/Al equipment ground lug
- Padlock provision to prevent unauthorized entry
- UL Listed (Panelboards No. 67)



Post Models

- Factory wired on loop feed lugs on 200 Amp models
- Removable post door allows lay in wiring
- Rolled edges to protect service cable
- Locking hasp for utility seal on post covers
- Stud terminations available to accept compression type lugs

Metered

Surface, 100 Amps, 120/240V

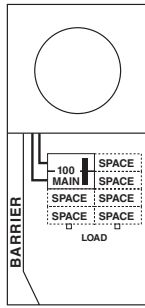

Fig. A
M101CB2, R101CB2, R101CB2ETG
Series

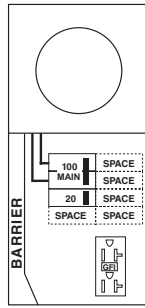

Fig. B
R101CB2010
Series

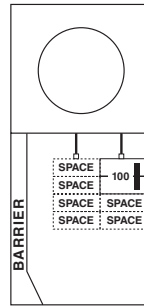

Fig. C
M102CB2, R102CB2
Parallel

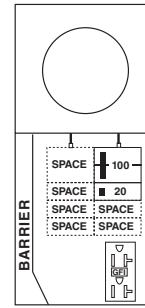

Fig. D
M102CB2010
Parallel

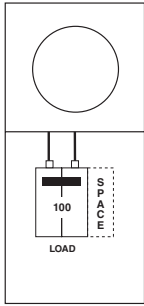

Fig. E
M100C, R100C
Parallel

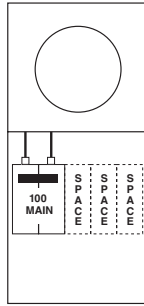

Fig. F
M101C, R101C
Series

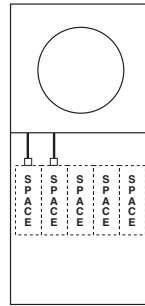

Fig. G
M102E, R102E
Parallel

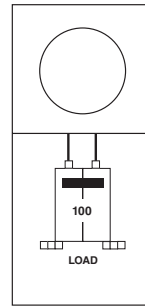

Fig. H
M100T, R100T
Series

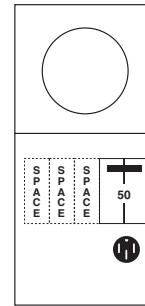

Fig. I
M354C
Series

Overhead/Underground Feed

Fig.	Model Number		Circuit Protection	Amps	Spaces	Wire Range*	Cabinet Size	Load Center	Unit Wt.	Std Pkg.	UL and Utility Approved
	Ring Type	Ringless									
A	M101CB2	R101CB2, ¹ R101CB2ETG	THQL21100	100	6	AN	14 x 26	LC88PC	38	1	UL, ETG
B	—	R101CB2010	THQL21100, THQL1120	100	5						UL
C	M102CB2	R102CB2 ¹	THQL21100	100	6						
D	M102CB2010	—	THQL21100, THQL1120	100	5						

Overhead Feed

Fig.	Model Number		Circuit Protection	Amps	Spaces	Wire Range*	Cabinet Size	Load Center	Unit Wt.	Std Pkg.	UL
	Ring Type	Ringless									
E	M100C	R100C	THQL21100	100	1	AB	9 x 30	LC33N1	24	1	Y
F	M101C ³	R101C	THQL21100	100	3	AB	9 x 30	LC55N1	25		
G	M102E	R102E ²	—	100	5	AB	9 x 30	LC55N1	24		
H	M100T ⁴	R100T ⁴	CBT2102	100	0	AB	9 x 30	LC32X1	24		
I	M354C	—	THQL2150	100	3	AD	9 x 30	LC55N1	25		UL ^c US

¹ Available with barrel – R101CB2LK and R102CB2LK.
² Available with neutral, order R102EN. Consult representative/utility for local utility acceptance.
³ Available with copper wire, order M101CC.
⁴ "Triple-Tap" - 3 load lugs per phase.
 * Wire Range Table on page 1-24.

Metered

Surface, Side-by-Side, 125 – 150 Amps, 120/240V

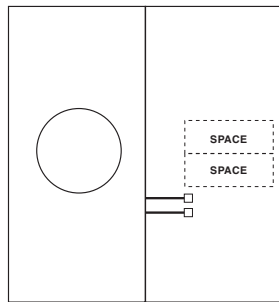

Fig. A
MS125E
 Series

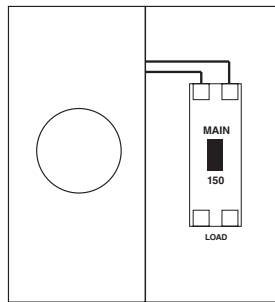

Fig. B
MS150C, MS150CGP, RS150C, RS150CGP
 Series

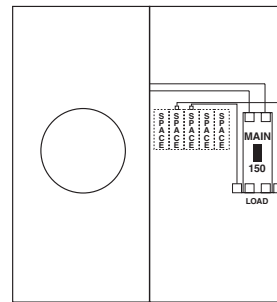

Fig. C
MS151C
 Series

Overhead/Underground Feed

Fig.	Model Number		Circuit Protection	Amps	Spaces	Wire Range*	Cabinet Size	Load Center	Unit Wt.	Std Pkg.	UL and Utility Approved
	Ring Type	Ringless									
A	MS125E	—	—	125	2	BC	16 x 17	PC2LC	24	1	UL
B	MS150C, MS150CGP	RS150C, RS150CGP	TQDL or equivalent	150	—	BC	17 x 26	—	41		UL, GP
C	MS151C	—	CBL2151	150	5	BC	17 x 26	LC55N1	43		UL

Surface, 150 Amps, 120/240V

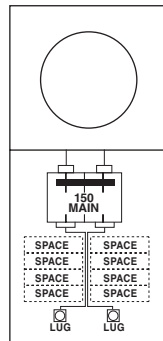

Fig. D
R158CR2TLFNG
 Series

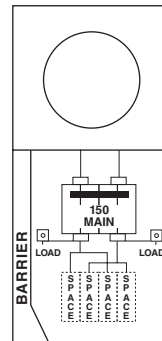

Fig. E
M181CB1, M181CB1GP, R181CB1
 Series

Overhead/Underground Feed

Fig.	Model Number		Circuit Protection	Amps	Spaces	Wire Range*	Cabinet Size	Load Center	Unit Wt.	Std Pkg.	UL and Utility Approved
	Ring Type	Ringless									
D	—	R158CR2TLFNG	THQMV150	150	8	ZZ	14 x 32	—	58	1	UL, MEG
E	M181CB1, M181CB1GP	R181CB1	THQMV150WLBP	150	4	BG	14 x 28	LCTL + LCBS	34		UL, GP

* Wire Range Table on pages 1-25–1-26.

Metered

Surface, Side-by-Side, 200 Amps, 120/240V

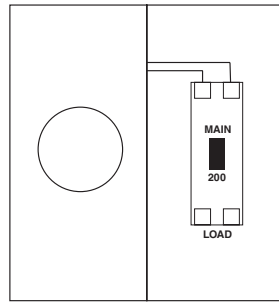

Fig. A
MS250C, MS250CGP, RS250C, RS250CGP
 Series

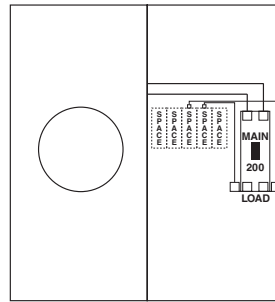

Fig. B
MS251C, RS251C
 Series

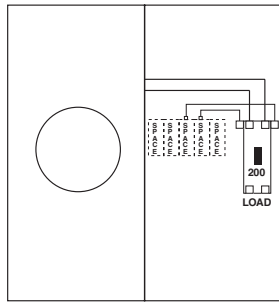

Fig. C
MS252C
 Parallel

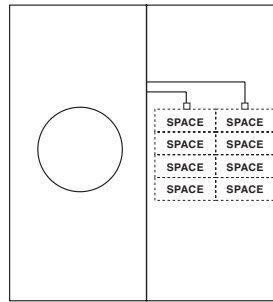

Fig. D
MS252E014
 Parallel

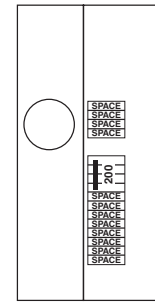

Fig. E
MS2453C
 Parallel

Overhead/Underground Feed

Fig.	Model Number		Circuit Protection	Amps	Spaces	Wire Range*	Cabinet Size	Load Center	Unit Wt.	Std Pkg.	UL and Utility Approved
	Ring Type	Ringless									
A	MS250C, MS250CGP ¹	RS250C, RS250CGP ¹	TQD22200WL	200	—	BC	17 x 26	—	41	1	UL, GP
B	MS251C	RS251C	CBL2201	200	5	BC	17 x 26	LC55N1	41		UL
C	MS252C	—	LCB2201	200	5	BC	17 x 26	LC55N1	43		
D	MS252E014 ²	—	—	200	8	BC	14 x 31	LC88X2	39		
E	MS2453C	—	THQMV200WLBP	200	8	W	14 x 31	LC88X2	38		

¹ GP models not available with barrel lock.

² Space for 8-Single Pole Breakers or 200A Main and 4-Single Pole Breakers.

* Wire Range Table on pages 1-25-1-26.

Metered

Surface, 200 Amps, 120/240V

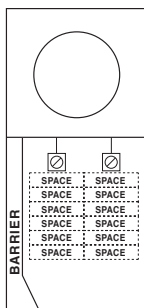

Fig. A

R256EB1A, R256EB1AETG, R256EB1FMG, R256EB1NAETG,
R256EB1NFMG, R256EB118AETG, R256EB118FMG
Parallel

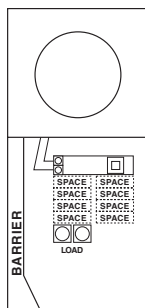

Fig. B

M208CR2A, M208CR2B,
R208CR2A, R208CR2AETG
Series

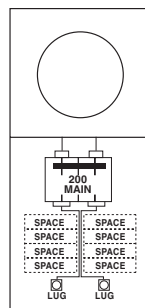

Fig. C

R208CR2TLFMG
Series

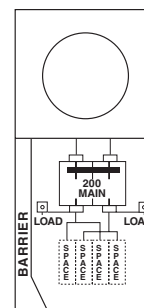

Fig. D

M281CB1, M281CB1GP, R281CB1,
R281CB1EP, R281CB1ETG, R281CB1GP
Series

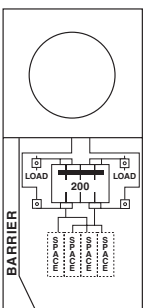

Fig. E

M282CB1, M282CB1C
R282CB1, R282CB1LK
Parallel

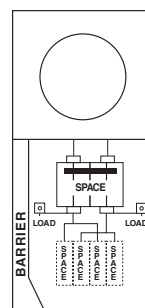

Fig. F

M281EB1, R281EB1
Series

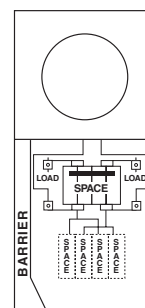

Fig. G

M282EB1, R282EB1
Parallel

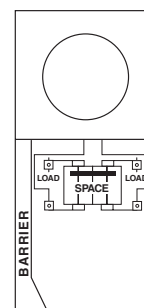

Fig. H

R283CB1, R283CB1AP
Parallel

Overhead/Underground Feed

Fig.	Model Number		Circuit Protection	Amps	Spaces	Wire Range*	Cabinet Size	Load Center	Unit Wt.	Std Pkg.	UL and Utility Approved
	Ring Type	Ringless									
A	—	R256EB1A, ^{2,3} R256EB1AETG, R256EB1FMG, R256EB1NAETG, R256EB1NFMG, R256EB118AETG, R256EB118FMG	—	200	12	—	14 x 26	—	32	1	UL, ETG, MEG
B	M208CR2A ⁶	R208CR2A, R208CR2AETG	TQDL or equivalent	200	8	AN	14 x 28	LC1212PC	46		UL, ETG
C	—	R208CR2TLFMG	THQMV200	200	8	ZZ	14 x 28	—	47		UL, MEG
D	M281CB1, M281CB1GP	R281CB1, ⁴ R281CB1AEP, R281CB1ETG, R281CB1GP ¹	THQMV200WLBP	200	4	BK	14 x 28	LCTNL + LCBS	34		UL, AEP, ETG, GP
E	M282CB1, M282CB1C	R282CB1 ⁴	THQMV200WLBP	200	4	BK	14 x 28	LCTL + LCBS	35		UL
F	M281EB1 ⁵	R281EB1	—	200	5	BK	14 x 28	LCTNL + LCBS	33		UL
G	M282EB1	R282EB1	—	200	5	BK	14 x 28	LCTL + LCBS	33.2		UL
H	—	R283CB1	THQMV200WLBP	200	0	BK	14 x 28	—	32.7		UL
H	—	R283CB1AP	THQMV200WLBP	200	0	BJ	14 x 28	—	34.19		UL

¹ GP models not available with barrel lock.

² Available with aluminum bussing and aluminum enclosure - R256EB1018A.

³ Available with galvanized enclosure with neutral installed - R256EB1NA.

⁴ Available with barrel lock - R281CB1LK and R282CB1LK.

⁵ Available with copper wire - M282CB1C.

⁶ Feed thru lug option available - M208CR2B.

* Wire Range Table on pages 1-24-1-26.

Data subject to change without notice.

Metered

Surface, 200 Amps, 120/240V

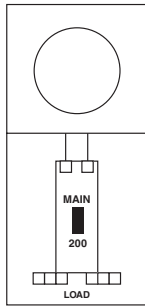

Fig. A
R200T
Series

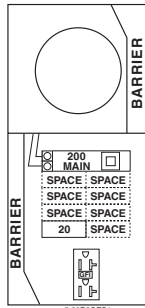

Fig. B
M208CR2B010
Series

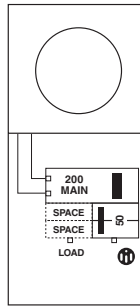

Fig. C
M254C
Series

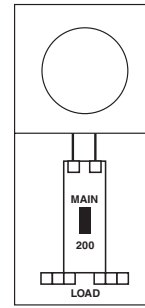

Fig. D
M280TM1, R280T
Series

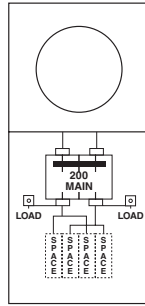

Fig. E
M281C1, R281C1
Series

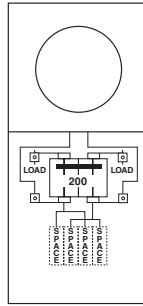

Fig. F
M282C1C
Parallel

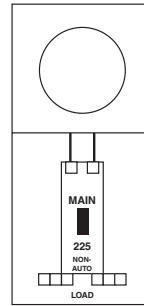

Fig. G
M285T
Series

Overhead Feed

Fig.	Model Number		Circuit Protection	Amps	Spaces	Wire Range*	Cabinet Size	Load Center	Unit Wt.	Std Pkg.	UL
	Ring Type	Ringless									
A	—	R200T ²	265A6249G1	200	—	AF	14 x 38	—	42	1	Y
B	M208CR2B010	—	TQDL or equivalent, THQL1120	200	7	AN	14 x 38	LC1212PC	50		
C	M254C	—	TQDL or equivalent, THQL2150	200	2	S	14 x 38	LC88PC	40		
D	M280TM1 ²	R280T ^{2,4}	265A6249G10	200	0	BD	9 x 32	—	32		
E	M281C1	R281C1	THQMV200WLBP	200	4	BK	9 x 30	LCTL + LCBS	26		
F	M282C1C ¹	—	THQMV200WLBP	200	4	BJ	9 x 30	LCTL + LCBS	26		
G	M285T ^{2,3}	—	CBT2201N	200	0	BD	9 x 32	—	27		

¹ Copper wired.

² "Triple-Tap" – 3 load lugs per phase.

³ 225A non-auto switch, no circuit protection.

⁴ Available with earth burial post – R280TP6HP.

* Wire Range Table on pages 1-24-1-25.

Unmetered

Surface, 100 – 125 Amps, 120/240V

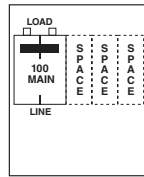

Fig. A
U101C
 Series

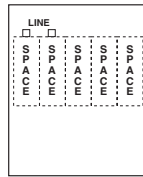

Fig. B
U102E
 Parallel

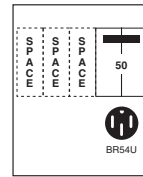

Fig. C
U354C
 Series

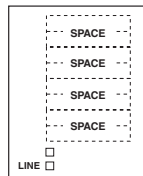

Fig. D
UL412RMW
 Parallel

Fig.	Model Number	Circuit Protection	Amps	Spaces	Wire Range*	Cabinet Size	Load Center	Unit Wt.	Std Pkg.	UL
A	U101C	THQL21100	100	3	Z	9 x 17	LC55N1	15	1	Y
B	U102E	—	100	5	V	9 x 17	LC55N1	15		Y
C	U354C	THQL2150	100	3	V	9 x 17	LC55N1	16		UL US
D	UL412RMW ¹	—	125	4/8	VB	7 x 10	425D549P1	7		Y

¹ (4) 1" spaces or (8) 1/2" spaces available.
 * Wire Range Table on page 1-26.

Unmetered

Surface, 150 – 200 Amps , 120/240V

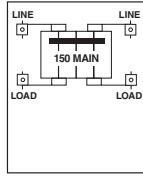

Fig. A
U180C1
Series

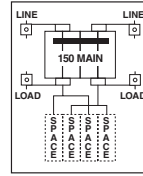

Fig. B
U181C1
Series/Parallel

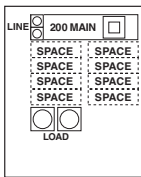

Fig. C
U208C
Series

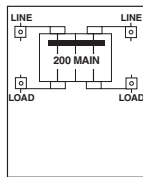

Fig. D
U280C1
Series/Parallel

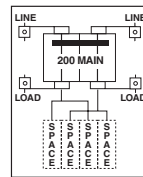

Fig. E
U281C1
Series/Parallel

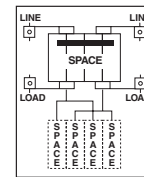

Fig. F
U281E1
Series/Parallel

Fig.	Model Number	Circuit Protection	Amps	Spaces	Wire Range*	Cabinet Size	Load Center	Unit Wt.	Std Pkg.	UL
A	U180C1	THQMV150WLBP	150	—	AW	9 x 21	LCTL + LCBNS	15	1	
B	U181C1 ¹	THQMV150WLBP	150	4	AX	9 x 21	LCTL + LCBS	21		Y
C	U208C	TQDL or equivalent	200	8	AN	14 x 21	LC1212PC	30		
D	U280C1 ¹	THQMV200WLBP	200	0	BF	9 x 21	LCTL + LCBNS	18.2		Y
E	U281C1 ¹	THQMV200WLBP	200	4	BG	9 x 21	LCTL + LCBS	18.7		
F	U281E1 ¹	—	200	5	BG	9 x 21	LCTNL + LCBS	—		Y

¹ Series or parallel wired.

* Wire Range Table on pages 1-24-1-25.

All-In-One

400 Amps

- Rated as service equipment (Panelboard No. 67 and Meter Sockets No. 414)
- Units supplied with factory installed main breakers rated 22kAIC where applicable
- Units available with or without load center with 8 circuit models being standard. Other configurations available, consult manufacturer.
- Load centers are provided with copper bus, 22kAIC bus bracing, and 100% neutral terminations. Feed-through lugs provided on load centers with main breakers.
- 320A continuous duty meter socket available in ring type, K-4 bolt on, or ringless (lever bypass)
- All terminals accept copper or aluminum wire for added installation flexibility
- Utility meter socket compartment has barrier from main circuit breakers for utility power protection
- Factory installed flange for easy semi-flush or surface installation
- NEMA 3R weatherproof enclosures
- G90 galvanized steel construction for superior corrosion protection
- Durable polyester powder coat finish resists chipping and fading
- Underground feed only, series wired, 240V single phase, and branch circuits accept combinations up to 200A
- Fifth jaw optional - order Model # MS5MIL
- Line side 1/2" stud termination provided, however, crimp-on/connector lug not provided by Midwest
- Bottom feed only – no hub provision

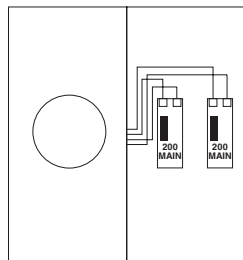

Fig. A
MS45500C
THQD22200WL

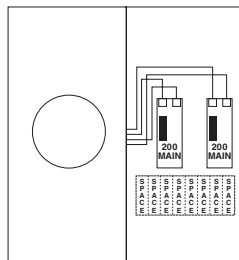

Fig. B
MS45508C
THQD22200WL

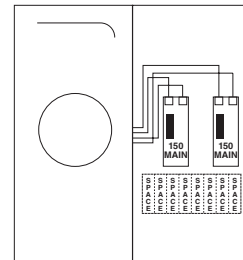

Fig. C
RS43308C, RS43308CGP
THQD22150WL

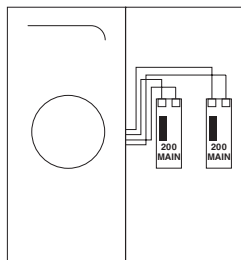

Fig. D
RS45500C, RS45500CAEP
THQD22200WL

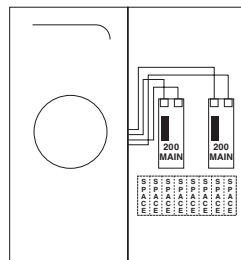

Fig. E
RS45508C, RS45508CGP, RS45508CAEP
THQD22200WL

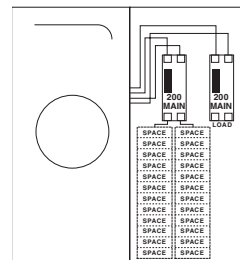

Fig. F
RS45524CFMG

Fig.	Model Number		Circuit Protection		OCP Device Rating (Amps)		Amps	Spaces (Max. 1")	Wire Range*	Cabinet Size	Hub Opening	Load Center	Unit Wt.	Std Pkg.	UL and Utility Approved
	Ring Type	Ringless – Lever Bypass	1	2	1	2									
A	MS45500C	—	THQD22200WL	THQD22200WL	200	200	400	—	400 Amps	31 x 33	N	—	95	1	UL
B	MS45508C	—	THQD22200WL	THQD22200WL	200	200	400	8				8 Circuits	99		
C	—	RS43308C, RS43308CGP	THQD22150WL	THQD22150WL	150	150	400	8				8 Circuits	99		UL, GP
D	—	RS45500C, RS45500CAEP	THQD22200WL	THQD22200WL	200	200	400	—				—	95		UL, AEP
E	—	RS45508C, RS45508CAEP, RS45508CGP	THQD22200WL	THQD22200WL	200	200	400	8				8 Circuits	99		UL, AEP, GP
F	—	RS45524CFMG	—	—	—	—	400	24				ZB	—		45

* Wire Range Table on page 1-26.

Data subject to change without notice.

Metered

Pedestal, 100 Amps, 120/240V

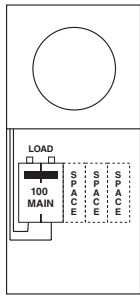

Fig. A
M101CP6, R101CP6
Series

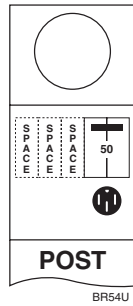

Fig. B
M354CP6
Series

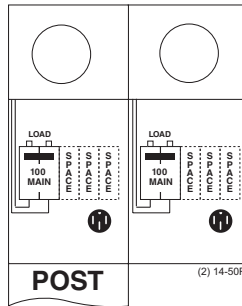

Fig. C
M101CB6, R101CB6
Series

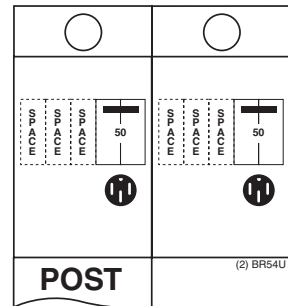

Fig. D
M354CB6
Series

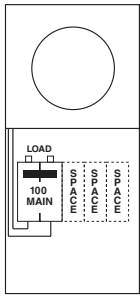

Fig. E
M101CP6HP, R101CP6HP
Series

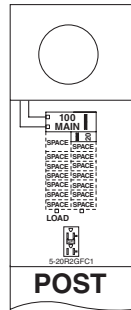

Fig. F
M108CP6HP010
Series

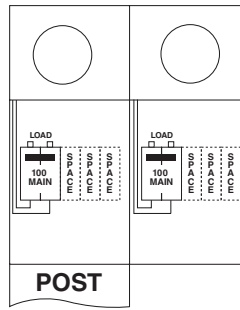

Fig. G
M101CB6HP, R101CB6HP
Series

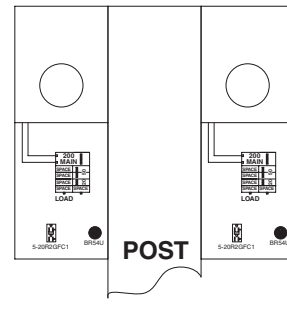

Fig. H
R255CB6010
Series

Inline Post

Fig.	Model Number		Circuit Protection	Amps	Spaces	Wire Range*	Cabinet Size	Load Center	Unit Wt.	Std Pkg.	UL
	Ring Type	Ringless									
A	M101CP6 ^{1,2}	R101CP6 ³	THQL21100	100	3	T2	9PT	LC55N1	59	1	Y
B	M354CP6	—	THQL2150	100	3	AS	9PT	LC55N1	59		

Back-to-Back Inline Post

Fig.	Model Number		Circuit Protection	Amps	Spaces	Wire Range*	Cabinet Size	Load Center	Unit Wt.	Std Pkg.	UL
	Ring Type	Ringless									
C	M101CB6	R101CB6	THQL21100	100	3	T2	9PT	LC55N1	82	1	Y
D	M354CB6	—	THQL2150	100	3	AT	9PT	LC55N1	82		

Head Post

Fig.	Model Number		Circuit Protection	Amps	Spaces	Wire Range*	Cabinet Size	Load Center	Unit Wt.	Std Pkg.	UL
	Ring Type	Ringless									
E	M101CP6HP ⁴	R101CP6HP	THQL21100	100	3	S	9HP	LC55N1	80	1	Y
F	M108CP6HP010	—	THQL1120GFT	100	14	U	9HP	—	78		

Back-to-Back Head Post

Fig.	Model Number		Circuit Protection	Amps	Spaces	Wire Range*	Cabinet Size	Load Center	Unit Wt.	Std Pkg.	UL
	Ring Type	Ringless									
G	M101CB6HP	R101CB6HP	THQL21100	100	3	S	9HP	LC55N1	110	1	Y
H	—	R255CB6010	TQDL or equivalent, THQL2150, THQL1120	100	5	S	14PT	LC1212PC	101		N

¹ Available in Ring Type, pad mount - M101CP4.

² Available in Ring Type, copper wire - M101CP6C.

³ Available in Ringless Type, pad mount - R101CP4.

⁴ Available with GFCI duplex receptacle in Ring Type only - M101CP6HP010.

* Wire Range Table on pages 1-24-1-26.

Metered

Pedestal, 200 Amps, 120/240V

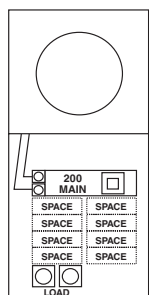

Fig. A
M208CP6HP, R208CP6HP
Series

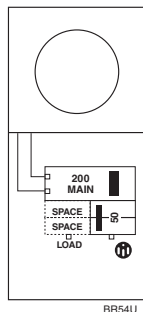

Fig. B
M254CP6
Series

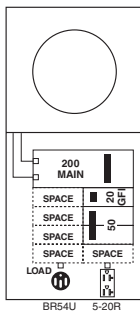

Fig. C
M255GP6
Series

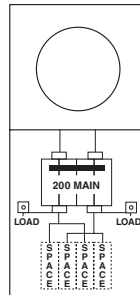

Fig. D
R2502CP6
Parallel

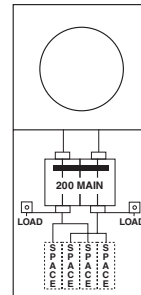

Fig. E
M281C1P6H, R281C1P6H
Series

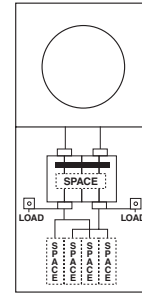

Fig. F
M281E1P6H, R281E1P6H
Series

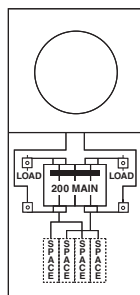

Fig. G
M282C1P6H, R282C1P6H
Parallel

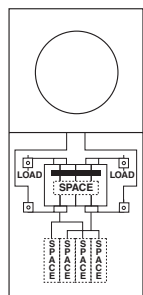

Fig. H
M282E1P6H, R282E1P6H
Parallel

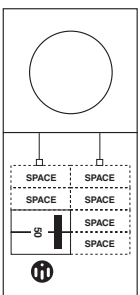

Fig. I
M654CP6
Parallel

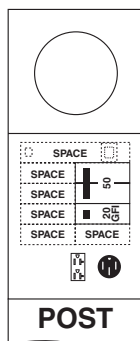

Fig. J
M655GP6
Parallel

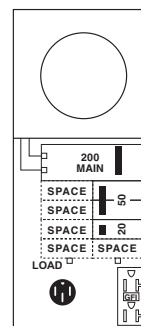

Fig. K
R255CP6010
BR54U, 5-20R2GFCI

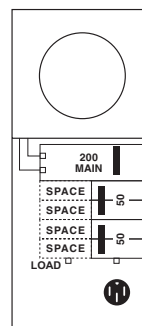

Fig. L
R225CP6
BR54U

Inline and Head Post

Fig.	Model Number		Circuit Protection	Amps	Spaces	Wire Range*	Cabinet Size	Load Center	Unit Wt.	Std Pkg.	UL
	Ring Type	Ringless									
A	M208CP6HP	R208CP6HP	TQDL or equivalent	200	8	S	14HP	LC1212PC	85	1	Y
B	M254CP6 ¹	—	TQDL or equivalent, THQL2150	200	2	S	14PT	LC88PC	96		
C	M255GP6 ¹	—	TQDL or equivalent, THQL2150, GFI120	200	5	S	14PT	LC1212PC	87		
D	—	R2502CP6	THQMV200WLBP	200	4	BM	9PT	LCTL + LCBS	53		
E	M281C1P6H ^{2,3,4,5}	R281C1P6H ⁴	THQMV200WLBP	200	4	S	6H	LCTNL + LCBS	68		
F	M281E1P6H	R281E1P6H	—	200	5	S	6H	LCTNL + LCBS	67		
G	M282C1P6H ^{2,3,6}	R282C1P6H	THQMV200WLBP	200	4	S	6H	LCTNL + LCBS	69		
H	M282E1P6H ²	R282E1P6H	—	200	5	S	6H	LCTNL + LCBS	68		
I	M654CP6 ¹	—	THQL2150	200	6	S	14PT	LC88PC	85		
J	M655GP6 ¹	—	THQL2150, GFI120	200	9	S	14PT	LC1212PC	85		
K	—	R255CP6010	TQDL or equivalent, THQL2150, THQL1120	200	5	S	14PT	LC1212PC	88		
L	—	R225CP6	TQDL or equivalent, THQL2150	200	4	ZZ	14PT	LC1212PC	88		

¹ Rated as Temporary Site Service Equipment.

² Available with GFCI Receptacle installed - M281C1P6H010, M282C1P6H010 and M282E1P6H010.

³ Available in Ring Type with stud termination - M281C1S6H and M282C1S6H.

⁴ Available in Ring Type with stud termination and copper wire - M281C1S6HC and R281C1S6HC.

⁵ Available with foot base factory installed - M281C1P6HFB.

⁶ Available in Ring Type with copper wire - M282C1P6HC.

* Wire Range Table on pages 1-25-1-26.

Data subject to change without notice.

Metered

Pedestal, 200 Amps, 120/240V

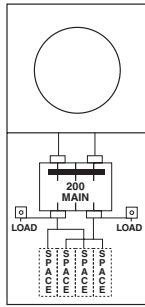

Fig. A
M281C1B6H, R281C1B6H
Series

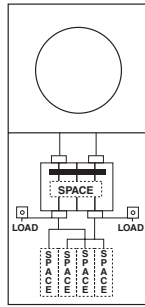

Fig. B
M281E1B6H, R281E1B6H
Series

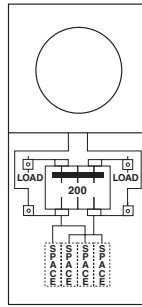

Fig. C
M282C1B6H, R282C1B6H
Series

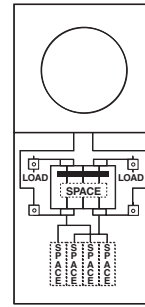

Fig. D
M282E1B6H, R282E1B6H
Series

Back-to-Back Head Post

Fig.	Model Number		Circuit Protection	Amps	Spaces	Wire Range*	Cabinet Size	Load Center	Unit Wt.	Std Pkg.	UL
	Ring Type	Ringless									
A	M281C1B6H	R281C1B6H	THQMV200WLBP	200	4	S	6H	LCTNL + LCBS	101	1	Y
B	M281E1B6H	R281E1B6H	—	200	5						
C	M282C1B6H	R282C1B6H	THQMV200WLBP	200	4						
D	M282E1B6H	R282E1B6H	—	200	5						

Unmetered

Pedestal, 100 – 200 Amps, 120/240V

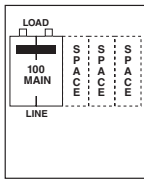

Fig. E
U101CP6
Series

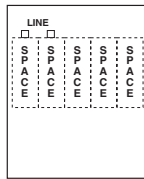

Fig. F
U102EP6
Parallel

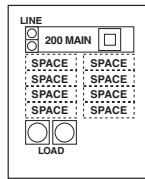

Fig. G
U208CP6HP
Series

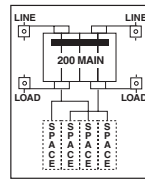

Fig. H
U281C1P6H
Series

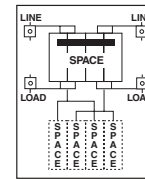

Fig. I
U281E1P6H
Series

Fig.	Model Number	Circuit Protection	Amps	Spaces	Wire Range*	Cabinet Size	Load Center	Unit Wt.	Std Pkg.	UL
E	U101CP6	THQL21100	100	3	T2	9PT	LC55N1	46	1	Y
F	U102EP6	—	100	5	V	9PT	LC55N2			

Fig.	Model Number	Circuit Protection	Amps	Spaces	Wire Range*	Cabinet Size	Load Center	Unit Wt.	Std Pkg.	UL
G	U208CP6HP	TQDL or equivalent	200	8	S	14HP	LC1212PC	80	1	Y
H	U281C1P6H	THQMV200WLBP	200	4	S	6H	LCTL + LCBS			
I	U281E1P6H	—	200	5	S	6H	LCTNL + LCBS			

* Wire Range Table on pages 1-25-1-26.

Metered Lever Bypass

Pedestal, Ringless, Surface, 100 – 200 Amps, 120/240V

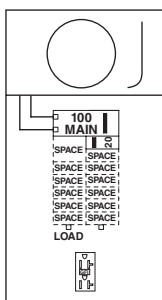

Fig. A
R108CP6HP034
Series

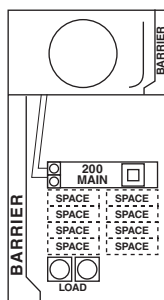

Fig. B
R208CR2A034
Series

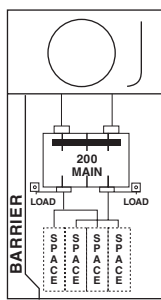

Fig. C
R281CB1034
Series

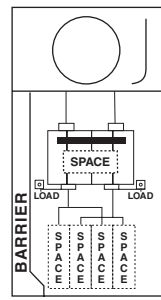

Fig. D
R281EB1034
Series

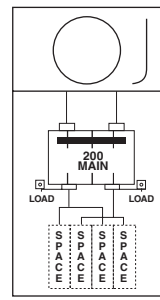

Fig. E
R281C1034
Series

Underground Feed

Fig.	Model Number	Circuit Protection	Amps	Spaces	Phase	Wire Range*	Cabinet Size	Load Center	Unit Wt.	Std Pkg.	UL
A	R108CP6HP034	THQL21100	100	12	1	BH	14 x 34	—	79	1	Y

Overhead and Underground Feed

Fig.	Model Number	Circuit Protection	Amps	Spaces	Phase	Wire Range*	Cabinet Size	Load Center	Unit Wt.	Std Pkg.	UL
B	R208CR2A034 ¹	TQDL or equivalent	200	8	1	BK	14 x 32	LC1212PC	38.4	1	Y
C	R281CB1034	THQMV200WLBP	200	4	1	BK	14 x 32	LCTL + LCBS			
D	R281EB1034 ²	—	200	4	1	BK	14 x 32	LCTL + LCBS			

Overhead Feed

Fig.	Model Number	Circuit Protection	Amps	Spaces	Phase	Wire Range*	Cabinet Size	Load Center	Unit Wt.	Std Pkg.	UL
E	R281C1034	THQMV200WLBP	200	4	1	BK	14 x 32	LCTL + LCBS	38.4	1	Y

¹ Loop feed lugs installed.

² Double latch on meter cover required by some utilities – R281EB1034L.

* Wire Range Table on page 1-25.

Metered Lever Bypass

Pedestal, Ringless, 200 - 400 Amps, 120/240V

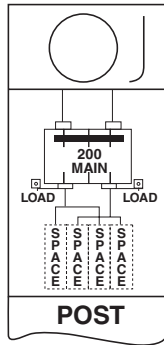

Fig. A
R281C1P6H034
Series

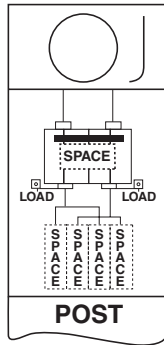

Fig. B
R281E1P6H034
Series

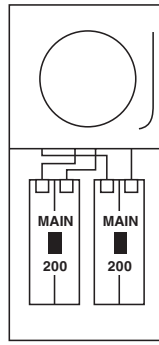

Fig. C
R455CP6034
Series

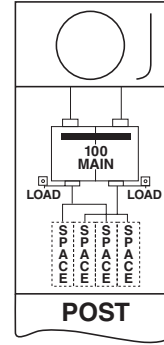

Fig. D
R481C1P6H034
Series

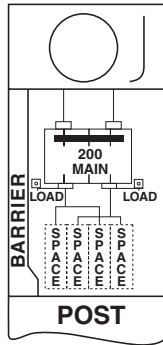

Fig. E
R281C1B6H034
Series

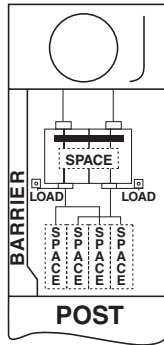

Fig. F
R281E1B6H034
Series

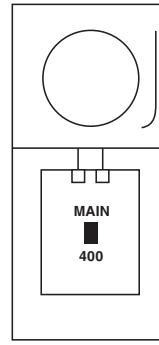

Fig. G
R400P6034
Series

Single-Sided

Fig.	Model Number	Circuit Protection	Amps	Spaces	Phase	Wire Range*	Cabinet Size	Load Center	Unit Wt.	Std Pkg.	UL
A	R281C1P6H034	THQMV200WLBP	200	4	1	S	6H034	LCTL + LCBS	83.5	1	Y
B	R281E1P6H034	—	200	4		S	6H034	LCTL + LCBS	83.5		
C	R455CP6034	(2) TQDL or equivalent	400	0		VA	13x21	—	60.5		
D	R481C1P6H034 ^{1,2}	THQL21100	200	4		S	6H034	LCTL + LCBS	83.5		

Back-to-Back

Fig.	Model Number	Circuit Protection	Amps	Spaces	Phase	Wire Range*	Cabinet Size	Load Center	Unit Wt.	Std Pkg.	UL
E	R281C1B6H034	THQMV200WLBP	200	4	1	S	6H034	LCTL + LCBS	114	1	Y
F	R281E1B6H034	—									

Without Breaker

Fig.	Model Number	Circuit Protection	Amps	Spaces	Phase	Wire Range*	Cabinet Size	Load Center	Unit Wt.	Std Pkg.	UL
G	R400P6034	—	400		1	SS	13x64	—	79	1	Y

All lever bypass models include a fifth jaw in the "nine o'clock" position as of 2004.

¹ R481C1P6H034 rated at 100A and 10kAIC (100A Breaker, 200A Meter Socket).

² Available in camo green paint – add "G" after model number.

* Wire Range Table on pages 1-25-1-26.

Data subject to change without notice.

Technical Data

Model Number	Replacement Parts		Cabinet Size	Enclosure Style ²	Cabinet Dimensions (inches)			Knockout Figure ³	Hub	kAIC	
	Meter Socket	Post Lugs			Height (A)	Width (B)	Depth (C)				
M100C	MSM100930	—	9 x 30	C	30	9-3/4	5-3/16	3	Y	10	
M100T	MSM100930	—	9 x 30	C	30	9-3/4	5-3/16	3	Y	10	
M101C	MSM100930	—	9 x 30	C	30	9-3/4	5-3/16	3	Y	10	
M101CC	MSM100930	—	9 x 30	C	30	9-3/4	5-3/16	3	Y	10	
M101CB2	MW200M	—	14 x 26	D	26-1/4	14-1/4	4-9/16	6	Y	10	
M101CB6	MSM100P9	LT100B350	9PT	See page 1-21						Y	10
M101CB6HP	MSM100P9	LT200B350	9HP	See page 1-21						N	10
M101CP4	MSM100P9	LT100B350	9PT	See page 1-21						N	10
M101CP6	MSM100P9	LT100S350	9PT	See page 1-21						N	10
M101CP6C	MSM100P9	LT200B350	9PT	See page 1-21						N	10
M101CP6HP	MSM100P9	LT100S350	9HP	See page 1-21						N	10
M101CP6HP010	MSM100P9	LT200S350	9HP	See page 1-21						N	10
M102CB2	MW200M	—	14 x 26	D	26-1/4	14-3/4	4-9/16	6	Y	10	
M102CB2010	MW200M	—	14 x 26	D	26-1/4	14-3/4	4-9/16	6	Y	10	
M102E	MSM100930	—	9 x 30	C	30	9-3/4	5-3/16	3	Y	10	
M108CP6HP010	MW200M	LT200S350	14HP	See page 1-21						N	10
M181CB1	MSMS1 ¹	—	14 x 28	D	28-5/8	14-3/8	4-3/4	6	Y	22	
M181CB1GP	MSMS1 ¹	—	14 x 28	D	28-5/8	14-3/8	4-3/4	6	Y	22	
M208CP6HP	MW200M	LT200S350	14HP	See page 1-21						N	10
M208CR2A	MW200M	—	14 x 28	C	28-5/8	14-3/8	6-3/8	8	Y	10	
M208CR2B	MW200M	—	14 x 28	C	28-5/8	14-3/8	6-3/8	8	Y	10	
M208CR2B010	MW200M	—	14 x 38	C	38-3/8	14-3/4	6-3/8	8	Y	10	
M254C	MW200M	—	14 x 38	C	38	14-3/4	6-3/8	8	Y	10	
M254CP6	MW200M	LT200S350	14PT	See page 1-21						N	10
M255GP6	MW200M	LT200S350	14PT	See page 1-21						N	10
M280TM1	MW200M	—	9 x 32	C	32-1/4	9-3/4	5-11/16	4	Y	10	
M281C1	MSMS	—	9 x 30	D	30-1/4	9-5/16	4-3/4	12	Y	22	
M281C1B6H	MSMP	LT200B350	6H	See page 1-22						N	22
M281C1P6H	MSMP	LT200S350	6H	See page 1-22						N	22
M281C1P6H010	MSMP	LT200S350	6H	See page 1-22						N	22
M281C1P6HFB	MSMP	LT200S350	6H	See page 1-22						N	22
M281C1S6H	MSMP	LT200SS	6H	See page 1-22						N	22
M281C1S6HC	MSMP	LT200SS	6H	See page 1-22						N	22
M281CB1	MSMS1 ¹	—	14 x 28	D	28-5/8	14-3/8	4-3/4	13	Y	22	
M281CB1GP	MSMS1 ¹	—	14 x 28	D	28-5/8	14-3/8	4-3/4	13	Y	22	
M281E1B6H	MSMP	LT200B350	6H	See page 1-22						N	22
M281E1P6H	MSMP	LT200S350	6H	See page 1-22						N	22
M281EB1	MSMS1 ¹	—	14 x 28	D	30-1/4	9-5/16	4-3/4	13	Y	22	
M282C1B6H	MSMP	LT200B350	6H	See page 1-22						N	22
M282C1C	MSMS	—	9 x 30	D	30-1/4	9-5/16	4-3/4	12	Y	22	
M282C1P6H	MSMP	LT200S350	6H	See page 1-22						N	22
M282C1P6H010	MSMP	LT200S350	6H	See page 1-22						N	22
M282C1P6HC	MSMP	LT200S350	6H	See page 1-22						N	22
M282C1S6H	MSMP	LT200SS	6H	See page 1-22						N	22
M282CB1	MSMS	—	14 x 28	D	28-5/8	14-3/8	4-3/4	13	Y	22	
M282CB1C	MSMS	—	14 x 28	D	28-5/8	14-3/8	4-3/4	13	Y	22	
M282E1B6H	MSMP	LT200B350	6H	See page 1-22						N	22
M282E1P6H	MSMP	LT200S350	6H	See page 1-22						N	22
M282E1P6H010	MSMP	LT200S350	6H	See page 1-22						N	22
M282EB1	MSMS	—	14 x 28	D	28-5/8	14-3/8	4-3/4	13	Y	22	
M285T	MW200M	—	9 x 32	C	32-1/4	9-3/4	5-11/16	4	Y	10	
M354C	MSM100930	—	9 x 30	C	30	9-3/4	5-3/16	1	Y	10	
M354CB6	MSM100P9	LT100B350	9PT	See page 1-21						N	10
M354CP6	MSM100P9	LT100S350	9PT	See page 1-21						N	10
M654CP6	MW200M	LT200S350	14PT	See page 1-21						N	10
M655GP6	MW200M	LT200S350	14PT	See page 1-21						N	10
MS125E	MW200M	—	16 x 17	E	17-1/4	16-3/4	5	9	Y	10	

1 Models prior to April 2004 use MSMS.

3 Knockout Figures on pages 1-19–1-20.

2 Enclosure Styles on page 1-19.

Data subject to change without notice.

Technical Data

Model Number	Replacement Parts		Cabinet Size	Enclosure Style ²	Cabinet Dimensions (inches)			Knockout Figure ³	Hub	kAIC
	Meter Socket	Post Lugs			Height (A)	Width (B)	Depth (C)			
MS150C	MW200M	—	16 x 17	E	17-1/4	16-3/4	5	9	Y	10
MS150CGP	MW200M	—	16 x 17	E	17-1/4	16-3/4	5	9	Y	10
MS151C	MW200M	—	17 x 26	E	17-1/4	16-3/4	5	9	Y	10
MS2453C	—	—	14 x 31	E	33	16-3/4	6-1/4	17	Y	22
MS250C	198B8601G11	—	16 x 17	E	17-1/4	16-3/4	5	9	Y	10
MS250CGP	198B8601G11	—	16 x 17	E	17-1/4	16-3/4	5	9	Y	10
MS251C	MW200M	—	17 x 26	E	26-1/4	17-1/2	5-1/2	10	Y	10
MS252C	MW200M	—	17 x 26	E	26-1/4	17-1/2	5-1/2	10	Y	10
MS252E014	MW200M	—	14 x 31	E	14-3/4	31-5/16	5-7/8	7B	Y	10
MS45500C	265A5264P2	—	31 x 33	E	33-1/10	30-1/2	6-1/10	See page 1-20	N	22
MS45508C	265A5264P2	—	31 x 33	E	33-1/10	30-1/2	6-1/10	See page 1-20	N	22
R100C	MSR100930	—	9 x 30	C	30	9-3/4	5-3/16	3	Y	10
R100T	MSR100930	—	9 x 30	C	30	9-3/4	5-3/16	3	Y	10
R101C	MSR100930	—	9 x 30	C	30	9-3/4	5-3/16	3	Y	10
R101CB2	MW200R	—	14 x 26	D	26-1/4	14-3/4	4-9/16	6	Y	10
R101CB2ETG	MW200R	—	14 x 26	D	26-1/4	14-3/4	4-9/16	6	Y	10
R101CB2LK	MW200R	—	14 x 26	D	26-1/4	14-3/4	4-9/16	6	Y	10
R101CB2010	MW200R	—	14 x 26	D	26-1/4	14-3/4	4-9/16	6	Y	10
R101CB6	MSR100P9	LT100B350	9PT		See page 1-21				N	10
R101CB6HP	MSR100P9	LT200B350	9HP		See page 1-21				N	10
R101CP4	MSR100P9	LT100S350	9PT		See page 1-21				N	10
R101CP6	MSR100P9	LT100S350	9PT		See page 1-21				N	10
R101CP6HP	MSR100P9	LT200S350	9HP		See page 1-21				N	10
R102CB2	MW200R	—	14 x 26	D	26-1/4	14-3/4	4-9/16	6	Y	10
R102CB2LK	MW200R	—	14 x 26	D	26-1/4	14-3/4	4-9/16	6	Y	10
R102E	MSR100930	—	9 x 30	C	29-1/2	9-1/4	5-3/16	1	Y	10
R102EN	MSR100930	—	9 x 30	C	29-1/2	9-1/4	5-3/16	1	Y	10
R108CP6HP034	265A5264P8	265A6216G65	14 x 83		See page 1-22				N	10
R158CR2TLFMG	198B8601G90	—	14 x 32	D	31-4/5	14-1/2	4-7/10	18	Y (2)	22
R181CB1	MSRS	—	14 x 28	D	28-1/2	14-3/10	4-4/5	6	Y	10
R181CB1GP	MSRS	—	14 x 28	E	31-7/10	14-1/2	4-8/10	6	Y	22
R200T	MW200R	—	14 x 38	C	38-3/8	14-3/4	6-3/8	8	Y	10
R208CP6HP	MW200R	LT200S350	14HP		See page 1-21				N	10
R208CR2A	MW200R	—	14 x 28	C	28-5/8	14-3/4	6-3/8	8	Y (2)	10
R208CR2AETG	MW200R	—	14 x 28	C	28-5/8	14-3/4	6-3/8	8	Y (2)	10
R208CR2A034	265A5264P8	—	14 x 28	C	28-5/8	14-3/4	6-3/8	8	Y	10
R208CR2TLFMG	198B8601G90	—	14 x 32	D	31-4/5	14-1/2	4-7/10	18	Y (2)	22
R225CP6	—	—	14PT		See page 1-21				N	10
R250CGP	MSRS	—	9PT ¹		See page 1-21				N	10
R2502CP6	MSRS	—	9PT ¹		See page 1-21				N	10
R255CB6010	MSR20014	LT200S350	14PT		See page 1-21				Y	10
R255CP6010	—	—	14PT		See page 1-21				—	—
R256EB1A	198B8601G70	—	14 x 26	D	26-1/4	14-3/4	4-9/16	6	Y	10
R256EB1AETG	198B8601G70	—	17 x 26	D	26-1/10	17-1/2	4-8/10	6	Y	10
R256EB1FMG	198B8601G70	—	14 x 26	D	26-1/4	14-3/4	4-9/16	6	Y	10
R256EB1NA	198B8601G70	—	14 x 26	D	26-1/4	14-3/4	4-9/16	6	Y	10
R256EB1NAETG	198B8601G70	—	14 x 26	D	26-1/4	14-3/4	4-9/16	6	Y	10
R256EB1NFMG	198B8601G70	—	14 x 26	D	26-1/4	14-3/4	4-9/16	6	Y	10
R256EB1018A	198B8601G70	—	14 x 26	D	26-1/4	14-3/4	4-9/16	6	Y	10
R256EB118AETG	198B8601G70	—	17 x 26	D	26-1/10	17-1/2	4-8/10	6	Y	10
R256EB118FMG	198B8601G70	—	14 x 26	D	26-1/4	14-3/4	4-9/16	6	Y	10
R280T	MW200R	—	9 x 32	C	32-1/4	9-3/4	5-11/16	4	Y	10
R280TP6HP	MW200R	LT200S350	9HP		See page 24				N	10
R281C1	MSRS	—	9 x 30	D	30-1/4	9-5/16	4-3/4	12	Y	22
R281C1034	265A5264P8	—	14 x 32	D	32-1/2	14-1/2	5-7/16	15	Y	22
R281C1B6H	MSRP	LT200B350	6H		See page 1-22				N	22
R281C1B6H034	265A5264P8	LT200B350	6H034		See page 1-22				N	22

¹ Not all models listed. Contact local representative for other models and details.

² Enclosure Styles on page 1-19.

³ Knockout Figures on pages 1-19–1-20.

Data subject to change without notice.

Technical Data

Model Number	Replacement Parts		Cabinet Size	Enclosure Style ¹	Cabinet Dimensions (inches)			Knockout Figure ²	Hub	kAIC
	Meter Socket	Post Lugs			Height (A)	Width (B)	Depth (C)			
R281C1P6H	MSRP	LT200S350	6H		See page 1-22				N	22
R281C1P6H034	265A5264P8	LT200S350	6H034		See page 1-22				N	22
R281C1S6HC	MSRP	LT200SS	6H		See page 1-22				N	22
R281CB1	MSRS	—	14 x 28	D	28-5/8	14-3/8	4-3/4	13	Y	22
R281CB1034	265A5264P8	—	14 x 28	D	28-5/8	14-3/8	4-3/4	13	Y	22
R281CB1AEP	MSRS	—	14 x 28	D	28-5/8	14-3/8	4-3/4	13	Y	22
R281CB1ETG	MSRS	—	14 x 28	D	28-1/2	17-1/2	4-8/10	13	Y	22
R281CB1GP	MSRS	—	14 x 28	E	31-7/10	14-1/2	4-8/10	6	Y	22
R281CB1LK	MSRS	—	14 x 28	D	28-5/8	14-3/8	4-3/4	13	Y	22
R281E1B6H	MSRP	LT200B350	6H		See page 1-22				N	22
R281E1B6H034	265A5264P8	LT200B350	6H034		See page 1-22				N	22
R281E1P6H	MSRP	LT200S350	6H		See page 1-22				N	22
R281E1P6H034	265A5264P8	LT200S350	6H034		See page 1-22				N	22
R281EB1	MSRS	—	14 x 28	D	28-5/8	14-3/8	4-3/4	13	Y	22
R281EB1034	265A5264P8	—	14 x 28	D	28-5/8	14-3/8	4-3/4	13	Y	22
R282C1B6H	MSRP	LT200B350	6H		See page 1-22				N	22
R282C1P6H	MSRP	LT200S350	6H		See page 1-22				N	22
R282CB1	MSRS	—	14 x 28	D	28-5/8	14-3/8	4-3/4	13	Y	22
R282CB1LK	MSRS	—	14 x 28	D	28-5/8	14-3/8	4-3/4	13	Y	22
R282E1B6H	MSRP	LT200B350	6H		See page 1-22				N	22
R282E1P6H	MSRP	LT200S350	6H		See page 1-22				N	22
R282EB1	MSRS	—	14 x 28	D	28-5/8	14-3/8	4-3/4	13	Y	22
R283CB1	—	—	14 x 28	D	28-5/8	14-3/8	14-3/8	6	Y	22
R283CB1AP	—	—	14 x 28	D	28-5/8	14-3/8	14-3/8	6	Y	22
R400P6034	265A5264P10	—	13 x 64		See page 1-23				N	10
R455CP6034	265A5264P10	—	13 x 21		See page 1-22				N	10
R481C1P6H034	265A5264P8	LT200S350	6H034		See page 1-22				N	22
RS150C	MW200R	—	17 x 26	E	26-1/4	17-1/2	5-1/2	10	Y	10
RS150CGP	MW200R	—	19 x 19	E	18-7/10	18-9/10	5-1/10	9	Y	10
RS250C	MW200R	—	17 x 26	E	26-1/4	17-1/2	5-1/2	10	Y	10
RS250CGP	MW200R	—	19 x 19	E	18-7/10	18-9/10	5-1/10	9	Y	10
RS251C	MW200R	—	17 x 26	E	26-1/4	17-1/2	5-1/2	10	Y	10
RS43308C	265A5264P10	—	31 x 33	E	33-1/10	30-1/2	6-1/10	See page 1-20	N	22
RS43308CGP	265A5264P10	—	31 x 33	E	33-1/10	30-1/2	6-1/2	16	Y	22
RS45500C	265A5264P10	—	31 x 33	E	33-1/10	30-1/2	6-1/10	See page 1-20	N	22
RS45508C	265A5264P10	—	31 x 33	E	33-1/10	30-1/2	6-1/10	See page 1-20	N	22
RS45500CAEP	265A5264P10	—	31 x 33	E	33-1/10	30-1/2	6-1/10	See page 1-20	N	22
RS45508CAEP	265A5264P10	—	31 x 33	E	33-1/10	30-1/2	6-1/2	16	Y	22
RS45508CGP	265A5264P10	—	31 x 33	E	33-1/10	30-1/2	6-1/2	16	Y	22
RS45524CFMG	265A5264P10	—	30 x 40	E	40-1/10	30-1/2	6-1/4	19	N	22
U101C	—	—	9 x 17	B	17-3/8	9-3/4	5-3/16	3	Y	10
U101CP6	—	LT100S350	9PT		See page 1-21				N	10
U102E	—	—	9 x 17	B	17-3/8	9-3/4	5-3/16	3	Y	10
U102EP6	—	LT100S350	9PT		See page 1-21				N	10
U180C1	—	—	9 x 21	A	21-3/4	9-5/16	4-3/4	11	Y	22
U181C1	—	—	9 x 21	A	21-3/4	9-5/16	4-3/4	11	Y	22
U208C	—	—	14 x 21	B	21-3/8	14-3/4	6-7/16	5	Y	10
U208CP6HP	—	LT200S350	14HP		See page 1-21				N	10
U280C1	—	—	9 x 21	A	21-3/4	9-5/16	4-3/4	11	Y	22
U281C1	—	—	9 x 21	A	21-3/4	9-5/16	4-3/4	11	Y	22
U281C1P6H	—	LT200S350	6H		See page 1-22				Y	22
U281E1	—	—	9 x 21	A	21-3/4	9-5/16	4-3/4	11	Y	22
U281E1P6H	—	LT200S350	6H		See page 1-22				Y	22
U354C	—	—	9 x 17	B	17-3/8	9-3/4	5-3/16	1	Y	10
UL412RMW	—	—	7 x 10	A	10	7-1/4	4	2	Y	10

¹ Enclosure Styles on page 1-19.

² Knockout Figures on pages 1-19–1-20.

Enclosure Styles / Cabinet Dimensions

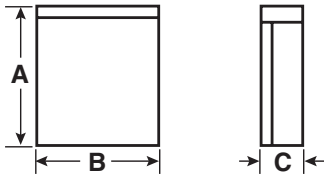

Fig. A

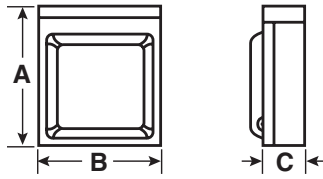

Fig. B

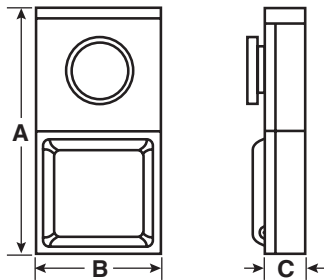

Fig. C

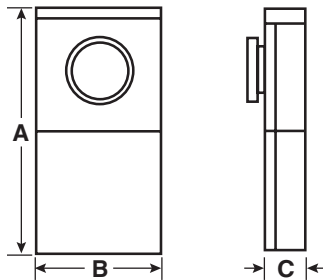

Fig. D

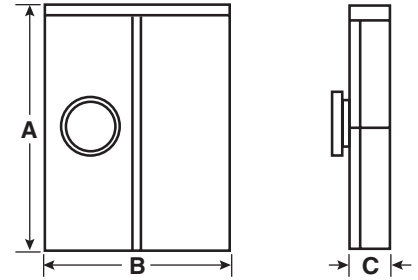

Fig. E

Knockout Configurations

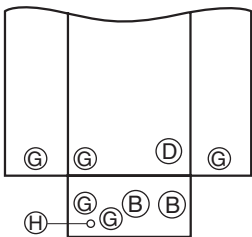

Fig. 1

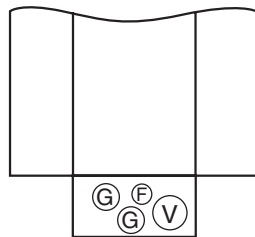

Fig. 2

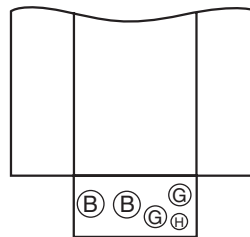

Fig. 3

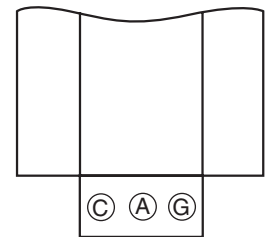

Fig. 4

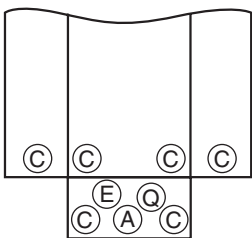

Fig. 5

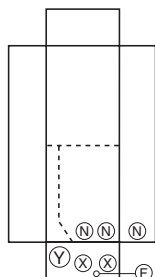

Fig. 6

Knockout Key

- A = 1-1/2", 2", 2-1/2"
- B = 1", 1-1/4", 1-1/2"
- C = 1-1/4", 1-1/2", 2"
- D = 3/4", 1", 1-1/4"
- E = 3/4"
- F = 1/2"
- G = 1/2", 3/4", 1"
- H = 9/32"
- L = 1/2", 3/4"
- N = 1/2", 3/4", 1", 1-1/4", 1-1/2", 2"

- P = 1-1/4", 1-1/2", 2", 2-1/2"
- Q = 1"
- S = 1/2", 3/4", 1", 1-1/4", 1-1/2"
- T = 3-1/2", 4"
- U = 1/2", 3/4", 1", 1-1/4", 1-1/2", 2", 2-1/2", 3"
- V = 3/4", 1", 1-1/4", 1-1/2"
- X = 1/2", 3/4", 1-1/4", 1-1/2", 2", 2-1/2"
- Y = 1-1/4", 1-1/2", 2", 2-1/2", 3"
- Z = 2-1/2", 3", 3-1/2", 4"

* Knockouts shown for size not for exact positions.

Data subject to change without notice.

Knockout Configurations

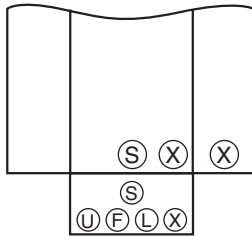

Fig. 7B

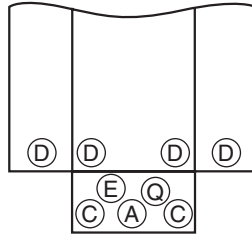

Fig. 8

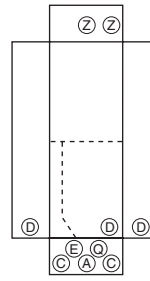

Fig. 8A

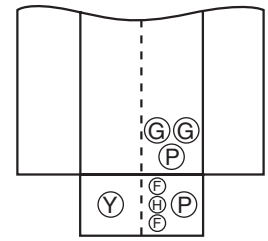

Fig. 9

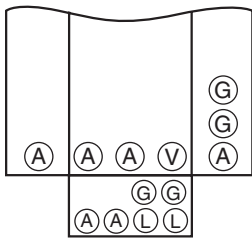

Fig. 10

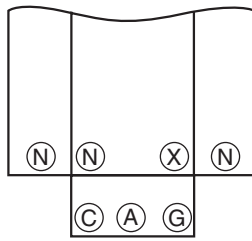

Fig. 11

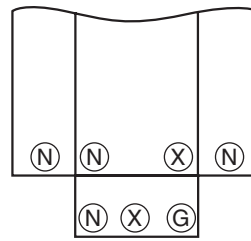

Fig. 12

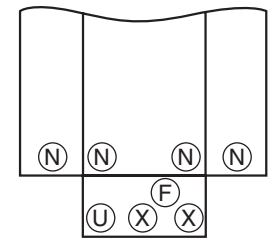

Fig. 13

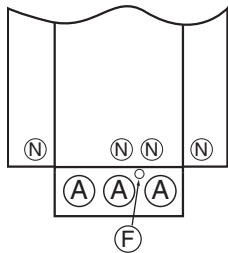

Fig. 15

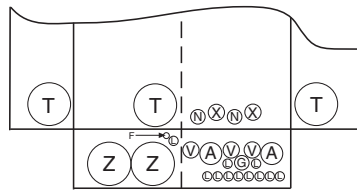

Fig. 16

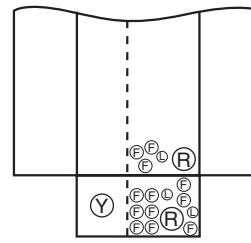

Fig. 17

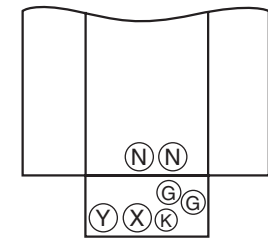

Fig. 18

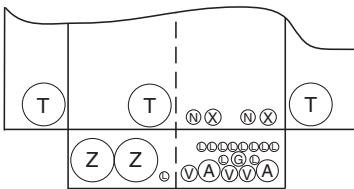

Fig. 19

Knockout Key

- A = 1-1/2", 2", 2-1/2"
- B = 1", 1-1/4", 1-1/2"
- C = 1-1/4", 1-1/2", 2"
- D = 3/4", 1", 1-1/4"
- E = 3/4"
- F = 1/2"
- G = 1/2", 3/4", 1"
- H = 9/32"
- L = 1/2", 3/4"
- N = 1/2", 3/4", 1", 1-1/4", 1-1/2", 2"
- P = 1-1/4", 1-1/2", 2", 2-1/2"
- Q = 1"
- S = 1/2", 3/4", 1", 1-1/4", 1-1/2"
- T = 3-1/2", 4"
- U = 1/2", 3/4", 1", 1-1/4", 1-1/2", 2", 2-1/2", 3"
- V = 3/4", 1", 1-1/4", 1-1/2"
- X = 1/2", 3/4", 1-1/4", 1-1/2", 2", 2-1/2"
- Y = 1-1/4", 1-1/2", 2", 2-1/2", 3"
- Z = 2-1/2", 3", 3-1/2", 4"

* Knockouts shown for size not for exact positions.

Post Dimensions

Earth Burial

9PT

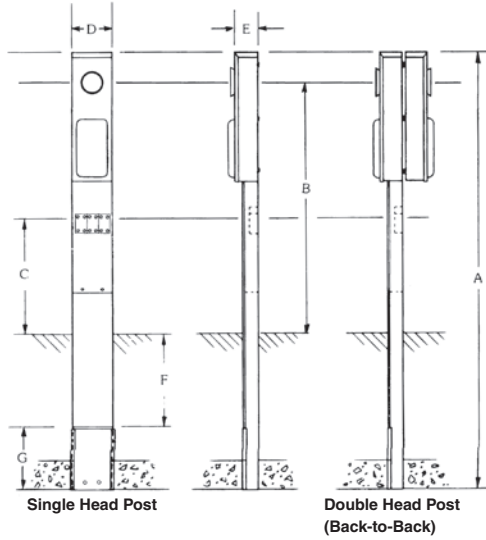

Key	Unmetered	Metered
A	65"	77-1/2"
B	—	45-1/4"
C	19-1/8"	19-1/8"
D	9"	9"
E	4-3/8"	4-3/8"
F	18"	18"
G	6"	6"

9HP

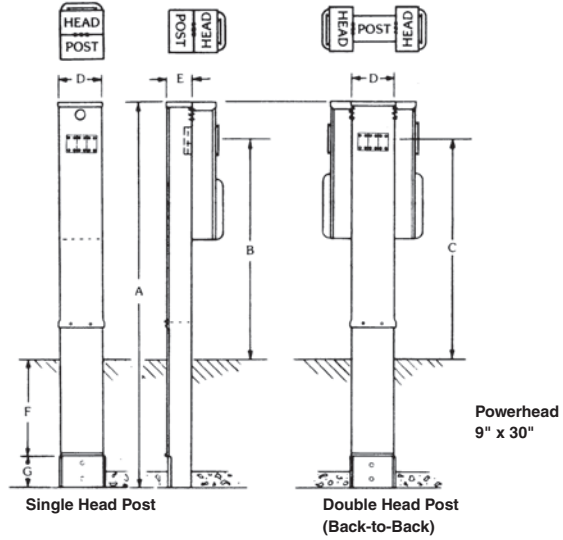

Key	100A Metered	200A Metered
A	83-1/2"	83-1/2"
B	51-1/4"	48-3/4"
C	47"	47"
D	9"	9"
E	4-3/8"	4-3/8"
F	18"	18"
G	6"	6"

14PT

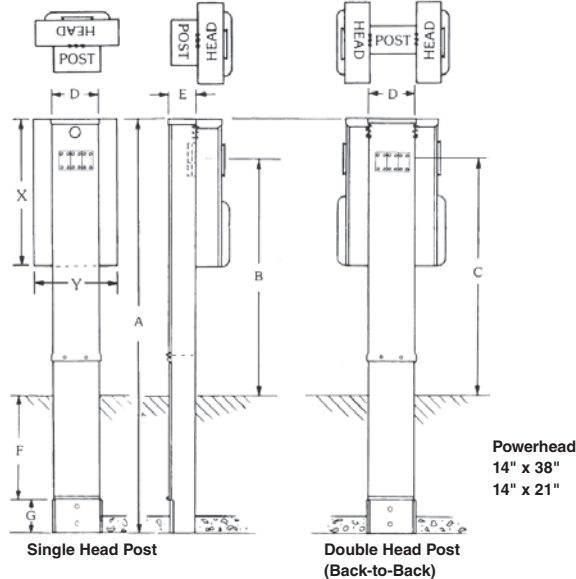

Key	Unmetered	Metered
A	83-1/2"	86"
B	—	50"
C	49-1/2"	49-1/2"
D	9"	9"
E	4-3/8"	4-3/8"
F	18"	18"
G	6"	6"

14HP

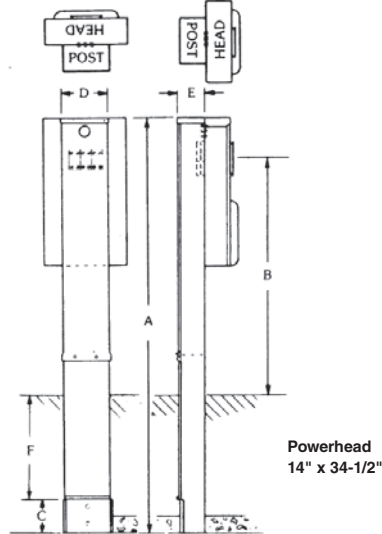

Key	Metered
A	83-1/2"
B	48-3/4"
C	6"
D	9-1/2"
E	4-3/8"
F	18"

Post Dimensions

Earth Burial

R400P6034

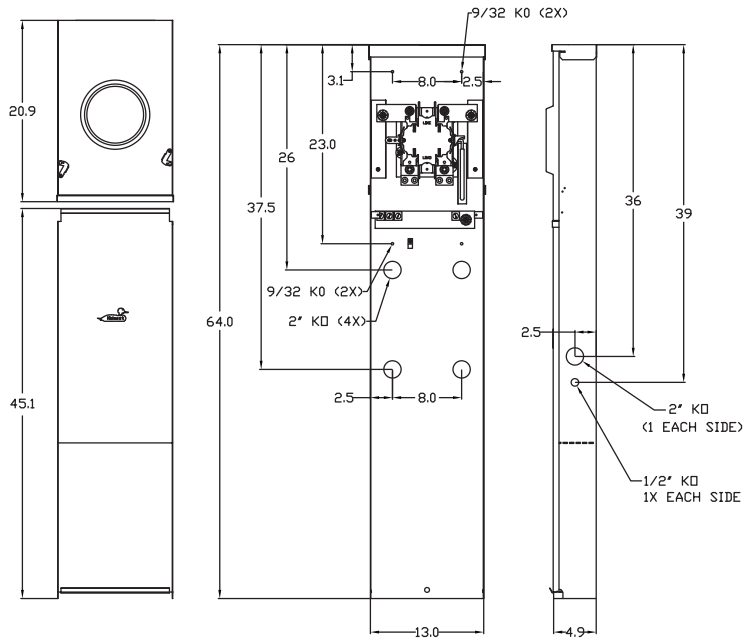

Wire Range Tables

AA

Connector	Copper		Aluminum	
	Solid	Strand	Solid	Strand
Line	—	1/0-250 kcmil	—	1/0-250 kcmil
Load	—	—	—	—
Neutral A	—	6-250	—	6-250
Neutral B	14-8	14-1/0	12-8	12-1/0
Neutral C	—	2-250	—	2-250

AB

Connector	Copper		Aluminum	
	Solid	Strand	Solid	Strand
Line	—	—	—	—
Load	14-8	14-1/0	12-8	12-1/0
Neutral - Large Hole	12-8	2-1/0	10-8	10-1/0
Neutral - Small Hole	14-8	14-4	12-8	12-4
Equipment Ground	12-8	12-2	12-8	12-2

AD

Connector	Copper		Aluminum	
	Solid	Strand	Solid	Strand
Line	—	6-1/0	—	6-1/0
Load	—	—	—	—
Neutral - Large Hole	12-8	12-1/0	10-8	10-1/0
Neutral - Small Hole	14-8	14-4	12-8	12-4
Equipment Ground	12-8	12-2	12-8	12-2

AF

Connector	Copper		Aluminum	
	Solid	Strand	Solid	Strand
Line	—	1/0-250 kcmil	—	1/0-250 kcmil
Load	—	1-300 kcmil	—	1-300 kcmil
Neutral	—	1/0-250 kcmil	—	1/0-250 kcmil
Equipment Ground	12-8	12-2	12-8	12-2

AN

Connector	Copper		Aluminum	
	Solid	Strand	Solid	Strand
Line Main Lugs	—	—	—	—
Load CB Base	—	1-300 kcmil	—	1-300 kcmil
Neutral - Large Single Lugs	—	1-300 kcmil	—	1-300 kcmil
Neutral - Small Single Holes	14-8	14-1/0	12-8	12-1/0
Neutral - Six Large Holes	14-8	10-4	—	6-4
Neutral - Small Holes	14-8	12-8	12-8	12-8
Equipment Ground	12-8	12-2	12-8	12-2

AS

Connector	Copper		Aluminum	
	Solid	Strand	Solid	Strand
Line	—	6-1/0	—	6-1/0
Load	—	—	—	—
Neutral - Large Hole	12-8	12-1/0	10-8	10-1/0
Neutral - Small Hole	14-8	14-4	12-8	12-4
Equipment Ground	12-8	12-2	12-8	12-2
Post Line Connectors Suitable for Loop Feed	2-350 kcmil		2-350 kcmil	
Equipment Ground	12-2	12-2	12-2	12-2

AT

Connector	Copper		Aluminum	
	Solid	Strand	Solid	Strand
Line	—	6-1/0	—	6-1/0
Load	—	—	—	—
Neutral	12-8	12-1/0	10-8	10-1/0
Neutral	14-8	14-4	12-8	12-4
Equipment Ground	12-8	12-2	12-8	12-2
Post Line Connectors Suitable for Loop Feed	6-350 kcmil		6-350 kcmil	
Equipment Ground	12-2	12-2	12-2	12-2

AW

Connector	Copper		Aluminum	
	Solid	Strand	Solid	Strand
Line	—	1/0-4/0	—	1/0-4/0
Load	—	1/0-4/0	—	1/0-4/0
Neutral	—	2-4/0	—	2-4/0
Equipment Ground	12-8	12-2	12-8	12-2

AX

Connector	Copper		Aluminum	
	Solid	Strand	Solid	Strand
Line	—	1/0-4/0	—	1/0-4/0
Load	—	1/0-4/0	—	1/0-4/0
Neutral A	—	2-4/0	—	2-4/0
Neutral B	12-8	12-1/0	10-8	10-1/0
Neutral C	14-8	14-4	12-8	12-4
Equipment Ground	12-8	12-2	12-8	12-2

Wire Range Tables

BC

Connector	Copper		Aluminum	
	Solid	Strand	Solid	Strand
Line	—	1/0-250	—	1/0-250
Load	—	1/0-250	—	1/0-250
Neutral	—	2-250	—	2-250
Neutral	12-8	12-1/0	10-8	10-1/0
Neutral	14-8	14-4	12-8	12-4
Equipment Ground	—	2-250	—	2-250
Equipment Ground	14-8	14-1/0	12-8	12-1/0

BD

Connector	Copper		Aluminum	
	Solid	Strand	Solid	Strand
Line	—	1/0-4/0	—	1/0-4/0
Load	—	2-4/0	—	1/0-4/0
Neutral	—	2-4/0	—	1/0-4/0
Equipment Ground	12-8	12-2	12-8	12-2

BF

Connector	Copper		Aluminum	
	Solid	Strand	Solid	Strand
Line	—	1-4/0	—	2/0-4/0
Load	—	1-4/0	—	2/0-4/0
Neutral	—	1-4/0	—	1-4/0
Equipment Ground	—	6-2/0	—	6-2/0

BG

Connector	Copper		Aluminum	
	Solid	Strand	Solid	Strand
Line	—	1-4/0	—	2/0-4/0
Load	—	1-4/0	—	2/0-4/0
Neutral A	—	1-4/0	—	1-4/0
Neutral/Ground B	—	6-2/0	—	6-2/0
Neutral/Ground C	14-8	14-4	12-8	12-4

BH

Connector	Copper		Aluminum	
	Solid	Strand	Solid	Strand
Line Meter Socket	—	6-350	—	6-350
Load Base Lugs	—	1-300	—	1-300
Neutral - Large Single Lugs	—	1-300	—	1-300
Neutral - Small Single Holes	14-8	14-1/0	12-8	12-1/0
Neutral - Six Large Holes	14-8	10-4	—	6-4
Neutral - Eight Small Holes	14-8	12-8	12-8	12-8
Post Line Connectors Suitable for Loop Feed	6-350 kcmil		6-350 kcmil	
Equipment Ground	12-8	12-2	12-8	12-2

BJ

Connector	Copper	
	Solid	Strand
Line Meter Socket	—	6-4/0
Load Base Lugs	—	1-4/0
Neutral A	—	1-4/0
Neutral/Ground B	—	6-2/0
Neutral/Ground C	14-8	14-4

BK

Connector	Copper		Aluminum	
	Solid	Strand	Solid	Strand
Line Meter Socket	—	6-350 mcm	—	6-350 mcm
Load Base Lugs	—	1-4/0	—	1-4/0
Neutral A	—	1-4/0	—	1-4/0
Neutral/Ground B	—	6-2/0	—	6-2/0
Neutral/Ground C	14-8	14-4	12-8	12-4

BM

Connector	Copper		Aluminum	
	Solid	Strand	Solid	Strand
Line	—	6-300	—	6-350
Load	—	1-300	—	1-300
Neutral A	—	1-300	—	1-300
Neutral B	—	6-2/0	—	6-2/0
Neutral C	14-8	14-1/0	12-1/0	12-1/0

BZ

Connector	Copper		Aluminum	
	Solid	Strand	Solid	Strand
Load	—	4/0-350	—	300-500
Neutral A	—	2-600	—	2-600
Neutral B	—	6-350	—	6-350

S

Connector	Copper		Aluminum	
	Solid	Strand	Solid	Strand
Post Line Connectors Suitable for Loop Feed	6-350 kcmil		6-350 kcmil	
Equipment Ground	12-2		12-2	

SS

Connector	Copper		Aluminum	
	Solid	Strand	Solid	Strand
Line	1/2" Stud Terminals		1/2" Stud Terminals	
Load	—	1-350	—	1-350
Neutral A	—	6-350	—	6-350
Neutral B	12-8	12-2	—	8-2
Neutral C	1/2" Stud Terminals		1/2" Stud Terminals	

Wire Range Tables

T2

Connector	Copper		Aluminum	
	Solid	Strand	Solid	Strand
Post Line Connectors Suitable for Loop Feed	2-250 kcmil		2-250 kcmil	
Equipment Ground	12-2		12-2	

U

Connector	Copper		Aluminum	
	Solid	Strand	Solid	Strand
Line Meter Socket	—	1/0-250	—	1/0-250
Load	—	6-1/0	—	4-1/0
Neutral – Large Single Lugs	—	1-300	—	1-300
Neutral – Small Single Lugs	14-8	14-1/0	12-8	12-1/0
Neutral - 3 Large Holes	14-8	10-4	—	6-4
Neutral - 3 Small Holes	14-8	12-8	12-8	12-8
Equipment Ground	12-8	12-2	12-8	12-2
Post Line Connectors Suitable for Loop Feed	6-350 kcmil		6-350 kcmil	
Equipment Ground	12-2	12-2	12-2	12-2

V

Connector	Copper		Aluminum	
	Solid	Strand	Solid	Strand
Line	14-8	14-1/0	12-8	12-1/0
Load	—	—	—	—
Neutral - Large Hole	12-8	12-1/0	10-8	10-1/0
Neutral - Small Hole	14-8	14-4	12-8	12-4
Equipment Ground	12-8	12-2	12-8	12-2

VA

Connector	Copper		Aluminum	
	Solid	Strand	Solid	Strand
Line	1/2" Stud Terminals			
Load	—	1-300	—	1-300
Neutral A	12-2	12-2	12-2	12-2
Neutral B	—	1-300	—	1-300
Neutral C	1/2" Stud Terminals			

VB

Connector	Copper		Aluminum	
	Solid	Strand	Solid	Strand
Neutral/Ground - Large Holes	14-8	10-4	12-8	10-4
Neutral/Ground - Small Holes	14-8	12-8	12-8	12-8

W

Connector	Copper		Aluminum	
	Solid	Strand	Solid	Strand
Equipment Ground	(2) 14	(2) 14	—	—
Equipment Ground	(2) 12	(2) 12	(2) 12	(2) 12
Equipment Ground	(2) 10	(2) 10	(2) 10	(2) 10
Equipment Ground	(1) 12, (1) 14	—	—	—
Equipment Ground	(1) 10, (1) 14	—	—	—
Equipment Ground	(1) 10, (1) 12	—	(1) 10, (1) 12	—
Equipment Ground	(1) 8-4	(1) 8-4	—	(1) 8-4

Z

Connector	Copper		Aluminum	
	Solid	Strand	Solid	Strand
Line	14-8	14-1/0	12-8	12-1/0
Load	14-8	14-1/0	12-8	12-1/0
Neutral - Large Hole	12-8	12-1/0	10-8	10-1/0
Neutral - Small Hole	14-8	14-4	12-8	12-4
Equipment Ground	12-8	12-2	12-8	12-2

ZB

Connector	Copper		Aluminum	
	Solid	Strand	Solid	Strand
Neutral N1	—	1-300	—	1-300
Neutral N2	6-2/0	6-2/0	14-1/0	14-1/0
Neutral N3	14-4	14-4	12-4	12-4
Load 1	—	1-300	—	1-300
Equipment Ground	6-2/0	6-2/0	6-2/0	6-2/0

ZZ

Connector	Copper		Aluminum	
	Solid	Strand	Solid	Strand
Line Meter Socket	—	6-1/0	—	6-1/0
Load	—	1-1/0	—	1-1/0
Neutral B	—	6-1/0	—	6-1/0
Neutral C	14-8	14-1/0	12-8	12-1/0
Neutral D	—	2-260	—	2-260
3 Large Holes	14-8	14-4	12-8	12-4
4 Small Holes	14-8	14-8	12-8	12-8
Equipment Ground	14-8	14-4	12-8	12-4
3 Large Holes	14-8	14-8	12-8	12-8

400 Amps

Connector	Copper		Aluminum	
	Solid	Strand	Solid	Strand
Line ¹	—	—	—	—
Load 1	1-300	—	1-300	—
Neutral N1	—	1-300	—	1-300
Equipment Ground	6-2/0	6-2/0	6-2/0	6-2/0

Data subject to change without notice.

¹ Crimp-on/connector lug is not supplied by Midwest.

Aluminum Mobile Home

Specifications

- NEMA 3R weatherproof construction
- 14-gauge aluminum power head construction
- Durable polyester powder coat finish resists chipping and fading (available in optional green finish)
- Suitable for use as service entrance equipment
- 22 kAIC amps RMS symmetrical short circuit rating
- Ring type, 4-jaw single phase meter socket series wired to main
- 600 MCM loop feed lugs on 3 and 4 socket models
- Available with up to 4 meters
- Available with 200 amp factory installed main breaker(s)
- Lockable, sealable covers with stainless steel latch
- Direct burial galvanized mounting posts supplied with adjustable foot extensions for increased stability

Installation Features

- Multi-gang construction reduces the number of installations
- Modular construction allows post installation for trenching and feeder cables (power heads can be installed at a later time)
- Unique “cap-off” feature on post for splice through applications
- Light weight aluminum power head construction allows easy installation by a single electrician
- Rolled edges on all post wire entry points
- Removable access doors on both sides of power head



Basic Model

Single and Multi-gang Power Heads, 200 Amps, 120/240V

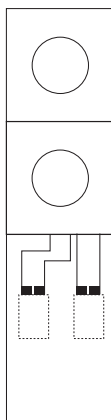

Fig. A
 MH100S0, MH200S0,
 MH300S0

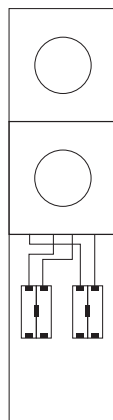

Fig. B
 MH120B0, MH220B0,
 MH320B0, MH420B0

Fig.	Model Number ^{1,2}	Meter Sockets	Power Heads	Amps	Main Breaker	Hub Opening	Unit Wt.	UL
A	MH100S0	1	1	200	Not Included (125A Max Plug-in)	N	22	Y
B	MH120B0	1	1		Included (200A Bolt-on)		22	
A	MH200S0	2	1		Not Included (125A Max Plug-in)		26	
B	MH220B0	2	1		Included (200A Bolt-on)		26	
A	MH300S0	3	2		Not Included (125A Max Plug-in)		39	
B	MH320B0	3	2		Included (200A Bolt-on)		39	
B	MH420B0	4	2		Included (200A Bolt-on)		52	

¹ All models available in optional green finish. Substitute trailing "0" with "1" (i.e., MH100S1).
² Order post separately.

Mounting Posts for Single and Multi-gang Power Heads

Model Number ¹	Color	Unit Wt. ²
P2POSTGRAY	Gray	26
P2POST	Green	

¹ Required for installation of power head.
² Post is shipped separately.

Dimensions

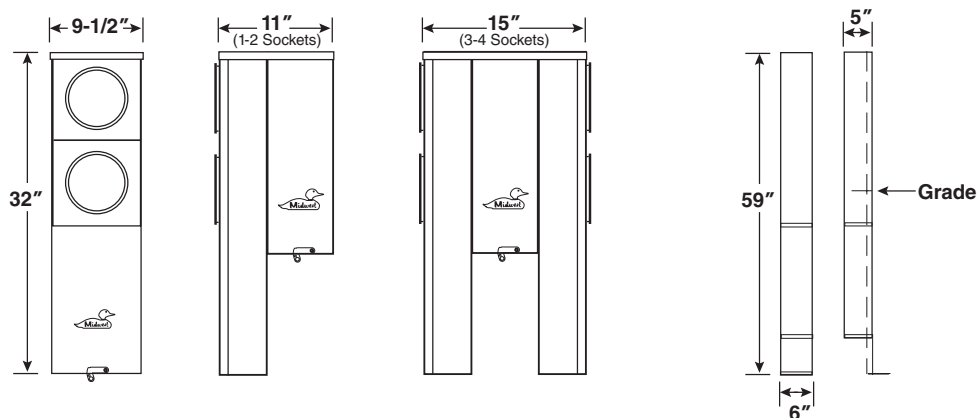

Data subject to change without notice.

Section 2

Single Socket Metering



Application Information

Midwest's Single Socket Metering products are designed for residential use. They are UL labeled and are manufactured with surface mounted outdoor enclosures. Many of our units are utility approved (see tables on the following page.)

Our products range from 20A to 320A and are available in single phase or three phase.



Features and Benefits

- Single or Three phase
- Integral duplex ground extruded in neutral lug

Rugged Durability

- Heavy duty lug screws provide stronger connection component for reliable termination
- G90 galvanized bridge provides superior corrosion resistance
- NEMA 3R enclosure
- 200A units have jaws made of copper plated alloy and have reinforcing springs to help maintain electrical connections

Installation Ease

- 200A units have slide-nuts to allow for ease of installation of conductors and help eliminate lost components
- 125A units have horn bypass kit that is field installable by changing slide-nut

User Safety

- Tested and UL listed up to 10 kAIC rating with specified overcurrent protection
- Selected items are utility approved



Sockets with 4 Jaws/Terminals

Std. Prefix	Other Features	Product Group	Amps	Service Design	Max. Conductor (Line and Load)	Std. Suffixes	Utility Approved (if applicable)	Midwest Electric Product
U	A = Aluminum Cab B = Barrel Lock F = Barrel Lock & Lock Guard G = Grounded Fifth Terminal H = Horn Bypass S = Screw Type Sealing Ring T = Grounding Connector (#14-#2 CU-AL) Z = 5/16" Hex Head Connector Screw	RS = Residential Service, Single Position	1 = 125 5 = 150 2 = 200	0 = Overhead 1 = Combination Overhead/Underground, Side Wired 2 = Underground, Side Wired 3 = Combination Overhead/Underground, Side Wired	0 = 3/8" Stud Connectors 2 = #250 kcmil Connectors 3 = #350 kcmil Connectors 6 = #600 kcmil Connectors 9 = Dual #500 kcmil Connectors	B = Small Hub Opening C = Small Hub Cover Plate HL = High Leg Label (Delta Service) L = 1 1/4" Hub N = 2" Hub ND = Neutral Disconnect T = Large Hub Opening U = Large Hub Cover Plate	FL = Meter Equipment Group KC = KCP+L	MEP

Sockets with 4, 5 or 7 Jaws/Terminals

Std. Prefix	Other Features	Product Group	Jaw Qty.	Amps	Service Design	Max. Conductor (Line and Load)	Std. Suffixes	Utility Approved (if applicable)	Midwest Electric Product
U	A = Aluminum Cab B = Barrel Lock C = Spring Jaw Socket F = Barrel Lock & Lock Guard H = Horn Bypass S = Screw Type Sealing Ring T = Grounding Connector (#14-#2 CU-AL) Z = 5/16" Hex Head Connector Screw	H = Commercial or Residential Service, Single Position (Lever Bypass)	4 = 4 Terminal 5 = 5 Terminal 7 = 7 Terminal	2 = 200 3 = 320	0 = Overhead 1 = Combination Overhead/Underground, Side Wired 2 = Underground, Side Wired 3 = Combination Overhead/Underground, Side Wired	0 = 3/8" Stud Connectors 2 = #250 kcmil Connectors 3 = #350 kcmil Connectors 6 = #600 kcmil Connectors 9 = Dual #500 kcmil Connectors	B = Small Hub Opening C = Small Hub Cover Plate HL = High Leg Label (Delta Service) L = 1 1/4" Hub N = 2" Hub ND = Neutral Disconnect SH = Stainless Steel Hasp T = Large Hub Opening U = Large Hub Cover Plate	FL = Meter Equipment Group KC = KCP & L	MEP

* Model numbers beginning with "10" or "MEP" will not follow the nomenclature.

Data subject to change without notice.

Section 2 – Single Socket Metering

1-Phase

20 – 200 Amps, 600V

Amps	Model Number Ringless	Line Wire Range (CU/AL)	Overhead/Underground Line Feed	Ground Range (CU/AL)	Triplex Ground	Number of Terminals	Lever Bypass	Horned Bypass	Hub Type	Enclosure N3R	UL and Utility Approved
20	1007003CMEP	#12	Bottom	(2) #14-2	N	13	N	N	Solid Top	G90 Steel	UL, DTE
	1007361CMEP	#12	Bottom	(2) #14-2	N	8	N	N	Solid Top	G90 Steel	UL, DTE
125	1006385BMEP	#8-2/0	Bottom	No Ground	N	4	N	N	Solid Top	G90 Steel	UL, DTE
	MEPKR1AS1BTZ	#8-2/0	Top	#14-2	Y	4	N	N	Small Hub Opening	G90 Steel	UL
	MEPKS1AS1BT	#8-2/0	Top/Bottom	#14-2	Y	4	N	Y	Small Hub Opening	G90 Steel	UL
	MEPKS1AS1BTV	#8-2/0	Top	#14-2	Y	4	N	Y	Small Hub Opening	G90 Steel	UL, AEP
	UATZRS101CFLMEP	#8-2/0	Top/Bottom	#14-2	Y	4	N	N	Small Hub Cover Plate	Aluminum	UL, MEG
	UBHRS101BMEP	#8-2/0	Top/Bottom	No Ground	N	4	N	Y	Small Hub Opening	G90 Steel	UL
	UFHTRS101BMEP	#8-2/0	Top/Bottom	#14-2	Y	4	N	Y	Small Hub Opening	G90 Steel	UL, AEP
	UGHTRS101BMEP	#8-2/0	Top/Bottom	#14-2	Y	5	N	Y	Small Hub Opening	G90 Steel	UL
	UHTRS101BMEP	#8-2/0	Top/Bottom	#14-2	Y	4	N	Y	Small Hub Opening	G90 Steel	UL
	URS101BCPLMEP	#8-2/0	Top/Bottom	(2) #14-2	Y	4	N	N	Small Hub Opening	G90 Steel	UL
	URS101CCPLMEP	#8-2/0	Top/Bottom	(2) #14-2	Y	4	N	N	Small Hub Cover Plate	G90 Steel	UL
	UTRS101BMEP	#8-2/0	Top/Bottom	#14-2	Y	4	N	N	Small Hub Opening	G90 Steel	UL, CMP
	UTZRS101CFLMEP	#8-2/0	Top/Bottom	#14-2	Y	4	N	N	Small Hub Cover Plate	G90 Steel	UL, MEG
150	UTRS502BMEP	#8-250MCM	Top/Bottom	#14-2	Y	4	N	N	Small Hub Opening	G90 Steel	UL
200	1004709DMEP	#8-250MCM	Top/Bottom	No Ground	N	4	N	N	Small Hub Opening	G90 Steel	UL, DTE
	1004710EMEP	#8-250MCM	Top/Bottom	No Ground	N	4	N	N	Small Hub Cover Plate	G90 Steel	UL, DTE
	1007665AMEP	#8-250MCM	Top/Bottom	#14-2	Y	4	N	Y	Small Hub Opening	G90 Steel	UL, AEP, CECHA
	1007665MEP	#8-250MCM	Top/Bottom	#14-2	Y	4	N	Y	Small Hub Opening	G90 Steel	UL, CECHA
	1009995MEP	#6-350MCM	Top/Bottom	No Ground	N	4	Y	N	Small Hub Cover Plate	G90 Steel	UL, DTE
	1011692MEP	#6-350MCM	Top/Bottom	#14-2	Y	4	Y	N	Small Hub Cover Plate	Aluminum	UL, AEP, CECHA
	MEPKR1CS1BT	#8-350MCM	Top	#14-2	Y	4	N	N	Small Hub Opening	G90 Steel	UL, CECHA
	MEPKS1CS1BJT	#8-250MCM	Top/Bottom	#14-2	Y	4	N	Y	Small Hub Opening	G90 Steel	UL
	MEPKS1CS1BJTV	#8-250MCM	Top	#14-2	Y	4	N	Y	Small Hub Opening	G90 Steel	UL, AEP
	MEPKS1CS1DT	#8-350MCM	Top/Bottom	#14-2	Y	4	N	Y	Small Hub Cover Plate	G90 Steel	UL
	MEPKS1CS1DTV	#8-350MCM	Top/Bottom	#14-2	Y	4	N	Y	Small Hub Cover Plate	G90 Steel	UL, AEP
	MEPKR1DH1DQRZ	#8-350MCM	Top/Bottom	#14-2	N	4	N	N	Small Hub Cover Plate	G90 Steel	UL
	MEPKS1DS1AT	#8-350MCM	Top/Bottom	#14-2	Y	4	N	Y	Solid Top	G90 Steel	UL
	MEPKS1DS1ATV	#8-350MCM	Side	#14-2	Y	4	N	Y	Solid Top	G90 Steel	UL, AEP
	MEPKU1CW3CT	#6-350MCM	Top/Bottom	#14-2	Y	7	Y	N	Large Hub Opening	G90 Steel	UL
	U92197CCCPLMEP	#8-350MCM	Side	(2) #14-2	N	4	N	N	(2) Small Hub Cover Plates	G90 Steel	UL
	UAFHTRS202BSHMEP	#8-250MCM	Top/Bottom	#14-2	Y	4	N	Y	Small Hub Opening	Aluminum	UL, AEP
	UAFHTRS223ASHMEP	#8-350MCM	Bottom	#14-2	Y	4	N	Y	Solid Top	Aluminum	UL, AEP

Data subject to change without notice.

Section 2 – Single Socket Metering

1-Phase

200 Amps, 600V (continued)

Amps	Model Number Ringless	Line Wire Range (CU/AL)	Overhead/Underground Line Feed	Ground Range (CU/AL)	Triplex Ground	Number of Terminals	Lever Bypass	Horned Bypass	Hub Type	Enclosure N3R	UL and Utility Approved
200	UATH4203BFLMEP	#6-350MCM	Top/Bottom	#14-2	Y	4	Y	N	Small Hub Opening	Aluminum	UL, MEG
	UATH4203TFLMEP	#6-350MCM	Top/Bottom	#14-2	Y	4	Y	N	Large Hub Opening	Aluminum	UL, MEG
	UATH4213CFLMEP	#6-350MCM	Top/Bottom	#14-2	Y	4	Y	N	Small Hub Cover Plate	Aluminum	UL, MEG
	UATH4213UFLMEP	#6-350MCM	Top/Bottom	#14-2	Y	4	Y	N	Large Hub Cover Plate	Aluminum	UL, MEG
	UATRS202BFLMEP	#8-250MCM	Top/Bottom	#14-2	Y	4	N	N	Small Hub Opening	Aluminum	UL, MEG
	UATRS212CFLMEP	#8-250MCM	Top/Bottom	#14-2	Y	4	N	N	Small Hub Cover Plate	Aluminum	UL, MEG
	UATRS213AFLMEP	#8-350MCM	Bottom	#14-2	Y	4	N	N	Solid Top	Aluminum	UL, MEG
	UATRS213CFLMEP	#8-350MCM	Top/Bottom	#14-2	Y	4	N	N	Small Hub Cover Plate	Aluminum	UL, MEG
	UATRS223AFLMEP	#8-350MCM	Bottom	#14-2	Y	4	N	N	Solid Top	Aluminum	UL, MEG
	UBHRS202BMEP	#8-250MCM	Top	No Ground	N	4	N	Y	Small Hub Opening	G90 Steel	UL
	UBHRS212BMEP	#8-250MCM	Top/Bottom	No Ground	N	4	N	Y	Small Hub Opening	G90 Steel	UL
	UFHTRS202BMEP	#8-250MCM	Top/Bottom	#14-2	Y	4	N	Y	Small Hub Opening	G90 Steel	UL, AEP
	UFHTRS223AMEP	#8-350MCM	Bottom	#14-2	Y	4	N	Y	Solid Top	G90 Steel	UL, AEP
	UFHTRS233CMEP	#8-350MCM	Top/Bottom	#14-2	Y	4	N	Y	Small Hub Cover Plate	G90 Steel	UL, AEP
	UFTH4213CMEP	#6-350MCM	Top/Bottom	#14-2	Y	4	Y	N	Small Hub Cover Plate	G90 Steel	UL, AEP
	UGHRS212CKCMEP	#8-250MCM	Top/Bottom	No Ground	N	5	N	Y	Small Hub Cover Plate	G90 Steel	UL, KCP&L
	UGHTRS213BMEP	#8-350MCM	Top/Bottom	#14-2	Y	5	N	Y	Small Hub Opening	G90 Steel	UL
	UGTH4213CMEP	#6-350MCM	Top/Bottom	#14-2	Y	5	N	N	Small Hub Cover Plate	G90 Steel	UL
	UGTRS213CMEP	#8-350MCM	Top/Bottom	#14-2	Y	5	N	N	Small Hub Cover Plate	G90 Steel	UL
	UH4213CMEP	#6-350MCM	Top/Bottom	No Ground	N	4	Y	N	Small Hub Cover Plate	G90 Steel	UL
	UHTRS202BMEP	#8-250MCM	Top/Bottom	#14-2	Y	4	N	Y	Small Hub Opening	G90 Steel	UL
	UHTRS223AMEP	#8-350MCM	Side	#14-2	Y	4	N	Y	Solid Top	G90 Steel	UL
	URTRS213AMEP	#8-350MCM	Bottom	#14-2	Y	4	N	N	Solid Top	G90 Steel	UL
	UT92197CCFLMEP	#8-350MCM	Top/Bottom	#14-2	Y	4	N	N	(2) Small Hub Cover Plates	G90 Steel	UL, MEG
	UTH4203BFLMEP	#6-350MCM	Top/Bottom	#14-2	Y	4	Y	N	Small Hub Opening	G90 Steel	UL, MEG
	UTH4203TFLMEP	#6-350MCM	Top/Bottom	#14-2	Y	4	Y	N	Large Hub Opening	G90 Steel	UL, MEG
	UTH4213BMEP	#6-350MCM	Top/Bottom	#14-2	Y	4	Y	N	Small Hub Opening	G90 Steel	UL
	UTH4213CMEP	#6-350MCM	Top/Bottom	#14-2	Y	4	N	N	Small Hub Cover Plate	G90 Steel	UL
	UTH4213CFLMEP	#6-350MCM	Top/Bottom	#14-2	Y	4	Y	N	Small Hub Cover Plate	G90 Steel	UL, MEG
	UTH4213UFLMEP	#6-350MCM	Top/Bottom	#14-2	Y	4	Y	N	Large Hub Cover Plate	G90 Steel	UL, MEG
	UTRS202BMEP	#8-250MCM	Top/Bottom	#14-2	Y	4	N	N	Small Hub Opening	G90 Steel	UL, CMP
	UTRS212BMEP	#8-250MCM	Top/Bottom	#14-2	Y	4	N	N	Small Hub Opening	G90 Steel	UL
UTRS212CMEP	#8-250MCM	Top/Bottom	#14-2	Y	4	N	N	Small Hub Cover Plate	G90 Steel	UL	

Data subject to change without notice.

Section 2 – Single Socket Metering

1-Phase

200 Amps, 600V (continued)

Amps	Model Number Ringless	Line Wire Range (CU/AL)	Overhead/Underground Line Feed	Ground Range (CU/AL)	Triplex Ground	Number of Terminals	Lever Bypass	Horned Bypass	Hub Type	Enclosure N3R	UL and Utility Approved
200	UTRS2138BMEP	(1) #8-350MCM Line (2) #8-250MCM Load	Top/Bottom	#14-2	Y	4	N	N	Small Hub Opening	G90 Steel	UL
	UTRS213AFLMEP	#8-350MCM	Bottom	#14-2	Y	4	N	N	Solid Top	G90 Steel	UL, MEG
	UTRS213BMEP	#8-350MCM	Top/Bottom	#14-2	Y	4	N	N	Small Hub Opening	G90 Steel	UL, CMP
	UTRS213CFLMEP	#8-350MCM	Top/Bottom	#14-2	Y	4	N	N	Small Hub Cover Plate	G90 Steel	UL, MEG
	UTRS213CMEP	#8-350MCM	Top/Bottom	#14-2	Y	4	N	N	Small Hub Cover Plate	G90 Steel	UL, CMP
	UTRS223AFLMEP	#8-350MCM	Bottom	#14-2	Y	4	N	N	Solid Top	G90 Steel	UL, MEG
	UTRS223AMEP	#8-350MCM	Bottom	#14-2	Y	4	N	N	Solid Top	G90 Steel	UL

1-Phase

320 Amps, 600V

Amps	Model Number Ringless	Line Wire Range (CU/AL)	Overhead/Underground Line Feed	Ground Range (CU/AL)	Triplex Ground	Number of Terminals	Lever Bypass	Horned Bypass	Hub Type	Enclosure N3R	UL and Utility Approved
320	1007672MEP ¹	Studs – (1) 600MCM or (2) 350MCM	Top	#14 -1/0	Y	4	Y	N	Large Hub Opening	G90 Steel	UL, CECHA
	1008068MEP	(2) #6-350MCM	Top/Bottom	#14 -1/0	Y	4	Y	N	Large Hub Cover Plate	G90 Steel	UL, AEP
	1008435MEP	#4-600MCM	Bottom	#14 -1/0	Y	4	Y	N	Solid Top	G90 Steel	UL
	1008836MEP ¹	Studs – (1) 600MCM or (2) 350MCM	Top/Bottom	#14 -1/0	Y	4	Y	N	Large Hub Cover Plate	G90 Steel	UL, MEG
	1008837MEP ¹	Studs – 600MCM or (2) 350MCM	Top/Bottom	#14 -1/0	Y	4	Y	N	Large Hub Cover Plate	Aluminum	UL, MEG
	1009260MEP ¹	Studs – (1) 600MCM or (2) 350MCM	Top/Bottom	#14 -1/0	Y	4	Y	N	Large Hub Cover Plate	G90 Steel	UL
	1009788AMEP ¹	Studs – (1) 600MCM or (2) 350MCM	Top/Bottom	No Ground	N	4	Y	N	Large Hub Cover Plate	G90 Steel	UL, DTE
	MEPKU1FS1EMT	#4-600MCM	Top/Bottom	#14 -1/0	Y	4	Y	N	Large Hub Cover Plate	G90 Steel	UL
	UAFTH4330TSHMEP ¹	Studs – (1) 600MCM or (2) 350MCM	Top/Bottom	#14 -1/0	Y	4	Y	N	Large Hub Opening	Aluminum	UL, AEP
	UAFTH4336TSHMEP	#4-600MCM	Top/Bottom	#14 -1/0	Y	4	Y	N	Large Hub Opening	Aluminum	UL, AEP
	UATH4300TFLMEP ¹	Studs – (1) 600MCM or (2) 350MCM	Top/Bottom	#14 -1/0	Y	4	Y	N	Large Hub Opening	Aluminum	UL, MEG
	UFTH4330TMEP ¹	Studs – (1) 600MCM or (2) 350MCM	Top/Bottom	#14 -1/0	Y	4	Y	N	Large Hub Opening	G90 Steel	UL, AEP
	UFTH4336TMEP	#4-600MCM	Top/Bottom	#14 -1/0	Y	4	Y	N	Large Hub Opening	G90 Steel	UL, AEP
	UH43068TCPLMEP	(1) #4-600MCM Line (2) #6-250MCM Load	Top	(2) #14-2	Y	4	Y	N	Large Hub Opening	G90 Steel	UL
	UTH4300TMEP	#4-600MCM	Top/Bottom	#14 -1/0	Y	7	Y	N	Large Hub Cover Plate	G90 Steel	UL
	UTH4300TFLMEP ¹	Studs – (1) 600MCM or (2) 350MCM	Top/Bottom	#14-1/0	Y	4	Y	N	Large Hub Opening	G90 Steel	UL, MEG
	UTH4330TMEP ¹	Studs – (1) 600MCM or (2) 350MCM	Top/Bottom	#14-1/0	Y	4	Y	N	Large Hub Opening	G90 Steel	UL, CMP
	UTH43369TMEP	(1) #4-600MCM Line (2) #6-350MCM Load	Top	#14-1/0	Y	4	Y	N	Large Hub Opening	G90 Steel	UL
UTH73069THLMEP	(1) #4-600MCM Line (2) #6-350MCM Load	Top/Bottom	#14-1/0	Y	4	Y	N	Large Hub Opening	G90 Steel	UL	

¹ Lugs not included. This product comes with studs only. Order lugs separately, see Accessories on page 2-9. One lug per kit, order appropriate QTY needed.

For example, order three lugs (A, C, N) if meter is 1-Phase or four lugs (A, B, C, N) if meter is 3-Phase.

Data subject to change without notice.

3-Phase

20 – 200 Amps, 600V

Amps	Model Number Ringless	Line Wire Range (CU/AL)	Overhead/ Underground Line Feed	Ground Range (CU/AL)	Triplex Ground	Number of Terminals	Lever Bypass	Horned Bypass	Hub Type	Enclosure N3R	Certification
20	URSTS132CMEP	#10-12	Top/Bottom	#14-2	Y	13	N	N	Small Hub Cover Plate	G90 Steel	UL, EUSERC
200	1007670MEP	#6-350MCM	Top	#14-2	Y	7	Y	N	Large Hub Opening	G90 Steel	UL, CECHA
	UAFTH7213TSHMEP	#6-350MCM	Top/Bottom	#14-2	Y	7	Y	N	Large Hub Opening	Aluminum	UL, AEP
	UATH7203BFLMEP	#6-350MCM	Top/Bottom	#14-2	Y	7	Y	N	Small Hub Opening	Aluminum	UL, MEG
	UATH7203TFLMEP	#6-350MCM	Top/Bottom	#14-2	Y	7	Y	N	Large Hub Opening	Aluminum	UL, MEG
	UATH7213CFLMEP	#6-350MCM	Top/Bottom	#14-2	Y	7	Y	N	Small Hub Cover Plate	Aluminum	UL, MEG
	UATH7213UFLMEP	#6-350MCM	Top/Bottom	#14-2	Y	7	Y	N	Large Hub Cover Plate	Aluminum	UL, MEG
	UBC7213BMEP	#6-350MCM	Top/Bottom	No Ground	N	7	Y	N	Small Hub Opening	G90 Steel	UL
	UBH7213TMEP	#6-350MCM	Top/Bottom	No Ground	N	7	Y	N	Large Hub Opening	G90 Steel	UL
	UFTH7213BMEP	#6-350MCM	Top/Bottom	#14-2	Y	7	Y	N	Small Hub Opening	G90 Steel	UL, AEP
	UFTH7213TMEP	#6-350MCM	Top/Bottom	#14-2	Y	7	Y	N	Large Hub Opening	G90 Steel	UL, AEP
	UFTTH7213TMEP	#6-350MCM	Top/Bottom	(2) #14-2	Y	7	Y	N	Large Hub Opening	G90 Steel	UL, AEP
	UH7213CKCMEP	#6-350MCM	Top/Bottom	No Ground	N	7	Y	N	Small Hub Cover Plate	G90 Steel	UL, KCP&L
	UH7213CMEP	#6-350MCM	Top/Bottom	No Ground	N	7	Y	N	Small Hub Cover Plate	G90 Steel	UL
	UTH7203BFLMEP	#6-350MCM	Top/Bottom	#14-2	Y	7	Y	N	Small Hub Opening	G90 Steel	UL, MEG
	UTH7203TFLMEP	#6-350MCM	Top/Bottom	#14-2	Y	7	Y	N	Large Hub Opening	G90 Steel	UL, MEG
	UTH7203TMEP	#6-350MCM	Top/Bottom	#14-2	Y	7	Y	N	Large Hub Opening	G90 Steel	UL, CMP
	UTH7213BMEP	#6-350MCM	Top/Bottom	#14-2	Y	7	Y	N	Small Hub Opening	G90 Steel	UL
	UTH7213CMEP	#6-350MCM	Top/Bottom	#14-2	Y	7	Y	N	Small Hub Cover Plate	G90 Steel	UL, EXCEL
	UTH7213THLMEP	#6-350MCM	Top/Bottom	#14-2	Y	7	Y	N	Large Hub Opening	G90 Steel	UL
	UTH7213TMEP	#6-350MCM	Top/Bottom	#14-2	Y	7	Y	N	Large Hub Opening	G90 Steel	UL
UTH7213UMEP	#6-350MCM	Top/Bottom	#14-2	Y	7	Y	N	Large Hub Cover Plate	G90 Steel	UL, CMP	

3-Phase

320 Amps, 600V

Amps	Model Number Ringless	Line Wire Range (CU/AL)	Overhead/Underground Line Feed	Ground Range (CU/AL)	Triplex Ground	Number of Terminals	Lever Bypass	Horned Bypass	Hub Type	Enclosure N3R	Certification
320	UAFTH7330TSHMEP ¹	Studs – (1) 600MCM or (2) 350MCM	Top/Bottom	#14 -1/0	Y	7	Y	N	Large Hub Opening	Aluminum	UL, AEP
	UAFTH7336TSHMEP	#4-600MCM	Top/Bottom	#14 -1/0	Y	7	Y	N	Large Hub Opening	Aluminum	UL, AEP
	UATH7300TFLMEP ¹	Studs – (1) 600MCM or (2) 350MCM	Top/Bottom	#14 -1/0	Y	7	Y	N	Large Hub Opening	Aluminum	UL, MEG
	UATH7300UFLMEP ¹	Studs – (1) 600MCM or (2) 350MCM	Top/Bottom	#14 -1/0	Y	7	Y	N	Large Hub Cover Plate	Aluminum	UL, MEG
	UATH7330UFLMEP	Studs – (1) 600MCM or (2) 350MCM	Side	#14 -1/0	Y	7	Y	N	Large Hub Cover Plate	Aluminum	UL, MEG
	UFTH7330TMEP ¹	Studs – (1) 600MCM or (2) 350MCM	Top/Bottom	#14 -1/0	Y	7	Y	N	Large Hub Opening	G90 Steel	UL, AEP
	UFTH7336TMEP	#4-600MCM	Top/Bottom	#14 -1/0	Y	7	Y	N	Large Hub Opening	G90 Steel	UL, AEP
	UFTTH7330TMEP ¹	Studs – (1) 600MCM or (2) 350MCM	Top/Bottom	(2) #14-1/0	Y	7	Y	N	Large Hub Opening	G90 Steel	UL, AEP
	UFTTH7336TMEP	#4-600MCM	Top/Bottom	(2) #14-1/0	Y	7	Y	N	Large Hub Opening	G90 Steel	UL, AEP
	UTH7300TFLMEP ¹	Studs – (1) 600MCM or (2) 350MCM	Top/Bottom	#14-1/0	Y	7	Y	N	Large Hub Opening	G90 Steel	UL, MEG
	UTH7330TMEP ¹	Studs – (1) 600MCM or (2) 350MCM	Top/Bottom	#14-1/0	Y	7	Y	N	Large Hub Opening	G90 Steel	UL
	UTH7330UFLMEP ¹	Studs – (1) 600MCM or (2) 350MCM	Top/Bottom	#14-1/0	Y	7	Y	N	Large Hub Cover Plate	G90 Steel	UL, MEG
	UTH73369THLMEP	(1) #4-600MCM Line (2) #6-350MCM Load	Top/Bottom	#14-1/0	Y	7	Y	N	Large Hub Opening	G90 Steel	UL
	UTJ7300UMEP	Studs – (1) 600MCM or (2) 350MCM	Top/Bottom	#14-1/0	Y	7	Y	N	Large Hub Cover Plate	G90 Steel	UL

¹ Lugs not included. This product comes with studs only. Order lugs separately, see Accessories on page 2-9. One lug per kit, order appropriate QTY needed. For example, order three lugs (A, C, N) if meter is 1-Phase or four lugs (A, B, C, N) if meter is 3-Phase.

1-Phase or 3-Phase

200 – 320 Amps, 600V

Amps	Model Number Ringless	Line Wire Range (CU/AL)	Overhead/Underground Line Feed	Ground Range (CU/AL)	Triplex Ground	Number of Terminals	Lever Bypass	Horned Bypass	Hub Type	Enclosure N3R	Certification
200	1008801MEP	#6-350MCM	Top/Bottom	#14 -1/0	N	5	Y	N	Small Hub Cover Plate	G90 Steel	UL, EXCEL
	UAFTH5213BNDMEP	#6-350MCM	Top/Bottom	#14-2	Y	5	Y	N	Small Hub Opening	Aluminum	UL, AEP
	UATH5203BFLMEP	#6-350MCM	Top/Bottom	#14-2	Y	5	Y	N	Small Hub Opening	Aluminum	UL, MEG
	UATH5203TFLMEP	#6-350MCM	Top/Bottom	#14-2	Y	5	Y	N	Large Hub Opening	Aluminum	UL, MEG
	UATH5213CFLMEP	#6-350MCM	Top/Bottom	#14-2	Y	5	Y	N	Small Hub Cover Plate	Aluminum	UL, MEG
	UATH5213UFLMEP	#6-350MCM	Top/Bottom	#14-2	Y	5	Y	N	Large Hub Cover Plate	Aluminum	UL, MEG
	UFTH5213BNDMEP	#6-350MCM	Top/Bottom	#14-2	Y	5	Y	N	Small Hub Opening	G90 Steel	UL, AEP
	UTH5203BFLMEP	#6-350MCM	Top/Bottom	#14-2	Y	5	Y	N	Small Hub Opening	G90 Steel	UL, MEG
	UTH5203BMEP	#6-350MCM	Top/Bottom	#14-2	Y	5	Y	N	Small Hub Opening	G90 Steel	UL, CMP
	UTH5203TFLMEP	#8-350MCM	Top/Bottom	#14-2	Y	5	Y	N	Large Hub Opening	G90 Steel	UL, MEG
	UTH5213BNDMEP	#6-350MCM	Top/Bottom	#14-2	Y	5	Y	N	Small Hub Opening	G90 Steel	UL
	UTH5213CFLMEP	#6-350MCM	Top/Bottom	#14-2	Y	5	Y	N	Small Hub Cover Plate	G90 Steel	UL, MEG
	UTH5213CMEP	#6-350MCM	Top/Bottom	#14-2	Y	5	Y	N	Small Hub Cover Plate	G90 Steel	UL, CMP
	UTH5213UFLMEP	#6-350MCM	Top/Bottom	#14-2	Y	5	Y	N	Large Hub Cover Plate	G90 Steel	UL, MEG
	UTH5233CMEP	#6-350MCM	Top/Bottom	#14-2	Y	5	Y	N	Small Hub Cover Plate	G90 Steel	UL, CMP
320	UATH5300TFLMEP ¹	Studs – (1) 600MCM or (2) 350MCM	Top/Bottom	#14 -1/0	Y	5	Y	N	Large Hub Opening	Aluminum	UL, MEG
	UATH5330UFLMEP ¹	Studs – (1) 600MCM or (2) 350MCM	Top/Bottom	#14 -1/0	Y	5	Y	N	Large Hub Cover Plate	Aluminum	UL, MEG
	UTH5300TFLMEP ¹	Studs – (1) 600MCM or (2) 350MCM	Top/Bottom	#14-1/0	Y	5	Y	N	Large Hub Opening	G90 Steel	UL, MEG
	UTH5330UFLMEP ¹	Studs – (1) 600MCM or (2) 350MCM	Top/Bottom	#14-2	Y	5	Y	N	Large Hub Cover Plate	G90 Steel	UL, MEG

¹ Lugs not included. This product comes with studs only. Order lugs separately, see Accessories on page 2-9. One lug per kit, order appropriate QTY needed. For example, order three lugs (A, C, N) if meter is 1-Phase or four lugs (A, B, C, N) if meter is 3-Phase.

Accessories



ARP00003MEP, ARP00004MEP, ARP00005MEP,
ARP00006MEP, ARP00007MEP



ARP00017MEP, ARP00018MEP, ARP00019MEP,
ARP00020MEP, ARP00021MEP



ARP000035MEP

Model Number	Description
ARP00118MEP	One Lug for (2) #6 - 250MCM Cables/Phase
ARP00429MEP	One Lug for (1) #4-600M Cables/Phase or (2) 1/0-250 Cables/Phase
ARP00427MEP	Connector Kit (2) 350MCM#6 3/8 Studs for lever bypass 1009788AMEP, 1008435MEP, UTH4330TMEP, UTH4330TMEP, UGTH4330TMEP, UBTH4330TMEP, 1007672MEP, 1009260MEP
ARP00129MEP	Connector Kit #4-600MCM
ARP00326MEP	5th Terminal Kit Lever Bypass
ARP00035MEP	5th Terminal Kit Non-Lever Bypass
ARP01595MEP	HQ Bolt-on Shield for 1009788AMEP (flash shield over jaws)
ARP00984MEP	Anti-Inversion Clip (10 per package)
ARP01590MEP	DTE Auxillary Service Kit
1006630AMEP	Auxillary Contacts Enclosure G90
ARP00920MEP	Plastic Meter Socket Cover Plate
ARP90015932MEP	2R1121 Wire Front Assembly
ARP00759MEP	HQ Neutral Insulating Kit

Hub Kits

Model Number	Description
ARP00003MEP	1" Hub Kit, Small
ARP00004MEP	1.25" Hub Kit, Small
ARP00005MEP	1.5" Hub Kit, Small
ARP00006MEP	2" Hub Kit, Small
ARP00007MEP	2.5" Hub Kit, Small
ARP00017MEP	2" Hub Kit, Large
ARP00018MEP	2.5" Hub Kit, Large
ARP00019MEP	3" Hub Kit, Large
ARP00020MEP	3.5" Hub Kit, Large
ARP00021MEP	4" Hub Kit, Large

Hub Cover Plates

Model Number	Description
ARP00002MEP	Small Steel Hub Cover Plate for 3.31" Hub Openings
ARP00008MEP	Small Aluminum Hub Cover Plate for 3.31" Hub Openings
ARP00015MEP	Adapter Plt: 5" to 3.31" Hub
ARP00016MEP	Large Steel Hub Cover Plate for 5" Hub Openings
ARP00023MEP	Large Aluminum Hub Cover Plate for 5" Hub Openings

Data subject to change without notice.

Technical Data

Model Number	Gross Weight (lbs.)	Enclosure Style ¹	Cabinet Dimensions (inches)			Knockout Figure ²	Std. Pkg.
			Height (A)	Width (B)	Depth (C)		
1004709DMEP	13	A	14	8	4-2/5	13	1
1004710EMEP	13	A	14	11	4-1/10	14	1
1006385BMEP	7	A	10-9/10	8	3-1/2	15	1
1007003CMEP	13	B	16-1/2	14	3-1/2	3	1
1007361CMEP	22	B	16-1/2	14	3-1/2	3	1
1007665AMEP	12	A	14	8	4-2/5	16	1
1007665MEP	10	A	14	8	4-2/5	16	1
1007670MEP	24	A	19	13	5	11	1
1007672MEP	38	C	38-1/4	15-1/2	6-2/5	4	1
1008068MEP	39	C	34-1/2	16-1/4	6-1/2	5	1
1008435MEP	33	D	36-3/5	15	5-7/10	4	1
1008801MEP	25	A	19	13	5	30	1
1008836MEP	41	C	36-3/5	15	6-1/2	28	1
1008837MEP	26	C	36-3/5	15	6-1/2	28	1
1009260MEP	38	C	36-3/5	15	5-7/10	4	1
1009788AMEP	31	A	34-1/2	13	5	17	1
1009995MEP	25	A	19	13	5	11	1
1011692MEP	25	A	19	13	5	11	1
MEPKR1AS1BTZ	7	A	10-9/10	8	3-1/2	19	1
MEPKR1CS1BT	14	A	15	11	4-2/5	6	1
MEPKR1DH1DQRZ	18	E	17-1/10	13	5	9	1
MEPKS1AS1BT	8	A	10-9/10	8	3-1/2	19	1
MEPKS1AS1BTV	7	A	10-9/10	8	3-1/2	31	1
MEPKS1CS1BJT	12	A	14	8	4-2/5	7	1
MEPKS1CS1BJTV	11	A	14	8	4-2/5	7	1
MEPKS1CS1DT	15	A	15	11	4-2/5	6	1
MEPKS1CS1DTV	14	A	15	11	4-2/5	6	1
MEPKS1DS1AT	16	D	13	13	5	21	1
MEPKS1DS1ATV	15	D	13	13	5	8	1
MEPKU1CW3CT	25	A	19	13	5	11	1
MEPKU1FS1EMT	41	C	36-3/5	15	6	4	1
U92197CCCPLMEP	17	E	17-1/10	13	5	9	1
UAFTH4330TSHMEP	22	C	36-3/5	15	5-7/10	4	1
UAFTH4336TSHMEP	28	C	36-3/5	15	5-7/10	4	1
UAFTH5213BNDMEP	19	A	19	13	5	11	1
UAFTH7213TSHMEP	19	A	19	13	5	11	1
UAFTH7330TSHMEP	37	C	39-9/10	20	6-1/2	18	1
UAFTH7336TSHMEP	39	C	39-9/10	20	6-1/2	18	1
UAFHTRS202BSHMEP	8	A	14	8	4-2/5	23	1
UAFHTRS223ASHMEP	10	C	13	13	5	8	1
UATH4203BFLMEP	18	A	19	10-1/2	5	22	1
UATH4203TFLMEP	18	A	19	10-1/2	5	22	1
UATH4213CFLMEP	18	A	19	13	5	29	1
UATH4213UFLMEP	18	A	19	13	5	29	1
UATH4300TFLMEP	39	F	34-1/2	13	5	12	1
UATH5203BFLMEP	17	A	19	10-1/2	5	22	1
UATH5203TFLMEP	17	A	19	10-1/2	5	22	1
UATH5213CFLMEP	18	A	19	13	5	11	1
UATH5213UFLMEP	18	A	19	13	5	11	1
UATH5300TFLMEP	18	A	34-1/2	13	5	12	1
UATH5330UFLMEP	36	C	39-9/10	20	6-1/2	18	1
UATH7203BFLMEP	18	A	19	10-1/2	5	22	1
UATH7203TFLMEP	18	A	19	10-1/2	5	22	1
UATH7213CFLMEP	18	A	19	13-2/5	5	12	1
UATH7213UFLMEP	18	A	19	13-2/5	5	12	1
UATH7300TFLMEP	23	F	34-1/2	15	5-7/10	12	1

¹ Enclosure Styles on page 2-12.

² Knockout Figures on pages 2-13–2-14.

Data subject to change without notice.

Single Socket

Technical Data

Single Socket

Model Number	Gross Weight (lbs.)	Enclosure Style ¹	Cabinet Dimensions (inches)			Knockout Figure ²	Std. Pkg.
			Height (A)	Width (B)	Depth (C)		
UATH7300UFLMEP	23	C	34-1/2	15	5-7/10	12	1
UATH7330UFLMEP	36	B	39-9/10	20	6-1/2	34	1
UATRS202BFLMEP	11	A	14	8	4-2/5	23	1
UATRS212CFLMEP	9	A	14	11	4-2/5	24	1
UATRS213AFLMEP	9	A	15	11-2/5	4-2/5	25	1
UATRS213CFLMEP	9	A	15	11	4-2/5	25	1
UATRS223AFLMEP	10	D	13	13	5	21	1
UATZRS101CFLMEP	7	A	10-9/10	8	3-1/2	19	1
UBC7213BMEP	21	A	19	13	5	11	1
UBH7213TMEP	24	A	19	13	5	11	1
UBHRS101BMEP	7	A	10-9/10	8	3-1/2	19	1
UBHRS202BMEP	11	A	14	8	4-2/5	7	1
UBHRS212BMEP	13	A	14	11	4-2/5	10	1
UFHTRS101BMEP	8	A	10-9/10	8	3-1/2	19	1
UFHTRS202BMEP	12	A	14	8	4-2/5	7	1
UFHTRS223AMEP	16	A	14	8	4-2/5	7	1
UFHTRS233CMEP	18	C	17-1/10	13	5	8	1
UFTH4213CMEP	25	A	19	13	5	11	1
UFTH4330TMEP	41	C	36-3/5	15	5-7/10	4	1
UFTH4336TMEP	42	C	36-3/5	15	5-7/10	4	1
UFTH5213BNDMEP	26	A	19	13	5	11	1
UFTH7213BMEP	26	A	19	13	5	11	1
UFTH7213TMEP	26	A	19	13	5	11	1
UFTH7330TMEP	65	C	39-9/10	20	6-1/2	18	1
UFTH7336TMEP	42	C	39-9/10	20	6-1/2	18	1
UFTTH7213TMEP	26	A	19	13	5	11	1
UFTTH7330TMEP	65	C	39-9/10	20	6-1/2	18	1
UFTTH7336TMEP	67	C	39-9/10	20	6-1/2	18	1
UGHRS212CKCMEP	13	A	14	11	4-2/5	1	1
UGHTRS101BMEP	7	A	10-9/10	8	3-1/2	19	1
UGHTRS213BMEP	14	A	15	11	4-2/5	6	1
UGTH4213CMEP	24	A	19	13	5	32	1
UGTRS213CMEP	14	A	15	11	4-2/5	6	1
UH4213CMEP	24	A	19	13	5	11	1
UH43068TCPLMEP	35	F	34-1/2	13	5	12	1
UH7213CKCMEP	24	A	19	13	5	2	1
UH7213CMEP	23	A	19	13	5	11	1
UHTRS101BMEP	7	A	10-9/10	8	3-1/2	19	1
UHTRS202BMEP	10	A	14	8	4-2/5	7	1
UHTRS223AMEP	14	D	13	13	5	8	1
URS101BCPLMEP	7	A	10-9/10	8	3-1/2	19	1
URS101CCPLMEP	7	A	10-9/10	8	3-1/2	19	1
URSTS132CMEP	23	A	20	12	4-2/5	33	1
URTRS213AMEP	15	A	15	11	4-2/5	15	1
UT92197CCFLMEP	17	D	17-1/10	13	5	27	1
UTH4203BFLMEP	23	A	19	10-1/2	5	22	1
UTH4203TFLMEP	23	A	19	10-1/2	5	22	1
UTH4213BMEP	23	A	19	13	5	11	1
UTH4213CFLMEP	28	A	19	13	5	11	1
UTH4213CMEP	25	A	19	13	5	11	1
UTH4213UFLMEP	28	A	19	13	5	11	1
UTH4300TFLMEP	32	F	34-1/2	13	5	12	1
UTH4300TMEP	32	C	34-1/2	13	5	4	1
UTH4330TMEP	39	C	36-2/5	15	5-7/10	4	1
UTH43369TMEP	40	C	36-2/5	15	5-7/10	4	1
UTH5203BFLMEP	23	A	19	10-1/2	5	22	1

¹ Enclosure Styles on page 2-12.

² Knockout Figures on pages 2-13-2-14.

Data subject to change without notice.

Technical Data

Single Socket

Model Number	Gross Weight (lbs.)	Enclosure Style ¹	Cabinet Dimensions (inches)			Knockout Figure ²	Std. Pkg.
			Height (A)	Width (B)	Depth (C)		
UTH5203BMEP	23	A	19	10-1/2	5	22	1
UTH5203TFLMEP	23	A	19	10-1/2	5	22	1
UTH5213BNDMEP	22	A	19	13	5	11	1
UTH5213CFLMEP	25	A	19	13	5	11	1
UTH5213CMEP	22	A	19	13	5	11	1
UTH5213UFLMEP	25	A	19	13	5	11	1
UTH5233CMEP	43	C	19	13	5	27	1
UTH5300TFLMEP	32	F	34-1/2	13	5	12	1
UTH5330UFLMEP	46	C	39-9/10	20	6-1/2	18	1
UTH7203BFLMEP	23	A	19	10-1/2	5	22	1
UTH7203TFLMEP	23	A	19	10-1/2	5	22	1
UTH7203TMEP	23	A	19	10-1/2	5	22	1
UTH7213BMEP	24	A	19	13	5	11	1
UTH7213CMEP	25	A	19	13	5	11	1
UTH7213THLMEP	25	A	19	13	5	11	1
UTH7213TMEP	23	A	19	13	5	11	1
UTH7213UMEP	25	A	19	13	5	11	1
UTH7300TFLMEP	35	F	34-1/2	15	5-7/10	12	1
UTH73069THLMEP	39	A	34-1/2	15	5-7/10	20	1
UTH7330TMEP	62	C	39-9/10	20	6-1/2	18	1
UTH7330UFLMEP	64	C	39-9/10	20	6-1/2	18	1
UTH73369THLMEP	64	C	39-9/10	20	6-1/2	18	1
UTJ7300UMEP	45	A	36-1/10	15	5-3/4	4	1
UTRS101BMEP	7	A	10-9/10	8	3-1/2	19	1
UTRS202BMEP	10	A	14	8	4-2/5	7	1
UTRS212BMEP	10	A	14	11	4-2/5	10	1
UTRS212CMEP	13	A	14	11	4-2/5	10	1
UTRS2138BMEP	19	A	20	13	5	28	1
UTRS213AFLMEP	14	A	15	11	4-2/5	12	1
UTRS213BMEP	12	A	15	11	4-2/5	6	1
UTRS213CFLMEP	14	A	15	11	4-2/5	12	1
UTRS213CMEP	13	A	15	11	4-2/5	6	1
UTRS223AFLMEP	15	D	13	13	5	21	1
UTRS223AMEP	14	D	13	13	5	21	1
UTRS502BMEP	10	A	14	8	4-2/5	7	1
UTZRS101CFLMEP	7	A	10-9/10	8	3-1/2	26	1

¹ Enclosure Styles on page 2-12.

² Knockout Figures on pages 2-13--2-14.

Enclosure Styles / Cabinet Dimensions

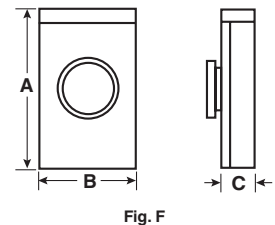
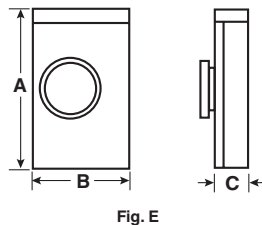
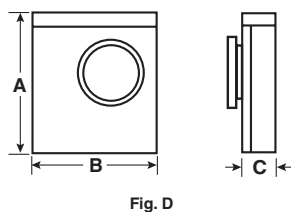
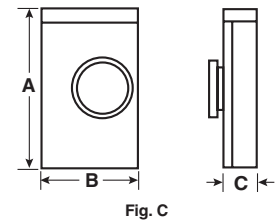
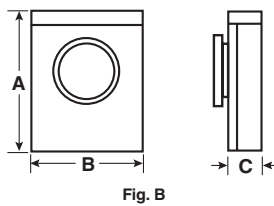
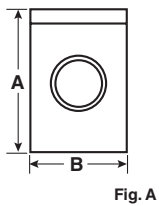

Data subject to change without notice.

Knockout Configurations

Single Socket

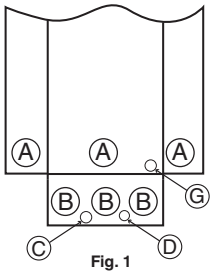

Fig. 1

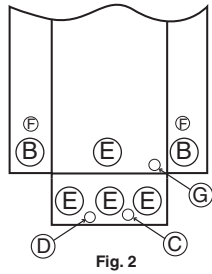

Fig. 2

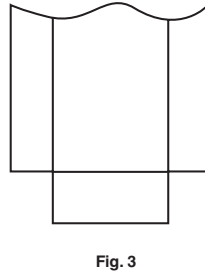

Fig. 3

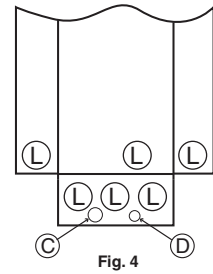

Fig. 4

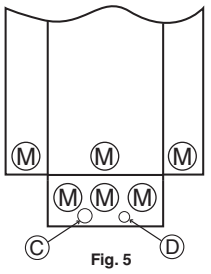

Fig. 5

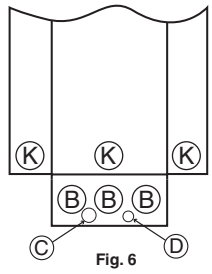

Fig. 6

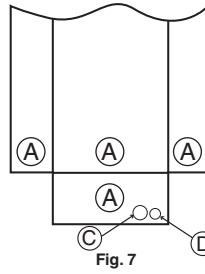

Fig. 7

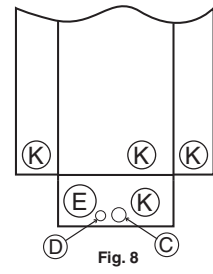

Fig. 8

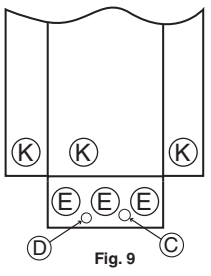

Fig. 9

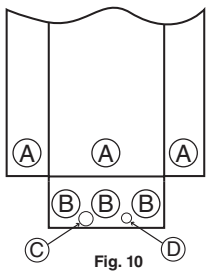

Fig. 10

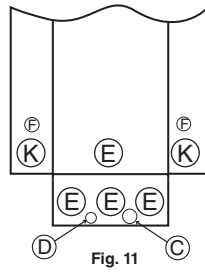

Fig. 11

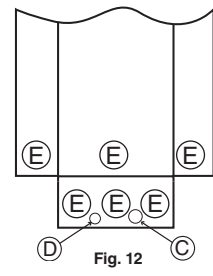

Fig. 12

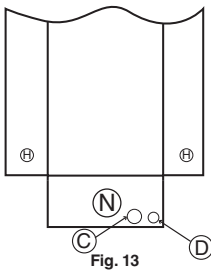

Fig. 13

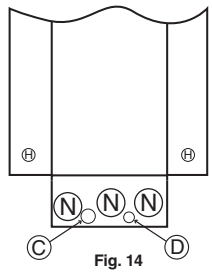

Fig. 14

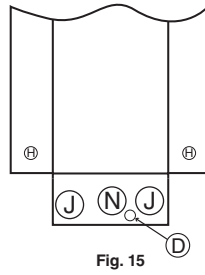

Fig. 15

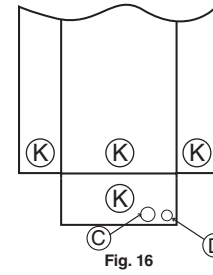

Fig. 16

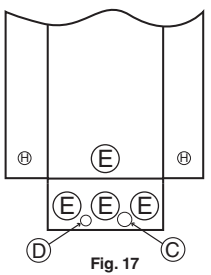

Fig. 17

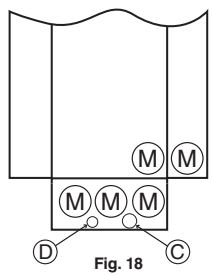

Fig. 18

Knockout Key

- A = 1-1/2", 2", 2-1/2"
- B = 1-1/4", 1-1/2", 2", 2-1/2"
- C = 1/2"
- D = 5/16"
- E = 2", 2-1/2", 3"
- F = 1/2", 3/4"
- G = 7/16"
- H = 3/4"

- I = 1-1/4", 1-1/2", 2"
- J = 1/2", 3/4", 1", 1-1/4"
- K = 1", 1-1/4", 1-1/2", 2", 2-1/2"
- L = 2", 2-1/2", 3", 3-1/2"
- M = 2", 2-1/2", 3", 3-1/2", 4"
- N = 1", 1-1/4", 1-1/2", 2"
- O = 1/2", 3/4", 1", 1-1/4", 1-1/2"

* Knockouts shown for size not for exact positions.

Knockout Configurations

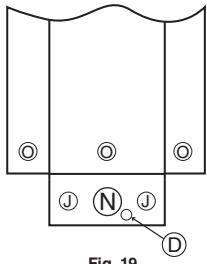

Fig. 19

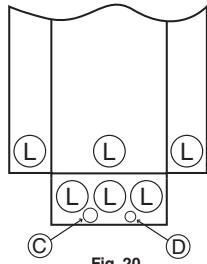

Fig. 20

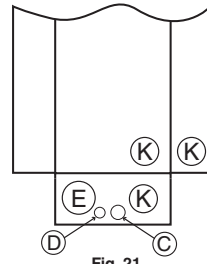

Fig. 21

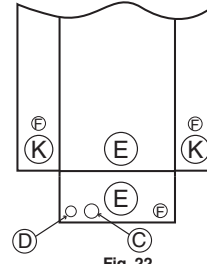

Fig. 22

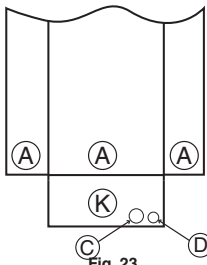

Fig. 23

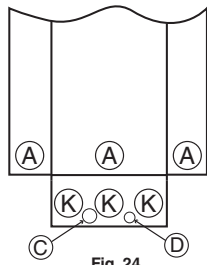

Fig. 24

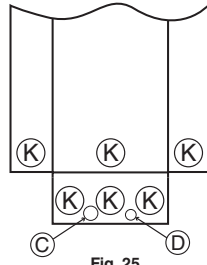

Fig. 25

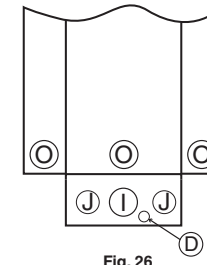

Fig. 26

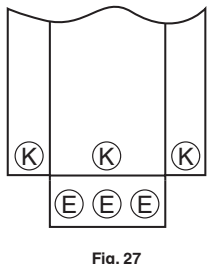

Fig. 27

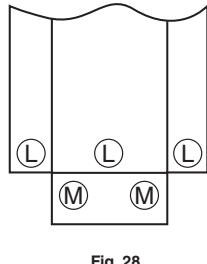

Fig. 28

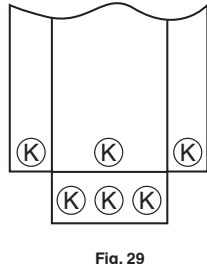

Fig. 29

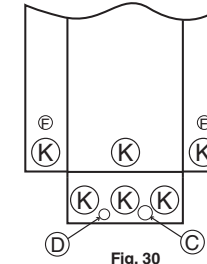

Fig. 30

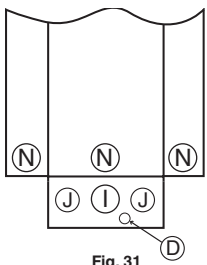

Fig. 31

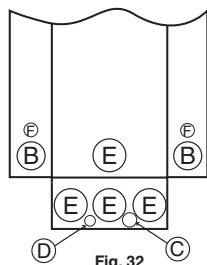

Fig. 32

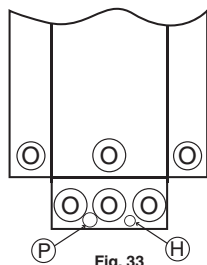

Fig. 33

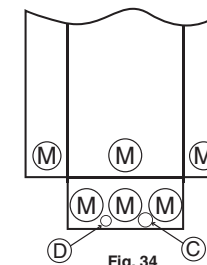

Fig. 34

Knockout Key

- | | |
|--------------------------------|------------------------------------|
| A = 1-1/2", 2", 2-1/2" | I = 1-1/4", 1-1/2", 2" |
| B = 1-1/4", 1-1/2", 2", 2-1/2" | J = 1/2", 3/4", 1", 1-1/4" |
| C = 1/2" | K = 1", 1-1/4", 1-1/2", 2", 2-1/2" |
| D = 5/16" | L = 2", 2-1/2", 3", 3-1/2" |
| E = 2", 2-1/2", 3" | M = 2", 2-1/2", 3", 3-1/2", 4" |
| F = 1/2", 3/4" | N = 1", 1-1/4", 1-1/2", 2" |
| G = 7/16" | O = 1/2", 3/4", 1", 1-1/4", 1-1/2" |
| H = 3/4" | |

* Knockouts shown for size not for exact positions.

Data subject to change without notice.

Transformer Rated Sockets

1-Phase, 20 Amps, 600V

FP&L Approved¹

Amps	Model Number	End Lug Size (CU/AL)	Side Lug Size (CU/AL)	Overhead/Underground Line Feed	Number of Terminals	Hub Type	Enclosure N3R	Certification
20	UASTH61C755GE	#14-2	#14-2	Top/Bottom	6	Small Hub Cover Plate	Aluminum	UL, FP&L
	USTH61C756MEP	#14-2	#14-2	Top/Bottom	6	Small Hub Cover Plate	Steel	
	UASTH131B757MEP	#14-2	#14-2	Top/Bottom	13	Small Hub Opening	Aluminum	
	USTH131C758MEP	#14-2	#14-2	Top/Bottom	13	Small Hub Cover Plate	Steel	

¹ Units come with a test switch (not pre-wired) and have a one piece ringless cover.

TECO Approved¹

Amps	Model Number	End Lug Size (CU/AL)	Side Lug Size (CU/AL)	Overhead/Underground Line Feed	Number of Terminals	Hub Type	Enclosure N3R	Certification
20	URSTH62B759MEP	#14-2	#14-2	Top/Bottom	6	Small Hub Opening	Steel	UL, TECO
	UARSTH62B760MEP	#14-2	#14-2	Top/Bottom	6	Small Hub Opening	Aluminum	
	URSTH132C761MEP	#14-2	#14-2	Top/Bottom	13	Small Hub Cover Plate	Steel	
	UARSTH132C762MEP	#14-2	#14-2	Top/Bottom	13	Small Hub Cover Plate	Aluminum	

¹ Units are pre-wired with test switch (per TECO specs) and have a two piece ring type cover.

Accessories

Model Number	Description
ARP00920MEP	Plastic Meter Socket Cover Plate

Hub Kits

Model Number	Description
ARP00003MEP	1" Hub Kit, Small
ARP00004MEP	1.25" Hub Kit, Small
ARP00005MEP	1.5" Hub Kit, Small
ARP00006MEP	2" Hub Kit, Small
ARP00007MEP	2.5" Hub Kit, Small



ARP00003MEP, ARP00004MEP, ARP00005MEP,
 ARP00006MEP, ARP00007MEP

Hub Cover Plates

Model Number	Description
ARP00002MEP	Small Steel Bolt-on Hub Cover Plate, 3-5/16" x 3-5/16"
ARP00008MEP	Small Aluminum Bolt-on Hub Cover Plate, 3-5/16" x 3-5/16"

Technical Data

Model Number	Gross Weight (lbs.)	Cabinet Dimensions (inches)			Std. Pkg.
		Height (A)	Width (B)	Depth (C)	
UASTH61C755GE	19	20	12	4-9/25	1
USTH61C756GE	26				
UASTH131B757GE	19				
USTH131C758GE	27				
URSTH62B759GE	23				
UARSTH62B760GE	19				
URSTH132C761GE	27				
UARSTH132C762GE	29				

Single Socket

Cabinet Dimensions

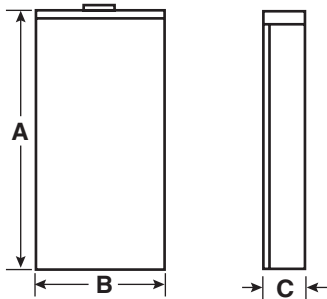

Knockout Configurations

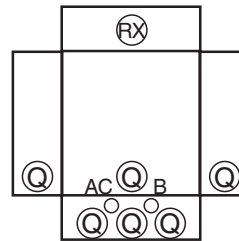

Knockout Key

- B = 1/2", 3/4"
- Q = 1", 1-1/4", 1-1/2"
- AC = 1/4", 1/2"
- RX = ø7.750 Hub OP

Section 3

Horizontal Meter Sockets



Application Information

Midwest's Horizontal Metering offers metering options for strip malls and small commercial buildings with 2 – 6 metering locations. Available in 100A – 200A. Has compact vertical footprint. Utility certifications available on selected models.



Features and Benefits

- Single phase
- Top / Bottom Feed
- Multiple hub opening and closure plate sizes available
- Hub opening in top endwall, requires use of a bolt-on hub or closing plate
- 1Ø, 600 Vac maximum
- Main lugs only

Rugged Durability

- NEMA 3R enclosure
- 2 through 6 meter positions, with and without horn or lever bypass

Installation Ease

- Overhead and underground service feeds
- End or center feed

User Safety

- Selected items are utility approved
- 10 kA short circuit rating (or higher with utility approval)



Horizontal Mtr Socket

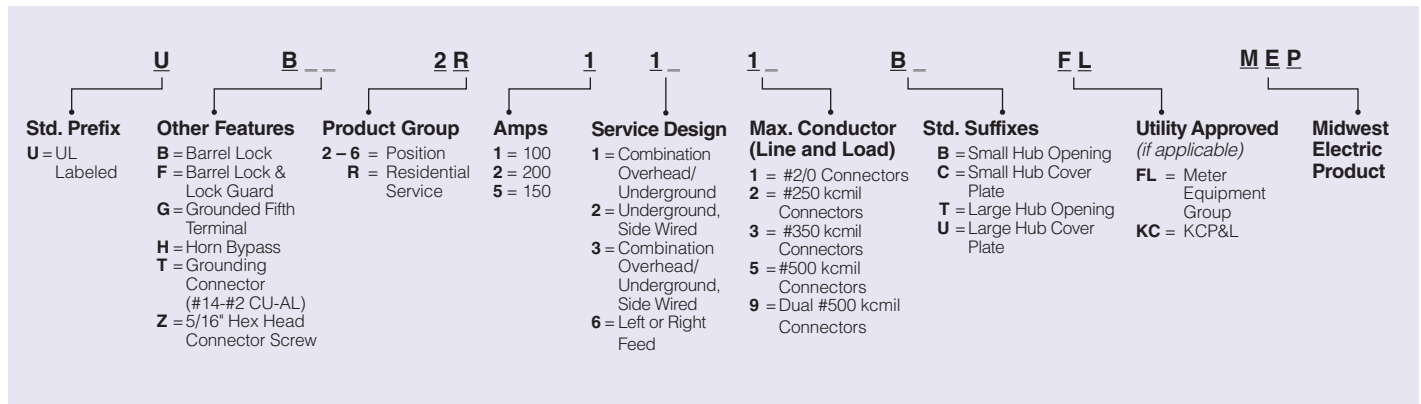

* Model numbers beginning with "10" or "MEP" will not follow the nomenclature.

Data subject to change without notice.

Two or Three Sockets

1-Phase, Top/Bottom Feed, 100 – 200 Amps

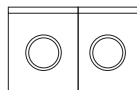

Fig. A
MEPKR2CS1ET

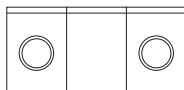

Fig. B
UBH2R1121BMEP, UT2R1121BMEP,
UT2R1121CFLMEP, UG2R5332CKCMEP,
UT2R5332BMEP, 1006737BMEP,
U2R2332UMEP, UBH2R2332TMEP,
UFHT2R2332TMEP, UHT2R2332TMEP,
UT2R2332TMEP, UT2R2332UFLMEP

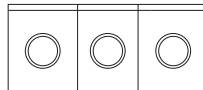

Fig. C
UT3R5632BMEP

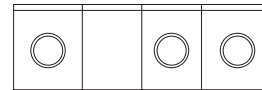

Fig. D
MEPKR3CS1ET, UBH3R1121BMEP, UT3R1121BMEP,
UT3R1121CFLMEP, UBH3R2332TMEP,
UFHT3R2332TMEP, UHT3R2332TMEP,
UT3R2332TMEP, UT3R2332UFLMEP

Horizontal Mtr Socket

Fig.	Model Number Ringless	Amps	Feed Type	Line Wire Range (CU/AL)	Ground Lug Size	Triplex Ground	Number of Terminals	Lever Bypass	Horned Bypass	Hub Type	Enclosure N3R	UL and Utility Approved
A	MEPKR2CS1ET	200	Center	#8-250MCM Load	#14-2	Y	4	N	N	Large Hub Cover Plate	G90 Steel	UL
B	UBH2R1121BMEP	100	Center	#6-250MCM Line #8-2/0 Load	No Ground	N	4	N	Y	Small Hub Opening	G90 Steel	UL
B	UT2R1121BMEP	100	Center	#6-250MCM Line #8-2/0 Load	#14-2	Y	4	N	N	Small Hub Opening	G90 Steel	UL, CMP
B	UTZ2R1121CFLMEP	100	Center	#6-350MCM Line #8-250MCM Load	#14-2	Y	4	N	N	Large Hub Cover Plate	G90 Steel	UL, MEG
B	UG2R5332CKCMEP	150	Center	#6-350MCM Line #8-250MCM Load	No Ground	N	5	N	N	Small Hub Cover Plate	G90 Steel	UL, KCP&L
B	UT2R5332BMEP	150	Center	#6-350MCM Line #8-250MCM Load	#14-2	Y	4	N	N	Small Hub Opening	G90 Steel	UL
B	1006737BMEP	200	Center	3/8" Stud Line-Max 350MCM ¹ #8-250 MCM Load	No Ground	N	4	N	N	Large Hub Cover Plate	G90 Steel	UL, DTE
B	U2R2332UMEP	200	Center	#6-350MCM Line #8-250MCM Load	No Ground	N	4	N	N	Large Hub Cover Plate	G90 Steel	UL
B	UBH2R2332TMEP	200	Center	#6-350MCM Line #8-250MCM Load	No Ground	N	4	N	Y	Large Hub Opening	G90 Steel	UL
B	UFHT2R2332TMEP	200	Center	#8-350MCM Line #8-250MCM Load	#14-2	Y	4	N	Y	Large Hub Opening	G90 Steel	UL, AEP
B	UHT2R2332TMEP	200	Center	#6-350MCM Line #8-250MCM Load	#14-2	Y	4	N	Y	Large Hub Opening	G90 Steel	UL
B	UT2R2332TMEP	200	Center	#6-350MCM Line #8-250MCM Load	#14-2	Y	4	N	N	Large Hub Opening	G90 Steel	UL, CMP
B	UT2R2332UFLMEP	200	Center	#6-350MCM Line #8-2/0 Load	#14-2	Y	4	N	N	Small Hub Cover Plate	G90 Steel	UL, MEG
C	UT3R5632BMEP	150	End	#6-350MCM Line #8-250MCM Load	#14-2	Y	4	N	N	Small Hub Opening, Small Hub Cover Plate	G90 Steel	UL
D	UBH3R1121BMEP	100	Center	#6-250MCM Line #8-2/0 Load	No Ground	N	4	N	Y	Small Hub Opening	G90 Steel	UL
D	UT3R1121BMEP	100	Center	#6-250MCM Line #8-2/0 Load	#14-2	Y	4	N	N	Small Hub Opening	G90 Steel	UL, CMP
D	UTZ3R1121CFLMEP	100	Center	#6-350MCM Line #8-250MCM Load	#14-2	Y	4	N	N	Large Hub Cover Plate	G90 Steel	UL, MEG
D	MEPKR3CS1ET	200	Center	#8-250MCM Load	#14-2	Y	4	N	N	Large Hub Cover Plate	G90 Steel	UL
D	UBH3R2332TMEP	200	Center	#6-350MCM Line #8-250MCM Load	No Ground	N	4	N	Y	Large Hub Opening	G90 Steel	UL
D	UFHT3R2332TMEP	200	Center	#6-350MCM Line #8-250MCM Load	#14-2	Y	4	N	Y	Large Hub Opening	G90 Steel	UL, AEP
D	UHT3R2332TMEP	200	Center	#6-350MCM Line #8-250MCM Load	#14-2	Y	4	N	Y	Large Hub Opening	G90 Steel	UL
D	UT3R2332TMEP	200	Center	#6-350MCM Line #8-250MCM Load	#14-2	Y	4	N	N	Large Hub Opening	G90 Steel	UL, CMP
D	UT3R2332UFLMEP	200	Center	#6-350MCM Line #8-2/0 Load	#14-2	Y	4	N	N	Small Hub Cover Plate	G90 Steel	UL, MEG

¹ Lugs not included. This product comes with studs only. Order lugs separately, see Accessories on page 3-5. One lug per kit, order appropriate QTY needed.
For example, order three lugs (A, C, N) if meter is 1-Phase or four lugs (A, B, C, N) if meter is 3-Phase.

Data subject to change without notice.

Section 3 – Horizontal Meter Sockets

Four, Five or Six Sockets

1-Phase, Top/Bottom Feed, 100 – 200 Amps

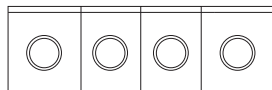

Fig. E
UT4R5632BMEP

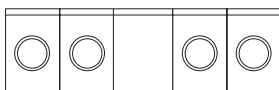

Fig. F
MEPKR4CS1ET, UT4R1121BMEP,
UTZ4R1121CFLMEP, UFHT4R2352TMEP,
UHT4R2352TMEP, UT4R2352TMEP,
UT4R2352UFLMEP

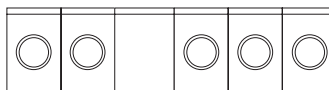

Fig. G
UT5R1121BMEP, UTZ5R1121CFLMEP,
MEPKR5CS1ET, UFHT5R2392TTMEP,
UT5R2392TTMEP, UT5R2392UFLMEP

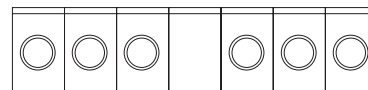

Fig. H
UT6R1131BMEP, UTZ6R1131CFLMEP,
MEPKR6CS1ET, UFHT6R2392TTMEP,
UHT6R2392TTMEP, UT6R2392TTMEP,
UT6R2392UFLMEP

Fig.	Model Number Ringless	Amps	Feed Type	Line Wire Range (CU/AL)	Ground Lug Size	Triplex Ground	Number of Terminals	Lever Bypass	Horned Bypass	Hub Type	Enclosure N3R	UL and Utility Approved
E	UT4R5632BMEP	150	End	#6-350MCM Line #8-250MCM Load	#14-2	Y	4	N	N	Small Hub Opening, Small Hub Cover Plate	G90 Steel	UL
F	UT4R1121BMEP	100	Center	#6-250MCM Line #8-2/0 Load	#14-2	Y	4	N	N	Small Hub Opening	G90 Steel	UL, CMP
F	UTZ4R1121CFLMEP	100	Center	1/0-500MCM Line #8-250MCM Load	#14-1/0	Y	4	N	N	Large Hub Cover Plate	G90 Steel	UL, MEG
F	MEPKR4CS1ET	200	Center	#8-250MCM Load	#14-2	Y	4	N	N	Large Hub Cover Plate	G90 Steel	UL
F	UFHT4R2352TMEP	200	Center	1/0-500MCM Line #8-250MCM Load	#14-1/0	Y	4	N	Y	Large Hub Opening	G90 Steel	UL, AEP
F	UHT4R2352TMEP	200	Center	1/0-500MCM Line #8-250MCM Load	#14-2	Y	4	N	Y	Large Hub Opening	G90 Steel	UL
F	UT4R2352TMEP	200	Center	1/0 - 500MCM Line #8-250MCM Load	#14-1/0	Y	4	N	N	Large Hub Opening	G90 Steel	UL, CMP
F	UT4R2352UFLMEP	200	Center	#6-250MCM Line #8-2/0 Load	#14-2	Y	4	N	N	Small Hub Cover Plate	G90 Steel	UL, MEG
G	UT5R1121BMEP	100	Center	#6-250MCM Line #8-2/0 Load	#14-2	Y	4	N	N	Small Hub Opening	G90 Steel	UL, CMP
G	UTZ5R1121CFLMEP	100	Center	#6-250MCM Line #8-2/0 Load	#14-2/0	Y	4	N	N	(2) Large Hub Cover Plates	G90 Steel	UL, MEG
G	MEPKR5CS1ET	200	Center	1/0-500MCM Line #8-250MCM Load	#14-2/0	Y	4	N	N	(2) Large Hub Cover Plates	G90 Steel	UL
G	UFHT5R2392TTMEP	200	Center	1/0-500MCM Line #8-250MCM Load	#14-2/0	Y	4	N	Y	(2) Large Hub Openings	G90 Steel	UL, AEP
G	UT5R2392TTMEP	200	Center	1/0-500MCM Line #8-250MCM Load	#14-2/0	Y	4	N	N	(2) Large Hub Openings	G90 Steel	UL, CMP
G	UT5R2392UFLMEP	200	Center	1/0-500MCM Line #8-250MCM Load	#14-2	Y	4	N	N	Small Hub Cover Plate	G90 Steel	UL, MEG
H	UT6R1131BMEP	100	Center	#6-350MCM Line #8-2/0 Load	#14-2	Y	4	N	N	Small Hub Opening	G90 Steel	UL, CMP
H	UTZ6R1131CFLMEP	100	Center	1/0-500MCM Line #8-250MCM Load	#14-2/0	Y	4	N	N	(2) Large Hub Cover Plates	G90 Steel	UL, MEG
H	MEPKR6CS1ET	200	Center	1/0-500MCM Line #8-250MCM Load	#14-2/0	Y	4	N	N	(2) Large Hub Cover Plates	G90 Steel	UL
H	UFHT6R2392TTMEP	200	Center	1/0-500MCM Line #8-250MCM Load	#14-2/0	Y	4	N	Y	(2) Large Hub Openings	G90 Steel	UL, AEP
H	UHT6R2392TTMEP	200	Center	1/0-500MCM Line #8-250MCM Load	#14-2/0	Y	4	N	Y	(2) Large Hub Openings	G90 Steel	UL
H	UT6R2392TTMEP	200	Center	1/0-500MCM Line #8-250MCM Load	#14-2/0	Y	4	N	N	(2) Large Hub Openings	G90 Steel	UL, CMP
H	UT6R2392UFLMEP	200	Center	#6-350MCM Line #8-2/0 Load	#14-2	Y	4	N	N	Small Hub Cover Plate	G90 Steel	UL, MEG

Data subject to change without notice.

Accessories



ARP00003MEP, ARP00004MEP, ARP00005MEP,
ARP00006MEP, ARP00007MEP



ARP00017MEP, ARP00018MEP, ARP00019MEP,
ARP00020MEP, ARP00021MEP



ARP000035MEP

Model Number	Description
ARP00118MEP	One Lug for (2) #6 - 250MCM Cables/Phase
ARP00429MEP	One Lug for (1) #4-600M Cables/Phase or (2) 1/0-250 Cables/Phase
ARP00129MEP	Connector Kit #4-600MCM
ARP00326MEP	5th Terminal Kit Lever Bypass
ARP00035MEP	5th Terminal Kit Non-Lever Bypass
ARP00984MEP	Anti-Inversion Clip (10 per package)
ARP01590MEP	DTE Auxiliary Service Kit
1006630AMEP	Auxiliary Contacts Enclosure G90
ARP00920MEP	Plastic Meter Socket Cover Plate
ARP90015932MEP	2R1121 Wire Front Assembly

Hub Kits

Model Number	Description
ARP00003MEP	1" Hub Kit, Small
ARP00004MEP	1.25" Hub Kit, Small
ARP00005MEP	1.5" Hub Kit, Small
ARP00006MEP	2" Hub Kit, Small
ARP00007MEP	2.5" Hub Kit, Small
ARP00017MEP	2" Hub Kit, Large
ARP00018MEP	2.5" Hub Kit, Large
ARP00019MEP	3" Hub Kit, Large
ARP00020MEP	3.5" Hub Kit, Large
ARP00021MEP	4" Hub Kit, Large

Hub Cover Plates

Model Number	Description
ARP00002MEP	Small Steel Hub Cover Plate for 3.31" Hub Openings
ARP00008MEP	Small Aluminum Hub Cover Plate for 3.31" Hub Openings
ARP00015MEP	Adapter Plate for 5" to 3.31" Hub Openings
ARP00016MEP	Large Steel Hub Cover Plate for 5" Hub Openings
ARP00023MEP	Large Aluminum Hub Cover Plate for 5" Hub Openings

Data subject to change without notice.

Technical Data

Model Number Ringless	Gross Weight (lbs.)	Enclosure Style ¹	Cabinet Dimensions (inches)			Knockout Figure ²
			Height (A)	Width (B)	Depth (C)	
1006737BMEP	28.5	D	14-1/10	24-3/10	5-2/5	11
MEPKR2CS1ET	29	D	14-1/10	24-3/10	5-4/10	4
MEPKR3CS1ET	39	E	14-1/10	32-1/2	5-4/10	7
MEPKR4CS1ET	49	H	14-1/10	40-7/10	5-4/10	15
MEPKR5CS1ET	62	A	14-1/10	54-4/5	5-2/5	1
MEPKR6CS1ET	72	B	14-1/10	63	5-2/5	2
U2R2332UMEP	28	D	14-1/10	24-3/10	5-2/5	4
UBH2R1121BMEP	27	D	14-1/10	24-3/10	4-1/2	5
UBH2R2332TMEP	28	D	14-1/10	24-3/10	5-4/10	4
UBH3R1121BMEP	34	I	14-1/10	32-1/2	4.50	6
UBH3R2332TMEP	38	I	14-1/10	32-1/2	5-2/5	7
UFHT2R2332TMEP	30	B	14-1/10	24-3/10	5-2/5	4
UFHT3R2332TMEP	41	E	14-1/10	32-1/2	5-2/5	7
UFHT4R2352TMEP	52	H	14-1/10	40-7/10	5-2/5	12
UFHT5R2392TTMEP	67	A	14-1/10	54-4/5	5-2/5	1
UFHT6R2392TTMEP	78	B	14-1/10	83	5-2/5	2
UG2R5332CKCMEP	29	D	14-1/10	24-3/10	5-2/5	4
UHT2R2332TMEP	28.2	D	14-1/10	24-3/10	5-2/5	4
UHT3R2332TMEP	36	I	14-1/10	32-1/2	5-2/5	7
UHT4R2352TMEP	48	H	14-1/10	40-7/10	5-2/5	12
UHT6R2392TTMEP	74	B	14-1/10	63	5-2/5	1
UT2R1121BMEP	25	D	14-1/10	24-3/10	4-1/2	5
UT2R2332TMEP	29	D	14-1/10	24-3/10	5-2/5	4
UT2R2332UFLMEP	27	D	14-1/10	24-9/10	4-1/2	4
UT2R5332BMEP	13	D	14-1/10	24-3/10	5-2/5	4
UT3R1121BMEP	35	I	14-1/10	32-1/2	4-1/2	6
UT3R2332TMEP	39	I	14-1/10	32-1/2	5-2/5	7
UT3R2332UFLMEP	34	I	14-1/10	40-9/10	4-1/2	7
UT3R5632BMEP	30	F	14-1/10	32-3/10	5-2/5	8
UT4R1121BMEP	42	H	14-1/10	40-7/10	4-1/2	13
UT4R2352TMEP	49	H	14-1/10	40-7/10	5-2/5	12
UT4R2352UFLMEP	42	H	14-1/10	40-7/10	4-1/2	12
UT4R5632BMEP	40	G	14-1/10	40-1/2	5-2/5	9
UT5R1121BMEP	48	A	14-1/10	48-4/5	4-1/2	13
UT5R2392TTMEP	63	A	14-1/10	54-4/5	5-2/5	1
UT5R2392UUFLMEP	49	A	14-1/10	48-4/5	4-1/2	1
UT6R1131BMEP	55	B	14-1/10	57	4-1/2	10
UT6R2392TTMEP	72	B	14-1/10	63	5-2/5	1
UT6R2392UUFLMEP	56	B	14-1/10	57	4-1/2	2
UTZ2R1121CFLMEP	29	D	14-1/10	24-3/10	5-2/5	5
UTZ3R1121CFLMEP	39	E	14-1/10	33	5-2/5	6
UTZ4R1121CFLMEP	49	H	14-1/10	40-7/10	5-2/5	13
UTZ5R1121CFLMEP	63	A	14-1/10	54-4/5	5-2/5	14
UTZ6R1131CFLMEP	73	B	14-1/10	63	5-2/5	10

¹ Enclosure Styles on page 3-7.² Knockout Figures on pages 3-8–3-9.

Enclosure Styles / Cabinet Dimensions

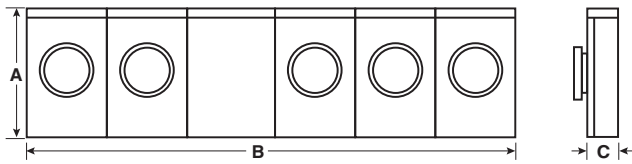

Fig. A

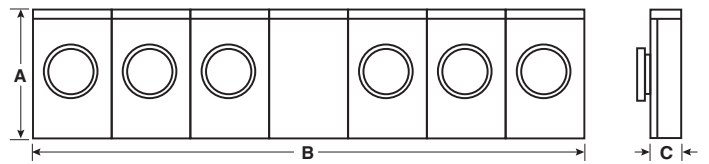

Fig. B

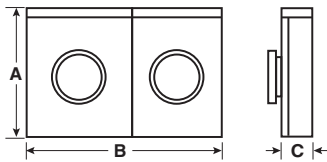

Fig. C

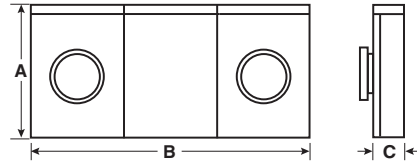

Fig. D

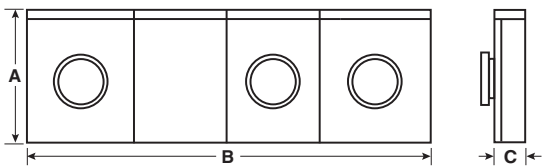

Fig. E

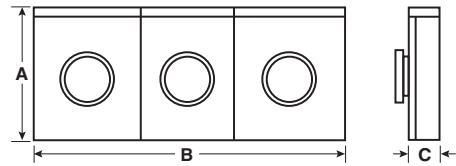

Fig. F

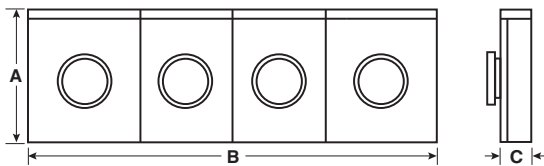

Fig. G

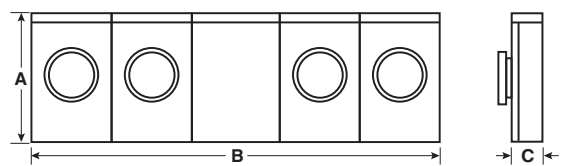

Fig. H

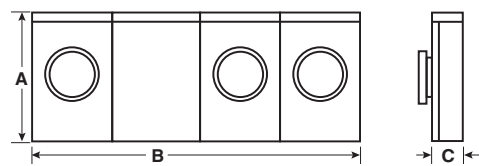

Fig. I

Horizontal Mtr Socket

Knockout Configurations

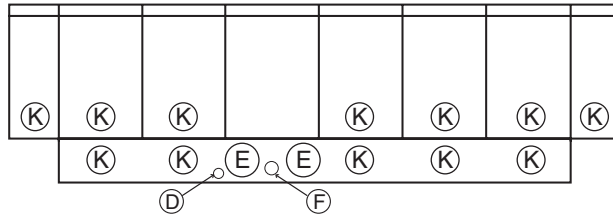

Fig. 1

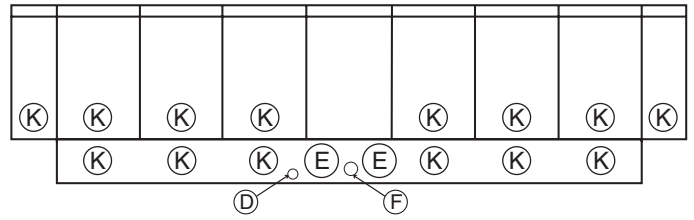

Fig. 2

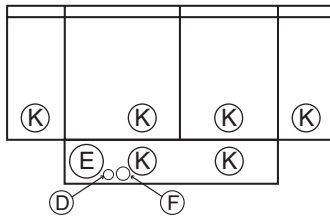

Fig. 3

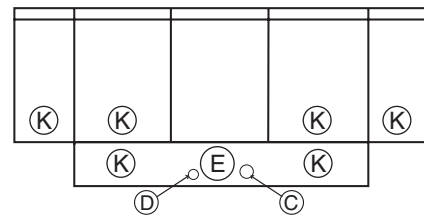

Fig. 4

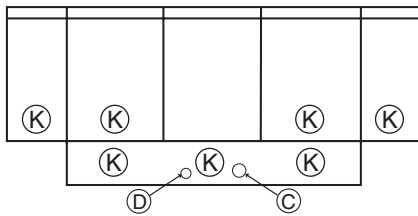

Fig. 5

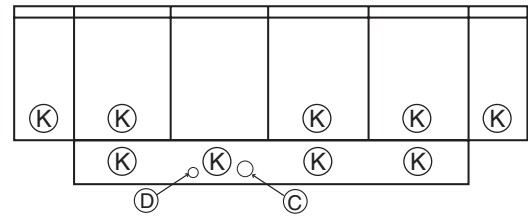

Fig. 6

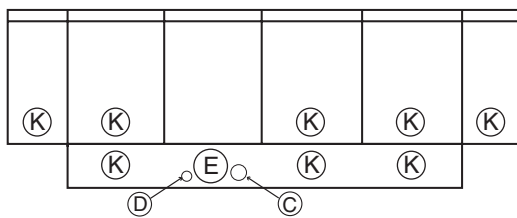

Fig. 7

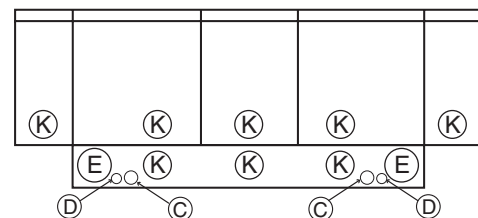

Fig. 8

Knockout Key

- C = 1/2"
- D = 5/16"
- E = 2", 2-1/2", 3"
- F = 1/2", 3/4"
- I = 1-1/4", 1-1/2", 2"
- J = 1/2", 3/4", 1", 1-1/4"
- K = 1", 1-1/4", 1-1/2", 2", 2-1/2"
- L = 2", 2-1/2", 3", 3-1/2"

* Knockouts shown for size not for exact positions.

Data subject to change without notice.

Knockout Configurations

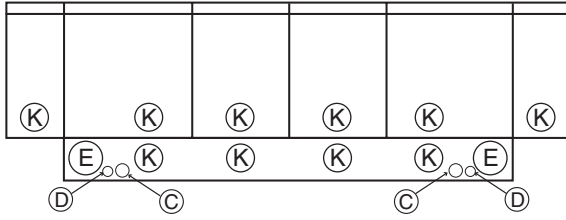

Fig. 9

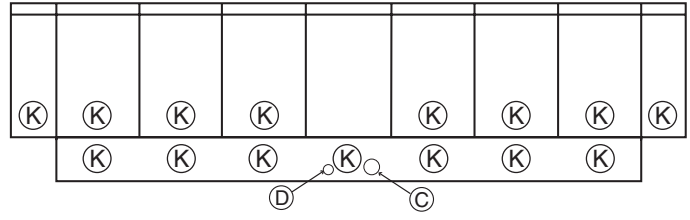

Fig. 10

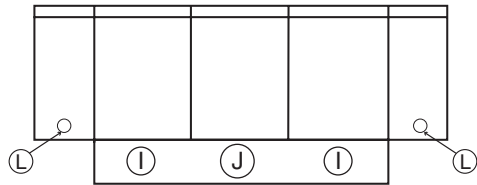

Fig. 11

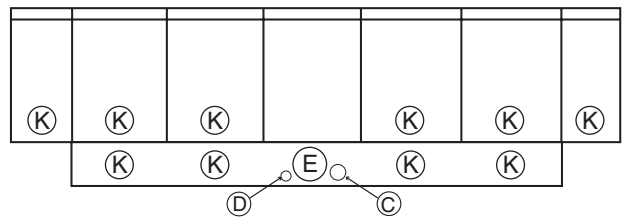

Fig. 12

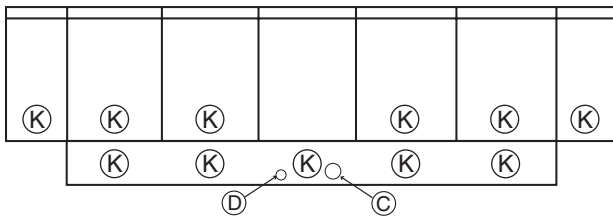

Fig. 13

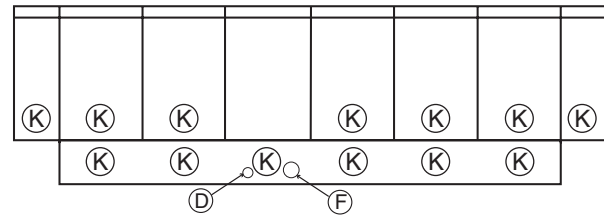

Fig. 14

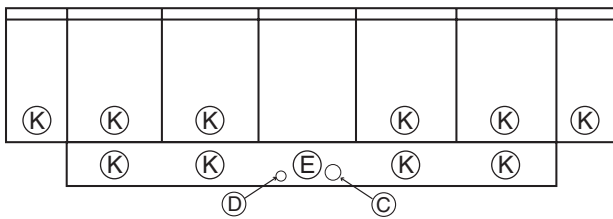

Fig. 15

Knockout Key

- C = 1/2"
- D = 5/16"
- E = 2", 2-1/2", 3"
- F = 1/2", 3/4"
- I = 1-1/4", 1-1/2", 2"
- J = 1/2", 3/4", 1", 1-1/4"
- K = 1", 1-1/4", 1-1/2", 2", 2-1/2"
- L = 2", 2-1/2", 3", 3-1/2"

Notes

Section 4

Load Centers / Circuit Breakers



Application Information

Midwest load centers lower your costs by making installation faster and easier, increasing application flexibility and reducing inventory requirements. At the same time, they deliver obvious and significant advances in design, function and quality.

Main lug load centers offer an economical solution for subpanels and similar applications. All main lug units 125A and above convert easily to main breaker units.



MLM4020CCU

Features and Benefits

Specifications

- UL Listed Panelboards No. 67
 - Service barriers included for factory installed main circuit breaker
- Suitable for use as service entrance equipment when installed in accordance with National Electrical Code
- 60°C/75°C Conductor Rating
- Single phase, 40-225A, 2-42 circuits
- Main breaker 22kAIC factory installed – standard
- Main lugs – factory installed
- All neutral holes rated for 14-4 wire
- Indoor and outdoor rated enclosures
- 100% rated split neutral on each side*

Flexibility – Most Model Numbers

- Main lug models field convertible to main breaker
- All load centers top or bottom feed
- Indoor fronts combination surface/flush
- Tie bar may be removed to split neutral/ground

Rugged Durability

- Sturdy copper bus
- Front packed in inner carton for added protection
- Copper bus with tin-plating standard
- Galvanized box

Installation Ease

- One-piece interior removes and reinstalls easily
- Split neutrals extend the full length of the interior for ease of wiring*
- Convertible models convert easily to main breaker
- Combination surface/flush front with spring-reinforced pan
- Combination slotted/Robertson square-drive screws on neutral,* ground, front and breaker lugs
- Field installable feed-through lugs up to 200A
- Straight-through main wiring
- Main breaker is clearly marked and circuit numbers are stamped on front
- Isolated ground bar is available
- Compact box maintains optimum wire-bending space



* 16 circuits and above.

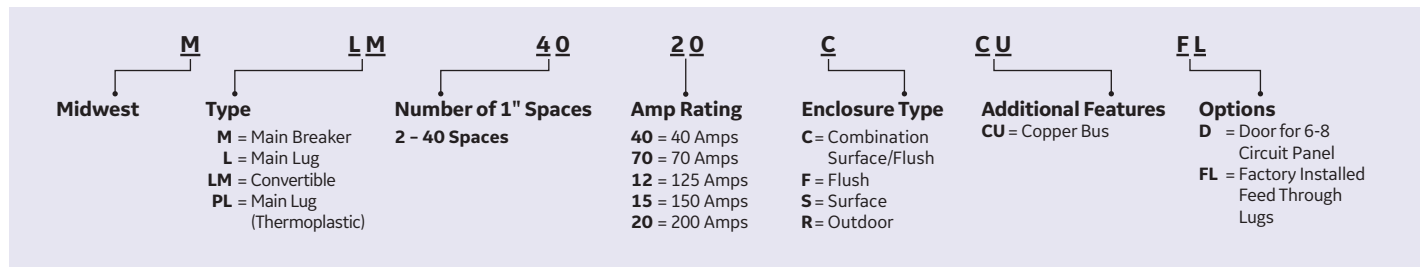

Data subject to change without notice.

Main Lugs

1-Phase, 40 – 125 Amps, 120/240VAC

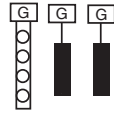

Fig. A
ML240SCU, RCU
ML270SCU, RCU

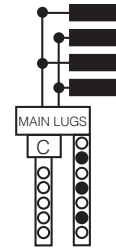

Fig. B
ML412C, MPL412R,
ML412R1

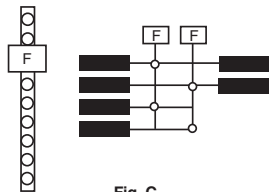

Fig. C
MLM612FCU, SCU, RCU

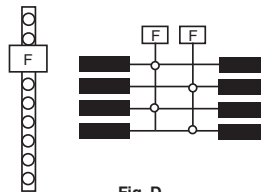

Fig. D
MLM812FCU, SCUD, RCU

Terminal Symbol	Wire Range (AWG/kcmil)	
	CU	AL
○	14-8	12-8
●	14-4	12-4
C	6-2/0	
F	6-1	
G	6-3	

Breaker Symbol	Breaker Fill	
	1" THQL	1/2" THQP
○	1	—
■	1	2

2/4/6/8 Circuits

Fig.	Model Number	Amps	1" Spaces		1/2" Spaces		Total 1 Pole Spaces	Main Wire Size (AWG/kcmil) Cu/Al	Equipment Ground Kit (order separately)	Enclosure Type	Material Type	Mounting Style	Feed	UL
			1 Pole	2 Pole	1 Pole	2 Pole								
A	ML240RCU ¹	40	2	1	4	1	4	14-4	MGK4	N3R	Metallic	—	Top	Y
A	ML240SCU ^{5,7}	40	2	1	4	1	4	14-4	MGK4	N1	Metallic	Surface	Top/Bottom	
A	ML270RCU ¹	70	2	1	4	1	4	6-3	MGK4	N3R	Metallic	—	Top	
A	ML270SCU ^{5,7}	70	2	1	4	1	4	6-3	MGK4	N1	Metallic	Surface	Top/Bottom	
B	ML412C ^{2,5,7}	125	4	2	8	3	8	1-2/0	MGL1	N1	Metallic	Combination Surface/Flush	Top/Bottom	
B	ML412R1 ^{1,2}	125	4	2	8	3	8	1-2/0	MGL1	N3R	Metallic	—	Top	
C	MLM612RCU ^{1,4}	125	4	3	12	4	12	6-1	MGK12	N3R	Metallic	—	Top	
B	MPL412R ^{1,2,3}	125	4	2	8	3	8	1-2/0	MGL1	N3R	Thermoplastic	—	Top	
C	MLM612FCU ^{4,5}	125	6	3	12	4	12	6-1	MGL2	N1	Metallic	Flush	Top/Bottom	
C	MLM612SCU ^{4,5}	125	6	3	12	4	12	6-1	MGL2	N1	Metallic	Surface	Top/Bottom	
D	MLM812FCUD ^{4,5}	125	8	4	16	8	16	6-1	MGL2	N1	Metallic	Flush	Top/Bottom	
D	MLM812RCU ^{1,4}	125	8	4	16	8	16	6-1	MGK12	N3R	Metallic	—	Top	
D	MLM812SCUD ^{4,5}	125	8	4	16	8	16	6-1	MGL2	N1	Metallic	Surface	Top/Bottom	

¹ 40-225 amp 1-Phase devices have removable closing caps. Larger ampere devices require field-cut openings. Order hubs separately.

² 10 kAIC.

³ 125 amp maximum branch capacity.

⁴ For main breaker, order MHQLRK2 retainer kit plus 2-pole circuit breaker. 100 amp maximum due to wire bending requirements.

⁵ Main and branch breakers are limited to 70 amps.

⁶ Load center includes a factory installed ground bar and add-a-lug. A separate MGL2 can be added in the unlikely event that another ground bar is required.

⁷ No door.

Main Lugs

1-Phase, 125 – 150 Amps, 120/240VAC

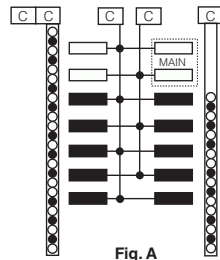

Fig. A
MLM1212CCU

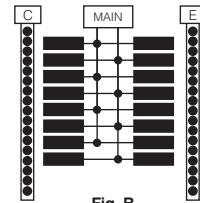

Fig. B
MLM1212RCU, MLM1612CCU

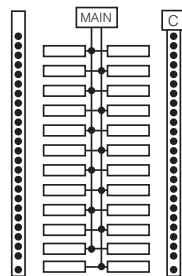

Fig. C
MLM2412CCU, MLM2412RCU

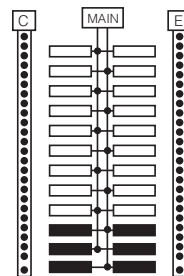

Fig. D
MLM2415RCU

Terminal Symbol	Wire Range (AWG/kcmil)	
	CU	AL
●	14-4	12-4
C	6-2/0	
E	1-300	

Breaker Symbol	Breaker Fill	
	1" THQL	1/2" THQP
□	1	—
■	1	2

14/16/24 Circuits

Fig.	Model Number	Amps	1" Spaces		1/2" Spaces		Total 1 Pole Spaces	Main Wire Size (AWG/kcmil) Cu/Al	Equipment Ground Kit	Enclosure Type	Material Type	Mounting Style	Feed	UL
			1 Pole	2 Pole	1 Pole	2 Pole								
A	MLM1212CCU ^{4,5}	125	14	6	20	8	24	6-2/0	Included	N1	Metallic	Combination Surface/Flush	Top/Bottom	Y
B	MLM1212RCU ^{1,4,6}	125	14	6	20	8	24	6-2/0	Included	N3R	Metallic	—	Top	
B	MLM1612CCU ²	125	16	8	16	6	24	6-2/0	MGK12, MGK24 ⁷	N1	Metallic	Combination Surface/Flush	Top/Bottom	
C	MLM2412CCU ²	125	24	12	—	—	24	6-2/0	MGK24, MGK32 ⁷	N1	Metallic	Combination Surface/Flush	Top/Bottom	
C	MLM2412RCU ^{1,2}	125	24	12	—	—	24	6-2/0	MGK24, MGK32 ⁷	N3R	Metallic	—	Top/Bottom	
D	MLM2415RCU ^{1,3}	150	24	12	12	4	30	1-3/0 (Cu), 2/0-3/0 (Al)	MGK24, MGK32 ⁷	N3R	Metallic	—	Top/Bottom	

¹ 40-225 amp 1-Phase devices have removable closing caps. Larger ampere devices require field-cut openings. Order hubs separately.

² For main breaker, order MQMH000 plus 2-pole THQL or THHQL circuit breakers.

³ For main breaker, order THQMVXXXD circuit breaker. See page 4-12.

⁴ For main breaker applications, use reverse feed THQL or THHQL circuit breakers plus MHQLRK3 breaker retainer kit.

⁵ Main and branch breakers are limited to 70 amps.

⁶ Load center includes a factory installed ground bar and add-a-lug. A separate MGL2 can be added in the unlikely event that another ground bar is required.

⁷ Order separately.

Main Lugs

1-Phase, 200 Amps, 120/240VAC

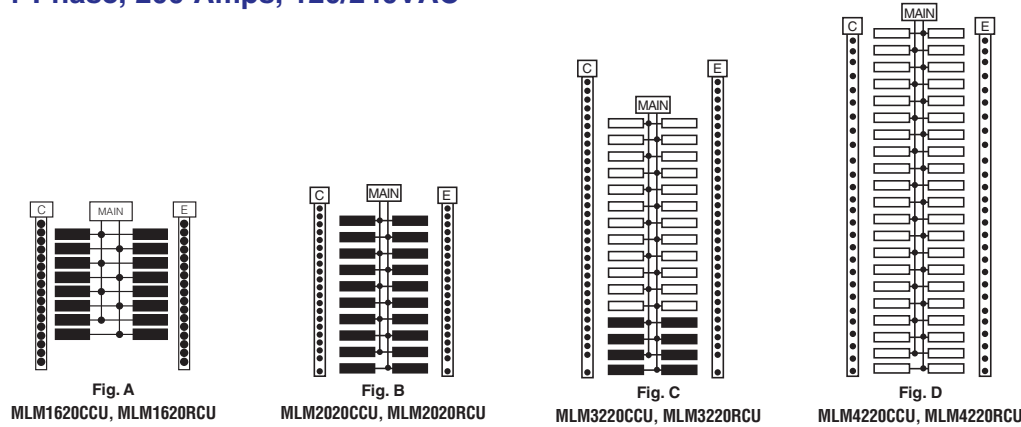

Terminal Symbol	Wire Range (AWG/kcmil)	
	CU	AL
●	14-4	12-4
C	6-2/0	
E	1-300	

Breaker Symbol	Breaker Fill	
	1" THQL	1/2" THQP
□	1	—
■	1	2

16/20/32/40 Circuits

Fig.	Model Number	Amps	1" Spaces		1/2" Spaces		Total 1 Pole Spaces	Main Wire Size (AWG/kcmil) Cu/Al	Equipment Ground Kit (order separately)	Enclosure Type	Material Type	Mounting Style	Feed	UL
			1 Pole	2 Pole	1 Pole	2 Pole								
A	MLM1620CCU ²	200	16	8	32	14	32	6-250	MGK32	N1	Metallic	Combination Surface/Flush	Top/Bottom	Y
A	MLM1620RCU ^{1,2}	200	16	8	32	14	32	6-250	MGK32	N3R	Metallic	—	Top	
B	MLM2020CCU ²	200	20	10	40	18	40	6-250	MGK32	N1	Metallic	Combination Surface/Flush	Top/Bottom	
B	MLM2020RCU ^{1,3}	200	20	10	40	18	40	6-250	MGK24, MGK42	N3R	Metallic	—	Top	
C	MLM3220CCU ²	200	32	16	16	6	40	6-250	MGK32	N1	Metallic	Combination Surface/Flush	Top/Bottom	
C	MLM3220RCU ^{1,2}	200	32	16	16	6	40	1-250 (Cu), 2/0-250 (Al)	MGK32	N3R	Metallic	—	Top/Bottom	
D	MLM4020CCU ²	200	40	20	—	—	40	6-250	MGK42	N1	Metallic	Surface/Flush	Top/Bottom	
D	MLM4020RCU ^{1,2}	200	40	20	—	—	40	6-250	MGK42	N3R	Metallic	—	Top/Bottom	

¹ 40-225 amp 1-Phase devices have removable closing caps. Larger ampere devices require field-cut openings. Order hubs separately.
² For main breaker, order THQMXXXX circuit breaker. See page 4-12.

Main Breaker

1-Phase, 200 Amps, 120/240VAC

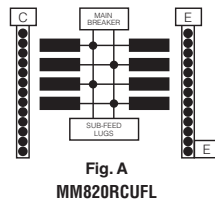

Terminal Symbol	Wire Range (AWG/kcmil)	
	CU	AL
●	14-4	12-4
C	6-2/0	
E	1-300	

Breaker Symbol	Breaker Fill	
	1" THQL	1/2" THQP
□	1	—
■	1	2

2/4/6/8 Circuits

Fig.	Model Number	Amps	1" Spaces		1/2" Spaces		Total 1 Pole Spaces	Main Wire Size (AWG/kcmil) Cu/Al	Equipment Ground Kit (order separately)	Enclosure Type	Material Type	Mounting Style	Feed	UL
			1 Pole	2 Pole	1 Pole	2 Pole								
A	MM820RCUFL ¹	200	8	4	16	6	16	1-250 (Cu), 2/0-250 (Al)	MGK32	N3R	Metallic	—	Top	Y

¹ 40-225 amp 1-Phase devices have removable closing caps. Larger ampere devices require field-cut openings. Order hubs separately.

Technical Data

Model Number	Weight (lbs.)	Dimensions (inches)			Knockout Figure ¹
		Height	Width	Depth	
ML240RCU	6-4/5	10	7-1/4	3-3/4	6
ML240SCU	4-3/10	10-1/4	5-11/16	3-3/8	1
ML270RCU	6-3/4	10	7-1/4	3-3/4	6
ML270SCU	4-1/2	10-1/4	5-11/16	3-3/8	1
ML412C	5-2/5	9	7-1/4	3	2
ML412R1	7-1/10	10	7-1/4	3-3/4	6
MLM1212CCU	14-9/10	16	14	3-3/8	8
MLM1212RCU	20-1/2	21-1/2	13	5	10
MLM1612CCU	19-1/2	19	14	3-3/4	9
MLM1620CCU	25-1/10	24-11/16	14	3-3/4	9
MLM1620RCU	27-3/5	29	13	5	10
MLM2020CCU	27	26-7/16	14	3-3/4	9
MLM2020RCU	29-1/2	33	13	5	10
MLM2412CCU	24-1/2	24-11/16	14	3-3/4	9
MLM2412RCU	22	30-3/16	14-11/16	5-1/4	10
MLM2415RCU	26	33	13	5	10
MLM3220CCU	33-1/2	33-3/16	14	3-3/4	9
MLM3220RCU	33-1/2	34-3/16	14-11/16	5-1/4	11
MLM4020CCU	37	39-3/16	14	3-3/4	9
MLM4020RCU	60	43-1/4	14-21/32	6-13/32	12
MLM612FCU	8-1/2	11-3/8	11-9/16	3-3/8	3
MLM612RCU	10	11-1/8	11-1/4	3-1/4	7
MLM612SCU	9-1/4	11-3/8	11-9/16	3-3/8	3
MLM812FCUD	9	11-3/8	11-9/16	3-3/8	3
MLM812RCU	10	11-1/8	11-1/4	3-1/4	7
MLM812SCUD	9	11-3/8	11-9/16	3-3/8	3
MM820RCUFL	28	28-11/16	12-1/2	4-5/8	5
MPL412R	2-1/2	9-7/32	7-1/2	3-5/16	4

¹ Knockout Figures on page 4-7.

Knockout Configurations

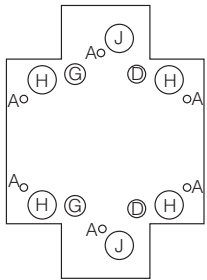

Fig. 1

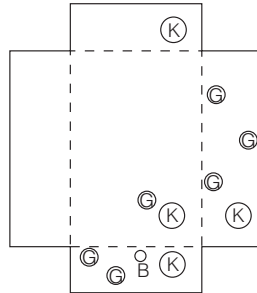

Fig. 2

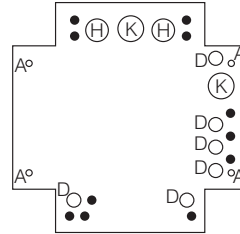

Fig. 3

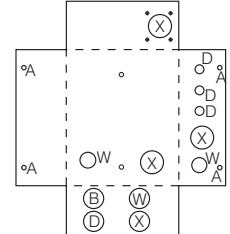

Fig. 4

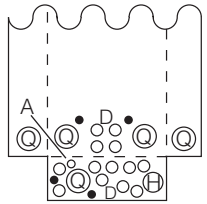

Fig. 5

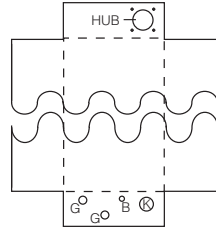

Fig. 6

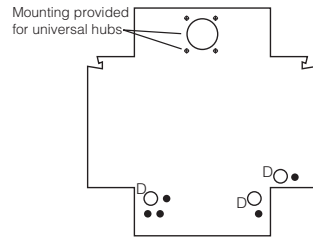

Fig. 7

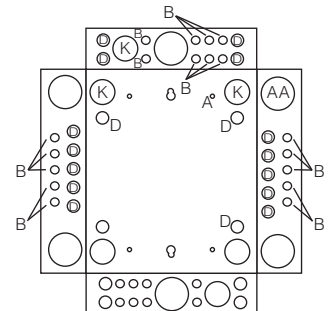

Fig. 8

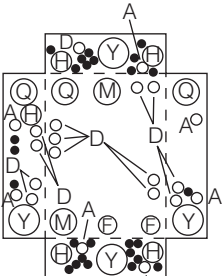

Fig. 9

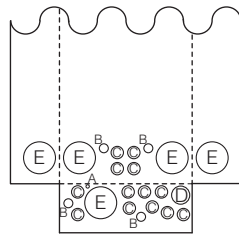

Fig. 10

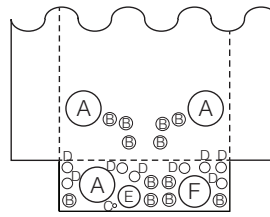

Fig. 11

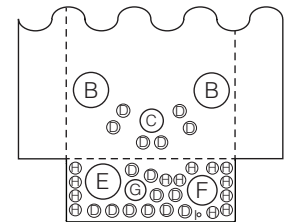

Fig. 12

Knockout Key

- A = 5/16
- = 3/8, 1/2
- B = 1/2
- C = 3/8, 1/2, 3/4
- D = 1/2, 3/4
- E = 3/4
- F = 1/2, 3/4, 1, 1-1/4, 1-1/2
- G = 1/2, 3/4, 1
- H = 1/2, 3/4, 1, 1-1/4

- I = 9/32
- J = 3/4, 1, 1-1/4
- K = 3/4, 1, 1-1/4, 1-1/2
- M = 1, 1-1/4, 1-1/2, 2
- Q = 1, 1-1/2, 2, 2-1/2
- W = 3/4, 1
- X = 1-1/4, 1-1/2
- Y = 1, 1-1/4, 1-1/2, 2, 2-1/2
- AA = 2-1/2, 3, 3-1/2, 4

* Knockouts shown for size not for exact positions.

Data subject to change without notice.

Accessories

Equipment Ground Kits

Model Number	Wire Range (AWG/kcmil)
MGL1	(4) 14-8Cu/12-8AL (3) 14-4CU/6-4Al
MGL2 ¹	(8) 14-8Cu/12-8AL (6) 14-4CU/6-4Al
MGL8 ¹	(7) 14-8Cu/12-8AL, (3) 14-4Cu/6-4AL, (2) 14-4CU/12-4Al, (1) 14-2Cu/Al
MGL20 ²	(1) 6-2/0Cu/Al Number of Terminals, Equipment Ground Kits
MNG3	(3) 10-1/0Cu/Al Number of Terminals for 400 and 600 Amp
MNG6	(6) 10-1/0Cu/Al Number of Terminals for 400 and 600 Amp

¹ MGL2 and MGL8 mount interchangeably.

² Add-on Equipment Ground Lug (for use on any MGL Kit).



MGL2



MGL20 Combined with MGL1

Equipment Ground and Isolated Ground Kits¹

Model Number	Description
MGK4	4-hole Ground
MGK12	12-hole Ground
MGK24	24-hole Ground
MGK32	32-hole Ground
MGK42	42-hole Ground

¹ Add TGK8 for isolated ground and mount to ground kit.



MGK12

Neutral Kits

Model Number	Wire Range	Description
MNLK20	6-2/0	Mounted on top of neutral only
MNLK250		



MNLK20

Neutral/Ground Kits

Mounted on any neutral or ground position by removing the termination screw

Model Number	Wire Range	Description
MLK20	6-2/0	Neutral/Ground Lug Kit
MLK250	6-250	
MLK300	6-300	



MLK20



MLK250

Isolated Ground Bar Equipment Ground Kits

Model Number	Description
MGKIS	Isolated Ground Bar Kit (order with MGK Equipment Ground Kits)
MGKIS2	Isolated Ground Bar Feet (order with TGK8)



MGK12 with MGKIS

Subfeed Lug Kits

Model Number	Description
MHLK2125	125A 2 Pole Plug-in
MHLK2150	150A 2 Pole Plug-in
MHLK2200	200A 2 Pole Plug-in



MHLK2125

Accessories

Raintight (Bolt-on) Hubs

Threaded

Hub Opening (inches)	Midwest Hub Number	Universal Hub Number	Std. Pkg.
3/4	B07	—	10
1	B10	—	
1-1/4	B12	—	
1-1/2	B15	—	
2	B20	U27	
2-1/2	B25	U28	
3	—	U30	1
3-1/2	—	U35	
4	—	U40	
Closure Plate ¹	B01	U04	10

¹ Closure Plate is standard with most Midwest products.



Service Barrier Kits

Model Number	Description
M2100SB	THQL21100 Service Barrier
M2200LSB	BJ2200/BJ22150 Lug Service Barrier Kit – one barrier included for each pole
M2201SB	TQD22200 Service Barrier
M2201SBP	TQD22200 Service Barrier Plug
M2201SBR	TQD22200 Service Barrier 100-125A Reducer
MBSB	MSLC Bus Service Barrier
MHQLRK	MB Retainer and Service Barrier Kit
MHQLRK1	MB Retainer and Service Barrier Kit
MHQLRK2	MB Retainer and Service Barrier Kit
MHQLRK3	MB Retainer and Service Barrier Kit
MHQLRK4	MB Retainer and Service Barrier Kit
MHQMVSBF	Service Barrier Flapper
MLSB	MSLC Lug Service Barrier
MLSB2P	MSLC Service Barrier 2P Module
MLSBF	MSLC Service Barrier Lug Bus Filler
MLSBR	MSLC Lug Service Barrier Reverse Feed
MLSBS	MSLC Lug Service Barrier Shutter
MSB	2/4 Sockets Service Barrier



M2200LSB



MHQMVSBF



MBSB



MLSB



MHQLRK



MLSB2P



MHQLRK1



MLSBF



MHQLRK2



MLSBR



MHQLRK3



MLSBS



MHQLRK4

Application Information

We offer a full line of GE circuit interrupters which includes Dual Function (DFCI), Ground Fault (GFI), Combination Arc Fault (AFCI), 1" and 1/2" breaker to meet all of your electrical installation needs.

The Dual Function (DFCI), Ground Fault (GFI) and Combination Arc Fault (AFCI) Circuit Interrupter features cutting edge technology and offers ground fault and arc fault circuit interruption in one unit. It meets the recent NEC requirements for use on kitchen and laundry room circuits. The Combination Arc Fault (AFCI) circuit interrupters allow sharing of neutrals that help to eliminate the need to run a second neutral cable. The Ground Fault with Self-Test (GFT) includes functionality required by UL which automatically runs diagnostic testing on a periodic basis.



THQL2140



THQL1120AF2



THQL1115DF



THQL2120GFT

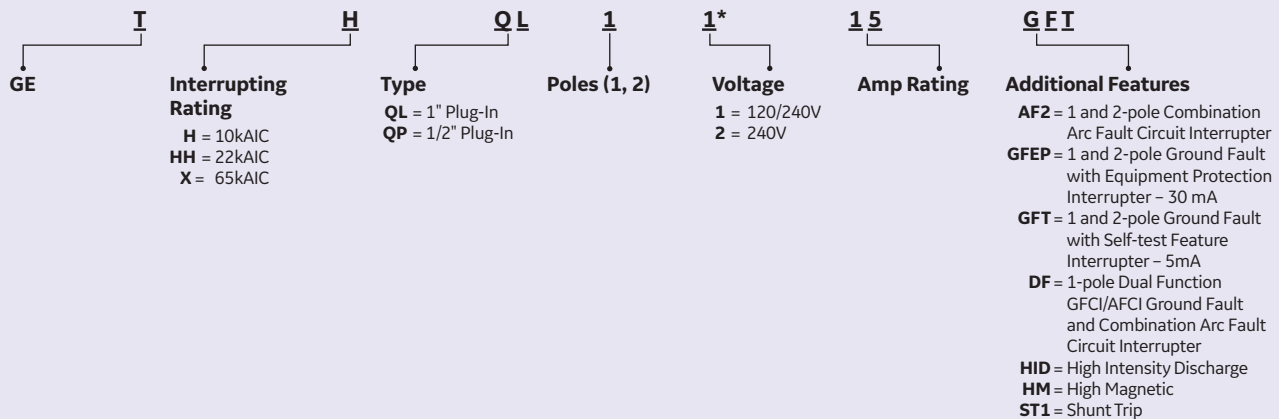

* Omit character for THQP breakers, which are all 120/240V.

Q-Line Plug-in

- UL Listed Molded Case Circuit Breakers No. 489
- Federal Government Specification Qualified WC-375B
- 60°C/75°C Conductor Rating
- Quick make, quick break
- Box type terminals



THQP130



THQP230



THQL1120



THQL2140

One Pole / Two Pole, 15 – 125 Amps, 120/240VAC

Amps	10,000 AIC		22,000 AIC	65,000 AIC	UL
	Model Number		Model Number	Model Number	
	1/2" Module	1" Module	1" Module	1" Module	
One Pole¹					
15 ²	THQP115	THQL1115	THHQL1115	TXQL1115	Y
20 ²	THQP120	THQL1120	THHQL1120	TXQL1120	
25	THQP125	THQL1125	THHQL1125	TXQL1125	
30	THQP130	THQL1130	THHQL1130	TXQL1130	
35	THQP135	THQL1135	THHQL1135	—	
40	THQP140	THQL1140	THHQL1140	—	
45	THQP145	THQL1145	THHQL1145	—	
50	THQP150	THQL1150	THHQL1150	—	
Two Pole³ (Incorporates Internal Common Trip Bar)					
15	THQP215	THQL2115	THHQL2115	TXQL2115	Y
20	THQP220	THQL2120	THHQL2120	TXQL2120	
25	THQP225	THQL2125	THHQL2125	TXQL2125	
30	THQP230	THQL2130	THHQL2130	TXQL2130	
35	THQP235	THQL2135	THHQL2135	—	
40	THQP240	THQL2140	THHQL2140	—	
45	THQP245	THQL2145	THHQL2145	—	
50	THQP250	THQL2150	THHQL2150	—	
60	—	THQL2160	THHQL2160	—	
70	—	THQL2170	THHQL2170	—	
80	—	THQL2180	THHQL2180	—	
90	—	THQL2190	THHQL2190	—	
100	—	THQL21100	THHQL21100	—	
110	—	THQL21110	THHQL21110	—	
125	—	THQL21125	THHQL21125	—	

Circuit Interrupters Wire Size

Breaker Type	Amps	Wire Range (AWG/kcmil ¹)	
		Copper	Aluminum
THQP	15-25	14-8	14-8
	30-50	8-4	8-4
THQL, THHQL, TXQL	15-30	14-8	14-8
	35-60	8-3	8-3
	70-100	6-1/0	6-1/0
	110-125	2-2/0	2-2/0

¹ Solid or stranded for 14-10 AWG.

¹ UL Listed as HACR (heating, air conditioning and refrigeration).

² UL Listed as SWD (switching duty). Suitable for 120V AC fluorescent lighting loads

³ 15 - 100 amp, UL Listed as HACR (heating, air conditioning and refrigeration).

Data subject to change without notice.

Main Breaker Kits

For Use with 125 Amp Load Centers

Amps	Model Number	Lug Wire Size (AWG/kcmil) Cu/Al	UL
—	MQMH000 ¹	—	Y

¹ Order breaker separately. See Main Breaker table below.



100 – 225 Amps

Amps	Model Number ²	Lug Wire Size (AWG/kcmil) Cu/Al	UL
100	THQMV100D	1-300 (Cu), 2/0-300 (Al)	Y
125	THQMV125D		
150	THQMV150D		
175	THQMV175D		
200	THQMV200D		
225	THQMV225D		

² Includes a breaker and mounting base.



Main Breakers

Two Pole^{1,2}, 15 – 125 Amps, 120/240VAC

Amps	10,000 AIC	22,000 AIC	UL
	Model Number	Model Number	
	1" Module	1" Module	
15	THQL2115	THHQL2115	Y
20	THQL2120	THHQL2120	
25	THQL2125	THHQL2125	
30	THQL2130	THHQL2130	
35	THQL2135	THHQL2135	
40	THQL2140	THHQL2140	
45	THQL2145	THHQL2145	
50	THQL2150	THHQL2150	
60	THQL2160	THHQL2160	
70	THQL2170	THHQL2170	
80	THQL2180	THHQL2180	
90	THQL2190	THHQL2190	
100	THQL21100	THHQL21100	
110	THQL21110	THHQL21110	
125	THQL21125	THHQL21125	

¹ 15 - 100 amp, UL Listed as HACR (heating, air conditioning and refrigeration).

² Incorporates internal common trip bar.



Arc Fault

- UL Listed Molded Case Circuit Breakers No. 489
- UL Listed Arc Fault Circuit Interrupters No. 1699

One Pole^{1,2}, 10 – 20 Amps, 120/240VAC

Amps	10,000 AIC		UL
	Model Number		
10	THQL1115AF2	THHQL1115AF2	Y
20	THQL1120AF2	THHQL1120AF2	



THQL1120AF2

¹ Combination AFCI compliant with 2008 NEC and later requirements.
² For two pole shared neutral applications, use (2) one pole circuit breakers with a handle tie.

Dual Function GFCI/AFCI Ground Fault and Combination Arc Fault Circuit Breaker

- UL Listed Molded Case Circuit Breakers No. 489
- UL Listed Arc Fault Circuit Interrupters No. 1699
- UL Listed Ground Fault Circuit Interrupters No. 943 ed5 (5 milliamperes)

One Pole, 15 – 20 Amps, 120VAC

Amps	10,000 AIC		UL
	Model Number		
15	THQL1115DF	THHQL1115DF	Y
20	THQL1120DF	THHQL1120DF	



THQL1115DF

Ground Fault with Self-Test Feature

- UL Listed Ground Fault Circuit Interrupters No. 943 ed5 (5 milliamperes)

One Pole / Two Pole¹, 15 – 50 Amps, 120VAC or 120/240VAC

Amps	10,000 AIC		22,000 AIC	UL
	Model Number			
	One Pole – 120VAC	Two Pole – 120/240VAC	One Pole – 120VAC	
15	THQL1115GFT	THQL2115GFT	THHQL1115GFT	cUL ^{us}
20	THQL1120GFT	THQL2120GFT	THHQL1120GFT	
25	THQL1125GFT	THQL2125GFT	THHQL1125GFT	
30	THQL1130GFT	THQL2130GFT	THHQL1130GFT	
40	—	THQL2140GFT ¹	—	
50	—	THQL2150GFT ¹	—	



THQL2120GFT

¹ UL and CSA.

Ground Fault with Equipment Protection

- UL Listed Ground Fault Circuit Interrupters No. 943 (30 milliamperes ground fault trip level)

One Pole / Two Pole¹, 15 – 30 Amps, 120VAC or 120/240VAC

Amps	10,000 AIC		UL
	Model Number		
	One Pole – 120VAC	Two Pole – 120/240VAC	
15	THQL1115GFEP	THQL2115GFEP	cUL ^{us}
20	THQL1120GFEP	THQL2120GFEP	
30	THQL1130GFEP	THQL2130GFEP	



THQL2115GFEP

HID Lighting

- UL Listed as HID
- HID breakers are designed to handle the current and voltage spikes that result when gaseous discharge lamps, including fluorescent and HID, are switched on and off

One Pole / Two Pole, 15 – 30 Amps, 120VAC or 120/240VAC

Amps	10,000 AIC		22,000 AIC		UL
	Model Number		Model Number		
	One Pole – 120VAC	Two Pole – 120/240VAC	One Pole – 120VAC	Two Pole – 120/240VAC	
15	THQL1115HID	THQL2115HID	THHQL1115HID ¹	THHQL2115HID	Y
20	THQL1120HID	THQL2120HID	THHQL1120HID ¹	THHQL2120HID	
30	THQL1130HID	THQL2130HID	THHQL1130HID	THHQL2130HID	



THQL2120HID

¹ UL Listed as SWD (switching duty). Suitable for 120 volts ac fluorescent lighting loads.

High Magnetic

- UL Listed Molded Case Circuit Breakers No. 489
- High short circuit rating suitable for circuits with inherent high in-rush load currents

One Pole, 15 – 50 Amps, 120VAC

Amps	10,000 AIC	UL
	Model Number	
15	THQL1115HM	Y
20	THQL1120HM	
25	THQL1125HM	
30	THQL1130HM	
40	THQL1140HM	
50	THQL1150HM	



THQL1140HM

THQL with Factory Installed Shunt

- UL Listed Molded Case Circuit Breakers No. 489
- Shunt trip requires one additional pole of space

One Pole / Two Pole, 15 – 100 Amps, 120/240VAC or 240VAC

Amps	10,000 AIC		UL
	Model Number ¹		
	One Pole – 120/240VAC	Two Pole ² – 240VAC	
15	THQL1115ST1	THQL2115ST1	Y
20	THQL1120ST1	THQL2120ST1	
30	THQL1130ST1	THQL2130ST1	
35	THQL1135ST1	THQL2135ST1	
40	THQL1140ST1	THQL2140ST1	
45	THQL1145ST1	THQL2145ST1	
50	THQL1150ST1	THQL2150ST1	
60	—	THQL2160ST1	
70	—	THQL2170ST1	
80	—	THQL2180ST1	
90	—	THQL2190ST1	
100	—	THQL21100ST1	



THQL2150ST1

¹ Solid or stranded for 14-10 AWG.

² Internal common trip.

Data subject to change without notice.

Section 5

Spa Panels



Application Information

GFI disconnects provide a convenient, low-cost means, to satisfy National Electric Code requirements for a GFI disconnect for spas, hot tubs, water heaters and swimming pools. The NEMA 3R design insures a safe, weather-tight installation. All units come fully assembled and factory wired. Midwest is your best choice for quality outdoor disconnects.

Features and Benefits

- Extra circuit breaker spaces allow for future expansion
- Fully assembled unit saves costly installation time
- NEMA 3R weatherproof enclosures
- G90 galvanized steel construction for superior corrosion protection
- Durable polyester powder coat finish resists chipping and fading
- 125A rating
- All terminals accept copper or aluminum wire for installation flexibility
- Includes both overcurrent and ground fault protection
- Overhead hub opening
- Padlock provision to prevent unauthorized access

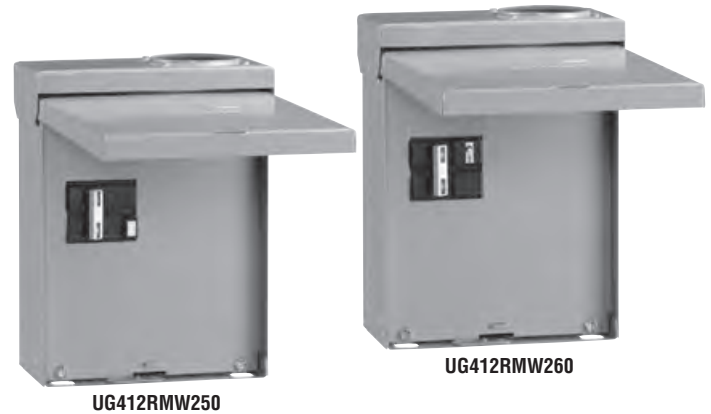

GFI Disconnect

125 Amps, 120/240V

Fig.	Model Number ¹	Extra Breaker Spaces	GFI Protection (Amps)	Amps	Hub Opening	Lug Wire Size Cu/Al	UL
A	UG412RMW250	2 or 4	50	125	Y	6-2/0	Y
B	UG412RMW260		60				

¹ Unit includes appropriate GFI Breaker.

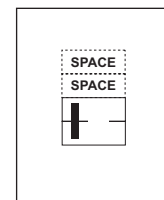

Fig. A
UG412RMW250

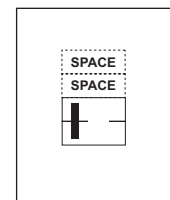
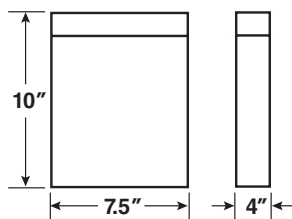
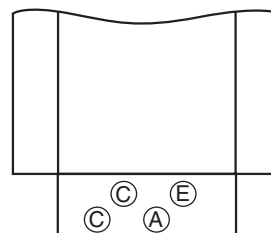

Fig. B
UG412RMW260

Cabinet Dimensions



Knockout Configurations



Knockout Key

- A = 1/2"
- C = 1/2", 3/4", 1"
- E = 3/4", 1-1/4", 1-1/2"

* Knockouts shown for size not for exact positions.

Section 6

Safety Switches



Application Information

General Duty

General Duty (Type MG) switches are designed for residential and light commercial applications where duty is not severe. The maximum voltage is 240 Vac / 250 Vdc. All General Duty safety switches are UL and CUL listed (UL98 Enclosed Switches) and meet NEMA Enclosed Safety Switch Standard KS1-2013, meet Federal Specification WS-865C and are also Seismic Certified.

Heavy Duty

Heavy Duty (Type MH) switches are designed for commercial and industrial applications where safety and superior reliability are essential. The maximum voltage is 600 Vac / 250 Vdc. Our Heavy Duty switches provide superior endurance performance, and when used with Class R or J fuses, 30-200A switches have a UL listed short-circuit rating of 200kAIC. They are UL listed as service equipment when installed in accordance with the National Electric Code. All Heavy Duty safety switches are UL and cUL listed (UL98 Enclosed Switches) and meet NEMA Enclosed Safety Switch Standard KS1-2013, meet Federal Specification WS-865C and are also Seismic Certified.

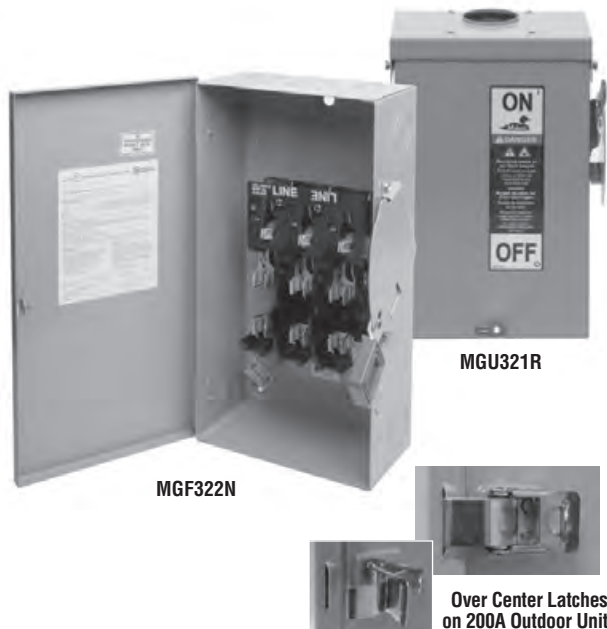

Features and Benefits

Flexibility

- 30-200 Amps
- NEMA Type 1 or NEMA Type 3R enclosures
- Fusible or Non-fusible
- 240 Vac / 250 Vdc or 600 Vac / 250 Vdc
- 2 pole or 3 pole
- Horsepower rated

User Safety

- Highly visible ON-OFF label
- Our General Duty switch features a highly visible, easy to grip red handle that accepts one padlock in the OFF position.
- The Heavy Duty switch features an upgraded “donut” handle ideal for hook stick operation and accepts three padlocks in the OFF position
- Direct-drive, quick-make, quick-break mechanism “snaps” the contacts open and closed, providing positive ON-OFF indication
- Our General Duty switch has an integral cover interlock
- The Heavy Duty switch has coin-proof, defeatable interlock
- Visible confirmation of plated blade contact positions
- Spring reinforced fuse clips assure reliable contact for cool operation
- Suitable for Class H, K, J or R fuses, where applicable

Installation Ease

- Wide, unobstructed gutter
- Self-leveling three-point mounting pattern

Rugged Durability

- NEMA Type 1 enclosures – powder coat painted steel
- NEMA Type 3R enclosures – powder coat painted galvanized steel

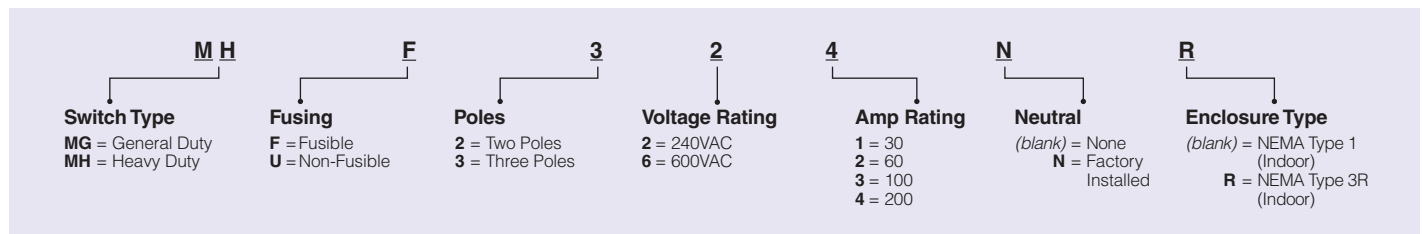

Data subject to change without notice.

General Duty

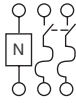

Fig. A
MGF221N, MGF222N, MGF223N,
MGF224N, MGF221NR, MGF222NR,
MGF223NR, MGF224NR
2 pole, 3 wire

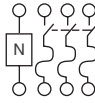

Fig. B
MGF321N, MGF322N, MGF323N,
MGF324N, MGF321NR, MGF322NR,
MGF323NR, MGF324NR
3 pole, 4 wire

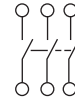

Fig. C
MGU321, MGU322, MGU323,
MGU324, MGU321R, MGU322R,
MGU323R, MGU324R
3 pole, 3 wire

Fusible, Two Pole / Three Pole, 30 – 200 Amps, 240V

Fig.	Model Number		Amps	Horsepower Rating					Unit Wt.	Std Pkg.	UL
	NEMA Type 1 Indoor	NEMA Type 3 Outdoor ¹		Single Phase, 240 Vac		Three Phase, 240 Vac		DC (Vdc)			
				Standard Fuse	Time Delay Fuse	Standard Fuse	Time Delay Fuse	250			
Two pole, 50/60 Hz											
A	MGF221N	MGF221NR	30	1-1/2	3	—	—	5	6	1	cULus
	MGF222N	MGF222NR	60	3	10	—	—	10	11		
	MGF223N	MGF223NR	100	7-1/2	15	—	—	20	17		
	MGF224N	MGF224NR	200	15	15	—	—	—	32		
Three pole, 50/60 Hz											
B	MGF321N	MGF321NR	30	1-1/2	3	3	7-1/2	5	6	1	cULus
	MGF322N	MGF322NR	60	3	10	7-1/2	15	10	11		
	MGF323N	MGF323NR	100	7-1/2	15	15	30	20	17		
	MGF324N	MGF324NR	200	15	15	25	50	—	32		

Non-Fusible, Three Pole, 30 – 200 Amps, 240V

Fig.	Model Number		Amps	Horsepower Rating			Unit Wt.	Std Pkg.	UL	
	NEMA Type 1 Indoor	NEMA Type 3 Outdoor ¹		Single Phase, 240 Vac	Three Phase, 240 Vac					DC (Vdc)
				Standard Fuse	Standard Fuse					250
Three pole, 50/60 Hz										
C	MGU321	MGU321R	30	3	7-1/2		5	6	1	cULus
	MGU322 ²	MGU322R ²	60	10	15		10	10		
	MGU323 ²	MGU323R ²	100	15	30		20	13		
	MGU324	MGU324R	200	15	50		—	30		

General Duty safety switches are not suitable for use as service equipment in Canada.

¹ 30, 60 and 100A General Duty outdoor switches feature a flip-top door style. 200A General Duty outdoor switches feature a side swing door style.

² Not suitable for use as service equipment. Solid neutral not available.

Short Circuit Ratings

Fusible / Non-Fusible, 30 – 200 Amps

Maximum System Voltage	Amps	Safety Switch Type	UL Listed Fusing		Enclosure Type
			Class	Withstand Rating (rms Sym Amps)	
240 Vac 250 Vdc	30-200	Fusible	K	10,000	N1 N3R
			H	10,000	
			R	100,000	
240 Vac 250 Vdc	30-200	Non-fusible ³	No Upstream Protection	10,000	N1 N3R
			K Upstream	10,000	
			H Upstream	10,000	
			R Upstream	100,000	

³ Non-fusible switch withstand ratings apply when protected by corresponding listed fuse type.

Lug Wire Sizes

Line and Load Terminals

Amps	Wire Range (AWG/kcmil)	
	Copper	Aluminum
30A (250V)	14-8	12-8
30A (600V)	12-2	12-2
60A (600V)	12-2	12-2
100A (600V)	10-1/0	10-1/0
200A (600V)	2-250	2-250

Heavy Duty

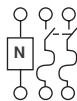

Fig. A
MHF221N, MHF222N, MHF223N,
MHF224N, MHF221NR, MHF222NR,
MHF223NR, MHF224NR
2 pole, 3 wire

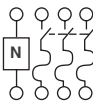

Fig. B
MHF321N, MHF322N, MHF323N,
MHF324N, MHF321NR, MHF322NR,
MHF323NR, MHF324NR
3 pole, 4 wire



Fig. C
MHF361, MHF362, MHF363,
MHF364, MHF361R, MHF362R,
MHF363R, MHF364R
3 pole, 3 wire



Fig. D
MHU361, MHU362, MHU363,
MHU364, MHU361R, MHU362R,
MHU363R, MHU364R
3 pole, 3 wire

Fusible, Two Pole / Three Pole, 30 – 200 Amps, 240V

Fig.	Model Number		Amps	Horsepower Rating					Unit Wt.	Std Pkg.	UL
	NEMA Type 1 Indoor	NEMA Type 3 Outdoor ¹		Single Phase, 240 Vac		Three Phase, 240 Vac		DC (Vdc)			
				Standard Fuse	Time Delay Fuse	Standard Fuse	Time Delay Fuse	250			
Two pole, 50/60 Hz											
A	MHF221N	MHF221NR	30	1-1/2	3	—	—	5	7	1	cULus
	MHF222N	MHF222NR	60	3	10	—	—	10	16		
	MHF223N	MHF223NR	100	7-1/2	15	—	—	20	18		
	MHF224N	MHF224NR	200	15	—	—	—	40	34		
Three pole, 50/60 Hz											
B	MHF321N	MHF321NR	30	1-1/2	3	3	7-1/2	5	7	1	cULus
	MHF322N	MHF322NR	60	3	10	7-1/2	15	10	16		
	MHF323N	MHF323NR	100	7-1/2	15	15	30	20	18		
	MHF324N	MHF324NR	200	15	—	25	60	40	34		

Fusible, Three Pole, 30 – 200 Amps, 600V

Fig.	Model Number		Amps	Horsepower Rating								Unit Wt.	Std Pkg.	UL		
	NEMA Type 1 Indoor	NEMA Type 3 Outdoor ¹		Single Phase, 480 Vac		Single Phase, 600 Vac		Three Phase, 480 Vac		Three Phase, 600 Vac					DC (Vdc)	DC (Vdc)
				Standard Fuse	Time Delay Fuse	Standard Fuse	Time Delay Fuse	Standard Fuse	Time Delay Fuse	Standard Fuse	Time Delay Fuse				125	250
Three pole, 50/60 Hz																
C	MHF361	MHF361R	30	3	7-1/2	3	10	5	15	7-1/2	20	—	5	11	1	cULus
	MHF362	MHF362R	60	5	20	10	25	15	30	15	50	5	10	18		
	MHF363	MHF363R	100	10	30	15	40	25	60	30	75	—	20	19		
	MHF364	MHF364R	200	25	50	30	50	50	125	60	150	—	40	33		

Non-Fusible, Three Pole, 30 – 200 Amps, 600V

Fig.	Model Number		Amps	Horsepower Rating				Unit Wt.	Std Pkg.	UL	
	NEMA Type 1 Indoor	NEMA Type 3R Outdoor ¹		Single Phase, Vac		Three Phase, Vac					DC (Vdc)
				Standard Fuse		Standard Fuse					
Three pole, 50/60 Hz											
D	MHU361 ²	MHU361R	30	7-1/2	10	20	30	5	11	1	cULus
	MHU362	MHU362R	60	20	25	50	60	10	18		
	MHU363	MHU363R	100	30	40	75	100	20	19		
	MHU364	MHU364R	200	50	50	125	150	40	33		

¹ 30, 60 and 100A Heavy Duty outdoor switches feature a flip-top door style. 200A Heavy Duty outdoor switches feature a side swing door style.

² Available in 240V, compact enclosure – order MHU321.

Short Circuit Ratings

Fusible / Non-Fusible, 30 – 200 Amps

Maximum System Voltage	Amps	Safety Switch Type	UL Listed Fusing		Enclosure Type
			Class	Withstand Rating (rms Sym Amps)	
600 Vac 600 Vdc	30-200	Fusible	H	10,000	N1 N3R
			R	200,000 ⁴	
			J	200,000 ⁴	
600 Vac 600 Vdc	30-200	Non-fusible ³	No Upstream Protection	10,000	N1 N3R
			H Upstream	10,000	
			R Upstream	200,000 ⁴	

³ Non-fusible switch withstand ratings apply when protected by corresponding listed fuse type.

⁴ Unless otherwise noted on the enclosure.

Safety Switch Accessories

Equipment Ground Kits

Model Number	Amps	Wire Range (AWG/kcmil)		Std Pkg.
		Copper	Aluminum	
MGL2	30	(4) 14-8, (3) 14-4	(4) 12-8, (3) 6-4	20
	60			
MGL4	100	(3) 10-1/0	(3) 10-1/0	1
	200			



Neutral Kit Insulated, Groundable and Bondable

Model Number	Amps	System Volts (Vac)	Fusible / Non-fusible	Wire Range (AWG/kcmil)		Std Pkg.
				Copper	Aluminum	
MNK1	30	600	Either	14-8	12-8	1
MNK2 ¹	30		Either	12-2	12-2	
	60		Non-fusible	12-2	12-2	
MNK2A	60		Fusible	12-2	12-2	
MNK3	100		Non-fusible	10-1/0	10-1/0	
MNK3A ¹	100		Fusible	10-1/0	10-1/0	
MNK4A	200		Either	2-250	2-250	



¹ Not suitable for type MG switches.
 Switching Neutral: order standard switch of required number of poles and use dummy fuse in neutral pole.

Auxiliary Contact Kits

Model Number	Switch Prefix	Amps	System Voltage	Contacts	Contact Ratings	Std Pkg.
MAUX61S	MH	30	240	1NO/1NC	15A, 600 Vac 0.50A, 125 Vac 0.25A, 250 Vac	1
MAUX21D			240	2NO/2NC	10A, 125/250 Vac 0.30A, 125 Vac 0.15A, 250 Vac	
MAUX64D			600	2NO/2NC	15A, 600 Vac 0.50A, 125 Vac 0.25A, 250 Vac	
		60-200	240-600			



Designed to open before switch blades. UL listed for field installation.

Class R Fuse Kits

Switch Prefix	Amps	Volts	Model Number
MG	30	240	MGR12
	60		MGR22
	100/200		MGR42
MH	30	240	MHR12
	30	600	MHR16
	60	240	MHR22
	60	600	MHR26
	100/200	600	MHR46



Raintight (Bolt-on) Hub

See page 14-3.



Accessory Selection Tables

General Duty Safety Switches

Model Number		Neutral Kit Accessory/ Replacement Part	Ground Lug Kit	Class R Fuse Kit
NEMA Type 1	NEMA Type 3R			
MGF221N	MGF221NR	Factory Installed Replacement = MNK1	MGL2	MGR12
MGF222N	MGF222NR	Factory Installed Replacement = MNK2A	MGL2	MGR22
MGF223N	MGF223NR	Factory Installed	MGL4	MGR42
MGF224N	MGF224NR	Factory Installed Replacement = MNK4A	MGL4	MGR42
MGF321N	MGF321NR	Factory Installed Replacement = MNK1	MGL2	MGR12
MGF322N	MGF322NR	Factory Installed	MGL2	MGR22
MGF323N	MGF323NR	Factory Installed	MGL4	MGR42
MGF324N	MGF324NR	Factory Installed Replacement = MNK4A	MGL4	MGR42
MGU321	MGU321R	—	MGL2	—
MGU322	MGU322R	—	MGL2	—
MGU323	MGU323R	MNK3	MGL4	—
MGU324	MGU324R	—	MGL4	—

Heavy Duty Safety Switches

Model Number		Neutral Kit Accessory/ Replacement Part	Ground Lug Kit	Class R Fuse Kit	Auxiliary Contact Kits	
NEMA Type 1	NEMA Type 3R				(1NO / 1NC)	(2NO / 2NC)
MHF221N	MHF221NR	Factory Installed Replacement = MNK1	MGL2	MHR12	MAUX61S	MAUX21D
MHF222N	MHF222NR	Factory Installed	MGL2	MHR22	—	MAUX64D
MHF223N	MHF223NR	Factory Installed	MGL4	MHR46	—	MAUX64D
MHF224N	MHF224NR	Factory Installed Replacement = MNK4A	MGL4	MHR46	—	MAUX64D
MHF361	MHF361R	MNK2 or MNK3	MGL2	MHR16	MAUX61S	MAUX21D
MHF362	MHF362R	MNK2A or MNK3A	MGL2	MHR26	—	MAUX64D
MHF363	MHF363R	MNK3A	MGL4	MHR46	—	MAUX64D
MHF364	MHF364R	MNK4A	MGL4	MHR46	—	MAUX64D
MHF321N	MHF321NR	Factory Installed Replacement = MNK1	MGL2	MHR12	MAUX61S	MAUX21D
MHF322N	MHF322NR	Factory Installed	MGL2	MHR22	—	MAUX64D
MHF323N	MHF323NR	Factory Installed	MGL4	MHR46	—	MAUX64D
MHF324N	MHF324NR	Factory Installed Replacement = MNK4A	MGL4	MHR46	—	MAUX64D
MHU361	MHU361R	MNK2 or MNK3	MGL2	—	MAUX61S	MAUX21D
MHU362	MHU362R	MNK2 or MNK3	MGL2	—	—	MAUX64D
MHU363	MHU363R	MNK3	MGL4	—	—	MAUX64D
MHU364	MHU364R	MNK4A	MGL4	—	—	MAUX64D

Data subject to change without notice.

Technical Data

General Duty Safety Switches

Model Number	Enclosure Style ¹	Cabinet Dimensions (inches)					Knockout Figure ²
		Height (A)	Width (B)	Width (C)	Depth (D)	Depth (E)	
MGF221N	A	10-3/10	6-9/10	6-2/5	6-3/10	3-3/10	1
MGF221NR	B	9-4/5	6-4/5	6-2/5	6-3/10	3-3/10	4
MGF222N	A	13-4/5	8-9/10	8-2/5	7-9/10	4	7
MGF222NR	B	13-7/10	8-4/5	8-2/5	7-9/10	3-9/10	8
MGF223N	A	21-3/10	10-3/5	9-2/5	9-9/10	4-9/10	2
MGF223NR	B	21-1/10	10-3/10	9-3/10	9-1/10	5	5
MGF224N	A	29-1/10	14-3/5	13-2/5	9-3/10	5-1/5	3
MGF224NR	C	28-4/5	14-3/10	13-2/5	8-9/10	5-3/10	9
MGF321N	A	10-3/10	6-9/10	6-2/5	6-3/10	3-3/10	1
MGF321NR	B	9-4/5	6-4/5	6-2/5	6-3/10	3-3/10	4
MGF322N	A	13-4/5	8-9/10	8-2/5	7-9/10	4	7
MGF322NR	B	13-7/10	8-4/5	8-2/5	7-9/10	3-9/10	8
MGF323N	A	21-3/10	10-3/5	9-2/5	9-9/10	4-9/10	2
MGF323NR	B	21-1/10	10-3/10	9-3/10	9-1/10	5	5
MGF324N	A	29-1/10	14-3/5	13-2/5	9-3/10	5-1/5	3
MGF324NR	C	28-4/5	14-3/10	13-2/5	8-9/10	5-3/10	9
MGU321	A	10-3/10	6-9/10	6-2/5	6-3/10	3-3/10	1
MGU321R	B	9-4/5	6-4/5	6-2/5	6-3/10	3-3/10	4
MGU322	A	13-4/5	8-9/10	8-2/5	7-9/10	4	7
MGU322R	B	13-7/10	8-4/5	8-2/5	7-9/10	3-9/10	8
MGU323	A	21-3/10	10-3/5	9-2/5	9-9/10	4-9/10	2
MGU323R	B	15-3/4	10-3/10	9-3/10	9-1/10	5	5
MGU324	A	29-1/10	14-3/5	13-2/5	9-3/10	5-1/5	3
MGU324R	C	28-4/5	14-3/10	13-2/5	8-9/10	5-3/10	9

¹ Enclosure Styles shown below.

² Knockout Figures on page 6-9.

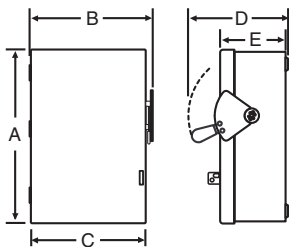

Fig. A
General Duty - NEMA Type 1

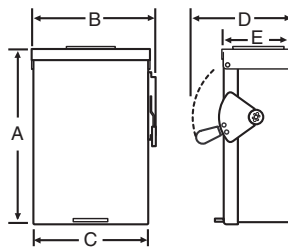

Fig. B
General Duty - NEMA Type 3R, 30 through 100A

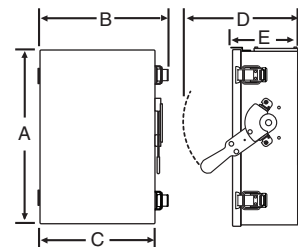

Fig. C
General Duty - NEMA Type 3R Side Swing, 200A

Technical Data

Heavy Duty Safety Switches

Model Number	Enclosure Style ¹	Cabinet Dimensions (inches)					Knockout Figure ²
		Height (A)	Width (B)	Width (C)	Depth (D)	Depth (E)	
MHF221N	A	10-3/10	7-1/10	6-3/10	6-1/10	3-3/10	1
MHF221NR	B	10-1/2	6-3/5	6-1/5	7-7/10	3-1/10	4
MHF222N	A	17-3/5	10-1/10	9-2/5	9	5	2
MHF222NR	B	17-1/5	9-7/10	9-1/5	7-9/10	4-4/5	5
MHF223N	A	21-3/10	10-1/10	9-3/10	9-4/5	4-4/5	2
MHF223NR	B	22-1/10	10-1/5	9-3/10	9-4/5	4-9/10	5
MHF224N	A	31-1/2	14-1/10	13-3/10	10-1/2	5-1/10	3
MHF224NR	C	31-3/10	14-1/5	13-2/5	9-1/2	5-1/10	9
MHF321N	A	10-3/10	7-1/10	6-3/10	6-1/10	3-3/10	1
MHF321NR	B	10-1/2	6-3/5	6-1/5	7-7/10	3-1/10	4
MHF322N	A	17-3/5	10-1/10	9-2/5	9	5	2
MHF322NR	B	17-1/5	9-7/10	9-1/5	7-9/10	4-4/5	5
MHF323N	A	21-3/10	10-1/10	9-3/10	9-4/5	4-4/5	2
MHF323NR	B	22-1/10	10-1/5	9-3/10	9-4/5	4-9/10	5
MHF324N	A	31-1/2	14-1/10	13-3/10	10-1/2	5-1/10	3
MHF324NR	C	31-3/10	14-1/5	13-2/5	9-1/2	5-1/10	9
MHF361	A	12-3/5	9-1/2	8-3/10	7-3/5	4	7
MHF361R	B	13-1/10	8-9/10	8-1/5	7-9/10	4	8
MHF362	A	21-3/10	9-2/5	9-1/10	8-3/5	5	2
MHF362R	B	22	9-7/10	9-1/5	7-9/10	4-4/5	5
MHF363	A	22-3/10	10-1/10	9-3/10	9-4/5	4-4/5	6
MHF363R	B	22-1/10	10-1/5	9-3/10	9-4/5	4-9/10	5
MHF364	A	31-1/2	14-1/10	13-3/10	10-1/2	5-1/10	3
MHF364R	C	31-3/10	14-1/5	13-2/5	9-1/2	5-1/10	9
MHU361	A	10-3/10	9-3/10	8-3/10	7-7/10	4	7
MHU361R	B	13-1/10	8-9/10	8-1/5	7-9/10	4	8
MHU362	A	17-3/5	10-1/10	9-2/5	9	5	2
MHU362R	B	17-1/5	9-7/10	9-1/5	7-9/10	4-4/5	5
MHU363	A	17-3/5	10-1/10	9-3/10	9-4/5	4-4/5	2
MHU363R	B	17-3/10	10-1/5	9-3/10	9-4/5	4-9/10	5
MHU364	A	31-1/2	14-1/10	13-3/10	10-1/2	5-1/10	3
MHU364R	C	31-3/10	14-1/5	13-2/5	9-1/2	5-1/10	9

¹ Enclosure Styles shown below.

² Knockout Figures on page 6-9.

Enclosure Styles / Cabinet Dimensions

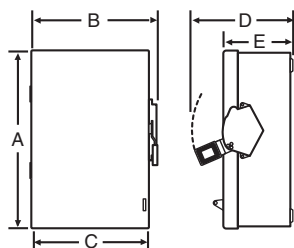

Fig. A
 Heavy Duty - NEMA Type 1

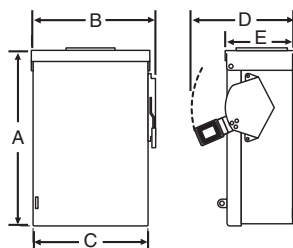

Fig. B
 Heavy Duty - NEMA Type 3R, 30 through 100A

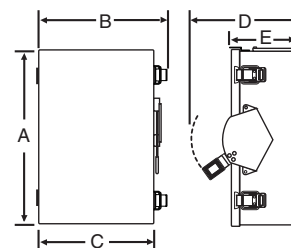

Fig. C
 Heavy Duty - NEMA Type 3R Side Swing, 200A

Data subject to change without notice.

Knockout Configurations

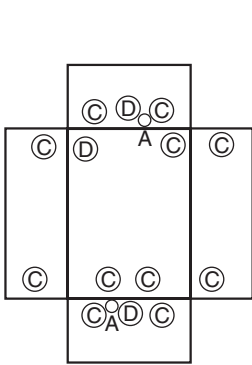

Fig. 1

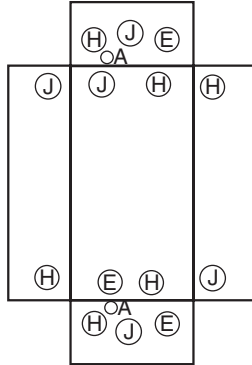

Fig. 2

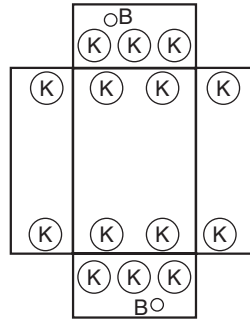

Fig. 3

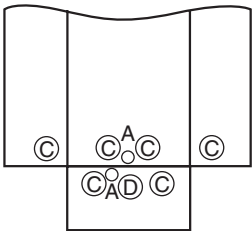

Fig. 4

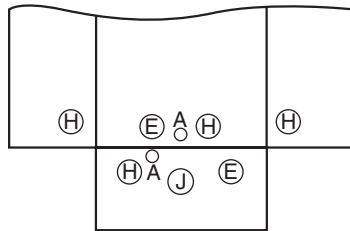

Fig. 5

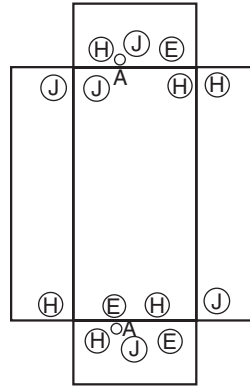

Fig. 6

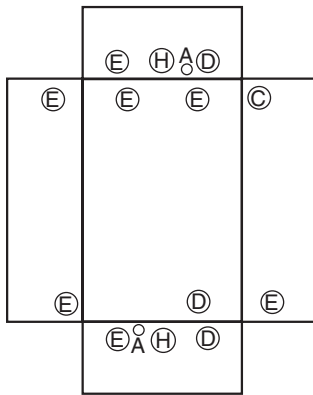

Fig. 7

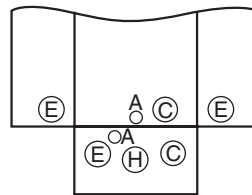

Fig. 8

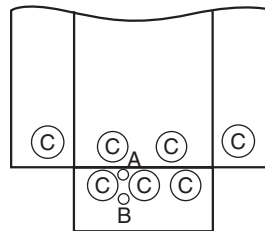

Fig. 9

Knockout Key

- A = 9/32"
- B = 1/2"
- C = 1/2", 3/4"
- D = 1/2", 3/4", 1"
- E = 1/2", 3/4", 1", 1-1/4"
- H = 3/4", 1", 1-1/4", 1-1/2"
- J = 1", 1-1/4", 1-1/2", 2"
- K = 1", 1-1/2", 2", 2-1/2"
- M = 2", 2-1/2", 3", 3-1/2"
- N = 2-1/2", 3"

* Knockouts shown for size not for exact positions.

Outline Drawings

General Duty Safety Switches

Type	Amps	Outline Drawing No.
Indoor	30-60	10103093SH4
	100-200	10103093SH8
Outdoor	30-60	10103093SH3
	100	10103093SH7
	200	10103093SH10

Outline drawings can be found at www.midwestelectric.com

Heavy Duty Safety Switches

Type	Amps	Outline Drawing No.
Indoor	30-60	10103093SH2
	100-200	10103093SH5
Outdoor	30-60	10103093SH1
	100	10103093SH6
	200	10103093SH9

Outline drawings can be found at www.midwestelectric.com

Midwest Electric Products

Section 7

AC Disconnects



Application Information

Article 440 of the National Electrical Code applies to electric motor-driven air conditioning and refrigerating equipment, and to the branch circuits and controllers for such equipment. It provides for the special considerations necessary for circuits supplying hermetic refrigerant motor-compressors and for any air conditioning and/or refrigerating equipment that is supplied from an individual branch circuit.

The National Electric Code Requirements

Disconnecting means shall be located within sight from and readily accessible from the air-conditioning or refrigerating equipment. The disconnecting means shall be permitted to be installed on or within the air-conditioning or refrigerating equipment. The disconnecting means shall not be located on panels that are designed to allow access to the air-conditioning or refrigeration equipment or to obscure the equipment nameplates.

Additionally, the National Electric Code states that listed or labeled equipment shall be used or installed in accordance with any instructions included in the listing or labeling.

Thus, when an equipment's label or instruction specifies circuit breaker protection, Article 110.3(b) can be met with a branch circuit breaker in the load center while article 440.14 can most economically be met using a disconnect without overcurrent protection. When an equipment's label or instructions specifies fuse protection, Article 110.3(b) mandates that fuse(s) must be present in the branch circuit. Since most load centers are of the circuit breaker variety, fuses must be installed elsewhere in the branch circuit. The most economical installation involves combining the fuse protection and disconnecting functions into a single device to be installed per Article 440.14. See illustration.

Air Conditioner Disconnect Selection Guide

Existing Branch Circuit Protection	Sight Disconnect Selection
Fusible ¹	Non-Fusible or Fusible
Circuit Breaker	Fusible
HACR ²	Non-Fusible or Fusible

¹ See Air Conditioner nameplate for correct selection.

² HACR = Heating, air conditioning, refrigeration type circuit breaker.

Features and Benefits

Flexibility

- 30-100 Amps
- 240 volts AC
- 1-phase or 3-phase fusible or non-fusible
- Horsepower rated
- 10kAIC
- Available with GFCI receptacle

Rugged Durability

- NEMA 3R weatherproof enclosure
- Noryl[®] thermoplastic enclosure is corrosion resistant and extremely durable, giving long maintenance free service
- Metallic models are made of G90 galvanized steel for superior corrosion protection and have a durable polyester powder coat finish which resists chipping and fading

User Safety

- Padlock provision on door helps prevent unauthorized access

Installation Ease

- Three-piece construction that opens up mounting and wiring areas
- Terminals approved for 60°C and 75°C wire, accepts solid 14-8 copper, 12-8 aluminum or stranded 14-3 copper, 12-3 aluminum
- Numerous knockouts reduce installation time
- Straight-in, straight-out wiring saves time and money

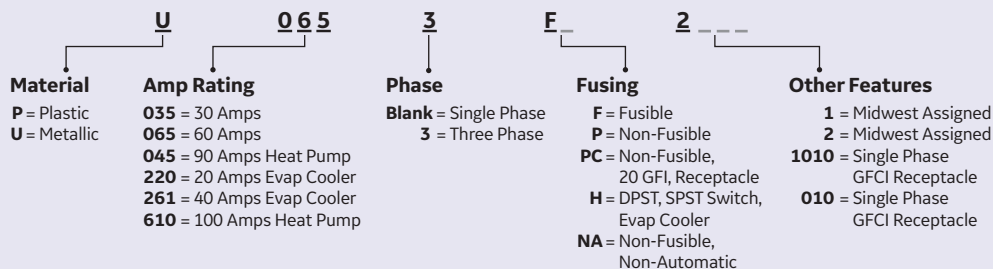
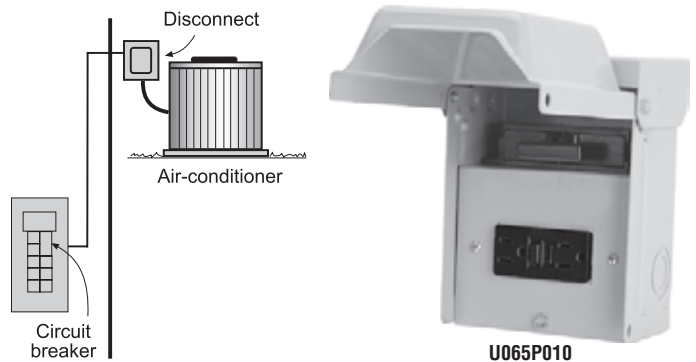

Data subject to change without notice.

Non-Metallic

Fusible / Non-Fusible, 30 – 60 Amps, 120/240V

Fusible disconnects are available in 30 and 60 Amp models. Pullers are removable or reinstallable in the OFF position for user safety during equipment maintenance. The P065F UL listing includes the ability to field replace the 60 Amp puller with a 30 Amp puller (FR352) for installation flexibility. Listed for use as service entrance.

Non-fusible disconnect pullers are removable or reinstallable in the OFF position for user safety during equipment maintenance.

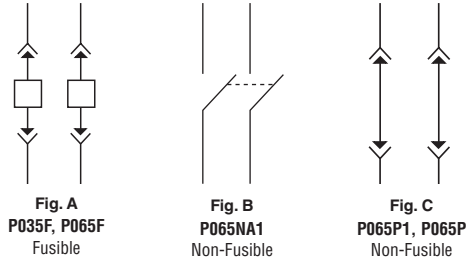

Fig.	Model Number		Amps	Horsepower Rating	Wire Range*	Cabinet Size	Unit Wt.	Std Pkg.	UL
	Fusible	Non-Fusible							
A	P035F	—	30	3	D	6 x 8	2	6	cULus
A	P065F	—	60	10		6 x 8			
B	—	P065NA1	60	10		5 x 7			
C	—	P065P1	60	10		5 x 7			
C	—	P065P	60	10		6 x 8			

* Wire Range Table on page 7-7. See Technical Data on page 7-6 for available replacement parts.

Metallic

1-Phase / 3-Phase, Fusible / Non-Fusible, 30 – 60 Amps, 120/240V or 240V

Fusible disconnects are available in 30 and 60 Amp models. Pullers are removable or reinstallable in the OFF position for user safety during equipment maintenance. Listed for use as service entrance.

Non-fusible disconnect pullers are removable or reinstallable in the OFF position for user safety during equipment maintenance.

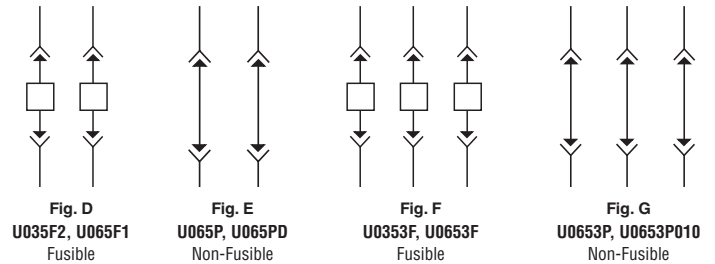

Fig.	Model Number		Amps	Horsepower Rating	Wire Range*	Cabinet Size	Unit Wt.	Std Pkg.	UL
	Fusible	Non-Fusible							
Phase 1 – 120/240V									
D	U035F2	—	30	3	D	5 x 7	2.5	6	cULus
D	U065F1	—	60	10		5 x 9	3.5		
E	—	U065P	60	10		5 x 7	3		
E	—	U065PD	60	10		7 x 10	7	1	
Phase 3 – 240V									
E	U0353F	—	30	3-7.5	D	6 x 14	8.5	4	cULus
F	U0653F	—	60	7.5-15					
G	—	U0653P	60	7.5-15					
G	—	U0653P010	60	7.5-15					

* Wire Range Table on page 7-7. See Technical Data on page 7-6 for available replacement parts.

Key

□ = Accepts Class H fuses (fuses not included)

Data subject to change without notice.

Non-Automatic

1-Phase, 60 Amps, 120/240V

Model Number	Phase	Amps	Horsepower Rating	Wire Range*	Cabinet Size	Unit Wt.	Std Pkg.	UL
U065NA1	1	60	10	D	5 x 7	2.5	6	
U065NA2	1	60	10	D	7 x 10	6.5	6	

* Wire Range Table on page 7-7.

Heat Pump

Fusible, 90 – 100 Amps, 120/240V

Multiple disconnect devices are offered for heat pump applications that require individual disconnects for the heating and cooling cycles. All pullers are removable or reinstallable in the OFF position for user safety during equipment maintenance. Their UL listing includes the ability to field replace the 60 Amp puller in the left fuse block with a 30 Amp puller (FR352) for installation flexibility but prohibits the interchangeability of pullers between fuse blocks to insure the proper fuse/puller combination is always reinstalled into the proper fuse block.

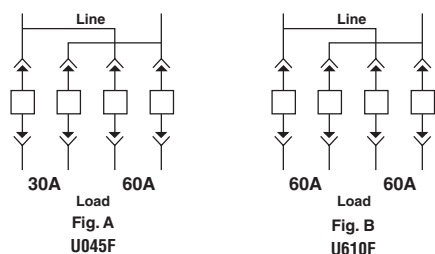

Fig.	Model Number	Amps	Horsepower Rating	Neutral Bar	Wire Range*	Cabinet Size	Unit Wt.	Std Pkg.	UL
	Fusible								
A	U045F	90	10	NU100B2	Y	9 x 17	13.5	1	Y
B	U610F	100							

* Wire Range Table on page 7-7. See Technical Data on page 7-6 for available replacement parts.

AC with Ground Fault

1-Phase / 3-Phase, 30 – 60 Amps, 120/240V or 240V

Model Number	Phase	Receptacle	Amps	Horsepower Rating	Wire Range*	Cabinet Size	Unit Wt.	Std Pkg.	UL
Phase 1 – 120/240V									
U035F010	1	5-15R2GFI	30	3	D	5 x 7	4	4	
U065F010	1	5-15R2GFI	60	3-10	D	7 x 9-1/10	6.44	1	Y
U065P010	1	5-15R2GFI	60	10	D	5 x 7	4.3	6	
U065NA1010	1	5-15R2GFI					4	6	
U065PC2	1	5-20R2					4.3	4	
Phase 3 – 240V									
U0353F010	3	5-20R2GFI	30	7.5-15	D	7 x 14	9.5	4	Y
U0653F010	3	5-20R2GFI	60				8.5	4	

* Wire Range Table on page 7-7. See Technical Data on page 7-6 for available replacement parts.

Evaporative Cooler

Fusible, 20 – 40 Amps, 120/240V

Evaporative cooler applications not only require fusing but switching or receptacle functions depending on equipment type and local codes. Two models are offered to meet these varied evaporative cooler applications.

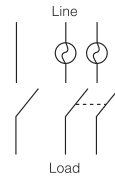

Fig. A
U220H

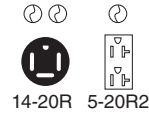

Fig. B
U261F

Fig.	Model Number	Receptacle	Circuit Protection	Amps	Wire Range*	Cabinet Size	Unit Wt.	Std Pkg.	UL
	Fusible								
A	U220H	DPST, SPST Switch	(2) FH1	20	AR	5 x 7	4.5	4	N
B	U261F	14-20R, 5-20R2	(3) FH1	40	E	6 x 9	6		UL

* Wire Range Table on page 7-7.

Key

□ = Accepts Class H fuses (fuses not included)

⊙ = Edison plug fuse base (fuses not included)

Mounting Bracket

Exterior

Fig.	Model Number	Orientation	Description	Std Pkg.
C	STC1	Exterior	For AC and AC/GFI in aluminum, vinyl siding and stucco applications	6

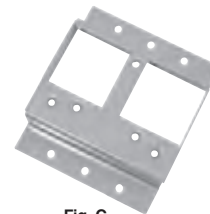

Fig. C
STC1

Technical Data

Model Number	Replacement Parts			Cabinet Size	Enclosure Style	Cabinet Dimensions (inches)				Knockout Figure ¹
	Complete Block and Puller	Fuse Block Only	Puller Only			Height (A)	Width (B)	Depth (C)	Depth (D)	
P035F	FR39	—	FR352	6 x 8	C	8	5-3/4	3-1/8	—	5
P065F	FR69	—	FH682	6 x 8	C	8	5-3/4	3-1/8	—	5
P065NA1	—	—	—	5 x 7	D	7-1/4	5	2-1/8	2-3/4	1
P065P	—	NF65	NF652	6 x 8	D	8	6	5-3/4	2-3/4	5
P065P1	—	NF65	NF652	5 x 7	D	7	5	2-1/8	2-3/4	1
U035F010	FR35R	—	FR352R	9 x 7	A	9	6-3/5	3-4/5	5-1/5	7
U035F2	FR35R	—	FR352R	5 x 7	A	7	5	2-1/8	2-3/4	1
U0353F	265A6035G27	—	265A6035G27	6 x 14	B	14-3/8	7-1/4	5-3/16	—	6
U0353F010	265A6035G27	—	265A6035G27	7 x 14	B	14	7	5-3/16	—	6
U045F	FR35XFR67	—	FR352, FH682	9 x 17	B	17-3/8	9-3/4	5-3/16	—	2
U0653F	265A6036G69	—	265A6036G69	6 x 14	B	14-3/8	7-1/4	5-3/16	—	6
U0653F010	265A6036G69	—	265A6036G69	7 x 14	B	14	7	5-3/16	—	6
U0653P	265A6036G73	—	265A6036G73	6 x 14	B	14-3/8	7-1/4	5-3/16	—	6
U0653P010	—	—	—	7 x 14	B	14	7	5-3/16	—	6
U065F010	FR69	—	FH682	9 x 7	B	9	7	5-1/5	—	7
U065F1	FR65	—	FH682	5 x 9	A	9	5	2-1/8	2-3/4	1
U065NA1	—	—	—	5 x 7	D	7	5	2-1/8	2-3/4	1
U065NA2	—	—	—	7 x 10	E	10	7-1/2	4	—	8
U065NA1010	—	—	—	5 x 7	D	7	5	3-5/8	5-3/16	3
U065P	—	NF65	NF652	5 x 7	A	7-1/4	5	2-1/8	2-3/4	1
U065PD	—	NF65	NF652	7 x 10	E	10	7-1/2	4	—	8
U065P010	—	NF65	NF652	5 x 7	D	7	5	3-5/8	5-3/16	3
U065PC2	—	NF65	NF652	5 x 7	D	7	5	2-1/8	2-3/4	3
U220H	—	FH1	—	5 x 7	B	7-1/8	5-3/4	5-3/16	—	3
U261F	—	FH1	—	6 x 9	B	9-1/8	7-1/4	5-3/16	—	4
U610F	FR67X2	—	FH682	9 x 17	B	17-3/8	9-3/4	5-3/16	—	2

¹ Knockout Figures on page 7-7.

Enclosure Styles / Cabinet Dimensions

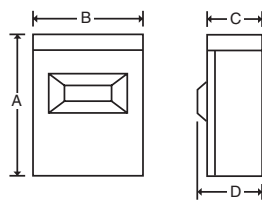

Fig. A

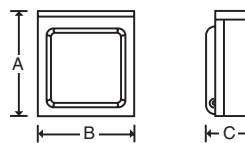

Fig. B

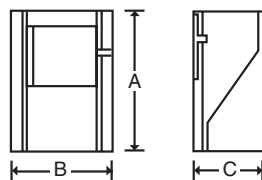

Fig. C

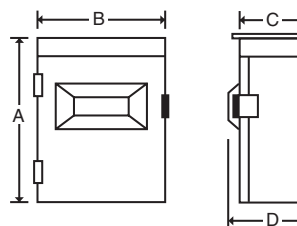

Fig. D

Knockout Configurations

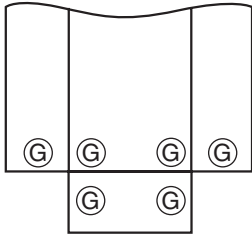

Fig. 1

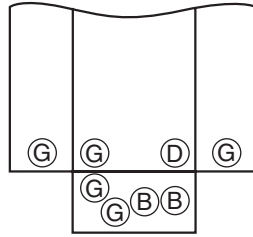

Fig. 2

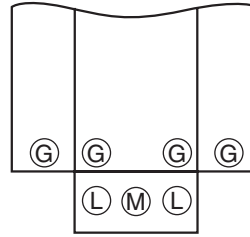

Fig. 3

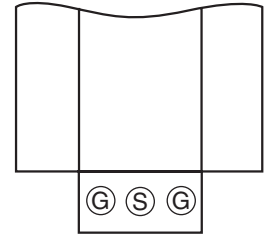

Fig. 4

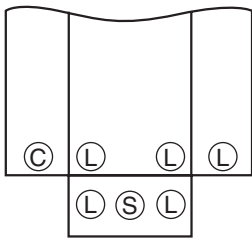

Fig. 5

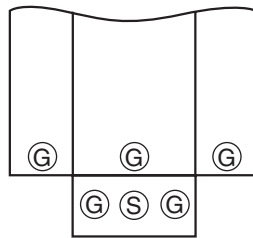

Fig. 6

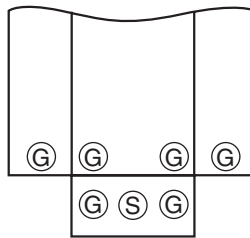

Fig. 7

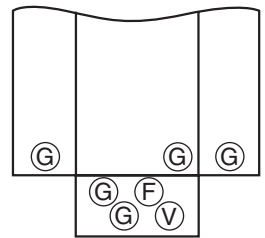

Fig. 8

Knockout Key

- B = 1", 1-1/4", 1-1/2"
- C = 3/4", 1-1/4"
- D = 3/4", 1", 1-1/4"
- F = 1/2"
- G = 1/2", 3/4", 1"
- L = 1/2", 3/4"
- M = 1/2", 3/4", 1", 1-1/4"
- S = 1/2", 3/4", 1", 1-1/4", 1-1/2"
- V = 3/4", 1", 1-1/4", 1-1/2"
- W = 3/4", 1"
- Y = 1", 1-1/4"

* Knockouts shown for size not for exact positions.

Wire Range Tables

D

Connector	Copper		Aluminum	
	Solid	Strand	Solid	Strand
Line	14-8	14-2	12-8	12-2
Load	14-8	14-2	12-8	12-2
Neutral	—	—	—	—
Equipment Ground	12-8	12-2	12-8	12-2

E

Connector	Copper		Aluminum	
	Solid	Strand	Solid	Strand
Line	14-10	14-10	—	—
Load	14-10	14-10	—	—
Neutral	14-10	14-10	—	—
Equipment Ground	12-8	12-2	—	—

Y

Connector	Copper		Aluminum	
	Solid	Strand	Solid	Strand
Line	14-8	14-1/0	12-8	12-1/0
Load	14-8	14-2	12-1/0	12-2
Neutral	14-8	14-1/0	12-8	12-1/0

AR

Connector	Copper		Aluminum	
	Solid	Strand	Solid	Strand
Line	14-10	14-10	—	—
Load	14-10	14-10	—	—
Neutral	—	—	—	—
Equipment Ground	12-8	12-2	—	—

Notes

Section 8

Transfer Switches / Power Inlets



Application Information

Midwest Electric heavy duty manual transfer switches help provide reliable transfer of power from the normal utility-supplied source to a standby generator, enabling the user to readily maintain power during utility outages. Use them anywhere an extended outage would result in severe loss, damage or inconvenience.

Designed to be operational and switchable at full rated capacity, Midwest Electric transfer switches are available in single- and three-phase configurations at ratings through 600V. The double-throw mechanism helps prevent dangerous backfeeding of generator power into the utility system.



Features and Benefits

Electrical Ratings

- 100-400 amperes
- 240V or 600V models
- 10kAIC

Rugged Durability

- Break before make switch mechanism*
- All-in-one construction with factory-assured terminations
- Bus bars interconnect main and standby switches*
- Knife blade switch contacts help provide long life
- NEMA 3R weatherproof enclosure
- G90 galvanized steel construction for superior corrosion protection
- Durable polyester powder coat finish resists chipping and fading
- High quality, user-tested components designed for long life

User Protection

- Interlock allows door opening only when switch is in the OFF position*
- Padlock provision in all three ON-OFF-ON transfer positions
- Padlock provision on door

Installation Ease

- Optional neutral kits available for both 240V and 600V models
- Broad range of concentric knockouts accommodate varying wiring needs
- All terminals accept copper or aluminum wire for installation flexibility



* On most models.

Steel Enclosures

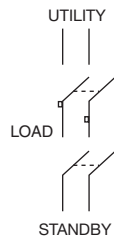

Fig. A
GS1101B12UL, GS1201B20UL, GS1202B20UL,
GS1402B01UL, GS1404B01UL

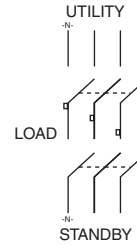

Fig. B
GS3402B01UL, GS3404B01UL, GS3161B12UL,
GS3262B25UL, GS3464B01UL

Two Pole, 100 – 400 Amps, 120/240V

Fig.	Model Number	Switch Ratings		Optional Neutral Kit ¹	Unit Wt.	UL
		Amps				
		Main	Standby			
A	GS1101B12UL	100	100	NEU102	31	cUL ^{us}
	GS1201B20UL	200	100	NEU202	42	
	GS1202B20UL	200	200	NEU202	46	
	GS1402B01UL	400	200	NEU407	71	cUL ^{us}
	GS1404B01UL	400	400	NEU407	80	

¹ Order Neutral Kit for 3-wire system (120/240).

Three Pole, 200 – 400 Amps, 240V

Fig.	Model Number	Switch Ratings		Optional Neutral Kit ¹	Unit Wt.	UL
		Amps				
		Main	Standby			
B	GS3402B01UL	400	200	NEU407	107	cUL ^{us}
	GS3404B01UL	400	400		120	

¹ Order Neutral Kit for 4-wire system (280Y/120).

Three Pole, 100 – 400 Amps, 600V

Fig.	Model Number	Switch Ratings		Optional Neutral Kit ¹	Unit Wt.	UL
		Amps				
		Main	Standby			
B	GS3161B12UL	100	100	NEU102	31	cUL ^{us}
	GS3262B25UL	200	200	NEU202	48	
	GS3464B01UL	400	400	NEU407	120	

¹ Order Neutral Kit for 4-wire systems (208Y/120, 480Y/277, 600Y/347).

All three pole models are suitable for use in 1-Phase, 3-wire, switched neutral applications – no neutral required.

Light Duty Transfer Switches with Aluminum Enclosures

Two Pole, 100 – 200 Amps, 120/240V or 240V

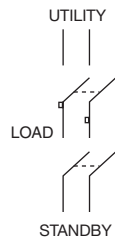

Fig. A
GS316G, GS1202B20M

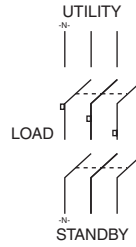

Fig. B
GS3262G

Fig.	Model Number	Switch Ratings		Neutral Kit	Unit Wt.	UL
		Amps				
		Main	Standby			
Two Pole – 120/240V						
A	GS3161G	100	100	Factory Installed	11	
Two Pole – 240V						
B	GS3262G	200	200	Factory Installed	43	

Transfer Switch with Attached Meter Socket and Steel Enclosure

Two Pole, 200 Amps, 120/240V

Fig.	Model Number	Switch Ratings		Neutral Kit	Unit Wt.	UL
		Amps				
		Main	Standby			
A	GS1202B20M	200	200	Factory Installed	50	N

Technical Data

Model Number	Wire Range (cu/al)	Conduit Hub/Opening ¹		Enclosure Style	Cabinet Dimensions (inches)				Knockout Figure
		Qty.	Size		Height (A)	Width (B)	Depth (C)	Depth (D)	
GS1101B12UL	12-1/0	1	1-1/4	A	26	13	6-3/4	10-5/8	1
GS3161B12UL					26	13	6-3/4	10-5/8	1
GS1201B20UL	6-250	1	2	A	32	15-3/4	6-3/4	10-5/8	2
GS1202B20M			2-1/2	B	36-1/10	14-3/10	4-4/5	—	5
GS1202B20UL			2	A	35	15-3/4	7	10-5/8	2
GS3262B25UL			2-1/2	A	34-3/4	15-3/4	6-3/4	10-5/8	2
GS1402B01UL	2-600 or (2) 1/0-250	2	Closure Caps	A	43-1/2	18-1/2	9-1/4	14-1/8	3
GS1404B01UL					43-3/4	18-1/2	9-1/4	14-1/8	3
GS3161G	14-1/0	1	Closure Cap	A	15-1/4	8	5-2/5	6-9/10	6
GS3262G	6-250			A	30-1/4	15-3/10	8-3/5	11-4/5	7
GS3402B01UL	2-600 or (2) 1/0-250	2	Closure Caps	A	42-1/2	24	9-1/4	14-1/8	4
GS3404B01UL					43-1/2	24	9	14-1/8	4
GS3464B01UL					43-1/2	24	9	14-1/8	4

¹ Switch includes conduit hub or closure cap(s) as indicated. Alternate conduit hub sizes on page 14-3.

Enclosure Styles / Cabinet Dimensions

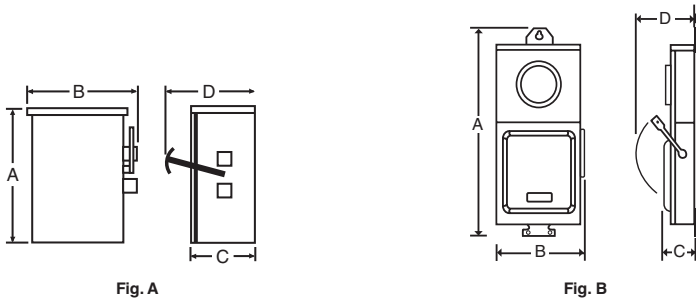

Knockout Configurations

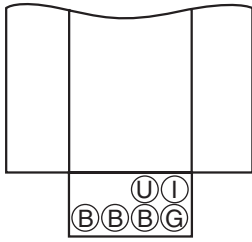

Fig. 1

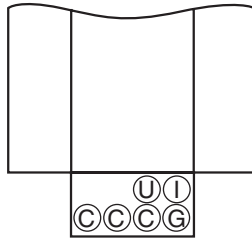

Fig. 2

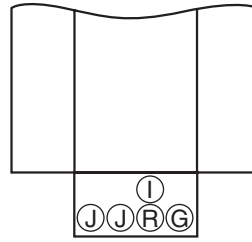

Fig. 3

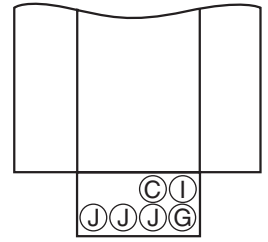

Fig. 4

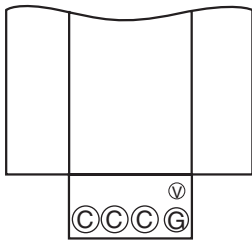

Fig. 5

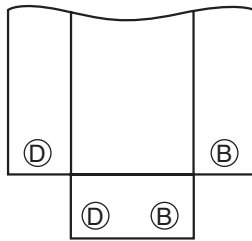

Fig. 6

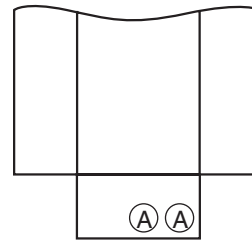

Fig. 7

Knockout Key

- A = 1-1/2", 2", 2-1/2"
- B = 1", 1-1/4", 1-1/2"
- C = 1-1/4", 1-1/2", 2"
- D = 3/4", 1", 1-1/4"
- G = 1/2", 3/4", 1"
- I = 11/16"
- J = 2", 2-1/2", 3", 3-1/2"
- R = 3/4", 1", 1-1/4", 1-1/2", 2"
- U = 1/4"
- V = 1/2"

* Knockouts shown for size not for exact positions.

Power Inlets

Power inlets from Midwest Electric work with the manual transfer switches for standby power. Each inlet comes in a single enclosure for maximum protection against weather and normal field use.

Features and Benefits

- All-in-one construction with factory-assured terminations help reduce installation time
- NEMA 3R weatherproof enclosure
- G90 galvanized steel construction for superior corrosion protection
- Durable polyester powder coat finish resists chipping and fading
- Rolled edge door for cord protection
- Cover design accommodates cords in place while maintaining NEMA 3R integrity
- Padlockable to help prevent unauthorized access
- Deadfront constructions help prevent accidental contact with live parts



U030N

Technical Data



Fig. A
U020N
 L14-20



Fig. B
U030N
 L14-30



Fig. C
U050N
 CS6375

20 – 50 Amps, 120/240V

Fig.	Model Number	Amps	Receptacles	Dimensions (inches)		
				Height	Width	Depth
A	U020N	20	L14-20	14-3/8	6-3/4	5-3/16
B	U030N	30	L14-30			
C	U050N	50	CS6375 ²			

¹ Also includes (2) MHQL1120 20A circuit breakers and one breaker space.

² California Standard, three pole, 4 wire grounded non-NEMA.

Knockout Configuration

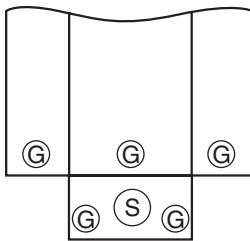

Fig. 1

Knockout Key

G = 1/2", 3/4", 1"

S = 1/2", 3/4", 1", 1-1/4", 1-1/2"

* Knockouts shown for size not for exact positions.

Section 9

Temporary Power



Application Information

Prior to permanently installing service equipment on a new structure, temporary power is typically installed to support the various construction trades. Electricians that are not familiar with Midwest Electric's Site-Power™ line usually construct their own temporary power arrangement using a combination of individual outdoor rated components (meter box, load center and multiple receptacles) assembled on a sheet of plywood and anchored to the ground with dimension lumber. While sufficient to do the job, this arrangement is labor intensive, has multiple conduit connections with the potential for water intrusion and is not well protected against unauthorized use.

Site-Power™ temporary power equipment from Midwest Electric combines the metering, circuit protection and power outlet combinations that are required on most construction sites. Every unit is delivered to the job site ready to go with factory installed and wired components — giving you the assurance needed for a reliable and safe temporary power unit. All Site-Power™ enclosures are constructed from heavy-gauge G90 galvanized steel for superior corrosion resistance. The durable polyester powder coat finish resists chipping and fading. The equipment door is designed to protect power cords and plugs and has a padlock provision to guard against unauthorized use or vandalism.



U055C010P

Features and Benefits

Rugged Durability

- Rolled edge door for cord protection
- Continuous duty meter socket with meter guides and reinforced jaws – ringless and ring type
- Utility accepted meter sealing accommodations
- NEMA 3R weatherproof construction
- G90 galvanized steel construction for superior corrosion resistance
- Durable polyester powder coat finish resists chipping and fading
- 10kAIC
- All GFCI duplexes are listed as weather resistant and tamper resistant as required by NEC in Article 406.8 and 406.11

Installation Ease

- All components factory wired and assembled, reducing installation time
- Door removable for installation ease; stay open position for user convenience
- All terminals accept copper or aluminum wire for added installation flexibility
- Wide range of receptacle configurations
- Broad range of concentric knockouts to accommodate varied wiring needs
- All units with factory installed Cu/Al equipment ground lug

User Safety

- Dead front construction prevents accidental contact with live parts
- Padlock provision to prevent unauthorized access

All-In-One Design

- Includes circuit breakers, receptacles and meter socket (if required)
- Available with GFI circuit breakers
- Eliminates construction delays due to red tag code violations
- All ringless meter socket models have standard horn bypass
- Conforms to NEC and NEMA standards

Unmetered

30 – 40 Amps, 120/240V

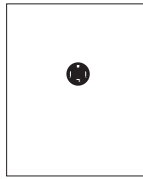

Fig. A
U030
 14-30R

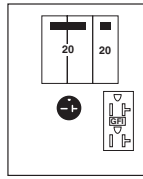

Fig. B
U036C010
 6-20R, 5-20R2GFCI

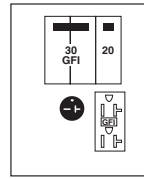

Fig. C
U036C033
 6-20R, 5-20R2GFCI

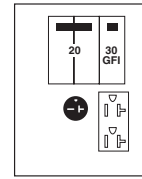

Fig. D
U036G
 6-20R, 5-20R2

Fig.	Model Number	Receptacles	Circuit Protection	Amps	Wire Range*	Cabinet Size	Hub Opening	Load & Neutral Bar	Unit Wt.	Std Pkg.	UL
A	U030	14-30R	—	30	G	5 x 7	Y	—	4.5	1	Y
B	U036C010	6-20R, 5-20R2GFCI	THQL2120, THQL1120	40	K	6 x 14		LC33N7	10	4	cULus
C	U036C033	6-20R, 5-20R2GFCI	THQL2130GFT, THQL1120	40	K	6 x 14		LC33N7	10	4	
D	U036G	6-20R, 5-20R2	THQL2120, THQL2130GFT	40	K	6 x 14		LC33N7	10	4	

* Wire Range Table on page 9-12.

Unmetered

70 Amps, 120/240V

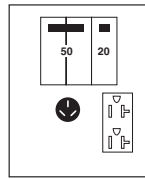

Fig. A
U051C
 10-50R, 5-20R2

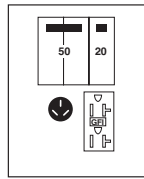

Fig. B
U051C010
 10-50R, 5-20R2GFCI

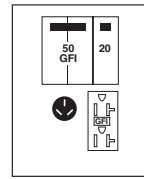

Fig. C
U051C033
 10-50R, 5-20R2GFCI

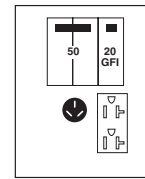

Fig. D
U051G
 10-50R, 5-20R2

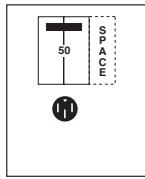

Fig. E
U054C
 BR54U

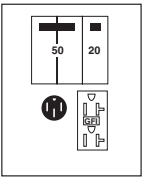

Fig. F
U055C010P
 BR54U, 5-20R2GFCI

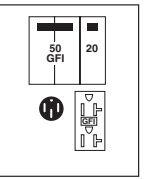

Fig. G
U055C033
 BR54U, 5-20R2GFCI

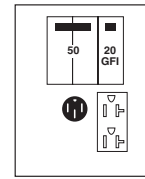

Fig. H
U055G
 BR54U, 5-20R2

Fig.	Model Number	Receptacles	Circuit Protection	Amps	Wire Range*	Cabinet Size	Hub Opening	Load & Neutral Bar	Unit Wt.	Std Pkg.	UL
A	U051C	10-50R, 5-20R2	THQL2150, THQL1120	70	K	6 x 14	Y	LC33N7	10	4	N
B	U051C010	10-50R, 5-20R2GFCI	THQL2150, THQL1120	70	K						
C	U051C033	10-50R, 5-20R2GFCI	THQL2150GFT, THQL1120	70	K						
D	U051G	10-50R, 5-20R2	THQL2150, THQL1120GFT	70	K						
E	U054C	BR54U	THQL2150, Space THQL1120	70	O						cULus
F	U055C010P	BR54U, 5-20R2GFCI	THQL2150, THQL1120	70	K						
G	U055C033	BR54U, 5-20R2GFCI	THQL2150GFT, THQL1120	70	K						
H	U055G	BR54U, 5-20R2	THQL2150, THQL1120GFT	70	K						

* Wire Range Table on page 9-12.

Unmetered

90 – 125 Amps, 120/240V

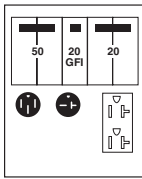

Fig. A
U073G
BR54U, 6-20R, 5-20R2

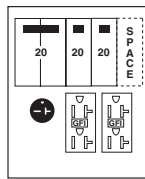

Fig. B
U038C010
6-20R, (2) 5-20R2GFCI

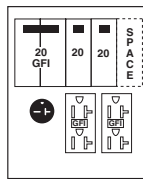

Fig. C
U038C033
6-20R, (2) 5-20R2GFCI

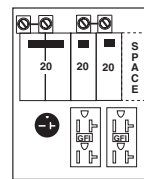

Fig. D
U038CTL010
6-20R, (2) 5-20R2GFCI

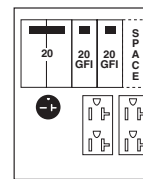

Fig. E
U038G
6-20R, (2) 5-20R2

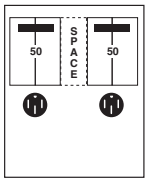

Fig. F
U072C
(2) BR54U

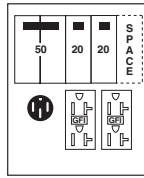

Fig. G
U076C010
BR54U, (2) 5-20R2GFCI

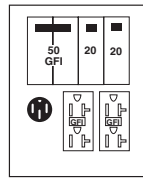

Fig. H
U076C033
BR54U, (2) 5-20R2GFCI

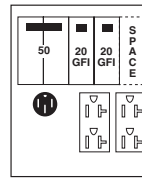

Fig. I
U076G
BR54U, (2) 5-20R2

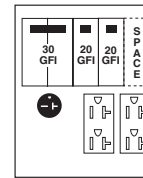

Fig. J
U038G033
6-20R, (2) 5-20R2

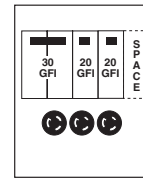

Fig. K
U039G6
L6-30R, (2) L5-20R

Fig.	Model Number	Receptacles	Circuit Protection	Amps	Wire Range*	Cabinet Size	Hub Opening	Load & Neutral Bar	Unit Wt.	Std Pkg.	UL
A	U073G	BR54U, 6-20R, 5-20R2	THQL2150, THQL2120, THQL1120GFT	90	U	9 x 17	Y	LC55N1	16	1	UL
B	U038C010	6-20R, (2) 5-20R2GFCI	THQL2120, (2) THQL1120	100	AA	9 x 17		LC55N1	15	1	
C	U038C033	6-20R, (2) 5-20R2GFCI	THQL2120GFT, (2) THQL1120, Space THQL1120	100	AA	9 x 17		LC55N1	15	1	
D	U038CTL010 ¹	6-20R, (2) 5-20R2GFCI	THQL2120, (2) THQL1120, Space THQL1120	100	AA	9 x 17		LC55N1T	16	1	
E	U038G	6-20R, (2) 5-20R2	THQL2120, (2) THQL2120GFT, Space THQL1120	100	U	9 x 17		LC55N1	15	1	
F	U072C	(2) BR54U	(2) THQL2150, Space THQL1120	100	V	9 x 17		LC55N1	16	1	
G	U076C010	BR54U, (2) 5-20R2GFCI	THQL2150, (2) THQL1120, Space THQL1120	100	AA	9 x 17		LC55N1	16	1	
H	U076C033	BR54U, (2) 5-20R2GFCI	(2) THQL1120, THQL2150GFT	100	AA	9 x 17		LC55N1	16	1	
I	U076G	BR54U, (2) 5-20R2	THQL2150, (2) THQL1120GFT, Space THQL1120	100	U	9 x 17		LC55N1	16	1	
J	U038G033	6-20R, (2) 5-20R2	THQL2130GFT, (2) THQL1120GFT, Space THQL1120	100	U	9 x 17		LC55N1	15	1	
K	U039G6	L6-30R, (2) L5-20R	THQL2130GFT, (2) THQL1120GFT, Space THQL1120	125	C	9 x 21		LC88PC	16	1	

¹ Available with GFI dual-pole breaker in place of GFI receptacle – replace "010" with "033". Order U038CTL033.

* Wire Range Table on page 9-12.

Metered

Top Feed, 40 – 90 Amps, 120/240V

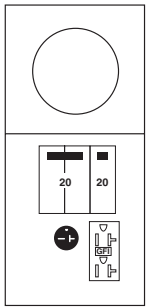

Fig. A
M036C010, R036C010
6-20R, 5-20R2GFCI

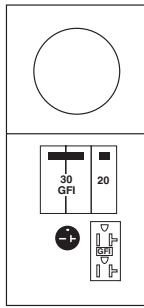

Fig. B
M036C033
6-20R, 5-20R2GFCI

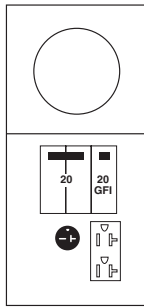

Fig. C
M036G, R036G
6-20R, 5-20R2

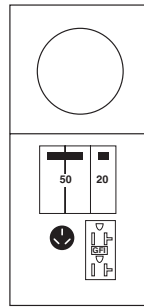

Fig. D
M051C010
10-50R, 5-20R2GFCI

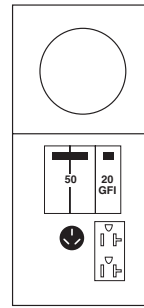

Fig. E
M051G
10-50R, 5-20R2

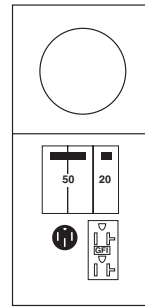

Fig. F
M055C010, R055C010
BR54U, 5-20R2GFCI

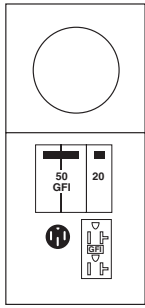

Fig. G
M055C033, R055C033
BR54U, 5-20R2GFCI

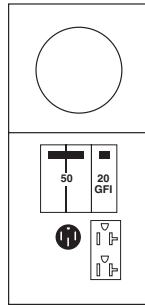

Fig. H
M055G, R055G
BR54U, (2) 5-20R2

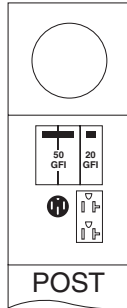

Fig. I
M055GP6033
BR54U, 5-20R2

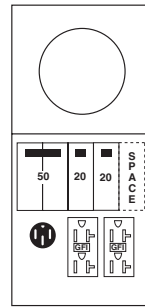

Fig. J
M076C010, R076C010
BR54U, (2) 5-20R2GFCI

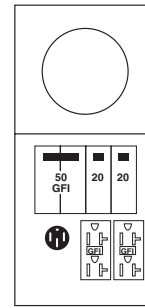

Fig. K
M076C033, R076C033
BR54U, (2) 5-20R2GFCI

Fig.	Model Number		Receptacles	Circuit Protection	Amps	Wire Range*	Cabinet Size	Hub Opening	Load & Neutral Bar	Unit Wt.	Std Pkg.	UL
	Ringtype	Ringless										
A	M036C010	R036C010	6-20R, 5-20R2GFCI	THQL2120, THQL1120	40	AA	9 x 30		LC33N1	25		UL US
B	M036C033	—	6-20R, 5-20R2GFCI	THQL2130GFT, THQL1120	40	AA	9 x 30		LC33N1	23		
C	M036G	R036G	6-20R, 5-20R2	THQL2120, THQL1120GFT	40	AA	9 x 30		LC33N1	25		
D	M051C010	—	10-50R, 5-20R2GFCI	THQL2150, THQL1120	70	AA	9 x 30		LC33N1	25		
E	M051G	—	10-50R, 5-20R2	THQL2150, THQL1120GFT	70	AA	9 x 30		LC33N1	25		
F	M055C010	R055C010	BR54U, 5-20R2GFCI	THQL2150, THQL1120	70	K	9 x 30	Y	LC33N1	25	1	
G	M055C033	R055C033	BR54U, 5-20R2GFCI	THQL2150GFT, THQL1120	70	K	9 x 30		LC33N1	23		
H	M055G	R055G	BR54U, 5-20R2	THQL2150, THQL1120GFT	70	AA	9 x 30		LC33N1	25		
I	M055GP6033 ¹	—	BR54U, 5-20R2	THQL1120GFT, THQL2150GFT	70	A2	9 PT		LC33N1	51		
J	M076C010	R076C010	BR54U, (2) 5-20R2GFCI	THQL2150, (2) THQL1120, Space THQL1120	90	AA	9 x 30		LC55N1	25		
K	M076C033	R076C033	BR54U, (2) 5-20R2GFCI	THQL2150GFT, (2) THQL1120, Space THQL1120	90	AA	9 x 30		LC55N1	25		

¹ Earth Burial Post. See page 11-25 for post mounted dimensions.
* Wire Range Table on page 9-12.

Metered

Top Feed, 40 – 100 Amps, 120/240V

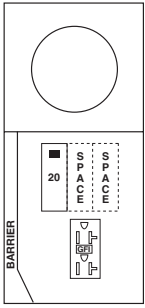

Fig. A
M009C010
5-20R2GFCI

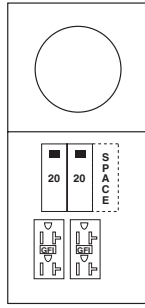

Fig. B
M011C010, R011C010
(2) 5-20R2GFCI

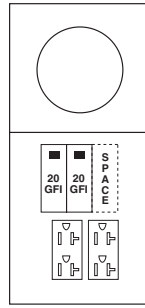

Fig. C
M011G, R011G
(2) 5-20R2

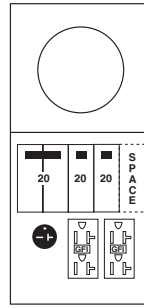

Fig. D
M038C010, R038C010
6-20R, (2) 5-20R2GFCI

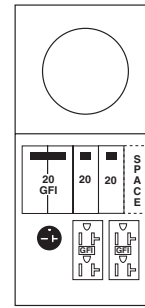

Fig. E
M038C033, R038C033
6-20R, (2) 5-20R2GFCI

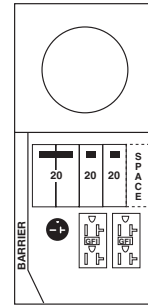

Fig. F
M038CB1010
6-20R, (2) 5-20R2GFCI

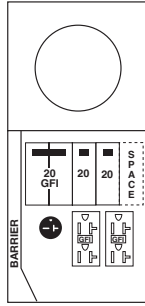

Fig. G
M038CB1033
6-20R, (2) 5-20R2GFCI

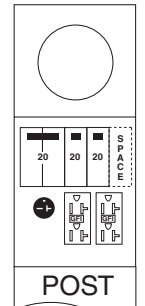

Fig. H
R038CP4010
6-20R, (2) 5-20R2GFCI

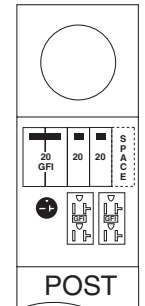

Fig. I
R038CP4033
6-20R, (2) 5-20R2GFCI

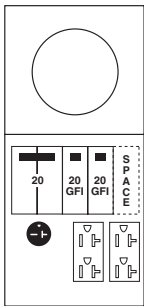

Fig. J
M038G, R038G
6-20R, (2) 5-20R

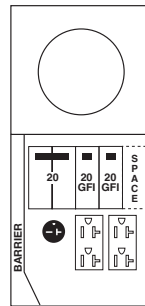

Fig. K
M038GB1
6-20R, (2) 5-20R

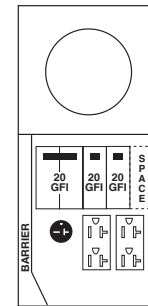

Fig. L
M038GB1033
6-20R, (2) 5-20R

Fig.	Model Number		Receptacles	Circuit Protection	Amps	Wire Range*	Cabinet Size	Hub Opening	Load & Neutral Bar	Unit Wt.	Std Pkg.	UL
	Ringtype	Ringless										
A	M009C010	—	5-20R2GFCI	THQL1120, Space (2) THQL1120	40	AA	9 x 30	Y	LC33N1	22	1	cULus
B	M011C010	R011C010	(2) 5-20R2GFCI	(2) THQL1120, Space THQL1120	100	AA	9 x 30		LC33N1	21	1	
C	M011G	R011G	(2) 5-20R2	(2) THQL1120GFT, Space THQL1120	100	AA	9 x 30		LC33N1	21	1	
D	M038C010	R038C010	6-20R, (2) 5-20R2GFCI	THQL2120, (2) THQL1120, Space THQL1120	100	AA	9 x 30		LC55N1	25	1	
E	M038C033	R038C033	6-20R, (2) 5-20R2GFCI	THQL2120GFT, (2) THQL1120, Space THQL1120	100	AA	9 x 30		LC55N1	24	1	
F	M038CB1010	—	6-20R, (2) 5-20R2GFCI	THQL2120, (2) THQL1120, Space THQL1120	100	AA	14 x 26		LC55N1	33	1	
G	M038CB1033	—	6-20R, (2) 5-20R2GFCI	THQL2120GFT, (2) THQL1120, Space THQL1120	100	AA	14 x 26		LC55N1	33	1	
H	—	R038CP4010 ¹	6-20R, (2) 5-20R2GFCI	THQL2120, (2) THQL1120, Space THQL1120	100	A2	9 PT		LC55N1	45	1	cULus
I	—	R038CP4033 ¹	6-20R, (2) 5-20R2GFCI	THQL2120GFT, (2) THQL1120, Space THQL1120	100	A2	9 PT		LC55N1	45	1	
J	M038G	R038G	6-20R, (2) 5-20R	THQL2120, (2) THQL1120GFT, Space THQL1120	100	AA	9 x 30		LC55N1	25	4	Y
K	M038GB1	—	6-20R, (2) 5-20R	THQL2120, (2) THQL1120GFT, Space THQL1120	100	AA	14 x 26		LC55N1	35	1	
L	M038GB1033	—	6-20R, (2) 5-20R2	THQL2120GFT, (2) THQL1120GFT, Space THQL1120	100	AA	14 x 26		LC55N1	35	1	

¹ Pad Mount Post. See page 11-25 for post mounted dimensions. * Wire Range Table on page 9-12.

Data subject to change without notice.

Metered

Bottom Feed, 40 – 100 Amps, 120/240V

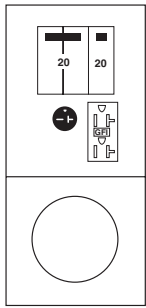

Fig. A
M036C010U
6-20R, 5-20R2GFCI

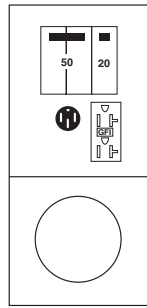

Fig. B
M055C010U, R055C010U
BR54U, 5-20R2GFCI

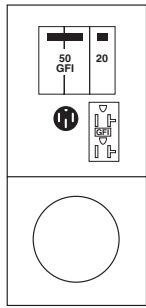

Fig. C
M055C033U, R055C033U
BR54U, 5-20R2GFCI

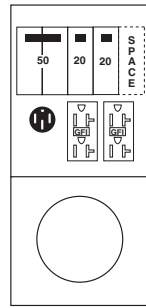

Fig. D
M076C010U, R076C010U
BR54U, (2) 5-20R2GFCI

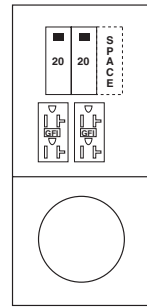

Fig. E
M011C010U, R011C010U
(2) 5-20R2GFCI

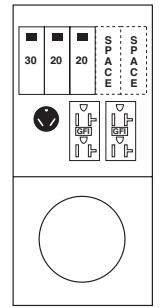

Fig. F
R031C010U
R32U, (2) 5-20R2GFCI

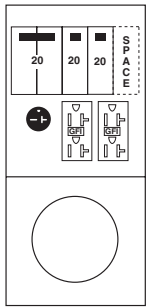

Fig. G
M038C010U, R038C010U
6-20R, (2) 5-20R2GFCI

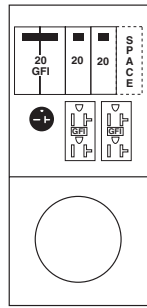

Fig. H
M038C033U, R038C033U
6-20R, (2) 5-20R2GFCI

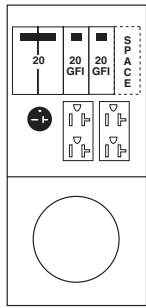

Fig. I
R038GU
6-20R, (2) 5-20R2

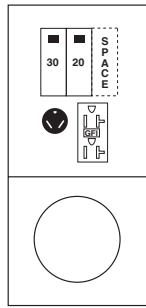

Fig. J
M041C010U
R32U, 5-20R2GFCI

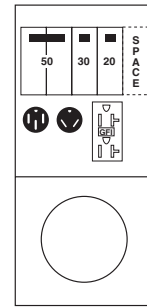

Fig. K
M075C010U, R075C010U
BR54U, R32U, 5-20R2GFCI

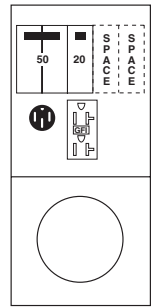

Fig. L
M355C010U
BR54U, 5-20R2GFCI

Fig.	Model Number		Receptacles	Circuit Protection	Amps	Wire Range*	Cabinet Size	Hub Opening	Load & Neutral Bar	Unit Wt.	Std Pkg.	UL
	Ringtype	Ringless										
A	M036C010U	—	6-20R, 5-20R2GFCI	THQL2120, THQL1120	40	X	9 x 30U	N	LC33N1	25	1	UL
B	M055C010U	R055C010U	BR54U, 5-20R2GFCI	THQL2150, THQL1120	70	H	9 x 30U	N	LC33N1	25		
C	M055C033U	R055C033U	BR54U, 5-20R2GFCI	THQL2150GFT, THQL1120	70	H	9 x 30U	Y	LC33N1	23		
D	M076C010U	R076C010U	BR54U, (2) 5-20R2GFCI	THQL2150, (2) THQL1120, Space THQL1120	90	X	9 x 30U	N	LC55N1	25		
E	M011C010U	R011C010U	(2) 5-20R2GFCI	(2) THQL1120, Space THQL1120	100	X	9 x 30U	N	LC33N1	21		
F	—	R031C010U	R32U, (2) 5-20R2GFCI	THQL1130, (2) THQL1120	100	AA	9 x 30U	Y	LC55N1	25		
G	M038C010U	R038C010U	6-20R, (2) 5-20R2GFCI	THQL2120, (2) THQL1120, Space THQL1120	100	X	9 x 30U	N	LC55N1	25		
H	M038C033U	R038C033U	6-20R, (2) 5-20R2GFCI	THQL2120GFT, (2) THQL1120, Space THQL1120	100	X	9 x 30U	Y	LC55N1	26		
I	—	R038GU	6-20R, (2) 5-20R2	THQL2120, (2) THQL1120GFT	100	X	9 x 30U	N	LC55N1	25		
J	M041C010U	—	R32U, 5-20R2GFCI	THQL1130, THQL1120, Space THQL1120	100	AA	9 x 30U	Y	LC33N1	25		
K	M075C010U	R075C010U	BR54U, R32U, 5-20R2GFCI	THQL2150, THQL1130, THQL1120, (1) Space	100	AA	9 x 30U	Y	LC55N1	25		
L	M355C010U	—	BR54U, 5-20R2GFCI	THQL2150, THQL1120, (2) Space THQL1120	100	AA	9 x 30U	Y	LC55N1	25		

* Wire Range Table on page 9-12.

Technical Data

Model Number	Replacement Parts	Cabinet Size	Enclosure Style ¹	Cabinet Dimensions (inches)			Knockout Figure ²
	Meter Socket			Height (A)	Width (B)	Depth (C)	
M009C010	MSM100930	9 x 30	B	30	9-3/4	5-3/16	2
M011C010	MSM100930	9 x 30	B	30	9-3/4	5-3/16	2
M011C010U	MSM100EZ	9 x 30U	C	30	9-3/4	5-3/16	3
M011G	MSM100930	9 x 30	B	30	9-3/4	5-3/16	2
M036C010	MSM100930	9 x 30	B	30	9-3/4	5-3/16	2
M036C010U	MSM100EZ	9 x 30U	C	30	9-3/4	5-3/16	3
M036C033	MSM100930	9 X 30	B	30	9-3/4	5-3/16	2
M036G	MSM100930	9 x 30	B	30	9-3/4	5-3/16	2
M038C010	MSM100930	9 x 30	B	30	9-3/4	5-3/16	2
M038C010U	MSM100EZ	9 x 30U	C	30	9-3/4	5-3/16	3
M038C033	MSM100930	9 X 30	B	30	9-3/4	5-3/16	2
M038C033U	MSM100EZ	9 X 30U	C	30	9-3/4	5-3/16	3
M038CB1010	MSM10014	14 x 26	B	26-1/4	14-3/4	4-9/16	4
M038CB1033	MSM10014	14 x 26	B	26-1/4	14-3/4	4-9/16	4
M038G	MSM100930	9 x 30	B	30	9-3/4	5-3/16	2
M038GB1	MSM10014	14 x 26	B	26-1/4	14-3/4	4-9/16	4
M038GB1033	MSM10014	14 x 26	B	26-1/4	14-3/4	4-9/16	4
M041C010U	MSM100EZ	9 x 30U	C	30	9-3/4	5-3/16	4
M051C010	MSM100930	9 x 30	B	30	9-3/4	5-3/16	2
M051G	MSM100930	9 x 30	B	30	9-3/4	5-3/16	2
M055C010	MSM100930	9 x 30	B	30	9-3/4	5-3/16	2
M055C010U	MSM100EZ	9 x 30U	C	30	9-3/4	5-3/16	3
M055C033	MSM100930	9 x 30	B	30	9-3/4	5-3/16	2
M055C033U	MSM100EZ	9 x 30U	C	30	9-3/4	5-3/16	3
M055G	MSM100930	9 x 30	B	30	9-3/4	5-3/16	2
M055GP6033	MSM100930	9 x 30	B	30	9-3/4	5-3/16	2
M075C010U	MSM100EZ	9 x 30U	C	30	9-3/4	5-3/16	4
M076C010	MSM100930	9 x 30	B	30	9-3/4	5-3/16	2
M076C010U	MSM100EZ	9 x 30U	C	30	9-3/4	5-3/16	3
M076C033	MSM100930	9 x 30	B	30	9-3/4	5-3/16	2
M355C010U	MSM100EZ	9 x 30U	C	30	9-3/4	5-3/16	4
R011C010	MSR100930	9 x 30	B	30	9-3/4	5-3/16	2
R011C010U	MSM100EZ	9 x 30U	C	30	9-3/4	5-3/16	3
R011G	MSR100930	9 x 30	B	30	9-3/4	5-3/16	2
R031C010U	MSM100EZ	9 x 30U	C	30	9-3/4	5-3/16	4
R036C010	MSR100930	9 x 30	B	30	9-3/4	5-3/16	2
R036G	MSR100930	9 x 30	B	30	9-3/4	5-3/16	2
R038C010	MSR100930	9 x 30	B	30	9-3/4	5-3/16	2
R038C010U	MSM100EZ	9 x 30U	C	30	9-3/4	5-3/16	3
R038C033	MSR100930	9 x 30	B	30	9-3/4	5-3/16	2
R038C033U	MSM100EZ	9 x 30U	C	30	9-3/4	5-3/16	3
R038CP4010	MSR100EZ	9 PT	B	30	9-3/4	5-3/16	2
R038CP4033	MSR100EZ	9 PT	B	30	9-3/4	5-3/16	2
R038G	MSR100930	9 x 30	B	30	9-3/4	5-3/16	2
R038GU	MSM100EZ	9 x 30U	C	30	9-3/4	5-3/16	3
R055C010	MSR100930	9 x 30	B	30	9-3/4	5-3/16	2
R055C010U	MSM100EZ	9 x 30U	C	30	9-3/4	5-3/16	3
R055C033	MSR100930	9 x 30	B	30	9-3/4	5-3/16	2
R055C033U	MSM100EZ	9 X 30U	C	30	9-3/4	5-3/16	3
R055G	MSR100930	9 x 30	B	30	9-3/4	5-3/16	2
R075C010U	MSM100EZ	9 x 30U	C	30	9-3/4	5-3/16	4
R076C010	MSR100930	9 x 30	B	30	9-3/4	5-3/16	2
R076C010U	MSM100EZ	9 x 30U	C	30	9-3/4	5-3/16	3
R076C033	MSR100930	9 X 30	B	30	9-3/4	5-3/16	2

¹ Enclosure Styles on page 9-10.

² Knockout Figures on page 9-11.

Technical Data

Model Number	Replacement Parts	Cabinet Size	Enclosure Style ¹	Cabinet Dimensions (inches)			Knockout Figure ²
	Meter Socket			Height (A)	Width (B)	Depth (C)	
U030	—	5 x 7	A	7-1/8	5-3/4	5-3/16	1
U036C010	—	6 x 14	A	14-3/8	6-3/4	5-3/16	1
U036C033	—	6 x 14	A	14-3/8	6-3/4	5-3/16	1
U036G	—	6 x 14	A	14-3/8	6-3/4	5-3/16	1
U038C010	—	9 x 17	A	17-3/8	9-3/4	5-3/16	2
U038C033	—	9 x 17	A	17-3/8	9-3/4	5-3/16	2
U038CTL010	—	9 x 17	A	17-3/8	9-3/4	5-3/16	2
U038CTL033	—	9 x 17	A	17-3/8	9-3/4	5-3/16	2
U038G	—	9 x 17	A	17-3/8	9-3/4	5-3/16	2
U038G033	—	9 x 17	A	17-3/8	9-3/4	5-3/16	2
U039G6	—	9 x 21	D	21	9-3/4	5-3/16	5
U051C	—	6 x 14	A	14-3/8	6-3/4	5-3/16	1
U051C010	—	6 x 14	A	14-3/8	6-3/4	5-3/16	1
U051C033	—	6 x 14	A	14-3/8	6-3/4	5-3/16	1
U051G	—	6 x 14	A	14-3/8	6-3/4	5-3/16	1
U054C	—	6 x 14	A	14-3/8	6-3/4	5-3/16	1
U055C010P	—	6 x 14	A	14-3/8	6-3/4	5-3/16	1
U055C033	—	6 x 14	A	14-3/8	6-3/4	5-3/16	1
U055G	—	6 x 14	A	14-3/8	6-3/4	5-3/16	1
U072C	—	9 x 17	A	17-3/8	9-3/4	5-3/16	2
U073G	—	9 x 17	A	17-3/8	9-3/4	5-3/16	2
U076C010	—	9 x 17	A	17-3/8	9-3/4	5-3/16	2
U076C033	—	9 x 17	A	17-3/8	9-3/4	5-3/16	2
U076G	—	9 x 17	A	17-3/8	9-3/4	5-3/16	2

¹ Enclosure Styles on page 9-10.
² Knockout Figures on page 9-11.

Enclosure Styles / Cabinet Dimensions

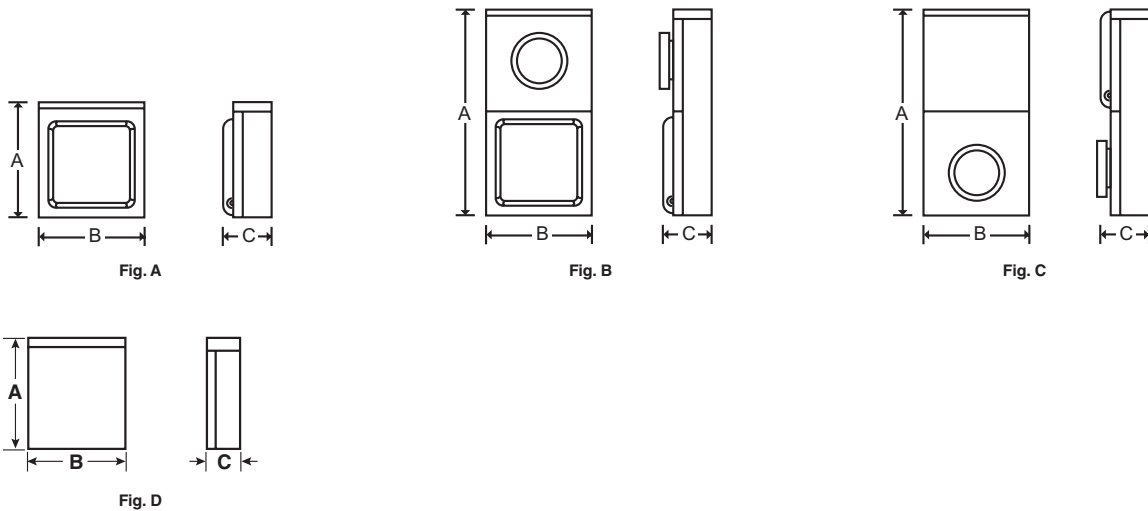

Knockout Configurations

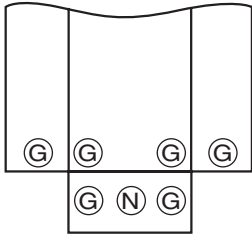

Fig. 1

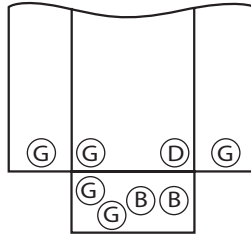

Fig. 2

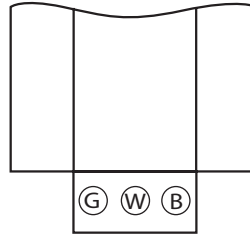

Fig. 3

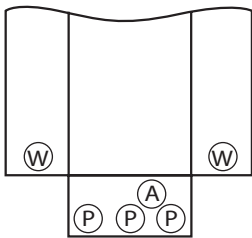

Fig. 4

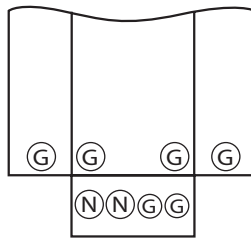

Fig. 5

Knockout Key

- A = 1/2"
- B = 1", 1-1/4", 1-1/2"
- D = 3/4", 1", 1-1/4"
- G = 1/2", 3/4", 1"
- N = 1/2", 3/4", 1", 1-1/4", 1-1/2"
- P = 1/2", 3/4", 1", 1-1/4", 1-1/2", 2", 2-1/2"
- W = 1/2", 3/4", 1", 1-1/4", 2"

* Knockouts shown for size not for exact positions.

Wire Range Tables

AA

Connector	Copper		Aluminum	
	Solid	Strand	Solid	Strand
Line	—	6-1/0	—	6-1/0
Load	14-10	14-10	—	—
Neutral - Large Hole	12-8	12-1/0	10-8	10-1/0
Neutral - Small Hole	14-8	14-4	12-8	12-4
Equipment Ground	12-8	12-2	12-8	12-2

A2

Connector	Copper		Aluminum	
	Solid	Strand	Solid	Strand
Line	—	6-1/0	—	6-1/0
Load	14-10	14-10	—	—
Neutral - Large Hole	12-8	12-1/0	10-8	10-1/0
Neutral - Small Hole	14-8	14-4	12-8	12-4
Equipment Ground	12-8	12-2	12-8	12-2
Post Line Connectors Suitable for Loop Feed	2-250 kcmil		2-250 kcmil	
Equipment Ground	12-2	12-2	12-2	12-2

C

Connector	Copper		Aluminum	
	Solid	Strand	Solid	Strand
Line	—	1-300	—	1-300
Ground - Large Hole	12-8	12-1/0	12-10	10-1/0
Ground - Small Hole	14-8	14-4	12-10	10-1/0
Neutral - Large Hole	14-1/0	14-1/0	14-1/0	14-1/0
Neutral - Small Hole	14-6	14-6	14-6	14-6

G

Connector	Copper	
	Solid	Strand
Line	12-8	12-4
Load	—	—
Neutral	12-8	12-4
Equipment Ground	12-8	12-2

H

Connector	Copper		Aluminum	
	Solid	Strand	Solid	Strand
Line	14-8	14-2	12-8	12-2
Load	14-10	14-10	—	—
Neutral	—	6-350	—	6-350
Neutral	—	1-300	—	1-300
Equipment Ground	12-8	12-2	12-8	12-2

K

Connector	Copper		Aluminum	
	Solid	Strand	Solid	Strand
Line	14-8	14-2	12-8	12-2
Load	14-10	14-10	—	—
Neutral - End Hole	14-8	14-2	12-8	12-2
Neutral - Side Hole	14-8	14-4	12-8	12-4
Equipment Ground	12-8	12-2	12-8	12-2

O

Connector	Copper		Aluminum	
	Solid	Strand	Solid	Strand
Line	14-8	14-2	12-8	12-2
Load	—	—	—	—
Neutral - End Hole	14-8	14-2	12-8	12-2
Neutral - Side Hole	14-8	14-4	12-8	12-4
Equipment Ground	12-8	12-2	12-8	12-2

U

Connector	Copper		Aluminum	
	Solid	Strand	Solid	Strand
Line	14-8	14-1/0	12-8	12-1/0
Load	14-10	14-10	—	—
Neutral - Large Hole	12-8	12-1/0	10-8	10-1/0
Neutral - Small Hole	14-8	14-4	12-8	12-4
Equipment Ground	12-8	12-2	12-8	12-2

V

Connector	Copper		Aluminum	
	Solid	Strand	Solid	Strand
Line	14-8	14-1/0	12-8	12-1/0
Load	—	—	—	—
Neutral - Large Hole	12-8	12-1/0	10-8	10-1/0
Neutral - Small Hole	14-8	14-4	12-8	12-4
Equipment Ground	12-8	12-2	12-8	12-2

X

Connector	Copper		Aluminum	
	Solid	Strand	Solid	Strand
Line	—	6-1/0	—	6-1/0
Load	14-10	14-10	—	—
Neutral	—	6-350	—	6-350
Neutral	—	1-300	—	1-300
Equipment Ground	12-8	12-2	12-8	12-2

Section 10

Power Outlets



Application Information

Portable equipment requiring electricity continues to increase steadily in both number and variety. This creates the need for conveniently located receptacles to provide power for cord connected equipment. Midwest Electric Power Outlets provide one or more receptacles, with or without overcurrent protection, in a single enclosure, eliminating the need for several separately mounted components while providing maximum protection against weather and normal field use. Additionally, many models also include disconnecting, metering, and/or pedestal mounting functions in a single NEMA 3R enclosure/assembly.

Features and Benefits

- NEMA 3R weatherproof construction
- G90 galvanized steel construction for superior corrosion resistance
- Durable polyester powder coat finish resists chipping and fading
- All in one construction for factory assured terminations
- Rolled edge door for cord protection
- Cover design allows cords to exist while maintaining the NEMA 3R integrity
- Wide assortments of concentric knockouts offer flexibility in the installation
- All GFCI duplexes are listed as weather resistant and tamper resistant as required by NEC in Article 406.8 and 406.11
- Padlockable door to help prevent unauthorized access
- Dead front construction prevents accidental contact with live parts
- All components factory wired and assembled



U013



U014C010

Unmetered

Surface, 20 – 30 Amps, 120V

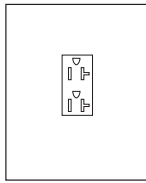

Fig. A
U010
 5-20R2

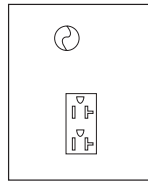

Fig. B
U010F
 5-20R2

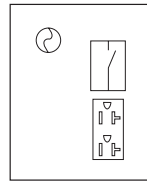

Fig. C
U010H
 5-20R2

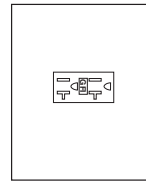

Fig. D
U010SEP
 5-20R2GFCI

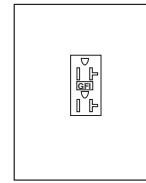

Fig. E
U010010
 5-20R2GFCI

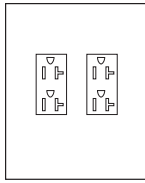

Fig. F
U011
 (2) 5-20R2

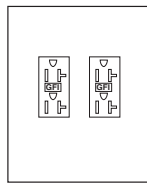

Fig. G
U011010, U012010
 (2) 5-20R2GFCI



Fig. H
U013
 R32U

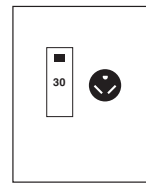

Fig. I
U013C
 R32U

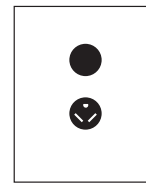

Fig. J
U013F
 R32U

Fig.	Model Number	Receptacles	Circuit Protection	Amps	Wire Range*	Cabinet Size	Hub Opening	Load & Neutral Bar	Unit Wt.	Std Pkg.	UL
A	U010	5-20R2	—	20	E	5 x 7	Y	—	4.5	4	cULus
B	U010F	5-20R2	FH2	20	E	5 x 7		—	4.5		
C	U010H	5-20R2	FH2, SP Switch	20	E	5 x 7		—	5		
D	U010SEP	5-20R2GFCI	—	20	E	5 x 7	N	—	4.5		
E	U010010	5-20R2GFCI	—	20	E	5 x 7	Y	—	4.5		
F	U011	(2) 5-20R2	—	20	E	5 x 7		—	4.5		
G	U011010	(2) 5-20R2GFCI	—	20	E	5 x 7		—	4.5		
G	U012010	(2) 5-20R2GFCI	—	20	E	5 x 7	N	—	4.5		
H	U013	R32U	—	30	F	5 x 7	Y	—	4.5		
I	U013C	R32U	THQL1130	30	A	6 x 9		LC31N3	7		
J	U013F	R32U	FH3	30	F	5 x 7		—	4.5		

* Wire Range Table on pages 10-13–10-14.

Unmetered

Surface, 20 – 50 Amps, 120/240V

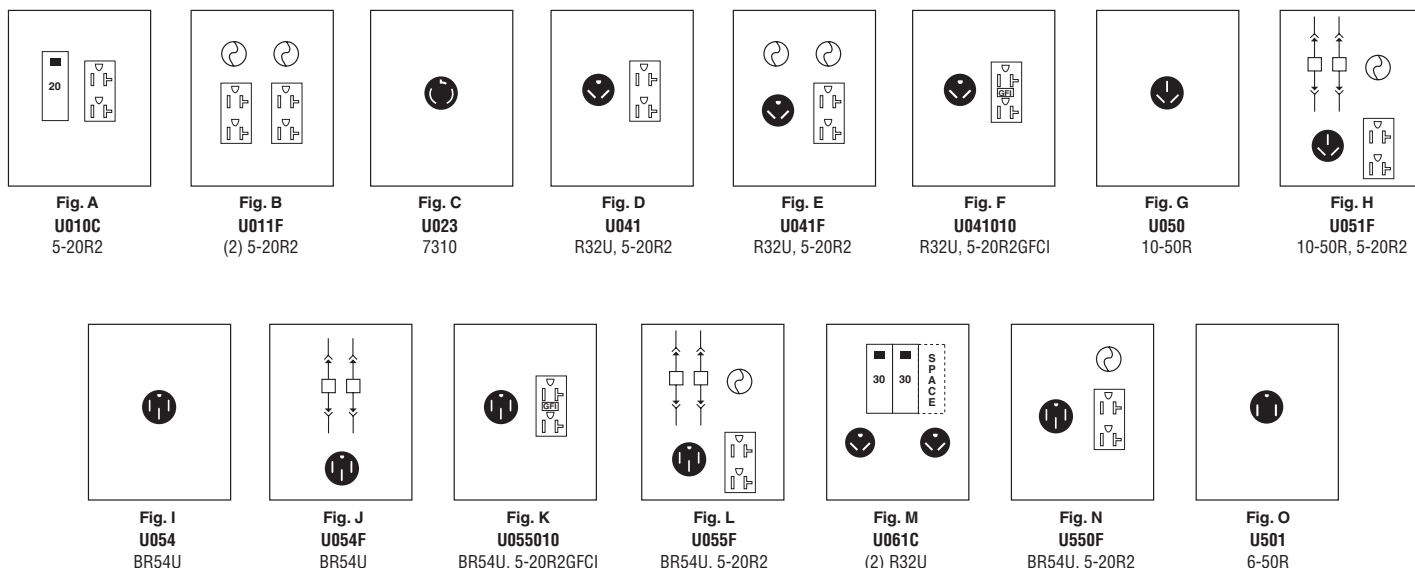

Fig.	Model Number	Receptacles	Circuit Protection	Amps	Wire Range*	Cabinet Size	Hub Opening	Load & Neutral Bar	Unit Wt.	Std Pkg.	UL
A	U010C	5-20R2	THQL1120	20	B	6 x 9	Y	LC31N3	7	4	cUL _{US}
B	U011F	(2) 5-20R2	(2) FH2	20	E	6 x 9		—	9		
C	U023	7310	—	20	F	5 x 7		—	4.5		N
D	U041	R32U, 5-20R2	—	30	E	6 x 9		—	6		cUL _{US}
E	U041F	R32U, 5-20R2	FH3, FH2	30	E	6 x 9		—	7		
F	U041010	R32U, 5-20R2GFCI	—	30	J	6 x 9		—	9		
G	U050	10-50R	—	50	G	5 x 7		—	4.5		N
H	U051F	10-50R, 5-20R2	FH2	50	K	6 x 14		FR66	10		cUL _{US}
I	U054	BR54U	—	50	G	5 x 7		—	5		
J	U054F	BR54U	—	50	O	6 x 14		FR67	10		
K	U055010	BR54U, 5-20R2GFCI	—	50	J	6 x 9		—	9		
L	U055F	BR54U, 5-20R2	—	50	L	6 x 14		FR66, FH2	9		
M	U061C ¹	(2) R32U	(2) THQL1130, Space THQL1120	50	O	6 x 14		LC33N7	10		
N	U550F	BR54U, 5-20R2	FH2	50	M	6 x 14		—	6		

¹ Model number is also suitable for use as temporary site service equipment when installed in accordance with the NEC.

* Wire Range Table on pages 10-13–10-14.

Surface, 50 Amps, 240V

Fig.	Model Number	Receptacles	Circuit Protection	Amps	Wire Range*	Cabinet Size	Hub Opening	Load & Neutral Bar	Unit Wt.	Std Pkg.	UL
O	U501	6-50R	—	50	P	5 x 7	Y	—	5	4	Y

* Wire Range Table on page 10-14.

Unmetered

Surface, 60 – 100 Amps, 120/240V

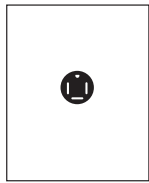

Fig. A
U546
14-60R

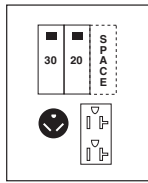

Fig. B
U041C
R32U, 5-20R2

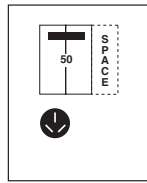

Fig. C
U050C
10-50R

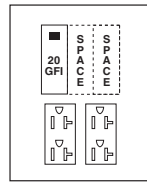

Fig. D
U361G
(2) 5-20R2

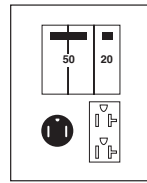

Fig. E
U511C
6-50R, 5-20R2

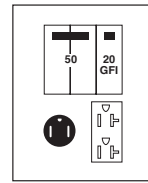

Fig. F
U511G
6-50R, 5-20R2

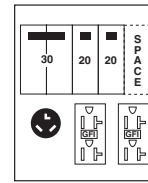

Fig. G
U666C010
10-30R, (2) 5-20R2GFCI

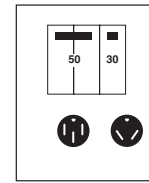

Fig. H
U058C
BR54U, BR32U

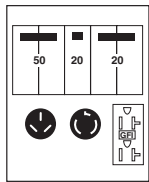

Fig. I
U070C
10-50R, 7310, 5-20R2

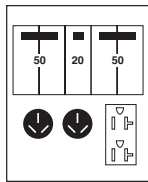

Fig. J
U002C
(2) 10-50R, 5-20R2

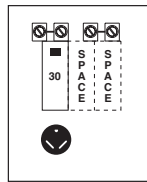

Fig. K
U132CTL
R32U

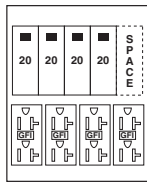

Fig. L
U014C010
(4) 5-20R2GFCI

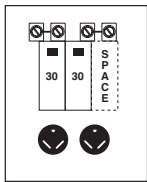

Fig. M
U061CTL
(2) R32U

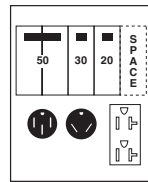

Fig. N
U075C
BR54U, R32U, 5-20R2

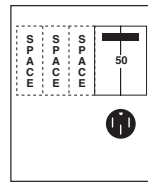

Fig. O
U354C
BR54U

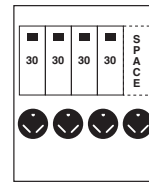

Fig. P
U614C
(2) R32U, (2) BR32U

Fig.	Model Number	Receptacles	Circuit Protection	Amps	Wire Range*	Cabinet Size	Hub Opening	Load & Neutral Bar	Unit Wt.	Std Pkg.	UL
A	U546	14-60R	—	60	G	6 x 9	Y	—	5	4	N
B	U041C	R32U, 5-20R2	THQL1130, THQL1120, Space THQL1120	70	K	6 x 14		LC33N7	10		cULus
C	U050C	10-50R	THQL2150, Space THQL1120	70	O	6 x 14		LC33N7	10		N
D	U361G	(2) 5-20R2	THQL1120GFT	70	K	6 x 14		LC33N7	9		cULus
E	U511C	6-50R, 5-20R2	THQL2150, THQL1120	70	K	6 x 14		LC33N7	10	cULus	
F	U511G	6-50R, 5-20R2	THQL2150, THQL1120GFT	70	K	6 x 14		LC33N7	10	cULus	
G	U666C010	10-30R, (2) 5-20R2GFCI	THQL2130, (2) THQL1120, Space THQL1120	70	U	9 x 17		LC55N1	16	1	N
H	U058C ¹	BR54U, BR32U	THQL2150, THQL1130	80	V	9 x 17		LC33N1	15		cULus
I	U070C	10-50R, 7310, 5-20R2	THQL2150, THQL2120, THQL1120	90	U	9 x 17		LC55N1	16		N
J	U002C	(2) 10-50R, 5-20R2	(2) THQL2150, THQL1120	100	U	14 x 21		LC55N1	31		N
K	U132CTL	R32U	THQL1130, Space (2) THQL1120	100	V	9 x 17		LC33N1T	11		cULus
L	U014C010 ²	(4) 5-20R2GFCI	(4) THQL1120, Space THQL1120	100	U	9 x 17		LC55N1	28		cULus
M	U061CTL	(2) R32U	(2) THQL1130, Space THQL1120	100	O	9 x 17		LC33N1T	14		cULus
N	U075C	BR54U, R32U, 5-20R2	THQL2150, THQL1130, THQL1120, Space THQL1120	100	U	9 x 17		LC55N1	16		cULus
O	U354C	BR54U	THQL2150, Space (3) THQL1120	100	V	9 x 17		LC55N1	16		cULus
P	U614C ¹	(2) R32U, (2) BR32U	(4) THQL1130, Space THQL1120	100	V	14 x 21		LC55N1	30		cULus

¹ Model number is also suitable for use as temporary site service equipment when installed in accordance with the NEC.

² Earth Burial Model U014CP6010.

* Wire Range Table on page 10-14.

Unmetered

Surface, 100 – 200 Amps, 120/240V

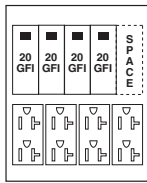

Fig. A
U014GWTR
 (4) 5-20R2GFCI

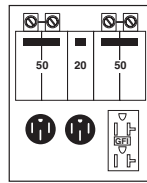

Fig. B
U004CTL010
 (2) BR54U, 5-20R2GFCI

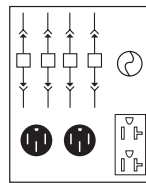

Fig. C
U004F
 (2) BR54U, 5-20R2

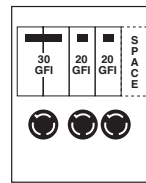

Fig. D
U870G6
 L6-30R, (2) L5-20R

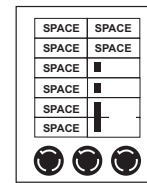

Fig. E
U239G
 L6-30R, (2) L5-20R

Fig.	Model Number	Receptacles	Circuit Protection	Amps	Wire Range*	Cabinet Size	Hub Opening	Load & Neutral Bar	Unit Wt.	Std Pkg.	UL
A	U014GWTR	(4) 5-20R2	(4) THQL1120GFT, Space THQL1120	100	U	9 x 17	Y	LC55N1T	15	1	cULus
B	U004CTL010	(2) BR54U, 5-20R2GFCI	(2) THQL2150, THQL1120	120	U	9 x 17		LC55N1T	17		
C	U004F	(2) BR54U, 5-20R2	FH2	120	U	14 x 21		FR64X2	30		
D	U870G6	L6-30R, (2) L5-20R	THQL2130GFT, (2) THQL1120GFT, Space THQL1120	125	Q	9 x 21		LC1212PC	16		
E	U239G	L6-30R, (2) L5-20R	THQL2130GFT, (2) THQL1120GFT	200	N	14 x 21		LC1212PC	30		

* Wire Range Table on page 10-14.

Metered

Surface, 80 – 100 Amps, 120V/240V

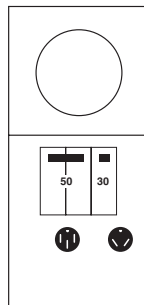

Fig. F
R058C
 BR54U, R32U

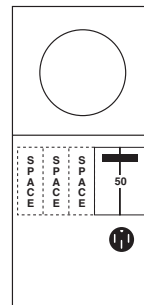

Fig. G
M354C
 BR54U

Fig.	Model Number	Receptacles	Circuit Protection	Amps	Wire Range*	Cabinet Size	Hub Opening	Load & Neutral Bar	Unit Wt.	Std Pkg.	UL
F	R058C ¹	BR54U, R32U	THQL2150, THQL1130	80	AD	9 x 30	Y	LC33N1	25	1	cULus
G	M354C	BR54U	THQL2150, Space (3) THQL1120	100	AD	9 x 30		LC55N1			

¹ Model number is also suitable for use as temporary site service equipment when installed in accordance with the NEC.

* Wire Range Table on page 10-13.

Unmetered

Surface, 20 Amps, 120V

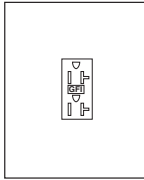

Fig. A
U010010GRP
 5-20R2GFCI

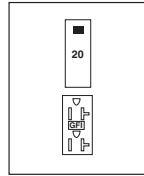

Fig. B
U010C025
 5-20R2GFCI

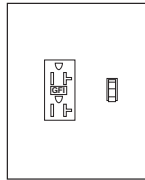

Fig. C
U010S010, U010S010GRP
 5-20R2GFCI, Switch

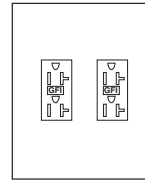

Fig. D
U012010GRP
 (2) 5-20R2GFCI

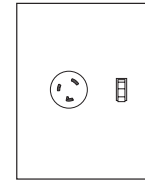

Fig. E
U025S
 L6-20R Twist Lock, Switch

Fig.	Model Number	Receptacles	Number of GFI	Amps	Wire Range*	Cabinet Size	Hub Opening	Enclosure Color	Unit Wt.	Std Pkg.	UL
A	U010010GRP ¹	5-20R2GFCI	1	20	E	5 x 7	N	Camo Green	4	1	cUL ^{us}
B	U010C025	5-20R2GFCI	1	20	BB	6-1/2 x 9	Y		7		
C	U010S010	5-20R2GFCI, Switch	1	20	R	5 x 7	N	Gray	4		
C	U010S010GRP ¹	5-20R2GFCI, Switch	1	20	R	5 x 7	N	Camo Green	3		
D	U012010GRP ¹	(2) 5-20R2GFCI	2	20	J	5 x 7	N	Camo Green	3		

Surface, 20 Amps, 240V

Fig.	Model Number	Receptacles	Number of GFI	Amps	Wire Range*	Cabinet Size	Hub Opening	Enclosure Color	Unit Wt.	Std Pkg.	UL
E	U025S	L6-20R Twist Lock, Switch	—	20	R	5 x 7	N	Gray	4	4	cUL ^{us}

* Wire Range Table on pages 10-13–10-14.

Unmetered

Pedestal, 70 – 80 Amps, 120/240V

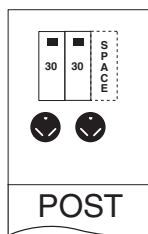

Fig. A
U061CP6
 (2) R32U

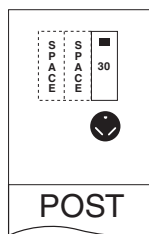

Fig. B
U132CP6
 R32U

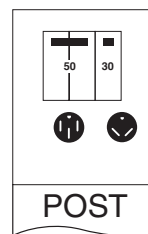

Fig. C
U058CP6
 BR54U, R32U

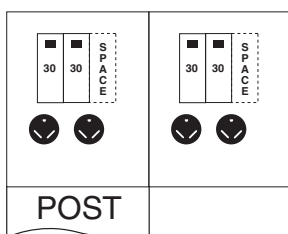

Fig. D
U061CB6
 (2) R32U

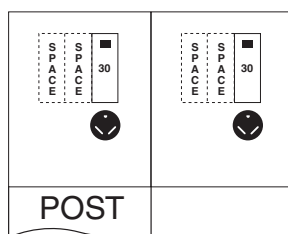

Fig. E
U132CB6
 R32U

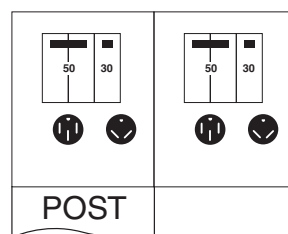

Fig. F
U058CB6
 BR54U, R32U

Fig.	Model Number	Receptacles	Circuit Protection	Amps	Wire Range*	Cabinet Size	Hub Opening	Load & Neutral Bar	Unit Wt.	Std Pkg.	UL
A	U061CP6 ¹	(2) R32U	(2) THQL1130, Space THQL1120	70	AJ	6PT	N	LC33N7	32	1	cULus
B	U132CP6 ¹	R32U	THQL1130, Space (2) THQL1120	70	AH	6PT		LC33N7	48		
C	U058CP6 ¹	BR54U, R32U	THQL2150, THQL1130	80	AG	9PT		LC33N1	20		

Back-to-Back

Fig.	Model Number	Receptacles	Circuit Protection	Amps	Wire Range*	Cabinet Size	Hub Opening	Load & Neutral Bar	Unit Wt.	Std Pkg.	UL
D	U061CB6 ¹	(2) R32U	(2) THQL1130, Space THQL1120	70	AM	6PT	N	LC33N1	46	1	cULus
E	U132CB6 ¹	R32U	THQL1130, Space (2) THQL1120	70	AM	6PT			59		
F	U058CB6	BR54U, R32U	THQL2150, THQL1130	80	AK	9PT			62		

¹ Model number is also suitable for use as temporary site service equipment when installed in accordance with the NEC.

* Wire Range Table on page 10-13.

Metered

Pedestal, 80 – 100 Amps, 120/240V

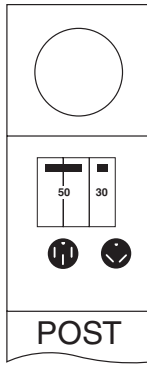

Fig. A
R058CP6
 BR54U, R32U

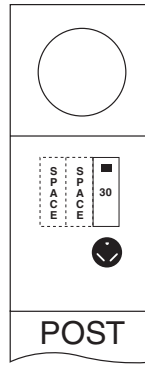

Fig. B
M132CP6
 R32U

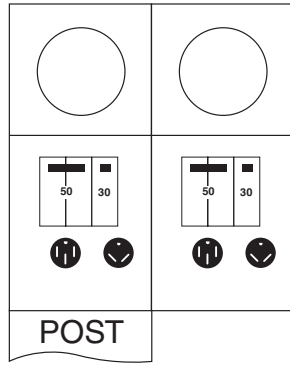

Fig. C
R058CB6
 BR54U, R32U

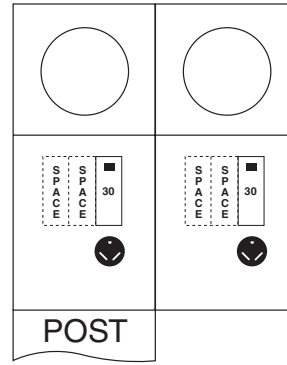

Fig. D
M132CB6
 R32U

Fig.	Model Number	Receptacles	Circuit Protection	Amps	Wire Range*	Cabinet Size	Hub Opening	Load & Neutral Bar	Unit Wt.	Std Pkg.	UL
A	R058CP6 ¹	BR54U, R32U	THQL2150, THQL1130	80	AQ	9PT	N	LC33N1	59	1	UL _{us}
B	M132CP6 ¹	R32U	THQL1130, Space (2) THQL1120	100					56		

Back-to-Back

Fig.	Model Number	Receptacles	Circuit Protection	Amps	Wire Range*	Cabinet Size	Hub Opening	Load & Neutral Bar	Unit Wt.	Std Pkg.	UL
C	R058CB6 ¹	BR54U, R32U	THQL2150, THQL1130	80	AT	9PT	N	LC33N1	82	1	UL _{us}
D	M132CB6 ¹	R32U	THQL1130, Space (2) THQL1120	100	AU						

¹ Model number is also suitable for use as temporary site service equipment when installed in accordance with the NEC.
 * Wire Range Table on page 10-13.

Technical Data

Model Number	Replacement Parts		Cabinet Size	Enclosure Style ¹	Cabinet Dimensions (inches)			Knockout Figure ²
	Meter Socket	Post Lugs			Height (A)	Width (B)	Depth (C)	
M132CB6	MSM100P9	LT100B350	9PT	See page 10-12				
M132CP6	MSM100P9	LT100S350	9PT	See page 10-12				
M354C	—	—	9 x 30	B	30	9-3/4	5-3/16	6
R058C	MSR100930	—	9 x 30	B	30	9-3/4	5-3/16	2
R058CB6	MSR100P9	LT100B350	9PT	See page 10-12				
R058CP6	MSR100P9	LT100S350	9PT	See page 10-12				
U002C	—	—	9 x 17	A	17-3/8	9-3/4	5-3/16	2
U004F	—	—	14 x 21	A	21-3/8	14-3/4	6-7/16	3
U004CTL010	—	—	9 x 17	A	17-3/8	9-3/4	5-3/16	2
U010	—	—	5 x 7	A	7-1/8	5-3/4	5-3/16	4
U010010	—	—	5 x 7	A	7-1/8	5-3/4	5-3/16	4
U010010GRP	—	—	5 x 7	A	7-1/8	5-3/4	5-3/16	4
U010C	—	—	6 x 9	A	9-1/8	7-1/4	5-3/16	1
U010C025	—	—	6-1/2 x 9	A	9-1/8	7-1/4	5-3/16	1
U010F	—	—	5 x 7	A	7-1/8	5-3/4	5-3/16	4
U010H	—	—	5 x 7	A	7-1/8	5-3/4	5-3/16	4
U010SEP	—	—	5 x 7	A	7	5-3/10	5	4
U010S010	—	—	5 x 7	A	7-1/8	5-3/4	5-3/16	4
U010S010GRP	—	—	5 x 7	A	7-1/8	5-3/4	5-3/16	4
U011	—	—	5 x 7	A	7-1/8	5-3/4	5-3/16	4
U011010	—	—	5 x 7	A	7-1/8	5-3/4	5-3/16	4
U011F	—	—	6 x 9	A	9-1/8	7-1/4	5-3/16	1
U012010	—	—	5 x 7	A	7-1/8	5-3/4	5-3/16	4
U012010GRP	—	—	5 x 7	A	7-1/8	5-3/4	5-3/16	4
U013	—	—	5 x 7	A	7-1/8	5-3/4	5-3/16	4
U013C	—	—	6 x 9	A	9-1/8	7-1/4	5-3/16	1
U013F	—	—	5 x 7	A	7-1/8	5-3/4	5-3/16	4
U014C010	—	—	9 x 17	A	17	9-1/2	5-1/5	2
U014CP6010	—	LT100S350	9PT	See page 10-12				
U014GWTR	—	—	9 x 17	A	17	9-1/2	5-1/5	2
U023	—	—	5 x 7	A	7-1/8	5-3/4	5-3/16	4
U025S	—	—	5 x 7	A	7-1/8	5-3/4	5-3/16	4
U041	—	—	6 x 9	A	9-1/8	7-1/4	5-3/16	1
U041010	—	—	6 x 9	A	9-1/8	7-1/4	5-3/16	1
U041C	—	—	6 x 14	A	14-3/8	7-1/4	5-3/16	1
U041F	—	—	6 x 9	A	9-1/8	7-1/4	5-3/16	1
U050	—	—	5 x 7	A	7-1/8	5-3/4	5-3/16	4
U050C	—	—	6 x 14	A	14-3/8	7-1/4	5-3/16	1
U051F	—	—	6 x 14	A	14-3/8	7-1/4	5-3/16	1
U054	—	—	5 x 7	A	7-1/8	5-3/4	5-3/16	4
U054F	—	—	6 x 14	A	14-3/8	7-1/4	5-3/16	1
U055010	—	—	6 X 9	A	9-1/8	7-1/4	5-3/16	1
U055F	—	—	6 x 14	A	14-3/8	7-1/4	5-3/16	1
U058C	—	—	9 x 17	A	17-3/8	9-1/4	5-3/16	2
U058CB6	—	LT100B350	9PT	See page 10-12				
U058CP6	—	LT100S350	9PT	See page 10-12				
U061C	—	—	6 x 14	A	14-3/8	7-1/4	5-3/16	1
U061CB6	—	LT100B350	6PT	See page 10-12				
U061CP6	—	LT100S350	6PT	See page 10-12				
U061CTL	—	—	9 x 17	A	17-3/8	9-3/4	5-3/16	2
U070C	—	—	9 x 17	A	17-3/8	9-3/4	5-3/16	2
U075C	—	—	9 x 17	A	17-3/8	9-3/4	5-3/16	2
U132CB6	—	LT100B350	6PT	See page 10-12				
U132CP6	—	LT100S350	6PT	See page 10-12				
U132CTL	—	—	9 x 17	A	17-3/8	9-1/4	5-3/16	2

¹ Enclosure Styles on page 10-11.

² Knockout Figures on page 10-11.

Data subject to change without notice.

Technical Data

Power Outlets

Model Number	Replacement Parts		Cabinet Size	Enclosure Style ¹	Cabinet Dimensions (inches)			Knockout Figure ²
	Meter Socket	Post Lugs			Height (A)	Width (B)	Depth (C)	
U239G	—	—	14 x 21	A	21-3/8	14-1/4	6-7/16	3
U354C	—	—	9 x 17	A	17-3/8	9-3/4	5-3/16	2
U361G	—	—	6 x 14	A	14-3/8	7-1/4	5-3/16	1
U501	—	—	5 x 7	A	7-1/8	5-3/4	5-3/16	4
U511C	—	—	6 x 14	A	14-3/8	7-1/4	5-3/16	1
U511G	—	—	6 x 14	A	14-3/8	7-1/4	5-3/16	1
U546	—	—	6 x 9	A	9-1/8	7-1/4	5-3/16	1
U550F	—	—	6 x 14	A	14-3/8	7-1/4	5-3/16	1
U614C	—	—	14 x 21	A	21-3/8	14-3/4	6-7/16	3
U666C010	—	—	9 x 17	A	17-3/8	9-3/4	5-3/16	2
U870G6	—	—	9 x 21	A	21-5/8	9-1/2	4-3/4	5

¹ Enclosure Styles see below.
² Knockout Figures see below.

Enclosure Styles / Cabinet Dimensions

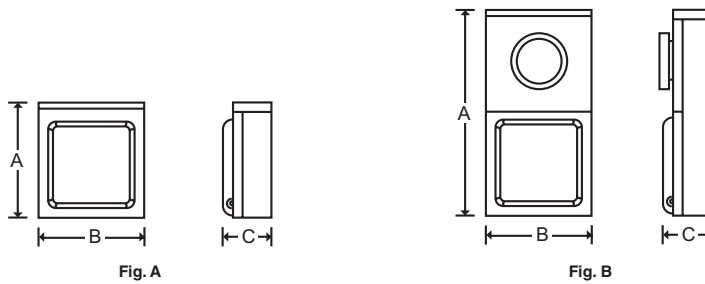

Knockout Configurations

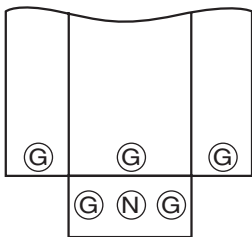

Fig. 1

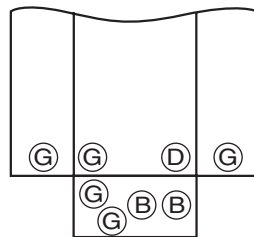

Fig. 2

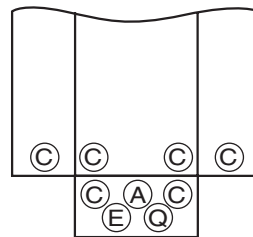

Fig. 3

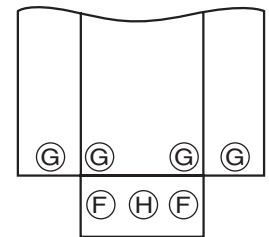

Fig. 4

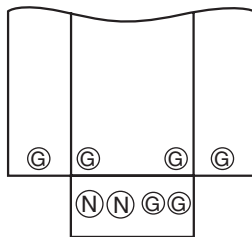

Fig. 5

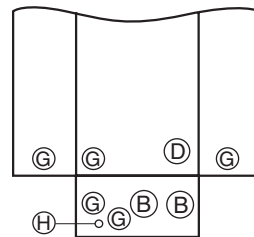

Fig. 6

Knockout Key

- A = 1-1/2", 2", 2-1/2"
- B = 1", 1-1/4", 1-1/2"
- C = 1-1/4", 1-1/2", 2"
- D = 3/4", 1", 1-1/4"
- E = 3/4"
- F = 1/2", 3/4"
- G = 1/2", 3/4", 1"
- H = 1/2", 3/4", 1", 1-1/4"
- N = 1/2", 3/4", 1", 1-1/4", 1-1/2"
- Q = 1"

* Knockouts shown for size not for exact positions.

Data subject to change without notice.

Post Dimensions

Earth Burial

6PT

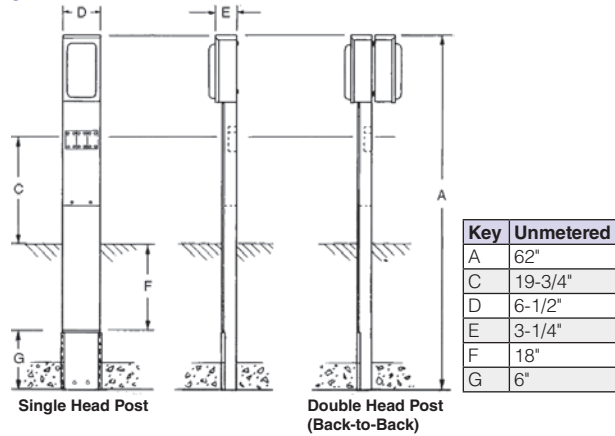

Pad Mount

6PT

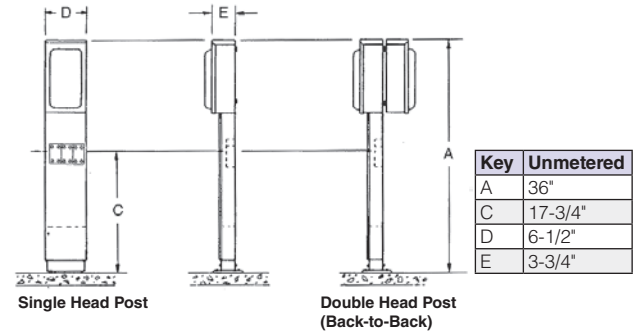

9PT

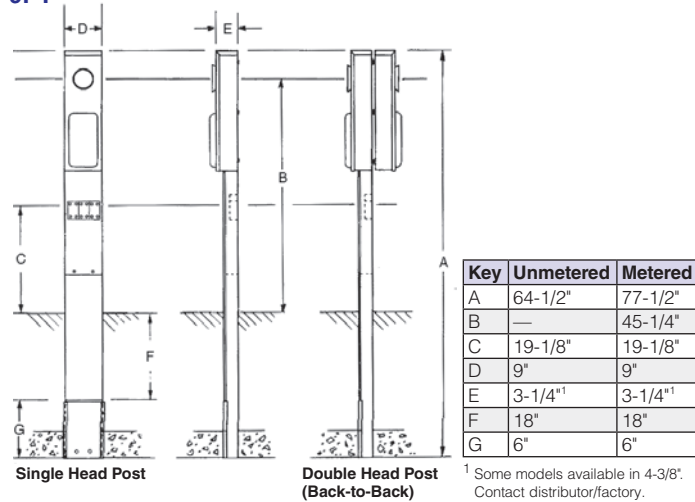

9PT

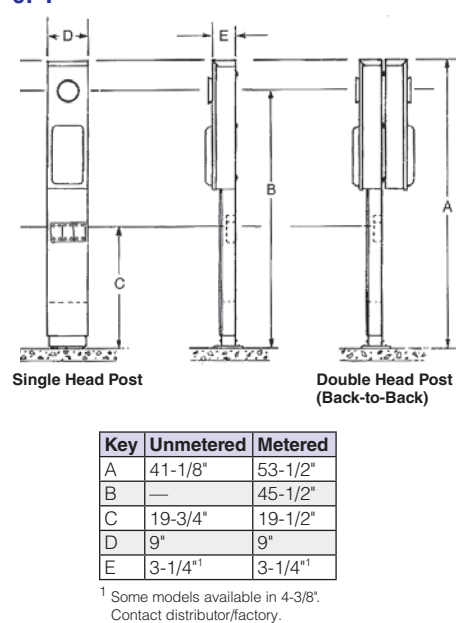

14PT

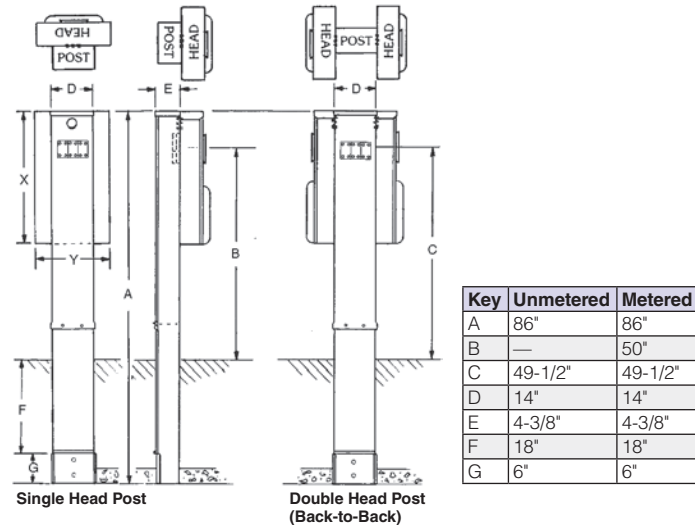

Dimensions Key

- A = Post Length
- B = Meter Center to Grade
- C = Terminal Bar to Grade
- D = Post Width
- E = Post Depth
- F = Grade to Wire Opening
- G = Wire Opening

Wire Range Tables

A

Connector	Copper		Aluminum	
	Solid	Strand	Solid	Strand
Line	14-8	14-6	12-8	12-6
Load	—	—	—	—
Neutral	12-8	12-6	12-8	12-6
Equipment Ground	12-8	12-2	12-8	12-2

AD

Connector	Copper		Aluminum	
	Solid	Strand	Solid	Strand
Line	—	6-1/0	—	6-1/0
Load	—	—	—	—
Neutral - Large Hole	12-8	12-1/0	10-8	10-1/0
Neutral - Small Hole	14-8	14-4	12-8	12-4
Equipment Ground	12-8	12-2	12-8	12-2

AG

Connector	Copper		Aluminum	
	Solid	Strand	Solid	Strand
Line	14-8	14-1/0	12-8	12-1/0
Load	—	—	—	—
Neutral	14-4	14-4	14-4	14-4
Equipment Ground- Distribution	12-8	12-2	12-8	12-2
Post Line Connectors - Loop Feed	1-300 kcmil		1-300 kcmil	
Equipment Ground- Pedestal	12-2	12-2	12-2	12-2

AH

Connector	Copper		Aluminum	
	Solid	Strand	Solid	Strand
Line	14-8	14-2	12-8	12-2
Load	—	—	—	—
Neutral	14-4	14-4	14-4	14-4
Equipment Ground- Distribution	12-8	12-2	12-8	12-2
Post Line Connectors - Loop Feed	1-300 kcmil		1-300 kcmil	
Equipment Ground- Pedestal	12-2	12-2	12-2	12-2

AJ

Connector	Copper		Aluminum	
	Solid	Strand	Solid	Strand
Line	14-8	14-2	12-8	12-2
Load	—	—	—	—
Neutral - End Hole	14-8	14-2	12-8	12-2
Neutral - Side Hole	14-8	14-4	12-8	12-4
Equipment Ground- Distribution	12-8	12-2	12-8	12-2
Post Line Connectors - Loop Feed	14-1/0		14-1/0	
Equipment Ground- Pedestal	12-2	12-2	12-2	12-2

AK

Connector	Copper		Aluminum	
	Solid	Strand	Solid	Strand
Line	14-8	14-1/0	12-8	12-1/0
Load	—	—	—	—
Neutral	12-8	12-1/0	10-8	10-1/0
Neutral	14-8	14-4	12-8	12-4
Equipment Ground- Distribution	12-8	12-2	12-8	12-2
Post Line Connectors - Loop Feed	6-350 kcmil		6-350 kcmil	
Equipment Ground- Pedestal	12-2	12-2	12-2	12-2

AM

Connector	Copper		Aluminum	
	Solid	Strand	Solid	Strand
Line	14-8	14-2	12-8	12-2
Load	—	—	—	—
Neutral - End Hole	14-8	14-2	12-8	12-2
Neutral - Side Hole	14-8	14-4	12-8	12-4
Equipment Ground- Distribution	12-8	12-2	12-8	12-2
Post Line Connectors - Loop Feed	2-250 kcmil		2-250 kcmil	
Equipment Ground- Pedestal	12-2	12-2	12-2	12-2

AQ

Connector	Copper		Aluminum	
	Solid	Strand	Solid	Strand
Line	—	6-1/0	—	6-1/0
Load	—	—	—	—
Neutral	14-4	14-4	14-4	14-4
Equipment Ground- Distribution	12-8	12-2	12-8	12-2
Post Line Connectors - Loop Feed	1-300 kcmil		1-300 kcmil	
Equipment Ground- Pedestal	12-2	12-2	12-2	12-2

AT

Connector	Copper		Aluminum	
	Solid	Strand	Solid	Strand
Line	—	6-1/0	—	6-1/0
Load	—	—	—	—
Neutral	12-8	12-1/0	10-8	10-1/0
Neutral	14-8	14-4	12-8	12-4
Equipment Ground- Distribution	12-8	12-2	12-8	12-2
Post Line Connectors - Loop Feed	6-350 kcmil		6-350 kcmil	
Equipment Ground- Pedestal	12-2	12-2	12-2	12-2

AU

Connector	Copper		Aluminum	
	Solid	Strand	Solid	Strand
Line	—	6-1/0	—	6-1/0
Load	—	—	—	—
Neutral	12-8	12-1/0	10-8	10-1/0
Neutral	14-8	14-4	12-8	12-4
Equipment Ground- Distribution	12-8	12-2	12-8	12-2
Post Line Connectors - Loop Feed	2-250 kcmil		2-250 kcmil	
Equipment Ground- Pedestal	12-2	12-2	12-2	12-2

B

Connector	Copper		Aluminum	
	Solid	Strand	Solid	Strand
Line	14-8	14-6	12-8	12-6
Load	14-10	14-10	—	—
Neutral	12-8	12-6	12-8	12-6
Equipment Ground	12-8	12-2	12-8	12-2

E

Connector	Copper	
	Solid	Strand
Line	14-10	14-10
Load	14-10	14-10
Neutral	14-10	14-10
Equipment Ground	12-8	12-2

Wire Range Tables

F

Connector	Copper	
	Solid	Strand
Line	14-10	14-10
Load	—	—
Neutral	14-10	14-10
Equipment Ground	12-8	12-2

G

Connector	Copper	
	Solid	Strand
Line	12-8	12-4
Load	—	—
Neutral	12-8	12-4
Equipment Ground	12-8	12-2

J

Connector	Copper		Aluminum	
	Solid	Strand	Solid	Strand
Line	14-10	14-10	—	—
Load	14-10	14-10	—	—
Neutral	14-10	14-10	—	—
Equipment Ground	12-8	12-2	12-8	12-2

K

Connector	Copper		Aluminum	
	Solid	Strand	Solid	Strand
Line	14-8	14-2	12-8	12-2
Load	14-10	14-10	—	—
Neutral - End Hole	14-8	14-2	12-8	12-2
Neutral - Side Hole	14-8	14-4	12-8	12-4
Equipment Ground	12-8	12-2	12-8	12-2

L

Connector	Copper		Aluminum	
	Solid	Strand	Solid	Strand
Line	14-8	14-3	12-8	12-3
Load	14-10	14-10	—	—
Neutral - End Hole	14-8	14-2	12-8	12-2
Neutral - Side Hole	14-8	14-4	12-8	12-4
Equipment Ground	12-8	12-2	12-8	12-2

M

Connector	Copper	
	Solid	Strand
Line	12-8	12-4
Load	14-10	14-10
Neutral	12-8	12-4
Equipment Ground	12-8	12-2
Line - FH2 Fuseholder	14-10	14-10
Neutral	14-10	14-10

N

Connector	Copper		Aluminum	
	Solid	Strand	Solid	Strand
Line - Meter Socket	—	1-300	—	—
Load - Base Lugs	—	—	—	—
Neutral - Large Single Lug	—	1-300	—	1-300
Neutral - Small Single Lug	14-8	14-1/0	12-8	12-1/0
Neutral - Large Hole	14-8	10-4	—	6-4
Neutral - Small Hole	14-8	12-8	12-8	12-8
Equipment Ground - Large Hole	12-8	12-1/0	12-1/0	10-1/0
Equipment Ground - Small Hole	14-8	14-4	12-10	12-4

O

Connector	Copper		Aluminum	
	Solid	Strand	Solid	Strand
Line	14-8	14-2	12-8	12-2
Load	—	—	—	—
Neutral - End Hole	14-8	14-2	12-8	12-2
Neutral - Side Hole	14-8	14-4	12-8	12-4
Equipment Ground	12-8	12-2	12-8	12-2

P

Connector	Copper	
	Solid	Strand
Line	12-8	12-4
Load	—	—
Neutral	—	—
Equipment Ground	12-8	12-2

Q

Connector	Copper	
	Solid	Strand
Line	14-8	14-1/0
Load	14-10	14-10
Neutral - Large Hole	12-8	12-1/0
Neutral - Small Hole	14-8	14-4
Equipment Ground	12-8	12-2

R

Connector	Copper		Aluminum	
	Solid	Strand	Solid	Strand
Line - Switch	14-10	14-10	—	—
Equipment Ground	12-8	12-2	12-8	12-2
Line - Receptacle	14-10	14-10	—	—
Load - Receptacle	14-10	14-10	—	—
Neutral - Receptacle	14-10	14-10	—	—

U

Connector	Copper		Aluminum	
	Solid	Strand	Solid	Strand
Line	14-8	14-1/0	12-8	12-1/0
Load	14-10	14-10	—	—
Neutral - Large Hole	12-8	12-1/0	10-8	10-1/0
Neutral - Small Hole	14-8	14-4	12-8	12-4
Equipment Ground	12-8	12-2	12-8	12-2

V

Connector	Copper		Aluminum	
	Solid	Strand	Solid	Strand
Line	14-8	14-1/0	12-8	12-1/0
Load	—	—	—	—
Neutral - Large Hole	12-8	12-1/0	10-8	10-1/0
Neutral - Small Hole	14-8	14-4	12-8	12-4
Equipment Ground	12-8	12-2	12-8	12-2

Section 11

RV Park Equipment



RV Park Equipment

Successful camp ground owners provide their campers with the amenities that keep them coming back year after year: fun, recreation, relaxation, clean and well maintained facilities, friendly staff, and last but not least, hassle free RV hookups! That's where Midwest Electric Products comes in. Midwest offers a complete line of RV power outlets designed with both the camper and the campground owner in mind.

Camper Safety

- Designed and tested to stringent UL safety standards
- Personal protection against ground faults is accomplished via GFCI circuit breaker or receptacle (your choice)
- Duplex outlets are weather resistant and tamper resistant
- In-use covers and grade panels prevent cord and incoming cable abrasion
- Painted dead front panel separates the camper from all electrical wiring
- Power units and access panels can be padlocked to prevent unauthorized access/use

Customer Convenience

- RV power outlets are offered with a wide range of receptacle and circuit breaker combinations
- Power heads provide stay-open, in-use cover
- Convenience features include: light, TV, cable and water connections

Installation and Maintenance

- Installation and maintenance ease, durability, and aesthetics
- Factory wired circuit breakers and receptacles
- Surface mounted power heads have ample concentric knockouts
- Pedestal models are equipped with factory installed loop feed lugs to accommodate down-stream power outlets
- All mechanical lugs are rated for copper and aluminum wire, including the factory installed equipment ground lug
- G90 galvanized steel which provides superior corrosion protection and years of trouble free maintenance
- Durable, fade resistant, polyester powder coat paint finish that is baked on for extra protection

If you're a long-time Midwest RV power outlet customer, thank you for your continued business (many of our repeat customers have been buying from Midwest for over thirty years). If you're new to Midwest, welcome. We'll do our best to make you a believer in all Midwest Electric Products.



Metallic RV

ParkMate™



Application Information

Midwest Metallic RV power centers are a cost effective favorite among campground owners seeking to offer the essential amenities to their campers while keeping their upfront and lifetime costs to a minimum. All components are factory assembled and wired to reduce installation time. The power centers are manufactured using heavy gauge galvanized steel that are top-coated with a durable power coat finish for years of maintenance free operation. These dependable power centers are available in either single-sided or double-sided construction and have a variety of circuit protection, receptacles and convenience options available. Mounting options include surface mount, pad mount, or earth burial post. This versatility gives campground owners the features that their campers expect.



Features and Benefits

Rugged Durability

- Rolled edge door for cord protection
- All-in-one construction for factory assured terminations
- G90 galvanized steel construction for superior corrosion and fading resistance
- Welded flange NEMA 3R construction for lasting service in outdoor installations
- 10kAIC

Installation Ease

- All components factory wired and assembled, reducing installation time
- Door has stay open position for user convenience
- All terminals accept copper or aluminum wire for added installation flexibility
- Wide range of receptacle configurations
- Broad range of concentric knockouts to accommodate varied wiring needs
- Post door removable for installation ease

User Safety

- Dead front construction prevents accidental contact with live parts
- Padlock provision to prevent unauthorized access
- GFCI weather and tamper resistant GFI receptacles
- Rolled edge post bottoms to protect incoming service cable



Unmetered

Surface, 20 Amps, 120V

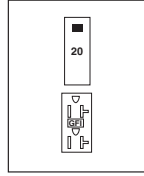

Fig. A
U010C010,
 5-20R2GFCI

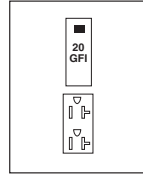

Fig. B
U010G
 5-20R2

Fig.	Model Number	Receptacles	Circuit Protection	Amps	Lug Type	Wire Range*	Cabinet Size	Hub Opening	Load & Neutral Bar	Unit Wt.	Std Pkg.	UL
A	U010C010	5-20R2GFCI	THQL1120	20	Standard	B	6 x 9	Y	—	7	4	Y ¹
B	U010G	5-20R2	THQL1120GFT	20	Standard	B	6 x 9	Y	—	7	4	Y ¹

¹ cULus approved.
 * Wire Range Table on page 11-27.

Surface, 70 – 80 Amps, 120/240V

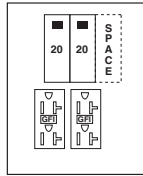

Fig. C
U011C010
 (2) 5-20R2GFCI

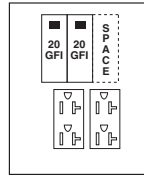

Fig. D
U011G
 (2) 5-20R2

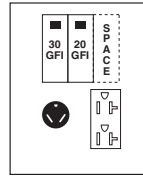

Fig. E
U040G
 R32U, 5-20R2

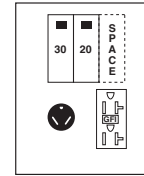

Fig. F
U041C010P
 R32U, 5-20R2GFCI

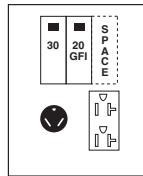

Fig. G
U041G
 R32U, 5-20R2

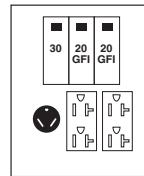

Fig. H
U412G
 BR32U, (2) 5-20R2

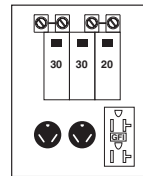

Fig. I
U611CTL010
 (2) BR32U, 5-20R2GFCI

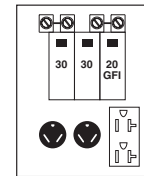

Fig. J
U611GTL
 (2) BR32U, 5-20R2

Fig.	Model Number	Receptacles	Circuit Protection	Amps	Lug Type	Wire Range*	Cabinet Size	Hub Opening	Load & Neutral Bar	Unit Wt.	Std Pkg.	UL
C	U011C010	(2) 5-20R2GFCI	(2) THQL1120, Space THQL1120	70	Standard	P	6 x 14	Y	LC33N7	10	4	Y ¹
D	U011G	(2) 5-20R2	(2) THQL1120GFT, Space THQL1120	70	Standard	P	6 x 14		LC33N7	10	4	
E	U040G	R32U, 5-20R2	THQL1130GFT, THQL1120GFT, Space THQL1120	70	Standard	P	6 x 14		LC33N7	10	4	
F	U041C010P	R32U, 5-20R2GFCI	THQL1130, THQL1120, Space THQL1120	70	Standard	P	6 x 14		LC33N7	10	4	
G	U041G	R32U, 5-20R2	THQL1130, THQL1120GFT, Space THQL1120	70	Standard	P	6 x 14		LC33N7	10	4	
I	U412G	BR32U, (2) 5-20R2	THQL1130, (2) THQL1120GFT	70	Standard	U	9 x 17		LC33N1	16	1	
J	U611CTL010	(2) BR32U, 5-20R2GFCI	(2) THQL1130, THQL1120	80	Loop Feed	W	9 x 17		LC33N1T	16	1	
K	U611GTL	(2) BR32U, 5-20R2	(2) THQL1130, THQL1120GFT	80	Loop Feed	W	9 x 17		LC33N1T	15	1	

¹ cULus approved.
 * Wire Range Table on page 11-27-11-28.

Unmetered

Surface, 100 – 125 Amps, 120/240V

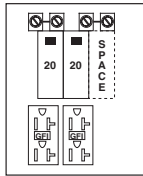

Fig. A
U011CTL010
(2) 5-20R2GFCI

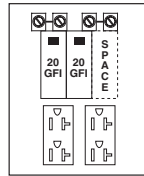

Fig. B
U011GTL
(2) 5-20R2

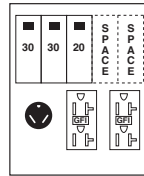

Fig. C
U031C010
R32U, (2) 5-20R2GFCI

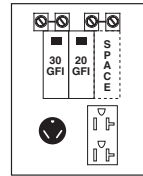

Fig. D
U040GTL
R32U, 5-20R2

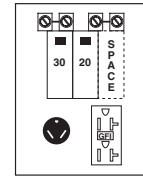

Fig. E
U041CTL010
R32U, 5-20R2GFCI

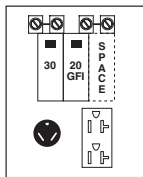

Fig. F
U041GTL
BR32U, 5-20R2

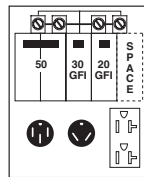

Fig. G
U074GTL
BR54U, R32U, 5-20R2

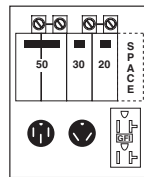

Fig. H
U075CTL010
BR54U, R32U, 5-20R2GFCI

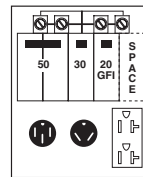

Fig. I
U075GTL
BR54U, R32U, 5-20R2

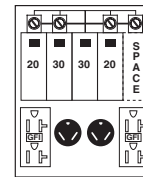

Fig. J
U131CTL010
(2) BR32U, (2) 5-20R2GFCI

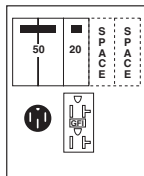

Fig. K
U355C010
BR54U, 5-20R2GFCI

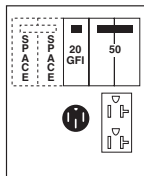

Fig. L
U355G
BR54U, 5-20R2

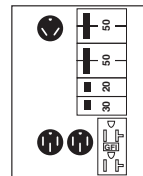

Fig. M
U775C010
(2) 14-50R, BR32U, 5-20R2GFCI

Fig.	Model Number	Receptacles	Circuit Protection	Amps	Lug Type	Wire Range*	Cabinet Size	Hub Opening	Load & Neutral Bar	Unit Wt.	Std Pkg.	UL
A	U011CTL010	(2) 5-20R2GFCI	(2) THQL1120, Space THQL1120	100	Loop Feed	W	9 x 17		LC33N1T	14		Y ¹
B	U011GTL	(2) 5-20R2	(2) THQL1120GFT, Space THQL1120	100	Loop Feed	W	9 x 17		LC33N1T	14		
C	U031C010	R32U, (2) 5-20R2GFCI	THQL1130, (2) THQL1120, Space (2) THQL1120	100	Standard	AA	9 x 17		LC55N1	16		
D	U040GTL	R32U, 5-20R2	THQL1130GFT, THQL1120GFT, Space THQL1120	100	Loop Feed	W	9 x 17		LC33N1T	14		
E	U041CTL010	R32U, 5-20R2GFCI	THQL1130, THQL1120, Space THQL1120	100	Loop Feed	W	9 x 17		LC33N1T	14		
F	U041GTL	BR32U, 5-20R2	THQL1130, THQL1120GFT, Space THQL1120	100	Loop Feed	W	9 x 17		LC33N1T	14		Y
G	U074GTL	BR54U, R32U, 5-20R2	THQL2150, THQL1130GFT, THQL1120GFT, Space THQL1120	100	Loop Feed	W	9 x 17	Y	LC55N1T	16	1	
H	U075CTL010	BR54U, R32U, 5-20R2GFCI	THQL2150, THQL1130, THQL1120, Space THQL1120	100	Loop Feed	W	9 x 17		LC55N1T	16		
I	U075GTL	BR54U, R32U, 5-20R2	THQL2150, THQL1130, THQL1120GFT, Space THQL1120	100	Loop Feed	W	9 x 17		LC55N1T	16		Y ¹
J	U131CTL010	(2) BR32U, (2) 5-20R2GFCI	(2) THQL1130, (2) THQL1120, Space THQL1120	100	Loop Feed	U	14 x 21		LC55N1T	28		
K	U355C010	BR54U, 5-20R2GFCI	THQL2150, THQL1120, (2) Spaces 100A Max	100	Standard	U	9 x 17		LC55N1	16		
L	U355G	BR54U, 5-20R2	THQL2150, THQL1120GFT, (2) Spaces 100A Max	100	Standard	U	9 x 17		LC55N1	15		
M	U775C010	(2) 14-50R, BR32U, 5-20R2GFCI	(2) THQL2150T, THQL1130, THQP120	125	Standard	W	9 x 17		—	15		

¹ cULus approved.

* Wire Range Table on page 11-27-11-28.

Metered

Surface, 70 – 120 Amps, 120/240V

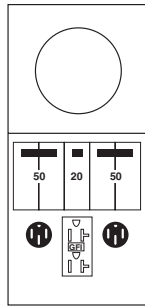

Fig. A
M004C010
(2) BR54U, 5-20R2GFCI

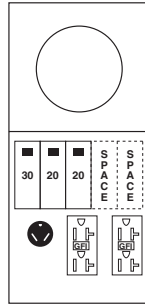

Fig. B
M031C010, R031C010
R32U, (2) 5-20R2GFCI

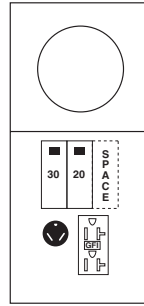

Fig. C
M041C010, R041C010
BR32U, 5-20R2GFCI

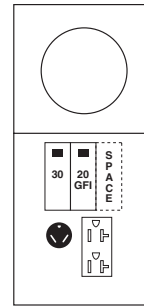

Fig. D
M041G, R041G
BR32U, 5-20R2

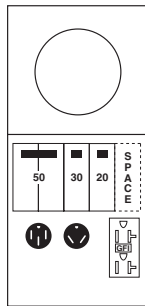

Fig. E
M075C010, R075C010
BR54U, BR32U, 5-20R2GFCI

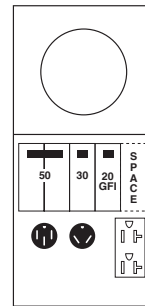

Fig. F
M075G
BR54U, BR32U, 5-20R2

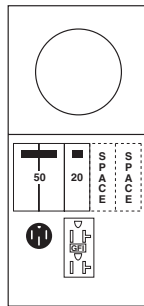

Fig. G
M355C010
BR54U, 5-20R2GFCI

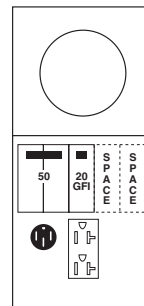

Fig. H
M355G, R355G
BR54U, 5-20R2

Fig.	Model Number		Receptacles	Circuit Protection	Amps	Wire Range*	Cabinet Size	Hub Opening	Load & Neutral Bar	Unit Wt.	Std Pkg.	UL
	Ring Type	Ringless										
A	M004C010	—	(2) BR54U, 5-20R2GFCI	(2) THQL2150, THQL1120	100	AA	9 x 30	Y	LC55N1	26	1	Y ¹
B	M031C010	R031C010	R32U, (2) 5-20R2GFCI	THQL1130, (2) THQL1120, (2) SPACE THQL1120	100				LC55N1	25		
C	M041C010	R041C010	BR32U, 5-20R2GFCI	THQL1130, THQL1120, Space THQL1120	100				LC33N1	24		
D	M041G	R041G	BR32U, 5-20R2	THQL1130, THQL1120GFT, Space THQL1120	100				LC33N1	25		
E	M075C010	R075C010	BR54U, BR32U, 5-20R2GFCI	THQL2150, THQL1130, THQL1120, Space THQL1120	100				LC55N1	25		
F	M075G	—	BR54U, BR32U, 5-20R2	THQL2150, THQL1130, THQL1120GFT, Space THQL1120	100				LC55N1	25		
G	M355C010	—	BR54U, 5-20R2GFCI	THQL2150, THQL1120, (2) Space THQL1120	100				LC55N1	25		
H	M355G	R355G	BR54U, 5-20R2	THQL2150, THQL1120GFT, (2) Space THQL1120	100				LC55N1	25		

¹ cULus approved.

* Wire Range Table on page 11-27.

Unmetered

Pedestal, 30 Amps, 120V

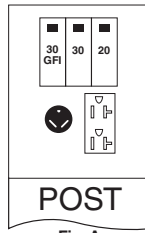

Fig. A
U042GP6
R32U, 5-20R2

Fig.	Model Number		Receptacles	Circuit Protection	Amps	Wire Range*	Cabinet Size	Hub Opening	Load & Neutral Bar	Unit Wt.	Std Pkg.	UL
	Earth Burial	Pad Mount										
A	U042GP6	—	R32U, 5-20R2	THQL1130GFT Main, THQL1130, THQL1120	30	Z	6PT	N	LC33N7	32	1	Y ¹

¹ cULus approved.

* Wire Range Table on page 11-28.

Pedestal, 70 Amps, 120/240V

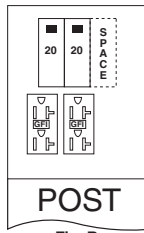

Fig. B
U011CP6010, U011CP4010
(2) 5-20R2GFCI

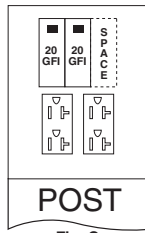

Fig. C
U011GP6, U011GP4
(2) 5-20R2

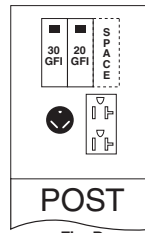

Fig. D
U040GP6, U040GP4
R32U, 5-20R2

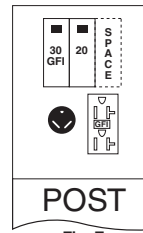

Fig. E
U040GP6010
R32U, 5-20R2GFCI

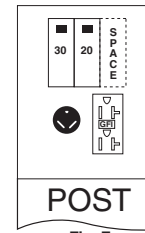

Fig. F
U041CP6010, U041CP4010
R32U, 5-20R2GFCI

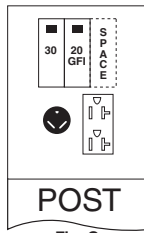

Fig. G
U041GP6, U041GP4
R32U, 5-20R2

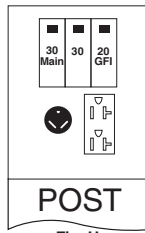

Fig. H
U043GP6
R32U, 5-20R2

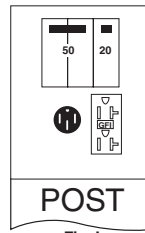

Fig. I
U055CP6010, U055CP4010
BR54U, 5-20R2GFCI

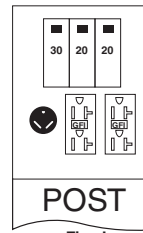

Fig. J
U412CP6010
BR32U, (2) 5-20R2GFCI

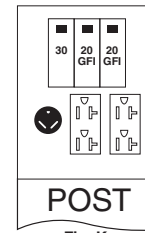

Fig. K
U412GP6
BR32U, (2) 5-20R2

Fig.	Model Number		Receptacles	Circuit Protection	Amps	Wire Range*	Cabinet Size	Hub Opening	Load & Neutral Bar	Unit Wt.	Std Pkg.	UL
	Earth Burial	Pad Mount										
B	U011CP6010	U011CP4010	(2) 5-20R2GFCI	(2) THQL1120, Space THQL1120	70	Z	6PT	N	LC33N7	32	1	Y ¹
C	U011GP6	U011GP4	(2) 5-20R2	(2) THQL1120GFT, Space THQL1120			6PT					
D	U040GP6	U040GP4	R32U, 5-20R2	THQL1130GFT, THQL1120GFT, Space THQL1120			9PT					
E	U040GP6010	—	R32U, 5-20R2GFCI	THQL1130GFT, THQL1120, Space THQL1120			9PT					
F	U041CP6010 ²	U041CP4010 ²	R32U, 5-20R2GFCI	THQL1130, THQL1120, Space THQL1120			6PT					
G	U041GP6	U041GP4	R32U, 5-20R2	THQL1130, THQL1120GFT, Space THQL1120			6PT					
H	U043GP6	—	R32U, 5-20R2	THQL1130, THQL1120GFT, THQL1130 Main			6PT					
I	U055CP6010	U055CP4010	BR54U, 5-20R2GFCI	THQL2150, THQL1120			6PT					
J	U412CP6010	—	BR32U, (2) 5-20R2GFCI	THQL1130, (2) THQL1120			9PT					
K	U412GP6	—	BR32U, (2) 5-20R2	THQL1130, (2) THQL1120GFT			9PT					

¹ cULus approved.

² Available with factory installed TV/Telephone – U041CP6031, U041CP4031. See pages 11-23–11-24 for TV/Telephone model diagrams.

* Wire Range Table on page 11-28.

Data subject to change without notice.

Unmetered

Pedestal, 80 – 125 Amps, 120/240V

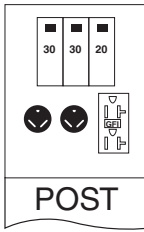

Fig. A
U611CP6010, U611CP4010
(2) BR32U, 5-20R2GFCI

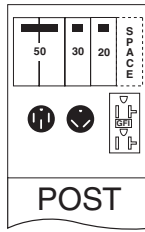

Fig. B
U075CP6010, U075CP4010
BR54U, BR32U, 5-20R2GFCI

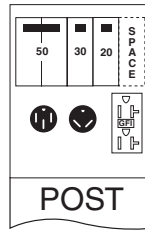

Fig. C
U075CP6010D
BR54U, BR32U, 5-20R2GFCI

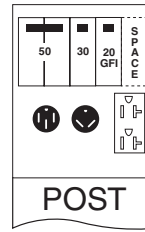

Fig. D
U075GP6, U075GP4
BR54U, BR32U, 5-20R2

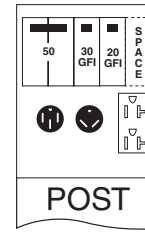

Fig. E
U075GP6019
BR54U, BR32U, 5-20R2

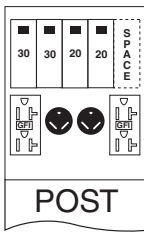

Fig. F
U131CP6010
(2) BR32U, (2) 5-20R2GFCI

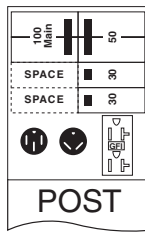

Fig. G
U175CP6HP010
BR54U, BR32U, 5-20R2GFCI

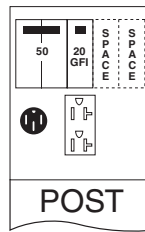

Fig. H
U355GP6
BR54U, 5-20R2

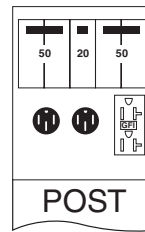

Fig. I
U004CP6010, U004CP4010
(2) BR54U, 5-20R2GFCI

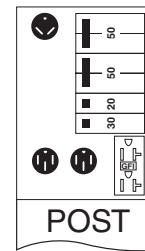

Fig. J
U775CP6010, U775CP4010
(2) 14-50R, BR32U, 5-20R2GFCI

Fig.	Model Number		Receptacles	Circuit Protection	Amps	Wire Range*	Cabinet Size	Hub Opening	Load & Neutral Bar	Unit Wt.	Std Pkg.	UL
	Earth Burial	Pad Mount										
A	U611CP6010	U611CP4010	(2) BR32U, 5-20R2GFCI	(2) THQL1130, THQL1120	80	Z	9PT	N	LC33N1	47	1	Y ¹
B	U075CP6010 ^{2,3,4}	U075CP4010 ^{2,3}	BR54U, BR32U, 5-20R2GFCI	THQL2150, THQL1130, THQL1120, Space THQL1120	100	X	9PT		LC55N1	47		
C	U075CP6010D ⁵	—	BR54U, BR32U, 5-20R2GFCI	THQL2150, THQL1130, THQL1120, Space THQL1120	100	X	9PT		LC55N1	47		
D	U075GP6 ⁷	U075GP4	BR54U, BR32U, 5-20R2	THQL2150, THQL1130, THQL1120GFT	100	Z	9PT		LC55N1	47		
E	U075GP6019	—	BR54U, BR32U, 5-20R2	THQL2150, THQL1130GFT, THQL1120GFT	100	Z	9PT		LC55N1	47		
F	U131CP6010	—	(2) BR32U, (2) 5-20R2GFCI	(2) THQL1130, (2) THQL1120, Space THQL1120	100	Z	14PT		LC55N1	47		
G	U175CP6HP010	—	BR54U, BR32U, 5-20R2GFCI	THQP250 Main, THQL2150, THQL1130, THQL1120	100	W	14PT		198B8627G14	89		
H	U355GP6	—	BR54U, 5-20R2	THQL2150, THQL1120GFT, (2) Space 100A Max	100	Z	9PT		LC55N1	47		
I	U004CP6010 ⁶	U004CP4010 ²	(2) BR54U, 5-20R2GFCI	(2) THQL2150, THQL1120	120	Z	9PT		LC55N1	47		
J	U775CP6010	U775CP4010	(2) 14-50R, BR32U, 5-20R2GFCI	(2) THQP250, THQL1130, THQP120	125	Z	9PT		265A6250G34	97		

¹ cULus approved.

² Available with factory installed TV/Telephone – U075CP6031, U075CP4031, U004CP4031.

See pages 11-23–11-24 for TV/Telephone model diagrams.

³ Available in bronze paint – U075CP6010BZ, U075CP4010Z1.

⁴ Available in tan paint – U075CP6010T.

⁵ Post depth dimension is non-standard (4-3/8”).

⁶ Available with light and GFCI receptacles – U004CP6L10.

⁷ Available with CU conductors – U075GP6C.

* Wire Range Table on page 11-28.

Unmetered

Pedestal, Earth Burial, 125 Amps, 120/208V

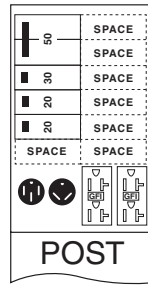

Fig. A
5S3S2S2SES
 BR54U, BR32U, (2) 5-20R2GFCI

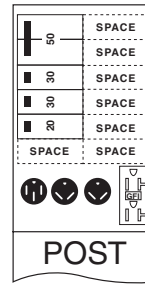

Fig. B
5S3S3S2SES
 BR54U, (2) BR32U, 5-20R2GFCI

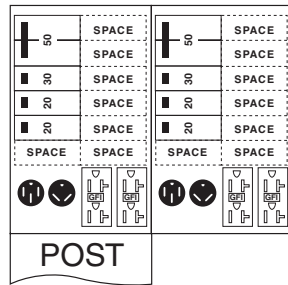

Fig. C
5S3S2S2SEB
 BR54U, BR32U, (2) 5-20R2GFCI

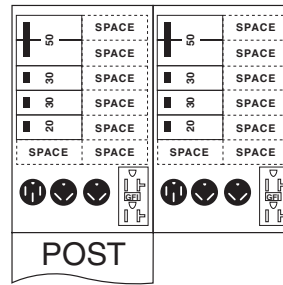

Fig. D
5S3S3S2SEB
 BR54U, (2) BR32U, 5-20R2GFCI

3-Phase

Fig.	Model Number	Receptacles	Circuit Protection	Sides	Amps	Wire Range*	Cabinet Size	Hub Opening	Load & Neutral Bar	Unit Wt.	Std Pkg.	UL
A	5S3S2S2SES	BR54U, BR32U, (2) 5-20R2GFCI	THQL2150, THQL1130, (2) THQL1120	1	125	6-350 kcmil ²	14PT	N	3-Phase, 4 Wire	—	1	Y ¹
B	5S3S3S2SES	BR54U, (2) BR32U, 5-20R2GFCI	THQL2150, (2) THQL1130, THQL1120									

3-Phase, Back-to-Back

Fig.	Model Number	Receptacles	Circuit Protection	Sides	Amps	Wire Range*	Cabinet Size	Hub Opening	Load & Neutral Bar	Unit Wt.	Std Pkg.	UL
C	5S3S2S2SEB	BR54U, BR32U, (2) 5-20R2GFCI	THQL2150, THQL1130, (2) THQL1120	2	125	6-350 kcmil ²	14PT	N	3-Phase, 4 Wire	—	1	Y ¹
D	5S3S3S2SEB	BR54U, (2) BR32U, 5-20R2GFCI	THQL2150, (2) THQL1130, THQL1120									

¹ cULus approved.

² Loop Lugs – Line/Neutral/Ground.

* Wire Range Table on page 11-27.

RV Equip – Metallic

Unmetered

Pedestal, Back-to-Back, 30 Amps, 120V

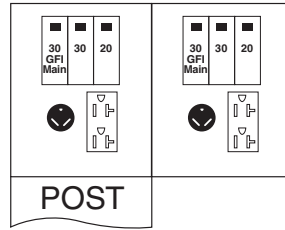

Fig. A
U042GB
R32U, 5-20R2

Fig.	Model Number		Receptacles	Circuit Protection	Amps	Wire Range*	Cabinet Size	Hub Opening	Load & Neutral Bar	Unit Wt.	Std Pkg.	UL
	Earth Burial	Pad Mount										
A	U042GB6	—	R32U, 5-20R2	THQL1130GFT Main, (2) THQL1120	30	Z	6PT	N	LC33N7	47	1	Y ¹

* Wire Range Table on page 11-28.

Pedestal, Back-to-Back, 70 Amps, 120/240V

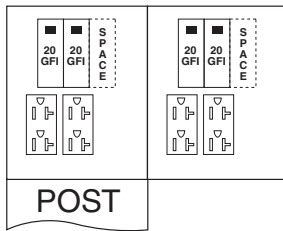

Fig. B
U011GB6, U011GB4
(2) 5-20R2

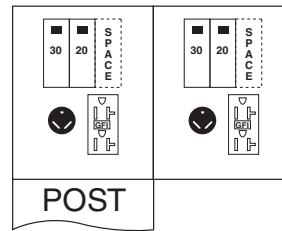

Fig. C
U041CB6010, U041CB4010
R32U, 5-20R2GFCI

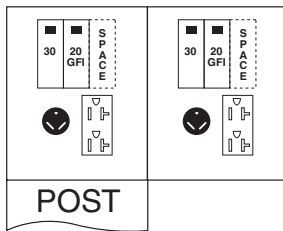

Fig. D
U041GB6, U041GB4
R32U, 5-20R2

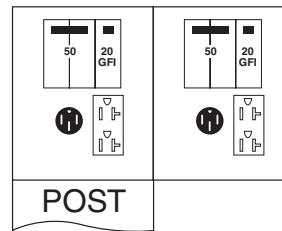

Fig. E
U055GB6
BR54U, 5-20R2

Fig.	Model Number		Receptacles	Circuit Protection	Amps	Wire Range*	Cabinet Size	Hub Opening	Load & Neutral Bar	Unit Wt.	Std Pkg.	UL
	Earth Burial	Pad Mount										
B	U011GB6	U011GB4	(2) 5-20R2	(2) THQL1120GFT, Space THQL1120	70	Z	6PT	N	LC33N7	47	1	Y ¹
C	U041CB6010	U041CB4010	R32U, 5-20R2GFCI	THQL1130, THQL1120, Space THQL1120								
D	U041GB6	U041GB4	R32U, 5-20R2	THQL1130, THQL1120GFT, Space THQL1120								
E	U055GB6	—	BR54U, 5-20R2	THQL2150, THQL1120GFT								

¹ cULus approved.

* Wire Range Table on page 11-28.

Unmetered

Pedestal, Back-to-Back, 80 – 120 Amps, 120/240V

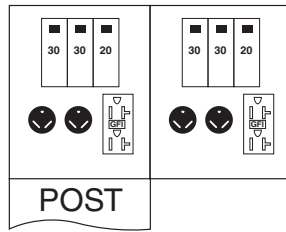

Fig. A

U611CB6010, U611CB4010
(2) R32U, 5-20R2GFCI

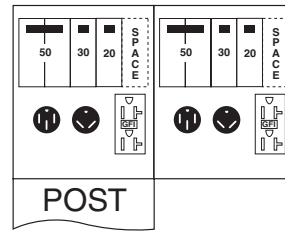

Fig. B

U075CB6010, U075CB4010
BR54U, R32U, 5-20R2GFCI

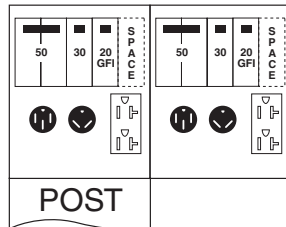

Fig. C

U075GB6
BR54U, R32U, 5-20R2

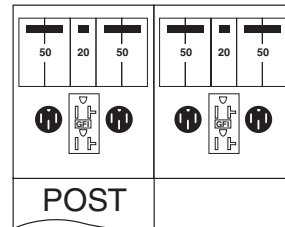

Fig. D

U004CB6010, U004CB4010
(2) BR54U, 5-20R2GFCI

Fig.	Model Number		Receptacles	Circuit Protection	Amps	Wire Range*	Cabinet Size	Hub Opening	Load & Neutral Bar	Unit Wt.	Std Pkg.	UL
	Earth Burial	Pad Mount										
A	U611CB6010	U611CB4010	(2) R32U, 5-20R2GFCI	(2) THQL1130, THQL1120	80	Z	9PT	N	LC33N1	62	1	Y ¹
B	U075CB6010 ²	U075CB4010 ²	BR54U, R32U, 5-20R2GFCI	THQL2150, THQL1130, THQL1120, Space THQL1120	100	S	9PT		LC55N1			
C	U075GB6	—	BR54U, R32U, 5-20R2	THQL2150, THQL1130, THQL1120GFT, Space THQL1120	100	S	9PT		LC55N1			
D	U004CB6010	U004CB4010	(2) BR54U, 5-20R2GFCI	(2) THQL2150, THQL1120	120	S	9PT		LC55N1			

¹ cULus approved.

² Available with factory installed TV/Telephone – U075CB6031, U075CB4031. See pages 11-23–11-24 for TV/Telephone model diagrams.

* Wire Range Table on page 11-27–11-28.

RV Equip – Metallic

Metered

Pedestal, Earth Burial, 70 – 100 Amps, 120/240V

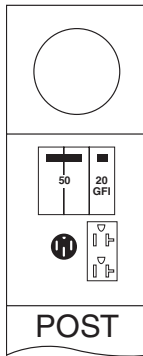

Fig. A
M055GP6
BR54U, 5-20R2

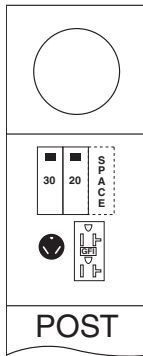

Fig. B
M041CP6010, R041CP6010
R32U, 5-20R2GFCI

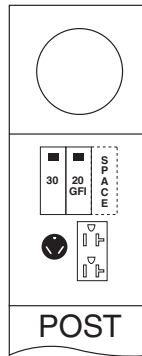

Fig. C
M041GP6, R041GP6
R32U, 5-20R2

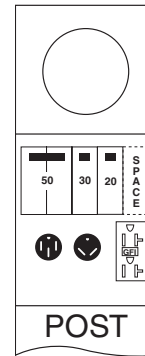

Fig. D
M075CP6010, R075CP6010,
R075CP6010FMG
BR54U, R32U, 5-20R2GFCI

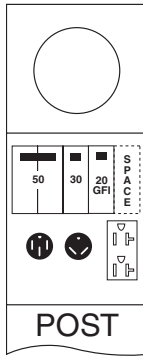

Fig. E
M075GP6, R075GP6
BR54U, R32U, 5-20R2

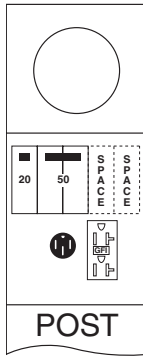

Fig. F
M355CP6010, R355CP6010
BR54U, 5-20R2GFCI

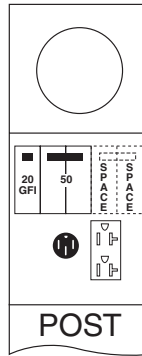

Fig. G
M355GP6, R355GP6
BR54U, 5-20R2

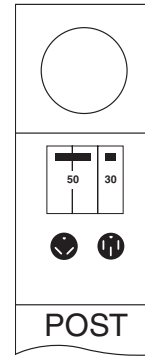

Fig. H
M358CP6
BR54U, R32U

Fig.	Model Number		Receptacles	Circuit Protection	Amps	Wire Range*	Cabinet Size	Hub Opening	Load & Neutral Bar	Unit Wt.	Std Pkg.	UL
	Ring Type	Ringless										
A	M055GP6	—	BR54U, 5-20R2	THQL2150, THQL1120GFT	70	Z	9PT	N	LC33N1	59	1	UL
B	M041CP6010	R041CP6010	R32U, 5-20R2GFCI	THQL1130, THQL1120, Space THQL1120	100	Z		N	LC33N1	53		
C	M041GP6	R041GP6	R32U, 5-20R2	THQL1130, THQL1120GFT, Space THQL1120	100	Z		N	LC33N1	59		
D	M075CP6010 ^{1,2}	R075CP6010, ^{1,3} R075CP6010FMG	BR54U, R32U, 5-20R2GFCI	THQL2150, THQL1130, THQL1120, Space THQL1120	100	Y		N	LC55N1	59	UL, MEG	
E	M075GP6	R075GP6	BR54U, R32U, 5-20R2	THQL1120GFT, Space THQL1120	100	Z		N	LC55N1	59		
F	M355CP6010	R355CP6010 ²	BR54U, 5-20R2GFCI	THQL2150, THQL1120, (2) Space THQL1120	100	Z		Y	LC55N1	59	UL	
G	M355GP6	R355GP6	BR54U, 5-20R2	THQL2150, THQL1120GFT, (2) Space THQL1120	100	Z		N	LC55N1	59		
H	M358CP6	—	BR54U, R32U	THQL2150, THQL1130	100	Z		N	LC55N1	53		

¹ Available with factory installed TV/Telephone – M075CP6031, R075CP6031, R355CP6031. See pages 11-23–11-24 for TV/Telephone model diagrams.

² Available in camo green – M075CP6010GR.

³ Available in bronze finish – R075CP6010Z1.

* Wire Range Table on page 11-28.

Metered

Pedestal, Earth Burial, 120 – 200 Amps, 120/240V

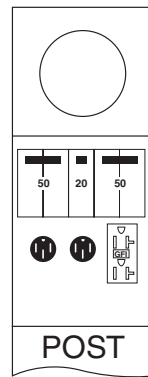

Fig. A
M004CP6010
(2) BR54U, 5-20R2GFCI

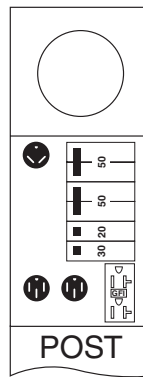

Fig. B
M775CP6010
(2) BR54U, BR32U, 5-20R2GFCI

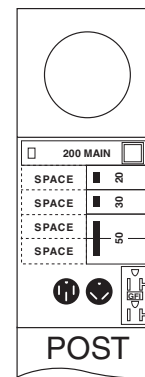

Fig. C
M275CP6010
BR54U, BR32U, 5-20R2GFCI

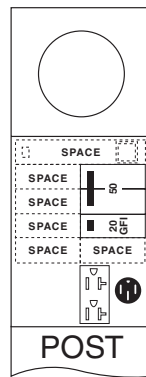

Fig. D
M655GP6
BR54U, 5-20R2

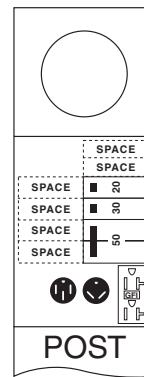

Fig. E
M675CP6010
BR54U, BR32U, 5-20R2GFCI

Fig.	Model Number		Receptacles	Circuit Protection	Amps	Wire Range*	Cabinet Size	Hub Opening	Load & Neutral Bar	Unit Wt.	Std Pkg.	UL
	Ring Type	Ringless										
A	M004CP6010	—	(2) BR54U, 5-20R2GFCI	(2) THQL2150, THQL1120	100	Z	9PT	N	LC55N1	48		
B	M775CP6010	—	(2) BR54U, BR32U, 5-20R2GFCI	(2) THQP250, THQL1130, THQP120	125	Z	9PT	N	—	59		
C	M275CP6010 ²	—	BR54U, BR32U, 5-20R2GFCI	TQDL or equivalent Main, THQL2150, THQL1130, THQL1120	200	BX	14PT	N	LC1212PC	89	1	Y ¹
D	M655GP6	—	BR54U, 5-20R2	THQL2150, THQL1120GFT, Space TQDL or equivalent, Space (5) THQL1120 200A Max	200	Z	14PT	N	LC1212PC	85		
E	M675CP6010	—	BR54U, BR32U, 5-20R2GFCI	THQL2150, THQL1130, THQL1120	200	BY	14PT	N	LC1212PC	87		

¹ cULus approved.

² Available in green paint – order as M275CP6010G1.

* Wire Range Table on page 11-27–11-28.

RV Equip – Metallic

Metered

Pedestal, Earth Burial, Back-to-Back, 100 – 200 Amps, 120/240V

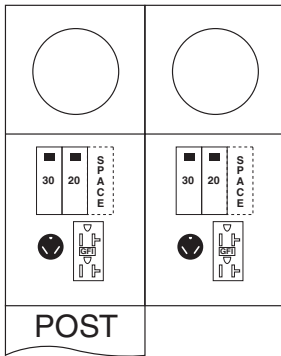

Fig. A
M041CB6010
 R32U, 5-20R2GFCI

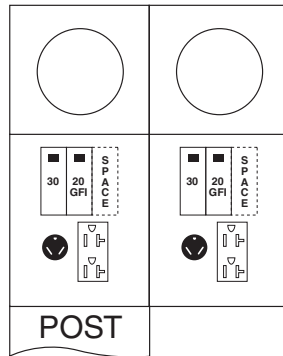

Fig. B
M041GB6, R041GB6
 R32U, 5-20R2

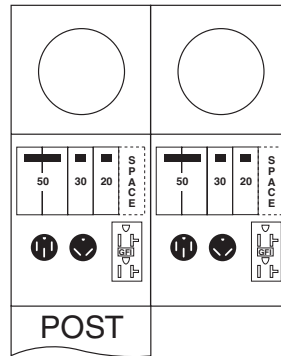

Fig. C
M075CB6010, R075CB6010, R075CB6010FMG
 BR54U, R32U, 5-20R2GFCI

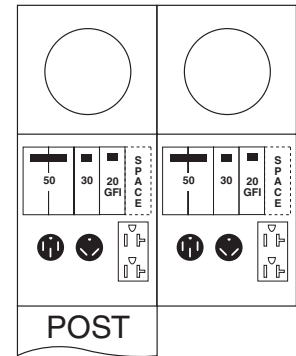

Fig. D
M075GB6, R075GB6
 BR54U, R32U, 5-20R2

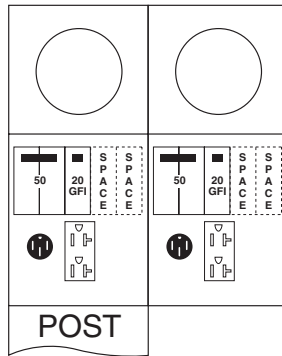

Fig. E
M355GB6
 BR54U, 5-20R2

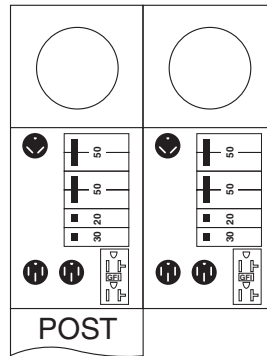

Fig. F
M775CB6010
 (2) BR54U, BR32U, 5-20R2GFCI

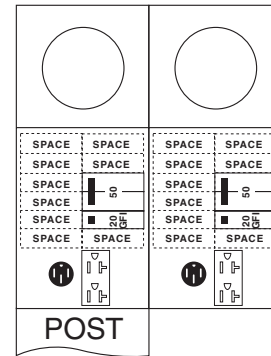

Fig. G
M655GB6
 BR54U, 5-20R2

Fig.	Model Number		Receptacles	Circuit Protection	Amps	Wire Range*	Cabinet Size	Hub Opening	Load & Neutral Bar	Unit Wt.	Std Pkg.	UL
	Ring Type	Ringless										
A	M041CB6010	—	R32U, 5-20R2GFCI	THQL1130, THQL1120, Space THQL1120	100	S	9PT	N	LC33N1	82	1	UL US
B	M041GB6	R041GB6	R32U, 5-20R2	THQL1130, THQL1120GFT, Space THQL1120	100		9PT	N	LC33N1	82		
C	M075CB6010 ¹	R075CB6010, R075CB6010FMG	BR54U, R32U, 5-20R2GFCI	THQL2150, THQL1130, THQL1120, Space THQL1120	100		9PT	N	LC55N1	82	1	UL, MEG
D	M075GB6	R075GB6	BR54U, R32U, 5-20R2	THQL2150, THQL1130, THQL1120GFT, Space THQL1120	100		9PT	N	LC55N1	82		
E	M355GB6	—	BR54U, 5-20R2	THQL2150, THQL1120GFT, (2) Space THQP250	100		9PT	N	LC55N1	82	1	UL US
F	M775CB6010	—	(2) BR54U, BR32U, 5-20R2GFCI	(2) THQP250, THQL1130, THQP120	125		9PT	N	—	82		
G	M655GB6	—	BR54U, 5-20R2	THQL2150, THQL1120GFT, (9) Space THQL1120	200		14PT	N	LC12122PC, N1200A4	80		

¹ Available with factory installed TV/Telephone – M075CB6031. See pages 11-23-11-24 for TV/Telephone model diagrams.
 * Wire Range Table on page 11-27.

RV Equip – Metallic

Metered

Pedestal, Pad Mount, 100 Amps, 120/240V

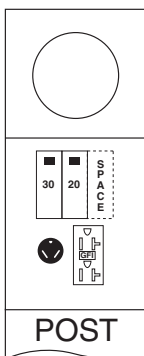

Fig. A
M041CP4010
R32U, 5-20R2GFCI

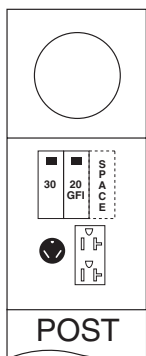

Fig. B
M041GP4
R32U, 5-20R2

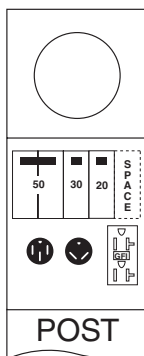

Fig. C
M075CP4010, R075CP4010
BR54U, R32U, 5-20R2GFCI

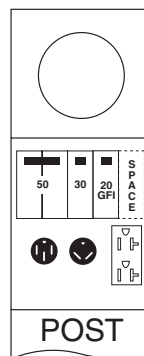

Fig. D
M075GP4
BR54U, R32U, 5-20R2

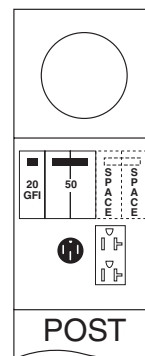

Fig. E
M355GP4
BR54U, 5-20R2

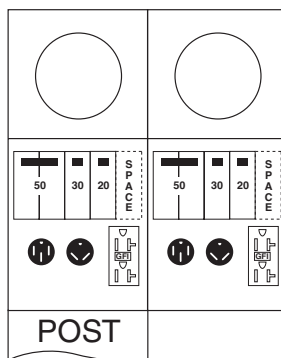

Fig. F
M075CB4010
BR54U, R32U, 5-20R2GFCI

Fig.	Model Number		Receptacles	Circuit Protection	Amps	Wire Range*	Cabinet Size	Hub Opening	Load & Neutral Bar	Unit Wt.	Std Pkg.	UL
	Ring Type	Ringless										
A	M041CP4010	—	R32U, 5-20R2GFCI	THQL1130, THQL1120, Space THQL1120	100	Z	9PT	N	LC33N1	53	1	Y ¹
B	M041GP4	—	R32U, 5-20R2	THQL1130, THQL1120GFT, Space THQL1120					LC33N1	59		
C	M075CP4010	R075CP4010	BR54U, R32U, 5-20R2GFCI	THQL2150, THQL1130, THQL1120, Space THQL1120					LC55N1	59		
D	M075GP4	—	BR54U, R32U, 5-20R2	THQL2150, THQL1130, THQL1120GFT, Space THQL1120					LC55N1	59		
E	M355GP4	—	BR54U, 5-20R2	THQL2150, THQL1120GFT, Space THQP250					LC55N1	59		

Back-to-Back

Fig.	Model Number		Receptacles	Circuit Protection	Amps	Wire Range*	Cabinet Size	Hub Opening	Load & Neutral Bar	Unit Wt.	Std Pkg.	UL
	Ring Type	Ringless										
F	M075CB4010	—	BR54U, R32U, 5-20R2GFCI	THQL2150, THQL1130, THQL1120, Space THQL1120	100	S	9PT	N	LC55N1	82	1	Y ¹

¹ cULus approved.

* Wire Range Table on page 11-27-11-28.

Unmetered

Lighted, Surface 100 Amps, 120/240V

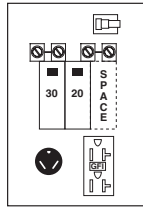

Fig. A
U041CTLL10
 R32U, 5-20R2GFCI

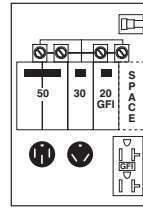

Fig. B
U075CTLL10
 BR32U, R32U, 5-20R2

Fig.	Model Number	Receptacles	Circuit Protection	Amps	Lug Type	Wire Range*	Cabinet Size	Hub Opening	Load & Neutral Bar	Unit Wt.	Std Pkg.	UL
A	U041CTLL10	R32U, 5-20R2GFCI	THQL1130, THQL1120	100	Loop Feed	W	9 x 17	N	LC33N1T	14	1	Y ¹
B	U075CTLL10 ²	BR32U, R32U 5-20R2GFCI	THQL2150, THQL1130, Space THQL1120						LC55N1T	16		

¹ cULus approved.
² Available with light and 50A ground fault breaker – U075CTL035.
 * Wire Range Table on page 11-28.

Light Socket Assembly.

Metered

Lighted, Pedestal, 100 Amps, 120/240V

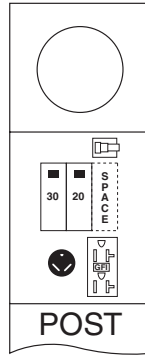

Fig. C
M041CP6L10, M041CP4L10
 R32U, 5-20R2GFCI

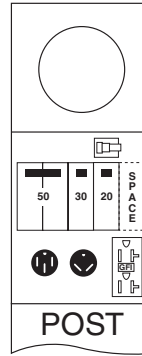

Fig. D
M075CP6L10, M075CP4L10
 BR54U, R32U, 5-20R2GFCI

Fig.	Model Number		Receptacles	Circuit Protection	Amps	Wire Range*	Cabinet Size	Hub Opening	Load & Neutral Bar	Unit Wt.	Std Pkg.	UL
	Earth Burial	Pad Mount										
C	M041CP6L10	M041CP4L10 ²	R32U, 5-20R2GFCI	THQL1130, THQL1120, Space THQL1120	100	Z	9PT	Y	LC33N1	50	1	Y ¹
D	M075CP6L10 ²	M075CP4L10 ²	BR54U, R32U, 5-20R2GFCI	THQL2150, THQL1130, THQL1120, Space THQL1120					LC55N1	59		

¹ cULus approved.
² Available with factory installed TV/Telephone – M041CP4L31, M075CP6L31, M075CP4L31. See pages 11-23–11-24 for TV/Telephone model diagrams.
 * Wire Range Table on page 11-28.

Light Socket Assembly.

Unmetered

Lighted, Pedestal, 70 – 100 Amps, 120/240V

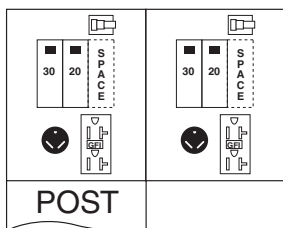

Fig. A
U041CB6L10, U041CB4L10
 R32U, 5-20R2GFC

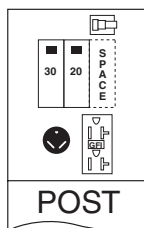

Fig. B
U041CP6L10, U041CP4L10
 R32U, 5-20R2GFCI

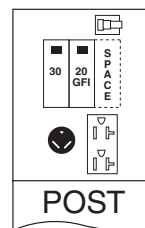

Fig. C
U041GP6L, U041GP4L10
 BR54U, R32U, 5-20R2

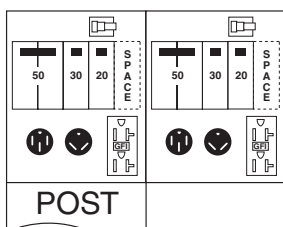

Fig. D
U075CB6L10, U075CB4L10
 BR54U, R32U, 5-20R2GFCI

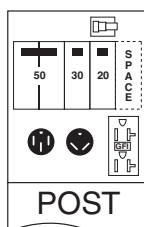

Fig. E
U075CP6L10, U075GP4L10
 BR54U, R32U, 5-20R2GFCI

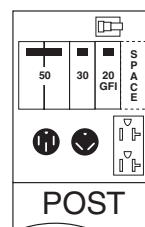

Fig. F
U075GP6L, U075GP4L
 BR54U, R32U, 5-20R2

Fig.	Model Number		Receptacles	Circuit Protection	Amps	Wire Range*	Cabinet Size	Hub Opening	Load & Neutral Bar	Unit Wt.	Std Pkg.	UL
	Earth Burial	Pad Mount										
A	U041CB6L10	U041CB4L10	R32U, 5-20R2GFCI	THQL1130, THQL1120, Space THQL1120	70	Z	6PT	N	LC33N1	42	1	Y ¹
B	U041CP6L10	U041CP4L10	R32U, 5-20R2GFCI	THQL1130, THQL1120, Space THQL1120	70	Z	6PT		LC33N1	30		
C	U041GP6L	U041GP4L	BR54U, R32U, 5-20R2	THQL1130, THQL1120GFT, THQL2150, Space THQL1120	70	Z	6PT		LC33N1	30		
D	U075CB6L10	U075CB4L10	BR54U, R32U, 5-20R2GFCI	THQL1120, Space THQL1120, THQL2150, THQL1130	100	S	9PT		LC55N1	62		
E	U075CP6L10 ^{2,3}	U075CP4L10 ²	BR54U, R32U, 5-20R2GFCI	THQL2150, THQL1130, THQL1120, Space THQL1120	100	Z	9PT		LC55N1	36		
F	U075GP6L	U075GP4L	BR54U, R32U, 5-20R2	THQL2150, THQL1130, THQL1120GFT, Space THQL1120	100	Z	9PT		LC55N1	62		

¹ cULus approved.

² Available with factory installed TV/Telephone – U075CP6L31, U075CP4L31. See pages 11-23–11-24 for TV/Telephone model diagrams.

³ Available with factory installed TV/Telephone, light and bronze finish – U075CP6L31BZ.

* Wire Range Table on page 11-27–11-28.

Light Socket Assembly.

Technical Data

Model Number	Replacement Parts		Cabinet Size	Enclosure Style ¹	Cabinet Dimensions (inches) ³			Knockout Figure ²
	Meter Socket	Post Lugs			Height (A)	Width (B)	Depth (C)	
5S3S2S2SEB	—	LT100B350	14PT	—	—	—	—	—
5S3S2S2SES	—	LT100S350	14PT	—	—	—	—	—
5S3S3S2SEB	—	LT100B350	14PT	—	—	—	—	—
5S3S3S2SES	—	LT100S350	14PT	—	—	—	—	—
M004C010	MSM100930	—	9 x 30	B	30	9-3/4	5-3/16	2
M004CP6010	MSM100P9	LT100S350	9PT	—	—	—	—	—
M031C010	MSM100930	—	9 x 30	B	30	9-3/4	5-3/16	2
M041C010	MSM100930	—	9 x 30	B	30	9-3/4	5-3/16	2
M041CB6010	MSM100P9, MSM100HP ⁴	LT100B350	9PT	A	—	—	—	—
M041CP4010	MSM100P9	LT100S350	9PT	—	—	—	—	—
M041CP4L10	MSM100P9	LT100S350	9PT	—	—	—	—	—
M041CP4L31	MSM100P9	LT100S350	9PT	—	—	—	—	—
M041CP6010	MSM100P9	LT100S350	9PT	—	—	—	—	—
M041CP6L10	MSM100P9	LT100S350	9PT	—	—	—	—	—
M041G	MSM100930	—	9 x 30	B	30	9-3/4	5-3/16	2
M041GB6	MSM100P9, MSM100HP ⁴	LT100B350	9PT	A	—	—	—	—
M041GP4	MSM100P9	LT100S350	9PT	—	—	—	—	—
M041GP6	MSM100P9	LT100S350	9PT	—	—	—	—	—
M055GP6	MSM100P9	LT100S350	9PT	—	—	—	—	—
M075C010	MSM100930	—	9 x 30	B	30	9-3/4	5-3/16	2
M075CB4010	MSM100P9, MSM100HP ⁴	LT100B350	9PT	A	—	—	—	—
M075CB6010	MSM100P9, MSM100HP ⁴	LT100B350	9PT	A	—	—	—	—
M075CB6031	MSM100P9, MSM100HP ⁴	LT100B350	9PT	A	—	—	—	—
M075CP4010	MSM100P9	LT100S350	9PT	—	—	—	—	—
M075CP4L10	MSM100P9	LT100S350	9PT	—	—	—	—	—
M075CP4L31	MSM100P9	LT100S350	9PT	—	—	—	—	—
M075CP6010	MSM100P9	LT100S350	9PT	—	—	—	—	—
M075CP6010GR	MSM100P9	LT100S350	9PT	—	—	—	—	—
M075CP6031	MSM100P9	LT100S350	9PT	—	—	—	—	—
M075CP6L10	MSM100P9	LT100S350	9PT	—	—	—	—	—
M075CP6L31	MSM100P9	LT100S350	9PT	—	—	—	—	—
M075G	MSM100930	—	9 x 30	B	30	9-3/4	5-3/16	2
M075GB6	MSM100P9, MSM100HP ⁴	LT100B350	9PT	A	—	—	—	—
M075GP4	MSM100P9	LT100S350	9PT	—	—	—	—	—
M075GP6	MSM100P9	LT100S350	9PT	—	—	—	—	—
M275CP6010	— ⁶	LT200S350	14PT	—	—	—	—	—
M275CP6010G1	— ⁶	LT200S350	14PT	—	—	—	—	—
M355C010	MSM100930	—	9 x 30	B	30	9-3/4	5-3/16	2
M355CP6010	MSM100P9	LT100S350	9PT	—	—	—	—	—
M355G	MSM100930	—	9 x 30	B	30	9-3/4	5-3/16	2
M355GB6	MSM100P9, MSM100HP ⁴	LT100B350	9PT	A	—	—	—	—
M355GP4	MSM100P9	LT100S350	9PT	—	—	—	—	—
M355GP6	MSM100P9	LT100S350	9PT	—	—	—	—	—
M358CP6	MSM100P9	LT100B350	9PT	—	—	—	—	—
M655GB6	MW200M	LT200B350	14PT	—	—	—	—	—
M655GP6	MW200M	LT200S350	14PT	—	—	—	—	—
M675CP6010	— ⁶	LT200S350	14PT	—	—	—	—	—
M775CB6010	MSM100P9, MSM100HP ⁴	LT100B350	9PT	A	—	—	—	—
M775CP6010	MSM100P9	LT100S350	9PT	—	—	—	—	—
R031C010	MSR100930	—	9 x 30	B	30	9-3/4	5-3/16	2
R041C010	MSR100930	—	9 x 30	B	30	9-3/4	5-3/16	2
R041CP6010	MSR100P9	LT100S350	9PT	—	—	—	—	—
R041G	MSR100930	—	9 x 30	B	30	9-3/4	5-3/16	2
R041GB6	MSR100P9, MSR100HP ⁵	LT100B350	9PT	B	—	—	—	—
R041GP6	MSR100P9	LT100S350	9PT	—	—	—	—	—
R075C010	MSR100930	—	9 x 30	B	30	9-3/4	5-3/16	2
R075CB6010	MSR100P9	LT100B350	9PT	—	—	—	—	—

¹ Enclosure Styles on page 11-22.² Knockout Figures on page 11-22.³ Post Cabinet sizes and dimensions on page 11-22.⁴ Front (inline side) – MSM100P9; Back (powerhead side) – MSM100HP.⁵ Front (inline side) – MSR100P9; Back (powerhead side) – MSR100HP.⁶ No replacement meter socket set up in system.

Technical Data

Model Number	Replacement Parts		Cabinet Size	Enclosure Style ¹	Cabinet Dimensions (inches) ³			Knockout Figure ²
	Meter Socket	Post Lugs			Height (A)	Width (B)	Depth (C)	
R075CB6010FMG	MSR100P9	LT100B350	9PT	—	—			—
R075CP4010	MSR100P9	LT100S350	9PT	—	—			—
R075CP6010	MSR100P9	LT100S350	9PT	—	—			—
R075CP6010FMG	MSR100P9	LT100S350	9PT	—	—			—
R075CP6010Z1	MSR100P9	LT100S350	9PT	—	—			—
R075CP6031	MSR100P9	LT100S350	9PT	—	—			—
R075GB6	MSR100P9, MSR100HP ⁴	LT100B350	9PT	B	—			—
R075GP6	MSR100P9	LT100S350	9PT	—	—			—
R355CP6010	MSR100P9	LT100S350	9PT	—	—			—
R355CP6031	MSR100P9	LT100S350	9PT	—	—			—
R355G	MSR100930	—	9 x 30	B	30	9-3/4	5-3/16	2
R355GP6	MSR100P9	—	9PT	—	—			—
U004CB4010	—	LT100B350	9PT	—	—			—
U004CB6010	—	LT100B350	9PT	—	—			—
U004CP4010	—	LT100S350	9PT	—	—			—
U004CP4031	—	LT100S350	9PT	—	—			—
U004CP6010	—	LT100S350	9PT	—	—			—
U004CP6L10	—	LT100S350	9PT	—	—			—
U010C010	—	—	6 x 9	A	9-1/8	7-1/4	5-3/16	1
U010G	—	—	6 x 9	A	9-1/8	7-1/4	5-3/16	1
U011C010	—	—	6 x 14	A	14-3/8	7-1/4	5-3/16	1
U011CP4010	—	LT100S350	6PT	—	—			—
U011CP6010	—	LT100S350	6PT	—	—			—
U011CTL010	—	—	9 x 17	A	17-3/8	9-3/4	5-3/16	2
U011G	—	—	6 x 14	A	14-3/8	7-1/4	5-3/16	1
U011GB4	—	LT100B350	6PT	—	—			—
U011GB6	—	LT100B350	6PT	—	—			—
U011GP4	—	LT100S350	6PT	—	—			—
U011GP6	—	LT100S350	6PT	—	—			—
U011GTL	—	—	9 x 17	A	17-3/8	9-3/4	5-3/16	2
U031C010	—	—	9 x 17	A	17-3/8	9-3/4	5-3/16	2
U040G	—	—	6 x 14	A	14-3/8	7-1/4	5-3/16	1
U040GP4	—	LT100S350	6PT	—	—			—
U040GP6	—	LT100S350	6PT	—	—			—
U040GP6010	—	LT100S350	6PT	—	—			—
U040GTL	—	—	9 x 17	A	17-3/8	9-3/4	5-3/16	2
U041C010P	—	—	6 x 14	A	14-3/8	7-1/4	5-3/16	1
U041CB4010	—	LT100B350	6PT	—	—			—
U041CB4L10	—	LT100B350	6PT	—	—			—
U041CB6010	—	LT100B350	6PT	—	—			—
U041CB6L10	—	LT100B350	6PT	—	—			—
U041CP4010	—	LT100S350	6PT	—	—			—
U041CP4031	—	LT100S350	6PT	—	—			—
U041CP4L10	—	LT100S350	6PT	—	—			—
U041CP6010	—	LT100S350	6PT	—	—			—
U041CP6031	—	LT100S350	6PT	—	—			—
U041CP6L10	—	LT100S350	6PT	—	—			—
U041CTL010	—	—	9 x 17	A	17-3/8	9-3/4	5-3/16	2
U041CTLL10	—	—	9 x 17	A	17-3/8	9-3/4	5-3/16	2
U041G	—	—	6 x 14	A	14-3/8	7-1/4	5-3/16	1
U041GB4	—	LT100B350	6PT	—	—			—
U041GB6	—	LT100B350	6PT	—	—			—
U041GP4	—	LT100S350	6PT	—	—			—
U041GP4L	—	LT100S350	6PT	—	—			—
U041GP6	—	LT100S350	6PT	—	—			—
U041GP6L	—	LT100S350	6PT	—	—			—

¹ Enclosure Styles on page 11-22.

² Knockout Figures on page 11-22.

³ Post Cabinet sizes and dimensions on page 11-22.

⁴ Front (inline side) – MSR100P9; Back (powerhead side) – MSR100HP.

Technical Data

Model Number	Replacement Parts		Cabinet Size	Enclosure Style ¹	Cabinet Dimensions (inches) ³			Knockout Figure ²
	Meter Socket	Post Lugs			Height (A)	Width (B)	Depth (C)	
U041GTL	—	—	9 x 17	A	17-3/8	9-3/4	5-3/16	2
U042GB6	—	LT100B350	6PT	—	—	—	—	—
U042GP6	—	LT100S350	6PT	—	—	—	—	—
U043GP6	—	LT100S350	6PT	—	—	—	—	—
U055CP4010	—	LT100S350	6PT	—	—	—	—	—
U055CP6010	—	LT100S350	6PT	—	—	—	—	—
U055GB6	—	LT100B350	6PT	—	—	—	—	—
U074GTL	—	—	9 x 17	A	17-3/8	9-3/4	5-3/16	2
U075CB4010	—	LT100B350	9PT	—	—	—	—	—
U075CB4031	—	LT100B350	9PT	—	—	—	—	—
U075CB4L10	—	LT100B350	9PT	—	—	—	—	—
U075CB6010	—	LT100B350	9PT	—	—	—	—	—
U075CB6031	—	LT100B350	9PT	—	—	—	—	—
U075CB6L10	—	LT100B350	9PT	—	—	—	—	—
U075CP4010	—	LT100S350	9PT	—	—	—	—	—
U075CP4010ZI	—	LT100S350	9PT	—	—	—	—	—
U075CP4031	—	LT100S350	9PT	—	—	—	—	—
U075CP4L10	—	LT100S350	9PT	—	—	—	—	—
U075CP4L31	—	LT100S350	9PT	—	—	—	—	—
U075CP6010	—	LT100S350	9PT	—	—	—	—	—
U075CP6010BZ	—	LT100S350	9PT	—	—	—	—	—
U075CP6010D	—	LT100S350	9PT	—	—	—	—	—
U075CP6010T	—	LT100S350	9PT	—	—	—	—	—
U075CP6031	—	LT100S350	9PT	—	—	—	—	—
U075CP6L10	—	LT100S350	9PT	—	—	—	—	—
U075CP6L31	—	LT100S350	9PT	—	—	—	—	—
U075CP6L31BZ	—	LT100S350	9PT	—	—	—	—	—
U075CTL010	—	—	9 x 17	A	17-3/8	9-3/4	5-3/16	2
U075CTL035	—	—	9 x 17	A	17-3/8	9-3/4	5-3/16	2
U075CTLL10	—	—	9 X 17	A	17-3/8	9-3/4	5-3/16	2
U075GB6	—	LT100B350	9PT	—	—	—	—	—
U075GP4	—	LT100S350	9PT	—	—	—	—	—
U075GP4L	—	LT100S350	9PT	—	—	—	—	—
U075GP6	—	LT100S350	9PT	—	—	—	—	—
U075GP6C	—	LT100S350	9PT	—	—	—	—	—
U075GP6019	—	LT100S350	9PT	—	—	—	—	—
U075GP6L	—	LT100S350	9PT	—	—	—	—	—
U075GTL	—	—	9 x 17	A	17-3/8	9-3/4	5-3/16	2
U131CP6010	—	LT100S350	14PT	—	—	—	—	—
U131CTL010	—	—	14 x 21	A	21-3/8	14-3/4	6-7/16	3
U175CP6HP010	—	—	14PT	—	—	—	—	—
U355C010	—	—	9 x 17	A	17-3/8	9-3/4	5-3/16	2
U355G	—	—	9 x 17	A	17-3/8	9-3/4	5-3/16	2
U355GP6	—	LT100S350	9PT	—	—	—	—	—
U412CP6010	—	LT100S350	9PT	—	—	—	—	—
U412G	—	—	9 x 17	A	17-3/8	9-3/4	5-3/16	2
U412GP6	—	LT100S350	9PT	—	—	—	—	—
U611CB4010	—	LT100B350	9PT	—	—	—	—	—
U611CB6010	—	LT100B350	9PT	—	—	—	—	—
U611CP4010	—	LT100S350	9PT	—	—	—	—	—
U611CP6010	—	LT100S350	9PT	—	—	—	—	—
U611CTL010	—	—	9 x 17	A	17-3/8	9-3/4	5-3/16	2
U611GTL	—	—	9 x 17	A	17-3/8	9-3/4	5-3/16	2
U775C010	—	—	9 X 17	A	17-3/8	9-3/4	5-3/16	2
U775CP4010	—	LT100S350	9PT	—	—	—	—	—
U775CP6010	—	LT100S350	9PT	—	—	—	—	—

¹ Enclosure Styles on page 11-22.² Knockout Figures on page 11-22.³ Post Cabinet sizes and dimensions on page 11-22.

Technical Data

RV Power Outlets

Cabinet Size	Enclosure Style	Cabinet Dimensions (inches)			Knockout Figure
		Height (A)	Width (B)	Depth (C)	
6 x 9	A	9-1/8	7-1/4	5-3/16	1
6 x 14	A	14-3/8	7-1/4	5-3/16	1
9 x 17	A	17-3/8	9-3/4	5-3/16	2
9 x 30	B	30	9-3/4	5-3/16	2
14 x 21	A	21-3/8	14-3/4	6-7/16	3

Enclosure Styles / Cabinet Dimensions

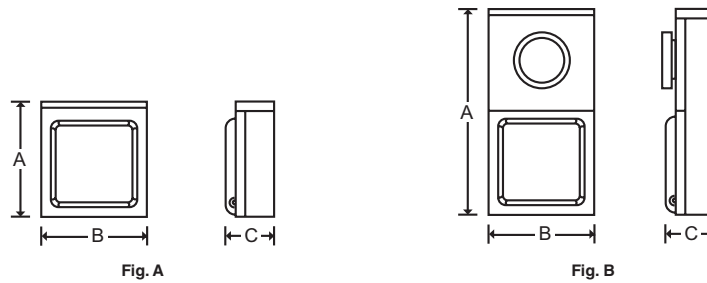

Knockout Configurations

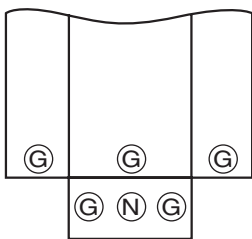

Fig. 1

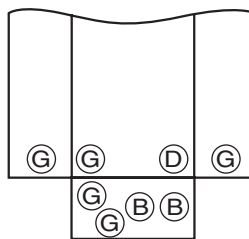

Fig. 2

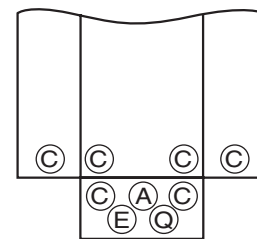

Fig. 3

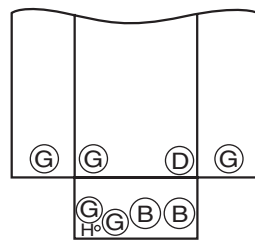

Fig. 4

Knockout Key

- A = 1-1/2", 2", 2-1/2"
- B = 1", 1-1/4", 1-1/2"
- C = 1-1/4", 1-1/2", 2"
- D = 3/4", 1", 1-1/4"
- E = 3/4"
- G = 1/2", 3/4", 1"
- H = 9/32"
- N = 1/2", 3/4", 1", 1-1/4", 1-1/2"
- Q = 1"

* Knockouts shown for size not for exact positions.

Data subject to change without notice.

Post Dimensions

TV/Telephone Unmetered

U004CP4031

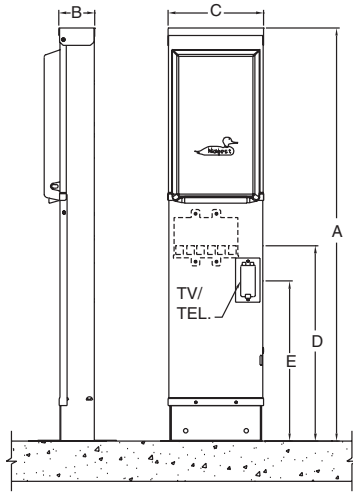

Key	Unmetered
A	41-1/8"
B	3-1/8"
C	9"
D	19-1/2"
E	16"

U075CP4031

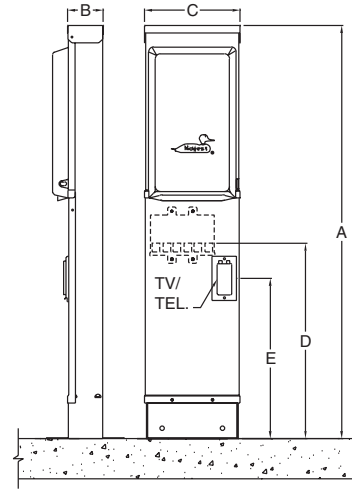

Key	Unmetered
A	41-1/8"
B	3-3/8"
C	9"
D	19-1/2"
E	16"

U041CP6031

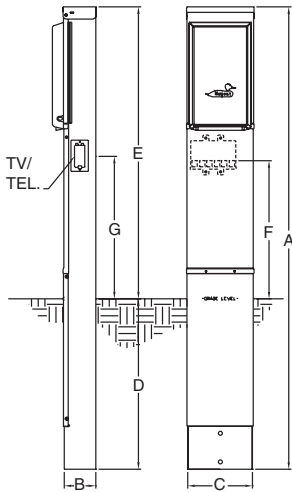

Key	Unmetered
A	65-1/8"
B	4-1/2"
C	9"
D	24"
E	41-1/8"
F	19-1/2"
G	20"

U075CP4L31

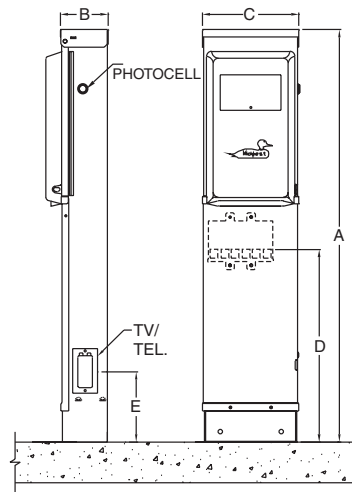

Key	Unmetered
A	40-1/2"
B	4-1/2"
C	9"
D	19"
E	7"

U075CB4031

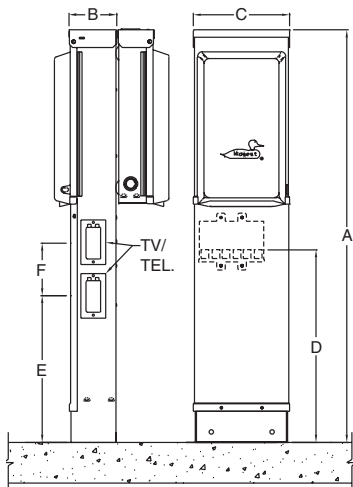

Key	Unmetered
A	40-1/2"
B	4-1/2"
C	9"
D	19"
E	14-1/2"
F	5-1/4"

U075CP6L31

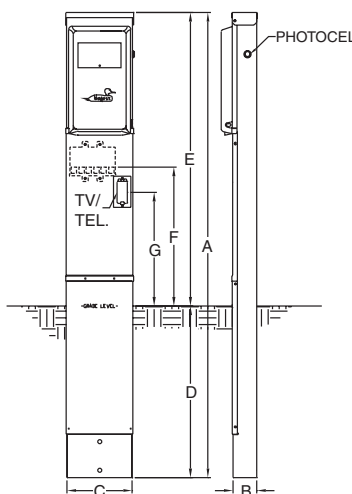

Key	Unmetered
A	65-1/8"
B	3-3/8"
C	9"
D	24"
E	41-1/8"
F	19-1/2"
G	16"

Data subject to change without notice.

RV Equip – Metallic

Post Dimensions

TV/Telephone Unmetered

U075CB6031

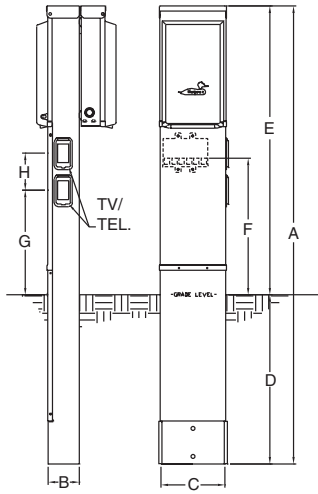

Key	Unmetered
A	65-1/8"
B	4-1/2"
C	9"
D	24"
E	41-1/8"
F	19-1/2"
G	15"
H	5-1/4"

U075CP6031

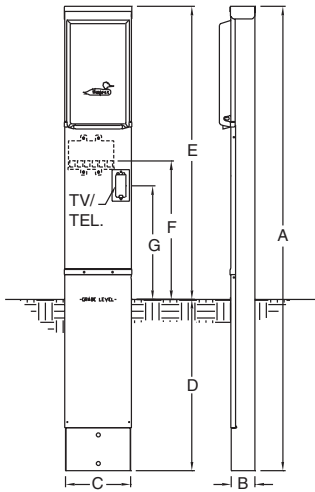

Key	Unmetered
A	65-1/8"
B	3-3/8"
C	9"
D	24"
E	41-1/8"
F	19-1/2"
G	16"

Flip-Cover for TV/Telephone is standard with padlock provision.

Dimensions Key

- A = Post Length
- B = Meter Center to Grade
- C = Terminal Bar to Grade
- D = Post Width
- E = Post Depth
- F = Grade to Wire Opening
- G = Wire Opening

Post Dimensions

Earth Burial

6PT

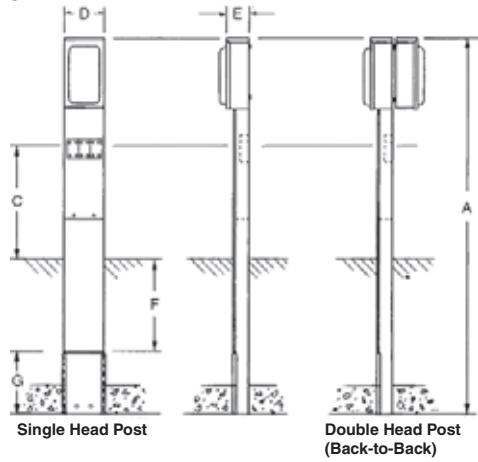

Key	Unmetered
A	62"
C	19-3/4"
D	6-1/2"
E	3-1/4"
F	18"
G	6"

14PT

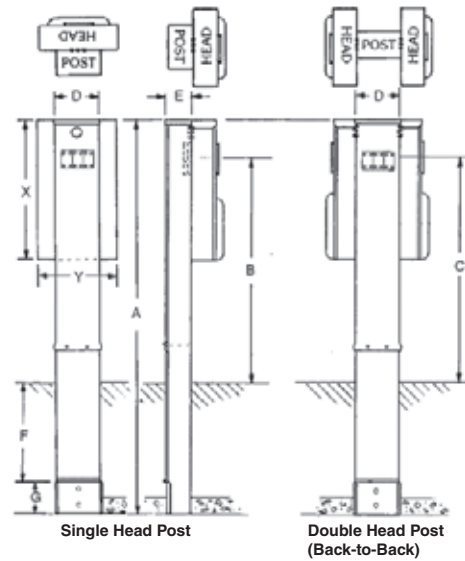

Key	Unmetered	Metered
A	83-1/2"	86"
B	—	50"
C	49-1/2"	49-1/2"
D	9"	9"
E	3-1/2"	3-1/2" ¹
F	18"	18"
G	6"	6"

¹ Some models available in 4-3/8".
 Contact distributor/factory.

9PT

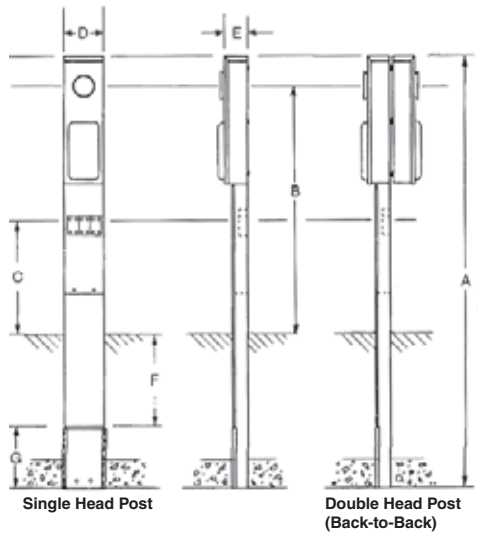

Key	Unmetered	Metered
A	65"	77-1/2"
B	—	45-1/4"
C	19-1/8"	19-1/8"
D	9"	9"
E	3-1/2" ¹	3-1/2" ¹
F	18"	18"
G	6"	6"

¹ Some models available in 4-3/8".
 Contact distributor/factory.

Post Dimensions

Pad Mount

6PT

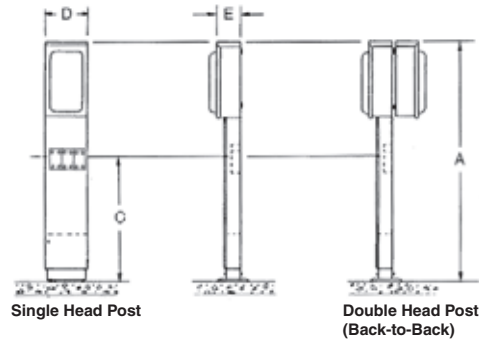

Key	Unmetered
A	36"
C	17-3/4"
D	6-1/2"
E	3-3/4"

9PT

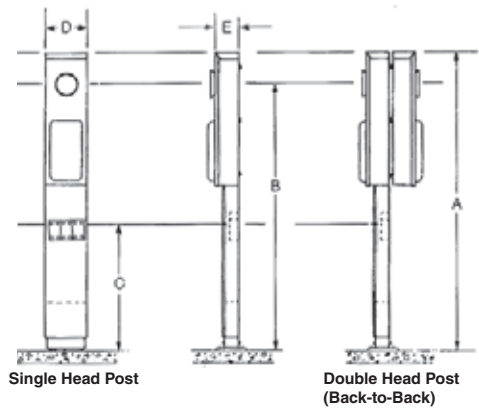

Key	Unmetered	Metered
A	41-1/8"	53-1/2"
B	—	45-1/2"
C	19-3/4"	19-1/2"
D	9"	9"
E	3-1/2" ¹	3-1/2" ¹

¹ Some models available in 4-3/8".
Contact distributor/factory.

Dimensions Key

- A = Post Length
- B = Meter Center to Grade
- C = Terminal Bar to Grade
- D = Post Width
- E = Post Depth
- F = Grade to Wire Opening
- G = Wire Opening

Wire Range Tables

AA

Connector	Copper		Aluminum	
	Solid	Strand	Solid	Strand
Line	—	6-1/0	—	6-1/0
Load	14-10	14-10	—	—
Neutral - Large Hole	12-8	12-1/0	10-8	10-1/0
Neutral - Small Hole	14-8	14-4	12-8	12-4
Equipment Ground	12-8	12-2	12-8	12-2

AR

Connector	Copper		Aluminum	
	Solid	Strand	Solid	Strand
Line	14-10	14-10	—	—
Load	14-10	14-10	—	—
Neutral	—	—	—	—
Equipment Ground	12-8	12-2	—	—

B

Connector	Copper		Aluminum	
	Solid	Strand	Solid	Strand
Line	14-8	14-6	12-8	12-6
Load	14-10	14-10	—	—
Neutral	12-8	12-6	12-8	12-6
Equipment Ground	12-8	12-2	12-8	12-2

BB

Connector	Copper	
	Solid	Strand
Line	14-10	14-10
Load	14-10	14-10
Neutral	14-10	14-10
Equipment Ground	12-8	12-2

BX

Connector	Copper		Aluminum	
	Solid	Strand	Solid	Strand
Line - Meter Socket	—	1/0-250	—	1/0-250
Load - Plug Duplex	14-10	14-10	—	—
Load - CB Base Lugs	—	1/0-4/0	—	1/0-4/0
Neutral	—	2-250	—	2-250
Neutral	14-8	14-1/0	12-8	12-1/0
Neutral	14-8	10-4	—	6-4
Neutral	14-8	12-8	12-8	12-8
Equipment Ground	12-8	12-2	12-8	12-2
Post Line Connectors Suitable for Loop Feed	6-350 kcmil		6-350 kcmil	

BY

Connector	Copper		Aluminum	
	Solid	Strand	Solid	Strand
Line	—	1/0-250	—	1/0-250
Load	14-10	14-10	—	—
Neutral	—	2-250	—	2-250
Neutral	14-8	14-1/0	12-8	12-1/0
Neutral	14-8	10-4	—	12-8
Neutral	14-8	12-8	12-8	12-8
Equipment Ground	12-8	12-2	12-8	12-2
Post Line Connectors Suitable for Loop Feed	6-350 kcmil		6-350 kcmil	

P

Connector	Copper		Aluminum	
	Solid	Strand	Solid	Strand
Line	14-8	14-1/0	12-8	12-1/0
Load	14-10	14-10	—	—
Neutral - End Hole	14-8	14-2	12-8	12-2
Neutral - Side Hole	14-8	14-4	12-8	12-4
Equipment Ground	12-8	12-2	12-8	12-2

S

Connector	Copper		Aluminum	
	Solid	Strand	Solid	Strand
Post Line Connectors Suitable for Loop Feed	6-350 kcmil		6-350 kcmil	
Equipment Ground	12-2		12-2	

U

Connector	Copper		Aluminum	
	Solid	Strand	Solid	Strand
Line	14-8	14-1/0	12-8	12-1/0
Load	14-10	14-10	—	—
Neutral - Large Hole	12-8	12-1/0	10-8	10-1/0
Neutral - Small Hole	14-8	14-4	12-8	12-4
Equipment Ground	12-8	12-2	12-8	12-2

UX

Connector	Copper		Aluminum	
	Solid	Strand	Solid	Strand
Line	14-8	14-1/0	12-10	12-1/0
Neutral - Large Hole	12-8	12-1/0	10	10-1/0
Neutral - Small Hole	14-8	14-4	12-10	12-4
Equipment Ground	14-2/0	14-2/0	14-2/0	14-2/0

Wire Range Tables

W

Connector	Copper		Aluminum	
	Solid	Strand	Solid	Strand
Line - Loop Feed	14-8	14-1/0	12-8	12-1/0
Load	14-8	14-1/0	—	—
Neutral - Large Hole	12-8	12-1/0	10-8	10-1/0
Neutral - Small Hole	14-8	14-4	12-8	12-4
Equipment Ground	12-8	12-2	12-8	12-2

X

Connector	Copper		Aluminum	
	Solid	Strand	Solid	Strand
Line - CB Base (JL-100)	14-8	14-1/0	12-8	12-1/0
Load - Plug Duplex	14-10	14-10	—	—
Neutral	14-4	14-4	14-4	14-4
Equipment Ground – Post	14-2/0	14-2/0	14-2/0	14-2/0

Y

Connector	Copper		Aluminum	
	Solid	Strand	Solid	Strand
Line - Meter Socket	—	6-1/0	—	6-1/0
Load - Plug Duplex	14-10	14-10	—	—
Neutral	14-4	14-4	14-4	14-4
Equipment Ground – Post	14-2/0	14-2/0	14-2/0	14-2/0

Z

Connector	Copper		Aluminum	
	Solid	Strand	Solid	Strand
Post Line Connectors Suitable for Loop Feed	6-350 kcmil		6-350 kcmil	
Equipment Ground	14-2/0		14-2/0	

ZZ

Connector	Copper		Aluminum	
	Solid	Strand	Solid	Strand
Line - Meter Socket	—	1/0-250	—	1/0-250
Load - CB Base Lugs	—	2-250	—	2-250
Neutral - Large Single Lugs	—	2-250	—	2-250
Neutral - Small Single Lugs	14-8	14-1/0	12-8	12-1/0
Neutral - 6 Large Hole	14-8	10-4	—	6-4
Neutral - 8 Small Hole	14-8	12-8	12-8	12-8
Equipment Ground	12-8	12-2	12-8	12-2



Application Information

ParkMate™ represents Midwest's premium line of RV power centers – offering superior corrosion protection against harsh coastal environments and in areas where roadways are heavily salted. The power center body is injection molded with impact and corrosion resistant VALOX™ engineered thermoplastic which is designed to provide years of maintenance free service. Post bodies are manufactured using heavy gauge galvanized steel. (Stainless steel posts are also available for the harshest environments.) Similar to our Metallic RV offering, ParkMate power centers are offered with the most common circuit protection, receptacles and convenience options. Choose ParkMate for the highest level of confidence in your RV power centers – you'll be glad you did!



Features and Benefits

Rugged Durability

- VALOX thermoplastic enclosure and internal components are corrosion resistant
- Earth burial posts are galvanized and features 350 KCMIL loop-feed lugs

Installation Ease

- Easy to wire terminal lugs
- Four circuit load center installed
- All units with factory installed Cu/Al equipment ground lug
- 10kAIC

User Safety

- Hinged cover closes over plugs and cords maintaining a safe, weather tight enclosure
- Padlock provision to prevent unauthorized access

Optional Features

- Available accessories – electronic meter, light, photocell
- Available add on accessory – TV/telephone
- Factory wired power receptacles are available in 20, 30 or 50 amp configurations protected by thermal magnetic circuit breakers
- Photoelectric sensor automatically turns lights on and off
- 7 watt fluorescent light illuminates receptacle for easy night time plug in while providing security lighting and easy identification of power center location – light circuit is protected by a 20 amp circuit breaker
- Additional accessories available – see pages 14-1-14-14

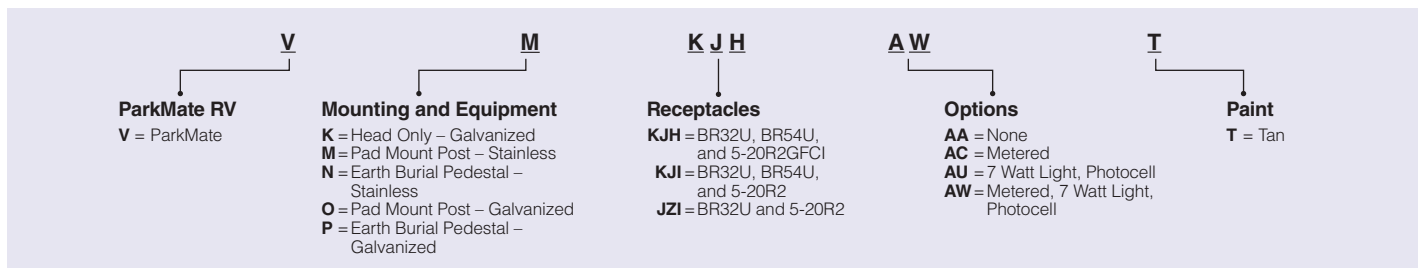

Head Only and Galvanized Steel Post

100 Amps, 120/240V

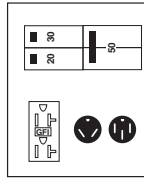

Fig. A
VKKJHAAT, VPKJHAAT,
VOKJHAAT
BR32U, BR54U, 5-20R2GFCl

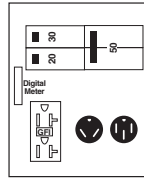

Fig. B
VKKJHACT, VPKJHACT,
VOKJHACT
BR32U, BR54U, 5-20R2GFCl

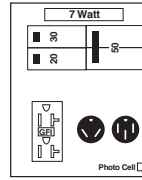

Fig. C
VKKJHAUT, VPKJHAUT,
VOKJHAUT
BR32U, BR54U, 5-20R2GFCl

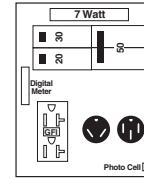

Fig. D
VKKJHAWT, VPKJHAWT,
VOKJHAWT
BR32U, BR54U, 5-20R2GFCl

Head Only

Fig.	Model Number ¹	Options	Receptacles	Circuit Protection	Amps	Cabinet Size	Load Center	Unit Wt.	Std Pkg.	UL
A	VKKJHAAT	—	BR32U, BR54U, 5-20R2GFCl	THQL2150, THQL1130, THQL1120	100	13.5 x 10	LC44X1	9	1	Y
B	VKKJHACT	Metered						10		
C	VKKJHAUT	7 Watt Light, Photocell						10		
D	VKKJHAWT	Metered, 7 Watt Light, Photocell						10		

Earth Burial, Galvanized Steel Post

Fig.	Model Number ¹	Options	Receptacles	Circuit Protection	Amps	Cabinet Size	Load Center	Unit Wt.	Std Pkg.	UL
A	VPKJHAAT	—	BR32U, BR54U, 5-20R2GFCl	THQL2150, THQL1130, THQL1120	100	13.5 x 10	LC44X1	45	1	Y
B	VPKJHACT	Metered						46		
C	VPKJHAUT	7 Watt Light, Photocell						46		
D	VPKJHAWT	Metered, 7 Watt Light, Photocell						46		

Pad Mount, Galvanized Steel Post

Fig.	Model Number ¹	Options	Receptacles	Circuit Protection	Amps	Cabinet Size	Load Center	Unit Wt.	Std Pkg.	UL
A	VOKJHAAT	—	BR32U, BR54U, 5-20R2GFCl	THQL2150, THQL1130, THQL1120	100	13.5 x 10	LC44X1	42	1	Y
B	VOKJHACT	Metered						43		
C	VOKJHAUT	7 Watt Light, Photocell						43		
D	VOKJHAWT	Metered, 7 Watt Light, Photocell						43		

¹ See page 11-33 for dimensions.

Stainless Steel Post

100 Amps, 120/240V

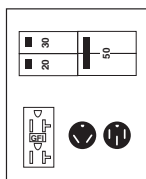

Fig. A
VNKJHAAT, VMKJHAAT
 BR32U, BR54U, 5-20R2GFCI

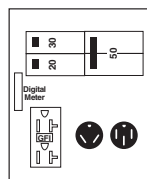

Fig. B
VNKJHACT, VMKJHACT
 BR32U, BR54U, 5-20R2GFCI

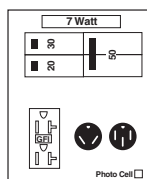

Fig. C
VNKJHAUT, VMKJHAUT
 BR32U, BR54U, 5-20R2GFCI

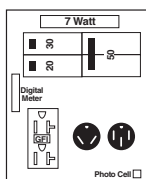

Fig. D
VNKJHAWT, VMKJHAWT
 BR32U, BR54U, 5-20R2GFCI

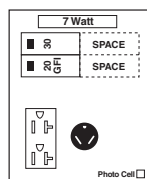

Fig. E
VMJZIAUT
 BR32U, 5-20R2

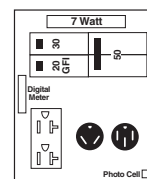

Fig. F
VMKJIAWT
 BR32U, BR54U, 5-20R2

Earth Burial

Fig.	Model Number ¹	Options	Receptacles	Circuit Protection	Amps	Cabinet Size	Load Center	Unit Wt.	Std Pkg.	UL
A	VNKJHAAT	—	BR32U, BR54U, 5-20R2GFCI	THQL2150, THQL1130, THQL1120	100	13.5 x 10	LC44X1	45	1	Y
B	VNKJHACT	Metered						46		
C	VNKJHAUT	7 Watt Light, Photocell						46		
D	VNKJHAWT	Metered, 7 Watt Light, Photocell						46		

Pad Mount

Fig.	Model Number ¹	Options	Receptacles	Circuit Protection	Amps	Cabinet Size	Load Center	Unit Wt.	Std Pkg.	UL
A	VMKJHAAT	—	BR32U, BR54U, 5-20R2GFCI	THQL2150, THQL1130, THQL1120	100	13.5 x 10	LC44X1	42	1	Y
B	VMKJHACT	Metered						43		
C	VMKJHAUT	7 Watt Light, Photocell						43		
D	VMKJHAWT	Metered, 7 Watt Light, Photocell						43		
E	VMJZIAUT	7 Watt Light, Photocell	BR32U, 5-20R2	THQL1130, THQL1120GF, (2) Spaces THQL1120				43		
F	VMKJIAWT	Metered, 7 Watt Light, Photocell	BR32U, BR54U, 5-20R2	THQL2150, THQL1130, THQL1120GF				43		

¹ See page 11-33 for dimensions.

Dimensions

ParkMate™

Head Only

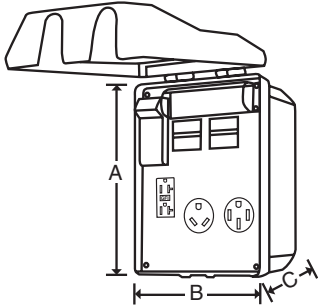

Key	Front
A	13-1/2"
B	10"
C	8"

Key	Back
A	12-1/8"
B	9-3/16"
C	8"

Water Shroud

UH90G / UH90GT

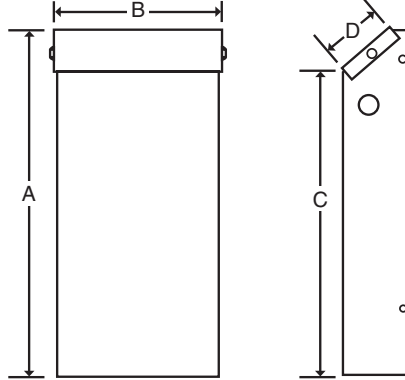

Key	Dimensions
A	15-1/4"
B	9-1/2"
C	13-1/4"
D	2-5/6"

Post (Earth Burial and Pad Mount)

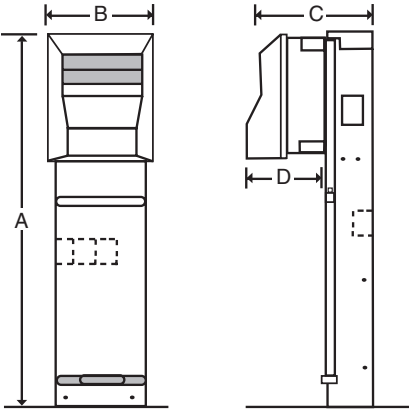

Key	Dimensions
A	41-1/2"
B	10"
C	12-3/4"
D	8"

UH90STL

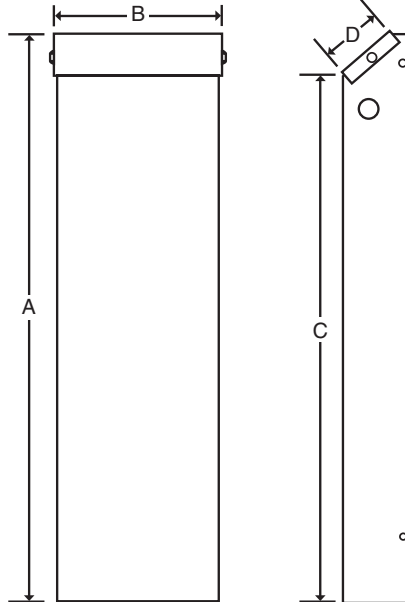

Key	Dimensions
A	27-1/4"
B	9-1/2"
C	25-1/4"
D	2-5/6"

TV/Telephone

TTV100T

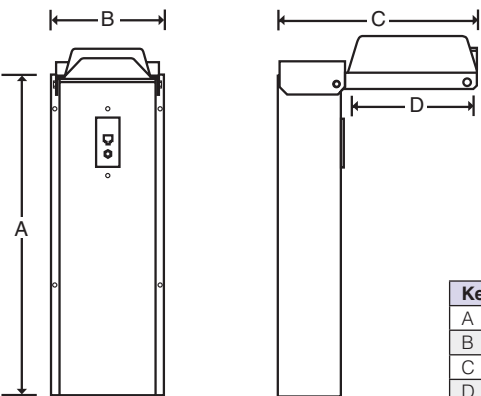

Key	Dimensions
A	17-4/5"
B	6-1/5"
C	9-1/10"
D	6"

Wire Range Table

Connector	Head Only	Post	
		Earth Burial	Pad Mount
Line Lug	14-1/0	1-350 kcmil	
Neutral	14-1/0	1-350 kcmil	
Ground Lug	12-2	12-2	

Notes

Section 12

Terminal Boxes

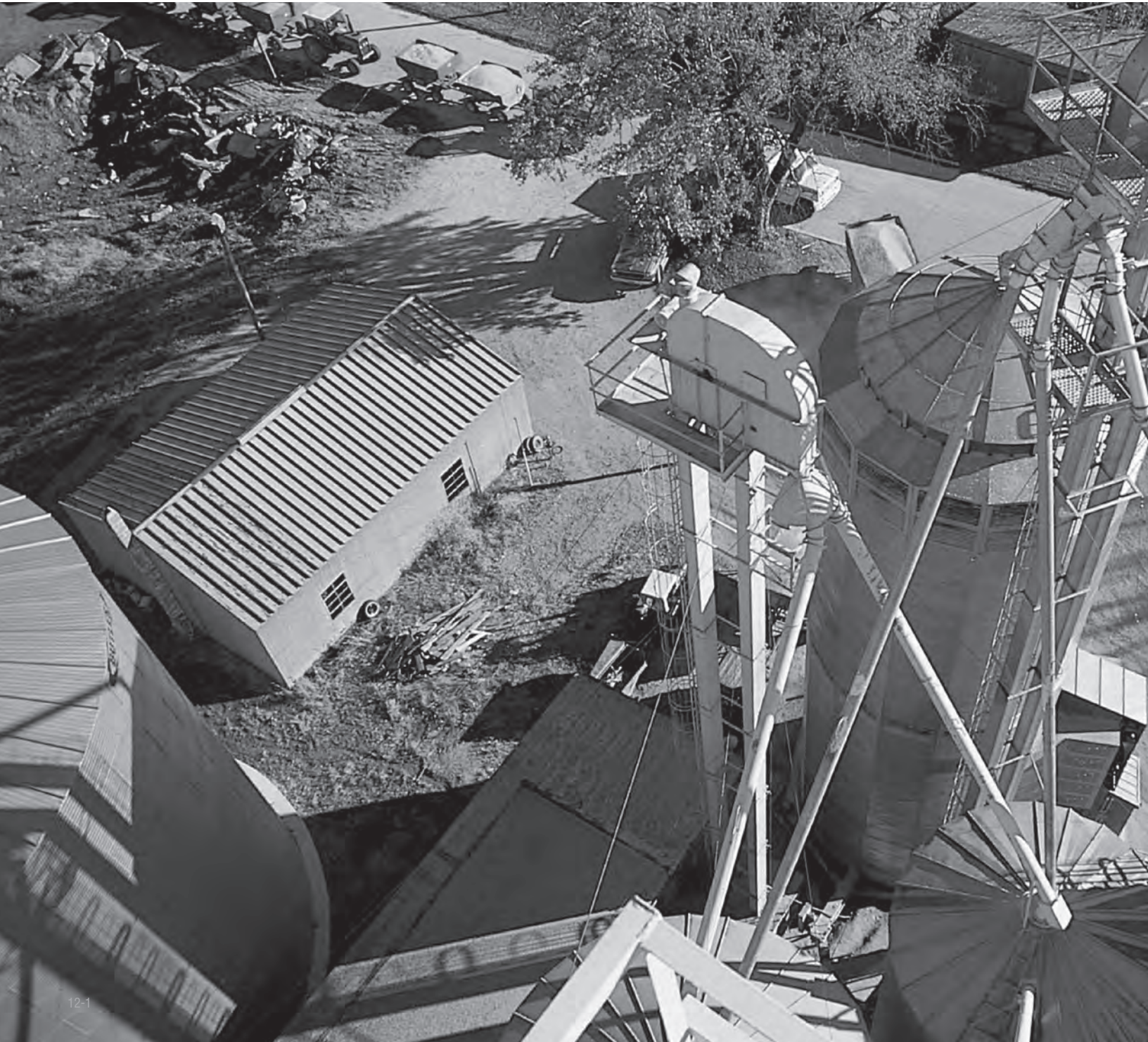

Application Information

Terminal Boxes convert overhead to underground services and are used for multi-circuit wiring. The NEMA 3R enclosure provides protection for all terminations inside and provides a convenient, time-saving means of wire splices and connections.

Midwest offers a full line of terminal boxes for 240 volt or 400 volt single-phase and three-phase 600 volt ratings to meet your application requirements. Typical applications, both indoor and outdoor, include inter-building wiring on farms, convenient splicing means for industrial use and commercial construction.

Features and Benefits

Installation Ease

- Rated for indoor and outdoor installations (NEMA 1/3R)
- Factory installed terminal bars accept copper or aluminum wire
- Plenty of concentric knockouts to reduce installation time
- Doors feature stay-open position or remove entirely to simplify wiring
- Stationary mounted terminations simplify circuit tracing
- Rolled edge door for cord protection

Durable, Safe, Long-lasting Construction

- G90 galvanized steel construction for superior corrosion protection
- Durable polyester powder coat finish resists chipping and fading
- Padlock provision helps prevent unauthorized entry
- Insulated lugs comply with NEC 314.28 E(4)
- All components factory wired and assembled



Terminal Boxes

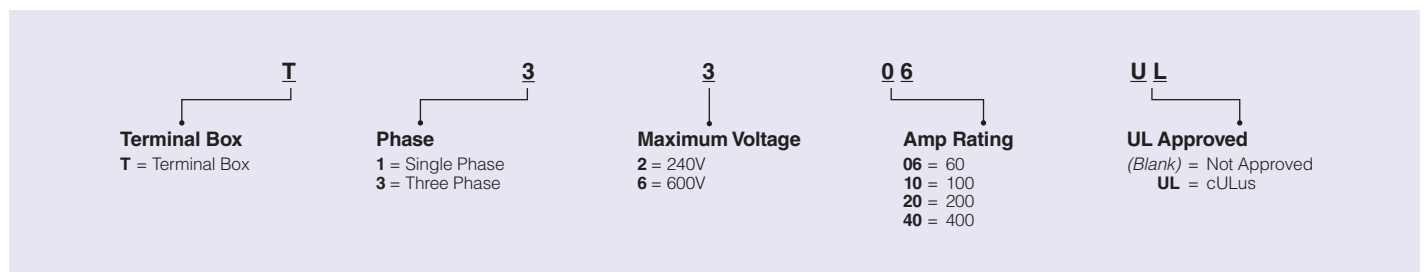

Data subject to change without notice.

Terminal Boxes

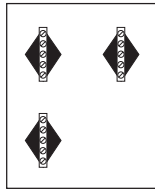

Fig. A
T1206, T1210, T1220

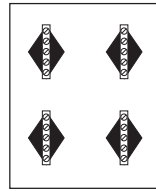

Fig. B
T3210, T3220,
T3610, T3620

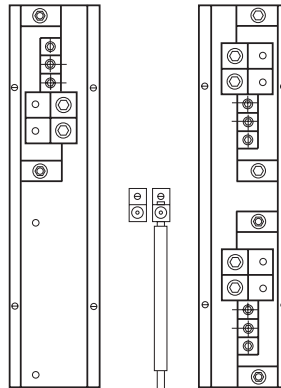

Fig. C
T1240UL

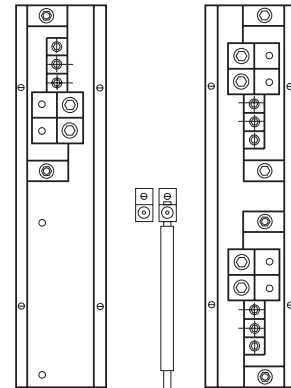

Fig. D
T3640UL

AC, 60 – 200 Amps, 240V Max

Fig.	Model Number	Wire Range	Phase	Amps	Cabinet Size	Hub Opening	Unit Wt.	Std Pkg.	UL
A	T1206	(4) 14-4	1	60	7 x 10	Y	6	4	Y ¹
A	T1210	(5) 14-1/0	1	100	9 x 17		11		
B	T3210	(5) 14-1/0	3	100	9 x 17		12		
A	T1220	(3) 1/0-250, (3) 12-1/0	1	200	14 x 21		19		
B	T3220	(3) 1/0-250, (3) 12-1/0	3	200	14 x 21		19		

¹ cULus approved.

AC, 400 Amps, 240V Max

Fig.	Model Number	Wire Range	Phase	Amps	Cabinet Size	Hub Opening	Unit Wt.	Std Pkg.	UL
C	T1240UL	(2) 2-600, (3) 6-350	1	400	16 x 29	Y ²	28	1	Y ¹

¹ cULus approved.

² Non-standard/Universal hub opening. Hub no longer furnished. Will accept U40 only – order separately. Consult Manufacturer.

AC, 100 – 400 Amps, 600V Max

Fig.	Model Number	Wire Range	Phase	Amps	Cabinet Size	Hub Opening	Unit Wt.	Std Pkg.	UL
B	T3610	(5) 14-1/0	3	100	9 x 17	Y	12	1	Y ¹
B	T3620	(3) 1/0-250, (3) 12-1/0		200	14 x 21		19		
D	T3640UL	(2) 2-600, (3) 6-350		400	16 x 29	Y ²	29		

¹ cULus approved.

² Non-standard/Universal hub opening. Hub no longer furnished. Will accept U40 only – order separately. Consult Manufacturer.

Technical Data

Model Number ¹	Replacement Parts Lug Assembly	Lug Cover Kit ³	Number of Bars	Lugs Per Bar	Cabinet Size	Cabinet Dimensions (inches)			Knockout Figure
						Height (A)	Width (B)	Depth (C)	
T1206	NI60B2	TBK100A	3	4	7 x 10	10	7-1/4	4	1
T1210	NI100B2	TBK100A	3	5	9 x 17	17-1/2	9-3/4	3-1/2	2
T1220	NI200	TBK200A	3	6	14 x 21	21-1/2	14-1/2	4-3/4	3
T1240UL	198B8615G1	TBK400A	3	5	16 x 29	29-1/2	16	5	4
T3210	NI100B2	TBK200A	4	5	9 x 17	17-1/2	9-3/4	3-1/2	2
T3220	NI200	TBK100B	4	6	14 x 21	21-1/2	14-1/2	4-3/4	3
T3610	NI100B2	TBK100B	4	5	9 x 17	17-1/2	9-3/4	3-1/2	2
T3620	NI200A5	TBK400A	4	6	14 x 21	21-1/2	14-1/2	4-3/4	3
T3640UL	198B8615G2	TBK400A	4	5	16 x 29	29-1/2	16	5	4

¹ All models include closure plate. Order conduit hub separately.

² Use large style universal hub.

³ Terminal boxes manufactured prior to 2013 can be retrofitted to comply with NEC 314.28 E(4). Order quantity (1) kit per terminal box.

Hubs (Order Separately)

Hub Opening (inches)	Midwest Hub Number	Universal Hub Number	
		Small	Large
3/4	B07	—	—
1	B10	U10	—
1-1/4	B12	U12	—
1-1/2	B15	U15	—
2	B20	U20	U27
2-1/2	B25	U25	U28
3	—	—	U30
3-1/2	—	—	U35
4	—	—	U40
Closure Plate	B01	U01	U04

Enclosure Styles / Cabinet Dimensions

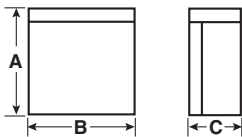

Fig. A

* See model specific dimensions in Technical Data table above.

Knockout Configurations

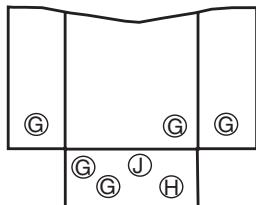

Fig. 1

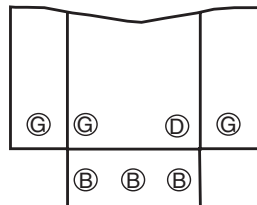

Fig. 2

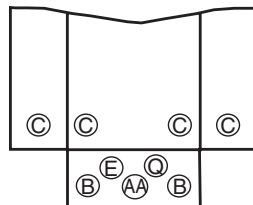

Fig. 3

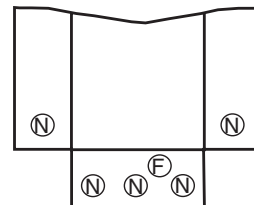

Fig. 4

Knockout Key

- AA = 1-1/2", 2", 2-1/2"
- B = 1", 1-1/4", 1-1/2"
- C = 1-1/4", 1-1/2", 2"
- D = 3/4", 1", 1-1/4"
- E = 3/4"
- F = 1/2", 3/4"
- G = 1/2", 3/4", 1"
- H = 1/2", 3/4", 1", 1-1/4", 1-1/2"
- N = 2", 2-1/2", 3"
- Q = 1"

* Knockouts shown for size not for exact positions.

Section 13

Transformers



Transformers

Our transformers are setting new standards for quality — in design, manufacturing and testing. Before leaving the factory, every Midwest transformer must pass a series of rigorous tests to ensure that you get the highest initial quality and years of trouble-free operation. These tests are performed with advanced equipment on a range of specific requirements.

- **Coil insulation integrity** to ensure high initial quality and years of trouble-free operation
- **Current and loss** to ensure peak efficiency, low noise and lowest operating cost possible
- **Voltage ratio** to ensure that input and output voltage parameters are exactly as specified
- **Impedance** to ensure the transformer is producing power that is friendly to your building and equipment



3-Phase Vented

- 15-500kVA DOE 2016 Efficiency
- General purpose
- K-Factor
- Low temperature rise
- Low noise
- Electronic noise isolation
- Harmonic mitigating
- Drive isolation (DIT)
- Stainless steel enclosure available



1-Phase Vented

- 15-250kVA
- DOE 2016 Efficiency
- Low temperature rise



Enclosed & Encapsulated

- 1-Phase
- 0.05-15kVA
- NEMA 3R



Buck-Boost

- 1-Phase
- 0.05-3kVA
- NEMA 3R



Control Power Core & Coil

- 1-Phase
- Fully encapsulated
- 0.05-3kVA
- Terminal board connection
- Leads out connection

Features and Benefits

DOE 2016 Efficiency Standards

- General Purpose
- K-Factor
- Low Noise
- Guard I & II Noise Isolation Transformer
- Guard III Harmonic Mitigating

Key Features

- Copper or aluminum windings
- Standard NEMA 2 drip-proof enclosure with optional weathershield conversion kit for NEMA 3R outdoor
- NEMA 3R stainless steel (Type 316) enclosure available up to 150kVA
- Lug kit included up to 150kVA
- Copper ground bar kit included
- 200% neutral
- Copper ground strap
- Taps
 - 300kVA and smaller have two 2.5% above nominal and four 2.5% below nominal
 - 500kVA and larger have two 2.5% above nominal and two 2.5% below nominal
- Robust packaging with top and edge protection
- 220°C insulation system
- 40°C ambient
- 10kV BIL

Installation and Service Ease

- Accessible mounting flanges with front/back slotted mounting holes
- Single-piece front/back is easily removable
- Outward facing mounting feet for faster installation

User Safety

- Clear, comprehensive documentation and labeling
- Seismic qualified to the requirements of ASCE 7.05, IEEE-693-2005 and IBC-2006
- Larger interior clearances for easier wiring and enhanced safety



Dry Type Transformers

Midwest Dry Type Transformers are brand contractors trust for trouble-free installation and years of reliable ser-vice. We have a wide array of transformers. The selection guide below will help you choose the correct transformer for some of the most common applications.



Application	General Purpose	K-Factor (K=4)	K-Factor (K=13)	K-Factor (K=20)	K-Factor (K=30)	Low Noise	Drive Isolation
AC or DC variable speed drives							■
Computer installations				■	■		
Critical care facilities				■	■	■	
Data processing equipment circuits				■	■		
HID lighting		■					
Hospital operating rooms				■	■		
Incandescent lighting	■	■					
Induction heaters		■					
Instrumentation				■	■		
Motor generators (without solid state drives)	■	■					
Motors	■	■					
Multiple receptacle circuits in heath care facilities			■				
Office buildings			■			■	
PLC & solid state controls		■					
Production or assembly line equipment			■				
Programmable controllers				■			
Rectifier outputs							■
Resistance heating	■	■					
Schools & classroom facilities			■			■	
SCR variable speed drives				■			
UPS with optional input filtering		■					
UPS without optional input filtering			■				
Welders		■					
X-ray equipment				■			
Technical Data ¹ (MET-028 page numbers)	3-9	10,14,18,20	11,15,18,20	12,16,19,21	13,17,19,21	22-23	24-29

¹ Refer to MET-028 Midwest Dry Type Transformers for additional transformers including Totally Enclosed, Non-ventilated, Midtapped, Buck-Boost Encapsulated, and Open Core and Coil.

General Purpose

1-Phase, DOE 2016 Efficiency, NEMA 2, Taps (+2, -4, 2.5%)

240 x 480 Primary, 120/240 Secondary, 150°C Rise

kVA	Aluminum			Copper		
	Model Number	Accessory Group	Approx. Net Wt.	Model Number	Accessory Group	Approx. Net Wt.
15	9T83W2670	YF171	320	9T83X2570	YF171	350
25	9T83W2671	YF171	320	9T83X2571	YF171	350
37.5	9T83W2672	YF171	320	9T83X2572	YF172	500
50	9T83W2673	YF172	400	9T83X2573	YF173	520
75	9T83W2674	YF174	510	9T83X2574	YF174	635
100	9T83W2675	YF175	900	9T83X2575	YF175	1050
167	9T83W2676	YF176	1360	9T83X2576	YF176	1675
250	9T83W2677	YF177	1700	—	—	—

240 x 480 Primary, 120/240 Secondary, 115°C Rise

kVA	Aluminum			Copper		
	Model Number	Accessory Group	Approx. Net Wt.	Model Number	Accessory Group	Approx. Net Wt.
15	9T83W2670G15	YF171	320	9T83X2570G15	YF171	350
25	9T83W2671G15	YF171	320	9T83X2571G15	YF171	350
37.5	9T83W2672G15	YF172	400	9T83X2572G15	YF172	500
50	9T83W2673G15	YF173	500	9T83X2573G15	YF173	520
75	9T83W2674G15	YF174	510	9T83X2574G15	YF174	635
100	9T83W2675G15	YF175	900	9T83X2575G15	YF175	1050
167	9T83W2676G15	YF176	1360	9T83X2576G15	YF176	1675

240 x 480 Primary, 120/240 Secondary, 80°C Rise

kVA	Aluminum			Copper		
	Model Number	Accessory Group	Approx. Net Wt.	Model Number	Accessory Group	Approx. Net Wt.
15	9T83W2670G80	YF171	320	9T83X2570G80	YF171	350
25	9T83W2671G80	YF171	320	9T83X2571G80	YF171	350
37.5	9T83W2672G80	YF172	400	9T83X2572G80	YF172	500
50	9T83W2673G80	YF174	510	9T83X2573G80	YF174	635
75	9T83W2674G80	YF175	900	9T83X2574G80	YF175	1050
100	9T83W2675G80	YF176	1360	9T83X2575G80	YF176	1675
167	9T83W2676G80	YF177	1700	9T83X2576G80	YF177	1960

General Purpose

3-Phase, DOE 2016 Efficiency, Vented, NEMA 2

480 Primary, 480/277 Secondary, 150°C Rise

kVA	Aluminum		
	Model Number	Accessory Group	Approx. Net Wt.
15	9T10W1171	UX71A	231
30	9T10W1172	UX72A	330
45	9T10W1173	UX73A	444
75	9T10W1174	UY74A	561
112.5	9T10W1175	DY75A	680
150	9T10W1176	DY76A	1030
225	9T10W1177	DY77A	1450
300	9T10W1178	DY78A	1670
500	9T10W1179	DX79A	2900

480 Primary, 208Y/120 Secondary, 150°C Rise

kVA	Aluminum			Copper		
	Model Number	Accessory Group	Approx. Net Wt.	Model Number	Accessory Group	Approx. Net Wt.
15	9T10W1001	UX71A	231	9T10X1001	UX71C	230
30	9T10W1002	UX72A	330	9T10X1002	UX72C	353
45	9T10W1003	UX73A	444	9T10X1003	UX73C	480
75	9T10W1004	UY74A	561	9T10X1004	UY74C	661
112.5	9T10W1005	DY75A	680	9T10X1005	DY75C	790
150	9T10W1006	DY76A	1030	9T10X1006	DY76C	1085
225	9T10W1007	DY77A	1450	9T10X1007	DY77C	1610
300	9T10W1008	DY78A	1670	9T10X1008	DY78C	1970
500	9T10W1009	DX79A	2900	9T10X1009	DX79C	3720

480 Primary, 208Y/120 Secondary, 115°C Rise

kVA	Aluminum			Copper		
	Model Number	Accessory Group	Approx. Net Wt.	Model Number	Accessory Group	Approx. Net Wt.
15	9T10W1001G31	UX71A	231	9T10X1001G31	UX71C	230
30	9T10W1002G31	UX72A	330	9T10X1002G31	UX72C	353
45	9T10W1003G31	UX73A	444	9T10X1003G31	UX73C	480
75	9T10W1004G31	UX74A	603	9T10X1004G31	UX74C	748
112.5	9T10W1005G31	DX75A	830	9T10X1005G31	DX75C	900
150	9T10W1006G31	DX76A	1250	9T10X1006G31	DX76C	1240
225	9T10W1007G31	DX77A	1670	9T10X1007G31	DX77C	1847
300	9T10W1008G31	DX78A	1985	9T10X1008G31	DX78C	2150
500	9T10W1009G31	DX79A	2900	—	—	—

480 Primary, 208Y/120 Secondary, 80°C Rise

kVA	Aluminum			Copper		
	Model Number	Accessory Group	Approx. Net Wt.	Model Number	Accessory Group	Approx. Net Wt.
15	9T10W1001G61	UX72A	330	9T10X1001G61	UX72C	353
30	9T10W1002G61	UX73A	444	9T10X1002G61	UX73C	480
45	9T10W1003G61	UY74A	561	9T10X1003G61	UY74C	661
75	9T10W1004G61	DY75A	680	9T10X1004G61	DY75C	790
112.5	9T10W1005G61	DY76A	1030	9T10X1005G61	DY76C	1085
150	9T10W1006G61	DY77A	1450	9T10X1006G61	DY77C	1610
225	9T10W1007G61	DX78A	1985	9T10X1007G61	DX78C	2150
300	9T10W1008G61	DX79A	2900	9T10X1008G61	DX79C	3720

Data subject to change without notice.

General Purpose

3-Phase, Vented, DOE 2016 Efficiency, NEMA 2

480 Primary, 240/120 Secondary, 150°C Rise

kVA	Aluminum		
	Model Number	Accessory Group	Approx. Net Wt.
15	9T10W1181	UX71A	231
30	9T10W1182	UX72A	330
45	9T10W1183	UX73A	444
75	9T10W1184	UY74A	561
112.5	9T10W1185	DX75A	830
150	9T10W1186	DY76A	1030
225	9T10W1187	DY77A	1450
300	9T10W1188	DY78A	1670
500	9T10W1189	DX79A	2900

480 Primary, 240 Secondary, 150°C Rise

kVA	Copper		
	Model Number	Accessory Group	Approx. Net Wt.
15	9T10X1191	UX71C	230
30	9T10X1192	UX72C	353
45	9T10X1193	UX73C	480
75	9T10X1194	UY74C	661
112.5	9T10X1195	DY75C	790
150	9T10X1196	DY76C	1085
225	9T10X1197	DY77C	1610
300	9T10X1198	DY78C	1970
500	9T10X1199	DX79C	3720

240 Primary, 480/277 Secondary, 150°C Rise

kVA	Aluminum		
	Model Number	Accessory Group	Approx. Net Wt.
15	9T10W1531	UX71A	231
30	9T10W1532	UX72A	330
45	9T10W1533	UX73A	444
75	9T10W1534	UY74A	561
112.5	9T10W1535	DY75A	680
150	9T10W1536	DY76A	1030
225	9T10W1537	DY77A	1450
300	9T10W1538	DY78A	1670
500	9T10W1539	DX79A	2900

240 Primary, 208Y/120 Secondary, 150°C Rise

kVA	Aluminum		
	Model Number	Accessory Group	Approx. Net Wt.
15	9T10W1611	UX71A	231
30	9T10W1612	UX72A	330
45	9T10W1613	UX73A	444
75	9T10W1614	UY74A	561
112.5	9T10W1615	DY75A	680
150	9T10W1616	DY76A	1030
225	9T10W1617	DY77A	1450
300	9T10W1618	DY78A	1670
500	9T10W1619	DX79A	2900

208 Primary, 480/277 Secondary, 150°C Rise

kVA	Aluminum		
	Model Number	Accessory Group	Approx. Net Wt.
15	9T10W1341	UX71A	231
30	9T10W1342	UX72A	330
45	9T10W1343	UY74A	561
75	9T10W1344	DY75A	680
112.5	9T10W1345	DY76A	1030
150	9T10W1346	DX76A	1250
225	9T10W1347	DY78A	1670
300	9T10W1348	DX79A	2900

208 Primary, 208Y/120 Secondary, 150°C Rise

kVA	Aluminum		
	Model Number	Accessory Group	Approx. Net Wt.
15	9T10W1451	UX71A	231
30	9T10W1452	UX72A	330
45	9T10W1453	UY74A	561
75	9T10W1454	DY75A	680
112.5	9T10W1455	DY76A	1030
150	9T10W1456	DX76A	1250
225	9T10W1457	DY78A	1670
300	9T10W1458	DX79A	2900

600 Primary, 208Y/120 Secondary, 150°C Rise

kVA	Copper		
	Model Number	Accessory Group	Approx. Net Wt.
15	9T10X2401	UX71C	230
30	9T10X2402	UX72C	353
45	9T10X2403	UX73C	480
75	9T10X2404	UY74C	661
112.5	9T10X2405	DY75C	790
150	9T10X2406	DY76C	1085
225	9T10X2407	DY77C	1610
300	9T10X2408	DY78C	1970
500	9T10X2409	DX79C	3720

Data subject to change without notice.

K-Factor

3-Phase, K=4, DOE 2016 Efficiency

480 Primary, 208Y/120 Secondary, 150°C Rise

kVA	Aluminum			Copper		
	Model Number	Accessory Group	Approx. Net Wt.	Model Number	Accessory Group	Approx. Net Wt.
15	9T14W1001G03	UX71A	231	9T14X1001G03	UX71C	230
30	9T14W1002G03	UX73A	444	9T14X1002G03	UX72C	353
45	9T14W1003G03	UX73A	444	9T14X1003G03	UX73C	480
75	9T14W1004G03	DY75A	603	9T14X1004G03	DY74C	661
112.5	9T14W1005G03	DY76A	1030	9T14X1005G03	DY75C	790
150	9T14W1006G03	DX76A	1250	9T14X1006G03	DY77C	1610
225	9T14W1007G03	DY78A	1670	9T14X1007G03	DX77C	1847
300	9T14W1008G03	DX79A	2900	9T14X1008G03	DX79C	3720

480 Primary, 208Y/120 Secondary, 115°C Rise

kVA	Aluminum			Copper		
	Model Number	Accessory Group	Approx. Net Wt.	Model Number	Accessory Group	Approx. Net Wt.
15	9T14W1001G33	UX71A	231	9T14X1001G33	UX72C	353
30	9T14W1002G33	UX73A	444	9T14X1002G33	UX73C	480
45	9T14W1003G33	UY74A	561	9T14X1003G33	UY74C	661
75	9T14W1004G33	DY75A	680	9T14X1004G33	UX74C	748
112.5	9T14W1005G33	DY76A	1250	9T14X1005G33	DX75C	900
150	9T14W1006G33	DX76A	1250	9T14X1006G33	DY77C	1610
225	9T14W1007G33	DY78A	1670	9T14X1007G33	DX78C	2150
300	9T14W1008G33	DX79A	2900	9T14X1008G33	DX79C	3720
500	—	—	—	9T14X1009G33	Call Tech Supp	Call Tech Supp

480 Primary, 208Y/120 Secondary, 80°C Rise

kVA	Aluminum			Copper		
	Model Number	Accessory Group	Approx. Net Wt.	Model Number	Accessory Group	Approx. Net Wt.
15	9T14W1001G63	UX72A	330	9T14X1001G63	UX72C	353
30	9T14W1002G63	UX73A	444	9T14X1002G63	UX73C	480
45	9T14W1003G63	UY74A	561	9T14X1003G63	UY74C	661
75	9T14W1004G63	DX75A	830	9T14X1004G63	DY75C	790
112.5	9T14W1005G63	DX76A	1250	9T14X1005G63	DY76C	1085
150	9T14W1006G63	DX77A	1670	9T14X1006G63	DX77C	1610
225	9T14W1007G63	DY78A	1985	9T14X1007G63	DX78C	2150
500	—	—	—	9T14X1008G63	DX79C	3720

K-Factor

3-Phase, K=13, DOE 2016 Efficiency

480 Primary, 208Y/120 Secondary, 150°C Rise

kVA	Aluminum			Copper		
	Model Number	Accessory Group	Approx. Net Wt.	Model Number	Accessory Group	Approx. Net Wt.
15	9T11W1001G03	UX71A	231	9T11X1001G03	UX71C	230
30	9T11W1002G03	UX73A	444	9T11X1002G03	UX72C	353
45	9T11W1003G03	UX73A	444	9T11X1003G03	UX73C	480
75	9T11W1004G03	UX74A	603	9T11X1004G03	DY75C	790
112.5	9T11W1005G03	DY76A	1030	9T11X1005G03	DY75C	790
150	9T11W1006G03	DX76A	1250	9T11X1006G03	DY77C	1610
225	9T11W1007G03	DY78A	1670	9T11X1007G03	DX78C	2150
300	9T11W1008G03	DX79A	2900	9T11X1008G03	DX79C	3720

480 Primary, 208Y/120 Secondary, 115°C Rise

kVA	Aluminum			Copper		
	Model Number	Accessory Group	Approx. Net Wt.	Model Number	Accessory Group	Approx. Net Wt.
15	9T11W1001G33	UX71A	231	9T11X1001G33	UX72C	353
30	9T11W1002G33	UX73A	444	9T11X1002G33	UX73C	480
45	9T11W1003G33	UY74A	561	9T11X1003G33	UY74C	661
75	9T11W1004G33	DY75A	680	9T11X1004G33	DY75C	790
112.5	9T11W1005G33	DX76A	1250	9T11X1005G33	DY76C	1085
150	9T11W1006G33	DY77A	1450	9T11X1006G33	DY77C	1610
225	9T11W1007G33	DY78A	1670	9T11X1007G33	DX79C	3270
300	9T11W1008G33	DX79A	2900	9T11X1008G33	DX79C	3720
500	—	—	—	9T11X1009G33	Call Tech Supp	Call Tech Supp

480 Primary, 208Y/120 Secondary, 80°C Rise

kVA	Aluminum			Copper		
	Model Number	Accessory Group	Approx. Net Wt.	Model Number	Accessory Group	Approx. Net Wt.
15	9T11W1001G63	UX72A	330	9T11X1001G63	UX72C	353
30	9T11W1002G63	UY74A	561	9T11X1002G63	UX73C	480
45	9T11W1003G63	UY74A	561	9T11X1003G63	UY74C	661
75	9T11W1004G63	DX75A	830	9T11X1004G63	DY75C	790
112.5	9T11W1005G63	DX77A	1670	9T11X1005G63	DY76C	1085
150	9T11W1006G63	DY78A	1670	9T11X1006G63	DY77C	1610
225	9T11W1007G63	DX79A	2900	9T11X1007G63	DX79C	3720
500	—	—	—	9T11X1008G63	Call Tech Supp	Call Tech Supp

K-Factor Low Noise

3-Phase, K=4, DOE 2016 Efficiency, -3dB Below NEMA ST-20 Standard

480 Primary, 208Y/120 Secondary, 150°C Rise

kVA	Aluminum			Copper		
	Model Number	Accessory Group	Approx. Net Wt.	Model Number	Accessory Group	Approx. Net Wt.
15	9T14W1001G04	UX71A	231	9T14X1001G04	UX71C	230
30	9T14W1002G04	UX73A	444	9T14X1002G04	UX73C	353
45	9T14W1003G04	UX73A	444	9T14X1003G04	UX73C	480
75	9T14W1004G04	UX74A	603	9T14X1004G04	UX74C	661
112.5	9T14W1005G04	DY76A	1030	9T14X1005G04	DY75C	790
150	9T14W1006G04	DX76A	1250	9T14X1006G04	DY77C	1610
225	9T14W1007G04	DY78A	1670	9T14X1007G04	DY78C	1970
300	9T14W1008G04	DX79A	2900	9T14X1008G04	DX79C	3720

480 Primary, 208Y/120 Secondary, 115°C Rise

kVA	Aluminum			Copper		
	Model Number	Accessory Group	Approx. Net Wt.	Model Number	Accessory Group	Approx. Net Wt.
15	9T14W1001G34	UX71A	231	9T14X1001G34	UX72C	353
30	9T14W1002G34	UX73A	444	9T14X1002G34	UX72C	353
45	9T14W1003G34	UY74A	561	9T14X1003G34	UY74C	661
75	9T14W1004G34	DY75A	680	9T14X1004G34	DY75C	790
112.5	9T14W1005G34	DY76A	1030	9T14X1005G34	DX75C	900
150	9T14W1006G34	DX76A	1250	9T14X1006G34	DY77C	1610
225	9T14W1007G34	DY78A	1670	9T14X1007G34	DX78C	2150
300	9T14W1008G34	DX79A	2900	9T14X1008G34	DX79C	3720

480 Primary, 208Y/120 Secondary, 80°C Rise

kVA	Aluminum			Copper		
	Model Number	Accessory Group	Approx. Net Wt.	Model Number	Accessory Group	Approx. Net Wt.
15	9T14W1001G64	UX72A	330	9T14X1001G64	UX72C	353
30	9T14W1002G64	UX73A	444	9T14X1002G64	UX73C	480
45	9T14W1003G64	UY74A	561	9T14X1003G64	UY74C	661
75	9T14W1004G64	DX75A	830	9T14X1004G64	DX75C	790
112.5	9T14W1005G64	DX76A	1250	9T14X1005G64	DX76C	1240
150	9T14W1006G64	DX77A	1670	9T14X1006G64	DX77C	1610
225	9T14W1007G64	DY78A	1670	9T14X1007G64	DX79C	3720
300	9T14W1008G64	DX79A	2900	—	—	—

K-Factor Low Noise

3-Phase, K=13, DOE 2016 Efficiency, -3dB Below NEMA ST-20 Standard

480 Primary, 208Y/120 Secondary, 150°C Rise

kVA	Aluminum			Copper		
	Model Number	Accessory Group	Approx. Net Wt.	Model Number	Accessory Group	Approx. Net Wt.
15	9T11W1001G04	UX71A	231	9T11X1001G04	UX71C	230
30	9T11W1002G04	UX73A	444	9T11X1002G04	UX72C	353
45	9T11W1003G04	UX73A	444	9T11X1003G04	UX73C	480
75	9T11W1004G04	UX74A	603	9T11X1004G04	DY75C	790
112.5	9T11W1005G04	DY76A	1030	9T11X1005G04	DY75C	790
150	9T11W1006G04	DX76A	1250	9T11X1006G04	DY77C	1610
225	9T11W1007G04	DY78A	1670	9T11X1007G04	DY78C	1970
300	9T11W1008G04	DX79A	2900	9T11X1008G04	DX79C	2900

480 Primary, 208Y/120 Secondary, 115°C Rise

kVA	Aluminum			Copper		
	Model Number	Accessory Group	Approx. Net Wt.	Model Number	Accessory Group	Approx. Net Wt.
15	9T11W1001G34	UX71A	231	9T11X1001G34	UX72C	353
30	9T11W1002G34	UX73A	444	9T11X1002G34	UX73C	480
45	9T11W1003G34	UY74A	561	9T11X1003G34	UY74C	661
75	9T11W1004G34	DY75A	680	9T11X1004G34	DY75C	790
112.5	9T11W1005G34	DX76A	1250	9T11X1005G34	DY76C	1085
150	9T11W1006G34	DY77A	1450	9T11X1006G34	DY77C	1610
225	9T11W1007G34	DY78A	1670	9T11X1007G34	DX79C	3720
300	9T11W1008G34	DX79A	2900	9T11X1008G34	DX79C	3720

480 Primary, 208Y/120 Secondary, 80°C Rise

kVA	Aluminum			Copper		
	Model Number	Accessory Group	Approx. Net Wt.	Model Number	Accessory Group	Approx. Net Wt.
15	9T11W1001G64	UX72A	330	9T11X1001G64	UX72C	353
30	9T11W1002G64	UY74A	561	9T11X1002G64	UY74C	661
45	9T11W1003G64	UY74A	561	9T11X1003G64	UY74C	661
75	9T11W1004G64	DY75A	680	9T11X1004G64	DY75C	790
112.5	9T11W1005G64	DX77A	1670	9T11X1005G64	DX76C	1240
150	9T11W1006G64	DY78A	1670	9T11X1006G64	DY77C	1610
225	—	—	—	9T11X1007G64	DX79C	3720

K-Factor Low Noise

3-Phase, K=20, DOE 2016 Efficiency, -3dB Below NEMA ST-20 Standard

480 Primary, 208Y/120 Secondary, 150°C Rise

kVA	Aluminum			Copper		
	Model Number	Accessory Group	Approx. Net Wt.	Model Number	Accessory Group	Approx. Net Wt.
15	9T10W1001G02	UX71A	231	9T10X1001G02	UX71C	230
30	9T10W1002G02	UX72A	330	9T10X1002G02	UX72C	353
45	9T10W1003G02	UX73A	444	9T10X1003G02	UX73C	480
75	9T10W1004G02	UY74A	561	9T10X1004G02	UY74C	661
112.5	9T10W1005G02	DY75A	680	9T10X1005G02	DY75C	790
150	9T10W1006G02	DY76A	1030	9T10X1006G02	DY76C	1085
225	9T10W1007G02	DY77A	1450	9T10X1007G02	DY77C	1610
300	9T10W1008G02	DY78A	1670	9T10X1008G02	DY78C	1970
500	9T10W1009G02	DX79A	2900	9T10X1009G02	DX79C	3720

480 Primary, 208Y/120 Secondary, 115°C Rise

kVA	Aluminum			Copper		
	Model Number	Accessory Group	Approx. Net Wt.	Model Number	Accessory Group	Approx. Net Wt.
15	9T10W1001G32	UX71A	231	9T10X1001G32	UX71C	230
30	9T10W1002G32	UX72A	330	9T10X1002G32	UX72C	353
45	9T10W1003G32	UX73A	444	9T10X1003G32	UX73C	480
75	9T10W1004G32	UX74A	603	9T10X1004G32	UX74C	748
112.5	9T10W1005G32	DX75A	830	9T10X1005G32	DX75C	900
150	9T10W1006G32	DX76A	1250	9T10X1006G32	DX76C	1240
225	9T10W1007G32	DX77A	1670	9T10X1007G32	DX77C	1847
300	9T10W1008G32	DX79A	1985	9T10X1008G32	DX79C	2150
500	9T10W1009G32	DX79A	2900	9T10X1009G32	DX79C	3720

480 Primary, 208Y/120 Secondary, 80°C Rise

kVA	Aluminum			Copper		
	Model Number	Accessory Group	Approx. Net Wt.	Model Number	Accessory Group	Approx. Net Wt.
15	9T10W1001G62	UX72A	330	9T10X1001G62	UX72C	353
30	9T10W1002G62	UX73A	444	9T10X1002G62	UX73C	480
45	9T10W1003G62	UY74A	561	9T10X1003G62	UY74C	661
75	9T10W1004G62	DY75A	680	9T10X1004G62	DY75C	790
112.5	9T10W1005G62	DY76A	1030	9T10X1005G62	DY76C	1085
150	9T10W1006G62	DY77A	1450	9T10X1006G62	DY77C	1610
225	9T10W1007G62	DX78A	1985	9T10X1007G62	DX78C	2150
300	9T10W1008G62	DX79A	2900	9T10X1008G62	DX79C	3720

Noise Isolation

3-Phase, DOE 2016 Efficiency, Guard 1 (Electrostatic Shield)

480 Primary, 208Y/120 Secondary, 150°C Rise

kVA	Aluminum			Copper		
	Model Number	Accessory Group	Approx. Net Wt.	Model Number	Accessory Group	Approx. Net Wt.
15	9T10W1001G03	UX71A	231	9T10X1001G03	UX71C	230
30	9T10W1002G03	UX72A	330	9T10X1002G03	UX72C	353
45	9T10W1003G03	UX73A	444	9T10X1003G03	UX73C	480
75	9T10W1004G03	UY74A	561	9T10X1004G03	UY74C	661
112.5	9T10W1005G03	DY75A	680	9T10X1005G03	DY75C	790
150	9T10W1006G03	DY76A	1030	9T10X1006G03	DY76C	1085
225	9T10W1007G03	DX77A	1450	9T10X1007G03	DY77C	1610
300	9T10W1008G03	DY78A	1670	9T10X1008G03	DY78C	1970
500	9T10W1009G03	DX79A	2900	9T10X1009G03	DX79C	3720

480 Primary, 208Y/120 Secondary, 115°C Rise

kVA	Aluminum			Copper		
	Model Number	Accessory Group	Approx. Net Wt.	Model Number	Accessory Group	Approx. Net Wt.
15	9T10W1001G33	UX71A	231	9T10X1001G33	UX71C	230
30	9T10W1002G33	UX72A	330	9T10X1002G33	UX72C	353
45	9T10W1003G33	UX73A	444	9T10X1003G33	UX73C	480
75	9T10W1004G33	UY74A	603	9T10X1004G33	UX74C	748
112.5	9T10W1005G33	DX75A	830	9T10X1005G33	DX75C	900
150	9T10W1006G33	DX76A	1250	9T10X1006G33	DX76C	1240
225	9T10W1007G33	DX77A	1670	9T10X1007G33	DX77C	1847
300	9T10W1008G33	DX78A	1985	9T10X1008G33	DX78C	2150
500	9T10W1009G33	DX79A	2900	9T10X1009G33	DX79C	3720

480 Primary, 208Y/120 Secondary, 80°C Rise

kVA	Aluminum			Copper		
	Model Number	Accessory Group	Approx. Net Wt.	Model Number	Accessory Group	Approx. Net Wt.
15	9T10W1001G63	UX72A	330	9T10X1001G63	UX72C	353
30	9T10W1002G63	UX73A	444	9T10X1002G63	UX73C	480
45	9T10W1003G63	UY74A	561	9T10X1003G63	UY74C	661
75	9T10W1004G63	DY75A	680	9T10X1004G63	DY75C	790
112.5	9T10W1005G63	DY76A	1030	9T10X1005G63	DY76C	1085
150	9T10W1006G63	DY77A	1450	9T10X1006G63	DY77C	1610
225	9T10W1007G63	DX78A	1985	9T10X1007G63	DX78C	2150
300	9T10W1008G63	DX79A	2900	9T10X1008G63	DX79C	3720

Midtapped

3-Phase, DOE 2016 Efficiency, 60 Hz

480 Primary, 240/120 Secondary, 150°C Rise

kVA	Aluminum			Copper		
	Model Number	Accessory Group	Approx. Net Wt.	Model Number	Accessory Group	Approx. Net Wt.
15	9T10W1181	UX71A	231	9T10X1181	UX71C	230
30	9T10W1182	UX72A	330	9T10X1182	UX72C	353
45	9T10W1183	UX73A	444	9T10X1183	UX73C	480
75	9T10W1184	UY74A	561	9T10X1184	UY74C	661
112.5	9T10W1185	DX75A	830	9T10X1185	DY75C	790
150	9T10W1186	DY76A	1030	9T10X1186	DY76C	1085
225	9T10W1187	DY77A	1450	9T10X1187	DY77C	1610
300	9T10W1188	DY78A	1670	9T10X1188	DY78C	1970
500	9T10W1189	DX79A	2900	9T10X1189	DX79C	3720

480 Primary, 240/120 Secondary, 115°C Rise

kVA	Aluminum			Copper		
	Model Number	Accessory Group	Approx. Net Wt.	Model Number	Accessory Group	Approx. Net Wt.
15	9T10W1181G31	UX71A	231	9T10X1181G31	UX71C	230
30	9T10W1182G31	UX72A	330	9T10X1182G31	UX72C	353
45	9T10W1183G31	UX73A	444	9T10X1183G31	UX73C	480
75	9T10W1184G31	UX74A	603	9T10X1184G31	UX74C	748
112.5	9T10W1185G31	DX75A	830	9T10X1185G31	DX75C	900
150	9T10W1186G31	DX76A	1250	9T10X1186G31	DX76C	1240
225	9T10W1187G31	DX77A	1670	9T10X1187G31	DX77C	1847
300	9T10W1188G31	DX78A	1985	9T10X1188G31	DX78C	2150
500	9T10W1189G31	DX79A	2900	9T10X1189G31	DX79C	3720

480 Primary, 240/120 Secondary, 80°C Rise

kVA	Aluminum			Copper		
	Model Number	Accessory Group	Approx. Net Wt.	Model Number	Accessory Group	Approx. Net Wt.
15	9T10W1181G61	UX72A	330	9T10X1181G61	UX72C	353
30	9T10W1182G61	UX73A	444	9T10X1182G61	UX73C	480
45	9T10W1183G61	UY74A	561	9T10X1183G61	UY74C	661
75	9T10W1184G61	DY75A	680	9T10X1184G61	DY75C	790
150	9T10W1186G61	DY77A	1450	9T10X1185G61	DY76C	1085
225	9T10W1187G61	DX78A	1985	9T10X1186G61	DY77C	1610
300	—	—	—	9T10X1187G61	DX78C	2150
500	—	—	—	9T10X1188G61	DX79C	3720

Accessories and Lugs

1-Phase and 3-Phase

Rainshield Kit

Accessory Group	Model Number
UX71A	9T18W1071G06
UX71C	9T18W1071G06
UX72A	9T18W1072G06
UX72C	9T18W1072G06
UX73A	9T18W1072G06
UX73C	9T18W1072G06
UY74A	9T18W1074G06
UX74A	9T18W1074G06
UY74C	9T18W1074G06
UX74C	9T18W1074G06
DY75A	9T18W1074G06
DY75C	9T18W1074G06
DX75A	9T18W1076G06
DX75C	9T18W1074G06
DY76A	9T18W1076G06
DY76C	9T18W1076G06
DX76A	9T18W1077G06
DX76C	9T18W1076G06
DX77A	9T18W1077G06
DX77C	9T18W1077G06
DY77A	9T18W1077G06
DY77C	9T18W1077G06
DY78C	9T18W1077G06
DY78A	9T18W1077G06
DX78A	9T18W1077G06
DX78C	9T18W1077G06
DX79A	9T18W1079G06
DX79C	9T18W1079G06
YF171	9T18W4317G05
YF172	9T18W4317G06
YF173	9T18W4317G06
YF174	9T18W4317G06
YF175	9T18W4322G77
YF176	9T18W4322G79
YF177	9T18W4322G79

Lug Kit

Accessory Group	Model Number
UX71A	9T18W1071G10
UX71C	9T18W1071G10
UX72A	9T18W1072G10
UX73A	9T18W1072G10
UX72C	9T18W1072G10
UX73C	9T18W1072G10
UY74A	9T18W1074G10
UX74A	9T18W1074G10
UY74C	9T18W1074G10
UX74C	9T18W1074G10
DY75A	9T18W1075G10
DY75C	9T18W1075G10
DX75C	9T18W1075G10
DY76A	9T18W1076G10
DY76C	9T18W1076G10
DX75A	9T18W1076G10
DX76C	9T18W1076G10
DY77A	9T18W1077G10
DY77C	9T18W1077G10
DX76A	9T18W1077G10
DX77A	9T18W1077G10
DX77C	9T18W1077G10
DY78A	9T18W1078G10
DY78C	9T18W1078G10
DX78A	9T18W1078G10
DX78C	9T18W1078G10
DX79A	9T18W1079G10
DX79C	9T18W1079G10
YF171	9T18W7240G02
YF172	9T18W7241G03
YF173	—
YF174	9T18W7240G03
YF175	9T18W7242G07
YF176	9T18W7242G05
YF177	—

Wall Mount Bracket

Accessory Group	Model Number
UX71A	9T18W1071G07
UX71C	9T18W1071G07
UX72A	9T18W1071G07
UX72C	9T18W1071G07
UX73A	9T18W1071G07
UX73C	9T18W1071G07
UX74A	9T18W1074G07
UX74C	9T18W1074G07
UY74A	9T18W1074G07
UY74C	9T18W1074G07
DX75C	9T18W1074G07
DY75A	9T18W1074G07
DY75C	9T18W1074G07
YF171	9T18W5042
YF172	9T18W5043
YF173	9T18W5043
YF174	9T18W5043
YF175	Not available
YF176	Not available
YF177	Not available

Accessories and Lugs

1-Phase and 3-Phase

Bottom Panel

Accessory Group	Model Number
DX76A	9T18W1077G09
DX77A	9T18W1077G09
DX77C	9T18W1077G09
DY77A	9T18W1077G09
DY77C	9T18W1077G09
DX78A	9T18W1078G09
DX78C	9T18W1078G09
DY78A	9T18W1078G09
DY78C	9T18W1078G09
DX79A	9T18W1079G09
DX79C	9T18W1079G09
YF175	9T18W4504G77
YF176	9T18W4504G79
YF177	9T18W4504G79

316 Stainless Steel Rainshield Kit

Accessory Group	Model Number
UX71A	9T18W1171G06
UX71C	9T18W1171G06
UX72A	9T18W1172G06
UX73A	9T18W1172G06
UX72C	9T18W1172G06
UX73C	9T18W1172G06
UY74A	9T18W1174G06
UX74A	9T18W1174G06
UY74C	9T18W1174G06
UX74C	9T18W1174G06
DY75A	9T18W1174G06
DY75C	9T18W1174G06
DX75C	9T18W1174G06
DY76A	9T18W1176G06
DY76C	9T18W1176G06
DX75A	9T18W1176G06
DX76C	9T18W1176G06

Ground Bar Kit

Accessory Group	Model Number
UX71A	9T18W1071G11
UX71C	9T18W1071G11
UX72A	9T18W1071G11
UX73A	9T18W1071G11
UX72C	9T18W1071G11
UX73C	9T18W1071G11
UY74A	9T18W1074G11
UX74A	9T18W1074G11
UY74C	9T18W1074G11
UX74C	9T18W1074G11
DY75A	9T18W1074G11
DY76A	9T18W1074G11
DY75C	9T18W1074G11
DY76C	9T18W1074G11
DX75A	9T18W1074G11
DX75C	9T18W1074G11
DX76C	9T18W1074G11

Accessories and Lugs

1-Phase and 3-Phase

Lug Kit Information, 1-Phase

Accessory Group	Typical Transformer Size	Primary Bus Bar Holes (Qty/Diameter)	Secondary Bus Bar Holes (Qty/Diameter)	Kit Number	Specified Lug Kit					
					Lug Size No. 1			Lug Size No. 2		
					Qty.	Conductor Size	Stud Hole Size	Qty.	Conductor Size	Stud Hole Size
YF171	15/25 kVA (2670/2671)	(2) .406	(2) .406	9T18W7240G02 ¹	8	6 AWG – 250 MCM	5/16	—	—	—
YF171	37.5 kVA (2672)	(2) .563	(2) .563	9T18W7240G02	8	6 AWG – 250 MCM	5/16	—	—	—
YF172	50 kVA (2673)	(2) .563	(2) .563	9T18W7241G03	4	6 AWG – 250 MCM	5/16	4	6 AWG – 350 MCM	3/8
YF174	75 kVA (2674)	(2) .563	(2) .563	9T18W7240G03	12	6 AWG – 250 MCM	5/16	—	—	—
YF175	100 kVA (2675)	(2) .563	(2) .563	9T18W7242G07	12	6 AWG – 350 MCM	3/8	—	—	—
YF176	167 kVA (2676)	(4) .563	(4) .563	9T18W7242G05	8	6 AWG – 350 MCM	3/8	12	4 AWG – 500 MCM	3/8

Lug Kit Information, 3-Phase

Accessory Group	Typical Transformer Size	Primary Bus Bar Holes (Qty/Diameter)	Secondary Bus Bar Holes (Qty/Diameter)	Kit Number	Specified Lug Kit					
					Lug Size No. 1			Lug Size No. 2		
					Qty.	Conductor Size	Stud Hole Size	Qty.	Conductor Size	Stud Hole Size
UX71A/UX71C	15 kVA (001)	(2) .406	(2) .406	9T18W1071G10 ¹	7	14 AWG – 1/0 AWG	1/4	—	—	—
UX72A/UX72C/ UX73A/UX73C	30/45 kVA (002/003)	(2) .406	(2) .406	9T18W1072G10 ¹	7	6 AWG – 250 MCM	5/16	—	—	—
UX74A/UX74C/ UY74A/UY74C	75 kVA (004)	(2) .406	(2) .406	9T18W1074G10	3	6 AWG – 250 MCM	5/16	8	6 AWG – 350 MCM	3/8
DX75C/DY75A/ DY75C	112.5 kVA (005)	(1) .563	(2) .563	9T18W1075G10	11	6 AWG – 350 MCM	3/8	—	—	—
DX75A/DX76C/ DY76A/DY76C	150 kVA (006)	(1) .563	(2) .563	9T18W1076G10	3	6 AWG – 350 MCM	3/8	8	4 AWG – 500 MCM	3/8
DX76A/DX77A/ DX77C/DY77A/ DY77C	225 kVA (007)	(2) .563	(4) .563	9T18W1077G10	22	6 AWG – 350 MCM	3/8	—	—	—
DX78A/DX78C/ DY78A/DY78C	300 kVA (008)	(2) .563	(4) .563	9T18W1078G10	6	6 AWG – 350 MCM	3/8	16	4 AWG – 500 MCM	3/8
DX79A/DX79C	400-500 kVA (009)	(4) .563	(6) .563	9T18W1079G10	9	6 AWG – 350 MCM	3/8	24	4 AWG – 500 MCM	3/8

¹ Proximity of bus bars would prohibit dual lugs per bus bar.

Enclosure Parts

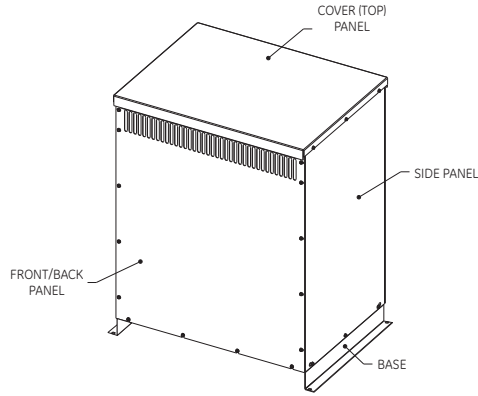

Fig. A

DX75A, DX75C, DY75A, DY75C, DY76A, DY76C, UX71A, UX71C, UX72A, UX72C, UX73A, UX73C, UX74A, UX74C, UY74A, UY74C
Enclosure kit: 1 cover + 2 sides + 2 fronts

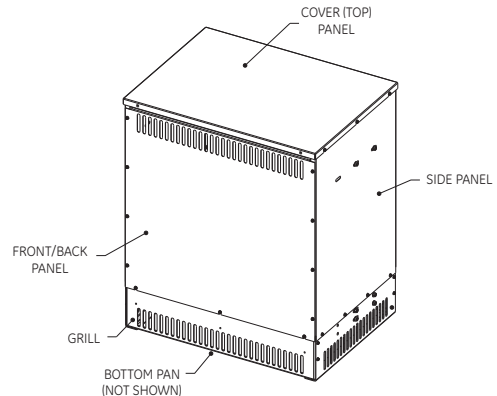

Fig. B

DX76A, DX76C, DX77A, DX77C, DX78A, DX78C, DX79A, DY77A, DY77C, DY78A, DY78C, DY79C
Enclosure kit: 1 cover + 2 sides + 2 fronts

Enclosure Kit

Fig.	Accessory Group	Model Number
A	UX71A	9T18W1071
A	UX72A	9T18W1072
A	UX73A	9T18W1072
A	UX72C	9T18W1072
A	UX73C	9T18W1072
A	UY74A	9T18W1074
A	UX74A	9T18W1074
A	UY74C	9T18W1074
A	UX74C	9T18W1074
A	UX74C	9T18W1074
A	DY75A	9T18W1075
A	DY75C	9T18W1075
A	DX75C	9T18W1075
A	DY76A	9T18W1076
A	DY76C	9T18W1076
A	DX75A	9T18W1076
B	DX76C	9T18W1076
B	DY77A	9T18W1077
B	DY77C	9T18W1077
B	DX76A	9T18W1077
B	DX77A	9T18W1077
B	DX77C	9T18W1077
B	DY78A	9T18W1078
B	DY78C	9T18W1078
B	DX78A	9T18W1078
B	DX78C	9T18W1078
B	DX79A	9T18W1079
B	DY79C	9T18W1079

Cover (Top) Panel

Fig.	Accessory Group	Model Number
A	UX71A	9T18W1071G05
A	UX71C	9T18Y1071G05
A	UX72A	9T18Y1072G05
A	UX73A	9T18Y1072G05
A	UX72C	9T18Y1072G05
A	UX73C	9T18Y1072G05
A	UY74A	9T18Y1074G05
A	UX74A	9T18Y1074G05
A	UY74C	9T18Y1074G05
A	UX74C	9T18Y1074G05
A	DY75A	9T18Y1074G05
A	DY75C	9T18Y1074G05
A	DX75C	9T18Y1074G05
A	DY76A	9T18Y1076G05
A	DY76C	9T18Y1076G05
A	DX75A	9T18Y1076G05
B	DX76C	9T18Y1076G05
B	DY77A	9T18Y1077G05
B	DY77C	9T18Y1077G05
B	DX76A	9T18Y1077G05
B	DX77A	9T18Y1077G05
B	DX77C	9T18Y1077G05
B	DY78A	9T18Y1078G05
B	DY78C	9T18Y1078G05
B	DX78A	9T18Y1078G05
B	DX78C	9T18Y1078G05
B	DX79A	9T18Y1079G05
B	DY79C	9T18Y1079G05

Enclosure Parts

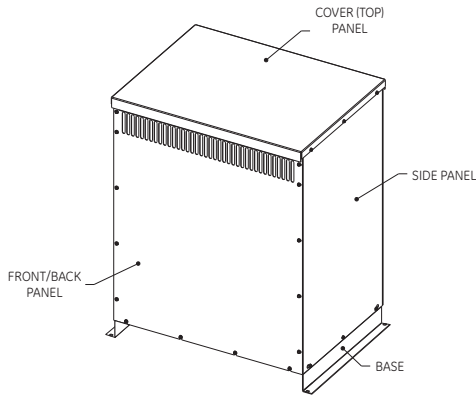

Fig. A

UX71A, UX71C, UX72A, UX72C, UX73A, UX73C, UX74A, UX74C, UY74A, UY74C,
DX75A, DX75C, DY75A, DY75C, DY76A, DY76C
Enclosure kit: 1 cover + 2 sides + 2 fronts

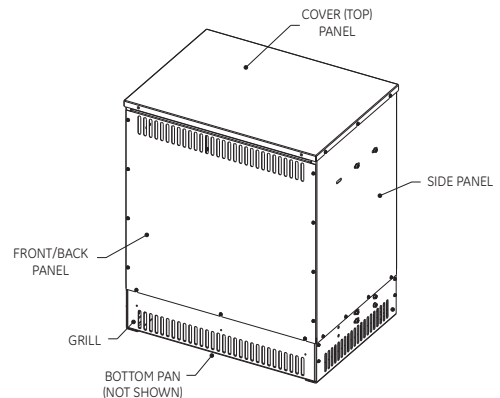

Fig. B

DX75A, DX76A, DX76C, DX77A, DX77C, DX78A, DX78C, DX79A,
DY77A, DY77C, DY78A, DY78C, DY79A,
Enclosure kit: 1 cover + 2 sides + 2 fronts

Front/Back Panel

Fig.	Accessory Group	Model Number
A	UX71A	9T18W1071G03
A	UX71C	9T18W1071G03
A	UX72A	9T18W1072G03
A	UX73A	9T18W1072G03
A	UX72C	9T18W1072G03
A	UX73C	9T18W1072G03
A	UY74A	9T18W1074G03
A	UX74A	9T18W1074G03
A	UY74C	9T18W1074G03
A	UX74C	9T18W1074G03
A	DY75A	9T18W1075G03
A	DY75C	9T18W1075G03
A	DX75C	9T18W1075G03
A	DY76A	9T18W1076G03
A	DY76C	9T18W1076G03
B	DX75A	9T18W1076G03
B	DX76C	9T18W1076G03
B	DY77A	9T18W1077G03
B	DY77C	9T18W1077G03
B	DX76A	9T18W1077G03
B	DX77A	9T18W1077G03
B	DX77C	9T18W1077G03
B	DY78A	9T18W1078G03
B	DY78C	9T18W1078G03
B	DX78A	9T18W1078G03
B	DX78C	9T18W1078G03
B	DX79A	9T18W1079G03
B	DY79C	9T18W1079G03



Side Panel

Fig.	Accessory Group	Model Number
A	UX71A	9T18W1071G04
A	UX71C	9T18W1071G04
A	UX72A	9T18W1072G04
A	UX73A	9T18W1072G04
A	UX72C	9T18W1072G04
A	UX73C	9T18W1072G04
A	UY74A	9T18W1074G04
A	UX74A	9T18W1074G04
A	UY74C	9T18W1074G04
A	UX74C	9T18W1074G04
A	DY75A	9T18W1075G04
A	DY75C	9T18W1075G04
A	DX75C	9T18W1075G04
A	DY76A	9T18W1076G04
A	DY76C	9T18W1076G04
A	DX75A	9T18W1076G04
B	DX76C	9T18W1076G04
B	DY77A	9T18W1077G04
B	DY77C	9T18W1077G04
B	DX76A	9T18W1077G04
B	DX77A	9T18W1077G04
B	DX77C	9T18W1077G04
B	DY78A	9T18W1078G04
B	DY78C	9T18W1078G04
B	DX78A	9T18W1078G04
B	DX78C	9T18W1078G04
B	DX79A	9T18W1079G04
B	DY79C	9T18W1079G04



General Purpose Encapsulated

1-Phase, NEMA 3R, .05 – 3 kVA, Indoor/Outdoor



240 x 480 Primary, 120/240 Secondary, 60 Hz

kVA	Model Number	Unit Wt.	Accessory Group	Taps	UL
.05	9T51W0002	6	6100	No Taps	 
.075	9T51W0003	6	6200		
.1	9T51W0004	6	6200		
.15	9T51W0005	10	8175		
.25	9T51W0007	10	8175		
.5	9T51W0008	16	10200		
.75	9T51W0009	25	12200		
1	9T51W0010	25	12225		
1.5	9T51W0011	40	14200		
2	9T51W0012	45	14250		
3	9T51W0013	55	14350		

480 Primary, 120/240 Secondary, 60 Hz

kVA	Model Number	Unit Wt.	Accessory Group	Taps	UL
1	9T51W0050	25	12225	(-2 5.0%)	 
1.5	9T51W0051	40	14200		
2	9T51W0052	45	14250		
3	9T51W0053	55	14350		
3	9T51W0135	55	14350	(+2,-2 2.5%)	

600 Primary, 120/240 Secondary, 60 Hz



kVA	Model Number	Unit Wt.	Accessory Group	Taps	UL
1	9T51W0070	25	12225	(-2 5.0%)	
1.5	9T51W0071	40	14200		
2	9T51W0072	45	14250		
3	9T51W0073	55	14350		
.05	9T51W0082	6	6100	No Taps	 
.075	9T51W0083	6	6200		
.1	9T51W0084	6	6200		
.15	9T51W0085	10	8175		
.25	9T51W0087	10	8175		
.5	9T51W0088	16	10200		
.75	9T51W0089	25	12200		
1	9T51W0090	25	12225		
1.5	9T51W0091	40	14200		
2	9T51W0092	45	14250		
3	9T51W0093	55	14350		

* For Wiring Diagrams, refer to MET-028.



General Purpose Encapsulated

1-Phase, NEMA 3R, .05 – 3 kVA, Indoor/Outdoor



120 x 240 Primary, 120/240 Secondary, 60 Hz

kVA	Model Number	Unit Wt.	Accessory Group	Taps	UL
.05	9T51W0022	6	6100	No Taps	 
.1	9T51W0024	6	6200		
.15	9T51W0025	10	8175		
.25	9T51W0027	10	8175		
.5	9T51W0028	16	10200		
.75	9T51W0029	25	12200		
1	9T51W0030	25	12225		
1.5	9T51W0031	40	14200		
2	9T51W0032	45	14250		
3	9T51W0033	60	14400		

208 Primary, 120/240 Secondary, 60 Hz

kVA	Model Number	Unit Wt.	Accessory Group	Taps	UL
.5	9T51W0158	16	10200	No Taps	 
.75	9T51W0159	25	12200		
1	9T51W0160	25	12225		
2	9T51W0156	45	14250		
3	9T51W0157	55	14350		

277 Primary, 120/240 Secondary, 60 Hz



kVA	Model Number	Unit Wt.	Accessory Group	Taps	UL
.25	9T51W0187	10	8175	(-2 5.1%)	 
.5	9T51W0188	16	10200		
.75	9T51W0189	25	12200		
1	9T51W0190	30	12275		
1.5	9T51W0191	40	14200		
2	9T51W0192	45	14250		
3	9T51W0193	55	14350		

* For Wiring Diagrams, refer to MET-028.



General Purpose Encapsulated

1-Phase, NEMA 3R, 5 – 25 kVA, Indoor/Outdoor, 115°C Rise



120 x 240 Primary, 120/240 Secondary, 60 Hz

kVA	Model Number	Unit Wt.	Accessory Group	Taps	UL
5	9T21W1001G02	103	16350	No Taps	 
7.5	9T21W1002G02	147	16600		
10	9T21W1003G02	198	19400		
10	9T21W1054G02	198	19400		
15	9T21W9101	220	19500		
15	9T21W9131	233	19550		
25	9T21W9102	233	19550		

208 Primary, 120/240 Secondary, 60 Hz

kVA	Model Number	Unit Wt.	Accessory Group	Taps	UL
5	9T21W1028G02	103	16350	No Taps	 
7.5	9T21W1029G02	147	16600		
10	9T21W1030G02	198	19400		
15	9T21W9119	220	19500		
25	9T21W9120	388	50500		

277 Primary, 120/240 Secondary, 60 Hz



kVA	Model Number	Unit Wt.	Accessory Group	Taps	UL
5	9T21W1046G02	103	16350	(-2 5.1%)	 
5	9T21W1265G02	103	16350	(-2 2.5%)	
7.5	9T21W1047G02	147	16600	(-2 5.1%)	
10	9T21W1048G02	198	19400	(-2 5.1%)	
10	9T21W1266G02	198	19400	(-2 2.5%)	
15	9T21W9143	220	19500	(-2 5.1%)	
25	9T21W9144	388	50500	(-2 4.7%)	

* For Wiring Diagrams, refer to MET-028.



General Purpose Encapsulated

1-Phase, NEMA 3R, 5 – 25 kVA, Indoor/Outdoor, 115°C Rise



240 x 480 Primary, 120/240 Secondary, 60 Hz

kVA	Model Number	Unit Wt.	Accessory Group	Taps	UL
5	9T21W1004G02	103	16350	No Taps	 
7.5	9T21W1005G02	147	16600		
10	9T21W1006G02	198	19400		
15	9T21W9103	220	19500		
25	9T21W9104	388	50500		

480 Primary, 120/240 Secondary, 60 Hz

kVA	Model Number	Unit Wt.	Accessory Group	Taps	UL
5	9T21W1007G02	103	16350	(-2 5.0%)	 
5	9T21W1013G02	103	16350	(+2,-2 2.5%)	
7.5	9T21W1008G02	147	16600	(-2 5.0%)	
7.5	9T21W1014G02	147	16600	(+2,-2 2.5%)	
10	9T21W1009G02	198	19400	(-2 4.9%)	
10	9T21W1015G02	198	19400	(+2,-2 2.6%)	
15	9T21W9105	220	19500	(-2 5.0%)	
15	9T21W9109	220	19500	(+2,-2 2.5%)	
25	9T21W9106	388	50500	(-2 5.0%)	
25	9T21W9110	388	50500	(+2,-2 2.5%)	

600 Primary, 120/240 Secondary, 60 Hz

kVA	Model Number	Unit Wt.	Accessory Group	Taps	UL
5	9T21W1016G02	103	16350	No Taps	 
5	9T21W1019G02	103	16350	(-2 5.0%)	
5	9T21W1025G02	107	16350	(+2,-2 2.5%)	
7.5	9T21W1020G02	147	16600	(-2 5.0%)	
10	9T21W1021G02	198	19400	(-2 4.9%)	
15	9T21W9111	220	19500	No Taps	
15	9T21W9113	220	19500	(-2 4.8%)	
25	9T21W9114	388	50500	(-2 5.0%)	

* For Wiring Diagrams, refer to MET-028.

Buck-Boost Encapsulated

Buck-boost transformers are small, single-phase, dry type distribution transformers designed and shipped as insulating/isolating transformers. They have a dual voltage primary and a dual voltage secondary. These transformers can be connected for a wide range of voltage combinations. The most common use is to buck (lower) or boost (raise) the supply voltage a small amount, usually 5 to 27%. Buck-boost transformers comply with NEC Article 210-9, Exception 1, when field connected as an autotransformer.

Midwest bucking and boosting transformers provide an economical and convenient means for bucking or boosting voltage, usually no more than $\pm 20\%$ on single- and three-phase circuits. They are compact, relatively light in weight, and can be easily installed for indoor or outdoor service.

Buck-boost transformers are employed primarily for boosting single- and three-phase circuits by connecting them as autotransformers. When connected as an autotransformer, only the low-voltage, high-current capacity secondary windings are required to carry the load. Because this load is only transformed over a small change in voltage, the buck-boost transformer can handle loads many times its nameplate kVA rating.

The transformers with series-multiple 12/24, 24/48, or 16/32 Volt secondary windings are suitable for a wide variety of applications. Two or more units can be used in various combinations to obtain many other special voltages.



Indoor/Outdoor Type Buck-Boost Transformer,
1-Phase

Key Features

- Convenient and least expensive method of matching line voltage with equipment voltage
- More efficient than equivalent isolation transformers
- Ability to handle loads up to 20 times nameplate rating when connected as an autotransformer
- Ideal for changing line voltages by small amounts
- Primary voltages include 120V, 240V and 480V
- Secondary voltages include 12V, 16V, 24V, 32V, 48V
- Qualified to the seismic requirements of IEEE 693-1997 and IBC-2003
- Efficient insulating materials permit compact size and light weight
- For maximum versatility has dual voltage primary and dual voltage secondary

Installation and Service Ease

- Large, front-accessible wiring compartment permits fast, easy wiring
- Convenient conduit knockouts located on side, bottom and back of wiring compartment
- Many Midwest buck-boost transformers fit competitor mounting footprints
- Indoor or outdoor service

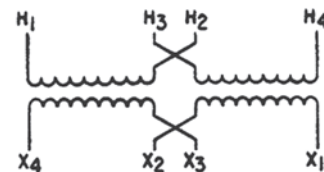

Wiring Diagram for Low Voltage Loads

Buck-Boost Encapsulated

1-Phase, Indoor/Outdoor, For Bucking and Boosting Voltage



1-Phase Wiring Diagram



3-Phase Wiring Diagram

240/120 Primary, 120 or 240/120 Secondary, 3 wire, 60 Hz

kVA	Model Number	Unit Wt.	Accessory Group	Dimensions (inches)			UL
				Height	Width	Depth	
.5	9T51W0136 ¹	10	8175	7-3/8	6-1/8	4-1/4	
.75	9T51W0137 ¹	16	10200	8-3/8	6-7/8	4-7/8	
1	9T51W0138 ¹	16	10200	8-3/8	6-7/8	4-7/8	
1.5	9T51W0139 ¹	25	12200	9-5/8	7-7/8	5-1/2	
2	9T51W0140 ¹	25	12225	9-5/8	7-7/8	5-1/2	
3	9T51W0141 ¹	40	14200	11-1/8	9-3/8	6-3/4	
5	9T51W0142	60	14400	11-1/8	9-3/8	6-3/4	
10 ²	9T21W4553G02	103	16350	14-1/2	10-5/8	11	
15 ²	9T21W9201	147	16600	17	10-5/8	11	
25 ²	9T21W9202	220	19500	17	12-1/2	12-1/2	

208Y/120 Primary, 230/133 Secondary, 60 Hz

kVA ³	Model Number	Unit Wt.	Accessory Group	Dimensions (inches)			UL
				Height	Width	Depth	
6	9T51W0143	10	8175	7-3/8	6-1/8	4-1/4	
9	9T51W0144	16	10200	8-3/8	6-7/8	4-7/8	
15	9T51W0145	20	10225	8-3/8	6-7/8	4-7/8	
30	9T51W0146	30	12275	9-5/8	7-7/8	5-1/2	
45	9T51W0147	40	14200	11-1/8	9-3/8	6-3/4	
75	9T51W0148	60	14400	11-1/8	9-3/8	6-3/4	

208Y/120 Primary, 240/120 Secondary, 60 Hz

kVA ³	Model Number	Unit Wt.	Accessory Group	Dimensions (inches)			UL
				Height	Width	Depth	
6	9T51W0150	10	8175	7-3/8	6-1/8	4-1/4	
15	9T51W0152	25	12200	9-5/8	7-7/8	5-1/2	
30	9T51W0153	40	14200	11-1/8	9-3/8	6-3/4	
45	9T51W0154	45	14250	11-1/8	9-3/8	6-3/4	

¹ CSA Certified.



² kVA output at 120 Volts, 2 wire, or allowable unbalance at 240/120 Volts, 3 wire.

³ Bank of (3) 1-Phase autotransformers to be connected wye. Price is for one single unit. Dimensions and weights are for each unit in bank. Each single autotransformer is rated 1/3 of the bank kVA rating. Order (3) 1-Phase transformers for each 3-Phase bank.

Buck-Boost Encapsulated

1-Phase, Indoor/Outdoor, For Bucking and Boosting Voltage



120/240 Primary, 12/24 Secondary, 60 Hz

kVA	Model Number	Unit Wt.	Accessory Group	Dimensions (inches)			UL
				Height	Width	Depth	
.05	9T51W0102	6	6100	6-3/8	5-1/8	3-1/4	 
.075	9T51W0103	6	6200	6-3/8	5-1/8	3-1/4	
.1	9T51W0104	6	6200	6-3/8	5-1/8	3-1/4	
.15	9T51W0105	10	8175	7-3/8	6-1/8	4-1/4	
.25	9T51W0107	10	8175	7-3/8	6-1/8	4-1/4	
.5	9T51W0108	20	10225	8-3/8	6-7/8	4-7/8	
.75	9T51W0109	25	12200	9-5/8	7-7/8	5-1/2	
1	9T51W0110	25	12225	9-5/8	7-7/8	5-1/2	
1.5	9T51W0111	40	14200	11-1/8	9-3/8	6-3/4	
2	9T51W0112	50	14300	11-1/8	9-3/8	6-3/4	
3	9T51W0113	55	14350	11-1/8	9-3/8	6-3/4	
5	9T21W1037G02	103	16350	14-1/2	10-5/8	11	

120/240 Primary, 16/32 Secondary, 60 Hz

kVA	Model Number	Unit Wt.	Accessory Group	Dimensions (inches)			UL
				Height	Width	Depth	
.05	9T51W0122	6	6100	6-3/8	5-1/8	3-1/4	 
.075	9T51W0123	6	6200	6-3/8	5-1/8	3-1/4	
.1	9T51W0124	6	6200	6-3/8	5-1/8	3-1/4	
.15	9T51W0125	10	8175	7-3/8	6-1/8	4-1/4	
.25	9T51W0127	10	8175	7-3/8	6-1/8	4-1/4	
.5	9T51W0128	20	10225	8-3/8	6-7/8	4-7/8	
.75	9T51W0129	25	12200	9-5/8	7-7/8	5-1/2	
1	9T51W0130	30	12300	9-5/8	7-7/8	5-1/2	
1.5	9T51W0131	40	14200	11-1/8	9-3/8	6-3/4	
2	9T51W0132	50	14300	11-1/8	9-3/8	6-3/4	
3	9T51W0133	55	14350	11-1/8	9-3/8	6-3/4	
5	9T21W1040G02	115	16400	14-1/2	10-5/8	11	

120/480 Primary, 24/48 Secondary, 60 Hz

kVA	Model Number	Unit Wt.	Accessory Group	Dimensions (inches)			UL
				Height	Width	Depth	
.05	9T51W0202	6	6100	6-3/8	5-1/8	3-1/4	 
.075	9T51W0203	6	6200	6-3/8	5-1/8	3-1/4	
.1	9T51W0204	6	6200	6-3/8	5-1/8	3-1/4	
.15	9T51W0205	10	8175	7-3/8	6-1/8	4-1/4	
.25	9T51W0207	10	8175	7-3/8	6-1/8	4-1/4	
.5	9T51W0208	20	10225	8-3/8	6-7/8	4-7/8	
.75	9T51W0209	25	12200	9-5/8	7-7/8	5-1/2	
1	9T51W0210	30	12275	9-5/8	7-7/8	5-1/2	
1.5	9T51W0211	40	14200	11-1/8	9-3/8	6-3/4	
2	9T51W0212	50	14300	11-1/8	9-3/8	6-3/4	
3	9T51W0213	55	14350	11-1/8	9-3/8	6-3/4	

Control Power Core and Coil

Control Power Core and coil transformers are used to provide voltage to control devices in applications where regulation and minimum space are important. Welded cores provide the highest quality electrical performance and quiet operation.

Standards and Listings

- Conforms to NEMA ST20
- UL listed under UL-5085, File E2739
- CSA Certified under C22.2, Number 66, File 3272

Insulation Classes

- 150VA and below
 - 105°C insulation class, 55°C rise
- 200VA and above
 - 185°C (NEMA) 180°C (UL) insulation class, 115°C rise

Frequency

- 60 Hz standard; 50 Hz optional
- Voltage Regulation
 - All designs 2.0kVA and below are compensated for voltage drop
 - Compensation ranges from 10% in the smallest rating to 3% for the largest

Series-Multiple Secondary Connections

- 120/240V secondaries (series-multiple) may be connected for 120V, 240V or 240/120V three-wire

Overcurrent Protection

- Low impedance transformers that require overcurrent protection for most applications
- Provides optional integral primary and/or secondary fusing

Installation and Service Ease

- Lightweight, small and designed for minimum mounting dimensions
- Many transformers fit competitor mounting footprints

User Safety

- Finger-safe terminals offer added protection and safety
- Pressure plate terminals ensure secure connections
- Wide variety of fusing options

Key Features – Terminal Board Connection

- Rugged, high-impact plastic terminal board
- Full head #8 brass screws assure quick, easy terminations with maximum connection integrity
- Copper windings
- Flexible design allows input or output voltage to match any application
- Available fuse-blocks offer simple, low-cost fusing



Terminal Board Connection





Leads Out Connection



Control Power Core and Coil

1-Phase, Fully Encapsulated, Terminal Board Connection



**240 x 440 / 230 x 460 / 240 x 480 Primary,
110/115/120 Secondary, 60 Hz**

kVA	Model Number	Unit Wt.	Accessory Group	UL
.05	9T58W0042	2.4	6100	 
.08	9T58W0043	2.8	6125	
.1	9T58W0044	3.6	8100	
.15	9T58W0045	5.1	8150	
.2	9T58W0046	5.8	8175	
.25	9T58W0047	6.5	8200	
.3	9T58W0048	7.6	8250	
.38	9T58W0049	7.6	8250	
.5	9T58W0050	10.7	10225	
.75	9T58W0051	12	12225	
1	9T58W0052	16.1	12300	
2	9T58W0053	26.7	14225	
2	9T58W0054	32.7	14300	
3	9T58W0055	47.4	14475	

208/277/380 Primary, 115/95 Secondary, 50/60 Hz

kVA	Model Number	Unit Wt.	Accessory Group	UL
.05	9T58W0082	3.1	6150	 
.08	9T58W0083	3.6	8100	
.1	9T58W0084	5.1	8150	
.15	9T58W0085	6.5	8200	
.2	9T58W0086	6.5	8200	
.25	9T58W0087	7.6	8250	
.3	9T58W0088	10.7	10225	
.38	9T58W0089	10.7	10225	
.5	9T58W0090	10.7	10225	
.75	9T58W0091	16.1	12300	
1	9T58W0092	26.7	14225	
1.5	9T58W0093	32.7	14300	
2	9T58W0094	47.4	14475	

230/460/575 Primary, 115/95 Secondary, 50/60 Hz

kVA	Model Number	Unit Wt.	Accessory Group	UL
.05	9T58W0062	3.1	6150	 
.08	9T58W0063	3.6	8100	
.1	9T58W0064	5.1	8150	
.15	9T58W0065	6.5	8200	
.2	9T58W0066	6.5	8200	
.25	9T58W0067	7.6	8250	
.3	9T58W0068	10.7	10225	
.38	9T58W0069	10.7	10225	
.5	9T58W0070	10.7	10225	
.75	9T58W0071	16.1	12300	
1	9T58W0072	26.7	14225	
1.5	9T58W0073	32.7	14300	
2	9T58W0074	47.4	14475	

* For Wiring Diagrams, refer to MET-028.

Control Power Core and Coil

1-Phase, Fully Encapsulated, Terminal Board Connection

240 x 280 Primary, 120/240 Secondary, 60 Hz

kVA	Model Number	Unit Wt.	Accessory Group	UL
.05	9T58W2802	2.4	6100	
.08	9T58W2803	2.8	6125	
.1	9T58W2804	3.6	8100	
.15	9T58W2805	5.1	8150	
.2	9T58W2806	5.8	8175	
.25	9T58W2807	6.5	8200	
.3	9T58W2808	6.5	8200	
.38	9T58W2809	7.6	8250	
.5	9T58W2810	10.7	10225	
.75	9T58W2811	12	12225	
1	9T58W2812	16.1	12300	
1.5	9T58W2813	26.7	14225	
2	9T58W2814	32.7	14300	
3	9T58W2815	47.4	14475	

120 x 240 Primary, 12/24 Secondary, 60 Hz

kVA	Model Number	Unit Wt.	Accessory Group	UL
.05	9T58W2873	2.4	6100	
.075	9T58W2874	2.8	6125	
.1	9T58W2875	3.6	8100	
.15	9T58W2876	5.1	8150	
.2	9T58W2877	5.8	8175	
.25	9T58W2878	6.5	8200	
.3	9T58W2879	6.5	8200	

240 x 480 Primary, 12/24 Secondary, 60 Hz

kVA	Model Number	Unit Wt.	Accessory Group	UL
.25	9T58W3024	6.5	8200	
.05	9T58W3164	2.4	6100	
.1	9T58W4132	3.6	8100	
.15	9T58W4133	5.1	8150	

600 Primary, 120/240 Secondary, 60 Hz

kVA	Model Number	Unit Wt.	Accessory Group	UL
.08	9T58W2823	2.8	6125	
.1	9T58W2824	3.6	8100	
.2	9T58W2826	5.8	8175	
.25	9T58W2827	6.5	8200	
.3	9T58W2828	6.5	8200	
.5	9T58W2830	10.7	10225	
.75	9T58W2831	12	12225	
1	9T58W2832	16.1	12300	
1.5	9T58W2833	26.7	14225	
2	9T58W2834	32.7	14300	
3	9T58W2835	47.4	14475	

208 x 240 Primary, 12/24 Secondary, 60 Hz

kVA	Model Number	Unit Wt.	Accessory Group	UL
.05	9T58W4050	2.4	6100	
.1	9T58W4051	3.6	8100	
.15	9T58W4052	5.1	8150	
.25	9T58W4053	6.5	8200	

380/400/416 Primary, 115/230 Secondary, 50/60 Hz

kVA	Model Number	Unit Wt.	Accessory Group	UL
.25	9T58W2975	6.5	8200	
.5	9T58W2978	10.7	10225	
.75	9T58W2979	16.1	12300	
1	9T58W2980	26.7	14225	
1.5	9T58W2981	32.7	14300	
2	9T58W2982	47.4	14475	
3	9T58W2983	47.4	14475	

120 x 240 Primary, 120/240 Secondary, 60 Hz



kVA	Model Number	Unit Wt.	Accessory Group	UL
.1	9T58W2907	3.6	8100	
.2	9T58W2909	5.8	8175	
.3	9T58W2911	6.5	8200	
.5	9T58W2913	10.7	10225	
.75	9T58W2914	12	12225	
1	9T58W2915	16.1	12300	
2	9T58W2917	32.7	14300	
3	9T58W2918	47.4	14475	

* For Wiring Diagrams, refer to MET-028.



Control Power Core and Coil

1-Phase, Fully Encapsulated, Leads Out Connection



120 x 240 Primary, 120/240 Secondary¹, 60 Hz

kVA	Model Number	Unit Wt.	Accessory Group	UL
.05	9T58W1873G07	2.4	6100	 
.075	9T58W1874G07	2.8	6125	
.1	9T58W1875G07	3.6	8100	
.15	9T58W1876G07	5.1	8150	
.2	9T58W1877G07	5.8	8175	
.25	9T58W1878G07	6.5	8200	
.3	9T58W1879G07	6.5	8200	
.5	9T58W1881G07	10.7	10225	
.75	9T58W1882G07	12	12225	
1	9T58W1883G07	26.7	14225	



600 Primary, 120/240 Secondary¹, 60 Hz

kVA	Model Number	Unit Wt.	Accessory Group	UL
0.1	9T58W1824G07	3.6	8100	 
0.2	9T58W1826G07	5.8	8175	
0.3	9T58W1828G07	6.5	8200	
0.5	9T58W1830G07	10.7	10225	
1	9T58W1832G07	26.7	14225	
2	9T58W1834G07	32.7	14300	
3	9T58W1835G07	47.4	14475	

380/400/416 Primary, 115/230 Secondary¹, 50/60 Hz

kVA	Model Number	Unit Wt.	Accessory Group	UL
.5	9T58W1978G07	10.7	10225	 
.75	9T58W1979G07	16.1	12300	
1	9T58W1980G07	26.7	14225	
1.5	9T58W1981G07	32.7	14300	

240 x 480 Primary, 120/240 Secondary¹, 60 Hz

kVA	Model Number	Unit Wt.	Accessory Group	UL
.05	9T58W1802G07	2.4	6100	 
.075	9T58W1803G07	2.8	6125	
.1	9T58W1804G07	3.6	8100	
.15	9T58W1805G07	5.1	8150	
.2	9T58W1806G07	5.8	8175	
.25	9T58W1807G07	6.5	8200	
.3	9T58W1808G07	6.5	8200	
.375	9T58W1809G07	7.6	8250	
.5	9T58W1810G07	10.7	10225	
.75	9T58W1811G07	12	12225	
1	9T58W1812G07	16.1	12300	
1.5	9T58W1813G07	26.7	14225	
2	9T58W1814G07	32.7	14300	
3	9T58W1815G07	47.4	14475	

¹ Secondary fusing not available.

* For Wiring Diagrams, refer to MET-028.

Terminal Strip Connection

Universal Voltage, Multitap, 50/60 Hz

kVA	Model Number	Accessory Group
.25	9T58W3715	10225
.35	9T58W3716	10225
.5	9T58W3717	12225
.75	9T58W3718	12300
1	9T58W3719	14225
1.5	9T58W3720	14300
2	9T58W3721	14475

Voltage

Incoming Voltage				Output Voltage		
H1 H2	H1 H3	H1 H4	H1 H5	X1 X2	X1 X3	X1 X4
208	—	—	500	85	100	110
—	—	415	—	86	104	113
220	380	440	550	91	110	120
230	40	460	575	95	115	125
240	416	480	600	99	120	130

Data subject to change without notice.

Fusing Options

Control Power Core and Coil Transformer Options

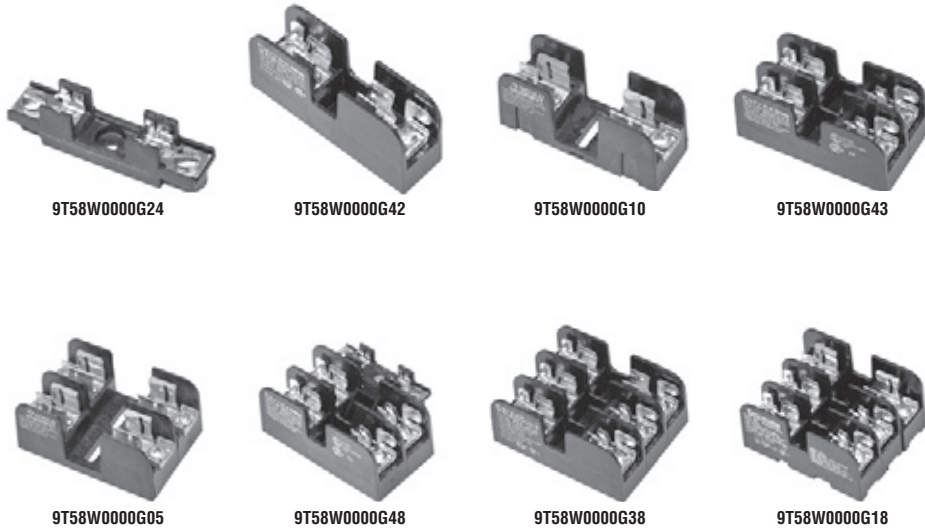

Model Number	Accessory Description
9T58W0000G24	(1) Quarter-Inch Fuseholder
9T58W0000G42	(1) Midget Fuseholder
9T58W0000G10	(1) H/K Fuseholder
9T58W0000G43	(2) CC Fuseholder
9T58W0000G05	(2) H/K Fuseholder
9T58W0000G48	(2) CC + (1) Quarter-Inch Fuseholder
9T58W0000G38	(2) CC + (1) Midget Fuseholder
9T58W0000G18	(2) CC + (1) H/K Fuseholder
9T58W0000G46	(2) CC Fuseholder
9T58W0000G47	(2) CC + (1) Midget Fuseholder
9T58W0000G01	Jumper Links

Fusing Options

Fuse Guide

Midget Class CC Rejection Fuse

Primary Voltage	Transformer Continuous Power Rating (VA)								
	Fuse Rating (Amperes)								
	50	75	100	150	200	250	300	375	500
100	1.50	2.00	3.00	4.00	3.00	4.00	5.00	6.00	8.00
110	1.25	2.00	2.50	4.00	5.00	3.00	4.00	5.00	7.00
120	1.25	1.60	2.50	3.00	5.00	3.00	4.00	5.00	6.00
200	0.75	1.00	1.50	2.00	3.00	3.00	4.00	5.00	4.00
208	0.60	1.00	1.25	2.00	2.50	3.00	4.00	5.00	4.00
220	0.60	1.00	1.25	2.00	2.50	3.00	4.00	5.00	3.00
230	0.60	0.80	1.25	1.60	2.50	3.00	3.00	4.00	3.00
240	0.60	0.80	1.25	1.60	2.50	3.00	3.00	4.00	3.00
277	0.50	0.80	1.00	1.60	2.00	2.50	3.00	4.00	5.00
380	0.30	0.50	0.75	1.00	1.50	1.60	2.00	2.50	3.00
400	0.30	0.50	0.75	1.00	1.50	1.60	2.00	2.50	3.00
416	0.30	0.50	0.60	1.00	1.25	1.60	2.00	2.50	3.00
440	0.30	0.50	0.60	1.00	1.25	1.60	2.00	2.50	3.00
460	0.30	0.40	0.60	0.80	1.25	1.60	1.60	2.00	3.00
480	0.30	0.40	0.60	0.80	1.25	1.50	1.60	2.00	3.00
550	0.25	0.40	0.50	0.80	1.00	1.25	1.60	2.00	2.50
575	0.25	0.30	0.50	0.75	1.00	1.25	1.50	1.60	2.50
600	0.25	0.30	0.50	0.75	1.00	1.25	1.50	1.60	2.50

Secondary Fuse Selection, Glass Fuse

Secondary Voltage	Transformer Continuous Power Rating (VA)													
	Fuse Rating (Amperes)													
	50	75	100	150	200	250	300	375	500	750	1000	1500	2000	3000
12	6.00	10.00	12.00	15.00	20.00	25.00	30.00	—	—	—	—	—	—	—
24	3.00	5.00	6.00	10.00	12.00	12.00	15.00	—	25.00	—	—	—	—	—
36	2.00	3.00	4.00	6.00	8.00	10.00	12.00	—	15.00	—	—	—	—	—
48	1.50	2.50	3.00	5.00	6.00	8.00	10.00	12.00	12.00	—	—	—	—	—
95	0.80	1.25	1.60	2.50	3.00	4.00	5.00	6.00	8.00	12.00	15.00	20.00	25.00	—
110	0.75	1.00	1.50	2.00	3.00	3.00	4.00	5.00	7.00	10.00	12.00	20.00	25.00	30.00
115	0.60	1.00	1.25	2.00	2.50	3.00	4.00	5.00	7.00	10.00	12.00	20.00	20.00	30.00
120	0.60	1.00	1.25	2.00	2.50	3.00	4.00	5.00	6.00	10.00	12.00	15.00	20.00	30.00
208	0.40	0.60	0.80	1.00	1.60	2.00	2.00	3.00	4.00	6.00	8.00	12.00	15.00	20.00
220	0.30	0.50	0.75	1.00	1.50	1.60	2.00	2.50	3.00	5.00	7.00	10.00	12.00	20.00
230	0.30	0.50	0.60	1.00	1.25	1.60	2.00	2.50	3.00	5.00	7.00	10.00	12.00	20.00
240	0.30	0.50	0.60	1.00	1.25	1.60	2.00	2.50	3.00	5.00	6.00	10.00	12.00	15.00

Notes

Section 14

Parts/Accessories / Application Data



Temporary Adapters

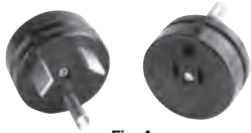







Fig. A
AD2030



Fig. B
AD3020



Fig. C
AD5020

Fig.	Model Number	Description	Symbol	UL
A	AD2030	30 Amp / 125 Volt Plug; 15 Amp / 125 Volt Receptacle	 to 	N
B	AD3020	15 Amp / 125 Volt Plug; 30 Amp / 125 Volt Receptacle	 to 	
C	AD5020	15 Amp / 125 Volt Plug; 50 Amp / 125 Volt Receptacle	 to 	

Receptacles and Angle Plugs

Angle Plugs

- Plugs into receptacles at an angle for increased flexibility in limited space
- Molded of Zytel® Nylon – a rugged, impact resistant material



Wiring	Volts	Amps	NEMA Configuration	Model Number		
				Receptacles ²	Receptacles on Plates	Angle Plugs
2 Pole 3-Wire Grounding	125	20A	5-20R (w/ GFCI)	520R2GFI	—	—
		30A	TT-30R ¹	BR32U	PR32U	C32U
R32U	PR32U			C32U		
3 Pole 3-Wire	125/250	30A	10-30R	BR33	PR33	C33
		50A	10-50R	BR53	PR53	C53
3 Pole 4-Wire Grounding	125/250	30A	14-30R	BR34	PR34	C34
		50A	14-50R	BR54U	PR54U	C54U
		60A	14-60R	BR64U	PR64U	C64U
4 Pole 4-Wire	120/208	60A	18-60R	—	—	C54

¹ Travel Trailer use only.

² "BR" prefix models include base mount bracket - "R" prefix = panel mount.

Post Only (with cover)

Features

- Post only with 3 wire openings (back and both sides)
- Earth burial and pad mounted
- Terminal bar assembly with loop feed lugs standard
- Surface mount units may be field installed on these posts (not UL listed)
- Swing-down hasp (latch) for padlock provision
- Painted 16 gauge galvanized steel

Model Number	Style	Terminal Assembly (factory installed)	Dimensions (inches)		
			Height	Width	Depth
P5POST	Pad Mount	LT200B350	59-1/2	9	4-1/2
P6POST	Earth Burial		83-1/2	9	4-1/2



Data subject to change without notice.

Post Kits



Fig. A
EK126, EK129



Fig. B
MS62

Fig.	Model Number	Style	Kit Components	Dimensions (inches)		
				Height	Width	Depth
A	EK126	Post Extension	(1) Post extension bracket, (2) 1/2" bolts, (2) 1/2" nuts, (4) 1/2" flatwashers	18	6	2
	EK129 ¹			18	9	2
B	MS62	Post Stake	(1) Post stake bracket, (2) 1/2" bolts, (2) 1/2" nuts, (4) 1/2" flatwashers	44	3	1

¹ Add "CW" for WEPCO approved model.

TV/Telephone Add-On

Features

- Bolts on to back of pad mount post, earth burial post or wall at ground level
- Open back and bottom for easy wiring access
- TV/Telephone receptacle may be field replaced with data (Cat5) or other similar feature receptacle
- Includes in use cover



Model Number	Components	Dimensions (inches)			UL
		Height	Width	Depth	
TTV001 ¹	Empty opening at 12" high	18	5	4-1/2	N
TTV001T ^{1,2}					
TTV100 ¹	RJ11 Phone Jack (12" high)				
TTV100T ^{1,2}					
TTV150 ¹	RJ45 Ethernet Connector (12" high)				
TTV150T ^{1,2}					
TTV200	(2) TV/Telephone Openings				

¹ Unit is non-NEMA.

² Unit is used with ParkMate models and tan in color.

Data subject to change without notice.

Raintight (Bolt-on) Hub



Threaded

Hub Opening (inches)	Midwest Hub Number	Universal Hub Number		Std. Pkg.
		Small	Large	
3/4	B07	—	—	10
1	B10	U10	—	
1-1/4	B12	U12	—	
1-1/2	B15	U15	—	
2	B20	U20	U27	
2-1/2	B25	U25	U28	
3	—	—	U30	1
3-1/2	—	—	U35	
4	—	—	U40	
Closure Plate ¹	B01	U01	U04	10

¹ Closure Plate is standard with most Midwest products.

Stabilizer Kits

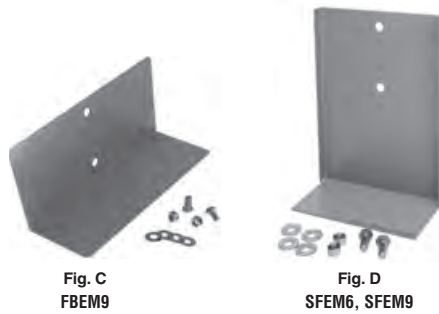

Fig. C
FBEM9

Fig. D
SFEM6, SFEM9

Fig.	Model Number	Style	Wire Install (direction)	Size (inches)
C	FBEM9	Stabilizer Base Kit (Earth Burial Installation)	Back Only	9
D	SFEM6	Stabilizer Foot Kit	Side or Back	6
	SFEM9			9

Top Barrier Kit

Use with Surface Models



Model Number	Description	Size
MSB14T	Isolates load conductors in meter compartment	Fits 14 x 26 surface model

Data subject to change without notice.

Sealing Ring

Use with Ring Type Meter Sockets

Model Number	Style	Type
ASR1	Screw	Aluminum
SNPR1	Snap on	



Meter Socket Cover Plate

Model Number	Style	Type
ARP00920MEP	Screw	Plastic



Circuit Breaker Filler Plates

Model Number	Size (inches)	Type
265A5003P1	1	Metal
265A5003P2	2	

Touch-Up Paint

Model Number	Sherwin-Williams Paint
UHT2-20011	Tan
UGT2-20015	Camo Green
PNS4-C0002	Bronze
PGT2-20042	Gray

* Owner is responsible for purchasing touch-up paint.

Terminal Kit

Model Number	Description
121	5th Terminal Kit

Replacement Deadfront Kit

50 Amp Receptacle Lockout Panel

Model Number	Amps	Kit Components	Cut-out
PLK50	50	Replacement Deadfront and Plate Cover for all U075- or M075- series models	GFCI Duplex

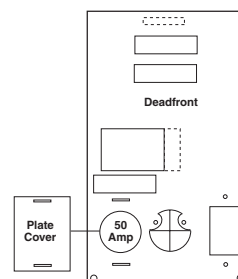

Data subject to change without notice.

Water Shroud

Fig.	Model Number	Color	Description	Dimensions (inches)	
				Height	Width
A	UH60G	Gray	Adapts to 6" wide galvanized steel post	15-1/4	6-3/4
	UH90G	Gray	Adapts to 9" wide galvanized steel post	15-1/4	9-1/2
	UH90GT	Tan		15-1/4	9-1/2
	UH90STL	Stainless		27-1/4	9-1/2



Fig. A
UH60G, UH90G, UH90GT, UH90STL

Water Shroud with TV/Telephone

Fig.	Model Number	Number of Receptacles	Color	Description	Dimensions (inches)	
					Height	Width
A	UH90GTTV1	1	Gray	Adapts to 9" wide galvanized steel post	15-1/4	9-1/2
B	UH90GTTV2	2				



Fig. A
UH90GTTV1



Fig. B
UH90GTTV2

3/4-Turn Hose Bib

Fig.	Model Number	Description	Dimensions (inches)	
			Height	Width
A	UWATER34	Turn knob	2.50	2.13
B	UWATER34L	Lever	2.58	3.87
C	UWATER34WN	Wing nut	2.58	3.87



Fig. A
UWATER34



Fig. B
UWATER34L



Fig. C
UWATER34WN

Meter Kits

Model Number	Description
S-02S-CA20023E	200 Amp Cyclometer California Type Approved Watthour Meter – 240V
S-02S-CA20023LCD	200 Amp Solid State California Type Approved Watthour Meter – 240V
4-GE-727X200001	200 Amp Solid State Watthour Meter – 1PH3W 240V
4-GE-727X100001	100 Amp Solid State Watthour Meter – 1PH2W 120V

Meter Kit Accessories

Model Number	Description
4-PK-BKIT-MIDWEST	BKIT-M = Consists of 4-MS-A4T100R1H1 + 4-MA-HUB1-M + 4-MA-NIP1 + 4-MA-PLSL
4-MS-A4T100R1H1	SKT 4 Term 100A RND 1" 1 Hub
4-MA-HUB1-M	BKIT-M Meter Hub 1"
4-MA-NIP1	BKIT-M Meter Nipple 1"
4-MA-PLSL	BKIT-M Meter Seal Plastic Padlock
4-PK-C1-MIDWEST	CKIT-M = Consists of 4-MS-A4T100R1.25H1 + 4-MA-HUB1.25-M + 4-MA-NIP1.25 + 4-MA-PLSL
4-MS-A4T100R1.25H1	SKT 4 TERM 100A RND 1.25" 1 HUB
4-MA-HUB1.25-M	CKIT-M Meter HUB 1 1/4" Midwest
4-MA-NIP1.25	CKIT-M Meter Nipple 1 1/4"

Data subject to change without notice.

Fuse Holder, Fuse Block, Fuse Block and Pullout 20 – 100 Amps



Fig. A
FH2
 14-20 Cu Only



Fig. B
FH1
 14-20 Cu Only



Fig. C
FH3
 14-10 Cu Only



Fig. D
NF65
 14-3

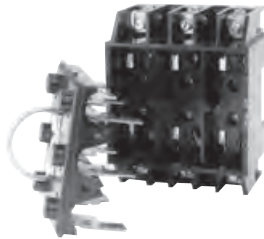

Fig. E
 265A6035G27, 265A6036G69



Fig. F
FR35R

Fuse Holder

Fig.	Model Number	Amps	Wire Range	Description
A	FH2	20	14-10 Cu Only	—
B	FH1	30		
C	FH3	30		

Fuse Block

Fig.	Model Number	Amps	Wire Range	Description
D	NF65	60	14-3 Cu/Al	—

Fuse Block and Pullout

Fig.	Model Number	Amps	Wire Range	Description
E	265A6035G27	30	—	Use for U0353F
E	265A6036G69	60		Use for U0653F
F	FR35R	—		Use for U035F2, FR35R

Pullout, Puller

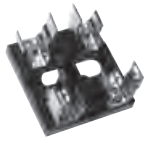

Fig. A
FR352



Fig. B
FR352R

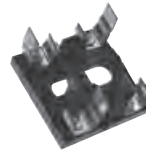

Fig. C
FH682

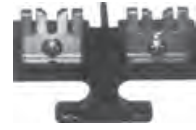

Fig. D
NF652



Fig. E
FR35, FR65
12-3



Fig. F
FR39, FR69
12-3



Fig. G
FR64X2
12-3

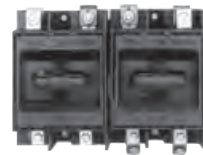

Fig. H
FR65X2
12-3

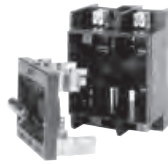

Fig. I
FR66
12-3



Fig. J
FR67
12-3

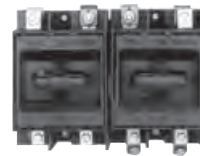

Fig. K
FR67X2
12-1/0

Pullout

Fig.	Model Number	Amps	Wire Range	Description
A	FR352	—	—	Use for P035F, FR35, FR39
B	FR352R			Use for U035F2, FR35R
C	FH682			Use for FR69, FR67, FR66, FR65, FR67X2, FR65X2, FR64X2
D	NF652			Use for NF65

Pullers

Fig.	Model Number	Amps	Wire Range	Description
E	FR35	30	12-3 Cu/Al	—
F	FR39	30		
G	FR64X2	60		
E	FR65	60		
H	FR65X2	60		
I	FR66	60		
J	FR67	60		
F	FR69	60		
K	FR67X2	100	12-1/0 Cu/Al	

Circuit Breakers



Figs. A – E
CB115 / THQL115



Figs. F – E
CB115T / THQP115



Figs. K – O, S – U
CB220 / THQL2120



Figs. P – R
CB220T / THQP220



Figs. V – V2
CB2200B / TQDL or Equivalent



Figs. W – AC
GF115 / THQL1115GFT



Figs. BB – DD, QQ – SS
CB2201 / TQD22200WL



Figs. LL – MM
CBT2201



Figs. EE – GG
CBL2201



Figs. HH – JJ
LCB2201

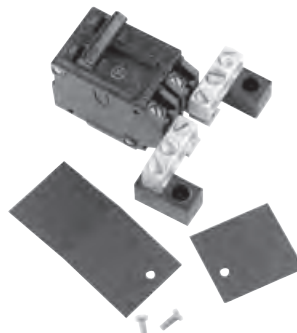

Figs. KK
CBT2102

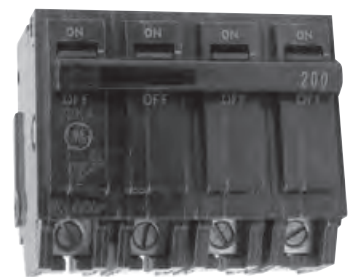

Figs. NN – OO
CB4200H / THQM200WLBP

Circuit Breakers

10kAIC, 15 – 200 Amps, 120/240V

Fig.	Midwest Model Number ¹ (Midwest Circuit Breakers Will Become Obsolete)	New Model Number		Amps	Number of Poles	Circuit Breaker Description
		1" Module	1/2" Module			
Single Pole						
A	CB115	THQL115	—	15	1	Plug-In
F	CB115T ¹	—	THQP115	15		
B	CB120	THQL1120	—	20		
G	CB120T ¹	—	THQP120	20		
C	CB130	THQL1130	—	30		
D	CB140	THQL1140	—	40		
E	CB150	THQL1150	—	50		
Double Pole						
K	CB215	THQL2115	—	15	2	Plug-In
L	CB220	THQL2120	—	20		
P	CB220T ¹	—	THQP220	20		
M	CB230	THQL2130	—	30		
Q	CB230T ¹	—	THQP230	30		
N	CB240	THQL2140	—	40		
O	CB250	THQL2150	—	50		
R	CB250T ¹	—	THQP250	50		
S	CB260	THQL2160	—	60		
T	CB270	THQL2170	—	70		
U	CB2100	THQL21100	—	100		
V	CB2150B	TQDL or equivalent	—	150		
V2	CB2200B	TQDL or equivalent	—	200		
Single and Double Pole						
W	GFI115	THQL1115GFT	—	15	1	Ground Fault Circuit Interrupter
X	GFI120	THQL1120GFT	—	20		
Y	GFI130	THQL1130GFT	—	30		
Z	GFI220	THQL2120GFT	—	20	2	
AA	GFI230	THQL2130GFT	—	30		
AB	GFI240	THQL2140GFT	—	40		
AC	GFI250	THQL2150GFT	—	50		

¹ Phasing out Midwest circuit breakers. Use new model number.

² Models ending in "T" (1/2" thinline breakers) not available for all load centers. Consult Manufacturer.

10kAIC, 100 – 225 Amps, 240V

Fig.	Midwest Model Number ¹ (Midwest Circuit Breakers Will Become Obsolete)	New Model Number		Amps	Number of Poles	Circuit Breaker Description
		1" Module	1/2" Module			
Double Pole, Bolt-on						
BB	CB2101	TQD22100WL	—	100	2	100 Amp Bolt-On
CC	CB2151	TQD22150WL	—	150		150 Amp Bolt-On
DD	CB2201	TQD22200WL	—	200		200 Amp Bolt-On
Special Purpose						
EE	CBL2101	—	—	100	2	Bolt-On w/Auxiliary Load Lugs
KK	CBT2102	—	—	100		Plug-In for 100 T Series
HH	LCB2101	—	—	100		Bolt-On w/Auxiliary Load Lugs
FF	CBL2151	—	—	150		Bolt-On w/Auxiliary Load Lugs
II	LCB2151	—	—	150		Bolt-On w/Auxiliary Load Lugs
GG	CBL2201	—	—	200		Bolt-On w/Auxiliary Load Lugs
LL	CBT2201	—	—	200		Bolt-On for 200 T Series
JJ	LCB2201	—	—	200		Bolt-On w/Auxiliary Load Lugs
MM	CBT2201N	—	—	225		Bolt-On, Non-Auto T Series

NOTE: Factory added modification parts to breakers, not available.

¹ Phasing out Midwest circuit breakers. Use new model number.

22kAIC, 100 – 200 Amps, 240V

Fig.	Midwest Model Number ¹ (Midwest Circuit Breakers Will Become Obsolete)	New Model Number		Amps	Number of Poles	Circuit Breaker Description
		1" Module	1/2" Module			
Plug-In						
	CB2100H	THHQL21100	—	100	2	Plug-In
OO	CB4150H	THQMV150WLBP	—	150		
NN	CB4200H	THQMV200WLBP	—	200		
Bolt-On						
QQ	CB2101H	THQD22100WL	—	100	2	Bolt-On
SS	CB2201H	THQD22200WL	—	200		

¹ Phasing out Midwest circuit breakers. Use new model number.

Data subject to change without notice.

Load Center Interiors

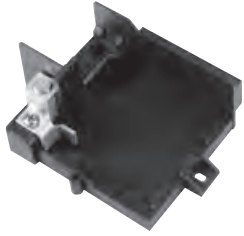

Fig. A
LC31X3



Fig. B
LC31N3

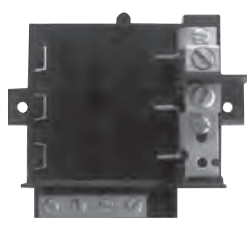

Fig. C
LC33N7

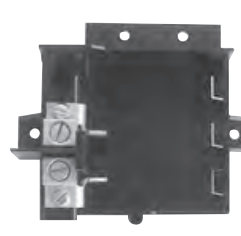

Fig. D
LC32X1

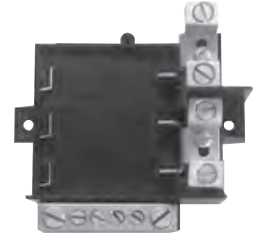

Fig. E
LC33N1

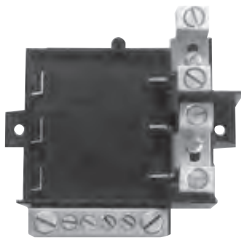

Fig. F
LC33N1T

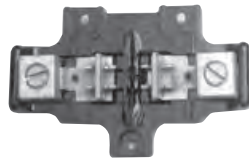

Fig. G
LC44X1

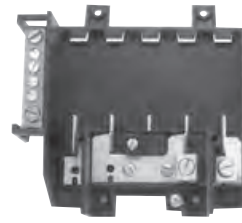

Fig. H
LC55N1

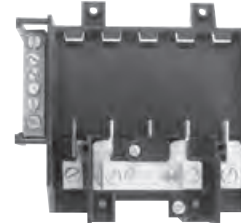

Fig. I
LC55N1T

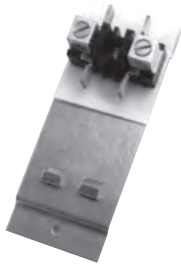

Fig. J
PC2LC

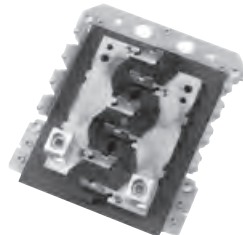

Fig. K
LC88PC

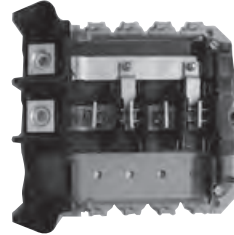

Fig. L
LC88X2

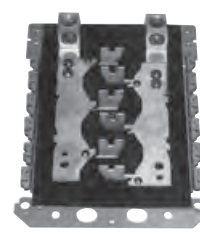

Fig. M
LC1212PC

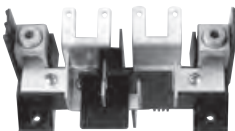

Fig. N
LCBS

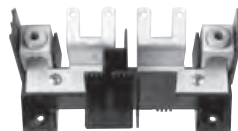

Fig. O
LCBNS



Fig. P
LCTL



Fig. Q
LCTNL

Load Center Interiors

30 Amps, 120V

Fig.	Model Number	Circuits	Amps	Line Lug Size	Neutral Lug Size
A	LC31X3	1	30	#14-1/0 Cu/Al	None
B	LC31N3				(2) #12-2 Cu/Al

70 – 200 Amps, 120/240V

Fig.	Model Number	Circuits	Amps	Line Lug Size	Neutral Lug Size
C	LC33N7	3	70	#14-1/0 Cu/Al	(4) #14-2 Cu/Al
D	LC32X1	2	100	#14-1/0 Cu/Al	None
E	LC33N1	3	100	#14-1/0 Cu/Al	(2) #14-1/0, (2) #14-4 Cu/Al
F	LC33N1T	3	100	(2) #14-1/0 Cu/Al/Phase	(2) #14-1/0, (2) #14-4 Cu/Al
G	LC44X1	4	100	#14-1/0 Cu/Al	None
H	LC55N1	5	100	#14-1/0 Cu/Al	(2) #14-1/0, (2) #14-4 Cu/Al
I	LC55N1T	5	100	(2) #14-1/0 Cu/Al/Phase	(2) #14-1/0, (2) #14-4 Cu/Al
J	PC2LC	2	125	#6-2/0 Cu/Al	None
K	LC88PC	8	200	#6-250 kcmil	None
L	LC88X2	8	200	(2) #1-300 kcmil Cu/Al	None
M	LC1212PC	12	200	#6-250 kcmil	None
N	LCBS	4	200	#1-4/0	#1-4/0, #6-2/0, #14-4
O	LCBNS	1	200	#1-4/0	#1-4/0, #6-2/0, #14-4
P	LCTL	4	200	#1-4/0	#1-4/0, #6-2/0, #14-4
Q	LCTNL	4	200	#1-4/0	#1-4/0, #6-2/0, #14-4

Lug Assemblies



Fig. A
NI60B2



Fig. B
NEU102



Fig. C
NEU100B2

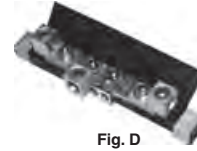

Fig. D
NEU202

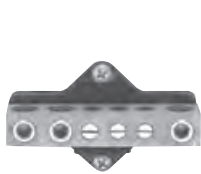

Fig. E
NI200



Fig. F
NI200A5



Fig. G
NEU407



Fig. H
NI400A1



Fig. I
GL3

Fig.	Part Number	Qty. and Lug Size
A	NI60B2	(4) #14-4 Cu/Al
B	NEU102	(5) #12-1/0 Cu/Al
C	NEU100B2	(5) #14-1/0 Cu/Al
D	NEU202	(2) #14-1/0 Cu/Al, (3) #6-250 kcmil Cu/Al
E	NI200	(3) 1/0-250 kcmil, (3) #12-1/0 Cu/Al
F	NI200A5	(3) 1/0-250 kcmil, (3) #12-1/0 Cu/Al
G	NEU407	(2) #14-1/0, (3) #2-600 kcmil
H	NI400A1	(2) 1/0-600 kcmil, (3) 1/0-250 kcmil Cu/Al
I	GL3	(2) #12-2 Cu/Al

Meter Door Replacement Kits

Meter door replacement kits are available for Service Entrance, Temporary Power, and RV metallic metered units. Please consult manufacturer to ensure the proper kit is ordered for your model.

Loop Feed Lug Terminal Bars

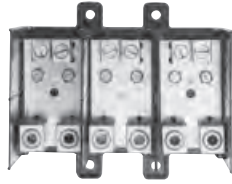

Fig. A
LT100B250

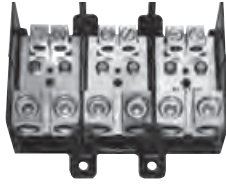

Fig. B
LT100B350

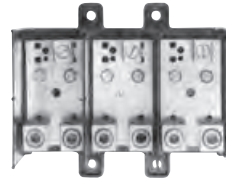

Fig. C
LT100S250

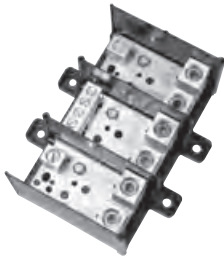

Fig. D
LT100S300

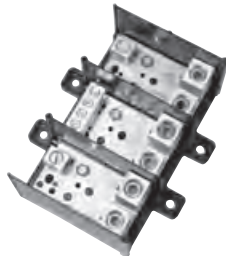

Fig. E
LT100S350

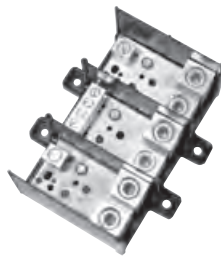

Fig. F
LT200B350



Fig. G
LT200B350RF

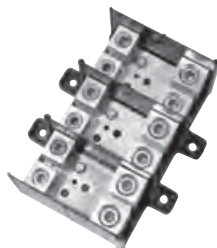

Fig. H
LT200S350



Fig. I
LT200SS

Fig.	Part Number	Load Amps	Load Lugs (Copper/Aluminum)	Line Amps	Line Lugs (Copper/Aluminum)
A	LT100B250	100	(2) #14-1/0 per Phase	200	(2) #1-300 kcmil per Phase
B	LT100B350		(2) #14-1/0 per Phase		(2) #6-350 kcmil per Phase
C	LT100S250		(1) #14-1/0 per Phase		(2) #1-300 kcmil per Phase
D	LT100S300		(2) #14-1/0, (4) #14-4		(6) #1-300 kcmil
E	LT100S350		(2) #14-1/0 CU, (4) #14-4		(6) #1-350 kcmil
F	LT200B350	200	(2) #2-250 kcmil per Phase		(2) #6-350 kcmil per Phase
G	LT200B350RF		(2) #14-1/0 per Phase		(3) #6-300 kcmil per Phase (Radial feed may go two different ways in row site)
H	LT200S350		(1) #2-250 kcmil per Phase		(2) #6-350 kcmil per Phase
I	LT200SS		(2) #2-250 kcmil per Phase		3/8" –16 Double Stud per Phase

Meter Bases

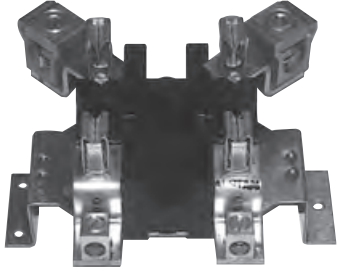

MSM100930

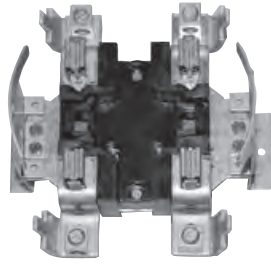

MSR100P9



MSM20014



MW200R

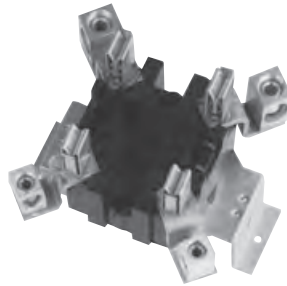

MW200M

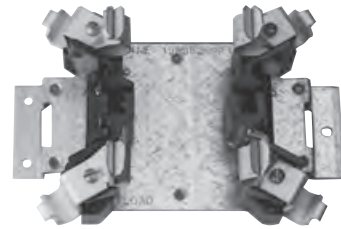

MS1S

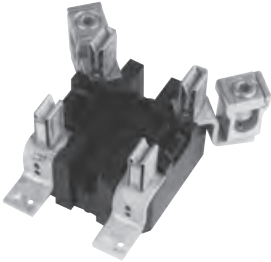

MSMS



MSRS



MSMP

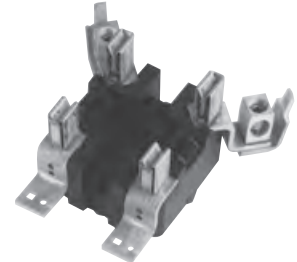

MSRP



MS5 (5TH JAW)



MSBN1A



MSBN4

Meter Bases

Meter Sockets Manufactured after February 1995, 100 Amps

Replacement Model Number	Type	Rating	Lug Style	Line Lug Wire Range	Optional Neutral Kit	Description
MSM100EZ	Ring Type	100	Lay In	6-350 kcmil	À	EZ-Site Underground Surface Panels
MSR100EZ	Ringless				À	EZ-Site Underground Surface Panels
MSM100930 ¹	Ring Type				MSBN4	9" x 30" Surface Panels
MSR100930	Ringless				MSBN4	9" x 30" Surface Panels
MSM100P9 ¹	Ring Type				MSBN4	9PT Single Sided Post
MSR100P9	Ringless				MSBN4	9PT Single Sided Post
MSM10014	Ring Type				MSBN4	11" Wide and 14" wide Surface Panels

À Neutral Factory installed in EZ-Site (Temporary Power) enclosure

¹ Midwest Electric manufactured meter socket only.

Meter Socket Manufactured between 1984 and February 1995, 100 Amps

Replacement Model Number	Type	Rating	Lug Style	Line Lug Wire Range	Optional Neutral Kit	Description
MS1H	Ring Type	100	Lay In	6-1/0	MSBN1A	Post Models, 14" Wide Surface Panels
MS1S ¹						Surface Mount, Rear Socket on Posts

¹ Midwest Electric manufactured meter socket only.

Meter Socket Manufactured after 1984, 200 Amp

Replacement Model Number	Type	Rating	Lug Style	Line Lug Wire Range	Optional Neutral Kit	Description
MSM20014 ¹	Ring Type	200	Lay In	6-350 kcmil	MSBN4	14" wide Surface Panels
MSR20014	Ringless		Lay In	6-350 kcmil	MSBN4	14" wide Surface Panels
MW200M ¹	Ring Type		Box Style	1/0-350 kcmil	MSBN4	All Other Panels and Post Units
MW200R ¹	Ringless		Box Style	1/0-350 kcmil	MSBN4	All Other Panels and Post Units
MSMS ¹	Ring Type		Lay In	—	—	28" and 18" Series Service End Surface Mount
MSRS ¹	Ringless		Lay In	—	—	28" and 18" Series Service End Surface Mount
MSMP ¹	Ring Type		Box Style	—	—	28" and 18" Series Service End Posts
MSRP ¹	Ringless		Box Style	—	—	28" and 18" Series Service End Posts
265A5264P8	Ringless	200/320 ²	Lay In	6-350 kcmil	Comes with 5th Jaw Neutral	14" Lever Bypass Series SE Surface/Pedestal

¹ Midwest Electric manufactured meter socket only.

² 320 Amp rated for bypass.

Lever Bypass Meter Socket, 400 Amp

Replacement Model Number	Type	Rating	Lug Style	Line Lug Wire Range	Optional Neutral Kit	Description
265A5264P10	Ringless	400/320 ²	Double Box Style	6-350 kcmil	—	14" Lever Bypass Series SE Surface/Pedestal

¹ Models ending in "T" (1/2" thinline breakers) not available for all load centers. Consult Manufacturer.

NEMA Receptacle Configurations

The configurations shown below all comply with National Electrical Manufacturers Association (NEMA) standards. These configurations represent a significant breakthrough on insuring the proper application and use of wiring devices to safeguard against accidents.

This breakthrough was accomplished with the completion of a systematic grouping of non-interchangeable general purpose receptacle and plug configurations. Use of NEMA's unique configuration design for standard usage current and voltage ratings reduce the unsafe interchangeability of devices which existed prior to their adoption.

System Voltage	NEMA	Straight Blade				NEMA	Locking Blade		
		20 Amps	30 Amps	50 Amps	60 Amps		20 Amps	30 Amps	
2 Pole, 3 Wire, Grounding	125V	5	5-20R	5-30R	5-50R	—	L-5	L5-20R	L5-30R
	250V	6	6-20R	6-30R	6-50R	—	L-6	L6-20R	L6-30R
	277VAC	7	7-20R	7-30R	7-50R	—	L-7	L7-20R	L7-30R
	480VAC	8	Reserved for Future Configurations				L-8	L8-20R	L8-30R
	600VAC	9	Reserved for Future Configurations				L-9	L9-20R	L9-30R
3 Pole, 3 Wire	125/250V	10	10-20R	10-30R, R-33	10-50R, R-53	—	L-10	L10-20R	L10-30R
	3Ø 250V	11	11-20R	11-30R	11-50R	—	L-11	L11-20R	L11-30R
	3Ø 480V	12	Reserved for Future Configurations				L-12	L12-20R	L12-30R
	3Ø 600V	13	Reserved for Future Configurations				L-13	—	L13-30R
3 Pole, 4 Wire, Grounding	125/250V	14	14-20R	14-30R, R-34	14-50R, R-54-U	14-60R	L-14	L14-20R	L14-30R
	3Ø 250V	15	15-20R	15-30R	15-50R	15-60R	L-15	L15-20R	L15-30R
	3Ø 480V	16	Reserved for Future Configurations				L-16	L16-20R	L16-30R
	3Ø 600V	17	Reserved for Future Configurations				L-17	—	L17-30R
4 Pole, 4 Wire	3Ø 120/208V	18	18-20R	18-30R	18-50R	18-60R, R-54	L-18	L18-20R	L18-30R

Other Receptacle Configurations

Configuration	Amps	Volts	Description
	20	125/250	7310
	30	125	TT-30R – 2 pole, 3 wire
	50	125/250	L6-50R (63CM69) Twist Lock – 2 pole, 3 wire
	50	125	L5-50R (63CM70) Twist Lock – 3 pole, 4 wire

Data subject to change without notice.

Section 14 – Application Data

Allowable ampacities of insulated conductors rated 0 through 2000 Volts, 60°C to 90°F (140° to 194°F) not more than three current-carrying conductors in raceway or cable or earth (directly buried), based on ambient temperature of 30°C (86°F).

Temperature Rating of Conductor								
Size	Copper			Aluminum or Copper-Clad Aluminum			Size	
AWG kcmil	Types							AWG kcmil
	TW=, UF=	FEPW=, RH=, RHW=, THHW=, THW=, THWN=, XHHW=, USE=, ZW=	TBS, SA, SIS, FEP=, FEPB=, MI, RHH=, RHW-2, THHN=, THHW=, THW-2=, THWN-2=, USE-2, XHH, XHHW=, XHHW-2, ZW-2	TW=, UF=	RH=, RHW=, THHW=, THW=, THWN=, XHHW=, USE=	TBS, SA, SIS, THHN=, THHW=, THW-2, THWN-2, RHH=, RHW-2, RHH=, RHW-2, USE-2, XHH, XHHW, XHHW-2, ZW-2		
	60°C (140°F)	75°C (167°F)	90°C (194°F)	60°C (140°F)	75°C (167°F)	90°C (194°F)		
18	14	
16	18	
14	20=	20=	25=	
12	25=	25=	30=	20=	20=	25=	12	
10	30	35=	40=	25	30=	35=	10	
8	40	50	55	30	40	45	8	
6	55	65	75	40	50	60	6	
4	70	85	95	55	65	75	4	
3	85	100	110	65	75	85	3	
2	95	115	130	75	90	100	2	
1	110	130	150	85	100	115	1	
1/0	125	150	170	100	120	135	1/0	
2/0	145	175	195	115	135	150	2/0	
3/0	165	200	225	130	155	175	3/0	
4/0	195	230	260	150	180	205	4/0	
250	215	255	290	170	205	230	250	
300	240	285	320	190	230	255	300	
350	260	310	350	210	250	280	350	
400	280	335	380	225	270	305	400	
500	320	380	430	260	310	350	500	
600	355	420	475	285	340	385	600	
700	385	460	520	310	375	420	700	
750	400	475	535	320	385	435	750	
800	410	490	555	330	395	450	800	
900	435	520	585	355	425	480	900	
1000	455	545	615	375	445	500	1000	
1250	495	590	665	405	485	545	1250	
1500	520	625	705	435	520	585	1500	
1750	545	650	735	455	545	615	1750	
2000	560	665	750	470	560	630	2000	

Correction Factors							
Ambient Temp. C	For ambient temperatures other than 30°C (86°F), multiply the allowable ampacities shown above by the appropriate factor shown below.						Ambient Temp. F
21-25	1.08	1.05	1.04	1.08	1.05	1.04	70-77
26-30	1.00	1.00	1.00	1.00	1.00	1.00	78-86
31-35	.91	.94	.96	.91	.94	.96	87-95
36-40	.82	.88	.91	.82	.88	.91	96-104
41-45	.71	.82	.87	.71	.82	.87	105-113
46-50	.58	.75	.82	.58	.75	.82	114-122
51-55	.41	.67	.76	.41	.67	.76	123-131
56-6058	.7158	.71	132-140
61-7033	.5833	.58	141-158
71-804141	159-176

Approximate Voltage Drop (Copper Conductor)

Wire Size AWG or MCM	Per Ampere per 100 feet – 80% Power Factor	
	Single Phase	Three Phase
14	.4762	.4167
12	.3125	.2632
10	.1961	.1677
8	.1250	.1087
6	.0833	.0714
4	.0538	.0463
3	.0431	.0379
2	.0370	.0323
1	.0323	.0278
1/0	.0269	.0231
2/0	.0222	.0196
3/0	.0190	.0163
4/0	.0161	.0139
250	.0147	.0128
300	.0131	.0114
350	.0121	.0106
400	.0115	.0091
500	.0101	.0088
600	.0094	.0082
700	.0089	.0077
750	.0086	.0075
800	.0085	.0074
900	.0081	.0071
1000	.0079	.0069

Data subject to change without notice.

= Unless otherwise specifically permitted elsewhere in this Code, the overcurrent protection for conductor types marked with an obelisk (=) shall not exceed 15 amperes for No. 14, 20 amperes for No. 12, and 30 amperes for No. 10 copper; or 15 amperes for No. 12 and 25 amperes for No. 10 aluminum and copper-clad aluminum after any correction factors for ambient temperature and number of conductors have been applied.

Section 15 – Authorized Reps

- 28 **Intralec Electrical Products**
Mississauga, ON L5S 1P6
Phone: (905) 670-0970
Fax: (905) 670-3098
www.intralec.com
- 28A **CHD Group**
Kitchener, ON N2R 1H4
Phone: (888) 849-4349
Fax: (888) 849-4349
www.chdgroup.ca
- 29 **E-Tel**
Houston, TX 77028
Phone: (713) 678-4460
Fax: (713) 678-4371
www.etelinc.com
- 30 **Robert A. Amey Company**
Portland, OR 97229
Phone: (503) 646-7196
Fax: (503) 626-8569
www.ameyco.com
- 37 **Electro-Lines, Inc.**
Syracuse, NY 13208
Phone: (315) 455-5701
(800) 962-5760
Fax: (315) 455-7114
www.electrolines.com
- 41 **L.W. French, Inc.**
Glen Allen, VA 23060
Phone: (804) 270-3205
Fax: (804) 270-0885
www.lwfrench.com
- 45 **Gemco Sales, Inc.**
Pittsburgh, PA 15201
Phone: (412) 562-9300
Fax: (412) 562-9028
- 50 **Vector Electrical Sales**
St. Charles, MO 63303
Phone: (636) 949-5925
Fax: (636) 949-5926
- 56 **John Moore & Associates**
La Vergne, TN 37086
Phone: (615) 287-0500
Fax: (615) 287-0662
www.jmaone.com
- Memphis, TN 38114
Phone: (901) 948-0193
Fax: (901) 948-0194
- 57 **Summit Sales & Marketing**
Louisville, KY 40217
Phone: (502) 636-3339
Fax: (502) 636-2575
www.summitsales-mkt.com
- 58 **Burrus & Matthews, Inc.**
Metairie, LA 70002
Phone: (504) 835-7825
(800) 535-7619
Fax: (504) 835-7853
www.b-m.com
- 62 **O.T. Hall & Son, Inc.**
Millersville, MD 21108
Phone: (410) 987-5990
(888) 621-7435
Fax: (410) 987-9691
www.othall.com
- 72 **Metra Associates, Inc.**
Deerfield Beach, FL 33442
Phone: (954) 428-4444
(800) 201-3465
Fax: (954) 428-4455
www.metra-assoc.com
- 75 **Theovine, Inc.**
Lachine, Quebec, Canada
Phone: (514) 637-0050
Fax: (514) 637-4630
www.theovine.com
- 77 **David Role & Co.**
Woburn, MA 01801
Phone: (781) 932-8810
(800) 878-0852
Fax: (781) 932-8815
- 83 **EAC/TSC**
Aurora, CO 80011
Phone: (303) 363-4152
Fax: (303) 344-8580
- 86 **Lake Michigan Sales, LLC**
Elk Grove Village, IL 60007
Phone: (847) 378-8045
Fax: (847) 307-8975
www.lakemichigansales.com
- 87 **Robert W. Chapman Company**
Charlotte, NC 28224
Phone: (704) 525-2421
Fax: (704) 527-1289
www.rwchapman.com
- 89 **Convergence**
North Kansas City, MO 64116
Phone: (816) 581-6300
Fax: (816) 581-6301
www.convergerep.com
- 90 **Gobeille-Robinson & Associates, Inc.**
Mansfield, OH 44907
Phone: (419) 526-1010
Fax: (419) 526-0291
www.gobrob.com
- 91 **Cusick Electrical Sales**
Willow Grove, PA 19090
Phone: (215) 659-6666
(888) 644-2744
Fax: (215) 659-6674
www.cusicksales.com
- 92 **Windshine LLC**
Oklahoma City, OK 73170
Phone: (405) 735-6999
www.wsokla.com
- 93 **Empire Electric Sales**
Sacramento, CA 95826
Phone: (916) 383-1399
www.empireelectricsales.com

Product Index

Model Number	Page	Model Number	Page	Model Number	Page
121.....	14-5	9T10W1002G61.....	13-5	9T10W1008G63.....	13-12
1004709DMEP.....	2-3, 2-10	9T10W1002G62.....	13-11	9T10W1009.....	13-5
1004710EMEP.....	2-3, 2-10	9T10W1002G63.....	13-12	9T10W1009G02.....	13-11
1006385BMEP.....	2-3, 2-10	9T10W1003.....	13-5	9T10W1009G03.....	13-12
1006630AMEP.....	2-9, 3-5	9T10W1003G02.....	13-11	9T10W1009G31.....	13-5
1006737BMEP.....	3-3, 3-6	9T10W1003G03.....	13-12	9T10W1009G32.....	13-11
1007003CMEP.....	2-3, 2-10	9T10W1003G31.....	13-5	9T10W1009G33.....	13-12
1007361CMEP.....	2-3, 2-10	9T10W1003G32.....	13-11	9T10W1171.....	13-5
1007665AMEP.....	2-3, 2-10	9T10W1003G33.....	13-12	9T10W1172.....	13-5
1007665MEP.....	2-3, 2-10	9T10W1003G61.....	13-5	9T10W1173.....	13-5
1007670MEP.....	2-6, 2-10	9T10W1003G62.....	13-11	9T10W1174.....	13-5
1007672MEP.....	2-5, 2-9, 2-10	9T10W1003G63.....	13-12	9T10W1175.....	13-5
1008068MEP.....	2-5, 2-10	9T10W1004.....	13-5	9T10W1176.....	13-5
1008435MEP.....	2-5, 2-9, 2-10	9T10W1004G02.....	13-11	9T10W1177.....	13-5
1008801MEP.....	2-10	9T10W1004G03.....	13-12	9T10W1178.....	13-5
1008836MEP.....	2-5, 2-10	9T10W1004G31.....	13-5	9T10W1179.....	13-5
1008837MEP.....	2-5, 2-10	9T10W1004G32.....	13-11	9T10W1181.....	13-6, 13-13
1009260MEP.....	2-5, 2-9, 2-10	9T10W1004G33.....	13-12	9T10W1181G31.....	13-13
1009788AMEP.....	2-5, 2-9, 2-10	9T10W1004G61.....	13-5	9T10W1181G61.....	13-13
1009995MEP.....	2-3, 2-10	9T10W1004G62.....	13-11	9T10W1182.....	13-6, 13-13
1011692MEP.....	2-3, 2-10	9T10W1004G63.....	13-12	9T10W1182G31.....	13-13
265A5003P1.....	14-5	9T10W1005.....	13-5	9T10W1182G61.....	13-13
265A5003P2.....	14-5	9T10W1005G02.....	13-11	9T10W1183.....	13-6, 13-13
265A5264P8.....	14-16	9T10W1005G03.....	13-12	9T10W1183G31.....	13-13
265A6035G27.....	14-7	9T10W1005G31.....	13-5	9T10W1183G61.....	13-13
265A6036G69.....	14-7	9T10W1005G32.....	13-11	9T10W1184.....	13-6, 13-13
4-GE-727X100001.....	14-6	9T10W1005G33.....	13-12	9T10W1184G31.....	13-13
4-GE-727X200001.....	14-6	9T10W1005G61.....	13-5	9T10W1184G61.....	13-13
4-MA-HUB1-M.....	14-6	9T10W1005G62.....	13-11	9T10W1185.....	13-6, 13-13
4-MA-HUB1.25-M.....	14-6	9T10W1005G63.....	13-12	9T10W1185G31.....	13-13
4-MA-NIP1.....	14-6	9T10W1006.....	13-5	9T10W1185G61.....	13-13
4-MA-NIP1.25.....	14-6	9T10W1006G02.....	13-11	9T10W1186.....	13-6, 13-13
4-MA-PLSL.....	14-6	9T10W1006G03.....	13-12	9T10W1186G31.....	13-13
4-MS-A4T100R1.25H1.....	14-6	9T10W1006G31.....	13-5	9T10W1186G61.....	13-13
4-MS-A4T100R1H1.....	14-6	9T10W1006G32.....	13-11	9T10W1187.....	13-6, 13-13
4-PK-BKIT-MIDWEST.....	14-6	9T10W1006G33.....	13-12	9T10W1187G31.....	13-13
4-PK-C1-MIDWEST.....	14-6	9T10W1006G61.....	13-5	9T10W1187G61.....	13-13
5S3S2S2SEB.....	11-10, 11-19	9T10W1006G62.....	13-11	9T10W1188.....	13-6, 13-13
5S3S2S2SES.....	11-10, 11-19	9T10W1006G63.....	13-12	9T10W1188G31.....	13-13
5S3S3S2SEB.....	11-10, 11-19	9T10W1007.....	13-5	9T10W1188G61.....	13-13
5S3S3S2SES.....	11-10, 11-19	9T10W1007G02.....	13-11	9T10W1189.....	13-6, 13-13
9T10W1001.....	13-5	9T10W1007G03.....	13-12	9T10W1189G31.....	13-13
9T10W1001G02.....	13-11	9T10W1007G31.....	13-5	9T10W1341.....	13-6
9T10W1001G03.....	13-12	9T10W1007G32.....	13-11	9T10W1342.....	13-6
9T10W1001G31.....	13-5	9T10W1007G33.....	13-12	9T10W1343.....	13-6
9T10W1001G32.....	13-11	9T10W1007G61.....	13-5	9T10W1344.....	13-6
9T10W1001G33.....	13-12	9T10W1007G62.....	13-11	9T10W1345.....	13-6
9T10W1001G61.....	13-5	9T10W1007G63.....	13-12	9T10W1346.....	13-6
9T10W1001G62.....	13-11	9T10W1008.....	13-5	9T10W1347.....	13-6
9T10W1001G63.....	13-12	9T10W1008G02.....	13-11	9T10W1348.....	13-6
9T10W1002.....	13-5	9T10W1008G03.....	13-12	9T10W1451.....	13-6
9T10W1002G02.....	13-11	9T10W1008G31.....	13-5	9T10W1452.....	13-6
9T10W1002G03.....	13-12	9T10W1008G32.....	13-11	9T10W1453.....	13-6
9T10W1002G31.....	13-5	9T10W1008G33.....	13-12	9T10W1454.....	13-6
9T10W1002G32.....	13-11	9T10W1008G61.....	13-5	9T10W1455.....	13-6
9T10W1002G33.....	13-12	9T10W1008G62.....	13-11	9T10W1456.....	13-6

Midwest Electric Products
Section 16 – Product Index

Model Number	Page
9T10W1457	13-6
9T10W1458	13-6
9T10W1531	13-6
9T10W1532	13-6
9T10W1533	13-6
9T10W1534	13-6
9T10W1535	13-6
9T10W1536	13-6
9T10W1537	13-6
9T10W1538	13-6
9T10W1539	13-6
9T10W1611	13-6
9T10W1612	13-6
9T10W1613	13-6
9T10W1614	13-6
9T10W1615	13-6
9T10W1616	13-6
9T10W1617	13-6
9T10W1618	13-6
9T10W1619	13-6
9T10X100	13-5
9T10X1001G02	13-11
9T10X1001G03	13-12
9T10X1001G31	13-5
9T10X1001G32	13-11
9T10X1001G33	13-12
9T10X1001G61	13-5
9T10X1001G62	13-11
9T10X1001G63	13-12
9T10X1002	13-5
9T10X1002G02	13-11
9T10X1002G03	13-12
9T10X1002G31	13-5
9T10X1002G32	13-11
9T10X1002G33	13-12
9T10X1002G61	13-5
9T10X1002G62	13-11
9T10X1002G63	13-12
9T10X1003	13-5
9T10X1003G02	13-11
9T10X1003G03	13-12
9T10X1003G31	13-5
9T10X1003G32	13-11
9T10X1003G33	13-12
9T10X1003G61	13-5
9T10X1003G62	13-11
9T10X1003G63	13-12
9T10X1004	13-5
9T10X1004G02	13-11
9T10X1004G03	13-12
9T10X1004G31	13-5
9T10X1004G32	13-11
9T10X1004G33	13-12
9T10X1004G61	13-5
9T10X1004G62	13-11
9T10X1004G63	13-12

Model Number	Page
9T10X1005	13-5
9T10X1005G02	13-11
9T10X1005G03	13-12
9T10X1005G31	13-5
9T10X1005G32	13-11
9T10X1005G33	13-12
9T10X1005G61	13-5
9T10X1005G62	13-11
9T10X1005G63	13-12
9T10X1006	13-5
9T10X1006G02	13-11
9T10X1006G03	13-12
9T10X1006G31	13-5
9T10X1006G32	13-11
9T10X1006G33	13-12
9T10X1006G61	13-5
9T10X1006G62	13-11
9T10X1006G63	13-12
9T10X1007	13-5
9T10X1007G02	13-11
9T10X1007G03	13-12
9T10X1007G31	13-5
9T10X1007G32	13-11
9T10X1007G33	13-12
9T10X1007G61	13-5
9T10X1007G62	13-11
9T10X1007G63	13-12
9T10X1008	13-5
9T10X1008G02	13-11
9T10X1008G03	13-12
9T10X1008G31	13-5
9T10X1008G32	13-11
9T10X1008G33	13-12
9T10X1008G61	13-5
9T10X1008G62	13-11
9T10X1008G63	13-12
9T10X1009	13-5
9T10X1009G02	13-11
9T10X1009G03	13-12
9T10X1009G32	13-11
9T10X1009G33	13-12
9T10X1181	13-13
9T10X1181G31	13-13
9T10X1181G61	13-13
9T10X1182	13-13
9T10X1182G31	13-13
9T10X1182G61	13-13
9T10X1183	13-13
9T10X1183G31	13-13
9T10X1183G61	13-13
9T10X1184	13-13
9T10X1184G31	13-13
9T10X1184G61	13-13
9T10X1185	13-13
9T10X1185G31	13-13
9T10X1185G61	13-13

Model Number	Page
9T10X1186	13-13
9T10X1186G31	13-13
9T10X1186G61	13-13
9T10X1187	13-13
9T10X1187G31	13-13
9T10X1187G61	13-13
9T10X1188	13-13
9T10X1188G31	13-13
9T10X1188G61	13-13
9T10X1189	13-13
9T10X1189G31	13-13
9T10X1191	13-6
9T10X1192	13-6
9T10X1193	13-6
9T10X1194	13-6
9T10X1195	13-6
9T10X1196	13-6
9T10X1197	13-6
9T10X1198	13-6
9T10X1199	13-6
9T10X240	13-6
9T10X2402	13-6
9T10X2403	13-6
9T10X2404	13-6
9T10X2405	13-6
9T10X2406	13-6
9T10X2407	13-6
9T10X2408	13-6
9T10X2409	13-6
9T11W1001G03	13-8
9T11W1001G04	13-10
9T11W1001G33	13-8
9T11W1001G34	13-10
9T11W1001G63	13-8
9T11W1001G64	13-10
9T11W1002G03	13-8
9T11W1002G04	13-10
9T11W1002G33	13-8
9T11W1002G34	13-10
9T11W1002G63	13-8
9T11W1002G64	13-10
9T11W1003G03	13-8
9T11W1003G04	13-10
9T11W1003G33	13-8
9T11W1003G34	13-10
9T11W1003G63	13-8
9T11W1003G64	13-10
9T11W1004G03	13-8
9T11W1004G04	13-10
9T11W1004G33	13-8
9T11W1004G34	13-10
9T11W1004G63	13-8
9T11W1004G64	13-10
9T11W1005G03	13-8
9T11W1005G04	13-10
9T11W1005G33	13-8

Data subject to change without notice.

Midwest Electric Products
Section 16 – Product Index

Model Number	Page
9T11W1005G34.....	13-10
9T11W1005G63.....	13-8
9T11W1005G64.....	13-10
9T11W1006G03.....	13-8
9T11W1006G04.....	13-10
9T11W1006G33.....	13-8
9T11W1006G34.....	13-10
9T11W1006G63.....	13-8
9T11W1006G64.....	13-10
9T11W1007G03.....	13-8
9T11W1007G04.....	13-10
9T11W1007G33.....	13-8
9T11W1007G34.....	13-10
9T11W1007G63.....	13-8
9T11W1008G03.....	13-8
9T11W1008G04.....	13-10
9T11W1008G33.....	13-8
9T11W1008G34.....	13-10
9T11X1001G03.....	13-8
9T11X1001G04.....	13-10
9T11X1001G33.....	13-8
9T11X1001G34.....	13-10
9T11X1001G63.....	13-8
9T11X1001G64.....	13-10
9T11X1002G03.....	13-8
9T11X1002G04.....	13-10
9T11X1002G33.....	13-8
9T11X1002G34.....	13-10
9T11X1002G63.....	13-8
9T11X1002G64.....	13-10
9T11X1003G03.....	13-8
9T11X1003G04.....	13-10
9T11X1003G33.....	13-8
9T11X1003G34.....	13-10
9T11X1003G63.....	13-8
9T11X1003G64.....	13-10
9T11X1004G03.....	13-8
9T11X1004G04.....	13-10
9T11X1004G33.....	13-8
9T11X1004G34.....	13-10
9T11X1004G63.....	13-8
9T11X1004G64.....	13-10
9T11X1005G03.....	13-8
9T11X1005G04.....	13-10
9T11X1005G33.....	13-8
9T11X1005G34.....	13-10
9T11X1005G63.....	13-8
9T11X1005G64.....	13-10
9T11X1006G03.....	13-8
9T11X1006G04.....	13-10
9T11X1006G33.....	13-8
9T11X1006G34.....	13-10
9T11X1006G63.....	13-8
9T11X1006G64.....	13-10
9T11X1007G03.....	13-8
9T11X1007G04.....	13-10

Model Number	Page
9T11X1007G33.....	13-8
9T11X1007G34.....	13-10
9T11X1007G63.....	13-8
9T11X1007G64.....	13-10
9T11X1008G03.....	13-8
9T11X1008G04.....	13-10
9T11X1008G33.....	13-8
9T11X1008G34.....	13-10
9T11X1008G63.....	13-8
9T11X1009G33.....	13-8
9T14W1001G03.....	13-7
9T14W1001G04.....	13-9
9T14W1001G33.....	13-7
9T14W1001G34.....	13-9
9T14W1001G63.....	13-7
9T14W1001G64.....	13-9
9T14W1002G03.....	13-7
9T14W1002G04.....	13-9
9T14W1002G33.....	13-7
9T14W1002G34.....	13-9
9T14W1002G63.....	13-7
9T14W1002G64.....	13-9
9T14W1003G03.....	13-7
9T14W1003G04.....	13-9
9T14W1003G33.....	13-7
9T14W1003G34.....	13-9
9T14W1003G63.....	13-7
9T14W1003G64.....	13-9
9T14W1004G03.....	13-7
9T14W1004G04.....	13-9
9T14W1004G33.....	13-7
9T14W1004G34.....	13-9
9T14W1004G63.....	13-7
9T14W1004G64.....	13-9
9T14W1005G03.....	13-7
9T14W1005G04.....	13-9
9T14W1005G33.....	13-7
9T14W1005G34.....	13-9
9T14W1005G63.....	13-7
9T14W1005G64.....	13-9
9T14W1006G03.....	13-7
9T14W1006G04.....	13-9
9T14W1006G33.....	13-7
9T14W1006G34.....	13-9
9T14W1006G63.....	13-7
9T14W1006G64.....	13-9
9T14W1007G03.....	13-7
9T14W1007G04.....	13-9
9T14W1007G33.....	13-7
9T14W1007G34.....	13-9
9T14W1007G63.....	13-7
9T14W1007G64.....	13-9
9T14W1008G03.....	13-7
9T14W1008G04.....	13-9
9T14W1008G33.....	13-7
9T14W1008G34.....	13-9

Model Number	Page
9T14W1008G64.....	13-9
9T14X1001G03.....	13-7
9T14X1001G04.....	13-9
9T14X1001G33.....	13-7
9T14X1001G34.....	13-9
9T14X1001G63.....	13-7
9T14X1001G64.....	13-9
9T14X1002G03.....	13-7
9T14X1002G04.....	13-9
9T14X1002G33.....	13-7
9T14X1002G34.....	13-9
9T14X1002G63.....	13-7
9T14X1002G64.....	13-9
9T14X1003G03.....	13-7
9T14X1003G04.....	13-9
9T14X1003G33.....	13-7
9T14X1003G34.....	13-9
9T14X1003G63.....	13-7
9T14X1003G64.....	13-9
9T14X1004G03.....	13-7
9T14X1004G04.....	13-9
9T14X1004G33.....	13-7
9T14X1004G34.....	13-9
9T14X1004G63.....	13-7
9T14X1004G64.....	13-9
9T14X1005G03.....	13-7
9T14X1005G04.....	13-9
9T14X1005G33.....	13-7
9T14X1005G34.....	13-9
9T14X1005G63.....	13-7
9T14X1005G64.....	13-9
9T14X1006G03.....	13-7
9T14X1006G04.....	13-9
9T14X1006G33.....	13-7
9T14X1006G34.....	13-9
9T14X1006G63.....	13-7
9T14X1006G64.....	13-9
9T14X1007G03.....	13-7
9T14X1007G04.....	13-9
9T14X1007G33.....	13-7
9T14X1007G34.....	13-9
9T14X1007G63.....	13-7
9T14X1007G64.....	13-9
9T14X1008G03.....	13-7
9T14X1008G04.....	13-9
9T14X1008G33.....	13-7
9T14X1008G34.....	13-9
9T14X1008G63.....	13-7
9T14X1009G33.....	13-7
9T18W1071.....	13-17
9T18W1071G03.....	13-18
9T18W1071G04.....	13-18
9T18W1071G05.....	13-17
9T18W1071G06.....	13-14
9T18W1071G07.....	13-14
9T18W1071G10.....	13-14

Data subject to change without notice.

Midwest Electric Products
Section 16 – Product Index

Model Number	Page
9T18W1071G101.....	13-16
9T18W1071G11.....	13-15
9T18W1072.....	13-17
9T18W1072G03.....	13-18
9T18W1072G04.....	13-18
9T18W1072G06.....	13-14
9T18W1072G10.....	13-14
9T18W1072G101.....	13-16
9T18W1074.....	13-17
9T18W1074G03.....	13-18
9T18W1074G04.....	13-18
9T18W1074G06.....	13-14
9T18W1074G07.....	13-14
9T18W1074G10.....	13-14, 13-16
9T18W1074G11.....	13-15
9T18W1075.....	13-17
9T18W1075G03.....	13-18
9T18W1075G04.....	13-18
9T18W1075G10.....	13-14, 13-16
9T18W1076.....	13-17
9T18W1076G03.....	13-18
9T18W1076G04.....	13-18
9T18W1076G06.....	13-14
9T18W1076G10.....	13-14, 13-16
9T18W1077.....	13-17
9T18W1077G03.....	13-18
9T18W1077G04.....	13-18
9T18W1077G06.....	13-14
9T18W1077G09.....	13-15
9T18W1077G10.....	13-14, 13-16
9T18W1078.....	13-17
9T18W1078G03.....	13-18
9T18W1078G04.....	13-18
9T18W1078G09.....	13-15
9T18W1078G10.....	13-14, 13-16
9T18W1079.....	13-17
9T18W1079G03.....	13-18
9T18W1079G04.....	13-18
9T18W1079G06.....	13-14
9T18W1079G09.....	13-15
9T18W1079G10.....	13-14, 13-16
9T18W1171G06.....	13-15
9T18W1172G06.....	13-15
9T18W1174G06.....	13-15
9T18W1176G06.....	13-15
9T18W4317G05.....	13-14
9T18W4317G06.....	13-14
9T18W4322G77.....	13-14
9T18W4322G79.....	13-14
9T18W4504G77.....	13-15
9T18W4504G79.....	13-15
9T18W5042.....	13-14
9T18W5043.....	13-14
9T18W7240G02.....	13-14, 13-16
9T18W7240G021.....	13-16
9T18W7240G03.....	13-14, 13-16

Model Number	Page
9T18W7241G03.....	13-14, 13-16
9T18W7242G05.....	13-14, 13-16
9T18W7242G07.....	13-14, 13-16
9T18Y1071G05.....	13-17
9T18Y1072G05.....	13-17
9T18Y1074G05.....	13-17
9T18Y1076G05.....	13-17
9T18Y1077G05.....	13-17
9T18Y1078G05.....	13-17
9T18Y1079G05.....	13-17
9T21W1001G02.....	13-21
9T21W1002G02.....	13-21
9T21W1003G02.....	13-21
9T21W1004G02.....	13-22
9T21W1005G02.....	13-22
9T21W1006G02.....	13-22
9T21W1007G02.....	13-22
9T21W1008G02.....	13-22
9T21W1009G02.....	13-22
9T21W1013G02.....	13-22
9T21W1014G02.....	13-22
9T21W1015G02.....	13-22
9T21W1016G02.....	13-22
9T21W1019G02.....	13-22
9T21W1020G02.....	13-22
9T21W1021G02.....	13-22
9T21W1025G02.....	13-22
9T21W1028G02.....	13-21
9T21W1029G02.....	13-21
9T21W1030G02.....	13-21
9T21W1037G02.....	13-25
9T21W1040G02.....	13-25
9T21W1046G02.....	13-21
9T21W1047G02.....	13-21
9T21W1048G02.....	13-21
9T21W1054G02.....	13-21
9T21W1265G02.....	13-21
9T21W1266G02.....	13-21
9T21W4553G02.....	13-24
9T21W9101.....	13-21
9T21W9102.....	13-21
9T21W9103.....	13-22
9T21W9104.....	13-22
9T21W9105.....	13-22
9T21W9106.....	13-22
9T21W9109.....	13-22
9T21W9110.....	13-22
9T21W9111.....	13-22
9T21W9113.....	13-22
9T21W9114.....	13-22
9T21W9119.....	13-21
9T21W9120.....	13-21
9T21W9131.....	13-21
9T21W9143.....	13-21
9T21W9144.....	13-21
9T21W9201.....	13-24

Model Number	Page
9T21W9202.....	13-24
9T51W0002.....	13-19
9T51W0003.....	13-19
9T51W0004.....	13-19
9T51W0005.....	13-19
9T51W0007.....	13-19
9T51W0008.....	13-19
9T51W0009.....	13-19
9T51W0010.....	13-19
9T51W0011.....	13-19
9T51W0012.....	13-19
9T51W0013.....	13-19
9T51W0022.....	13-20
9T51W0024.....	13-20
9T51W0025.....	13-20
9T51W0027.....	13-20
9T51W0028.....	13-20
9T51W0029.....	13-20
9T51W0030.....	13-20
9T51W0031.....	13-20
9T51W0032.....	13-20
9T51W0033.....	13-20
9T51W0050.....	13-19
9T51W0051.....	13-19
9T51W0052.....	13-19
9T51W0053.....	13-19
9T51W0070.....	13-19
9T51W0071.....	13-19
9T51W0072.....	13-19
9T51W0073.....	13-19
9T51W0082.....	13-19
9T51W0083.....	13-19
9T51W0084.....	13-19
9T51W0085.....	13-19
9T51W0087.....	13-19
9T51W0088.....	13-19
9T51W0089.....	13-19
9T51W0090.....	13-19
9T51W0091.....	13-19
9T51W0092.....	13-19
9T51W0093.....	13-19
9T51W0102.....	13-25
9T51W0103.....	13-25
9T51W0104.....	13-25
9T51W0105.....	13-25
9T51W0107.....	13-25
9T51W0108.....	13-25
9T51W0109.....	13-25
9T51W0110.....	13-25
9T51W0111.....	13-25
9T51W0112.....	13-25
9T51W0113.....	13-25
9T51W0122.....	13-25
9T51W0123.....	13-25
9T51W0124.....	13-25
9T51W0125.....	13-25

Data subject to change without notice.

Midwest Electric Products
Section 16 – Product Index

Model Number	Page	Model Number	Page	Model Number	Page
9T51W0127	13-25	9T58W0000G46	13-30	9T58W1815G07	13-29
9T51W0128	13-25	9T58W0000G47	13-30	9T58W1824G07	13-29
9T51W0129	13-25	9T58W0000G48	13-30	9T58W1826G07	13-29
9T51W0130	13-25	9T58W00042	13-27	9T58W1828G07	13-29
9T51W0131	13-25	9T58W00043	13-27	9T58W1830G07	13-29
9T51W0132	13-25	9T58W00044	13-27	9T58W1832G07	13-29
9T51W0133	13-25	9T58W00045	13-27	9T58W1834G07	13-29
9T51W0135	13-19	9T58W00046	13-27	9T58W1835G07	13-29
9T51W01361	13-24	9T58W00047	13-27	9T58W1873G07	13-29
9T51W01371	13-24	9T58W00048	13-27	9T58W1874G07	13-29
9T51W01381	13-24	9T58W00049	13-27	9T58W1875G07	13-29
9T51W01391	13-24	9T58W00050	13-27	9T58W1876G07	13-29
9T51W01401	13-24	9T58W00051	13-27	9T58W1877G07	13-29
9T51W01411	13-24	9T58W00052	13-27	9T58W1878G07	13-29
9T51W0142	13-24	9T58W00053	13-27	9T58W1879G07	13-29
9T51W0143	13-24	9T58W00054	13-27	9T58W1881G07	13-29
9T51W0144	13-24	9T58W00055	13-27	9T58W1882G07	13-29
9T51W0145	13-24	9T58W00062	13-27	9T58W1883G07	13-29
9T51W0146	13-24	9T58W00063	13-27	9T58W1978G07	13-29
9T51W0147	13-24	9T58W00064	13-27	9T58W1979G07	13-29
9T51W0148	13-24	9T58W00065	13-27	9T58W1980G07	13-29
9T51W0150	13-24	9T58W00066	13-27	9T58W1981G07	13-29
9T51W0152	13-24	9T58W00067	13-27	9T58W2802	13-28
9T51W0153	13-24	9T58W00068	13-27	9T58W2803	13-28
9T51W0154	13-24	9T58W00069	13-27	9T58W2804	13-28
9T51W0156	13-20	9T58W00070	13-27	9T58W2805	13-28
9T51W0157	13-20	9T58W00071	13-27	9T58W2806	13-28
9T51W0158	13-20	9T58W00072	13-27	9T58W2807	13-28
9T51W0159	13-20	9T58W00073	13-27	9T58W2808	13-28
9T51W0160	13-20	9T58W00074	13-27	9T58W2809	13-28
9T51W0187	13-20	9T58W00082	13-27	9T58W2810	13-28
9T51W0188	13-20	9T58W00083	13-27	9T58W2811	13-28
9T51W0189	13-20	9T58W00084	13-27	9T58W2812	13-28
9T51W0190	13-20	9T58W00085	13-27	9T58W2813	13-28
9T51W0191	13-20	9T58W00086	13-27	9T58W2814	13-28
9T51W0192	13-20	9T58W00087	13-27	9T58W2815	13-28
9T51W0193	13-20	9T58W00088	13-27	9T58W2823	13-28
9T51W0202	13-25	9T58W00089	13-27	9T58W2824	13-28
9T51W0203	13-25	9T58W00090	13-27	9T58W2826	13-28
9T51W0204	13-25	9T58W00091	13-27	9T58W2827	13-28
9T51W0205	13-25	9T58W00092	13-27	9T58W2828	13-28
9T51W0207	13-25	9T58W00093	13-27	9T58W2830	13-28
9T51W0208	13-25	9T58W00094	13-27	9T58W2831	13-28
9T51W0209	13-25	9T58W1802G07	13-29	9T58W2832	13-28
9T51W0210	13-25	9T58W1803G07	13-29	9T58W2833	13-28
9T51W0211	13-25	9T58W1804G07	13-29	9T58W2834	13-28
9T51W0212	13-25	9T58W1805G07	13-29	9T58W2835	13-28
9T51W0213	13-25	9T58W1806G07	13-29	9T58W2873	13-28
9T58W0000G01	13-30	9T58W1807G07	13-29	9T58W2874	13-28
9T58W0000G05	13-30	9T58W1808G07	13-29	9T58W2875	13-28
9T58W0000G10	13-30	9T58W1809G07	13-29	9T58W2876	13-28
9T58W0000G18	13-30	9T58W1810G07	13-29	9T58W2877	13-28
9T58W0000G24	13-30	9T58W1811G07	13-29	9T58W2878	13-28
9T58W0000G38	13-30	9T58W1812G07	13-29	9T58W2879	13-28
9T58W0000G42	13-30	9T58W1813G07	13-29	9T58W2907	13-28
9T58W0000G43	13-30	9T58W1814G07	13-29	9T58W2909	13-28

Data subject to change without notice.

Midwest Electric Products
Section 16 – Product Index

Model Number	Page	Model Number	Page	Model Number	Page
9T58W2911	13-28	9T83X2572	13-4	BR53	14-2
9T58W2913	13-28	9T83X2572G15	13-4	BR54U	14-2
9T58W2914	13-28	9T83X2572G80	13-4	BR64U	14-2
9T58W2915	13-28	9T83X2573	13-4	C32U	14-2
9T58W2917	13-28	9T83X2573G15	13-4	C33	14-2
9T58W2918	13-28	9T83X2573G80	13-4	C34	14-2
9T58W2975	13-28	9T83X2574	13-4	C53	14-2
9T58W2978	13-28	9T83X2574G15	13-4	C54U	14-2
9T58W2979	13-28	9T83X2574G80	13-4	C64U	14-2
9T58W2980	13-28	9T83X2575	13-4	CB115	14-10
9T58W2981	13-28	9T83X2575G15	13-4	CB115T	14-10
9T58W2982	13-28	9T83X2575G80	13-4	CB120	14-10
9T58W2983	13-28	9T83X2576	13-4	CB120T	14-10
9T58W3024	13-28	9T83X2576G15	13-4	CB130	14-10
9T58W3164	13-28	9T83X2576G80	13-4	CB140	14-10
9T58W3715	13-29	AD2030	14-2	CB150	14-10
9T58W3716	13-29	AD3020	14-2	CB2100	14-10
9T58W3717	13-29	AD5020	14-2	CB2100H	14-10
9T58W3718	13-29	ARP0002MEP	2-9, 3-5	CB2101	14-10
9T58W3719	13-29	ARP00003MEP	2-9, 3-5	CB2101H	14-10
9T58W3720	13-29	ARP00004MEP	2-9, 3-5	CB215	14-10
9T58W3721	13-29	ARP00005MEP	2-9, 3-5	CB2150B	14-10
9T58W4050	13-28	ARP00006MEP	2-9, 3-5	CB2151	14-10
9T58W4051	13-28	ARP00007MEP	2-9, 3-5	CB220	14-10
9T58W4052	13-28	ARP00008MEP	2-9, 3-5	CB2200B	14-10
9T58W4053	13-28	ARP00015MEP	2-9, 3-5	CB2201	14-10
9T58W4132	13-28	ARP00016MEP	2-9, 3-5	CB2201H	14-10
9T58W4133	13-28	ARP00017MEP	2-9, 3-5	CB220T	14-10
9T83W2670	13-4	ARP00018MEP	2-9, 3-5	CB230	14-10
9T83W2670G15	13-4	ARP00019MEP	2-9, 3-5	CB230T	14-10
9T83W2670G80	13-4	ARP00020MEP	2-9, 3-5	CB240	14-10
9T83W2671	13-4	ARP00021MEP	2-9, 3-5	CB250	14-10
9T83W2671G15	13-4	ARP00023MEP	2-9, 3-5	CB250T	14-10
9T83W2671G80	13-4	ARP00035MEP	2-9, 3-5	CB260	14-10
9T83W2672	13-4	ARP00118MEP	2-9, 3-5	CB270	14-10
9T83W2672G15	13-4	ARP00129MEP	2-9, 3-5	CB4150H	14-10
9T83W2672G80	13-4	ARP00326MEP	2-9, 3-5	CB4200H	14-10
9T83W2673	13-4	ARP00427MEP	2-9	CBL2101	14-10
9T83W2673G15	13-4	ARP00429MEP	2-9, 3-5	CBL2151	14-10
9T83W2673G80	13-4	ARP00759MEP	2-9	CBL2201	14-10
9T83W2674	13-4	ARP00920MEP	2-9, 3-5, 14-5	CBT2102	14-10
9T83W2674G15	13-4	ARP00984MEP	2-9, 3-5	CBT2201	14-10
9T83W2674G80	13-4	ARP01590MEP	2-9, 3-5	CBT2201N	14-10
9T83W2675	13-4	ARP01595MEP	2-9	EK126	14-3
9T83W2675G15	13-4	ARP90015932MEP	2-9, 3-5	EK129	14-3
9T83W2675G80	13-4	ASR1	14-5	FBEM9	14-4
9T83W2676	13-4	B01	4-9, 14-4	FH1	14-7
9T83W2676G15	13-4	B07	4-9, 14-4	FH2	14-7
9T83W2676G80	13-4	B10	4-9, 14-4	FH3	14-7
9T83W2677	13-4	B12	4-9, 14-4	FH682	14-8
9T83X257	13-4	B15	4-9, 14-4	FR35	14-8
9T83X2570	13-4	B20	4-9, 14-4	FR352R	14-8
9T83X2570G15	13-4	B25	4-9, 14-4	FR35R	14-7
9T83X2570G80	13-4	BR32U	14-2	FR39	14-8
9T83X2571G15	13-4	BR33	14-2	FR64X2	14-8
9T83X2571G80	13-4	BR34	14-2	FR65	14-8

Data subject to change without notice.

Midwest Electric Products
Section 16 – Product Index

Model Number	Page
FR65X2.....	14-8
FR66.....	14-8
FR67.....	14-8
FR67X2.....	14-8
FR69.....	14-8
GFI115.....	14-10
GFI120.....	14-10
GFI130.....	14-10
GFI220.....	14-10
GFI230.....	14-10
GFI240.....	14-10
GFI250.....	14-10
GL3.....	14-13
GS1101B12UL.....	8-3, 8-5
GS1201B20UL.....	8-3, 8-5
GS1202B20M.....	8-4, 8-5
GS1202B20UL.....	8-3, 8-5
GS1402B01UL.....	8-3, 8-5
GS1404B01UL.....	8-3, 8-5
GS3161B12UL.....	8-3, 8-5
GS3161G.....	8-4, 8-5
GS3262B25UL.....	8-3, 8-5
GS3262G.....	8-4, 8-5
GS3402B01UL.....	8-3, 8-5
GS3404B01UL.....	8-3, 8-5
GS3464B01UL.....	8-3, 8-5
LC1212PC.....	14-12
LC31N3.....	14-12
LC31X3.....	14-12
LC32X1.....	14-12
LC33N1.....	14-12
LC33N1T.....	14-12
LC33N7.....	14-12
LC44X1.....	14-12
LC55N1.....	14-12
LC55N1T.....	14-12
LC88PC.....	14-12
LC88X2.....	14-12
LCB2101.....	14-10
LCB2151.....	14-10
LCB2201.....	14-10
LCBNS.....	14-12
LCBS.....	14-12
LCTL.....	14-12
LCTNL.....	14-12
LT100B250.....	14-14
LT100B350.....	14-14
LT100S250.....	14-14
LT100S300.....	14-14
LT100S350.....	14-14
LT200B350.....	14-14
LT200B350RF.....	14-14
LT200S350.....	14-14
LT200SS.....	14-14
M004C010.....	11-7, 11-19
M004CP6010.....	11-14, 11-19

Model Number	Page
M009C010.....	9-7, 9-9
M011C010.....	9-7, 9-9
M011C010U.....	9-8, 9-9
M011G.....	9-7, 9-9
M031C010.....	11-7, 11-19
M036C010.....	9-6, 9-9
M036C010U.....	9-8, 9-9
M036C033.....	9-6, 9-9
M036G.....	9-6, 9-9
M038C010.....	9-7, 9-9
M038C010U.....	9-8, 9-9
M038C033.....	9-7, 9-9
M038C033U.....	9-8, 9-9
M038CB1010.....	9-7, 9-9
M038CB1033.....	9-7, 9-9
M038G.....	9-7, 9-9
M038GB1.....	9-7, 9-9
M038GB1033.....	9-7, 9-9
M041C010.....	11-7, 11-19
M041C010U.....	9-8, 9-9
M041CB6010.....	11-15, 11-19
M041CP4010.....	11-16, 11-19
M041CP4L10.....	11-17, 11-19
M041CP4L31.....	11-17, 11-19
M041CP6010.....	11-13, 11-19
M041CP6L10.....	11-17, 11-19
M041G.....	11-7, 11-19
M041GB6.....	11-15, 11-19
M041GP4.....	11-16, 11-19
M041GP6.....	11-13, 11-19
M051C010.....	9-6, 9-9
M051G.....	9-6, 9-9
M055C010.....	9-6, 9-9
M055C010U.....	9-8, 9-9
M055C033.....	9-6, 9-9
M055C033U.....	9-8, 9-9
M055G.....	9-6, 9-9
M055GP6.....	11-13, 11-19
M055GP6033.....	9-6, 9-9
M075C010.....	11-7, 11-19
M075C010U.....	9-8, 9-9
M075CB4010.....	11-16, 11-19
M075CB6010.....	11-15, 11-19
M075CB6031.....	11-15, 11-19
M075CP4010.....	11-16, 11-19
M075CP4L10.....	11-17, 11-19
M075CP4L31.....	11-17, 11-19
M075CP6010.....	11-13, 11-19
M075CP6010GR.....	11-13, 11-19
M075CP6031.....	11-13, 11-19
M075CP6L10.....	11-17, 11-19
M075CP6L31.....	11-17, 11-19
M075G.....	11-7, 11-19
M075GB6.....	11-15, 11-19
M075GP4.....	11-16, 11-19
M075GP6.....	11-13, 11-19

Model Number	Page
M076C010.....	9-6, 9-9
M076C010U.....	9-8, 9-9
M076C033.....	9-6, 9-9
M100C.....	1-3, 1-16
M100T.....	1-3, 1-16
M101C.....	1-3, 1-16
M101CB2.....	1-3, 1-16
M101CB6.....	1-11, 1-16
M101CB6HP.....	1-11, 1-16
M101CC.....	1-3, 1-16
M101CP4.....	1-11, 1-16
M101CP6.....	1-11, 1-16
M101CP6C.....	1-11, 1-16
M101CP6HP.....	1-11, 1-16
M101CP6HP010.....	1-11, 1-16
M102CB2.....	1-3, 1-16
M102CB2010.....	1-3, 1-16
M102E.....	1-3, 1-16
M108CP6HP010.....	1-11, 1-16
M132CB6.....	10-9, 10-10
M132CP6.....	10-9, 10-10
M181CB1.....	1-4, 1-16
M181CB1GP.....	1-4, 1-16
M208CP6HP.....	1-12, 1-16
M208CR2A.....	1-6, 1-16
M208CR2B.....	1-6, 1-16
M208CR2B010.....	1-7, 1-16
M2100SB.....	4-9
M2200LSB.....	4-9
M2201SB.....	4-9
M2201SBP.....	4-9
M2201SBR.....	4-9
M254C.....	1-7, 1-16
M254CP6.....	1-12, 1-16
M255GP6.....	1-12, 1-16
M275CP6010.....	11-14, 11-19
M275CP6010G1.....	11-14, 11-19
M280TM1.....	1-7, 1-16
M281C1.....	1-7, 1-16
M281C1B6H.....	1-13, 1-16
M281C1P6H.....	1-12, 1-16
M281C1P6H010.....	1-12, 1-16
M281C1P6HFB.....	1-12, 1-16
M281C1S6H.....	1-12, 1-16
M281C1S6HC.....	1-12, 1-16
M281CB1.....	1-6, 1-16
M281CB1GP.....	1-6, 1-16
M281E1B6H.....	1-13, 1-16
M281E1P6H.....	1-12, 1-16
M281EB1.....	1-6, 1-16
M282C1B6H.....	1-13, 1-16
M282C1C.....	1-7, 1-16
M282C1P6H.....	1-12, 1-16
M282C1P6H010.....	1-12, 1-16
M282C1P6HC.....	1-12, 1-16
M282C1S6H.....	1-12, 1-16

Data subject to change without notice.

Midwest Electric Products
Section 16 – Product Index

Model Number	Page
M282CB1.....	1-6, 1-16
M282CB1C.....	1-6, 1-16
M282E1B6H.....	1-13, 1-16
M282E1P6H.....	1-12, 1-16
M282E1P6H010.....	1-12, 1-16
M282EB1.....	1-6, 1-16
M285T.....	1-7, 1-16
M354C.....	1-3, 1-16, 10-6, 10-10
M354CB6.....	1-11, 1-16
M354CP6.....	1-11, 1-16
M355C010.....	11-7, 11-19
M355C010U.....	9-8, 9-9
M355CP6010.....	11-13, 11-19
M355G.....	11-7, 11-19
M355GB6.....	11-15, 11-19
M355GP4.....	11-16, 11-19
M355GP6.....	11-13, 11-19
M358CP6.....	11-13, 11-19
M654CP6.....	1-12, 1-16
M655GB6.....	11-15, 11-19
M655GP6.....	1-12, 1-16
M655GP6.....	11-14, 11-19
M675CP6010.....	11-14, 11-19
M775CB6010.....	11-15, 11-19
M775CP6010.....	11-14, 11-19
MAUX21D.....	6-5, 6-6
MAUX61S.....	6-5, 6-6
MAUX64D.....	6-5, 6-6
MBSB.....	4-9
MEPKR1AS1BTZ.....	2-3, 2-10
MEPKR1CS1BT.....	2-3, 2-10
MEPKR1DH1DQRZ.....	2-3, 2-10
MEPKR2CS1ET.....	3-3, 3-6
MEPKR3CS1ET.....	3-3, 3-6
MEPKR4CS1ET.....	3-4, 3-6
MEPKR5CS1ET.....	3-4, 3-6
MEPKR6CS1ET.....	3-4, 3-6
MEPKS1AS1BT.....	2-3, 2-10
MEPKS1AS1BTV.....	2-3, 2-10
MEPKS1CS1BJT.....	2-3, 2-10
MEPKS1CS1BJTV.....	2-3, 2-10
MEPKS1CS1DT.....	2-3, 2-10
MEPKS1CS1DTV.....	2-3, 2-10
MEPKS1DS1AT.....	2-3, 2-10
MEPKS1DS1ATV.....	2-3, 2-10
MEPKU1CW3CT.....	2-3, 2-10
MEPKU1FS1EMT.....	2-5, 2-10
MGF221N.....	6-3, 6-6, 6-7
MGF221NR.....	6-3, 6-6, 6-7
MGF222N.....	6-3, 6-6, 6-7
MGF222NR.....	6-3, 6-6, 6-7
MGF223N.....	6-3, 6-6, 6-7
MGF223NR.....	6-3, 6-6, 6-7
MGF224N.....	6-3, 6-6, 6-7
MGF224NR.....	6-3, 6-6, 6-7
MGF321N.....	6-3, 6-6, 6-7

Model Number	Page
MGF321NR.....	6-3, 6-6, 6-7
MGF322N.....	6-3, 6-6, 6-7
MGF322NR.....	6-3, 6-6, 6-7
MGF323N.....	6-3, 6-6, 6-7
MGF323NR.....	6-3, 6-6, 6-7
MGF324N.....	6-3, 6-6, 6-7
MGF324NR.....	6-3, 6-6, 6-7
MGK12.....	4-8
MGK24.....	4-8
MGK32.....	4-8
MGK4.....	4-8
MGK42.....	4-8
MGL1.....	4-8
MGL2.....	4-8, 6-5, 6-6
MGL20.....	4-8
MGL4.....	6-5, 6-6
MGL8.....	4-8
MGR12.....	6-5, 6-6
MGR22.....	6-5, 6-6
MGR42.....	6-5, 6-6
MGU321.....	6-3, 6-6, 6-7
MGU321R.....	6-3, 6-6, 6-7
MGU322.....	6-6, 6-7
MGU3222.....	6-3
MGU322R.....	6-6, 6-7
MGU322R2.....	6-3
MGU323.....	6-6, 6-7
MGU3232.....	6-3
MGU323R.....	6-6, 6-7
MGU323R2.....	6-3
MGU324.....	6-3, 6-6, 6-7
MGU324R.....	6-3, 6-6, 6-7
MHF221N.....	6-4, 6-6, 6-8
MHF221NR.....	6-4, 6-6, 6-8
MHF222N.....	6-4, 6-6, 6-8
MHF222NR.....	6-4, 6-6, 6-8
MHF223N.....	6-4, 6-6, 6-8
MHF223NR.....	6-4, 6-6, 6-8
MHF224N.....	6-4, 6-6, 6-8
MHF224NR.....	6-4, 6-6, 6-8
MHF321N.....	6-4, 6-6, 6-8
MHF321NR.....	6-4, 6-6, 6-8
MHF322N.....	6-4, 6-6, 6-8
MHF322NR.....	6-4, 6-6, 6-8
MHF323N.....	6-4, 6-6, 6-8
MHF323NR.....	6-4, 6-6, 6-8
MHF324N.....	6-4, 6-6, 6-8
MHF324NR.....	6-4, 6-6, 6-8
MHF361.....	6-4, 6-6, 6-8
MHF361R.....	6-4, 6-6, 6-8
MHF362.....	6-4, 6-6, 6-8
MHF362R.....	6-4, 6-6, 6-8
MHF363.....	6-4, 6-6, 6-8
MHF363R.....	6-4, 6-6, 6-8
MHF364.....	6-4, 6-6, 6-8
MHF364R.....	6-4, 6-6, 6-8

Model Number	Page
MHLK2125.....	4-8
MHLK2150.....	4-8
MHLK2200.....	4-8
MHQLRK.....	4-9
MHQLRK1.....	4-9
MHQLRK2.....	4-9
MHQLRK3.....	4-9
MHQLRK4.....	4-9
MHQMVSBF.....	4-9
MHR12.....	6-5, 6-6
MHR16.....	6-5
MHR22.....	6-5, 6-6
MHR26.....	6-5
MHR46.....	6-5, 6-6
MHU361.....	6-6, 6-8
MHU361.....	6-4
MHU361R.....	6-6
MHU361R.....	6-8
MHU361R.....	6-8
MHU361R.....	6-4
MHU362.....	6-4, 6-6, 6-8
MHU362R.....	6-4, 6-6, 6-8
MHU363.....	6-4, 6-6, 6-8
MHU363R.....	6-4, 6-6, 6-8
MHU364.....	6-4, 6-6, 6-8
MHU364R.....	6-4, 6-6, 6-8
ML240RCU.....	4-3, 4-6
ML240SCU.....	4-3, 4-6
ML270RCU.....	4-3, 4-6
ML270SCU.....	4-3, 4-6
ML412C.....	4-6
ML412C2.....	4-3
ML412R1.....	4-3, 4-6
MLK300.....	4-8
MLM1212CCU.....	4-4, 4-6
MLM1212RCU.....	4-4, 4-6
MLM1612CCU.....	4-4, 4-6
MLM1620CCU.....	4-5, 4-6
MLM1620RCU.....	4-5, 4-6
MLM2020CCU.....	4-5, 4-6
MLM2020RCU.....	4-5, 4-6
MLM2412CCU.....	4-4, 4-6
MLM2412RCU.....	4-4, 4-6
MLM2415RCU.....	4-4, 4-6
MLM3220CCU.....	4-5, 4-6
MLM3220RCU.....	4-5, 4-6
MLM4020CCU.....	4-5, 4-6
MLM4020RCU.....	4-5, 4-6
MLM612FCU.....	4-3, 4-6
MLM612RCU.....	4-3, 4-6
MLM612SCU.....	4-3, 4-6
MLM812FCUD.....	4-3, 4-6
MLM812RCU.....	4-3, 4-6
MLM812SCUD.....	4-3, 4-6
MLSB.....	4-9
MLSB2P.....	4-9

Midwest Electric Products
Section 16 – Product Index

Model Number	Page
MLSBF.....	4-9
MLSBR.....	4-9
MLSBS.....	4-9
MM820RCUFL.....	4-5, 4-6
MNG3.....	4-8
MNG6.....	4-8
MNK1.....	6-5, 6-6
MNK2.....	6-5, 6-6
MNK2A.....	6-5, 6-6
MNK3.....	6-5, 6-6
MNK3A.....	6-5, 6-6
MNK4A.....	6-5, 6-6
MNLK20.....	4-8
MNLK250.....	4-8
MPL412R.....	4-3
MPL412R.....	4-6
MQMH000.....	4-12
MS125E.....	1-4, 1-16
MS150C.....	1-4, 1-16
MS150CGP.....	1-4, 1-16
MS151C.....	1-4, 1-17
MS1H.....	14-16
MS1S.....	14-16
MS2453C.....	1-5, 1-17
MS250C.....	1-5, 1-17
MS250CGP.....	1-5, 1-17
MS251C.....	1-5, 1-17
MS252C.....	1-5, 1-17
MS252E014.....	1-5, 1-17
MS45500C.....	1-10, 1-17
MS45508C.....	1-10, 1-17
MS62.....	14-3
MSB.....	4-9
MSB14T.....	14-4
MSBN1A.....	14-16
MSBN4.....	14-16
MSM10014.....	14-16
MSM1009301.....	14-16
MSM100EZ.....	14-16
MSM100P91.....	14-16
MSM200141.....	14-16
MSMP.....	14-16
MSMS.....	14-16
MSR100930.....	14-16
MSR100EZ.....	14-16
MSR100P9.....	14-16
MSR20014.....	14-16
MSRP.....	14-16
MSRS.....	14-16
MW200M.....	14-16
MW200R.....	14-16
NEU100B2.....	14-13
NEU102.....	14-13
NEU202.....	14-13
NEU407.....	14-13
NF65.....	14-7

Model Number	Page
NF652.....	14-8
NI200.....	14-13
NI200A5.....	14-13
NI400A1.....	14-13
NI60B2.....	14-13
P035F.....	7-3, 7-6
P065F.....	7-3, 7-6
P065NA1.....	7-3, 7-6
P065P.....	7-3, 7-6
P065P1.....	7-3, 7-6
P5POST.....	14-2
P6POST.....	14-2
PC2LC.....	14-12
PGT2-20042.....	14-5
PLK50.....	14-5
PNS4-C0002.....	14-5
PR32U.....	14-2
PR33.....	14-2
PR34.....	14-2
PR53.....	14-2
PR54U.....	14-2
PR64U.....	14-2
R011C010.....	9-7, 9-9
R011C010U.....	9-8, 9-9
R011G.....	9-7, 9-9
R031C010.....	11-7, 11-19
R031C010U.....	9-8, 9-9
R036C010.....	9-6, 9-9
R036G.....	9-6, 9-9
R038C010.....	9-7, 9-9
R038C010U.....	9-8, 9-9
R038C033.....	9-7, 9-9
R038C033U.....	9-8, 9-9
R038CP4010.....	9-7, 9-9
R038CP4033.....	9-7, 9-9
R038G.....	9-7, 9-9
R038GU.....	9-8, 9-9
R041C010.....	11-7, 11-19
R041CP6010.....	11-13, 11-19
R041G.....	11-7, 11-19
R041GB6.....	11-15, 11-19
R041GP6.....	11-13, 11-19
R055C010.....	9-6, 9-9
R055C010U.....	9-8, 9-9
R055C033.....	9-6, 9-9
R055C033U.....	9-8, 9-9
R055G.....	9-6, 9-9
R058C.....	10-6, 10-10
R058CB6.....	10-9, 10-10
R058CP6.....	10-9, 10-10
R075C010.....	11-7, 11-19
R075C010U.....	9-8, 9-9
R075CB6010.....	11-15, 11-19
R075CB6010FMG.....	11-15, 11-20
R075CP4010.....	11-16, 11-20
R075CP6010.....	11-13, 11-20

Model Number	Page
R075CP6010FMG.....	11-13, 11-20
R075CP6010Z1.....	11-13, 11-20
R075CP6031.....	11-13, 11-20
R075GB6.....	11-15, 11-20
R075GP6.....	11-13, 11-20
R076C010.....	9-6, 9-9
R076C010U.....	9-8, 9-9
R076C033.....	9-6, 9-9
R100C.....	1-3, 1-17
R100T.....	1-17
R100T4.....	1-3
R101C.....	1-3, 1-17
R101CB2.....	1-3, 1-17
R101CB2010.....	1-3, 1-17
R101CB2ETG.....	1-3, 1-17
R101CB2LK.....	1-3, 1-17
R101CB6.....	1-11, 1-17
R101CB6HP.....	1-11, 1-17
R101CP4.....	1-11, 1-17
R101CP6.....	1-11, 1-17
R101CP6HP.....	1-11, 1-17
R102CB2.....	1-3, 1-17
R102CB2LK.....	1-3, 1-17
R102E.....	1-3, 1-17
R102EN.....	1-3, 1-17
R108CP6HP034.....	1-14, 1-17
R158CR2TLFMG.....	1-4, 1-17
R181CB1.....	1-4, 1-17
R181CB1GP.....	1-4, 1-17
R200T.....	1-7, 1-17
R208CP6HP.....	1-12, 1-17
R208CR2A.....	1-6, 1-17
R208CR2A034.....	1-14, 1-17
R208CR2AETG.....	1-6, 1-17
R208CR2TLFMG.....	1-6, 1-17
R225CP6.....	1-12, 1-17
R2502CP6.....	1-12, 1-17
R255CB6010.....	1-11, 1-17
R255CP6010.....	1-12, 1-17
R256EB1018A.....	1-6, 1-17
R256EB118AETG.....	1-6, 1-17
R256EB118FMG.....	1-6, 1-17
R256EB1A.....	1-6, 1-17
R256EB1AETG.....	1-6, 1-17
R256EB1FMG.....	1-6, 1-17
R256EB1NA.....	1-6, 1-17
R256EB1NAETG.....	1-6, 1-17
R256EB1NFMG.....	1-6, 1-17
R280T.....	1-7, 1-17
R280TP6HP.....	1-7, 1-17
R281C1.....	1-7, 1-17
R281C1034.....	1-14, 1-17
R281C1B6H.....	1-13, 1-17
R281C1B6H034.....	1-15, 1-17
R281C1P6H.....	1-12, 1-17
R281C1P6H034.....	1-15, 1-17

Data subject to change without notice.

Midwest Electric Products
Section 16 – Product Index

Model Number	Page
R281C1P6H4.....	1-12, 1-18
R281C1S6HC	1-12, 1-18
R281CB1	1-6, 1-18
R281CB1034	1-14, 1-18
R281CB1AEP	1-6, 1-18
R281CB1ETG	1-6, 1-18
R281CB1GP	1-6, 1-18
R281CB1LK.....	1-6, 1-18
R281E1B6H.....	1-13, 1-18
R281E1B6H034.....	1-15, 1-18
R281E1P6H.....	1-12, 1-18
R281E1P6H034.....	1-15, 1-18
R281EB1.....	1-6, 1-18
R281EB1034.....	1-14, 1-18
R282C1B6H.....	1-13, 1-18
R282C1P6H.....	1-12, 1-18
R282CB1	1-6, 1-18
R282CB1LK.....	1-6, 1-13, 1-18
R282E1B6H.....	1-13, 1-18
R282E1P6H.....	1-12, 1-18
R282EB1.....	1-6, 1-18
R283CB1	1-6, 1-18
R283CB1AP.....	1-6, 1-18
R28TP6HP	1-17
R32U.....	14-2
R355CP6010	11-13, 11-20
R355CP6031	11-13, 11-20
R355G	11-7, 11-20
R355GP6	11-13, 11-20
R400P6034	1-15, 1-18
R455CP6034	1-15, 1-18
R481C1P6H034.....	1-15, 1-18
RS150C	1-4, 1-18
RS150CGP	1-4, 1-18
RS250C	1-5, 1-18
RS250CGP	1-5, 1-18
RS251C	1-5, 1-18
RS43308C	1-10, 1-18
RS43308CGP	1-10, 1-18
RS45500C	1-10, 1-18
RS45500CAEP.....	1-10, 1-18
RS45508C	1-10, 1-18
RS45508CAEP.....	1-10, 1-18
RS45508CGP	1-10, 1-18
RS45524CFMG.....	1-10, 1-18
S-02S-CA20023E.....	14-6
S-02S-CA20023LCD.....	14-6
SFEM6	14-4
SFEM9	14-4
SNPR1	14-5
STC1.....	7-5
T1206.....	12-3, 12-4
T1210.....	12-3, 12-4
T1220.....	12-3, 12-4
T1240UL.....	12-3, 12-4
T3210.....	12-3, 12-4

Model Number	Page
T3220.....	12-3, 12-4
T3610.....	12-3, 12-4
T3620.....	12-3, 12-4
T3640UL.....	12-3, 12-4
THHQL1115.....	4-11
THHQL1115AF2.....	4-13
THHQL1115DF.....	4-13
THHQL1115GFT.....	4-13
THHQL1115HID	4-14
THHQL1120.....	4-11
THHQL1120AF2.....	4-13
THHQL1120DF.....	4-13
THHQL1120GFT.....	4-13
THHQL1120HID	4-14
THHQL1125.....	4-11
THHQL1125GFT.....	4-13
THHQL1130.....	4-11
THHQL1130GFT.....	4-13
THHQL1130HID	4-14
THHQL1135.....	4-11
THHQL1140.....	4-11
THHQL1145.....	4-11
THHQL1150.....	4-11
THHQL21100.....	4-11, 4-12, 14-10
THHQL21110.....	4-11, 4-12
THHQL21125.....	4-11, 4-12
THHQL2115.....	4-11, 4-12
THHQL2115HID	4-14
THHQL2120.....	4-11, 4-12
THHQL2120HID	4-14
THHQL2125.....	4-11, 4-12
THHQL2130.....	4-11, 4-12
THHQL2130HID	4-14
THHQL2135.....	4-11, 4-12
THHQL2140.....	4-11, 4-12
THHQL2145.....	4-11, 4-12
THHQL2150.....	4-11, 4-12
THHQL2160.....	4-11, 4-12
THHQL2170.....	4-11, 4-12
THHQL2180.....	4-11, 4-12
THHQL2190.....	4-11, 4-12
THQD22100WL	14-10
THQD22200WL	14-10
THQL1115	4-11
THQL1115AF2.....	4-13
THQL1115DF.....	4-13
THQL1115GFEP.....	4-13
THQL1115GFT	4-13, 14-10
THQL1115HID	4-14
THQL1115HM.....	4-14
THQL1115ST1	4-14
THQL1120	4-11, 14-10
THQL1120AF2.....	4-13
THQL1120DF.....	4-13
THQL1120GFEP.....	4-13
THQL1120GFT	4-13, 14-10

Model Number	Page
THQL1120HID	4-14
THQL1120HM.....	4-14
THQL1120ST1.....	4-14
THQL1125	4-11
THQL1125GFT	4-13
THQL1125HM.....	4-14
THQL1130	4-11, 14-10
THQL1130GFEP.....	4-13
THQL1130GFT	4-13, 14-10
THQL1130HID	4-14
THQL1130HM.....	4-14
THQL1130ST1.....	4-14
THQL1135	4-11
THQL1135ST1.....	4-14
THQL1140	4-11, 14-10
THQL1140HM.....	4-14
THQL1140ST1.....	4-14
THQL1145	4-11
THQL1145ST1.....	4-14
THQL115	14-10
THQL1150	4-11, 14-10
THQL1150HM.....	4-14
THQL1150ST1.....	4-14
THQL21100	4-11, 4-12, 14-10
THQL21100ST1	4-14
THQL21110	4-11, 4-12
THQL21125	4-11, 4-12
THQL2115	4-11, 4-12, 14-10
THQL2115GFEP.....	4-13
THQL2115GFT	4-13
THQL2115HID	4-14
THQL2115ST1.....	4-14
THQL2120	4-11, 4-12, 14-10
THQL2120GFEP.....	4-13
THQL2120GFT	4-13, 14-10
THQL2120HID	4-14
THQL2120ST1.....	4-14
THQL2125	4-11, 4-12
THQL2125GFT	4-13
THQL2130	4-11, 4-12, 14-10
THQL2130GFEP.....	4-13
THQL2130GFT	4-13, 14-10
THQL2130HID	4-14
THQL2130ST1.....	4-14
THQL2135	4-11, 4-12
THQL2135ST1.....	4-14
THQL2140	4-11, 4-12, 14-10
THQL2140GFT	4-13, 14-10
THQL2140ST1.....	4-14
THQL2145	4-11, 4-12
THQL2145ST1.....	4-14
THQL2150	4-11, 4-12, 14-10
THQL2150GFT	4-13, 14-10
THQL2150ST1.....	4-14
THQL2160	4-11, 4-12, 14-10
THQL2160ST1.....	4-14

Midwest Electric Products
Section 16 – Product Index

Model Number	Page
THQL2170	4-11, 4-12, 14-10
THQL2170ST1	4-14
THQL2180	4-11, 4-12
THQL2180ST1	4-14
THQL2190	4-11, 4-12
THQL2190ST1	4-14
THQMV100D	4-12
THQMV125D	4-12
THQMV150D	4-12
THQMV150WLBP	14-10
THQMV175D	4-12
THQMV200D	4-12
THQMV200WLBP	14-10
THQMV225D	4-12
THQP115	4-11, 14-10
THQP120	4-11, 14-10
THQP125	4-11
THQP130	4-11
THQP135	4-11
THQP140	4-11
THQP145	4-11
THQP150	4-11
THQP215	4-11
THQP220	4-11, 14-10
THQP225	4-11
THQP230	4-11, 14-10
THQP235	4-11
THQP240	4-11
THQP245	4-11
THQP250	4-11, 14-10
TQD22100WL	14-10
TQD22150WL	14-10
TQD22200WL	14-10
TQDL	14-10
TTV001	14-3
TTV001T	14-3
TTV100	14-3
TTV100T	14-3
TTV150	14-3
TTV150T	14-3
TVTV200	14-3
TXQL1115	4-11
TXQL1120	4-11
TXQL1125	4-11
TXQL1130	4-11
TXQL2115	4-11
TXQL2120	4-11
TXQL2125	4-11
TXQL2130	4-11
U002C	10-5, 10-10
U004CB4010	11-12, 11-20
U004CB6010	11-12, 11-20
U004CP4010	11-9, 11-20
U004CP4031	11-9, 11-20
U004CP6010	11-9, 11-20
U004CP6L10	11-9, 11-20

Model Number	Page
U004CTL010	10-6, 10-10
U004F	10-6, 10-10
U01	14-4
U010	10-3, 10-10
U010010	10-3, 10-10
U010010GRP	10-7, 10-10
U010C	10-4, 10-10
U010C010	11-5, 11-20
U010C025	10-7, 10-10
U010F	10-3, 10-10
U010G	11-5, 11-20
U010H	10-3, 10-10
U010S010	10-7, 10-10
U010S010GRP	10-7, 10-10
U010SEP	10-3, 10-10
U011	10-3, 10-10
U011010	10-3, 10-10
U011C010	11-5, 11-20
U011CP4010	11-8, 11-20
U011CP6010	11-8, 11-20
U011CTL010	11-6, 11-20
U011F	10-4, 10-10
U011G	11-5, 11-20
U011GB4	11-11, 11-20
U011GB6	11-11, 11-20
U011GP4	11-8, 11-20
U011GP6	11-8, 11-20
U011GTL	11-6, 11-20
U012010	10-3, 10-10
U012010GRP	10-7, 10-10
U013	10-3, 10-10
U013C	10-3, 10-10
U013F	10-3, 10-10
U014C010	10-10
U014C0102	10-5
U014CP6010	10-5, 10-10
U014GWTR	10-6, 10-10
U023	10-4, 10-10
U025S	10-7, 10-10
U030	9-3, 9-10
U031C010	11-6, 11-20
U0353F	7-3, 7-6
U0353F010	7-4, 7-6
U035F010	7-4, 7-6
U035F2	7-3, 7-6
U036C010	9-3, 9-10
U036C033	9-3, 9-10
U036G	9-3, 9-10
U038C010	9-5, 9-10
U038C033	9-5, 9-10
U038CTL010	9-5, 9-10
U038CTL033	9-5, 9-10
U038G	9-5, 9-10
U038G033	9-5, 9-10
U039G6	9-5, 9-10
U04	4-9, 14-4

Model Number	Page
U040G	11-5, 11-20
U040GP4	11-8, 11-20
U040GP6	11-8, 11-20
U040GP6010	11-8, 11-20
U040GTL	11-6, 11-20
U041	10-4, 10-10
U041010	10-4, 10-10
U041C	10-5, 10-10
U041C010P	11-5, 11-20
U041CB4010	11-11, 11-20
U041CB4L10	11-18, 11-20
U041CB6010	11-11, 11-20
U041CB6L10	11-18, 11-20
U041CP4010	11-8, 11-20
U041CP4031	11-8, 11-20
U041CP4L10	11-18, 11-20
U041CP6010	11-8, 11-20
U041CP6031	11-8, 11-20
U041CP6L10	11-18, 11-20
U041CTL010	11-6, 11-20
U041CTLL10	11-17, 11-20
U041F	10-4, 10-10
U041G	11-5, 11-20
U041GB4	11-11, 11-20
U041GB6	11-11, 11-20
U041GP4	11-8, 11-20
U041GP4L	11-18, 11-20
U041GP6	11-8, 11-20
U041GP6L	11-18, 11-20
U041GTL	11-6, 11-21
U042GB6	11-11, 11-21
U042GP6	11-8, 11-21
U043GP6	11-8, 11-21
U045F	7-4, 7-6
U050	10-4, 10-10
U050C	10-5, 10-10
U051C	9-4, 9-10
U051C010	9-4, 9-10
U051C033	9-4, 9-10
U051F	10-4, 10-10
U051G	9-4, 9-10
U054	10-4, 10-10
U054C	9-4, 9-10
U054F	10-4, 10-10
U055010	10-4, 10-10
U055C010P	9-4, 9-10
U055C033	9-4, 9-10
U055CP4010	11-8, 11-21
U055CP6010	11-8, 11-21
U055F	10-4, 10-10
U055G	9-4, 9-10
U055GB6	11-11, 11-21
U058C	10-5, 10-10
U058CB6	10-8, 10-10
U058CP6	10-8, 10-10
U061C	10-4, 10-10

Data subject to change without notice.

Midwest Electric Products
Section 16 – Product Index

Model Number	Page	Model Number	Page	Model Number	Page
U061CB6	10-8, 10-10	U101CP6	1-13, 1-18	U775CP6010	11-9, 11-21
U061CP6	10-8, 10-10	U102E	1-8, 1-18	U870G6	10-6, 10-11
U061CTL	10-5, 10-10	U102EP6	1-13, 1-18	U92197CCCPLMEP	2-3, 2-10
U0653F	7-3, 7-6	U12	14-4	UAFHTRS202BSHMEP	2-3, 2-10
U0653F010	7-4, 7-6	U131CP6010	11-9, 11-21	UAFHTRS223ASHMEP	2-3, 2-10
U0653P	7-3, 7-6	U131CTL010	11-6, 11-21	UAFTH4330TSHMEP	2-5, 2-10
U0653P010	7-3, 7-6	U132CB6	10-8, 10-10	UAFTH4336TSHMEP	2-5, 2-10
U065F010	7-4, 7-6	U132CP6	10-8, 10-10	UAFTH5213BNDMEP	2-8, 2-10
U065F1	7-3, 7-6	U132CTL	10-5, 10-10	UAFTH7213TSHMEP	2-6, 2-10
U065NA1	7-4, 7-6	U15	14-4	UAFTH7330TSHMEP	2-7, 2-10
U065NA1010	7-4, 7-6	U175CP6HP010	11-9, 11-21	UAFTH7336TSHMEP	2-7, 2-10
U065NA2	7-4, 7-6	U180C1	1-9, 1-18	UATH4203BFLMEP	2-4, 2-10
U065P	7-3, 7-6	U181C1	1-9, 1-18	UATH4203TFLMEP	2-4, 2-10
U065P010	7-4, 7-6	U20	14-4	UATH4213CFLMEP	2-4, 2-10
U065PC2	7-4, 7-6	U208C	1-9, 1-18	UATH4213UFLMEP	2-4, 2-10
U065PD	7-3, 7-6	U208CP6HP	1-13, 1-18	UATH4300TFLMEP	2-5, 2-10
U070C	10-5, 10-10	U220H	7-5, 7-6	UATH5203BFLMEP	2-8, 2-10
U072C	9-5, 9-10	U239G	10-6, 10-11	UATH5203TFLMEP	2-8, 2-10
U073G	9-5, 9-10	U25	14-4	UATH5213CFLMEP	2-8, 2-10
U074GTL	11-6, 11-21	U261F	7-5, 7-6	UATH5213UFLMEP	2-8, 2-10
U075C	10-5, 10-10	U27	4-9, 14-4	UATH5300TFLMEP	2-8, 2-10
U075CB4010	11-12, 11-21	U28	4-9, 14-4	UATH5330UFLMEP	2-8, 2-10
U075CB4031	11-12, 11-21	U280C1	1-9, 1-18	UATH7203BFLMEP	2-6, 2-10
U075CB4L10	11-18, 11-21	U281C1	1-9, 1-18	UATH7203TFLMEP	2-6, 2-10
U075CB6010	11-12, 11-21	U281C1P6H	1-13, 1-18	UATH7213CFLMEP	2-6, 2-10
U075CB6031	11-12, 11-21	U281E1	1-9, 1-18	UATH7213UFLMEP	2-6, 2-10
U075CB6L10	11-18, 11-21	U281E1P6H	1-13, 1-18	UATH7300TFLMEP	2-7, 2-10
U075CP4010	11-9, 11-21	U2R2332UMEP	3-3, 3-6	UATH7300UFLMEP	2-7, 2-11
U075CP4010Z1	11-9, 11-21	U30	4-9, 14-4	UATH7330UFLMEP	2-7, 2-11
U075CP4031	11-9, 11-21	U35	4-9, 14-4	UATRS202BFLMEP	2-4, 2-11
U075CP4L10	11-18, 11-21	U354C	1-8, 1-18	UATRS212CFLMEP	2-4, 2-11
U075CP4L31	11-18, 11-21	U354C	10-5, 10-11	UATRS213AFLMEP	2-4, 2-11
U075CP6010	11-9, 11-21	U355C010	11-6, 11-21	UATRS213CFLMEP	2-4, 2-11
U075CP6010BZ	11-9, 11-21	U355G	11-6, 11-21	UATRS223AFLMEP	2-4, 2-11
U075CP6010D	11-9, 11-21	U355GP6	11-9, 11-21	UATZRS101CFLMEP	2-3, 2-11
U075CP6010T	11-9, 11-21	U361G	10-5, 10-11	UBC7213BMEP	2-6, 2-11
U075CP6031	11-9, 11-21	U40	4-9, 14-4	UBH2R1121BMEP	3-3, 3-6
U075CP6L10	11-18, 11-21	U412CP6010	11-8, 11-21	UBH2R2332TMEP	3-3, 3-6
U075CP6L31	11-18, 11-21	U412G	11-5, 11-21	UBH3R1121BMEP	3-3, 3-6
U075CP6L31BZ	11-18, 11-21	U412GP6	11-8, 11-21	UBH3R2332TMEP	3-3, 3-6
U075CTL010	11-6, 11-21	U501	10-4, 10-11	UBH7213TMEP	2-6, 2-11
U075CTL035	11-17, 11-21	U511C	10-5, 10-11	UBHRS101BMEP	2-3, 2-11
U075CTLL10	11-17, 11-21	U511G	10-5, 10-11	UBHRS202BMEP	2-4, 2-11
U075GB6	11-12, 11-21	U546	10-5, 10-11	UBHRS212BMEP	2-4, 2-11
U075GP4	11-9, 11-21	U550F	10-4, 10-11	UBTH4330TMEP	2-9
U075GP4L	11-18, 11-21	U610F	7-4, 7-6	UFHT2R2332TMEP	3-3, 3-6
U075GP6	11-9, 11-21	U611CB4010	11-12, 11-21	UFHT3R2332TMEP	3-3, 3-6
U075GP6019	11-9, 11-21	U611CB6010	11-12, 11-21	UFHT4R2352TMEP	3-4, 3-6
U075GP6C	11-9, 11-21	U611CP4010	11-9, 11-21	UFHT5R2392TTMEP	3-4, 3-6
U075GP6L	11-18, 11-21	U611CP6010	11-9, 11-21	UFHT6R2392TTMEP	3-4, 3-6
U075GTL	11-6, 11-21	U611CTL010	11-5, 11-21	UFHTRS101BMEP	2-3, 2-11
U076C010	9-5, 9-10	U611GTL	11-5, 11-21	UFHTRS202BMEP	2-4, 2-11
U076C033	9-5, 9-10	U614C	10-5, 10-11	UFHTRS223AMEP	2-4, 2-11
U076G	9-5, 9-10	U666C010	10-5, 10-11	UFHTRS233CMEP	2-4, 2-11
U10	14-4	U775C010	11-6, 11-21	UFTH4213CMEP	2-4, 2-11
U101C	1-8, 1-18	U775CP4010	11-9, 11-21	UFTH4330TMEP	2-5, 2-11

Data subject to change without notice.

Midwest Electric Products
Section 16 – Product Index

Model Number	Page
UFTH4336TMEP	2-5, 2-11
UFTH5213BNDMEP	2-8, 2-11
UFTH7213BMEP	2-6, 2-11
UFTH7213TMEP	2-6, 2-11
UFTH7330TMEP	2-7, 2-11
UFTH7336TMEP	2-7, 2-11
UFTTH7213TMEP	2-6, 2-11
UFTTH7330TMEP	2-7, 2-11
UFTTH7336TMEP	2-7, 2-11
UG2R5332CKCMEP	3-3, 3-6
UG412RMW250	5-2
UG412RMW260	5-2
UGHRS212CKCMEP	2-4, 2-11
UGHTRS101BMEP	2-3, 2-11
UGHTRS213BMEP	2-4, 2-11
UGT2-20015	14-5
UGTH4213CMEP	2-4, 2-11
UGTH4330TMEP	2-9
UGTRS213CMEP	2-4, 2-11
UH4213CMEP	2-4, 2-11
UH43068TCPLMEP	2-5, 2-11
UH60G	14-6
UH7213CKCMEP	2-6, 2-11
UH7213CMEP	2-6, 2-11
UH90G	14-6
UH90GT	14-6
UH90STL	14-6
UHT2-20011	14-5
UHT2R2332TMEP	3-3, 3-6
UHT3R2332TMEP	3-3, 3-6
UHT4R2352TMEP	3-4, 3-6
UHT6R2392TTMEP	3-4, 3-6
UHTRS101BMEP	2-3, 2-11
UHTRS202BMEP	2-4, 2-11
UHTRS223AMEP	2-4, 2-11
UL412RMW	1-8, 1-18
URS101BCPLMEP	2-3, 2-11
URS101CCPLMEP	2-3, 2-11
URSTS132CMEP	2-6, 2-11
URTRS213AMEP	2-4, 2-11
UT2R1121BMEP	3-3, 3-6
UT2R2332TMEP	3-3, 3-6
UT2R2332UFLMEP	3-3, 3-6
UT2R5332BMEP	3-3, 3-6
UT3R1121BMEP	3-3, 3-6
UT3R2332TMEP	3-3, 3-6
UT3R2332UFLMEP	3-3, 3-6
UT3R5632BMEP	3-3, 3-6
UT4R1121BMEP	3-4, 3-6
UT4R2352TMEP	3-4, 3-6
UT4R2352UFLMEP	3-4, 3-6
UT4R5632BMEP	3-4, 3-6
UT5R1121BMEP	3-4, 3-6
UT5R2392TTMEP	3-4, 3-6
UT5R2392UUFLMEP	3-4, 3-6
UT6R1131BMEP	3-4, 3-6

Model Number	Page
UT6R2392TTMEP	3-4, 3-6
UT6R2392UUFLMEP	3-4, 3-6
UT92197CCFLMEP	2-4, 2-11
UTH4203BFLMEP	2-4, 2-11
UTH4203TFLMEP	2-4, 2-11
UTH4213BMEP	2-4, 2-11
UTH4213CFLMEP	2-4, 2-11
UTH4213CMEP	2-4, 2-11
UTH4213UFLMEP	2-4, 2-11
UTH4300TFLMEP	2-5, 2-11
UTH4300TMEP	2-5, 2-11
UTH4330TMEP	2-5, 2-9, 2-11
UTH43369TMEP	2-5, 2-11
UTH5203BFLMEP	2-8, 2-11
UTH5203BMEP	2-8, 2-12
UTH5203TFLMEP	2-8, 2-12
UTH5213BNDMEP	2-8, 2-12
UTH5213CFLMEP	2-8, 2-12
UTH5213CMEP	2-8, 2-12
UTH5213UFLMEP	2-8, 2-12
UTH5233CMEP	2-8, 2-12
UTH5300TFLMEP	2-8, 2-12
UTH5330UFLMEP	2-8, 2-12
UTH7203BFLMEP	2-6, 2-12
UTH7203TFLMEP	2-6, 2-12
UTH7203TMEP	2-6, 2-12
UTH7213BMEP	2-6, 2-12
UTH7213CMEP	2-6, 2-12
UTH7213THLMEP	2-6, 2-12
UTH7213TMEP	2-6, 2-12
UTH7213UMEP	2-6, 2-12
UTH7300TFLMEP	2-7, 2-12
UTH73069THLMEP	2-5, 2-12
UTH7330TMEP	2-7, 2-12
UTH7330UFLMEP	2-7, 2-12
UTH73369THLMEP	2-7, 2-12
UTJ7300UMEP	2-7, 2-12
UTRS101BMEP	2-3, 2-12
UTRS202BMEP	2-4, 2-12
UTRS212BMEP	2-4, 2-12
UTRS212CMEP	2-4, 2-12
UTRS2138BMEP	2-5, 2-12
UTRS213AFLMEP	2-5, 2-12
UTRS213BMEP	2-5, 2-12
UTRS213CFLMEP	2-5, 2-12
UTRS213CMEP	2-5, 2-12
UTRS223AFLMEP	2-5, 2-12
UTRS223AMEP	2-5, 2-12
UTRS502BMEP	2-3, 2-12
UTTH4330TMEP	2-9
UTZ2R1121CFLMEP	3-3, 3-6
UTZ3R1121CFLMEP	3-3, 3-6
UTZ4R1121CFLMEP	3-4, 3-6
UTZ5R1121CFLMEP	3-4, 3-6
UTZ6R1131CFLMEP	3-4, 3-6
UTZRS101CFLMEP	2-3, 2-12

Model Number	Page
UWATER34	14-6
UWATER34L	14-6
UWATER34WN	14-6

Product Index

Data subject to change without notice.

Notes

Notes

Information provided is subject to change without notice. Please verify all details with Midwest Electric Products. All values are design or typical values when measured under laboratory conditions, and Midwest makes no warranty or guarantee, express or implied, that such performance will be obtained under end-use conditions.

Midwest Electric Products
41 Woodford Avenue
Plainville, CT 06062
Customer Service: 866-685-0577 • Fax: 804-965-1041
www.midwestelectric.com

© 2018 Midwest Electric Products

MET017G (3/18)



Midwest Electric Products

General Products Catalog



Markets



Contents

Introduction	i-1 – i-4
Service Equipment	1-1 – 1-28
Single Socket Metering	2-1 – 2-16
Horizontal Meter Sockets	3-1 – 3-10
Load Centers / Circuit Breakers	4-1 – 4-14
Spa Panels	5-1 – 5-2
Safety Switches	6-1 – 6-10
AC Disconnects	7-1 – 7-8
Transfer Switches / Power Inlets	8-1 – 8-8
Temporary Power	9-1 – 9-12
Power Outlets	10-1 – 10-14
RV Park Equipment	11-1 – 11-34
Terminal Boxes	12-1 – 12-4
Transformers	13-1 – 13-32
Parts/Accessories / Application Data	14-1 – 14-18
Authorized Reps	15-1 – 15-2
Product Index	16-1 – 16-15

Introduction

How To Use This Catalog

Midwest Electric Products is pleased to offer our product catalog. Model numbers are illustrated with a layout drawing and data table. (See Fig. 1 as an example.) A technical table (see Fig. 2) at the end of each section shows specific information including replacement parts, cabinet dimensions, enclosure styles and knockout configurations. Also, for quick reference, a Product Index is located on pages 16-1–16-12.

Each of the indexed sections of the catalog are clearly marked with tabs on each page contained within that section.

For quick reference, heads clearly identify model type, amp range and voltage of product group shown.

An easy to understand diagram illustrates the model's internal component configuration.

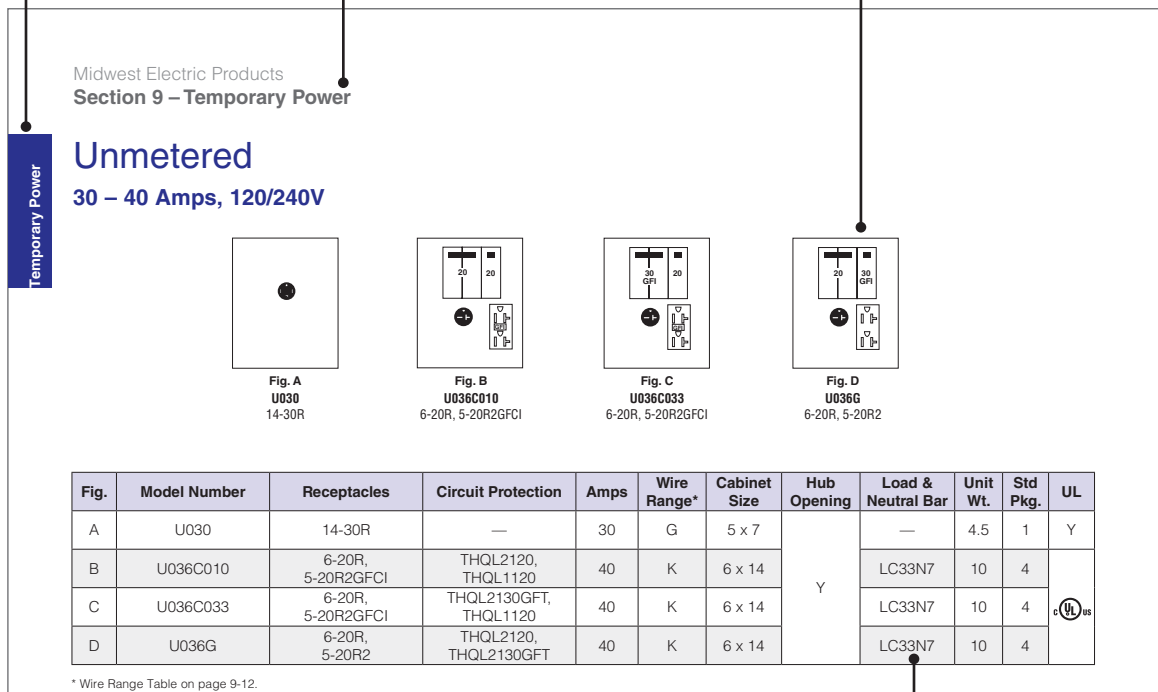

Fig. 1
 Partial catalog page showing model layout drawings and data table.

Each diagram corresponds to defining data in an accompanying table. Tables are arranged in ascending amperage order for each product group and contain all necessary ordering information.

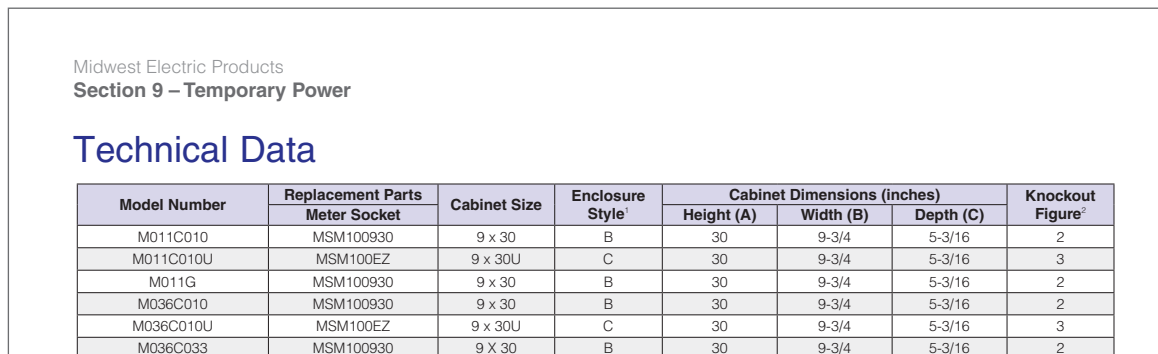
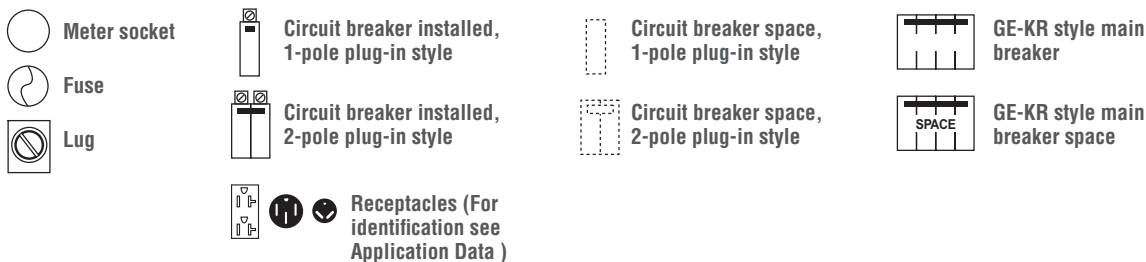

Fig. 2
 Partial catalog page showing a Technical Data table.

Catalog Keys

Model Diagram Symbols



Model Number System

Model numbers are based on the following system.
Example: Model Number U041CP6010.

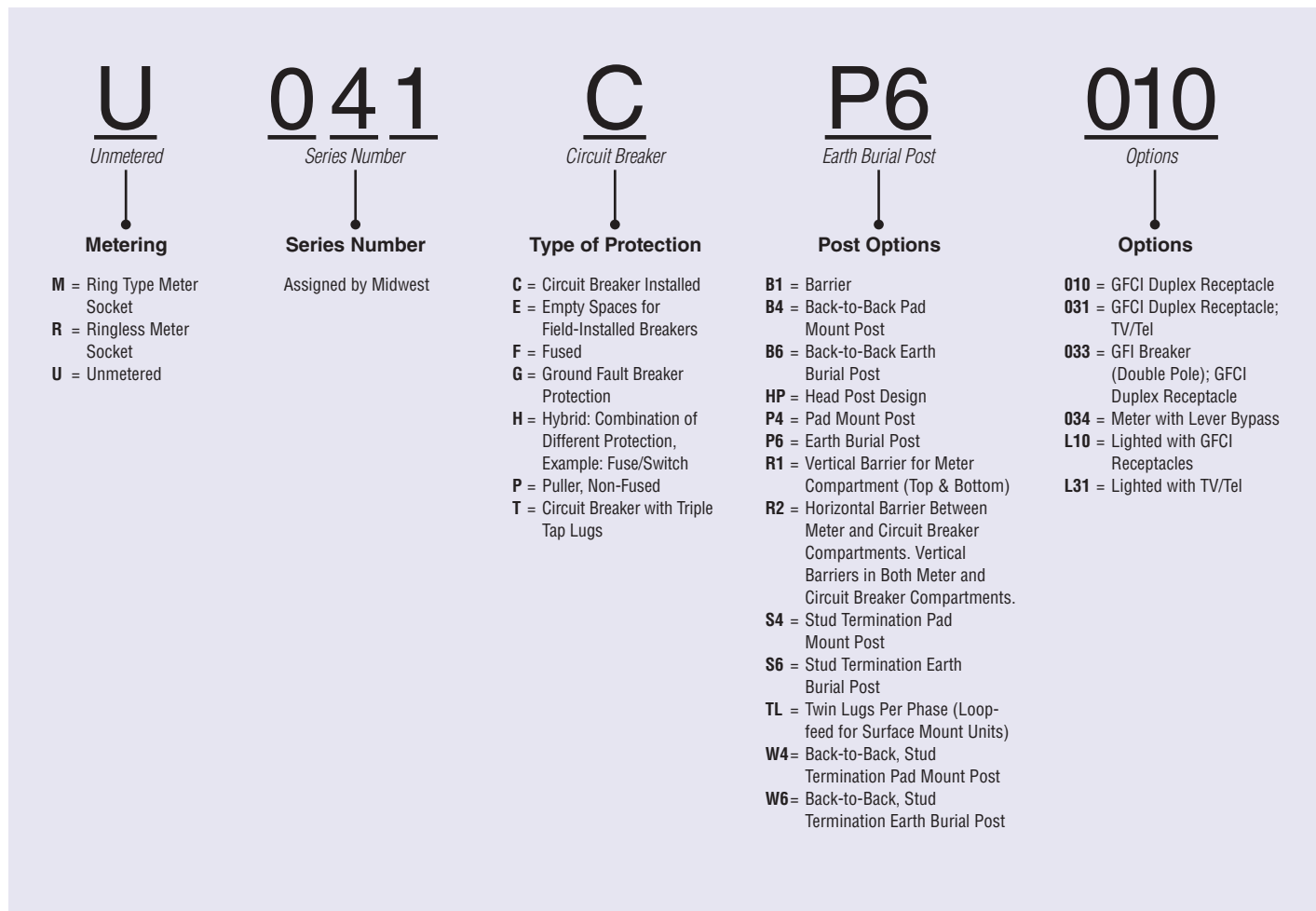

Introduction

Product Features

Surface Unit

- NEMA 3R weatherproof construction
- G90 galvanized steel construction for superior corrosion resistance
- Durable polyester powder coat finish resists chipping and fading
- All components factory wired and assembled, reducing installation time
- Door removable for installation ease; stay open position for user convenience
- All terminals accept copper or aluminum wire for added installation flexibility
- Wide range of receptacle configurations
- Broad range of concentric knockouts to accommodate varied wiring needs
- All units with factory installed Cu/Al equipment ground lug
- Dead front construction prevents accidental contact with live parts
- Padlock provision to prevent unauthorized access
- Rolled edge door for cord protection
- Conforms to NEC and NEMA standards



U055C010

Pedestal Unit

- NEMA 3R weatherproof construction
- G90 galvanized steel construction for superior corrosion resistance
- Durable polyester powder coat finish resists chipping and fading
- All components factory wired and assembled, reducing installation time
- Door removable for installation ease; stay open position for user convenience
- All terminals accept copper or aluminum wire for added installation flexibility
- Loop-feed terminals for maximum flexibility
- Single or double cabinet posts for fast and economical multiple site applications
- Barriers available for line, load and meter socket isolation
- Utility accepted meter sealing accommodations
- Pad mount posts available
- Dead front construction prevents accidental contact with live parts
- Padlock provision to prevent unauthorized access
- Rolled edges on all post wire entry points
- Conforms to NEC and NEMA standards



M255GP6

Electrical Data and Wiring Information

All equipment manufactured by Midwest Electric Products contains a label located on the inside of the door which gives electrical data and wiring information for the unit. On select models the label also lists the renewal parts for the unit. Pictured below is a sample label.

TYPICAL WIRING DIAGRAM
 8 POLES MAX 6-20 AWG CU/AL
 MAX BRANCH OR MAIN CIRCUIT BREAKER RATING 125 AMP

SEE NOTE 1:

UL LISTED
 CLASS CTL PANELBOARD LOAD CENTER
 E68341 Vol 1
 ISSUE NUMBER C-3024

NOTE 1:
 * THERE ARE 3 LUGS ON THE BREAKER
 * INSERT WHITE LOAD WIRE IN LUG MARKED
 * W/WHY 001
 * SEE DIAGRAM

USE ONLY WITH GE TYPE THQP, THQP, THQL, THQL, THXL, THXL, THQL-QFCL, THQL-QFCL, SIEMENS TYPE QFF OR MIDWEST TYPE MHQL BREAKERS 50 AMP MAX

WARNING
 THE CIRCUIT BREAKER IN THIS BOX HAVE BEEN SELECTED TO PROTECT THE WIRING, TO AVOID DAMAGE AND LOSS OF PROTECTION, DO NOT REPLACE WITH HIGHER AMPERE RATED BREAKERS, IF CHANGES ARE NECESSARY CALL A QUALIFIED ELECTRICAL CONTRACTOR

IF BREAKER TRIPS HANDLE WILL BE IN INTERMEDIATE POSITION TO RESTORE SERVICE
 1. MOVE HANDLE TO 'OFF' POSITION
 2. THEN TO 'ON' POSITION

WHEN INSTALLED IN ACCORDANCE WITH THE NEC, UNIT IS NOT SUITABLE FOR USE AS SERVICE EQUIPMENT. MAXIMUM CONTINUOUS LOADS ON BRANCH CIRCUITS NOT TO EXCEED 80% OF THE RATINGS OF THE CIRCUIT BREAKERS EMPLOYED IN OTHER THAN MOTOR CIRCUITS. LES CHARGES CONTINUES MAXIMALES POUR LES DERIVATIONS NE COUVRENT PAS ETRE SUPERIEURES A 80% DU COURANT NOMINAL DES DISJONCTEURS UTILISES POUR DES CIRCUITS AUTRES QUE DES CIRCUITS DE MOTEURS.

USE COPPER OR ALUMINUM WIRE
 USE 60°C OR 75°C AMPACITY SIZED WIRE ON LINE AND NEUTRAL TERMINALS. SEE CIRCUIT BREAKERS FOR THEIR WIRE TEMPERATURE RATING

ALUMINUM TERMINATIONS TO HELP GUARD AGAINST OVER-HEATING WHEN CONNECTING ALUMINUM WIRE IN CU/AL LUG, REMOVE OXIDE FILM FROM WIRE AND PROTECT IT WITH OXIDE INHIBITING COMPOUND.

SUITABLE FOR USE AS SERVICE EQUIPMENT WHEN NOT MORE THAN 6 MAIN DISCONNECTS ARE PROVIDED WHEN NOT USED AS A LIGHTING AND APPLIANCE BRANCH CIRCUIT PANELBOARD. SEE ARTICLE 384-14 OF THE NEC.

THE SHORT CIRCUIT RATING OF THIS PANELBOARD IS EQUAL TO THE LOWEST INTERRUPTING RATING OF ANY INSTALLED CIRCUIT BREAKER BUT NOT MORE THAN 10,000 RMS SYMMETRICAL AMPERES AT 240V SINGLE PHASE

⚡ DANGER
 HAZARD OF ELECTRICAL SHOCK OR BURN. TURN OFF POWER BEFORE WORKING INSIDE THIS EQUIPMENT.

RAINPROOF CONDUIT HUBS

CONDUIT SIZE	3/4	1	1 1/4	1 1/2	2	2 1/2
CAT No.	807	810	813	815	820	825

NEUTRAL AND EQUIPMENT GROUND WIRE

	SOLID		STRANDED	
	AWG	CU	AWG	CU
LARGE HOLES	14-8	CU	10-4	CU
SMALL HOLES	12-6	CU	10-4	AL
LARGE HOLES	14-8	CU	12-8	CU
SMALL HOLES	12-6	AL	12-8	AL

SLOTTED WIRE

AWG WIRE	MIN LB-IN	MAX LB-IN
14-10	32	35
8	38	40
8-4	41	45
2-20	45	50

WIRE CONNECTOR TERMINAL SCREW TIGHTENING TORQUE APPLIES ONLY TO LINE, NEUTRAL AND EQUIPMENT GROUND TERMINALS

SAL | MADE IN MEXICO | PLANT SAL | MIDWEST ELECTRIC PRODUCTS | 41 WOODFORD AVENUE | PLAINVILLE, CT 06062 | WWW.MIDWESTELECTRIC.COM

Warranty

The Company warrants to the Purchaser that the equipment to be delivered hereunder will be free from defects in material or workmanship and will be of the kind and quality designated or specified in the contract.

This warranty shall apply only to defects appearing within *one year from the date of shipment* by the Company.

If the equipment delivered hereunder does not meet the above warranty, and if the Purchaser promptly notifies the Company, the Company shall thereupon correct any defect including nonconformance with the specifications either (at its option), by repairing any defective or damaged parts of the equipment, or by making available at the Company's plant necessary repaired or replacement parts. The liability of the Company under this warranty (except as to title), or for any loss or damage to the equipment whether the claim is based on contract or negligence, shall not in any case exceed the cost of correcting defects in the equipment as herein provided and upon the expiration of the warranty period all such liability shall terminate. The foregoing shall constitute the exclusive remedy of the Purchaser and the exclusive liability of the Company.

The foregoing warranty is exclusive and in lieu of all other warranties, whether written, oral, implied, or statutory (except as to title). **No warranty of merchantability or fitness for purpose shall apply.** The Company does not warrant any equipment of other manufacture designated by Purchaser.

Section 1

Service Equipment



Application Information

Where electrical power enters a building or other structure, the National Electrical Code (NEC) requires electrical distribution equipment rated as “Service Entrance.” Such service equipment usually consists of one main breaker disconnect or space for up to 6 main disconnects. Midwest models meet these NEC requirements and are UL listed as service entrance equipment.

Service entrance products are typically utilized on single family residences and mobile homes. Additionally, service entrance for mobile homes is generally located within 30 feet of the mobile home. This location requirement by the NEC and the common use of underground service feeders, combine to make service entrance on a pedestal the preferred installation method by many park owners. Midwest offers a broad range of pedestal units, factory assembled and wired, with loop feed lugs to reduce installation time and labor expense. Midwest also offers a wide selection of surface units for single family residences and mobile home sites.

Specifications and Features

- Rated for use as service equipment
- NEMA 3R weatherproof enclosure
- G90 galvanized steel construction for superior corrosion protection
- Durable polyester powder coat finish resists chipping and fading
- Metered and unmetered construction available up to 200 Amps
- All-in-one construction available up to 400 Amps
- Available in surface or pedestal mount construction
- Segregated meter compartment for utility power protection
- Weather resistant and tamper resistant GFCI receptacles
- Horn bypass comes standard on ringless metered units
- Cu/Al rated field terminations
- Factory installed Cu/Al equipment ground lug
- Padlock provision to prevent unauthorized entry
- UL Listed (Panelboards No. 67)



Post Models

- Factory wired on loop feed lugs on 200 Amp models
- Removable post door allows lay in wiring
- Rolled edges to protect service cable
- Locking hasp for utility seal on post covers
- Stud terminations available to accept compression type lugs

Metered

Surface, 100 Amps, 120/240V

Service Equipment

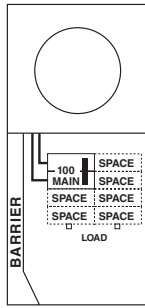

Fig. A
M101CB2, R101CB2, R101CB2ETG
Series

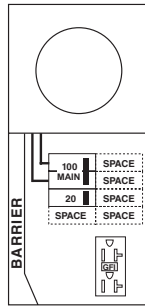

Fig. B
R101CB2010
Series

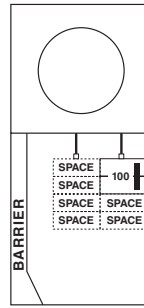

Fig. C
M102CB2, R102CB2
Parallel

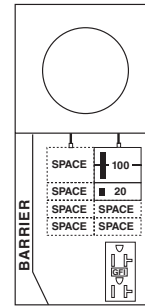

Fig. D
M102CB2010
Parallel

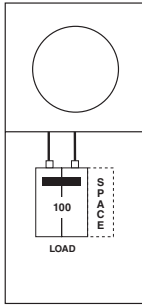

Fig. E
M100C, R100C
Parallel

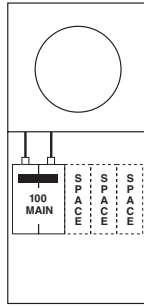

Fig. F
M101C, R101C
Series

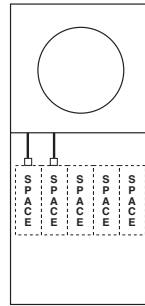

Fig. G
M102E, R102E
Parallel

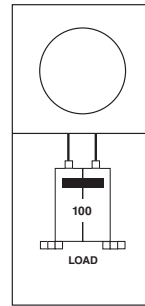

Fig. H
M100T, R100T
Series

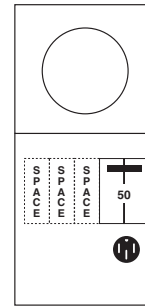

Fig. I
M354C
Series

Overhead/Underground Feed

Fig.	Model Number		Circuit Protection	Amps	Spaces	Wire Range ⁺	Cabinet Size	Load Center	Unit Wt.	Std Pkg.	UL and Utility Approved
	Ring Type	Ringless									
A	M101CB2	R101CB2, ¹ R101CB2ETG	THQL21100	100	6	AN	14 x 26	LC88PC	38	1	UL, ETG
B	—	R101CB2010	THQL21100, THQL1120	100	5						UL
C	M102CB2	R102CB2 ¹	THQL21100	100	6						
D	M102CB2010	—	THQL21100, THQL1120	100	5						

Overhead Feed

Fig.	Model Number		Circuit Protection	Amps	Spaces	Wire Range ⁺	Cabinet Size	Load Center	Unit Wt.	Std Pkg.	UL
	Ring Type	Ringless									
E	M100C	R100C	THQL21100	100	1	AB	9 x 30	LC33N1	24	1	Y
F	M101C ³	R101C	THQL21100	100	3	AB	9 x 30	LC55N1	25		
G	M102E	R102E ²	—	100	5	AB	9 x 30	LC55N1	24		
H	M100T ⁴	R100T ⁴	CBT2102	100	0	AB	9 x 30	LC32X1	24		
I	M354C	—	THQL2150	100	3	AD	9 x 30	LC55N1	25		

¹ Available with barrel – R101CB2LK and R102CB2LK.

² Available with neutral, order R102EN. Consult representative/utility for local utility acceptance.

³ Available with copper wire, order M101CC.

⁴ "Triple-Tap" - 3 load lugs per phase.

⁺ Wire Range Table on page 1-24.

Metered

Surface, Side-by-Side, 125 – 150 Amps, 120/240V

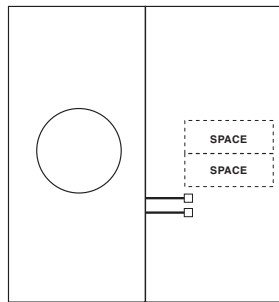

Fig. A
MS125E
 Series

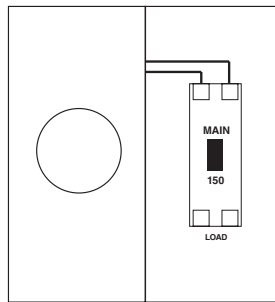

Fig. B
MS150C, MS150CGP, RS150C, RS150CGP
 Series

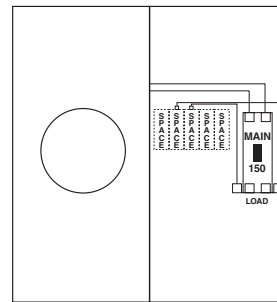

Fig. C
MS151C
 Series

Overhead/Underground Feed

Fig.	Model Number		Circuit Protection	Amps	Spaces	Wire Range*	Cabinet Size	Load Center	Unit Wt.	Std Pkg.	UL and Utility Approved
	Ring Type	Ringless									
A	MS125E	—	—	125	2	BC	16 x 17	PC2LC	24	1	UL
B	MS150C, MS150CGP	RS150C, RS150CGP	TQDL or equivalent	150	—	BC	17 x 26	—	41		UL, GP
C	MS151C	—	CBL2151	150	5	BC	17 x 26	LC55N1	43		UL

Surface, 150 Amps, 120/240V

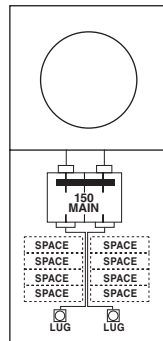

Fig. D
R158CR2TLFNG
 Series

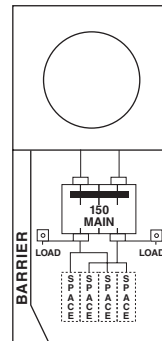

Fig. E
M181CB1, M181CB1GP, R181CB1
 Series

Overhead/Underground Feed

Fig.	Model Number		Circuit Protection	Amps	Spaces	Wire Range*	Cabinet Size	Load Center	Unit Wt.	Std Pkg.	UL and Utility Approved
	Ring Type	Ringless									
D	—	R158CR2TLFNG	THQMV150	150	8	ZZ	14 x 32	—	58	1	UL, MEG
E	M181CB1, M181CB1GP	R181CB1	THQMV150WLBP	150	4	BG	14 x 28	LCTL + LCBS	34		UL, GP

* Wire Range Table on pages 1-25–1-26.

Metered

Surface, Side-by-Side, 200 Amps, 120/240V

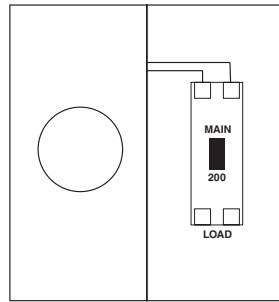

Fig. A
MS250C, MS250CGP, RS250C, RS250CGP
 Series

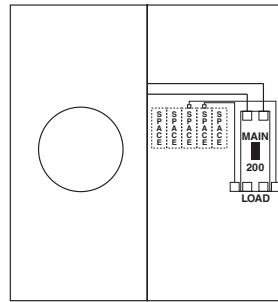

Fig. B
MS251C, RS251C
 Series

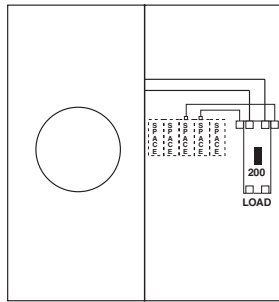

Fig. C
MS252C
 Parallel

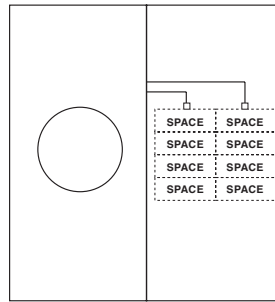

Fig. D
MS252E014
 Parallel

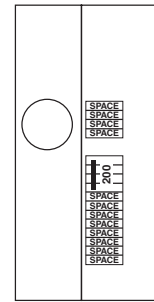

Fig. E
MS2453C
 Parallel

Overhead/Underground Feed

Fig.	Model Number		Circuit Protection	Amps	Spaces	Wire Range*	Cabinet Size	Load Center	Unit Wt.	Std Pkg.	UL and Utility Approved
	Ring Type	Ringless									
A	MS250C, MS250CGP ¹	RS250C, RS250CGP ¹	TQD22200WL	200	—	BC	17 x 26	—	41	1	UL, GP
B	MS251C	RS251C	CBL2201	200	5	BC	17 x 26	LC55N1	41		UL
C	MS252C	—	LCB2201	200	5	BC	17 x 26	LC55N1	43		
D	MS252E014 ²	—	—	200	8	BC	14 x 31	LC88X2	39		
E	MS2453C	—	THQMV200WLBP	200	8	W	14 x 31	LC88X2	38		

¹ GP models not available with barrel lock.

² Space for 8-Single Pole Breakers or 200A Main and 4-Single Pole Breakers.

* Wire Range Table on pages 1-25-1-26.

Metered

Surface, 200 Amps, 120/240V

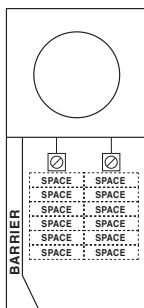

Fig. A

R256EB1A, R256EB1AETG, R256EB1FMG, R256EB1NAETG,
R256EB1NFMG, R256EB118AETG, R256EB118FMG
Parallel

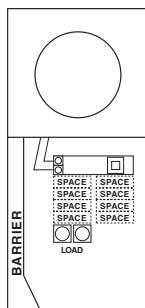

Fig. B

M208CR2A, M208CR2B,
R208CR2A, R208CR2AETG
Series

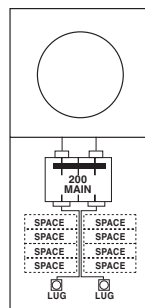

Fig. C

R208CR2TLFMG
Series

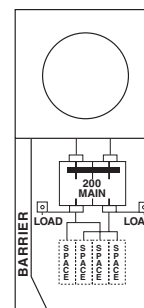

Fig. D

M281CB1, M281CB1GP, R281CB1,
R281CB1EP, R281CB1ETG, R281CB1GP
Series

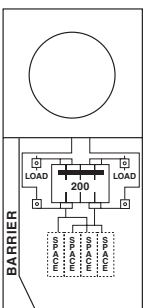

Fig. E

M282CB1, M282CB1C
R282CB1, R282CB1LK
Parallel

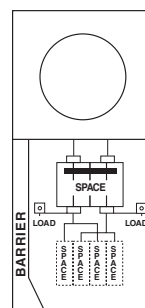

Fig. F

M281EB1, R281EB1
Series

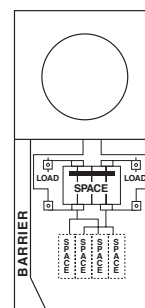

Fig. G

M282EB1, R282EB1
Parallel

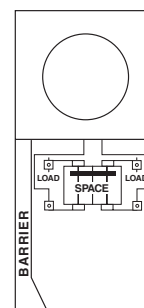

Fig. H

R283CB1, R283CB1AP
Parallel

Overhead/Underground Feed

Fig.	Model Number		Circuit Protection	Amps	Spaces	Wire Range*	Cabinet Size	Load Center	Unit Wt.	Std Pkg.	UL and Utility Approved
	Ring Type	Ringless									
A	—	R256EB1A, ^{2,3} R256EB1AETG, R256EB1FMG, R256EB1NAETG, R256EB1NFMG, R256EB118AETG, R256EB118FMG	—	200	12	—	14 x 26	—	32	1	UL, ETG, MEG
B	M208CR2A ⁶	R208CR2A, R208CR2AETG	TQDL or equivalent	200	8	AN	14 x 28	LC1212PC	46		UL, ETG
C	—	R208CR2TLFMG	THQMV200	200	8	ZZ	14 x 28	—	47		UL, MEG
D	M281CB1, M281CB1GP	R281CB1, ⁴ R281CB1AEP, R281CB1ETG, R281CB1GP ¹	THQMV200WLBP	200	4	BK	14 x 28	LCTNL + LCBS	34		UL, AEP, ETG, GP
E	M282CB1, M282CB1C	R282CB1 ⁴	THQMV200WLBP	200	4	BK	14 x 28	LCTL + LCBS	35		UL
F	M281EB1 ⁵	R281EB1	—	200	5	BK	14 x 28	LCTNL + LCBS	33		UL
G	M282EB1	R282EB1	—	200	5	BK	14 x 28	LCTL + LCBS	33.2		UL
H	—	R283CB1	THQMV200WLBP	200	0	BK	14 x 28	—	32.7		UL
H	—	R283CB1AP	THQMV200WLBP	200	0	BJ	14 x 28	—	34.19		UL

¹ GP models not available with barrel lock.

² Available with aluminum bussing and aluminum enclosure - R256EB1018A.

³ Available with galvanized enclosure with neutral installed - R256EB1NA.

⁴ Available with barrel lock - R281CB1LK and R282CB1LK.

⁵ Available with copper wire - M282CB1C.

⁶ Feed thru lug option available - M208CR2B.

* Wire Range Table on pages 1-24-1-26.

Data subject to change without notice.

Metered

Surface, 200 Amps, 120/240V

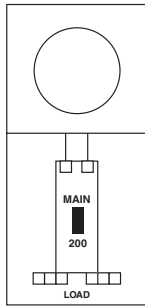

Fig. A
R200T
Series

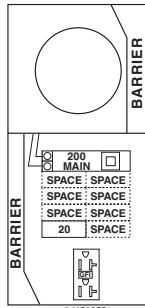

Fig. B
M208CR2B010
Series

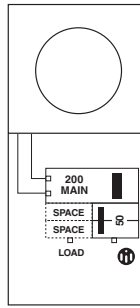

Fig. C
M254C
Series

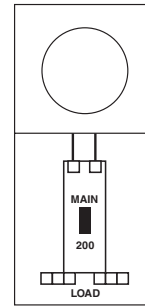

Fig. D
M280TM1, R280T
Series

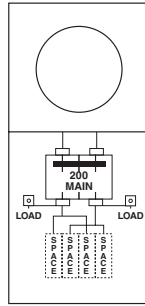

Fig. E
M281C1, R281C1
Series

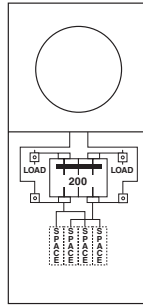

Fig. F
M282C1C
Parallel

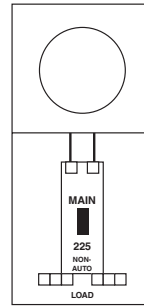

Fig. G
M285T
Series

Overhead Feed

Fig.	Model Number		Circuit Protection	Amps	Spaces	Wire Range*	Cabinet Size	Load Center	Unit Wt.	Std Pkg.	UL
	Ring Type	Ringless									
A	—	R200T ²	265A6249G1	200	—	AF	14 x 38	—	42	1	Y
B	M208CR2B010	—	TQDL or equivalent, THQL1120	200	7	AN	14 x 38	LC1212PC	50		
C	M254C	—	TQDL or equivalent, THQL2150	200	2	S	14 x 38	LC88PC	40		
D	M280TM1 ²	R280T ^{2,4}	265A6249G10	200	0	BD	9 x 32	—	32		
E	M281C1	R281C1	THQMV200WLBP	200	4	BK	9 x 30	LCTL + LCBS	26		
F	M282C1C ¹	—	THQMV200WLBP	200	4	BJ	9 x 30	LCTL + LCBS	26		
G	M285T ^{2,3}	—	CBT2201N	200	0	BD	9 x 32	—	27		

¹ Copper wired.

² "Triple-Tap" – 3 load lugs per phase.

³ 225A non-auto switch, no circuit protection.

⁴ Available with earth burial post – R280TP6HP.

* Wire Range Table on pages 1-24-1-25.

Unmetered

Surface, 100 – 125 Amps, 120/240V

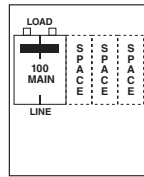

Fig. A
U101C
 Series

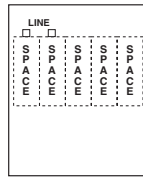

Fig. B
U102E
 Parallel

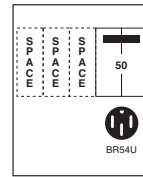

Fig. C
U354C
 Series

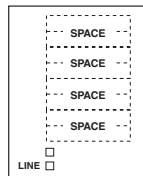

Fig. D
UL412RMW
 Parallel

Fig.	Model Number	Circuit Protection	Amps	Spaces	Wire Range*	Cabinet Size	Load Center	Unit Wt.	Std Pkg.	UL
A	U101C	THQL21100	100	3	Z	9 x 17	LC55N1	15	1	Y
B	U102E	—	100	5	V	9 x 17	LC55N1	15		Y
C	U354C	THQL2150	100	3	V	9 x 17	LC55N1	16		cULus
D	UL412RMW ¹	—	125	4/8	VB	7 x 10	425D549P1	7		Y

¹ (4) 1" spaces or (8) 1/2" spaces available.
 * Wire Range Table on page 1-26.

Unmetered

Surface, 150 – 200 Amps , 120/240V

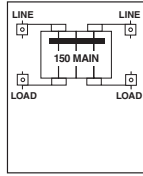

Fig. A
U180C1
 Series

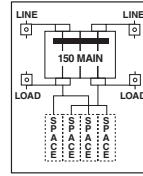

Fig. B
U181C1
 Series/Parallel

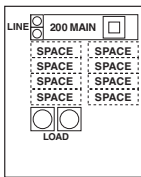

Fig. C
U208C
 Series

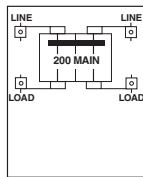

Fig. D
U280C1
 Series/Parallel

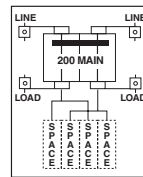

Fig. E
U281C1
 Series/Parallel

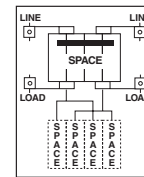

Fig. F
U281E1
 Series/Parallel

Fig.	Model Number	Circuit Protection	Amps	Spaces	Wire Range*	Cabinet Size	Load Center	Unit Wt.	Std Pkg.	UL
A	U180C1	THQMV150WLBP	150	—	AW	9 x 21	LCTL + LCBNS	15	1	
B	U181C1 ¹	THQMV150WLBP	150	4	AX	9 x 21	LCTL + LCBS	21		Y
C	U208C	TQDL or equivalent	200	8	AN	14 x 21	LC1212PC	30		
D	U280C1 ¹	THQMV200WLBP	200	0	BF	9 x 21	LCTL + LCBNS	18.2		Y
E	U281C1 ¹	THQMV200WLBP	200	4	BG	9 x 21	LCTL + LCBS	18.7		
F	U281E1 ¹	—	200	5	BG	9 x 21	LCTNL + LCBS	—		Y

¹ Series or parallel wired.

* Wire Range Table on pages 1-24-1-25.

All-In-One

400 Amps

- Rated as service equipment (Panelboard No. 67 and Meter Sockets No. 414)
- Units supplied with factory installed main breakers rated 22kAIC where applicable
- Units available with or without load center with 8 circuit models being standard. Other configurations available, consult manufacturer.
- Load centers are provided with copper bus, 22kAIC bus bracing, and 100% neutral terminations. Feed-through lugs provided on load centers with main breakers.
- 320A continuous duty meter socket available in ring type, K-4 bolt on, or ringless (lever bypass)
- All terminals accept copper or aluminum wire for added installation flexibility
- Utility meter socket compartment has barrier from main circuit breakers for utility power protection
- Factory installed flange for easy semi-flush or surface installation
- NEMA 3R weatherproof enclosures
- G90 galvanized steel construction for superior corrosion protection
- Durable polyester powder coat finish resists chipping and fading
- Underground feed only, series wired, 240V single phase, and branch circuits accept combinations up to 200A
- Fifth jaw optional - order Model # MS5MIL
- Line side 1/2" stud termination provided, however, crimp-on/connector lug not provided by Midwest
- Bottom feed only – no hub provision

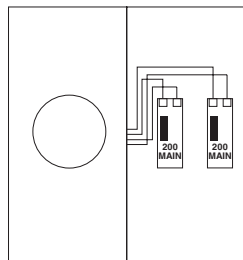

Fig. A
MS45500C
THQD22200WL

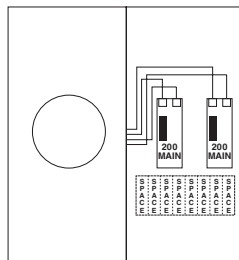

Fig. B
MS45508C
THQD22200WL

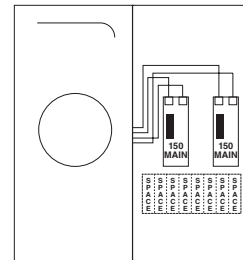

Fig. C
RS43308C, RS43308CGP
THQD22150WL

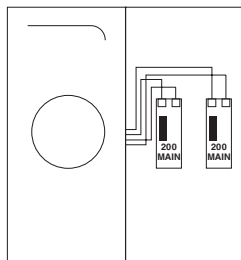

Fig. D
RS45500C, RS45500CAEP
THQD22200WL

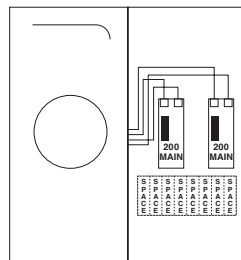

Fig. E
RS45508C, RS45508CGP, RS45508CAEP
THQD22200WL

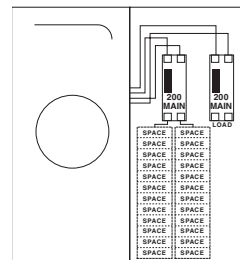

Fig. F
RS45524CFMG

Fig.	Model Number		Circuit Protection		OCP Device Rating (Amps)		Amps	Spaces (Max. 1")	Wire Range*	Cabinet Size	Hub Opening	Load Center	Unit Wt.	Std Pkg.	UL and Utility Approved
	Ring Type	Ringless – Lever Bypass	1	2	1	2									
A	MS45500C	—	THQD22200WL	THQD22200WL	200	200	400	—	400 Amps	31 x 33	N	—	95	1	UL
B	MS45508C	—	THQD22200WL	THQD22200WL	200	200	400	8				8 Circuits	99		
C	—	RS43308C, RS43308CGP	THQD22150WL	THQD22150WL	150	150	400	8				8 Circuits	99		UL, GP
D	—	RS45500C, RS45500CAEP	THQD22200WL	THQD22200WL	200	200	400	—				—	95		UL, AEP
E	—	RS45508C, RS45508CAEP, RS45508CGP	THQD22200WL	THQD22200WL	200	200	400	8				8 Circuits	99		UL, AEP, GP
F	—	RS45524CFMG	—	—	—	—	400	24				ZB	—		45

* Wire Range Table on page 1-26.

Data subject to change without notice.

Metered

Pedestal, 100 Amps, 120/240V

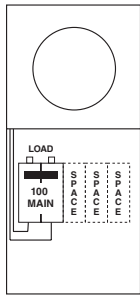

Fig. A
M101CP6, R101CP6
Series

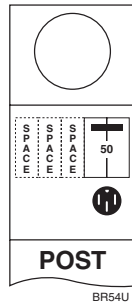

Fig. B
M354CP6
Series

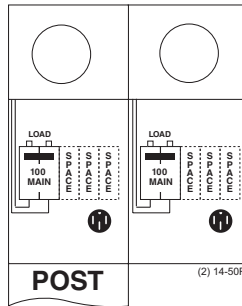

Fig. C
M101CB6, R101CB6
Series

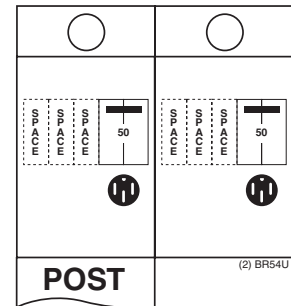

Fig. D
M354CB6
Series

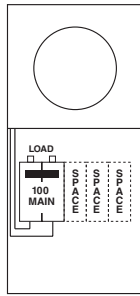

Fig. E
M101CP6HP, R101CP6HP
Series

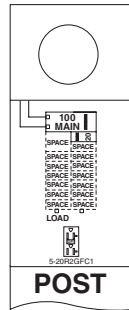

Fig. F
M108CP6HP010
Series

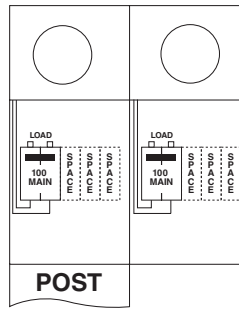

Fig. G
M101CB6HP, R101CB6HP
Series

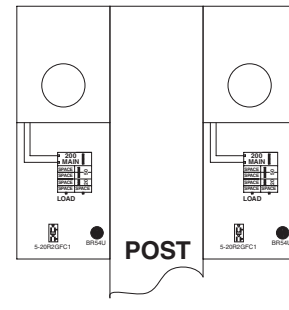

Fig. H
R255CB6010
Series

Inline Post

Fig.	Model Number		Circuit Protection	Amps	Spaces	Wire Range*	Cabinet Size	Load Center	Unit Wt.	Std Pkg.	UL
	Ring Type	Ringless									
A	M101CP6 ^{1,2}	R101CP6 ³	THQL21100	100	3	T2	9PT	LC55N1	59	1	Y
B	M354CP6	—	THQL2150	100	3	AS	9PT	LC55N1	59		

Back-to-Back Inline Post

Fig.	Model Number		Circuit Protection	Amps	Spaces	Wire Range*	Cabinet Size	Load Center	Unit Wt.	Std Pkg.	UL
	Ring Type	Ringless									
C	M101CB6	R101CB6	THQL21100	100	3	T2	9PT	LC55N1	82	1	Y
D	M354CB6	—	THQL2150	100	3	AT	9PT	LC55N1	82		

Head Post

Fig.	Model Number		Circuit Protection	Amps	Spaces	Wire Range*	Cabinet Size	Load Center	Unit Wt.	Std Pkg.	UL
	Ring Type	Ringless									
E	M101CP6HP ⁴	R101CP6HP	THQL21100	100	3	S	9HP	LC55N1	80	1	Y
F	M108CP6HP010	—	THQL1120GFT	100	14	U	9HP	—	78		

Back-to-Back Head Post

Fig.	Model Number		Circuit Protection	Amps	Spaces	Wire Range*	Cabinet Size	Load Center	Unit Wt.	Std Pkg.	UL
	Ring Type	Ringless									
G	M101CB6HP	R101CB6HP	THQL21100	100	3	S	9HP	LC55N1	110	1	Y
H	—	R255CB6010	TQDL or equivalent, THQL2150, THQL1120	100	5	S	14PT	LC1212PC	101		N

¹ Available in Ring Type, pad mount - M101CP4.

² Available in Ring Type, copper wire - M101CP6C.

³ Available in Ringless Type, pad mount - R101CP4.

⁴ Available with GFCI duplex receptacle in Ring Type only - M101CP6HP010.

* Wire Range Table on pages 1-24-1-26.

Metered

Pedestal, 200 Amps, 120/240V

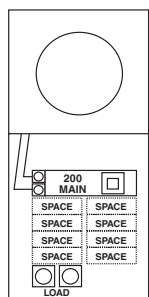

Fig. A
M208CP6HP, R208CP6HP
Series

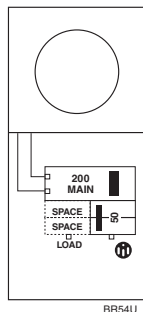

Fig. B
M254CP6
Series

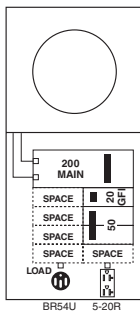

Fig. C
M255GP6
Series

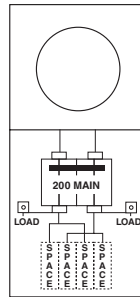

Fig. D
R2502CP6
Parallel

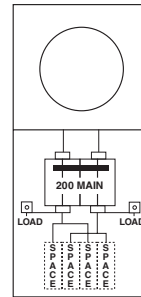

Fig. E
M281C1P6H, R281C1P6H
Series

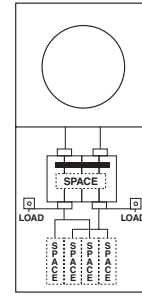

Fig. F
M281E1P6H, R281E1P6H
Series

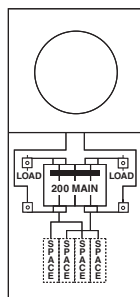

Fig. G
M282C1P6H, R282C1P6H
Parallel

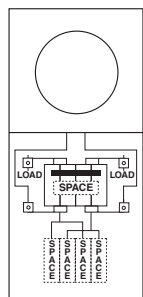

Fig. H
M282E1P6H, R282E1P6H
Parallel

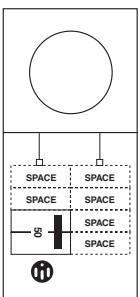

Fig. I
M654CP6
Parallel

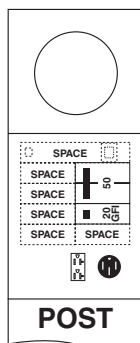

Fig. J
M655GP6
Parallel

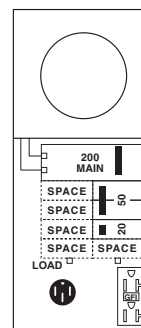

Fig. K
R255CP6010
BR54U, 5-20R2GFCI

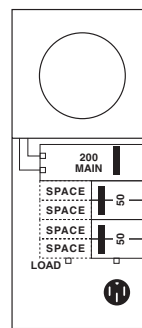

Fig. L
R225CP6
BR54U

Inline and Head Post

Fig.	Model Number		Circuit Protection	Amps	Spaces	Wire Range*	Cabinet Size	Load Center	Unit Wt.	Std Pkg.	UL
	Ring Type	Ringless									
A	M208CP6HP	R208CP6HP	TQDL or equivalent	200	8	S	14HP	LC1212PC	85	1	Y
B	M254CP6 ¹	—	TQDL or equivalent, THQL2150	200	2	S	14PT	LC88PC	96		
C	M255GP6 ¹	—	TQDL or equivalent, THQL2150, GFI120	200	5	S	14PT	LC1212PC	87		
D	—	R2502CP6	THQMV200WLBP	200	4	BM	9PT	LCTL + LCBS	53		
E	M281C1P6H ^{2,3,4,5}	R281C1P6H ⁴	THQMV200WLBP	200	4	S	6H	LCTNL + LCBS	68		
F	M281E1P6H	R281E1P6H	—	200	5	S	6H	LCTNL + LCBS	67		
G	M282C1P6H ^{2,3,6}	R282C1P6H	THQMV200WLBP	200	4	S	6H	LCTNL + LCBS	69		
H	M282E1P6H ²	R282E1P6H	—	200	5	S	6H	LCTNL + LCBS	68		
I	M654CP6 ¹	—	THQL2150	200	6	S	14PT	LC88PC	85		
J	M655GP6 ¹	—	THQL2150, GFI120	200	9	S	14PT	LC1212PC	85		
K	—	R255CP6010	TQDL or equivalent, THQL2150, THQL1120	200	5	S	14PT	LC1212PC	88		
L	—	R225CP6	TQDL or equivalent, THQL2150	200	4	ZZ	14PT	LC1212PC	88		

¹ Rated as Temporary Site Service Equipment.

² Available with GFCI Receptacle installed - M281C1P6H010, M282C1P6H010 and M282E1P6H010.

³ Available in Ring Type with stud termination - M281C1S6H and M282C1S6H.

⁴ Available in Ring Type with stud termination and copper wire - M281C1S6HC and R281C1S6HC.

⁵ Available with foot base factory installed - M281C1P6HFB.

⁶ Available in Ring Type with copper wire - M282C1P6HC.

* Wire Range Table on pages 1-25-1-26.

Data subject to change without notice.

Metered

Pedestal, 200 Amps, 120/240V

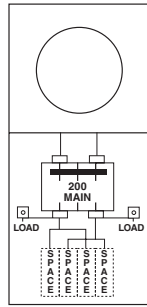

Fig. A
M281C1B6H, R281C1B6H
Series

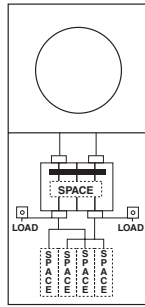

Fig. B
M281E1B6H, R281E1B6H
Series

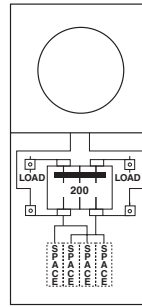

Fig. C
M282C1B6H, R282C1B6H
Series

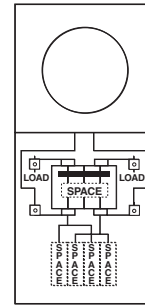

Fig. D
M282E1B6H, R282E1B6H
Series

Back-to-Back Head Post

Fig.	Model Number		Circuit Protection	Amps	Spaces	Wire Range*	Cabinet Size	Load Center	Unit Wt.	Std Pkg.	UL
	Ring Type	Ringless									
A	M281C1B6H	R281C1B6H	THQMV200WLBP	200	4	S	6H	LCTNL + LCBS	101	1	Y
B	M281E1B6H	R281E1B6H	—	200	5						
C	M282C1B6H	R282C1B6H	THQMV200WLBP	200	4						
D	M282E1B6H	R282E1B6H	—	200	5						

Unmetered

Pedestal, 100 – 200 Amps, 120/240V

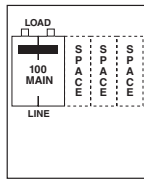

Fig. E
U101CP6
Series

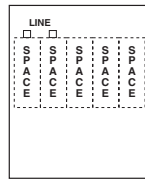

Fig. F
U102EP6
Parallel

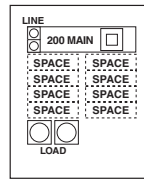

Fig. G
U208CP6HP
Series

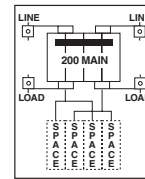

Fig. H
U281C1P6H
Series

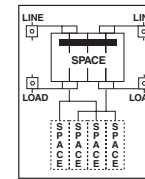

Fig. I
U281E1P6H
Series

Fig.	Model Number	Circuit Protection	Amps	Spaces	Wire Range*	Cabinet Size	Load Center	Unit Wt.	Std Pkg.	UL
E	U101CP6	THQL21100	100	3	T2	9PT	LC55N1	46	1	Y
F	U102EP6	—	100	5	V	9PT	LC55N2			

Fig.	Model Number	Circuit Protection	Amps	Spaces	Wire Range*	Cabinet Size	Load Center	Unit Wt.	Std Pkg.	UL
G	U208CP6HP	TQDL or equivalent	200	8	S	14HP	LC1212PC	80	1	Y
H	U281C1P6H	THQMV200WLBP	200	4	S	6H	LCTL + LCBS			
I	U281E1P6H	—	200	5	S	6H	LCTNL + LCBS			

* Wire Range Table on pages 1-25-1-26.

Metered Lever Bypass

Pedestal, Ringless, Surface, 100 – 200 Amps, 120/240V

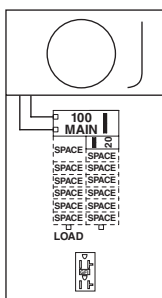

Fig. A
R108CP6HP034
Series

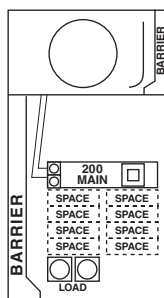

Fig. B
R208CR2A034
Series

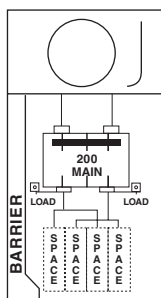

Fig. C
R281CB1034
Series

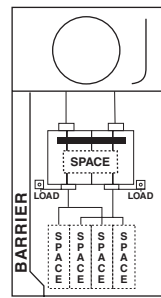

Fig. D
R281EB1034
Series

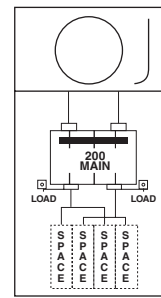

Fig. E
R281C1034
Series

Underground Feed

Fig.	Model Number	Circuit Protection	Amps	Spaces	Phase	Wire Range*	Cabinet Size	Load Center	Unit Wt.	Std Pkg.	UL
A	R108CP6HP034	THQL21100	100	12	1	BH	14 x 34	—	79	1	Y

Overhead and Underground Feed

Fig.	Model Number	Circuit Protection	Amps	Spaces	Phase	Wire Range*	Cabinet Size	Load Center	Unit Wt.	Std Pkg.	UL
B	R208CR2A034 ¹	TQDL or equivalent	200	8	1	BK	14 x 32	LC1212PC	38.4	1	Y
C	R281CB1034	THQMV200WLBP	200	4	1	BK	14 x 32	LCTL + LCBS			
D	R281EB1034 ²	—	200	4	1	BK	14 x 32	LCTL + LCBS			

Overhead Feed

Fig.	Model Number	Circuit Protection	Amps	Spaces	Phase	Wire Range*	Cabinet Size	Load Center	Unit Wt.	Std Pkg.	UL
E	R281C1034	THQMV200WLBP	200	4	1	BK	14 x 32	LCTL + LCBS	38.4	1	Y

¹ Loop feed lugs installed.

² Double latch on meter cover required by some utilities – R281EB1034L.

* Wire Range Table on page 1-25.

Metered Lever Bypass

Pedestal, Ringless, 200 - 400 Amps, 120/240V

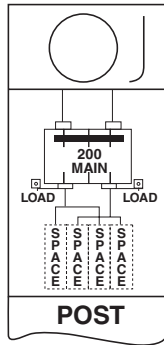

Fig. A
R281C1P6H034
Series

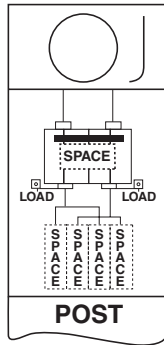

Fig. B
R281E1P6H034
Series

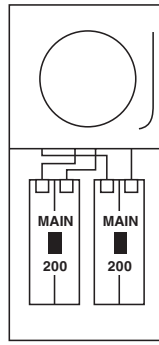

Fig. C
R455CP6034
Series

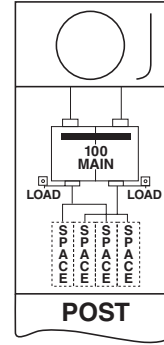

Fig. D
R481C1P6H034
Series

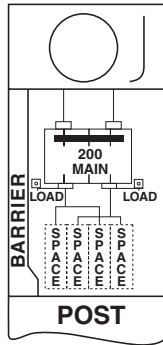

Fig. E
R281C1B6H034
Series

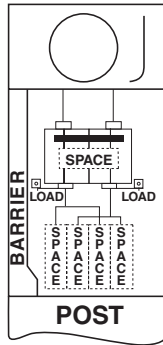

Fig. F
R281E1B6H034
Series

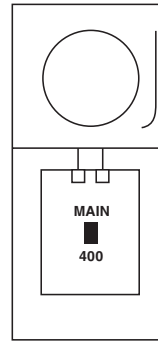

Fig. G
R400P6034
Series

Single-Sided

Fig.	Model Number	Circuit Protection	Amps	Spaces	Phase	Wire Range*	Cabinet Size	Load Center	Unit Wt.	Std Pkg.	UL
A	R281C1P6H034	THQMV200WLBP	200	4	1	S	6H034	LCTL + LCBS	83.5	1	Y
B	R281E1P6H034	—	200	4		S	6H034	LCTL + LCBS	83.5		
C	R455CP6034	(2) TQDL or equivalent	400	0		VA	13x21	—	60.5		
D	R481C1P6H034 ^{1,2}	THQL21100	200	4		S	6H034	LCTL + LCBS	83.5		

Back-to-Back

Fig.	Model Number	Circuit Protection	Amps	Spaces	Phase	Wire Range*	Cabinet Size	Load Center	Unit Wt.	Std Pkg.	UL
E	R281C1B6H034	THQMV200WLBP	200	4	1	S	6H034	LCTL + LCBS	114	1	Y
F	R281E1B6H034	—									

Without Breaker

Fig.	Model Number	Circuit Protection	Amps	Spaces	Phase	Wire Range*	Cabinet Size	Load Center	Unit Wt.	Std Pkg.	UL
G	R400P6034	—	400		1	SS	13x64	—	79	1	Y

All lever bypass models include a fifth jaw in the "nine o'clock" position as of 2004.

¹ R481C1P6H034 rated at 100A and 10kAIC (100A Breaker, 200A Meter Socket).

² Available in camo green paint – add "G" after model number.

* Wire Range Table on pages 1-25-1-26.

Data subject to change without notice.

Technical Data

Model Number	Replacement Parts		Cabinet Size	Enclosure Style ²	Cabinet Dimensions (inches)			Knockout Figure ³	Hub	kAIC
	Meter Socket	Post Lugs			Height (A)	Width (B)	Depth (C)			
M100C	MSM100930	—	9 x 30	C	30	9-3/4	5-3/16	3	Y	10
M100T	MSM100930	—	9 x 30	C	30	9-3/4	5-3/16	3	Y	10
M101C	MSM100930	—	9 x 30	C	30	9-3/4	5-3/16	3	Y	10
M101CC	MSM100930	—	9 x 30	C	30	9-3/4	5-3/16	3	Y	10
M101CB2	MW200M	—	14 x 26	D	26-1/4	14-1/4	4-9/16	6	Y	10
M101CB6	MSM100P9	LT100B350	9PT	See page 1-21					Y	10
M101CB6HP	MSM100P9	LT200B350	9HP	See page 1-21					N	10
M101CP4	MSM100P9	LT100B350	9PT	See page 1-21					N	10
M101CP6	MSM100P9	LT100S350	9PT	See page 1-21					N	10
M101CP6C	MSM100P9	LT200B350	9PT	See page 1-21					N	10
M101CP6HP	MSM100P9	LT100S350	9HP	See page 1-21					N	10
M101CP6HP010	MSM100P9	LT200S350	9HP	See page 1-21					N	10
M102CB2	MW200M	—	14 x 26	D	26-1/4	14-3/4	4-9/16	6	Y	10
M102CB2010	MW200M	—	14 x 26	D	26-1/4	14-3/4	4-9/16	6	Y	10
M102E	MSM100930	—	9 x 30	C	30	9-3/4	5-3/16	3	Y	10
M108CP6HP010	MW200M	LT200S350	14HP	See page 1-21					N	10
M181CB1	MSMS1 ¹	—	14 x 28	D	28-5/8	14-3/8	4-3/4	6	Y	22
M181CB1GP	MSMS1 ¹	—	14 x 28	D	28-5/8	14-3/8	4-3/4	6	Y	22
M208CP6HP	MW200M	LT200S350	14HP	See page 1-21					N	10
M208CR2A	MW200M	—	14 x 28	C	28-5/8	14-3/8	6-3/8	8	Y	10
M208CR2B	MW200M	—	14 x 28	C	28-5/8	14-3/8	6-3/8	8	Y	10
M208CR2B010	MW200M	—	14 x 38	C	38-3/8	14-3/4	6-3/8	8	Y	10
M254C	MW200M	—	14 x 38	C	38	14-3/4	6-3/8	8	Y	10
M254CP6	MW200M	LT200S350	14PT	See page 1-21					N	10
M255GP6	MW200M	LT200S350	14PT	See page 1-21					N	10
M280TM1	MW200M	—	9 x 32	C	32-1/4	9-3/4	5-11/16	4	Y	10
M281C1	MSMS	—	9 x 30	D	30-1/4	9-5/16	4-3/4	12	Y	22
M281C1B6H	MSMP	LT200B350	6H	See page 1-22					N	22
M281C1P6H	MSMP	LT200S350	6H	See page 1-22					N	22
M281C1P6H010	MSMP	LT200S350	6H	See page 1-22					N	22
M281C1P6HFB	MSMP	LT200S350	6H	See page 1-22					N	22
M281C1S6H	MSMP	LT200SS	6H	See page 1-22					N	22
M281C1S6HC	MSMP	LT200SS	6H	See page 1-22					N	22
M281CB1	MSMS1 ¹	—	14 x 28	D	28-5/8	14-3/8	4-3/4	13	Y	22
M281CB1GP	MSMS1 ¹	—	14 x 28	D	28-5/8	14-3/8	4-3/4	13	Y	22
M281E1B6H	MSMP	LT200B350	6H	See page 1-22					N	22
M281E1P6H	MSMP	LT200S350	6H	See page 1-22					N	22
M281EB1	MSMS1 ¹	—	14 x 28	D	30-1/4	9-5/16	4-3/4	13	Y	22
M282C1B6H	MSMP	LT200B350	6H	See page 1-22					N	22
M282C1C	MSMS	—	9 x 30	D	30-1/4	9-5/16	4-3/4	12	Y	22
M282C1P6H	MSMP	LT200S350	6H	See page 1-22					N	22
M282C1P6H010	MSMP	LT200S350	6H	See page 1-22					N	22
M282C1P6HC	MSMP	LT200S350	6H	See page 1-22					N	22
M282C1S6H	MSMP	LT200SS	6H	See page 1-22					N	22
M282CB1	MSMS	—	14 x 28	D	28-5/8	14-3/8	4-3/4	13	Y	22
M282CB1C	MSMS	—	14 x 28	D	28-5/8	14-3/8	4-3/4	13	Y	22
M282E1B6H	MSMP	LT200B350	6H	See page 1-22					N	22
M282E1P6H	MSMP	LT200S350	6H	See page 1-22					N	22
M282E1P6H010	MSMP	LT200S350	6H	See page 1-22					N	22
M282EB1	MSMS	—	14 x 28	D	28-5/8	14-3/8	4-3/4	13	Y	22
M285T	MW200M	—	9 x 32	C	32-1/4	9-3/4	5-11/16	4	Y	10
M354C	MSM100930	—	9 x 30	C	30	9-3/4	5-3/16	1	Y	10
M354CB6	MSM100P9	LT100B350	9PT	See page 1-21					N	10
M354CP6	MSM100P9	LT100S350	9PT	See page 1-21					N	10
M654CP6	MW200M	LT200S350	14PT	See page 1-21					N	10
M655GP6	MW200M	LT200S350	14PT	See page 1-21					N	10
MS125E	MW200M	—	16 x 17	E	17-1/4	16-3/4	5	9	Y	10

1 Models prior to April 2004 use MSMS.

3 Knockout Figures on pages 1-19–1-20.

2 Enclosure Styles on page 1-19.

Data subject to change without notice.

Technical Data

Model Number	Replacement Parts		Cabinet Size	Enclosure Style ²	Cabinet Dimensions (inches)			Knockout Figure ³	Hub	kAIC
	Meter Socket	Post Lugs			Height (A)	Width (B)	Depth (C)			
MS150C	MW200M	—	16 x 17	E	17-1/4	16-3/4	5	9	Y	10
MS150CGP	MW200M	—	16 x 17	E	17-1/4	16-3/4	5	9	Y	10
MS151C	MW200M	—	17 x 26	E	17-1/4	16-3/4	5	9	Y	10
MS2453C	—	—	14 x 31	E	33	16-3/4	6-1/4	17	Y	22
MS250C	198B8601G11	—	16 x 17	E	17-1/4	16-3/4	5	9	Y	10
MS250CGP	198B8601G11	—	16 x 17	E	17-1/4	16-3/4	5	9	Y	10
MS251C	MW200M	—	17 x 26	E	26-1/4	17-1/2	5-1/2	10	Y	10
MS252C	MW200M	—	17 x 26	E	26-1/4	17-1/2	5-1/2	10	Y	10
MS252E014	MW200M	—	14 x 31	E	14-3/4	31-5/16	5-7/8	7B	Y	10
MS45500C	265A5264P2	—	31 x 33	E	33-1/10	30-1/2	6-1/10	See page 1-20	N	22
MS45508C	265A5264P2	—	31 x 33	E	33-1/10	30-1/2	6-1/10	See page 1-20	N	22
R100C	MSR100930	—	9 x 30	C	30	9-3/4	5-3/16	3	Y	10
R100T	MSR100930	—	9 x 30	C	30	9-3/4	5-3/16	3	Y	10
R101C	MSR100930	—	9 x 30	C	30	9-3/4	5-3/16	3	Y	10
R101CB2	MW200R	—	14 x 26	D	26-1/4	14-3/4	4-9/16	6	Y	10
R101CB2ETG	MW200R	—	14 x 26	D	26-1/4	14-3/4	4-9/16	6	Y	10
R101CB2LK	MW200R	—	14 x 26	D	26-1/4	14-3/4	4-9/16	6	Y	10
R101CB2010	MW200R	—	14 x 26	D	26-1/4	14-3/4	4-9/16	6	Y	10
R101CB6	MSR100P9	LT100B350	9PT		See page 1-21				N	10
R101CB6HP	MSR100P9	LT200B350	9HP		See page 1-21				N	10
R101CP4	MSR100P9	LT100S350	9PT		See page 1-21				N	10
R101CP6	MSR100P9	LT100S350	9PT		See page 1-21				N	10
R101CP6HP	MSR100P9	LT200S350	9HP		See page 1-21				N	10
R102CB2	MW200R	—	14 x 26	D	26-1/4	14-3/4	4-9/16	6	Y	10
R102CB2LK	MW200R	—	14 x 26	D	26-1/4	14-3/4	4-9/16	6	Y	10
R102E	MSR100930	—	9 x 30	C	29-1/2	9-1/4	5-3/16	1	Y	10
R102EN	MSR100930	—	9 x 30	C	29-1/2	9-1/4	5-3/16	1	Y	10
R108CP6HP034	265A5264P8	265A6216G65	14 x 83		See page 1-22				N	10
R158CR2TLFMG	198B8601G90	—	14 x 32	D	31-4/5	14-1/2	4-7/10	18	Y (2)	22
R181CB1	MSRS	—	14 x 28	D	28-1/2	14-3/10	4-4/5	6	Y	10
R181CB1GP	MSRS	—	14 x 28	E	31-7/10	14-1/2	4-8/10	6	Y	22
R200T	MW200R	—	14 x 38	C	38-3/8	14-3/4	6-3/8	8	Y	10
R208CP6HP	MW200R	LT200S350	14HP		See page 1-21				N	10
R208CR2A	MW200R	—	14 x 28	C	28-5/8	14-3/4	6-3/8	8	Y (2)	10
R208CR2AETG	MW200R	—	14 x 28	C	28-5/8	14-3/4	6-3/8	8	Y (2)	10
R208CR2A034	265A5264P8	—	14 x 28	C	28-5/8	14-3/4	6-3/8	8	Y	10
R208CR2TLFMG	198B8601G90	—	14 x 32	D	31-4/5	14-1/2	4-7/10	18	Y (2)	22
R225CP6	—	—	14PT		See page 1-21				N	10
R250CGP	MSRS	—	9PT ¹		See page 1-21				N	10
R2502CP6	MSRS	—	9PT ¹		See page 1-21				N	10
R255CB6010	MSR20014	LT200S350	14PT		See page 1-21				Y	10
R255CP6010	—	—	14PT		See page 1-21				—	—
R256EB1A	198B8601G70	—	14 x 26	D	26-1/4	14-3/4	4-9/16	6	Y	10
R256EB1AETG	198B8601G70	—	17 x 26	D	26-1/10	17-1/2	4-8/10	6	Y	10
R256EB1FMG	198B8601G70	—	14 x 26	D	26-1/4	14-3/4	4-9/16	6	Y	10
R256EB1NA	198B8601G70	—	14 x 26	D	26-1/4	14-3/4	4-9/16	6	Y	10
R256EB1NAETG	198B8601G70	—	14 x 26	D	26-1/4	14-3/4	4-9/16	6	Y	10
R256EB1NFMG	198B8601G70	—	14 x 26	D	26-1/4	14-3/4	4-9/16	6	Y	10
R256EB1018A	198B8601G70	—	14 x 26	D	26-1/4	14-3/4	4-9/16	6	Y	10
R256EB118AETG	198B8601G70	—	17 x 26	D	26-1/10	17-1/2	4-8/10	6	Y	10
R256EB118FMG	198B8601G70	—	14 x 26	D	26-1/4	14-3/4	4-9/16	6	Y	10
R280T	MW200R	—	9 x 32	C	32-1/4	9-3/4	5-11/16	4	Y	10
R280TP6HP	MW200R	LT200S350	9HP		See page 24				N	10
R281C1	MSRS	—	9 x 30	D	30-1/4	9-5/16	4-3/4	12	Y	22
R281C1034	265A5264P8	—	14 x 32	D	32-1/2	14-1/2	5-7/16	15	Y	22
R281C1B6H	MSRP	LT200B350	6H		See page 1-22				N	22
R281C1B6H034	265A5264P8	LT200B350	6H034		See page 1-22				N	22

¹ Not all models listed. Contact local representative for other models and details.

² Enclosure Styles on page 1-19.

³ Knockout Figures on pages 1-19–1-20.

Data subject to change without notice.

Technical Data

Model Number	Replacement Parts		Cabinet Size	Enclosure Style ¹	Cabinet Dimensions (inches)			Knockout Figure ²	Hub	kAIC
	Meter Socket	Post Lugs			Height (A)	Width (B)	Depth (C)			
R281C1P6H	MSRP	LT200S350	6H		See page 1-22				N	22
R281C1P6H034	265A5264P8	LT200S350	6H034		See page 1-22				N	22
R281C1S6HC	MSRP	LT200SS	6H		See page 1-22				N	22
R281CB1	MSRS	—	14 x 28	D	28-5/8	14-3/8	4-3/4	13	Y	22
R281CB1034	265A5264P8	—	14 x 28	D	28-5/8	14-3/8	4-3/4	13	Y	22
R281CB1AEP	MSRS	—	14 x 28	D	28-5/8	14-3/8	4-3/4	13	Y	22
R281CB1ETG	MSRS	—	14 x 28	D	28-1/2	17-1/2	4-8/10	13	Y	22
R281CB1GP	MSRS	—	14 x 28	E	31-7/10	14-1/2	4-8/10	6	Y	22
R281CB1LK	MSRS	—	14 x 28	D	28-5/8	14-3/8	4-3/4	13	Y	22
R281E1B6H	MSRP	LT200B350	6H		See page 1-22				N	22
R281E1B6H034	265A5264P8	LT200B350	6H034		See page 1-22				N	22
R281E1P6H	MSRP	LT200S350	6H		See page 1-22				N	22
R281E1P6H034	265A5264P8	LT200S350	6H034		See page 1-22				N	22
R281EB1	MSRS	—	14 x 28	D	28-5/8	14-3/8	4-3/4	13	Y	22
R281EB1034	265A5264P8	—	14 x 28	D	28-5/8	14-3/8	4-3/4	13	Y	22
R282C1B6H	MSRP	LT200B350	6H		See page 1-22				N	22
R282C1P6H	MSRP	LT200S350	6H		See page 1-22				N	22
R282CB1	MSRS	—	14 x 28	D	28-5/8	14-3/8	4-3/4	13	Y	22
R282CB1LK	MSRS	—	14 x 28	D	28-5/8	14-3/8	4-3/4	13	Y	22
R282E1B6H	MSRP	LT200B350	6H		See page 1-22				N	22
R282E1P6H	MSRP	LT200S350	6H		See page 1-22				N	22
R282EB1	MSRS	—	14 x 28	D	28-5/8	14-3/8	4-3/4	13	Y	22
R283CB1	—	—	14 x 28	D	28-5/8	14-3/8	14-3/8	6	Y	22
R283CB1AP	—	—	14 x 28	D	28-5/8	14-3/8	14-3/8	6	Y	22
R400P6034	265A5264P10	—	13 x 64		See page 1-23				N	10
R455CP6034	265A5264P10	—	13 x 21		See page 1-22				N	10
R481C1P6H034	265A5264P8	LT200S350	6H034		See page 1-22				N	22
RS150C	MW200R	—	17 x 26	E	26-1/4	17-1/2	5-1/2	10	Y	10
RS150CGP	MW200R	—	19 x 19	E	18-7/10	18-9/10	5-1/10	9	Y	10
RS250C	MW200R	—	17 x 26	E	26-1/4	17-1/2	5-1/2	10	Y	10
RS250CGP	MW200R	—	19 x 19	E	18-7/10	18-9/10	5-1/10	9	Y	10
RS251C	MW200R	—	17 x 26	E	26-1/4	17-1/2	5-1/2	10	Y	10
RS43308C	265A5264P10	—	31 x 33	E	33-1/10	30-1/2	6-1/10	See page 1-20	N	22
RS43308CGP	265A5264P10	—	31 x 33	E	33-1/10	30-1/2	6-1/2	16	Y	22
RS45500C	265A5264P10	—	31 x 33	E	33-1/10	30-1/2	6-1/10	See page 1-20	N	22
RS45508C	265A5264P10	—	31 x 33	E	33-1/10	30-1/2	6-1/10	See page 1-20	N	22
RS45500CAEP	265A5264P10	—	31 x 33	E	33-1/10	30-1/2	6-1/10	See page 1-20	N	22
RS45508CAEP	265A5264P10	—	31 x 33	E	33-1/10	30-1/2	6-1/2	16	Y	22
RS45508CGP	265A5264P10	—	31 x 33	E	33-1/10	30-1/2	6-1/2	16	Y	22
RS45524CFMG	265A5264P10	—	30 x 40	E	40-1/10	30-1/2	6-1/4	19	N	22
U101C	—	—	9 x 17	B	17-3/8	9-3/4	5-3/16	3	Y	10
U101CP6	—	LT100S350	9PT		See page 1-21				N	10
U102E	—	—	9 x 17	B	17-3/8	9-3/4	5-3/16	3	Y	10
U102EP6	—	LT100S350	9PT		See page 1-21				N	10
U180C1	—	—	9 x 21	A	21-3/4	9-5/16	4-3/4	11	Y	22
U181C1	—	—	9 x 21	A	21-3/4	9-5/16	4-3/4	11	Y	22
U208C	—	—	14 x 21	B	21-3/8	14-3/4	6-7/16	5	Y	10
U208CP6HP	—	LT200S350	14HP		See page 1-21				N	10
U280C1	—	—	9 x 21	A	21-3/4	9-5/16	4-3/4	11	Y	22
U281C1	—	—	9 x 21	A	21-3/4	9-5/16	4-3/4	11	Y	22
U281C1P6H	—	LT200S350	6H		See page 1-22				Y	22
U281E1	—	—	9 x 21	A	21-3/4	9-5/16	4-3/4	11	Y	22
U281E1P6H	—	LT200S350	6H		See page 1-22				Y	22
U354C	—	—	9 x 17	B	17-3/8	9-3/4	5-3/16	1	Y	10
UL412RMW	—	—	7 x 10	A	10	7-1/4	4	2	Y	10

¹ Enclosure Styles on page 1-19.

² Knockout Figures on pages 1-19–1-20.

Enclosure Styles / Cabinet Dimensions

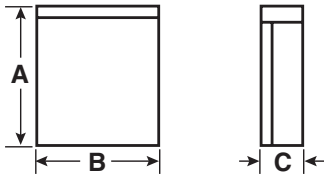

Fig. A

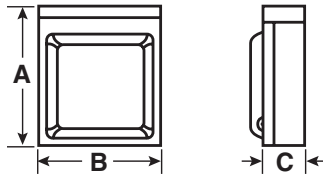

Fig. B

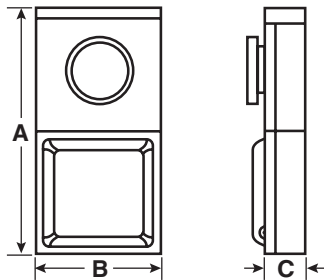

Fig. C

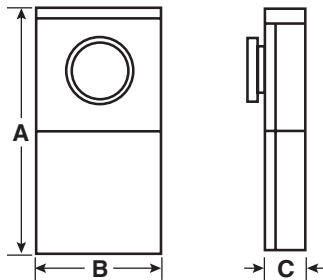

Fig. D

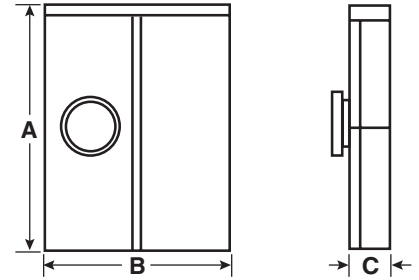

Fig. E

Knockout Configurations

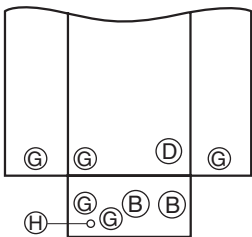

Fig. 1

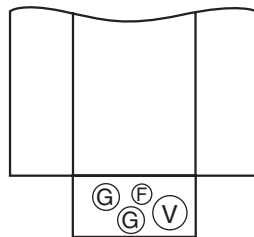

Fig. 2

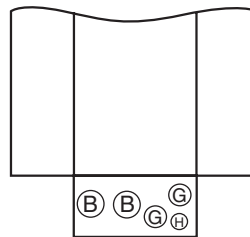

Fig. 3

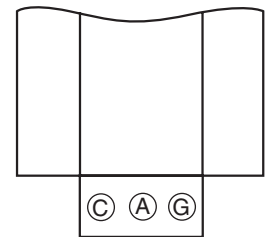

Fig. 4

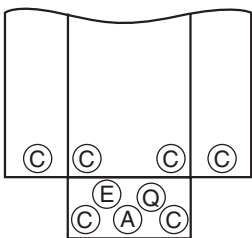

Fig. 5

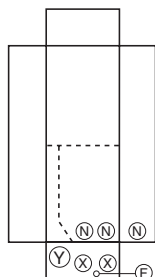

Fig. 6

Knockout Key

A = 1-1/2", 2", 2-1/2"
 B = 1", 1-1/4", 1-1/2"
 C = 1-1/4", 1-1/2", 2"
 D = 3/4", 1", 1-1/4"
 E = 3/4"
 F = 1/2"
 G = 1/2", 3/4", 1"
 H = 9/32"
 L = 1/2", 3/4"
 N = 1/2", 3/4", 1", 1-1/4", 1-1/2", 2"

P = 1-1/4", 1-1/2", 2", 2-1/2"
 Q = 1"
 S = 1/2", 3/4", 1", 1-1/4", 1-1/2"
 T = 3-1/2", 4"
 U = 1/2", 3/4", 1", 1-1/4", 1-1/2", 2", 2-1/2", 3"
 V = 3/4", 1", 1-1/4", 1-1/2"
 X = 1/2", 3/4", 1-1/4", 1-1/2", 2", 2-1/2"
 Y = 1-1/4", 1-1/2", 2", 2-1/2", 3"
 Z = 2-1/2", 3", 3-1/2", 4"

* Knockouts shown for size not for exact positions.

Post Dimensions

Earth Burial

9PT

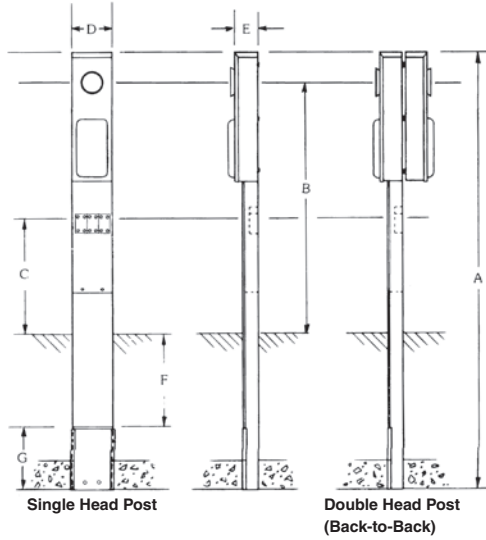

Key	Unmetered	Metered
A	65"	77-1/2"
B	—	45-1/4"
C	19-1/8"	19-1/8"
D	9"	9"
E	4-3/8"	4-3/8"
F	18"	18"
G	6"	6"

9HP

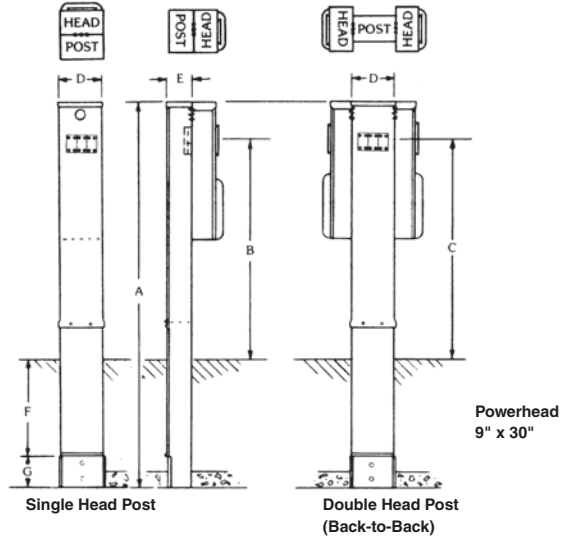

Key	100A Metered	200A Metered
A	83-1/2"	83-1/2"
B	51-1/4"	48-3/4"
C	47"	47"
D	9"	9"
E	4-3/8"	4-3/8"
F	18"	18"
G	6"	6"

14PT

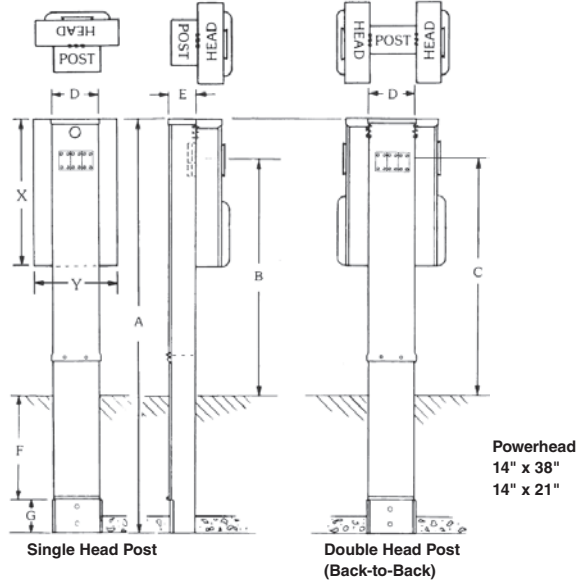

Key	Unmetered	Metered
A	83-1/2"	86"
B	—	50"
C	49-1/2"	49-1/2"
D	9"	9"
E	4-3/8"	4-3/8"
F	18"	18"
G	6"	6"

14HP

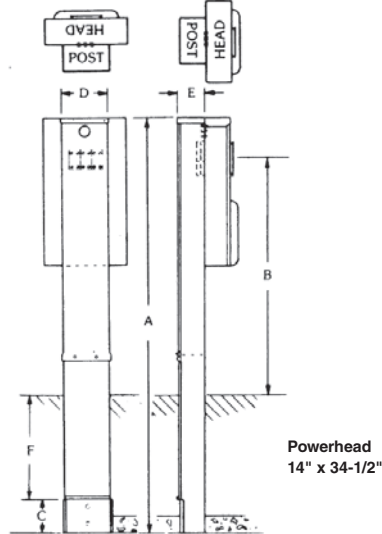

Key	Metered
A	83-1/2"
B	48-3/4"
C	6"
D	9-1/2"
E	4-3/8"
F	18"

Post Dimensions

Earth Burial

R400P6034

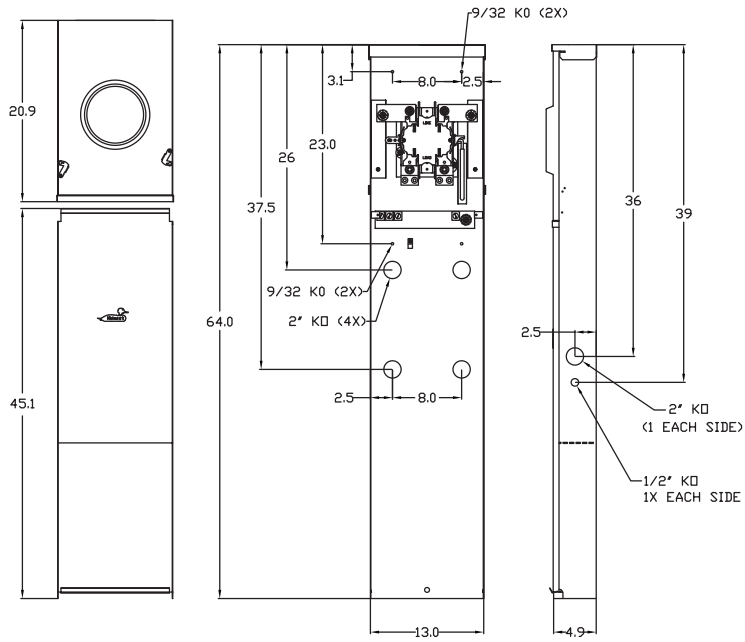

Wire Range Tables

AA

Connector	Copper		Aluminum	
	Solid	Strand	Solid	Strand
Line	—	1/0-250 kcmil	—	1/0-250 kcmil
Load	—	—	—	—
Neutral A	—	6-250	—	6-250
Neutral B	14-8	14-1/0	12-8	12-1/0
Neutral C	—	2-250	—	2-250

AB

Connector	Copper		Aluminum	
	Solid	Strand	Solid	Strand
Line	—	—	—	—
Load	14-8	14-1/0	12-8	12-1/0
Neutral - Large Hole	12-8	2-1/0	10-8	10-1/0
Neutral - Small Hole	14-8	14-4	12-8	12-4
Equipment Ground	12-8	12-2	12-8	12-2

AD

Connector	Copper		Aluminum	
	Solid	Strand	Solid	Strand
Line	—	6-1/0	—	6-1/0
Load	—	—	—	—
Neutral - Large Hole	12-8	12-1/0	10-8	10-1/0
Neutral - Small Hole	14-8	14-4	12-8	12-4
Equipment Ground	12-8	12-2	12-8	12-2

AF

Connector	Copper		Aluminum	
	Solid	Strand	Solid	Strand
Line	—	1/0-250 kcmil	—	1/0-250 kcmil
Load	—	1-300 kcmil	—	1-300 kcmil
Neutral	—	1/0-250 kcmil	—	1/0-250 kcmil
Equipment Ground	12-8	12-2	12-8	12-2

AN

Connector	Copper		Aluminum	
	Solid	Strand	Solid	Strand
Line Main Lugs	—	—	—	—
Load CB Base	—	1-300 kcmil	—	1-300 kcmil
Neutral - Large Single Lugs	—	1-300 kcmil	—	1-300 kcmil
Neutral - Small Single Holes	14-8	14-1/0	12-8	12-1/0
Neutral - Six Large Holes	14-8	10-4	—	6-4
Neutral - Small Holes	14-8	12-8	12-8	12-8
Equipment Ground	12-8	12-2	12-8	12-2

AS

Connector	Copper		Aluminum	
	Solid	Strand	Solid	Strand
Line	—	6-1/0	—	6-1/0
Load	—	—	—	—
Neutral - Large Hole	12-8	12-1/0	10-8	10-1/0
Neutral - Small Hole	14-8	14-4	12-8	12-4
Equipment Ground	12-8	12-2	12-8	12-2
Post Line Connectors Suitable for Loop Feed	2-350 kcmil		2-350 kcmil	
Equipment Ground	12-2	12-2	12-2	12-2

AT

Connector	Copper		Aluminum	
	Solid	Strand	Solid	Strand
Line	—	6-1/0	—	6-1/0
Load	—	—	—	—
Neutral	12-8	12-1/0	10-8	10-1/0
Neutral	14-8	14-4	12-8	12-4
Equipment Ground	12-8	12-2	12-8	12-2
Post Line Connectors Suitable for Loop Feed	6-350 kcmil		6-350 kcmil	
Equipment Ground	12-2	12-2	12-2	12-2

AW

Connector	Copper		Aluminum	
	Solid	Strand	Solid	Strand
Line	—	1/0-4/0	—	1/0-4/0
Load	—	1/0-4/0	—	1/0-4/0
Neutral	—	2-4/0	—	2-4/0
Equipment Ground	12-8	12-2	12-8	12-2

AX

Connector	Copper		Aluminum	
	Solid	Strand	Solid	Strand
Line	—	1/0-4/0	—	1/0-4/0
Load	—	1/0-4/0	—	1/0-4/0
Neutral A	—	2-4/0	—	2-4/0
Neutral B	12-8	12-1/0	10-8	10-1/0
Neutral C	14-8	14-4	12-8	12-4
Equipment Ground	12-8	12-2	12-8	12-2

Wire Range Tables

BC

Connector	Copper		Aluminum	
	Solid	Strand	Solid	Strand
Line	—	1/0-250	—	1/0-250
Load	—	1/0-250	—	1/0-250
Neutral	—	2-250	—	2-250
Neutral	12-8	12-1/0	10-8	10-1/0
Neutral	14-8	14-4	12-8	12-4
Equipment Ground	—	2-250	—	2-250
Equipment Ground	14-8	14-1/0	12-8	12-1/0

BD

Connector	Copper		Aluminum	
	Solid	Strand	Solid	Strand
Line	—	1/0-4/0	—	1/0-4/0
Load	—	2-4/0	—	1/0-4/0
Neutral	—	2-4/0	—	1/0-4/0
Equipment Ground	12-8	12-2	12-8	12-2

BF

Connector	Copper		Aluminum	
	Solid	Strand	Solid	Strand
Line	—	1-4/0	—	2/0-4/0
Load	—	1-4/0	—	2/0-4/0
Neutral	—	1-4/0	—	1-4/0
Equipment Ground	—	6-2/0	—	6-2/0

BG

Connector	Copper		Aluminum	
	Solid	Strand	Solid	Strand
Line	—	1-4/0	—	2/0-4/0
Load	—	1-4/0	—	2/0-4/0
Neutral A	—	1-4/0	—	1-4/0
Neutral/Ground B	—	6-2/0	—	6-2/0
Neutral/Ground C	14-8	14-4	12-8	12-4

BH

Connector	Copper		Aluminum	
	Solid	Strand	Solid	Strand
Line Meter Socket	—	6-350	—	6-350
Load Base Lugs	—	1-300	—	1-300
Neutral - Large Single Lugs	—	1-300	—	1-300
Neutral - Small Single Holes	14-8	14-1/0	12-8	12-1/0
Neutral - Six Large Holes	14-8	10-4	—	6-4
Neutral - Eight Small Holes	14-8	12-8	12-8	12-8
Post Line Connectors Suitable for Loop Feed	6-350 kcmil		6-350 kcmil	
Equipment Ground	12-8	12-2	12-8	12-2

BJ

Connector	Copper	
	Solid	Strand
Line Meter Socket	—	6-4/0
Load Base Lugs	—	1-4/0
Neutral A	—	1-4/0
Neutral/Ground B	—	6-2/0
Neutral/Ground C	14-8	14-4

BK

Connector	Copper		Aluminum	
	Solid	Strand	Solid	Strand
Line Meter Socket	—	6-350 mcm	—	6-350 mcm
Load Base Lugs	—	1-4/0	—	1-4/0
Neutral A	—	1-4/0	—	1-4/0
Neutral/Ground B	—	6-2/0	—	6-2/0
Neutral/Ground C	14-8	14-4	12-8	12-4

BM

Connector	Copper		Aluminum	
	Solid	Strand	Solid	Strand
Line	—	6-300	—	6-350
Load	—	1-300	—	1-300
Neutral A	—	1-300	—	1-300
Neutral B	—	6-2/0	—	6-2/0
Neutral C	14-8	14-1/0	12-1/0	12-1/0

BZ

Connector	Copper		Aluminum	
	Solid	Strand	Solid	Strand
Load	—	4/0-350	—	300-500
Neutral A	—	2-600	—	2-600
Neutral B	—	6-350	—	6-350

S

Connector	Copper		Aluminum	
	Solid	Strand	Solid	Strand
Post Line Connectors Suitable for Loop Feed	6-350 kcmil		6-350 kcmil	
Equipment Ground	12-2		12-2	

SS

Connector	Copper		Aluminum	
	Solid	Strand	Solid	Strand
Line	1/2" Stud Terminals		1/2" Stud Terminals	
Load	—	1-350	—	1-350
Neutral A	—	6-350	—	6-350
Neutral B	12-8	12-2	—	8-2
Neutral C	1/2" Stud Terminals		1/2" Stud Terminals	

Wire Range Tables

T2

Connector	Copper		Aluminum	
	Solid	Strand	Solid	Strand
Post Line Connectors Suitable for Loop Feed	2-250 kcmil		2-250 kcmil	
Equipment Ground	12-2		12-2	

U

Connector	Copper		Aluminum	
	Solid	Strand	Solid	Strand
Line Meter Socket	—	1/0-250	—	1/0-250
Load	—	6-1/0	—	4-1/0
Neutral – Large Single Lugs	—	1-300	—	1-300
Neutral – Small Single Lugs	14-8	14-1/0	12-8	12-1/0
Neutral - 3 Large Holes	14-8	10-4	—	6-4
Neutral - 3 Small Holes	14-8	12-8	12-8	12-8
Equipment Ground	12-8	12-2	12-8	12-2
Post Line Connectors Suitable for Loop Feed	6-350 kcmil		6-350 kcmil	
Equipment Ground	12-2	12-2	12-2	12-2

V

Connector	Copper		Aluminum	
	Solid	Strand	Solid	Strand
Line	14-8	14-1/0	12-8	12-1/0
Load	—	—	—	—
Neutral - Large Hole	12-8	12-1/0	10-8	10-1/0
Neutral - Small Hole	14-8	14-4	12-8	12-4
Equipment Ground	12-8	12-2	12-8	12-2

VA

Connector	Copper		Aluminum	
	Solid	Strand	Solid	Strand
Line	1/2" Stud Terminals			
Load	—	1-300	—	1-300
Neutral A	12-2	12-2	12-2	12-2
Neutral B	—	1-300	—	1-300
Neutral C	1/2" Stud Terminals			

VB

Connector	Copper		Aluminum	
	Solid	Strand	Solid	Strand
Neutral/Ground - Large Holes	14-8	10-4	12-8	10-4
Neutral/Ground - Small Holes	14-8	12-8	12-8	12-8

W

Connector	Copper		Aluminum	
	Solid	Strand	Solid	Strand
Equipment Ground	(2) 14	(2) 14	—	—
Equipment Ground	(2) 12	(2) 12	(2) 12	(2) 12
Equipment Ground	(2) 10	(2) 10	(2) 10	(2) 10
Equipment Ground	(1) 12, (1) 14	—	—	—
Equipment Ground	(1) 10, (1) 14	—	—	—
Equipment Ground	(1) 10, (1) 12	—	(1) 10, (1) 12	—
Equipment Ground	(1) 8-4	(1) 8-4	—	(1) 8-4

Z

Connector	Copper		Aluminum	
	Solid	Strand	Solid	Strand
Line	14-8	14-1/0	12-8	12-1/0
Load	14-8	14-1/0	12-8	12-1/0
Neutral - Large Hole	12-8	12-1/0	10-8	10-1/0
Neutral - Small Hole	14-8	14-4	12-8	12-4
Equipment Ground	12-8	12-2	12-8	12-2

ZB

Connector	Copper		Aluminum	
	Solid	Strand	Solid	Strand
Neutral N1	—	1-300	—	1-300
Neutral N2	6-2/0	6-2/0	14-1/0	14-1/0
Neutral N3	14-4	14-4	12-4	12-4
Load 1	—	1-300	—	1-300
Equipment Ground	6-2/0	6-2/0	6-2/0	6-2/0

ZZ

Connector	Copper		Aluminum	
	Solid	Strand	Solid	Strand
Line Meter Socket	—	6-1/0	—	6-1/0
Load	—	1-1/0	—	1-1/0
Neutral B	—	6-1/0	—	6-1/0
Neutral C	14-8	14-1/0	12-8	12-1/0
Neutral D	—	2-260	—	2-260
3 Large Holes	14-8	14-4	12-8	12-4
4 Small Holes	14-8	14-8	12-8	12-8
Equipment Ground	14-8	14-4	12-8	12-4
3 Large Holes	14-8	14-8	12-8	12-8

400 Amps

Connector	Copper		Aluminum	
	Solid	Strand	Solid	Strand
Line ¹	—	—	—	—
Load 1	1-300	—	1-300	—
Neutral N1	—	1-300	—	1-300
Equipment Ground	6-2/0	6-2/0	6-2/0	6-2/0

Data subject to change without notice.

¹ Crimp-on/connector lug is not supplied by Midwest.

Aluminum Mobile Home

Specifications

- NEMA 3R weatherproof construction
- 14-gauge aluminum power head construction
- Durable polyester powder coat finish resists chipping and fading (available in optional green finish)
- Suitable for use as service entrance equipment
- 22 kAIC amps RMS symmetrical short circuit rating
- Ring type, 4-jaw single phase meter socket series wired to main
- 600 MCM loop feed lugs on 3 and 4 socket models
- Available with up to 4 meters
- Available with 200 amp factory installed main breaker(s)
- Lockable, sealable covers with stainless steel latch
- Direct burial galvanized mounting posts supplied with adjustable foot extensions for increased stability

Installation Features

- Multi-gang construction reduces the number of installations
- Modular construction allows post installation for trenching and feeder cables (power heads can be installed at a later time)
- Unique “cap-off” feature on post for splice through applications
- Light weight aluminum power head construction allows easy installation by a single electrician
- Rolled edges on all post wire entry points
- Removable access doors on both sides of power head



Basic Model

Single and Multi-gang Power Heads, 200 Amps, 120/240V

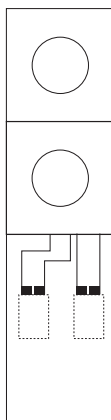

Fig. A
 MH100S0, MH200S0,
 MH300S0

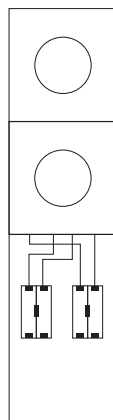

Fig. B
 MH120B0, MH220B0,
 MH320B0, MH420B0

Fig.	Model Number ^{1,2}	Meter Sockets	Power Heads	Amps	Main Breaker	Hub Opening	Unit Wt.	UL
A	MH100S0	1	1	200	Not Included (125A Max Plug-in)	N	22	Y
B	MH120B0	1	1		Included (200A Bolt-on)		22	
A	MH200S0	2	1		Not Included (125A Max Plug-in)		26	
B	MH220B0	2	1		Included (200A Bolt-on)		26	
A	MH300S0	3	2		Not Included (125A Max Plug-in)		39	
B	MH320B0	3	2		Included (200A Bolt-on)		39	
B	MH420B0	4	2		Included (200A Bolt-on)		52	

¹ All models available in optional green finish. Substitute trailing "0" with "1" (i.e., MH100S1).
² Order post separately.

Mounting Posts for Single and Multi-gang Power Heads

Model Number ¹	Color	Unit Wt. ²
P2POSTGRAY	Gray	26
P2POST	Green	

¹ Required for installation of power head.
² Post is shipped separately.

Dimensions

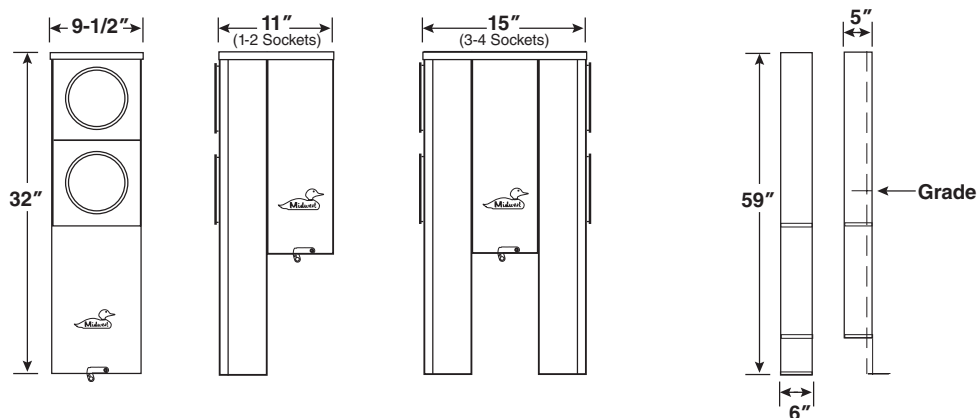

Data subject to change without notice.

Section 2

Single Socket Metering



Application Information

Midwest's Single Socket Metering products are designed for residential use. They are UL labeled and are manufactured with surface mounted outdoor enclosures. Many of our units are utility approved (see tables on the following page.)

Our products range from 20A to 320A and are available in single phase or three phase.



Features and Benefits

- Single or Three phase
- Integral duplex ground extruded in neutral lug

Rugged Durability

- Heavy duty lug screws provide stronger connection component for reliable termination
- G90 galvanized bridge provides superior corrosion resistance
- NEMA 3R enclosure
- 200A units have jaws made of copper plated alloy and have reinforcing springs to help maintain electrical connections

Installation Ease

- 200A units have slide-nuts to allow for ease of installation of conductors and help eliminate lost components
- 125A units have horn bypass kit that is field installable by changing slide-nut

User Safety

- Tested and UL listed up to 10 kAIC rating with specified overcurrent protection
- Selected items are utility approved



Sockets with 4 Jaws/Terminals

Std. Prefix	Other Features	Product Group	Amps	Service Design	Max. Conductor (Line and Load)	Std. Suffixes	Utility Approved (if applicable)	Midwest Electric Product
U	A = Aluminum Cab B = Barrel Lock F = Barrel Lock & Lock Guard G = Grounded Fifth Terminal H = Horn Bypass S = Screw Type Sealing Ring T = Grounding Connector (#14-#2 CU-AL) Z = 5/16" Hex Head Connector Screw	RS = Residential Service, Single Position	1 = 125 5 = 150 2 = 200	0 = Overhead 1 = Combination Overhead/Underground, Side Wired 2 = Underground, Side Wired 3 = Combination Overhead/Underground, Side Wired	0 = 3/8" Stud Connectors 2 = #250 kcmil Connectors 3 = #350 kcmil Connectors 6 = #600 kcmil Connectors 9 = Dual #500 kcmil Connectors	B = Small Hub Opening C = Small Hub Cover Plate HL = High Leg Label (Delta Service) L = 1 1/4" Hub N = 2" Hub ND = Neutral Disconnect T = Large Hub Opening U = Large Hub Cover Plate	FL = Meter Equipment Group KC = KCP+L	MEP

Sockets with 4, 5 or 7 Jaws/Terminals

Std. Prefix	Other Features	Product Group	Jaw Qty.	Amps	Service Design	Max. Conductor (Line and Load)	Std. Suffixes	Utility Approved (if applicable)	Midwest Electric Product
U	A = Aluminum Cab B = Barrel Lock C = Spring Jaw Socket F = Barrel Lock & Lock Guard H = Horn Bypass S = Screw Type Sealing Ring T = Grounding Connector (#14-#2 CU-AL) Z = 5/16" Hex Head Connector Screw	H = Commercial or Residential Service, Single Position (Lever Bypass)	4 = 4 Terminal 5 = 5 Terminal 7 = 7 Terminal	2 = 200 3 = 320	0 = Overhead 1 = Combination Overhead/Underground, Side Wired 2 = Underground, Side Wired 3 = Combination Overhead/Underground, Side Wired	0 = 3/8" Stud Connectors 2 = #250 kcmil Connectors 3 = #350 kcmil Connectors 6 = #600 kcmil Connectors 9 = Dual #500 kcmil Connectors	B = Small Hub Opening C = Small Hub Cover Plate HL = High Leg Label (Delta Service) L = 1 1/4" Hub N = 2" Hub ND = Neutral Disconnect SH = Stainless Steel Hasp T = Large Hub Opening U = Large Hub Cover Plate	FL = Meter Equipment Group KC = KCP & L	MEP

* Model numbers beginning with "10" or "MEP" will not follow the nomenclature.

Data subject to change without notice.

Section 2 – Single Socket Metering

1-Phase

20 – 200 Amps, 600V

Amps	Model Number Ringless	Line Wire Range (CU/AL)	Overhead/Underground Line Feed	Ground Range (CU/AL)	Triplex Ground	Number of Terminals	Lever Bypass	Horned Bypass	Hub Type	Enclosure N3R	UL and Utility Approved
20	1007003CMEP	#12	Bottom	(2) #14-2	N	13	N	N	Solid Top	G90 Steel	UL, DTE
	1007361CMEP	#12	Bottom	(2) #14-2	N	8	N	N	Solid Top	G90 Steel	UL, DTE
125	1006385BMEP	#8-2/0	Bottom	No Ground	N	4	N	N	Solid Top	G90 Steel	UL, DTE
	MEPKR1AS1BTZ	#8-2/0	Top	#14-2	Y	4	N	N	Small Hub Opening	G90 Steel	UL
	MEPKS1AS1BT	#8-2/0	Top/Bottom	#14-2	Y	4	N	Y	Small Hub Opening	G90 Steel	UL
	MEPKS1AS1BTV	#8-2/0	Top	#14-2	Y	4	N	Y	Small Hub Opening	G90 Steel	UL, AEP
	UATZRS101CFLMEP	#8-2/0	Top/Bottom	#14-2	Y	4	N	N	Small Hub Cover Plate	Aluminum	UL, MEG
	UBHRS101BMEP	#8-2/0	Top/Bottom	No Ground	N	4	N	Y	Small Hub Opening	G90 Steel	UL
	UFHTRS101BMEP	#8-2/0	Top/Bottom	#14-2	Y	4	N	Y	Small Hub Opening	G90 Steel	UL, AEP
	UGHTRS101BMEP	#8-2/0	Top/Bottom	#14-2	Y	5	N	Y	Small Hub Opening	G90 Steel	UL
	UHTRS101BMEP	#8-2/0	Top/Bottom	#14-2	Y	4	N	Y	Small Hub Opening	G90 Steel	UL
	URS101BCPLMEP	#8-2/0	Top/Bottom	(2) #14-2	Y	4	N	N	Small Hub Opening	G90 Steel	UL
	URS101CCPLMEP	#8-2/0	Top/Bottom	(2) #14-2	Y	4	N	N	Small Hub Cover Plate	G90 Steel	UL
	UTRS101BMEP	#8-2/0	Top/Bottom	#14-2	Y	4	N	N	Small Hub Opening	G90 Steel	UL, CMP
	UTZRS101CFLMEP	#8-2/0	Top/Bottom	#14-2	Y	4	N	N	Small Hub Cover Plate	G90 Steel	UL, MEG
150	UTRS502BMEP	#8-250MCM	Top/Bottom	#14-2	Y	4	N	N	Small Hub Opening	G90 Steel	UL
200	1004709DMEP	#8-250MCM	Top/Bottom	No Ground	N	4	N	N	Small Hub Opening	G90 Steel	UL, DTE
	1004710EMEP	#8-250MCM	Top/Bottom	No Ground	N	4	N	N	Small Hub Cover Plate	G90 Steel	UL, DTE
	1007665AMEP	#8-250MCM	Top/Bottom	#14-2	Y	4	N	Y	Small Hub Opening	G90 Steel	UL, AEP, CECHA
	1007665MEP	#8-250MCM	Top/Bottom	#14-2	Y	4	N	Y	Small Hub Opening	G90 Steel	UL, CECHA
	1009995MEP	#6-350MCM	Top/Bottom	No Ground	N	4	Y	N	Small Hub Cover Plate	G90 Steel	UL, DTE
	1011692MEP	#6-350MCM	Top/Bottom	#14-2	Y	4	Y	N	Small Hub Cover Plate	Aluminum	UL, AEP, CECHA
	MEPKR1CS1BT	#8-350MCM	Top	#14-2	Y	4	N	N	Small Hub Opening	G90 Steel	UL, CECHA
	MEPKS1CS1BJT	#8-250MCM	Top/Bottom	#14-2	Y	4	N	Y	Small Hub Opening	G90 Steel	UL
	MEPKS1CS1BJTV	#8-250MCM	Top	#14-2	Y	4	N	Y	Small Hub Opening	G90 Steel	UL, AEP
	MEPKS1CS1DT	#8-350MCM	Top/Bottom	#14-2	Y	4	N	Y	Small Hub Cover Plate	G90 Steel	UL
	MEPKS1CS1DTV	#8-350MCM	Top/Bottom	#14-2	Y	4	N	Y	Small Hub Cover Plate	G90 Steel	UL, AEP
	MEPKR1DH1DQRZ	#8-350MCM	Top/Bottom	#14-2	N	4	N	N	Small Hub Cover Plate	G90 Steel	UL
	MEPKS1DS1AT	#8-350MCM	Top/Bottom	#14-2	Y	4	N	Y	Solid Top	G90 Steel	UL
	MEPKS1DS1ATV	#8-350MCM	Side	#14-2	Y	4	N	Y	Solid Top	G90 Steel	UL, AEP
	MEPKU1CW3CT	#6-350MCM	Top/Bottom	#14-2	Y	7	Y	N	Large Hub Opening	G90 Steel	UL
	U92197CCCPLMEP	#8-350MCM	Side	(2) #14-2	N	4	N	N	(2) Small Hub Cover Plates	G90 Steel	UL
	UAFHTRS202BSHMEP	#8-250MCM	Top/Bottom	#14-2	Y	4	N	Y	Small Hub Opening	Aluminum	UL, AEP
	UAFHTRS223ASHMEP	#8-350MCM	Bottom	#14-2	Y	4	N	Y	Solid Top	Aluminum	UL, AEP

Data subject to change without notice.

1-Phase

200 Amps, 600V (continued)

Amps	Model Number Ringless	Line Wire Range (CU/AL)	Overhead/Underground Line Feed	Ground Range (CU/AL)	Triplex Ground	Number of Terminals	Lever Bypass	Horned Bypass	Hub Type	Enclosure N3R	UL and Utility Approved
200	UATH4203BFLMEP	#6-350MCM	Top/Bottom	#14-2	Y	4	Y	N	Small Hub Opening	Aluminum	UL, MEG
	UATH4203TFLMEP	#6-350MCM	Top/Bottom	#14-2	Y	4	Y	N	Large Hub Opening	Aluminum	UL, MEG
	UATH4213CFLMEP	#6-350MCM	Top/Bottom	#14-2	Y	4	Y	N	Small Hub Cover Plate	Aluminum	UL, MEG
	UATH4213UFLMEP	#6-350MCM	Top/Bottom	#14-2	Y	4	Y	N	Large Hub Cover Plate	Aluminum	UL, MEG
	UATRS202BFLMEP	#8-250MCM	Top/Bottom	#14-2	Y	4	N	N	Small Hub Opening	Aluminum	UL, MEG
	UATRS212CFLMEP	#8-250MCM	Top/Bottom	#14-2	Y	4	N	N	Small Hub Cover Plate	Aluminum	UL, MEG
	UATRS213AFLMEP	#8-350MCM	Bottom	#14-2	Y	4	N	N	Solid Top	Aluminum	UL, MEG
	UATRS213CFLMEP	#8-350MCM	Top/Bottom	#14-2	Y	4	N	N	Small Hub Cover Plate	Aluminum	UL, MEG
	UATRS223AFLMEP	#8-350MCM	Bottom	#14-2	Y	4	N	N	Solid Top	Aluminum	UL, MEG
	UBHRS202BMEP	#8-250MCM	Top	No Ground	N	4	N	Y	Small Hub Opening	G90 Steel	UL
	UBHRS212BMEP	#8-250MCM	Top/Bottom	No Ground	N	4	N	Y	Small Hub Opening	G90 Steel	UL
	UFHTRS202BMEP	#8-250MCM	Top/Bottom	#14-2	Y	4	N	Y	Small Hub Opening	G90 Steel	UL, AEP
	UFHTRS223AMEP	#8-350MCM	Bottom	#14-2	Y	4	N	Y	Solid Top	G90 Steel	UL, AEP
	UFHTRS233CMEP	#8-350MCM	Top/Bottom	#14-2	Y	4	N	Y	Small Hub Cover Plate	G90 Steel	UL, AEP
	UFTH4213CMEP	#6-350MCM	Top/Bottom	#14-2	Y	4	Y	N	Small Hub Cover Plate	G90 Steel	UL, AEP
	UGHRS212CKCMEP	#8-250MCM	Top/Bottom	No Ground	N	5	N	Y	Small Hub Cover Plate	G90 Steel	UL, KCP&L
	UGHTRS213BMEP	#8-350MCM	Top/Bottom	#14-2	Y	5	N	Y	Small Hub Opening	G90 Steel	UL
	UGTH4213CMEP	#6-350MCM	Top/Bottom	#14-2	Y	5	N	N	Small Hub Cover Plate	G90 Steel	UL
	UGTRS213CMEP	#8-350MCM	Top/Bottom	#14-2	Y	5	N	N	Small Hub Cover Plate	G90 Steel	UL
	UH4213CMEP	#6-350MCM	Top/Bottom	No Ground	N	4	Y	N	Small Hub Cover Plate	G90 Steel	UL
	UHTRS202BMEP	#8-250MCM	Top/Bottom	#14-2	Y	4	N	Y	Small Hub Opening	G90 Steel	UL
	UHTRS223AMEP	#8-350MCM	Side	#14-2	Y	4	N	Y	Solid Top	G90 Steel	UL
	URTRS213AMEP	#8-350MCM	Bottom	#14-2	Y	4	N	N	Solid Top	G90 Steel	UL
	UT92197CCFLMEP	#8-350MCM	Top/Bottom	#14-2	Y	4	N	N	(2) Small Hub Cover Plates	G90 Steel	UL, MEG
	UTH4203BFLMEP	#6-350MCM	Top/Bottom	#14-2	Y	4	Y	N	Small Hub Opening	G90 Steel	UL, MEG
	UTH4203TFLMEP	#6-350MCM	Top/Bottom	#14-2	Y	4	Y	N	Large Hub Opening	G90 Steel	UL, MEG
	UTH4213BMEP	#6-350MCM	Top/Bottom	#14-2	Y	4	Y	N	Small Hub Opening	G90 Steel	UL
	UTH4213CMEP	#6-350MCM	Top/Bottom	#14-2	Y	4	N	N	Small Hub Cover Plate	G90 Steel	UL
	UTH4213CFLMEP	#6-350MCM	Top/Bottom	#14-2	Y	4	Y	N	Small Hub Cover Plate	G90 Steel	UL, MEG
	UTH4213UFLMEP	#6-350MCM	Top/Bottom	#14-2	Y	4	Y	N	Large Hub Cover Plate	G90 Steel	UL, MEG
	UTRS202BMEP	#8-250MCM	Top/Bottom	#14-2	Y	4	N	N	Small Hub Opening	G90 Steel	UL, CMP
	UTRS212BMEP	#8-250MCM	Top/Bottom	#14-2	Y	4	N	N	Small Hub Opening	G90 Steel	UL
UTRS212CMEP	#8-250MCM	Top/Bottom	#14-2	Y	4	N	N	Small Hub Cover Plate	G90 Steel	UL	

Data subject to change without notice.

1-Phase

200 Amps, 600V (continued)

Amps	Model Number Ringless	Line Wire Range (CU/AL)	Overhead/Underground Line Feed	Ground Range (CU/AL)	Triplex Ground	Number of Terminals	Lever Bypass	Horned Bypass	Hub Type	Enclosure N3R	UL and Utility Approved
200	UTRS2138BMEP	(1) #8-350MCM Line (2) #8-250MCM Load	Top/Bottom	#14-2	Y	4	N	N	Small Hub Opening	G90 Steel	UL
	UTRS213AFLMEP	#8-350MCM	Bottom	#14-2	Y	4	N	N	Solid Top	G90 Steel	UL, MEG
	UTRS213BMEP	#8-350MCM	Top/Bottom	#14-2	Y	4	N	N	Small Hub Opening	G90 Steel	UL, CMP
	UTRS213CFLMEP	#8-350MCM	Top/Bottom	#14-2	Y	4	N	N	Small Hub Cover Plate	G90 Steel	UL, MEG
	UTRS213CMEP	#8-350MCM	Top/Bottom	#14-2	Y	4	N	N	Small Hub Cover Plate	G90 Steel	UL, CMP
	UTRS223AFLMEP	#8-350MCM	Bottom	#14-2	Y	4	N	N	Solid Top	G90 Steel	UL, MEG
	UTRS223AMEP	#8-350MCM	Bottom	#14-2	Y	4	N	N	Solid Top	G90 Steel	UL

1-Phase

320 Amps, 600V

Amps	Model Number Ringless	Line Wire Range (CU/AL)	Overhead/Underground Line Feed	Ground Range (CU/AL)	Triplex Ground	Number of Terminals	Lever Bypass	Horned Bypass	Hub Type	Enclosure N3R	UL and Utility Approved
320	1007672MEP ¹	Studs – (1) 600MCM or (2) 350MCM	Top	#14 -1/0	Y	4	Y	N	Large Hub Opening	G90 Steel	UL, CECHA
	1008068MEP	(2) #6-350MCM	Top/Bottom	#14 -1/0	Y	4	Y	N	Large Hub Cover Plate	G90 Steel	UL, AEP
	1008435MEP	#4-600MCM	Bottom	#14 -1/0	Y	4	Y	N	Solid Top	G90 Steel	UL
	1008836MEP ¹	Studs – (1) 600MCM or (2) 350MCM	Top/Bottom	#14 -1/0	Y	4	Y	N	Large Hub Cover Plate	G90 Steel	UL, MEG
	1008837MEP ¹	Studs – 600MCM or (2) 350MCM	Top/Bottom	#14 -1/0	Y	4	Y	N	Large Hub Cover Plate	Aluminum	UL, MEG
	1009260MEP ¹	Studs – (1) 600MCM or (2) 350MCM	Top/Bottom	#14 -1/0	Y	4	Y	N	Large Hub Cover Plate	G90 Steel	UL
	1009788AMEP ¹	Studs – (1) 600MCM or (2) 350MCM	Top/Bottom	No Ground	N	4	Y	N	Large Hub Cover Plate	G90 Steel	UL, DTE
	MEPKU1FS1EMT	#4-600MCM	Top/Bottom	#14 -1/0	Y	4	Y	N	Large Hub Cover Plate	G90 Steel	UL
	UAFT4330TSHMEP ¹	Studs – (1) 600MCM or (2) 350MCM	Top/Bottom	#14 -1/0	Y	4	Y	N	Large Hub Opening	Aluminum	UL, AEP
	UAFT4336TSHMEP	#4-600MCM	Top/Bottom	#14 -1/0	Y	4	Y	N	Large Hub Opening	Aluminum	UL, AEP
	UATH4300TFLMEP ¹	Studs – (1) 600MCM or (2) 350MCM	Top/Bottom	#14 -1/0	Y	4	Y	N	Large Hub Opening	Aluminum	UL, MEG
	UFTH4330TMEP ¹	Studs – (1) 600MCM or (2) 350MCM	Top/Bottom	#14 -1/0	Y	4	Y	N	Large Hub Opening	G90 Steel	UL, AEP
	UFTH4336TMEP	#4-600MCM	Top/Bottom	#14 -1/0	Y	4	Y	N	Large Hub Opening	G90 Steel	UL, AEP
	UH43068TCPLMEP	(1) #4-600MCM Line (2) #6-250MCM Load	Top	(2) #14-2	Y	4	Y	N	Large Hub Opening	G90 Steel	UL
	UTH4300TMEP	#4-600MCM	Top/Bottom	#14 -1/0	Y	7	Y	N	Large Hub Cover Plate	G90 Steel	UL
	UTH4300TFLMEP ¹	Studs – (1) 600MCM or (2) 350MCM	Top/Bottom	#14-1/0	Y	4	Y	N	Large Hub Opening	G90 Steel	UL, MEG
	UTH4330TMEP ¹	Studs – (1) 600MCM or (2) 350MCM	Top/Bottom	#14-1/0	Y	4	Y	N	Large Hub Opening	G90 Steel	UL, CMP
	UTH43369TMEP	(1) #4-600MCM Line (2) #6-350MCM Load	Top	#14-1/0	Y	4	Y	N	Large Hub Opening	G90 Steel	UL
UTH73069THLMEP	(1) #4-600MCM Line (2) #6-350MCM Load	Top/Bottom	#14-1/0	Y	4	Y	N	Large Hub Opening	G90 Steel	UL	

¹ Lugs not included. This product comes with studs only. Order lugs separately, see Accessories on page 2-9. One lug per kit, order appropriate QTY needed.

For example, order three lugs (A, C, N) if meter is 1-Phase or four lugs (A, B, C, N) if meter is 3-Phase.

Data subject to change without notice.

3-Phase

20 – 200 Amps, 600V

Amps	Model Number Ringless	Line Wire Range (CU/AL)	Overhead/ Underground Line Feed	Ground Range (CU/AL)	Triplex Ground	Number of Terminals	Lever Bypass	Horned Bypass	Hub Type	Enclosure N3R	Certification
20	URSTS132CMEP	#10-12	Top/Bottom	#14-2	Y	13	N	N	Small Hub Cover Plate	G90 Steel	UL, EUSERC
200	1007670MEP	#6-350MCM	Top	#14-2	Y	7	Y	N	Large Hub Opening	G90 Steel	UL, CECHA
	UAFTH7213TSHMEP	#6-350MCM	Top/Bottom	#14-2	Y	7	Y	N	Large Hub Opening	Aluminum	UL, AEP
	UATH7203BFLMEP	#6-350MCM	Top/Bottom	#14-2	Y	7	Y	N	Small Hub Opening	Aluminum	UL, MEG
	UATH7203TFLMEP	#6-350MCM	Top/Bottom	#14-2	Y	7	Y	N	Large Hub Opening	Aluminum	UL, MEG
	UATH7213CFLMEP	#6-350MCM	Top/Bottom	#14-2	Y	7	Y	N	Small Hub Cover Plate	Aluminum	UL, MEG
	UATH7213UFLMEP	#6-350MCM	Top/Bottom	#14-2	Y	7	Y	N	Large Hub Cover Plate	Aluminum	UL, MEG
	UBC7213BMEP	#6-350MCM	Top/Bottom	No Ground	N	7	Y	N	Small Hub Opening	G90 Steel	UL
	UBH7213TMEP	#6-350MCM	Top/Bottom	No Ground	N	7	Y	N	Large Hub Opening	G90 Steel	UL
	UFTH7213BMEP	#6-350MCM	Top/Bottom	#14-2	Y	7	Y	N	Small Hub Opening	G90 Steel	UL, AEP
	UFTH7213TMEP	#6-350MCM	Top/Bottom	#14-2	Y	7	Y	N	Large Hub Opening	G90 Steel	UL, AEP
	UFTTH7213TMEP	#6-350MCM	Top/Bottom	(2) #14-2	Y	7	Y	N	Large Hub Opening	G90 Steel	UL, AEP
	UH7213CKCMEP	#6-350MCM	Top/Bottom	No Ground	N	7	Y	N	Small Hub Cover Plate	G90 Steel	UL, KCP&L
	UH7213CMEP	#6-350MCM	Top/Bottom	No Ground	N	7	Y	N	Small Hub Cover Plate	G90 Steel	UL
	UTH7203BFLMEP	#6-350MCM	Top/Bottom	#14-2	Y	7	Y	N	Small Hub Opening	G90 Steel	UL, MEG
	UTH7203TFLMEP	#6-350MCM	Top/Bottom	#14-2	Y	7	Y	N	Large Hub Opening	G90 Steel	UL, MEG
	UTH7203TMEP	#6-350MCM	Top/Bottom	#14-2	Y	7	Y	N	Large Hub Opening	G90 Steel	UL, CMP
	UTH7213BMEP	#6-350MCM	Top/Bottom	#14-2	Y	7	Y	N	Small Hub Opening	G90 Steel	UL
	UTH7213CMEP	#6-350MCM	Top/Bottom	#14-2	Y	7	Y	N	Small Hub Cover Plate	G90 Steel	UL, EXCEL
	UTH7213THLMEP	#6-350MCM	Top/Bottom	#14-2	Y	7	Y	N	Large Hub Opening	G90 Steel	UL
	UTH7213TMEP	#6-350MCM	Top/Bottom	#14-2	Y	7	Y	N	Large Hub Opening	G90 Steel	UL
UTH7213UMEP	#6-350MCM	Top/Bottom	#14-2	Y	7	Y	N	Large Hub Cover Plate	G90 Steel	UL, CMP	

3-Phase

320 Amps, 600V

Amps	Model Number Ringless	Line Wire Range (CU/AL)	Overhead/Underground Line Feed	Ground Range (CU/AL)	Triplex Ground	Number of Terminals	Lever Bypass	Horned Bypass	Hub Type	Enclosure N3R	Certification
320	UAFTH7330TSHMEP ¹	Studs – (1) 600MCM or (2) 350MCM	Top/Bottom	#14 -1/0	Y	7	Y	N	Large Hub Opening	Aluminum	UL, AEP
	UAFTH7336TSHMEP	#4-600MCM	Top/Bottom	#14 -1/0	Y	7	Y	N	Large Hub Opening	Aluminum	UL, AEP
	UATH7300TFLMEP ¹	Studs – (1) 600MCM or (2) 350MCM	Top/Bottom	#14 -1/0	Y	7	Y	N	Large Hub Opening	Aluminum	UL, MEG
	UATH7300UFLMEP ¹	Studs – (1) 600MCM or (2) 350MCM	Top/Bottom	#14 -1/0	Y	7	Y	N	Large Hub Cover Plate	Aluminum	UL, MEG
	UATH7330UFLMEP	Studs – (1) 600MCM or (2) 350MCM	Side	#14 -1/0	Y	7	Y	N	Large Hub Cover Plate	Aluminum	UL, MEG
	UFTH7330TMEP ¹	Studs – (1) 600MCM or (2) 350MCM	Top/Bottom	#14 -1/0	Y	7	Y	N	Large Hub Opening	G90 Steel	UL, AEP
	UFTH7336TMEP	#4-600MCM	Top/Bottom	#14 -1/0	Y	7	Y	N	Large Hub Opening	G90 Steel	UL, AEP
	UFTTH7330TMEP ¹	Studs – (1) 600MCM or (2) 350MCM	Top/Bottom	(2) #14-1/0	Y	7	Y	N	Large Hub Opening	G90 Steel	UL, AEP
	UFTTH7336TMEP	#4-600MCM	Top/Bottom	(2) #14-1/0	Y	7	Y	N	Large Hub Opening	G90 Steel	UL, AEP
	UTH7300TFLMEP ¹	Studs – (1) 600MCM or (2) 350MCM	Top/Bottom	#14-1/0	Y	7	Y	N	Large Hub Opening	G90 Steel	UL, MEG
	UTH7330TMEP ¹	Studs – (1) 600MCM or (2) 350MCM	Top/Bottom	#14-1/0	Y	7	Y	N	Large Hub Opening	G90 Steel	UL
	UTH7330UFLMEP ¹	Studs – (1) 600MCM or (2) 350MCM	Top/Bottom	#14-1/0	Y	7	Y	N	Large Hub Cover Plate	G90 Steel	UL, MEG
	UTH73369THLMEP	(1) #4-600MCM Line (2) #6-350MCM Load	Top/Bottom	#14-1/0	Y	7	Y	N	Large Hub Opening	G90 Steel	UL
	UTJ7300UMEP	Studs – (1) 600MCM or (2) 350MCM	Top/Bottom	#14-1/0	Y	7	Y	N	Large Hub Cover Plate	G90 Steel	UL

¹ Lugs not included. This product comes with studs only. Order lugs separately, see Accessories on page 2-9. One lug per kit, order appropriate QTY needed.
For example, order three lugs (A, C, N) if meter is 1-Phase or four lugs (A, B, C, N) if meter is 3-Phase.

1-Phase or 3-Phase

200 – 320 Amps, 600V

Amps	Model Number Ringless	Line Wire Range (CU/AL)	Overhead/Underground Line Feed	Ground Range (CU/AL)	Triplex Ground	Number of Terminals	Lever Bypass	Horned Bypass	Hub Type	Enclosure N3R	Certification
200	1008801MEP	#6-350MCM	Top/Bottom	#14 -1/0	N	5	Y	N	Small Hub Cover Plate	G90 Steel	UL, EXCEL
	UAFTH5213BNDMEP	#6-350MCM	Top/Bottom	#14-2	Y	5	Y	N	Small Hub Opening	Aluminum	UL,AEP
	UATH5203BFLMEP	#6-350MCM	Top/Bottom	#14-2	Y	5	Y	N	Small Hub Opening	Aluminum	UL, MEG
	UATH5203TFLMEP	#6-350MCM	Top/Bottom	#14-2	Y	5	Y	N	Large Hub Opening	Aluminum	UL, MEG
	UATH5213CFLMEP	#6-350MCM	Top/Bottom	#14-2	Y	5	Y	N	Small Hub Cover Plate	Aluminum	UL, MEG
	UATH5213UFLMEP	#6-350MCM	Top/Bottom	#14-2	Y	5	Y	N	Large Hub Cover Plate	Aluminum	UL, MEG
	UFTH5213BNDMEP	#6-350MCM	Top/Bottom	#14-2	Y	5	Y	N	Small Hub Opening	G90 Steel	UL,AEP
	UTH5203BFLMEP	#6-350MCM	Top/Bottom	#14-2	Y	5	Y	N	Small Hub Opening	G90 Steel	UL, MEG
	UTH5203BMEP	#6-350MCM	Top/Bottom	#14-2	Y	5	Y	N	Small Hub Opening	G90 Steel	UL, CMP
	UTH5203TFLMEP	#8-350MCM	Top/Bottom	#14-2	Y	5	Y	N	Large Hub Opening	G90 Steel	UL, MEG
	UTH5213BNDMEP	#6-350MCM	Top/Bottom	#14-2	Y	5	Y	N	Small Hub Opening	G90 Steel	UL
	UTH5213CFLMEP	#6-350MCM	Top/Bottom	#14-2	Y	5	Y	N	Small Hub Cover Plate	G90 Steel	UL, MEG
	UTH5213CMEP	#6-350MCM	Top/Bottom	#14-2	Y	5	Y	N	Small Hub Cover Plate	G90 Steel	UL, CMP
	UTH5213UFLMEP	#6-350MCM	Top/Bottom	#14-2	Y	5	Y	N	Large Hub Cover Plate	G90 Steel	UL, MEG
	UTH5233CMEP	#6-350MCM	Top/Bottom	#14-2	Y	5	Y	N	Small Hub Cover Plate	G90 Steel	UL, CMP
320	UATH5300TFLMEP ¹	Studs – (1) 600MCM or (2) 350MCM	Top/Bottom	#14 -1/0	Y	5	Y	N	Large Hub Opening	Aluminum	UL, MEG
	UATH5330UFLMEP ¹	Studs – (1) 600MCM or (2) 350MCM	Top/Bottom	#14 -1/0	Y	5	Y	N	Large Hub Cover Plate	Aluminum	UL, MEG
	UTH5300TFLMEP ¹	Studs – (1) 600MCM or (2) 350MCM	Top/Bottom	#14-1/0	Y	5	Y	N	Large Hub Opening	G90 Steel	UL, MEG
	UTH5330UFLMEP ¹	Studs – (1) 600MCM or (2) 350MCM	Top/Bottom	#14-2	Y	5	Y	N	Large Hub Cover Plate	G90 Steel	UL, MEG

¹ Lugs not included. This product comes with studs only. Order lugs separately, see Accessories on page 2-9. One lug per kit, order appropriate QTY needed. For example, order three lugs (A, C, N) if meter is 1-Phase or four lugs (A, B, C, N) if meter is 3-Phase.

Accessories



ARP00003MEP, ARP00004MEP, ARP00005MEP,
ARP00006MEP, ARP00007MEP



ARP00017MEP, ARP00018MEP, ARP00019MEP,
ARP00020MEP, ARP00021MEP



ARP000035MEP

Model Number	Description
ARP00118MEP	One Lug for (2) #6 - 250MCM Cables/Phase
ARP00429MEP	One Lug for (1) #4-600M Cables/Phase or (2) 1/0-250 Cables/Phase
ARP00427MEP	Connector Kit (2) 350MCM#6 3/8 Studs for lever bypass 1009788AMEP, 1008435MEP, UTH4330TMEP, UTH4330TMEP, UGTH4330TMEP, UBTH4330TMEP, 1007672MEP, 1009260MEP
ARP00129MEP	Connector Kit #4-600MCM
ARP00326MEP	5th Terminal Kit Lever Bypass
ARP00035MEP	5th Terminal Kit Non-Lever Bypass
ARP01595MEP	HQ Bolt-on Shield for 1009788AMEP (flash shield over jaws)
ARP00984MEP	Anti-Inversion Clip (10 per package)
ARP01590MEP	DTE Auxillary Service Kit
1006630AMEP	Auxillary Contacts Enclosure G90
ARP00920MEP	Plastic Meter Socket Cover Plate
ARP90015932MEP	2R1121 Wire Front Assembly
ARP00759MEP	HQ Neutral Insulating Kit

Hub Kits

Model Number	Description
ARP00003MEP	1" Hub Kit, Small
ARP00004MEP	1.25" Hub Kit, Small
ARP00005MEP	1.5" Hub Kit, Small
ARP00006MEP	2" Hub Kit, Small
ARP00007MEP	2.5" Hub Kit, Small
ARP00017MEP	2" Hub Kit, Large
ARP00018MEP	2.5" Hub Kit, Large
ARP00019MEP	3" Hub Kit, Large
ARP00020MEP	3.5" Hub Kit, Large
ARP00021MEP	4" Hub Kit, Large

Hub Cover Plates

Model Number	Description
ARP00002MEP	Small Steel Hub Cover Plate for 3.31" Hub Openings
ARP00008MEP	Small Aluminum Hub Cover Plate for 3.31" Hub Openings
ARP00015MEP	Adapter Plt: 5" to 3.31" Hub
ARP00016MEP	Large Steel Hub Cover Plate for 5" Hub Openings
ARP00023MEP	Large Aluminum Hub Cover Plate for 5" Hub Openings

Data subject to change without notice.

Technical Data

Model Number	Gross Weight (lbs.)	Enclosure Style ¹	Cabinet Dimensions (inches)			Knockout Figure ²	Std. Pkg.
			Height (A)	Width (B)	Depth (C)		
1004709DMEP	13	A	14	8	4-2/5	13	1
1004710EMEP	13	A	14	11	4-1/10	14	1
1006385BMEP	7	A	10-9/10	8	3-1/2	15	1
1007003CMEP	13	B	16-1/2	14	3-1/2	3	1
1007361CMEP	22	B	16-1/2	14	3-1/2	3	1
1007665AMEP	12	A	14	8	4-2/5	16	1
1007665MEP	10	A	14	8	4-2/5	16	1
1007670MEP	24	A	19	13	5	11	1
1007672MEP	38	C	38-1/4	15-1/2	6-2/5	4	1
1008068MEP	39	C	34-1/2	16-1/4	6-1/2	5	1
1008435MEP	33	D	36-3/5	15	5-7/10	4	1
1008801MEP	25	A	19	13	5	30	1
1008836MEP	41	C	36-3/5	15	6-1/2	28	1
1008837MEP	26	C	36-3/5	15	6-1/2	28	1
1009260MEP	38	C	36-3/5	15	5-7/10	4	1
1009788AMEP	31	A	34-1/2	13	5	17	1
1009995MEP	25	A	19	13	5	11	1
1011692MEP	25	A	19	13	5	11	1
MEPKR1AS1BTZ	7	A	10-9/10	8	3-1/2	19	1
MEPKR1CS1BT	14	A	15	11	4-2/5	6	1
MEPKR1DH1DQRZ	18	E	17-1/10	13	5	9	1
MEPKS1AS1BT	8	A	10-9/10	8	3-1/2	19	1
MEPKS1AS1BTV	7	A	10-9/10	8	3-1/2	31	1
MEPKS1CS1BJT	12	A	14	8	4-2/5	7	1
MEPKS1CS1BJTV	11	A	14	8	4-2/5	7	1
MEPKS1CS1DT	15	A	15	11	4-2/5	6	1
MEPKS1CS1DTV	14	A	15	11	4-2/5	6	1
MEPKS1DS1AT	16	D	13	13	5	21	1
MEPKS1DS1ATV	15	D	13	13	5	8	1
MEPKU1CW3CT	25	A	19	13	5	11	1
MEPKU1FS1EMT	41	C	36-3/5	15	6	4	1
U92197CCCPLEP	17	E	17-1/10	13	5	9	1
UAFTH4330TSHMEP	22	C	36-3/5	15	5-7/10	4	1
UAFTH4336TSHMEP	28	C	36-3/5	15	5-7/10	4	1
UAFTH5213BNDMEP	19	A	19	13	5	11	1
UAFTH7213TSHMEP	19	A	19	13	5	11	1
UAFTH7330TSHMEP	37	C	39-9/10	20	6-1/2	18	1
UAFTH7336TSHMEP	39	C	39-9/10	20	6-1/2	18	1
UAFHTRS202BSHMEP	8	A	14	8	4-2/5	23	1
UAFHTRS223ASHMEP	10	C	13	13	5	8	1
UATH4203BFLMEP	18	A	19	10-1/2	5	22	1
UATH4203TFLMEP	18	A	19	10-1/2	5	22	1
UATH4213CFLMEP	18	A	19	13	5	29	1
UATH4213UFLMEP	18	A	19	13	5	29	1
UATH4300TFLMEP	39	F	34-1/2	13	5	12	1
UATH5203BFLMEP	17	A	19	10-1/2	5	22	1
UATH5203TFLMEP	17	A	19	10-1/2	5	22	1
UATH5213CFLMEP	18	A	19	13	5	11	1
UATH5213UFLMEP	18	A	19	13	5	11	1
UATH5300TFLMEP	18	A	34-1/2	13	5	12	1
UATH5330UFLMEP	36	C	39-9/10	20	6-1/2	18	1
UATH7203BFLMEP	18	A	19	10-1/2	5	22	1
UATH7203TFLMEP	18	A	19	10-1/2	5	22	1
UATH7213CFLMEP	18	A	19	13-2/5	5	12	1
UATH7213UFLMEP	18	A	19	13-2/5	5	12	1
UATH7300TFLMEP	23	F	34-1/2	15	5-7/10	12	1

¹ Enclosure Styles on page 2-12.

² Knockout Figures on pages 2-13–2-14.

Data subject to change without notice.

Single Socket

Technical Data

Model Number	Gross Weight (lbs.)	Enclosure Style ¹	Cabinet Dimensions (inches)			Knockout Figure ²	Std. Pkg.
			Height (A)	Width (B)	Depth (C)		
UATH7300UFLMEP	23	C	34-1/2	15	5-7/10	12	1
UATH7330UFLMEP	36	B	39-9/10	20	6-1/2	34	1
UATRS202BFLMEP	11	A	14	8	4-2/5	23	1
UATRS212CFLMEP	9	A	14	11	4-2/5	24	1
UATRS213AFLMEP	9	A	15	11-2/5	4-2/5	25	1
UATRS213CFLMEP	9	A	15	11	4-2/5	25	1
UATRS223AFLMEP	10	D	13	13	5	21	1
UATZRS101CFLMEP	7	A	10-9/10	8	3-1/2	19	1
UBC7213BMEP	21	A	19	13	5	11	1
UBH7213TMEP	24	A	19	13	5	11	1
UBHRS101BMEP	7	A	10-9/10	8	3-1/2	19	1
UBHRS202BMEP	11	A	14	8	4-2/5	7	1
UBHRS212BMEP	13	A	14	11	4-2/5	10	1
UFHTRS101BMEP	8	A	10-9/10	8	3-1/2	19	1
UFHTRS202BMEP	12	A	14	8	4-2/5	7	1
UFHTRS223AMEP	16	A	14	8	4-2/5	7	1
UFHTRS233CMEP	18	C	17-1/10	13	5	8	1
UFTH4213CMEP	25	A	19	13	5	11	1
UFTH4330TMEP	41	C	36-3/5	15	5-7/10	4	1
UFTH4336TMEP	42	C	36-3/5	15	5-7/10	4	1
UFTH5213BNDMEP	26	A	19	13	5	11	1
UFTH7213BMEP	26	A	19	13	5	11	1
UFTH7213TMEP	26	A	19	13	5	11	1
UFTH7330TMEP	65	C	39-9/10	20	6-1/2	18	1
UFTH7336TMEP	42	C	39-9/10	20	6-1/2	18	1
UFTTH7213TMEP	26	A	19	13	5	11	1
UFTTH7330TMEP	65	C	39-9/10	20	6-1/2	18	1
UFTTH7336TMEP	67	C	39-9/10	20	6-1/2	18	1
UGHRS212CKCMEP	13	A	14	11	4-2/5	1	1
UGHTRS101BMEP	7	A	10-9/10	8	3-1/2	19	1
UGHTRS213BMEP	14	A	15	11	4-2/5	6	1
UGTH4213CMEP	24	A	19	13	5	32	1
UGTRS213CMEP	14	A	15	11	4-2/5	6	1
UH4213CMEP	24	A	19	13	5	11	1
UH43068TCPLMEP	35	F	34-1/2	13	5	12	1
UH7213CKCMEP	24	A	19	13	5	2	1
UH7213CMEP	23	A	19	13	5	11	1
UHTRS101BMEP	7	A	10-9/10	8	3-1/2	19	1
UHTRS202BMEP	10	A	14	8	4-2/5	7	1
UHTRS223AMEP	14	D	13	13	5	8	1
URS101BCPLMEP	7	A	10-9/10	8	3-1/2	19	1
URS101CCPLMEP	7	A	10-9/10	8	3-1/2	19	1
URSTS132CMEP	23	A	20	12	4-2/5	33	1
URTRS213AMEP	15	A	15	11	4-2/5	15	1
UT92197CCFLMEP	17	D	17-1/10	13	5	27	1
UTH4203BFLMEP	23	A	19	10-1/2	5	22	1
UTH4203TFLMEP	23	A	19	10-1/2	5	22	1
UTH4213BMEP	23	A	19	13	5	11	1
UTH4213CFLMEP	28	A	19	13	5	11	1
UTH4213CMEP	25	A	19	13	5	11	1
UTH4213UFLMEP	28	A	19	13	5	11	1
UTH4300TFLMEP	32	F	34-1/2	13	5	12	1
UTH4300TMEP	32	C	34-1/2	13	5	4	1
UTH4330TMEP	39	C	36-2/5	15	5-7/10	4	1
UTH43369TMEP	40	C	36-2/5	15	5-7/10	4	1
UTH5203BFLMEP	23	A	19	10-1/2	5	22	1

¹ Enclosure Styles on page 2-12.² Knockout Figures on pages 2-13-2-14.

Data subject to change without notice.

Technical Data

Model Number	Gross Weight (lbs.)	Enclosure Style ¹	Cabinet Dimensions (inches)			Knockout Figure ²	Std. Pkg.
			Height (A)	Width (B)	Depth (C)		
UTH5203BMEP	23	A	19	10-1/2	5	22	1
UTH5203TFLMEP	23	A	19	10-1/2	5	22	1
UTH5213BNDMEP	22	A	19	13	5	11	1
UTH5213CFLMEP	25	A	19	13	5	11	1
UTH5213CMEP	22	A	19	13	5	11	1
UTH5213UFLMEP	25	A	19	13	5	11	1
UTH5233CMEP	43	C	19	13	5	27	1
UTH5300TFLMEP	32	F	34-1/2	13	5	12	1
UTH5330UFLMEP	46	C	39-9/10	20	6-1/2	18	1
UTH7203BFLMEP	23	A	19	10-1/2	5	22	1
UTH7203TFLMEP	23	A	19	10-1/2	5	22	1
UTH7203TMEP	23	A	19	10-1/2	5	22	1
UTH7213BMEP	24	A	19	13	5	11	1
UTH7213CMEP	25	A	19	13	5	11	1
UTH7213THLMEP	25	A	19	13	5	11	1
UTH7213TMEP	23	A	19	13	5	11	1
UTH7213UMEP	25	A	19	13	5	11	1
UTH7300TFLMEP	35	F	34-1/2	15	5-7/10	12	1
UTH73069THLMEP	39	A	34-1/2	15	5-7/10	20	1
UTH7330TMEP	62	C	39-9/10	20	6-1/2	18	1
UTH7330UFLMEP	64	C	39-9/10	20	6-1/2	18	1
UTH73369THLMEP	64	C	39-9/10	20	6-1/2	18	1
UTJ7300UMEP	45	A	36-1/10	15	5-3/4	4	1
UTRS101BMEP	7	A	10-9/10	8	3-1/2	19	1
UTRS202BMEP	10	A	14	8	4-2/5	7	1
UTRS212BMEP	10	A	14	11	4-2/5	10	1
UTRS212CMEP	13	A	14	11	4-2/5	10	1
UTRS2138BMEP	19	A	20	13	5	28	1
UTRS213AFLMEP	14	A	15	11	4-2/5	12	1
UTRS213BMEP	12	A	15	11	4-2/5	6	1
UTRS213CFLMEP	14	A	15	11	4-2/5	12	1
UTRS213CMEP	13	A	15	11	4-2/5	6	1
UTRS223AFLMEP	15	D	13	13	5	21	1
UTRS223AMEP	14	D	13	13	5	21	1
UTRS502BMEP	10	A	14	8	4-2/5	7	1
UTZRS101CFLMEP	7	A	10-9/10	8	3-1/2	26	1

¹ Enclosure Styles on page 2-12.

² Knockout Figures on pages 2-13--2-14.

Enclosure Styles / Cabinet Dimensions

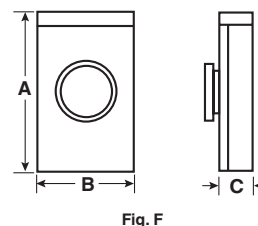
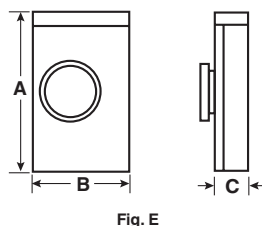
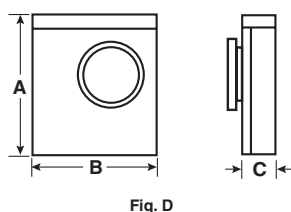
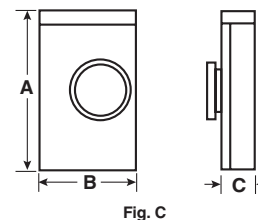
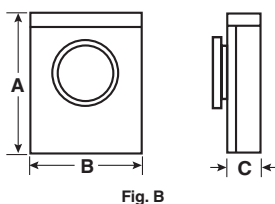
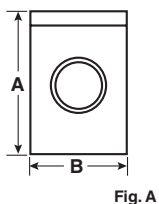

Data subject to change without notice.

Knockout Configurations

Single Socket

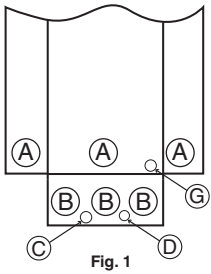

Fig. 1

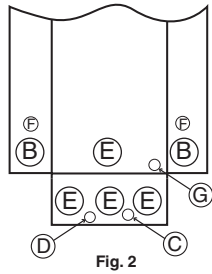

Fig. 2

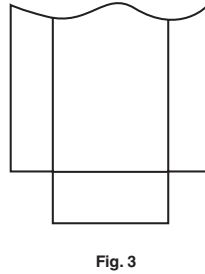

Fig. 3

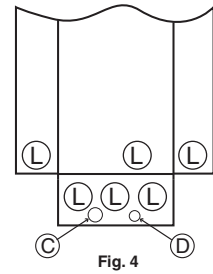

Fig. 4

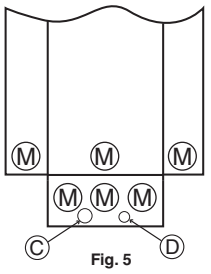

Fig. 5

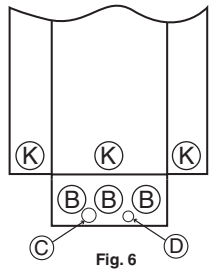

Fig. 6

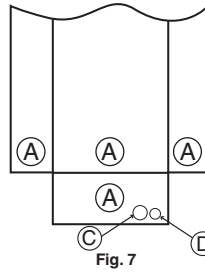

Fig. 7

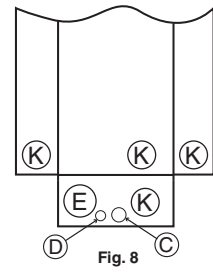

Fig. 8

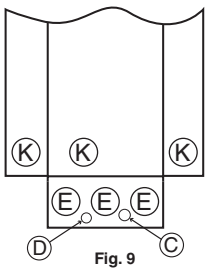

Fig. 9

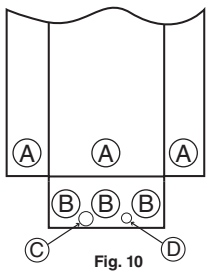

Fig. 10

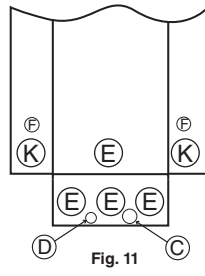

Fig. 11

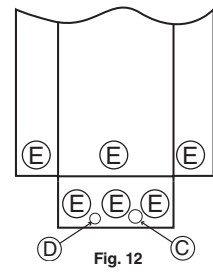

Fig. 12

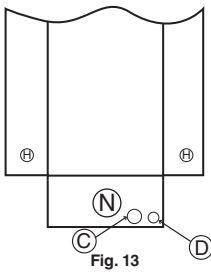

Fig. 13

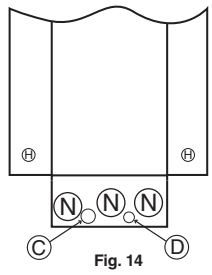

Fig. 14

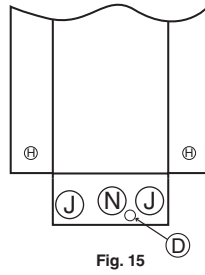

Fig. 15

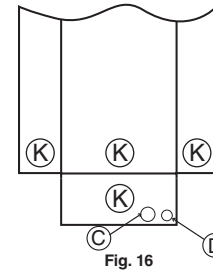

Fig. 16

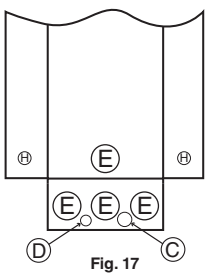

Fig. 17

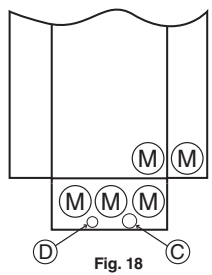

Fig. 18

Knockout Key

- A = 1-1/2", 2", 2-1/2"
- B = 1-1/4", 1-1/2", 2", 2-1/2"
- C = 1/2"
- D = 5/16"
- E = 2", 2-1/2", 3"
- F = 1/2", 3/4"
- G = 7/16"
- H = 3/4"

- I = 1-1/4", 1-1/2", 2"
- J = 1/2", 3/4", 1", 1-1/4"
- K = 1", 1-1/4", 1-1/2", 2", 2-1/2"
- L = 2", 2-1/2", 3", 3-1/2"
- M = 2", 2-1/2", 3", 3-1/2", 4"
- N = 1", 1-1/4", 1-1/2", 2"
- O = 1/2", 3/4", 1", 1-1/4", 1-1/2"

* Knockouts shown for size not for exact positions.

Knockout Configurations

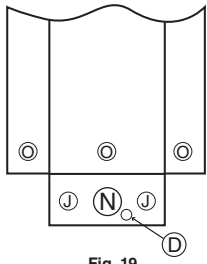

Fig. 19

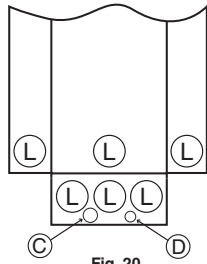

Fig. 20

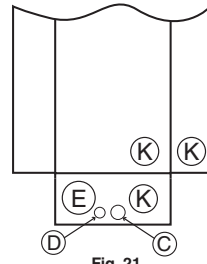

Fig. 21

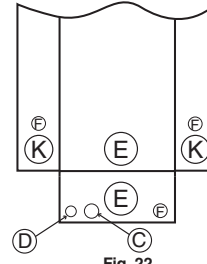

Fig. 22

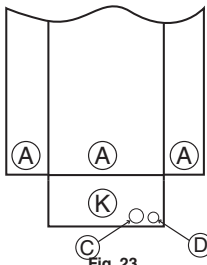

Fig. 23

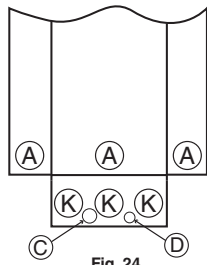

Fig. 24

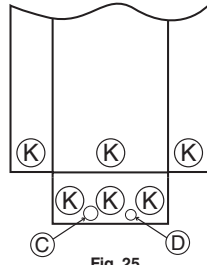

Fig. 25

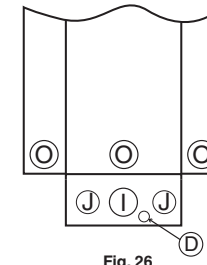

Fig. 26

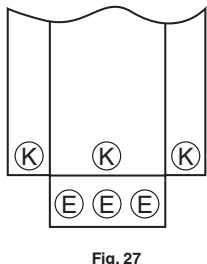

Fig. 27

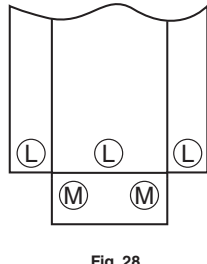

Fig. 28

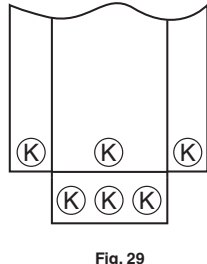

Fig. 29

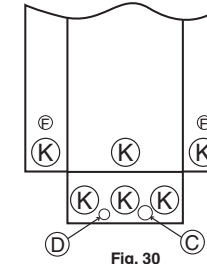

Fig. 30

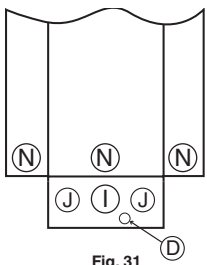

Fig. 31

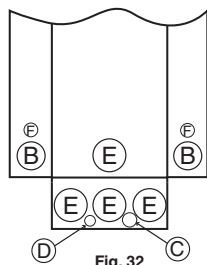

Fig. 32

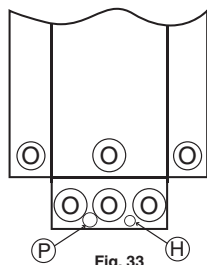

Fig. 33

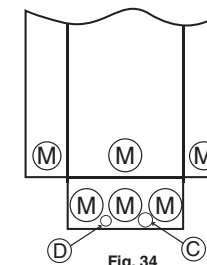

Fig. 34

Knockout Key

- | | |
|--------------------------------|------------------------------------|
| A = 1-1/2", 2", 2-1/2" | I = 1-1/4", 1-1/2", 2" |
| B = 1-1/4", 1-1/2", 2", 2-1/2" | J = 1/2", 3/4", 1", 1-1/4" |
| C = 1/2" | K = 1", 1-1/4", 1-1/2", 2", 2-1/2" |
| D = 5/16" | L = 2", 2-1/2", 3", 3-1/2" |
| E = 2", 2-1/2", 3" | M = 2", 2-1/2", 3", 3-1/2", 4" |
| F = 1/2", 3/4" | N = 1", 1-1/4", 1-1/2", 2" |
| G = 7/16" | O = 1/2", 3/4", 1", 1-1/4", 1-1/2" |
| H = 3/4" | |

* Knockouts shown for size not for exact positions.

Data subject to change without notice.

Transformer Rated Sockets

1-Phase, 20 Amps, 600V

FP&L Approved¹

Amps	Model Number	End Lug Size (CU/AL)	Side Lug Size (CU/AL)	Overhead/Underground Line Feed	Number of Terminals	Hub Type	Enclosure N3R	Certification
20	UASTH61C755GE	#14-2	#14-2	Top/Bottom	6	Small Hub Cover Plate	Aluminum	UL, FP&L
	USTH61C756MEP	#14-2	#14-2	Top/Bottom	6	Small Hub Cover Plate	Steel	
	UASTH131B757MEP	#14-2	#14-2	Top/Bottom	13	Small Hub Opening	Aluminum	
	USTH131C758MEP	#14-2	#14-2	Top/Bottom	13	Small Hub Cover Plate	Steel	

¹ Units come with a test switch (not pre-wired) and have a one piece ringless cover.

TECO Approved¹

Amps	Model Number	End Lug Size (CU/AL)	Side Lug Size (CU/AL)	Overhead/Underground Line Feed	Number of Terminals	Hub Type	Enclosure N3R	Certification
20	URSTH62B759MEP	#14-2	#14-2	Top/Bottom	6	Small Hub Opening	Steel	UL, TECO
	UARSTH62B760MEP	#14-2	#14-2	Top/Bottom	6	Small Hub Opening	Aluminum	
	URSTH132C761MEP	#14-2	#14-2	Top/Bottom	13	Small Hub Cover Plate	Steel	
	UARSTH132C762MEP	#14-2	#14-2	Top/Bottom	13	Small Hub Cover Plate	Aluminum	

¹ Units are pre-wired with test switch (per TECO specs) and have a two piece ring type cover.

Accessories

Model Number	Description
ARP00920MEP	Plastic Meter Socket Cover Plate

Hub Kits

Model Number	Description
ARP00003MEP	1" Hub Kit, Small
ARP00004MEP	1.25" Hub Kit, Small
ARP00005MEP	1.5" Hub Kit, Small
ARP00006MEP	2" Hub Kit, Small
ARP00007MEP	2.5" Hub Kit, Small



ARP00003MEP, ARP00004MEP, ARP00005MEP,
 ARP00006MEP, ARP00007MEP

Hub Cover Plates

Model Number	Description
ARP00002MEP	Small Steel Bolt-on Hub Cover Plate, 3-5/16" x 3-5/16"
ARP00008MEP	Small Aluminum Bolt-on Hub Cover Plate, 3-5/16" x 3-5/16"

Technical Data

Model Number	Gross Weight (lbs.)	Cabinet Dimensions (inches)			Std. Pkg.
		Height (A)	Width (B)	Depth (C)	
UASTH61C755GE	19	20	12	4-9/25	1
USTH61C756GE	26				
UASTH131B757GE	19				
USTH131C758GE	27				
URSTH62B759GE	23				
UARSTH62B760GE	19				
URSTH132C761GE	27				
UARSTH132C762GE	29				

Single Socket

Cabinet Dimensions

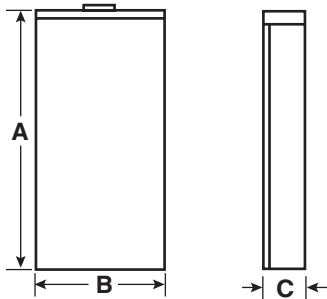

Knockout Configurations

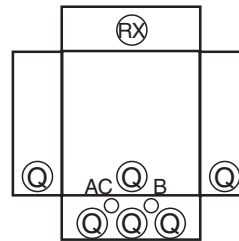

Knockout Key

- B = 1/2", 3/4"
- Q = 1", 1-1/4", 1-1/2"
- AC = 1/4", 1/2"
- RX = ø7.750 Hub OP

Section 3

Horizontal Meter Sockets



Application Information

Midwest's Horizontal Metering offers metering options for strip malls and small commercial buildings with 2 – 6 metering locations. Available in 100A – 200A. Has compact vertical footprint. Utility certifications available on selected models.



Features and Benefits

- Single phase
- Top / Bottom Feed
- Multiple hub opening and closure plate sizes available
- Hub opening in top endwall, requires use of a bolt-on hub or closing plate
- 1Ø, 600 Vac maximum
- Main lugs only

Rugged Durability

- NEMA 3R enclosure
- 2 through 6 meter positions, with and without horn or lever bypass

Installation Ease

- Overhead and underground service feeds
- End or center feed

User Safety

- Selected items are utility approved
- 10 kA short circuit rating (or higher with utility approval)



Horizontal Mtr Socket

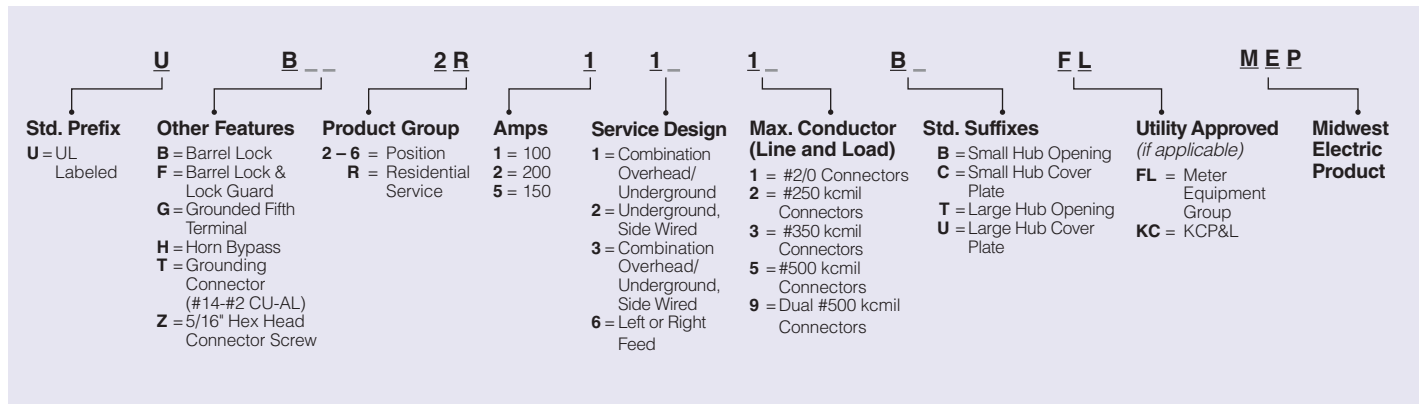

* Model numbers beginning with "10" or "MEP" will not follow the nomenclature.

Data subject to change without notice.

Two or Three Sockets

1-Phase, Top/Bottom Feed, 100 – 200 Amps

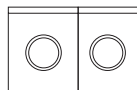

Fig. A
MEPKR2CS1ET

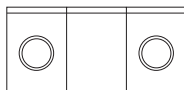

Fig. B
UBH2R1121BMEP, UT2R1121BMEP,
UT2R1121CFLMEP, UG2R5332CKCMEP,
UT2R5332BMEP, 1006737BMEP,
U2R2332UMEP, UBH2R2332TMEP,
UFHT2R2332TMEP, UHT2R2332TMEP,
UT2R2332TMEP, UT2R2332UFLMEP

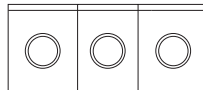

Fig. C
UT3R5632BMEP

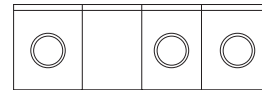

Fig. D
MEPKR3CS1ET, UBH3R1121BMEP, UT3R1121BMEP,
UT3R1121CFLMEP, UBH3R2332TMEP,
UFHT3R2332TMEP, UHT3R2332TMEP,
UT3R2332TMEP, UT3R2332UFLMEP

Horizontal Mtr Socket

Fig.	Model Number Ringless	Amps	Feed Type	Line Wire Range (CU/AL)	Ground Lug Size	Triplex Ground	Number of Terminals	Lever Bypass	Horned Bypass	Hub Type	Enclosure N3R	UL and Utility Approved
A	MEPKR2CS1ET	200	Center	#8-250MCM Load	#14-2	Y	4	N	N	Large Hub Cover Plate	G90 Steel	UL
B	UBH2R1121BMEP	100	Center	#6-250MCM Line #8-2/0 Load	No Ground	N	4	N	Y	Small Hub Opening	G90 Steel	UL
B	UT2R1121BMEP	100	Center	#6-250MCM Line #8-2/0 Load	#14-2	Y	4	N	N	Small Hub Opening	G90 Steel	UL, CMP
B	UTZ2R1121CFLMEP	100	Center	#6-350MCM Line #8-250MCM Load	#14-2	Y	4	N	N	Large Hub Cover Plate	G90 Steel	UL, MEG
B	UG2R5332CKCMEP	150	Center	#6-350MCM Line #8-250MCM Load	No Ground	N	5	N	N	Small Hub Cover Plate	G90 Steel	UL, KCP&L
B	UT2R5332BMEP	150	Center	#6-350MCM Line #8-250MCM Load	#14-2	Y	4	N	N	Small Hub Opening	G90 Steel	UL
B	1006737BMEP	200	Center	3/8" Stud Line-Max 350MCM ¹ #8-250 MCM Load	No Ground	N	4	N	N	Large Hub Cover Plate	G90 Steel	UL, DTE
B	U2R2332UMEP	200	Center	#6-350MCM Line #8-250MCM Load	No Ground	N	4	N	N	Large Hub Cover Plate	G90 Steel	UL
B	UBH2R2332TMEP	200	Center	#6-350MCM Line #8-250MCM Load	No Ground	N	4	N	Y	Large Hub Opening	G90 Steel	UL
B	UFHT2R2332TMEP	200	Center	#8-350MCM Line #8-250MCM Load	#14-2	Y	4	N	Y	Large Hub Opening	G90 Steel	UL, AEP
B	UHT2R2332TMEP	200	Center	#6-350MCM Line #8-250MCM Load	#14-2	Y	4	N	Y	Large Hub Opening	G90 Steel	UL
B	UT2R2332TMEP	200	Center	#6-350MCM Line #8-250MCM Load	#14-2	Y	4	N	N	Large Hub Opening	G90 Steel	UL, CMP
B	UT2R2332UFLMEP	200	Center	#6-350MCM Line #8-2/0 Load	#14-2	Y	4	N	N	Small Hub Cover Plate	G90 Steel	UL, MEG
C	UT3R5632BMEP	150	End	#6-350MCM Line #8-250MCM Load	#14-2	Y	4	N	N	Small Hub Opening, Small Hub Cover Plate	G90 Steel	UL
D	UBH3R1121BMEP	100	Center	#6-250MCM Line #8-2/0 Load	No Ground	N	4	N	Y	Small Hub Opening	G90 Steel	UL
D	UT3R1121BMEP	100	Center	#6-250MCM Line #8-2/0 Load	#14-2	Y	4	N	N	Small Hub Opening	G90 Steel	UL, CMP
D	UTZ3R1121CFLMEP	100	Center	#6-350MCM Line #8-250MCM Load	#14-2	Y	4	N	N	Large Hub Cover Plate	G90 Steel	UL, MEG
D	MEPKR3CS1ET	200	Center	#8-250MCM Load	#14-2	Y	4	N	N	Large Hub Cover Plate	G90 Steel	UL
D	UBH3R2332TMEP	200	Center	#6-350MCM Line #8-250MCM Load	No Ground	N	4	N	Y	Large Hub Opening	G90 Steel	UL
D	UFHT3R2332TMEP	200	Center	#6-350MCM Line #8-250MCM Load	#14-2	Y	4	N	Y	Large Hub Opening	G90 Steel	UL, AEP
D	UHT3R2332TMEP	200	Center	#6-350MCM Line #8-250MCM Load	#14-2	Y	4	N	Y	Large Hub Opening	G90 Steel	UL
D	UT3R2332TMEP	200	Center	#6-350MCM Line #8-250MCM Load	#14-2	Y	4	N	N	Large Hub Opening	G90 Steel	UL, CMP
D	UT3R2332UFLMEP	200	Center	#6-350MCM Line #8-2/0 Load	#14-2	Y	4	N	N	Small Hub Cover Plate	G90 Steel	UL, MEG

¹ Lugs not included. This product comes with studs only. Order lugs separately, see Accessories on page 3-5. One lug per kit, order appropriate QTY needed.
For example, order three lugs (A, C, N) if meter is 1-Phase or four lugs (A, B, C, N) if meter is 3-Phase.

Data subject to change without notice.

Section 3 – Horizontal Meter Sockets

Four, Five or Six Sockets

1-Phase, Top/Bottom Feed, 100 – 200 Amps

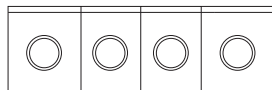

Fig. E
UT4R5632BMEP

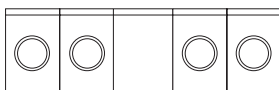

Fig. F
MEPKR4CS1ET, UT4R1121BMEP,
UTZ4R1121CFLMEP, UFHT4R2352TMEP,
UHT4R2352TMEP, UT4R2352TMEP,
UT4R2352UFLMEP

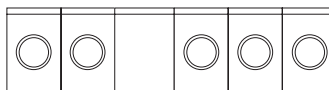

Fig. G
UT5R1121BMEP, UTZ5R1121CFLMEP,
MEPKR5CS1ET, UFHT5R2392TTMEP,
UT5R2392TTMEP, UT5R2392UFLMEP



Fig. H
UT6R1131BMEP, UTZ6R1131CFLMEP,
MEPKR6CS1ET, UFHT6R2392TTMEP,
UHT6R2392TTMEP, UT6R2392TTMEP,
UT6R2392UFLMEP

Fig.	Model Number Ringless	Amps	Feed Type	Line Wire Range (CU/AL)	Ground Lug Size	Triplex Ground	Number of Terminals	Lever Bypass	Horned Bypass	Hub Type	Enclosure N3R	UL and Utility Approved
E	UT4R5632BMEP	150	End	#6-350MCM Line #8-250MCM Load	#14-2	Y	4	N	N	Small Hub Opening, Small Hub Cover Plate	G90 Steel	UL
F	UT4R1121BMEP	100	Center	#6-250MCM Line #8-2/0 Load	#14-2	Y	4	N	N	Small Hub Opening	G90 Steel	UL, CMP
F	UTZ4R1121CFLMEP	100	Center	1/0-500MCM Line #8-250MCM Load	#14-1/0	Y	4	N	N	Large Hub Cover Plate	G90 Steel	UL, MEG
F	MEPKR4CS1ET	200	Center	#8-250MCM Load	#14-2	Y	4	N	N	Large Hub Cover Plate	G90 Steel	UL
F	UFHT4R2352TMEP	200	Center	1/0-500MCM Line #8-250MCM Load	#14-1/0	Y	4	N	Y	Large Hub Opening	G90 Steel	UL, AEP
F	UHT4R2352TMEP	200	Center	1/0-500MCM Line #8-250MCM Load	#14-2	Y	4	N	Y	Large Hub Opening	G90 Steel	UL
F	UT4R2352TMEP	200	Center	1/0 - 500MCM Line #8-250MCM Load	#14-1/0	Y	4	N	N	Large Hub Opening	G90 Steel	UL, CMP
F	UT4R2352UFLMEP	200	Center	#6-250MCM Line #8-2/0 Load	#14-2	Y	4	N	N	Small Hub Cover Plate	G90 Steel	UL, MEG
G	UT5R1121BMEP	100	Center	#6-250MCM Line #8-2/0 Load	#14-2	Y	4	N	N	Small Hub Opening	G90 Steel	UL, CMP
G	UTZ5R1121CFLMEP	100	Center	#6-250MCM Line #8-2/0 Load	#14-2/0	Y	4	N	N	(2) Large Hub Cover Plates	G90 Steel	UL, MEG
G	MEPKR5CS1ET	200	Center	1/0-500MCM Line #8-250MCM Load	#14-2/0	Y	4	N	N	(2) Large Hub Cover Plates	G90 Steel	UL
G	UFHT5R2392TTMEP	200	Center	1/0-500MCM Line #8-250MCM Load	#14-2/0	Y	4	N	Y	(2) Large Hub Openings	G90 Steel	UL, AEP
G	UT5R2392TTMEP	200	Center	1/0-500MCM Line #8-250MCM Load	#14-2/0	Y	4	N	N	(2) Large Hub Openings	G90 Steel	UL, CMP
G	UT5R2392UFLMEP	200	Center	1/0-500MCM Line #8-250MCM Load	#14-2	Y	4	N	N	Small Hub Cover Plate	G90 Steel	UL, MEG
H	UT6R1131BMEP	100	Center	#6-350MCM Line #8-2/0 Load	#14-2	Y	4	N	N	Small Hub Opening	G90 Steel	UL, CMP
H	UTZ6R1131CFLMEP	100	Center	1/0-500MCM Line #8-250MCM Load	#14-2/0	Y	4	N	N	(2) Large Hub Cover Plates	G90 Steel	UL, MEG
H	MEPKR6CS1ET	200	Center	1/0-500MCM Line #8-250MCM Load	#14-2/0	Y	4	N	N	(2) Large Hub Cover Plates	G90 Steel	UL
H	UFHT6R2392TTMEP	200	Center	1/0-500MCM Line #8-250MCM Load	#14-2/0	Y	4	N	Y	(2) Large Hub Openings	G90 Steel	UL, AEP
H	UHT6R2392TTMEP	200	Center	1/0-500MCM Line #8-250MCM Load	#14-2/0	Y	4	N	Y	(2) Large Hub Openings	G90 Steel	UL
H	UT6R2392TTMEP	200	Center	1/0-500MCM Line #8-250MCM Load	#14-2/0	Y	4	N	N	(2) Large Hub Openings	G90 Steel	UL, CMP
H	UT6R2392UFLMEP	200	Center	#6-350MCM Line #8-2/0 Load	#14-2	Y	4	N	N	Small Hub Cover Plate	G90 Steel	UL, MEG

Data subject to change without notice.

Accessories



ARP00003MEP, ARP00004MEP, ARP00005MEP,
ARP00006MEP, ARP00007MEP



ARP00017MEP, ARP00018MEP, ARP00019MEP,
ARP00020MEP, ARP00021MEP



ARP000035MEP

Model Number	Description
ARP00118MEP	One Lug for (2) #6 - 250MCM Cables/Phase
ARP00429MEP	One Lug for (1) #4-600M Cables/Phase or (2) 1/0-250 Cables/Phase
ARP00129MEP	Connector Kit #4-600MCM
ARP00326MEP	5th Terminal Kit Lever Bypass
ARP00035MEP	5th Terminal Kit Non-Lever Bypass
ARP00984MEP	Anti-Inversion Clip (10 per package)
ARP01590MEP	DTE Auxiliary Service Kit
1006630AMEP	Auxiliary Contacts Enclosure G90
ARP00920MEP	Plastic Meter Socket Cover Plate
ARP90015932MEP	2R1121 Wire Front Assembly

Hub Kits

Model Number	Description
ARP00003MEP	1" Hub Kit, Small
ARP00004MEP	1.25" Hub Kit, Small
ARP00005MEP	1.5" Hub Kit, Small
ARP00006MEP	2" Hub Kit, Small
ARP00007MEP	2.5" Hub Kit, Small
ARP00017MEP	2" Hub Kit, Large
ARP00018MEP	2.5" Hub Kit, Large
ARP00019MEP	3" Hub Kit, Large
ARP00020MEP	3.5" Hub Kit, Large
ARP00021MEP	4" Hub Kit, Large

Hub Cover Plates

Model Number	Description
ARP00002MEP	Small Steel Hub Cover Plate for 3.31" Hub Openings
ARP00008MEP	Small Aluminum Hub Cover Plate for 3.31" Hub Openings
ARP00015MEP	Adapter Plate for 5" to 3.31" Hub Openings
ARP00016MEP	Large Steel Hub Cover Plate for 5" Hub Openings
ARP00023MEP	Large Aluminum Hub Cover Plate for 5" Hub Openings

Data subject to change without notice.

Technical Data

Model Number Ringless	Gross Weight (lbs.)	Enclosure Style ¹	Cabinet Dimensions (inches)			Knockout Figure ²
			Height (A)	Width (B)	Depth (C)	
1006737BMEP	28.5	D	14-1/10	24-3/10	5-2/5	11
MEPKR2CS1ET	29	D	14-1/10	24-3/10	5-4/10	4
MEPKR3CS1ET	39	E	14-1/10	32-1/2	5-4/10	7
MEPKR4CS1ET	49	H	14-1/10	40-7/10	5-4/10	15
MEPKR5CS1ET	62	A	14-1/10	54-4/5	5-2/5	1
MEPKR6CS1ET	72	B	14-1/10	63	5-2/5	2
U2R2332UMEP	28	D	14-1/10	24-3/10	5-2/5	4
UBH2R1121BMEP	27	D	14-1/10	24-3/10	4-1/2	5
UBH2R2332TMEP	28	D	14-1/10	24-3/10	5-4/10	4
UBH3R1121BMEP	34	I	14-1/10	32-1/2	4.50	6
UBH3R2332TMEP	38	I	14-1/10	32-1/2	5-2/5	7
UFHT2R2332TMEP	30	B	14-1/10	24-3/10	5-2/5	4
UFHT3R2332TMEP	41	E	14-1/10	32-1/2	5-2/5	7
UFHT4R2352TMEP	52	H	14-1/10	40-7/10	5-2/5	12
UFHT5R2392TTMEP	67	A	14-1/10	54-4/5	5-2/5	1
UFHT6R2392TTMEP	78	B	14-1/10	83	5-2/5	2
UG2R5332CKCMEP	29	D	14-1/10	24-3/10	5-2/5	4
UHT2R2332TMEP	28.2	D	14-1/10	24-3/10	5-2/5	4
UHT3R2332TMEP	36	I	14-1/10	32-1/2	5-2/5	7
UHT4R2352TMEP	48	H	14-1/10	40-7/10	5-2/5	12
UHT6R2392TTMEP	74	B	14-1/10	63	5-2/5	1
UT2R1121BMEP	25	D	14-1/10	24-3/10	4-1/2	5
UT2R2332TMEP	29	D	14-1/10	24-3/10	5-2/5	4
UT2R2332UFLMEP	27	D	14-1/10	24-9/10	4-1/2	4
UT2R5332BMEP	13	D	14-1/10	24-3/10	5-2/5	4
UT3R1121BMEP	35	I	14-1/10	32-1/2	4-1/2	6
UT3R2332TMEP	39	I	14-1/10	32-1/2	5-2/5	7
UT3R2332UFLMEP	34	I	14-1/10	40-9/10	4-1/2	7
UT3R5632BMEP	30	F	14-1/10	32-3/10	5-2/5	8
UT4R1121BMEP	42	H	14-1/10	40-7/10	4-1/2	13
UT4R2352TMEP	49	H	14-1/10	40-7/10	5-2/5	12
UT4R2352UFLMEP	42	H	14-1/10	40-7/10	4-1/2	12
UT4R5632BMEP	40	G	14-1/10	40-1/2	5-2/5	9
UT5R1121BMEP	48	A	14-1/10	48-4/5	4-1/2	13
UT5R2392TTMEP	63	A	14-1/10	54-4/5	5-2/5	1
UT5R2392UUFLMEP	49	A	14-1/10	48-4/5	4-1/2	1
UT6R1131BMEP	55	B	14-1/10	57	4-1/2	10
UT6R2392TTMEP	72	B	14-1/10	63	5-2/5	1
UT6R2392UUFLMEP	56	B	14-1/10	57	4-1/2	2
UTZ2R1121CFLMEP	29	D	14-1/10	24-3/10	5-2/5	5
UTZ3R1121CFLMEP	39	E	14-1/10	33	5-2/5	6
UTZ4R1121CFLMEP	49	H	14-1/10	40-7/10	5-2/5	13
UTZ5R1121CFLMEP	63	A	14-1/10	54-4/5	5-2/5	14
UTZ6R1131CFLMEP	73	B	14-1/10	63	5-2/5	10

¹ Enclosure Styles on page 3-7.² Knockout Figures on pages 3-8–3-9.

Enclosure Styles / Cabinet Dimensions

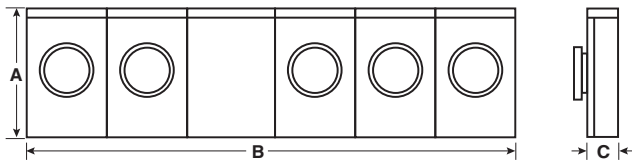

Fig. A

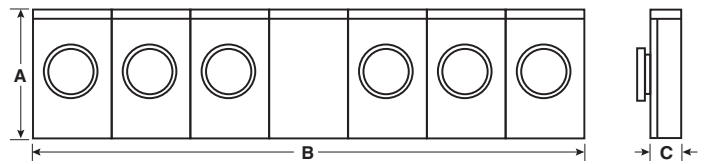

Fig. B

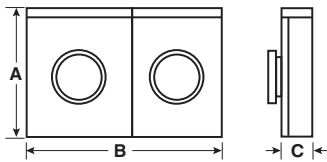

Fig. C

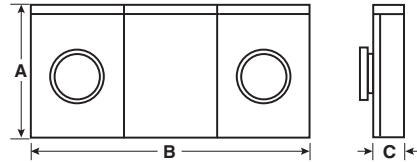

Fig. D

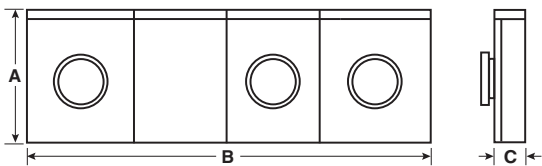

Fig. E

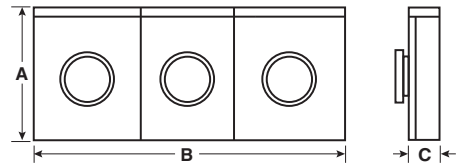

Fig. F

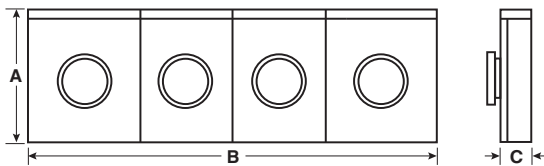

Fig. G

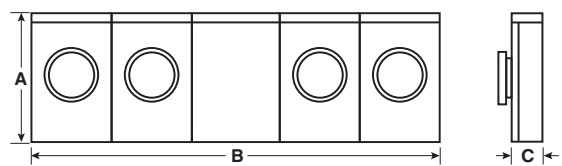

Fig. H

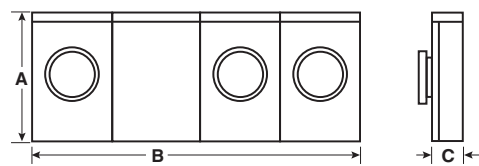

Fig. I

Horizontal Mtr Socket

Knockout Configurations

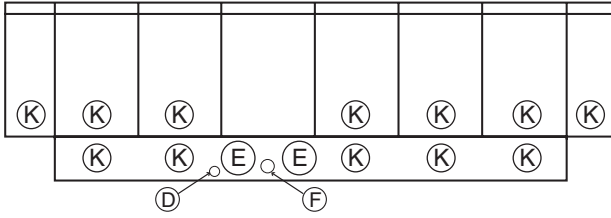

Fig. 1

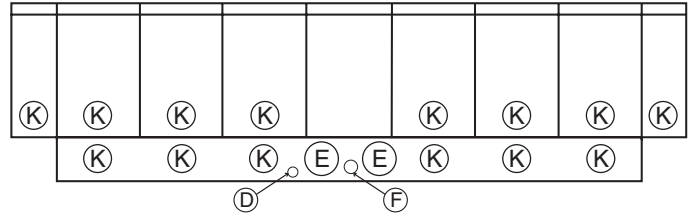

Fig. 2

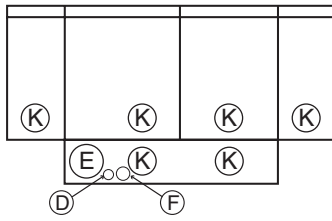

Fig. 3

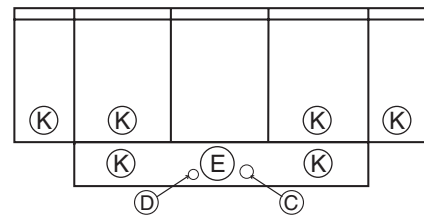

Fig. 4

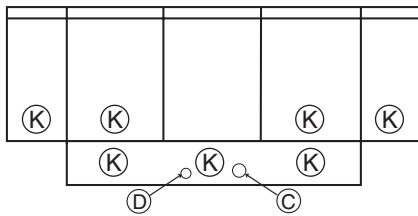

Fig. 5

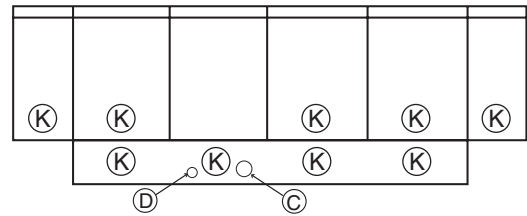

Fig. 6

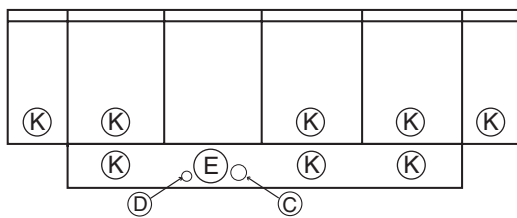

Fig. 7

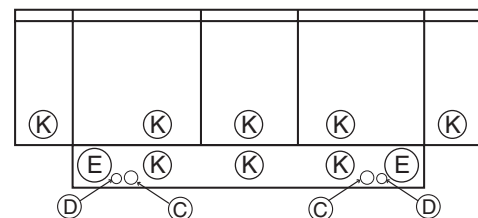

Fig. 8

Knockout Key

- C = 1/2"
- D = 5/16"
- E = 2", 2-1/2", 3"
- F = 1/2", 3/4"
- I = 1-1/4", 1-1/2", 2"
- J = 1/2", 3/4", 1", 1-1/4"
- K = 1", 1-1/4", 1-1/2", 2", 2-1/2"
- L = 2", 2-1/2", 3", 3-1/2"

* Knockouts shown for size not for exact positions.

Data subject to change without notice.

Knockout Configurations

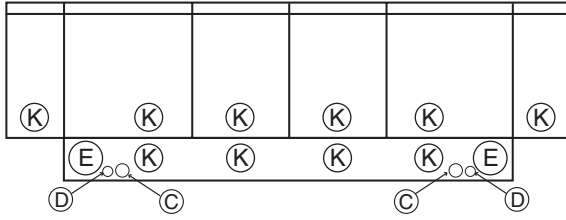

Fig. 9

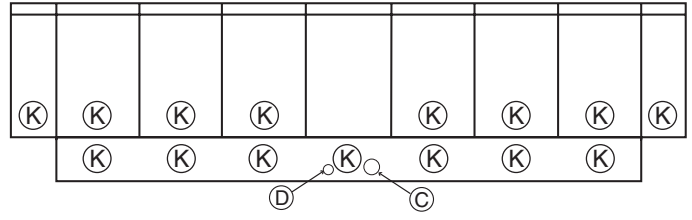

Fig. 10

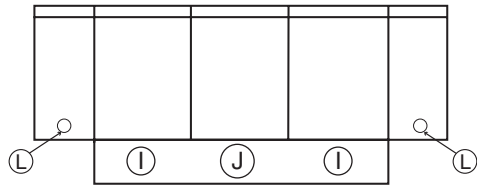

Fig. 11

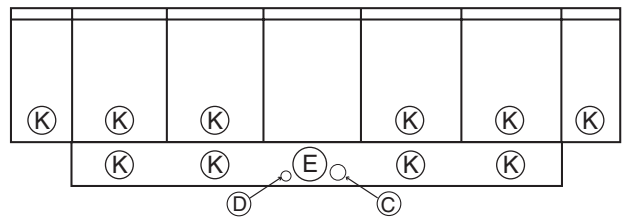

Fig. 12

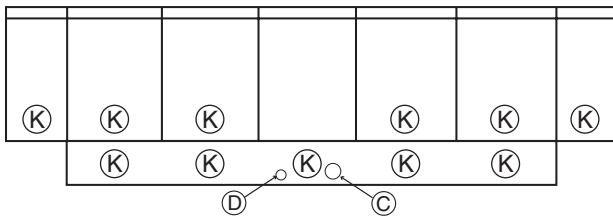

Fig. 13

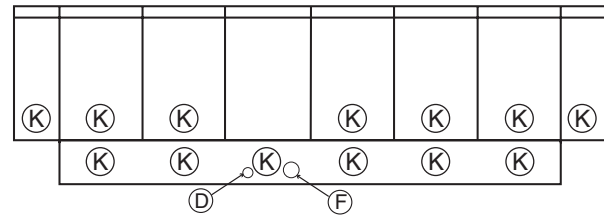

Fig. 14

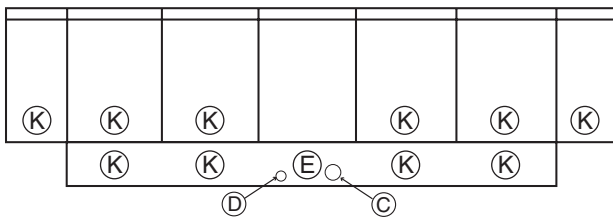

Fig. 15

Knockout Key

- C = 1/2"
- D = 5/16"
- E = 2", 2-1/2", 3"
- F = 1/2", 3/4"
- I = 1-1/4", 1-1/2", 2"
- J = 1/2", 3/4", 1", 1-1/4"
- K = 1", 1-1/4", 1-1/2", 2", 2-1/2"
- L = 2", 2-1/2", 3", 3-1/2"

Notes

Section 4

Load Centers / Circuit Breakers



Application Information

Midwest load centers lower your costs by making installation faster and easier, increasing application flexibility and reducing inventory requirements. At the same time, they deliver obvious and significant advances in design, function and quality.

Main lug load centers offer an economical solution for subpanels and similar applications. All main lug units 125A and above convert easily to main breaker units.



MLM4020CCU

Features and Benefits

Specifications

- UL Listed Panelboards No. 67
 - Service barriers included for factory installed main circuit breaker
- Suitable for use as service entrance equipment when installed in accordance with National Electrical Code
- 60°C/75°C Conductor Rating
- Single phase, 40-225A, 2-42 circuits
- Main breaker 22kAIC factory installed – standard
- Main lugs – factory installed
- All neutral holes rated for 14-4 wire
- Indoor and outdoor rated enclosures
- 100% rated split neutral on each side*

Flexibility – Most Model Numbers

- Main lug models field convertible to main breaker
- All load centers top or bottom feed
- Indoor fronts combination surface/flush
- Tie bar may be removed to split neutral/ground

Rugged Durability

- Sturdy copper bus
- Front packed in inner carton for added protection
- Copper bus with tin-plating standard
- Galvanized box

Installation Ease

- One-piece interior removes and reinstalls easily
- Split neutrals extend the full length of the interior for ease of wiring*
- Convertible models convert easily to main breaker
- Combination surface/flush front with spring-reinforced pan
- Combination slotted/Robertson square-drive screws on neutral,* ground, front and breaker lugs
- Field installable feed-through lugs up to 200A
- Straight-through main wiring
- Main breaker is clearly marked and circuit numbers are stamped on front
- Isolated ground bar is available
- Compact box maintains optimum wire-bending space



* 16 circuits and above.

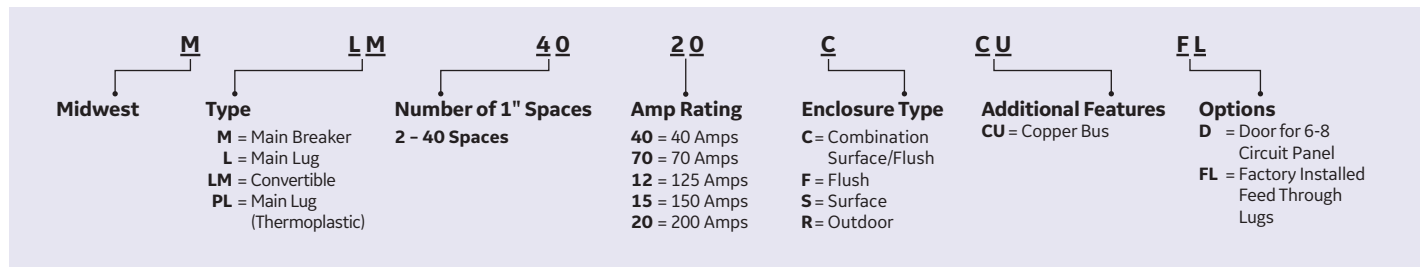

Data subject to change without notice.

Main Lugs

1-Phase, 40 – 125 Amps, 120/240VAC

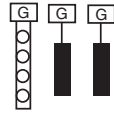

Fig. A
ML240SCU, RCU
ML270SCU, RCU

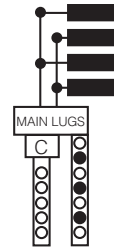

Fig. B
ML412C, MPL412R,
ML412R1

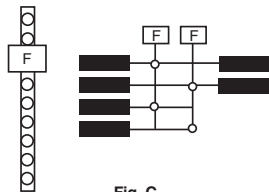

Fig. C
MLM612FCU, SCU, RCU

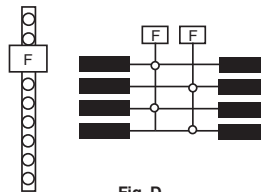

Fig. D
MLM812FCU, SCUD, RCU

Terminal Symbol	Wire Range (AWG/kcmil)	
	CU	AL
○	14-8	12-8
●	14-4	12-4
C	6-2/0	
F	6-1	
G	6-3	

Breaker Symbol	Breaker Fill	
	1" THQL	1/2" THQP
○	1	—
■	1	2

2/4/6/8 Circuits

Fig.	Model Number	Amps	1" Spaces		1/2" Spaces		Total 1 Pole Spaces	Main Wire Size (AWG/kcmil) Cu/Al	Equipment Ground Kit (order separately)	Enclosure Type	Material Type	Mounting Style	Feed	UL
			1 Pole	2 Pole	1 Pole	2 Pole								
A	ML240RCU ¹	40	2	1	4	1	4	14-4	MGK4	N3R	Metallic	—	Top	Y
A	ML240SCU ^{5,7}	40	2	1	4	1	4	14-4	MGK4	N1	Metallic	Surface	Top/Bottom	
A	ML270RCU ¹	70	2	1	4	1	4	6-3	MGK4	N3R	Metallic	—	Top	
A	ML270SCU ^{5,7}	70	2	1	4	1	4	6-3	MGK4	N1	Metallic	Surface	Top/Bottom	
B	ML412C ^{2,5,7}	125	4	2	8	3	8	1-2/0	MGL1	N1	Metallic	Combination Surface/Flush	Top/Bottom	
B	ML412R1 ^{1,2}	125	4	2	8	3	8	1-2/0	MGL1	N3R	Metallic	—	Top	
C	MLM612RCU ^{1,4}	125	4	3	12	4	12	6-1	MGK12	N3R	Metallic	—	Top	
B	MPL412R ^{1,2,3}	125	4	2	8	3	8	1-2/0	MGL1	N3R	Thermoplastic	—	Top	
C	MLM612FCU ^{4,5}	125	6	3	12	4	12	6-1	MGL2	N1	Metallic	Flush	Top/Bottom	
C	MLM612SCU ^{4,5}	125	6	3	12	4	12	6-1	MGL2	N1	Metallic	Surface	Top/Bottom	
D	MLM812FCUD ^{4,5}	125	8	4	16	8	16	6-1	MGL2	N1	Metallic	Flush	Top/Bottom	
D	MLM812RCU ^{1,4}	125	8	4	16	8	16	6-1	MGK12	N3R	Metallic	—	Top	
D	MLM812SCUD ^{4,5}	125	8	4	16	8	16	6-1	MGL2	N1	Metallic	Surface	Top/Bottom	

¹ 40-225 amp 1-Phase devices have removable closing caps. Larger ampere devices require field-cut openings. Order hubs separately.

² 10 kAIC.

³ 125 amp maximum branch capacity.

⁴ For main breaker, order MHQLRK2 retainer kit plus 2-pole circuit breaker. 100 amp maximum due to wire bending requirements.

⁵ Main and branch breakers are limited to 70 amps.

⁶ Load center includes a factory installed ground bar and add-a-lug. A separate MGL2 can be added in the unlikely event that another ground bar is required.

⁷ No door.

Main Lugs

1-Phase, 125 – 150 Amps, 120/240VAC

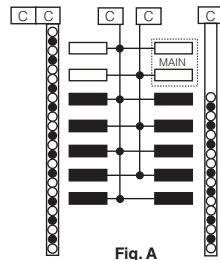

Fig. A
MLM1212CCU

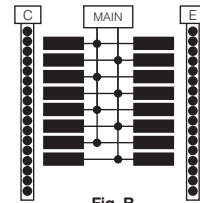

Fig. B
MLM1212RCU, MLM1612CCU

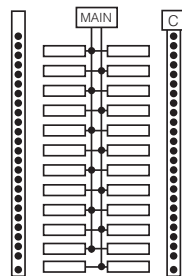

Fig. C
MLM2412CCU, MLM2412RCU

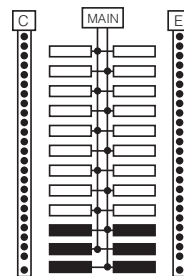

Fig. D
MLM2415RCU

Terminal Symbol	Wire Range (AWG/kcmil)	
	CU	AL
●	14-4	12-4
C	6-2/0	
E	1-300	

Breaker Symbol	Breaker Fill	
	1" THQL	1/2" THQP
□	1	—
■	1	2

14/16/24 Circuits

Fig.	Model Number	Amps	1" Spaces		1/2" Spaces		Total 1 Pole Spaces	Main Wire Size (AWG/kcmil) Cu/Al	Equipment Ground Kit	Enclosure Type	Material Type	Mounting Style	Feed	UL
			1 Pole	2 Pole	1 Pole	2 Pole								
A	MLM1212CCU ^{4,5}	125	14	6	20	8	24	6-2/0	Included	N1	Metallic	Combination Surface/Flush	Top/Bottom	Y
B	MLM1212RCU ^{1,4,6}	125	14	6	20	8	24	6-2/0	Included	N3R	Metallic	—	Top	
B	MLM1612CCU ²	125	16	8	16	6	24	6-2/0	MGK12, MGK24 ⁷	N1	Metallic	Combination Surface/Flush	Top/Bottom	
C	MLM2412CCU ²	125	24	12	—	—	24	6-2/0	MGK24, MGK32 ⁷	N1	Metallic	Combination Surface/Flush	Top/Bottom	
C	MLM2412RCU ^{1,2}	125	24	12	—	—	24	6-2/0	MGK24, MGK32 ⁷	N3R	Metallic	—	Top/Bottom	
D	MLM2415RCU ^{1,3}	150	24	12	12	4	30	1-3/0 (Cu), 2/0-3/0 (Al)	MGK24, MGK32 ⁷	N3R	Metallic	—	Top/Bottom	

¹ 40-225 amp 1-Phase devices have removable closing caps. Larger ampere devices require field-cut openings. Order hubs separately.

² For main breaker, order MQMH000 plus 2-pole THQL or THHQL circuit breakers.

³ For main breaker, order THQMVXXXD circuit breaker. See page 4-12.

⁴ For main breaker applications, use reverse feed THQL or THHQL circuit breakers plus MHQLRK3 breaker retainer kit.

⁵ Main and branch breakers are limited to 70 amps.

⁶ Load center includes a factory installed ground bar and add-a-lug. A separate MGL2 can be added in the unlikely event that another ground bar is required.

⁷ Order separately.

Main Lugs

1-Phase, 200 Amps, 120/240VAC

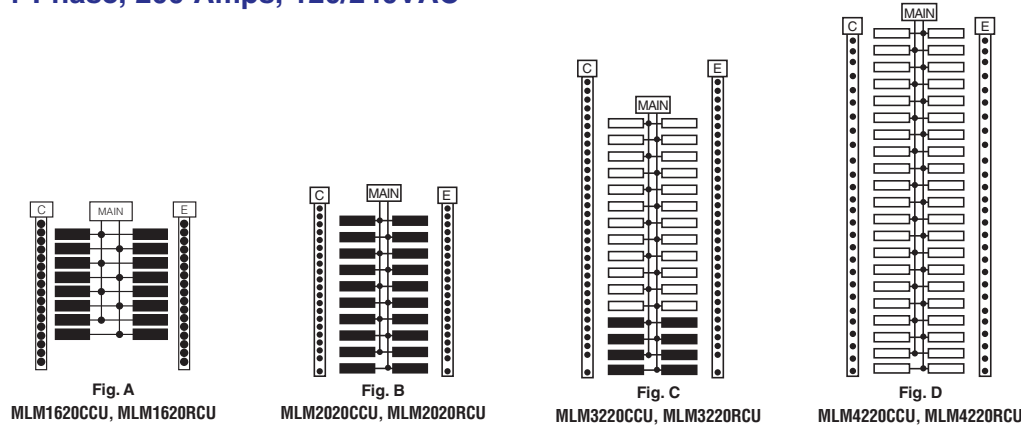

Terminal Symbol	Wire Range (AWG/kcmil)	
	CU	AL
●	14-4	12-4
C	6-2/0	
E	1-300	

Breaker Symbol	Breaker Fill	
	1" THQL	1/2" THQP
□	1	—
■	1	2

16/20/32/40 Circuits

Fig.	Model Number	Amps	1" Spaces		1/2" Spaces		Total 1 Pole Spaces	Main Wire Size (AWG/kcmil) Cu/Al	Equipment Ground Kit (order separately)	Enclosure Type	Material Type	Mounting Style	Feed	UL
			1 Pole	2 Pole	1 Pole	2 Pole								
A	MLM1620CCU ²	200	16	8	32	14	32	6-250	MGK32	N1	Metallic	Combination Surface/Flush	Top/Bottom	Y
A	MLM1620RCU ^{1,2}	200	16	8	32	14	32	6-250	MGK32	N3R	Metallic	—	Top	
B	MLM2020CCU ²	200	20	10	40	18	40	6-250	MGK32	N1	Metallic	Combination Surface/Flush	Top/Bottom	
B	MLM2020RCU ^{1,3}	200	20	10	40	18	40	6-250	MGK24, MGK42	N3R	Metallic	—	Top	
C	MLM3220CCU ²	200	32	16	16	6	40	6-250	MGK32	N1	Metallic	Combination Surface/Flush	Top/Bottom	
C	MLM3220RCU ^{1,2}	200	32	16	16	6	40	1-250 (Cu), 2/0-250 (Al)	MGK32	N3R	Metallic	—	Top/Bottom	
D	MLM4020CCU ²	200	40	20	—	—	40	6-250	MGK42	N1	Metallic	Surface/Flush	Top/Bottom	
D	MLM4020RCU ^{1,2}	200	40	20	—	—	40	6-250	MGK42	N3R	Metallic	—	Top/Bottom	

¹ 40-225 amp 1-Phase devices have removable closing caps. Larger ampere devices require field-cut openings. Order hubs separately.
² For main breaker, order THQMXXXX circuit breaker. See page 4-12.

Main Breaker

1-Phase, 200 Amps, 120/240VAC

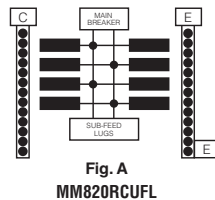

Terminal Symbol	Wire Range (AWG/kcmil)	
	CU	AL
●	14-4	12-4
C	6-2/0	
E	1-300	

Breaker Symbol	Breaker Fill	
	1" THQL	1/2" THQP
□	1	—
■	1	2

2/4/6/8 Circuits

Fig.	Model Number	Amps	1" Spaces		1/2" Spaces		Total 1 Pole Spaces	Main Wire Size (AWG/kcmil) Cu/Al	Equipment Ground Kit (order separately)	Enclosure Type	Material Type	Mounting Style	Feed	UL
			1 Pole	2 Pole	1 Pole	2 Pole								
A	MM820RCUFL ¹	200	8	4	16	6	16	1-250 (Cu), 2/0-250 (Al)	MGK32	N3R	Metallic	—	Top	Y

¹ 40-225 amp 1-Phase devices have removable closing caps. Larger ampere devices require field-cut openings. Order hubs separately.

Technical Data

Model Number	Weight (lbs.)	Dimensions (inches)			Knockout Figure ¹
		Height	Width	Depth	
ML240RCU	6-4/5	10	7-1/4	3-3/4	6
ML240SCU	4-3/10	10-1/4	5-11/16	3-3/8	1
ML270RCU	6-3/4	10	7-1/4	3-3/4	6
ML270SCU	4-1/2	10-1/4	5-11/16	3-3/8	1
ML412C	5-2/5	9	7-1/4	3	2
ML412R1	7-1/10	10	7-1/4	3-3/4	6
MLM1212CCU	14-9/10	16	14	3-3/8	8
MLM1212RCU	20-1/2	21-1/2	13	5	10
MLM1612CCU	19-1/2	19	14	3-3/4	9
MLM1620CCU	25-1/10	24-11/16	14	3-3/4	9
MLM1620RCU	27-3/5	29	13	5	10
MLM2020CCU	27	26-7/16	14	3-3/4	9
MLM2020RCU	29-1/2	33	13	5	10
MLM2412CCU	24-1/2	24-11/16	14	3-3/4	9
MLM2412RCU	22	30-3/16	14-11/16	5-1/4	10
MLM2415RCU	26	33	13	5	10
MLM3220CCU	33-1/2	33-3/16	14	3-3/4	9
MLM3220RCU	33-1/2	34-3/16	14-11/16	5-1/4	11
MLM4020CCU	37	39-3/16	14	3-3/4	9
MLM4020RCU	60	43-1/4	14-21/32	6-13/32	12
MLM612FCU	8-1/2	11-3/8	11-9/16	3-3/8	3
MLM612RCU	10	11-1/8	11-1/4	3-1/4	7
MLM612SCU	9-1/4	11-3/8	11-9/16	3-3/8	3
MLM812FCUD	9	11-3/8	11-9/16	3-3/8	3
MLM812RCU	10	11-1/8	11-1/4	3-1/4	7
MLM812SCUD	9	11-3/8	11-9/16	3-3/8	3
MM820RCUFL	28	28-11/16	12-1/2	4-5/8	5
MPL412R	2-1/2	9-7/32	7-1/2	3-5/16	4

¹ Knockout Figures on page 4-7.

Knockout Configurations

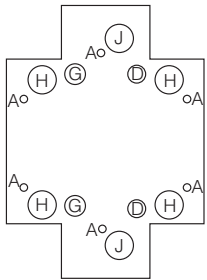

Fig. 1

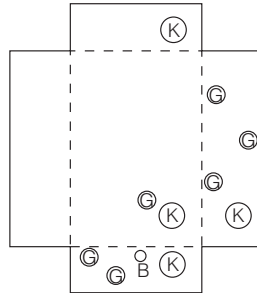

Fig. 2

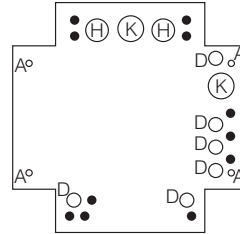

Fig. 3

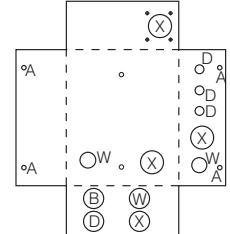

Fig. 4

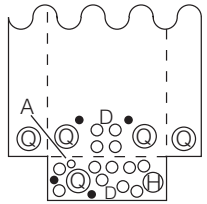

Fig. 5

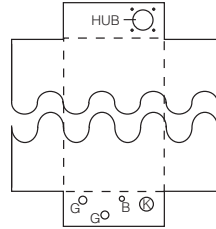

Fig. 6

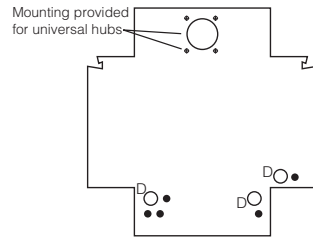

Fig. 7

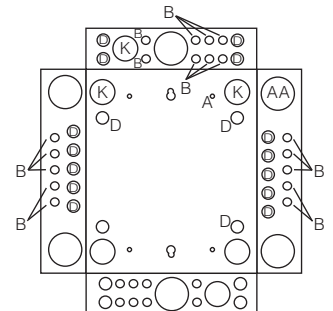

Fig. 8

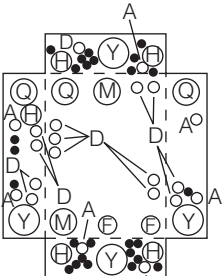

Fig. 9

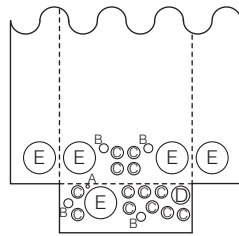

Fig. 10

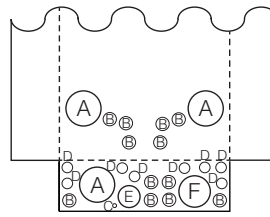

Fig. 11

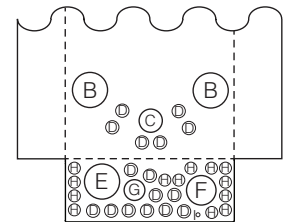

Fig. 12

Knockout Key

- A = 5/16
- = 3/8, 1/2
- B = 1/2
- C = 3/8, 1/2, 3/4
- D = 1/2, 3/4
- E = 3/4
- F = 1/2, 3/4, 1, 1-1/4, 1-1/2
- G = 1/2, 3/4, 1
- H = 1/2, 3/4, 1, 1-1/4

- I = 9/32
- J = 3/4, 1, 1-1/4
- K = 3/4, 1, 1-1/4, 1-1/2
- M = 1, 1-1/4, 1-1/2, 2
- Q = 1, 1-1/2, 2, 2-1/2
- W = 3/4, 1
- X = 1-1/4, 1-1/2
- Y = 1, 1-1/4, 1-1/2, 2, 2-1/2
- AA = 2-1/2, 3, 3-1/2, 4

* Knockouts shown for size not for exact positions.

Data subject to change without notice.

Accessories

Equipment Ground Kits

Model Number	Wire Range (AWG/kcmil)
MGL1	(4) 14-8Cu/12-8AL (3) 14-4CU/6-4Al
MGL2 ¹	(8) 14-8Cu/12-8AL (6) 14-4CU/6-4Al
MGL8 ¹	(7) 14-8Cu/12-8AL, (3) 14-4CU/6-4AL, (2) 14-4CU/12-4Al, (1) 14-2Cu/Al
MGL20 ²	(1) 6-2/0Cu/Al Number of Terminals, Equipment Ground Kits
MNG3	(3) 10-1/0Cu/Al Number of Terminals for 400 and 600 Amp
MNG6	(6) 10-1/0Cu/Al Number of Terminals for 400 and 600 Amp

¹ MGL2 and MGL8 mount interchangeably.

² Add-on Equipment Ground Lug (for use on any MGL Kit).



MGL2



MGL20 Combined with MGL1

Equipment Ground and Isolated Ground Kits¹

Model Number	Description
MGK4	4-hole Ground
MGK12	12-hole Ground
MGK24	24-hole Ground
MGK32	32-hole Ground
MGK42	42-hole Ground

¹ Add TGK8 for isolated ground and mount to ground kit.



MGK12

Neutral Kits

Model Number	Wire Range	Description
MNLK20	6-2/0	Mounted on top of neutral only
MNLK250		



MNLK20

Neutral/Ground Kits

Mounted on any neutral or ground position by removing the termination screw

Model Number	Wire Range	Description
MLK20	6-2/0	Neutral/Ground Lug Kit
MLK250	6-250	
MLK300	6-300	



MLK20



MLK250

Isolated Ground Bar Equipment Ground Kits

Model Number	Description
MGKIS	Isolated Ground Bar Kit (order with MGK Equipment Ground Kits)
MGKIS2	Isolated Ground Bar Feet (order with TGK8)



MGK12 with MGKIS

Subfeed Lug Kits

Model Number	Description
MHLK2125	125A 2 Pole Plug-in
MHLK2150	150A 2 Pole Plug-in
MHLK2200	200A 2 Pole Plug-in



MHLK2125

Accessories

Raintight (Bolt-on) Hubs

Threaded

Hub Opening (inches)	Midwest Hub Number	Universal Hub Number	Std. Pkg.
3/4	B07	—	10
1	B10	—	
1-1/4	B12	—	
1-1/2	B15	—	
2	B20	U27	
2-1/2	B25	U28	
3	—	U30	1
3-1/2	—	U35	
4	—	U40	
Closure Plate ¹	B01	U04	10

¹ Closure Plate is standard with most Midwest products.



Service Barrier Kits

Model Number	Description
M2100SB	THQL21100 Service Barrier
M2200LSB	BJ2200/BJ22150 Lug Service Barrier Kit – one barrier included for each pole
M2201SB	TQD22200 Service Barrier
M2201SBP	TQD22200 Service Barrier Plug
M2201SBR	TQD22200 Service Barrier 100-125A Reducer
MBSB	MSLC Bus Service Barrier
MHQLRK	MB Retainer and Service Barrier Kit
MHQLRK1	MB Retainer and Service Barrier Kit
MHQLRK2	MB Retainer and Service Barrier Kit
MHQLRK3	MB Retainer and Service Barrier Kit
MHQLRK4	MB Retainer and Service Barrier Kit
MHQMVSBF	Service Barrier Flapper
MLSB	MSLC Lug Service Barrier
MLSB2P	MSLC Service Barrier 2P Module
MLSBF	MSLC Service Barrier Lug Bus Filler
MLSBR	MSLC Lug Service Barrier Reverse Feed
MLSBS	MSLC Lug Service Barrier Shutter
MSB	2/4 Sockets Service Barrier



M2200LSB



MHQMVSBF



MBSB



MLSB



MHQLRK



MLSB2P



MHQLRK1



MLSBF



MHQLRK2



MLSBR



MHQLRK3



MLSBS



MHQLRK4

Application Information

We offer a full line of GE circuit interrupters which includes Dual Function (DFCI), Ground Fault (GFI), Combination Arc Fault (AFCI), 1" and 1/2" breaker to meet all of your electrical installation needs.

The Dual Function (DFCI), Ground Fault (GFI) and Combination Arc Fault (AFCI) Circuit Interrupter features cutting edge technology and offers ground fault and arc fault circuit interruption in one unit. It meets the recent NEC requirements for use on kitchen and laundry room circuits. The Combination Arc Fault (AFCI) circuit interrupters allow sharing of neutrals that help to eliminate the need to run a second neutral cable. The Ground Fault with Self-Test (GFT) includes functionality required by UL which automatically runs diagnostic testing on a periodic basis.



THQL2140



THQL1120AF2



THQL1115DF



THQL2120GFT

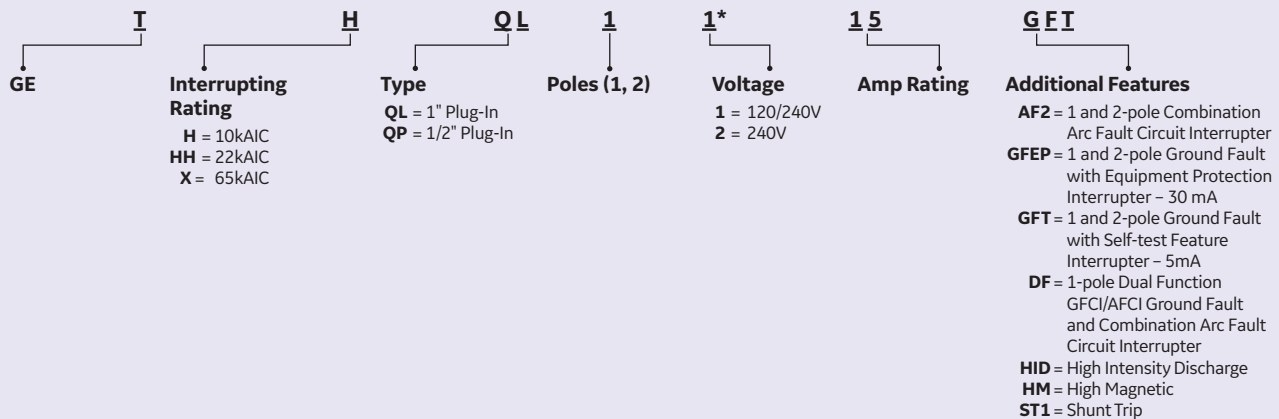

* Omit character for THQP breakers, which are all 120/240V.

Q-Line Plug-in

- UL Listed Molded Case Circuit Breakers No. 489
- Federal Government Specification Qualified WC-375B
- 60°C/75°C Conductor Rating
- Quick make, quick break
- Box type terminals



THQP130



THQP230



THQL1120



THQL2140

One Pole / Two Pole, 15 – 125 Amps, 120/240VAC

Amps	10,000 AIC		22,000 AIC	65,000 AIC	UL
	Model Number		Model Number	Model Number	
	1/2" Module	1" Module	1" Module	1" Module	
One Pole¹					
15 ²	THQP115	THQL1115	THHQL1115	TXQL1115	Y
20 ²	THQP120	THQL1120	THHQL1120	TXQL1120	
25	THQP125	THQL1125	THHQL1125	TXQL1125	
30	THQP130	THQL1130	THHQL1130	TXQL1130	
35	THQP135	THQL1135	THHQL1135	—	
40	THQP140	THQL1140	THHQL1140	—	
45	THQP145	THQL1145	THHQL1145	—	
50	THQP150	THQL1150	THHQL1150	—	
Two Pole³ (Incorporates Internal Common Trip Bar)					
15	THQP215	THQL2115	THHQL2115	TXQL2115	Y
20	THQP220	THQL2120	THHQL2120	TXQL2120	
25	THQP225	THQL2125	THHQL2125	TXQL2125	
30	THQP230	THQL2130	THHQL2130	TXQL2130	
35	THQP235	THQL2135	THHQL2135	—	
40	THQP240	THQL2140	THHQL2140	—	
45	THQP245	THQL2145	THHQL2145	—	
50	THQP250	THQL2150	THHQL2150	—	
60	—	THQL2160	THHQL2160	—	
70	—	THQL2170	THHQL2170	—	
80	—	THQL2180	THHQL2180	—	
90	—	THQL2190	THHQL2190	—	
100	—	THQL21100	THHQL21100	—	
110	—	THQL21110	THHQL21110	—	
125	—	THQL21125	THHQL21125	—	

Circuit Interrupters Wire Size

Breaker Type	Amps	Wire Range (AWG/kcmil ¹)	
		Copper	Aluminum
THQP	15-25	14-8	14-8
	30-50	8-4	8-4
THQL, THHQL, TXQL	15-30	14-8	14-8
	35-60	8-3	8-3
	70-100	6-1/0	6-1/0
	110-125	2-2/0	2-2/0

¹ Solid or stranded for 14-10 AWG.

¹ UL Listed as HACR (heating, air conditioning and refrigeration).

² UL Listed as SWD (switching duty). Suitable for 120V AC fluorescent lighting loads

³ 15 - 100 amp, UL Listed as HACR (heating, air conditioning and refrigeration).

Data subject to change without notice.

Main Breaker Kits

For Use with 125 Amp Load Centers

Amps	Model Number	Lug Wire Size (AWG/kcmil) Cu/Al	UL
—	MQMH000 ¹	—	Y

¹ Order breaker separately. See Main Breaker table below.



100 – 225 Amps

Amps	Model Number ²	Lug Wire Size (AWG/kcmil) Cu/Al	UL
100	THQMV100D	1-300 (Cu), 2/0-300 (Al)	Y
125	THQMV125D		
150	THQMV150D		
175	THQMV175D		
200	THQMV200D		
225	THQMV225D		

² Includes a breaker and mounting base.

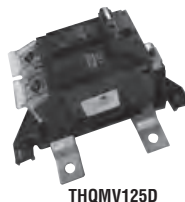

Main Breakers

Two Pole^{1,2}, 15 – 125 Amps, 120/240VAC

Amps	10,000 AIC	22,000 AIC	UL
	Model Number	Model Number	
	1" Module	1" Module	
15	THQL2115	THHQL2115	Y
20	THQL2120	THHQL2120	
25	THQL2125	THHQL2125	
30	THQL2130	THHQL2130	
35	THQL2135	THHQL2135	
40	THQL2140	THHQL2140	
45	THQL2145	THHQL2145	
50	THQL2150	THHQL2150	
60	THQL2160	THHQL2160	
70	THQL2170	THHQL2170	
80	THQL2180	THHQL2180	
90	THQL2190	THHQL2190	
100	THQL21100	THHQL21100	
110	THQL21110	THHQL21110	
125	THQL21125	THHQL21125	

¹ 15 - 100 amp, UL Listed as HACR (heating, air conditioning and refrigeration).

² Incorporates internal common trip bar.



Arc Fault

- UL Listed Molded Case Circuit Breakers No. 489
- UL Listed Arc Fault Circuit Interrupters No. 1699

One Pole^{1,2}, 10 – 20 Amps, 120/240VAC

Amps	10,000 AIC	22,000 AIC	UL
	Model Number	Model Number	
10	THQL1115AF2	THHQL1115AF2	Y
20	THQL1120AF2	THHQL1120AF2	



THQL1120AF2

¹ Combination AFCI compliant with 2008 NEC and later requirements.

² For two pole shared neutral applications, use (2) one pole circuit breakers with a handle tie.

Dual Function GFCI/AFCI Ground Fault and Combination Arc Fault Circuit Breaker

- UL Listed Molded Case Circuit Breakers No. 489
- UL Listed Arc Fault Circuit Interrupters No. 1699
- UL Listed Ground Fault Circuit Interrupters No. 943 ed5 (5 milliamperes)

One Pole, 15 – 20 Amps, 120VAC

Amps	10,000 AIC	22,000 AIC	UL
	Model Number	Model Number	
15	THQL1115DF	THHQL1115DF	Y
20	THQL1120DF	THHQL1120DF	



THQL1115DF

Ground Fault with Self-Test Feature

- UL Listed Ground Fault Circuit Interrupters No. 943 ed5 (5 milliamperes)

One Pole / Two Pole¹, 15 – 50 Amps, 120VAC or 120/240VAC

Amps	10,000 AIC		22,000 AIC	UL
	Model Number		Model Number	
	One Pole – 120VAC	Two Pole – 120/240VAC	One Pole – 120VAC	
15	THQL1115GFT	THQL2115GFT	THHQL1115GFT	cUL ^{us}
20	THQL1120GFT	THQL2120GFT	THHQL1120GFT	
25	THQL1125GFT	THQL2125GFT	THHQL1125GFT	
30	THQL1130GFT	THQL2130GFT	THHQL1130GFT	
40	—	THQL2140GFT ¹	—	
50	—	THQL2150GFT ¹	—	



THQL2120GFT

¹ UL and CSA.

Ground Fault with Equipment Protection

- UL Listed Ground Fault Circuit Interrupters No. 943 (30 milliamperes ground fault trip level)

One Pole / Two Pole¹, 15 – 30 Amps, 120VAC or 120/240VAC

Amps	10,000 AIC		UL
	Model Number		
	One Pole – 120VAC	Two Pole – 120/240VAC	
15	THQL1115GFEP	THQL2115GFEP	cUL ^{us}
20	THQL1120GFEP	THQL2120GFEP	
30	THQL1130GFEP	THQL2130GFEP	



THQL2115GFEP

HID Lighting

- UL Listed as HID
- HID breakers are designed to handle the current and voltage spikes that result when gaseous discharge lamps, including fluorescent and HID, are switched on and off

One Pole / Two Pole, 15 – 30 Amps, 120VAC or 120/240VAC

Amps	10,000 AIC		22,000 AIC		UL
	Model Number		Model Number		
	One Pole – 120VAC	Two Pole – 120/240VAC	One Pole – 120VAC	Two Pole – 120/240VAC	
15	THQL1115HID	THQL2115HID	THHQL1115HID ¹	THHQL2115HID	Y
20	THQL1120HID	THQL2120HID	THHQL1120HID ¹	THHQL2120HID	
30	THQL1130HID	THQL2130HID	THHQL1130HID	THHQL2130HID	



THQL2120HID

¹ UL Listed as SWD (switching duty). Suitable for 120 volts ac fluorescent lighting loads.

High Magnetic

- UL Listed Molded Case Circuit Breakers No. 489
- High short circuit rating suitable for circuits with inherent high in-rush load currents

One Pole, 15 – 50 Amps, 120VAC

Amps	10,000 AIC	UL
	Model Number	
15	THQL1115HM	Y
20	THQL1120HM	
25	THQL1125HM	
30	THQL1130HM	
40	THQL1140HM	
50	THQL1150HM	



THQL1140HM

THQL with Factory Installed Shunt

- UL Listed Molded Case Circuit Breakers No. 489
- Shunt trip requires one additional pole of space

One Pole / Two Pole, 15 – 100 Amps, 120/240VAC or 240VAC

Amps	10,000 AIC		UL
	Model Number ¹		
	One Pole – 120/240VAC	Two Pole ² – 240VAC	
15	THQL1115ST1	THQL2115ST1	Y
20	THQL1120ST1	THQL2120ST1	
30	THQL1130ST1	THQL2130ST1	
35	THQL1135ST1	THQL2135ST1	
40	THQL1140ST1	THQL2140ST1	
45	THQL1145ST1	THQL2145ST1	
50	THQL1150ST1	THQL2150ST1	
60	—	THQL2160ST1	
70	—	THQL2170ST1	
80	—	THQL2180ST1	
90	—	THQL2190ST1	
100	—	THQL21100ST1	



THQL2150ST1

¹ Solid or stranded for 14-10 AWG.

² Internal common trip.

Data subject to change without notice.

Section 5

Spa Panels



Application Information

GFI disconnects provide a convenient, low-cost means, to satisfy National Electric Code requirements for a GFI disconnect for spas, hot tubs, water heaters and swimming pools. The NEMA 3R design insures a safe, weather-tight installation. All units come fully assembled and factory wired. Midwest is your best choice for quality outdoor disconnects.

Features and Benefits

- Extra circuit breaker spaces allow for future expansion
- Fully assembled unit saves costly installation time
- NEMA 3R weatherproof enclosures
- G90 galvanized steel construction for superior corrosion protection
- Durable polyester powder coat finish resists chipping and fading
- 125A rating
- All terminals accept copper or aluminum wire for installation flexibility
- Includes both overcurrent and ground fault protection
- Overhead hub opening
- Padlock provision to prevent unauthorized access

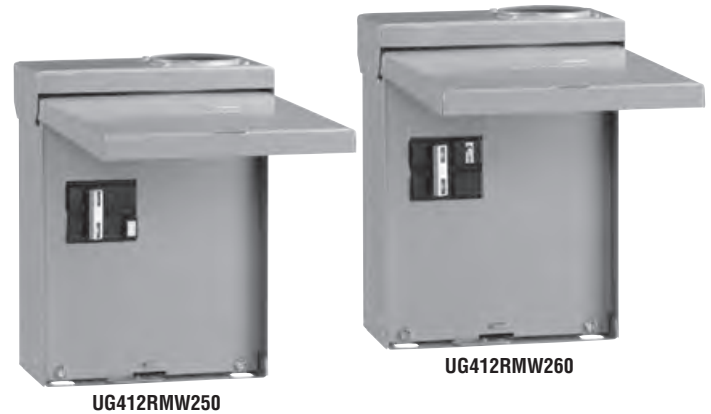

GFI Disconnect

125 Amps, 120/240V

Fig.	Model Number ¹	Extra Breaker Spaces	GFI Protection (Amps)	Amps	Hub Opening	Lug Wire Size Cu/Al	UL
A	UG412RMW250	2 or 4	50	125	Y	6-2/0	Y
B	UG412RMW260		60				

¹ Unit includes appropriate GFI Breaker.

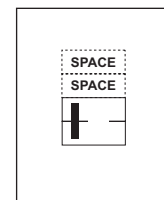

Fig. A
UG412RMW250

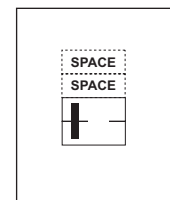
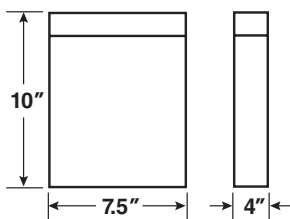
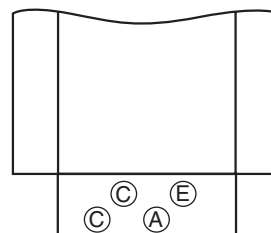

Fig. B
UG412RMW260

Cabinet Dimensions



Knockout Configurations



Knockout Key

- A = 1/2"
- C = 1/2", 3/4", 1"
- E = 3/4", 1-1/4", 1-1/2"

* Knockouts shown for size not for exact positions.

Section 6

Safety Switches



Application Information

General Duty

General Duty (Type MG) switches are designed for residential and light commercial applications where duty is not severe. The maximum voltage is 240 Vac / 250 Vdc. All General Duty safety switches are UL and CUL listed (UL98 Enclosed Switches) and meet NEMA Enclosed Safety Switch Standard KS1-2013, meet Federal Specification WS-865C and are also Seismic Certified.

Heavy Duty

Heavy Duty (Type MH) switches are designed for commercial and industrial applications where safety and superior reliability are essential. The maximum voltage is 600 Vac / 250 Vdc. Our Heavy Duty switches provide superior endurance performance, and when used with Class R or J fuses, 30-200A switches have a UL listed short-circuit rating of 200kAIC. They are UL listed as service equipment when installed in accordance with the National Electric Code. All Heavy Duty safety switches are UL and cUL listed (UL98 Enclosed Switches) and meet NEMA Enclosed Safety Switch Standard KS1-2013, meet Federal Specification WS-865C and are also Seismic Certified.

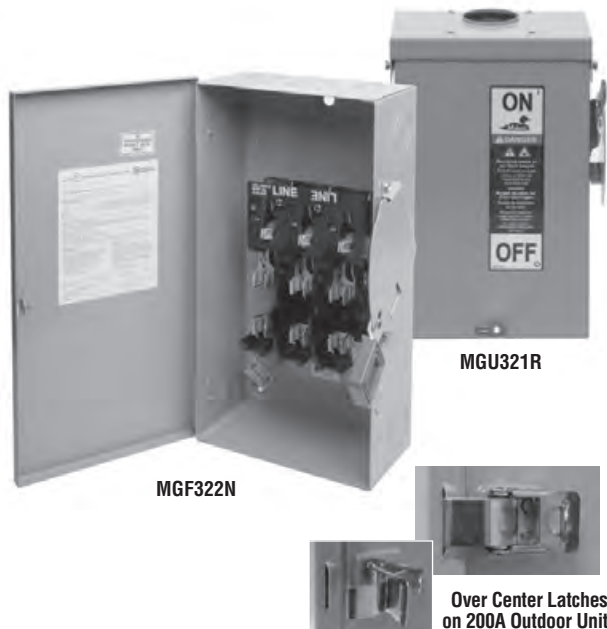

Features and Benefits

Flexibility

- 30-200 Amps
- NEMA Type 1 or NEMA Type 3R enclosures
- Fusible or Non-fusible
- 240 Vac / 250 Vdc or 600 Vac / 250 Vdc
- 2 pole or 3 pole
- Horsepower rated

User Safety

- Highly visible ON-OFF label
- Our General Duty switch features a highly visible, easy to grip red handle that accepts one padlock in the OFF position.
- The Heavy Duty switch features an upgraded “donut” handle ideal for hook stick operation and accepts three padlocks in the OFF position
- Direct-drive, quick-make, quick-break mechanism “snaps” the contacts open and closed, providing positive ON-OFF indication
- Our General Duty switch has an integral cover interlock
- The Heavy Duty switch has coin-proof, defeatable interlock
- Visible confirmation of plated blade contact positions
- Spring reinforced fuse clips assure reliable contact for cool operation
- Suitable for Class H, K, J or R fuses, where applicable

Installation Ease

- Wide, unobstructed gutter
- Self-leveling three-point mounting pattern

Rugged Durability

- NEMA Type 1 enclosures – powder coat painted steel
- NEMA Type 3R enclosures – powder coat painted galvanized steel

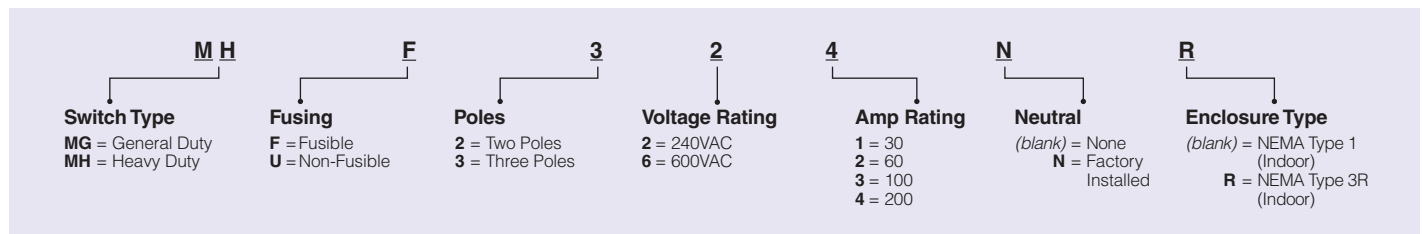

Data subject to change without notice.

General Duty

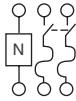

Fig. A
MGF221N, MGF222N, MGF223N,
MGF224N, MGF221NR, MGF222NR,
MGF223NR, MGF224NR
2 pole, 3 wire

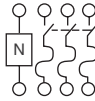

Fig. B
MGF321N, MGF322N, MGF323N,
MGF324N, MGF321NR, MGF322NR,
MGF323NR, MGF324NR
3 pole, 4 wire



Fig. C
MGU321, MGU322, MGU323,
MGU324, MGU321R, MGU322R,
MGU323R, MGU324R
3 pole, 3 wire

Fusible, Two Pole / Three Pole, 30 – 200 Amps, 240V

Fig.	Model Number		Amps	Horsepower Rating					Unit Wt.	Std Pkg.	UL
	NEMA Type 1 Indoor	NEMA Type 3 Outdoor ¹		Single Phase, 240 Vac		Three Phase, 240 Vac		DC (Vdc)			
				Standard Fuse	Time Delay Fuse	Standard Fuse	Time Delay Fuse	250			
Two pole, 50/60 Hz											
A	MGF221N	MGF221NR	30	1-1/2	3	—	—	5	6	1	cULus
	MGF222N	MGF222NR	60	3	10	—	—	10	11		
	MGF223N	MGF223NR	100	7-1/2	15	—	—	20	17		
	MGF224N	MGF224NR	200	15	15	—	—	—	32		
Three pole, 50/60 Hz											
B	MGF321N	MGF321NR	30	1-1/2	3	3	7-1/2	5	6	1	cULus
	MGF322N	MGF322NR	60	3	10	7-1/2	15	10	11		
	MGF323N	MGF323NR	100	7-1/2	15	15	30	20	17		
	MGF324N	MGF324NR	200	15	15	25	50	—	32		

Non-Fusible, Three Pole, 30 – 200 Amps, 240V

Fig.	Model Number		Amps	Horsepower Rating			Unit Wt.	Std Pkg.	UL	
	NEMA Type 1 Indoor	NEMA Type 3 Outdoor ¹		Single Phase, 240 Vac	Three Phase, 240 Vac					DC (Vdc)
				Standard Fuse	Standard Fuse					250
Three pole, 50/60 Hz										
C	MGU321	MGU321R	30	3	7-1/2		5	6	1	cULus
	MGU322 ²	MGU322R ²	60	10	15		10	10		
	MGU323 ²	MGU323R ²	100	15	30		20	13		
	MGU324	MGU324R	200	15	50		—	30		

General Duty safety switches are not suitable for use as service equipment in Canada.

¹ 30, 60 and 100A General Duty outdoor switches feature a flip-top door style. 200A General Duty outdoor switches feature a side swing door style.

² Not suitable for use as service equipment. Solid neutral not available.

Short Circuit Ratings

Fusible / Non-Fusible, 30 – 200 Amps

Maximum System Voltage	Amps	Safety Switch Type	UL Listed Fusing		Enclosure Type
			Class	Withstand Rating (rms Sym Amps)	
240 Vac 250 Vdc	30-200	Fusible	K	10,000	N1 N3R
			H	10,000	
			R	100,000	
240 Vac 250 Vdc	30-200	Non-fusible ³	No Upstream Protection	10,000	N1 N3R
			K Upstream	10,000	
			H Upstream	10,000	
			R Upstream	100,000	

³ Non-fusible switch withstand ratings apply when protected by corresponding listed fuse type.

Lug Wire Sizes

Line and Load Terminals

Amps	Wire Range (AWG/kcmil)	
	Copper	Aluminum
30A (250V)	14-8	12-8
30A (600V)	12-2	12-2
60A (600V)	12-2	12-2
100A (600V)	10-1/0	10-1/0
200A (600V)	2-250	2-250

Heavy Duty



Fig. A
MHF221N, MHF222N, MHF223N,
MHF224N, MHF221NR, MHF222NR,
MHF223NR, MHF224NR
2 pole, 3 wire

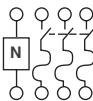

Fig. B
MHF321N, MHF322N, MHF323N,
MHF324N, MHF321NR, MHF322NR,
MHF323NR, MHF324NR
3 pole, 4 wire



Fig. C
MHF361, MHF362, MHF363,
MHF364, MHF361R, MHF362R,
MHF363R, MHF364R
3 pole, 3 wire



Fig. D
MHU361, MHU362, MHU363,
MHU364, MHU361R, MHU362R,
MHU363R, MHU364R
3 pole, 3 wire

Fusible, Two Pole / Three Pole, 30 – 200 Amps, 240V

Fig.	Model Number		Amps	Horsepower Rating					Unit Wt.	Std Pkg.	UL
	NEMA Type 1 Indoor	NEMA Type 3 Outdoor ¹		Single Phase, 240 Vac		Three Phase, 240 Vac		DC (Vdc)			
				Standard Fuse	Time Delay Fuse	Standard Fuse	Time Delay Fuse	250			
Two pole, 50/60 Hz											
A	MHF221N	MHF221NR	30	1-1/2	3	—	—	5	7	1	cULus
	MHF222N	MHF222NR	60	3	10	—	—	10	16		
	MHF223N	MHF223NR	100	7-1/2	15	—	—	20	18		
	MHF224N	MHF224NR	200	15	—	—	—	40	34		
Three pole, 50/60 Hz											
B	MHF321N	MHF321NR	30	1-1/2	3	3	7-1/2	5	7	1	cULus
	MHF322N	MHF322NR	60	3	10	7-1/2	15	10	16		
	MHF323N	MHF323NR	100	7-1/2	15	15	30	20	18		
	MHF324N	MHF324NR	200	15	—	25	60	40	34		

Fusible, Three Pole, 30 – 200 Amps, 600V

Fig.	Model Number		Amps	Horsepower Rating								Unit Wt.	Std Pkg.	UL		
	NEMA Type 1 Indoor	NEMA Type 3 Outdoor ¹		Single Phase, 480 Vac		Single Phase, 600 Vac		Three Phase, 480 Vac		Three Phase, 600 Vac					DC (Vdc)	DC (Vdc)
				Standard Fuse	Time Delay Fuse	Standard Fuse	Time Delay Fuse	Standard Fuse	Time Delay Fuse	Standard Fuse	Time Delay Fuse				125	250
Three pole, 50/60 Hz																
C	MHF361	MHF361R	30	3	7-1/2	3	10	5	15	7-1/2	20	—	5	11	1	cULus
	MHF362	MHF362R	60	5	20	10	25	15	30	15	50	5	10	18		
	MHF363	MHF363R	100	10	30	15	40	25	60	30	75	—	20	19		
	MHF364	MHF364R	200	25	50	30	50	50	125	60	150	—	40	33		

Non-Fusible, Three Pole, 30 – 200 Amps, 600V

Fig.	Model Number		Amps	Horsepower Rating				Unit Wt.	Std Pkg.	UL	
	NEMA Type 1 Indoor	NEMA Type 3R Outdoor ¹		Single Phase, Vac		Three Phase, Vac					DC (Vdc)
				Standard Fuse	Standard Fuse	Standard Fuse	Standard Fuse				
Three pole, 50/60 Hz											
D	MHU361 ²	MHU361R	30	7-1/2	10	20	30	5	11	1	cULus
	MHU362	MHU362R	60	20	25	50	60	10	18		
	MHU363	MHU363R	100	30	40	75	100	20	19		
	MHU364	MHU364R	200	50	50	125	150	40	33		

¹ 30, 60 and 100A Heavy Duty outdoor switches feature a flip-top door style. 200A Heavy Duty outdoor switches feature a side swing door style.

² Available in 240V, compact enclosure – order MHU321.

Short Circuit Ratings

Fusible / Non-Fusible, 30 – 200 Amps

Maximum System Voltage	Amps	Safety Switch Type	UL Listed Fusing		Enclosure Type
			Class	Withstand Rating (rms Sym Amps)	
600 Vac 600 Vdc	30-200	Fusible	H	10,000	N1 N3R
			R	200,000 ⁴	
			J	200,000 ⁴	
600 Vac 600 Vdc	30-200	Non-fusible ³	No Upstream Protection	10,000	N1 N3R
			H Upstream	10,000	
			R Upstream	200,000 ⁴	

³ Non-fusible switch withstand ratings apply when protected by corresponding listed fuse type.

⁴ Unless otherwise noted on the enclosure.

Safety Switch Accessories

Equipment Ground Kits

Model Number	Amps	Wire Range (AWG/kcmil)		Std Pkg.
		Copper	Aluminum	
MGL2	30	(4) 14-8, (3) 14-4	(4) 12-8, (3) 6-4	20
	60			
MGL4	100	(3) 10-1/0	(3) 10-1/0	1
	200			



Neutral Kit Insulated, Groundable and Bondable

Model Number	Amps	System Volts (Vac)	Fusible / Non-fusible	Wire Range (AWG/kcmil)		Std Pkg.
				Copper	Aluminum	
MNK1	30	600	Either	14-8	12-8	1
MNK2 ¹	30		Either	12-2	12-2	
	60		Non-fusible	12-2	12-2	
MNK2A	60		Fusible	12-2	12-2	
MNK3	100		Non-fusible	10-1/0	10-1/0	
MNK3A ¹	100		Fusible	10-1/0	10-1/0	
MNK4A	200		Either	2-250	2-250	



¹ Not suitable for type MG switches.
 Switching Neutral: order standard switch of required number of poles and use dummy fuse in neutral pole.

Auxiliary Contact Kits

Model Number	Switch Prefix	Amps	System Voltage	Contacts	Contact Ratings	Std Pkg.
MAUX61S	MH	30	240	1NO/1NC	15A, 600 Vac 0.50A, 125 Vac 0.25A, 250 Vac	1
MAUX21D			240	2NO/2NC	10A, 125/250 Vac 0.30A, 125 Vac 0.15A, 250 Vac	
MAUX64D			600	2NO/2NC	15A, 600 Vac 0.50A, 125 Vac 0.25A, 250 Vac	
		60-200	240-600			



Designed to open before switch blades. UL listed for field installation.

Class R Fuse Kits

Switch Prefix	Amps	Volts	Model Number
MG	30	240	MGR12
	60		MGR22
	100/200		MGR42
MH	30	240	MHR12
	30	600	MHR16
	60	240	MHR22
	60	600	MHR26
	100/200	600	MHR46



Raintight (Bolt-on) Hub

See page 14-3.



Accessory Selection Tables

General Duty Safety Switches

Model Number		Neutral Kit Accessory/ Replacement Part	Ground Lug Kit	Class R Fuse Kit
NEMA Type 1	NEMA Type 3R			
MGF221N	MGF221NR	Factory Installed Replacement = MNK1	MGL2	MGR12
MGF222N	MGF222NR	Factory Installed Replacement = MNK2A	MGL2	MGR22
MGF223N	MGF223NR	Factory Installed	MGL4	MGR42
MGF224N	MGF224NR	Factory Installed Replacement = MNK4A	MGL4	MGR42
MGF321N	MGF321NR	Factory Installed Replacement = MNK1	MGL2	MGR12
MGF322N	MGF322NR	Factory Installed	MGL2	MGR22
MGF323N	MGF323NR	Factory Installed	MGL4	MGR42
MGF324N	MGF324NR	Factory Installed Replacement = MNK4A	MGL4	MGR42
MGU321	MGU321R	—	MGL2	—
MGU322	MGU322R	—	MGL2	—
MGU323	MGU323R	MNK3	MGL4	—
MGU324	MGU324R	—	MGL4	—

Heavy Duty Safety Switches

Model Number		Neutral Kit Accessory/ Replacement Part	Ground Lug Kit	Class R Fuse Kit	Auxiliary Contact Kits	
NEMA Type 1	NEMA Type 3R				(1NO / 1NC)	(2NO / 2NC)
MHF221N	MHF221NR	Factory Installed Replacement = MNK1	MGL2	MHR12	MAUX61S	MAUX21D
MHF222N	MHF222NR	Factory Installed	MGL2	MHR22	—	MAUX64D
MHF223N	MHF223NR	Factory Installed	MGL4	MHR46	—	MAUX64D
MHF224N	MHF224NR	Factory Installed Replacement = MNK4A	MGL4	MHR46	—	MAUX64D
MHF361	MHF361R	MNK2 or MNK3	MGL2	MHR16	MAUX61S	MAUX21D
MHF362	MHF362R	MNK2A or MNK3A	MGL2	MHR26	—	MAUX64D
MHF363	MHF363R	MNK3A	MGL4	MHR46	—	MAUX64D
MHF364	MHF364R	MNK4A	MGL4	MHR46	—	MAUX64D
MHF321N	MHF321NR	Factory Installed Replacement = MNK1	MGL2	MHR12	MAUX61S	MAUX21D
MHF322N	MHF322NR	Factory Installed	MGL2	MHR22	—	MAUX64D
MHF323N	MHF323NR	Factory Installed	MGL4	MHR46	—	MAUX64D
MHF324N	MHF324NR	Factory Installed Replacement = MNK4A	MGL4	MHR46	—	MAUX64D
MHU361	MHU361R	MNK2 or MNK3	MGL2	—	MAUX61S	MAUX21D
MHU362	MHU362R	MNK2 or MNK3	MGL2	—	—	MAUX64D
MHU363	MHU363R	MNK3	MGL4	—	—	MAUX64D
MHU364	MHU364R	MNK4A	MGL4	—	—	MAUX64D

Technical Data

General Duty Safety Switches

Model Number	Enclosure Style ¹	Cabinet Dimensions (inches)					Knockout Figure ²
		Height (A)	Width (B)	Width (C)	Depth (D)	Depth (E)	
MGF221N	A	10-3/10	6-9/10	6-2/5	6-3/10	3-3/10	1
MGF221NR	B	9-4/5	6-4/5	6-2/5	6-3/10	3-3/10	4
MGF222N	A	13-4/5	8-9/10	8-2/5	7-9/10	4	7
MGF222NR	B	13-7/10	8-4/5	8-2/5	7-9/10	3-9/10	8
MGF223N	A	21-3/10	10-3/5	9-2/5	9-9/10	4-9/10	2
MGF223NR	B	21-1/10	10-3/10	9-3/10	9-1/10	5	5
MGF224N	A	29-1/10	14-3/5	13-2/5	9-3/10	5-1/5	3
MGF224NR	C	28-4/5	14-3/10	13-2/5	8-9/10	5-3/10	9
MGF321N	A	10-3/10	6-9/10	6-2/5	6-3/10	3-3/10	1
MGF321NR	B	9-4/5	6-4/5	6-2/5	6-3/10	3-3/10	4
MGF322N	A	13-4/5	8-9/10	8-2/5	7-9/10	4	7
MGF322NR	B	13-7/10	8-4/5	8-2/5	7-9/10	3-9/10	8
MGF323N	A	21-3/10	10-3/5	9-2/5	9-9/10	4-9/10	2
MGF323NR	B	21-1/10	10-3/10	9-3/10	9-1/10	5	5
MGF324N	A	29-1/10	14-3/5	13-2/5	9-3/10	5-1/5	3
MGF324NR	C	28-4/5	14-3/10	13-2/5	8-9/10	5-3/10	9
MGU321	A	10-3/10	6-9/10	6-2/5	6-3/10	3-3/10	1
MGU321R	B	9-4/5	6-4/5	6-2/5	6-3/10	3-3/10	4
MGU322	A	13-4/5	8-9/10	8-2/5	7-9/10	4	7
MGU322R	B	13-7/10	8-4/5	8-2/5	7-9/10	3-9/10	8
MGU323	A	21-3/10	10-3/5	9-2/5	9-9/10	4-9/10	2
MGU323R	B	15-3/4	10-3/10	9-3/10	9-1/10	5	5
MGU324	A	29-1/10	14-3/5	13-2/5	9-3/10	5-1/5	3
MGU324R	C	28-4/5	14-3/10	13-2/5	8-9/10	5-3/10	9

¹ Enclosure Styles shown below.

² Knockout Figures on page 6-9.

Enclosure Styles / Cabinet Dimensions

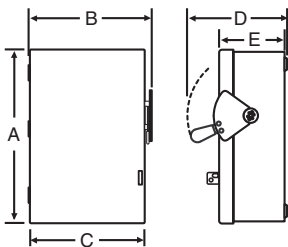

Fig. A
 General Duty - NEMA Type 1

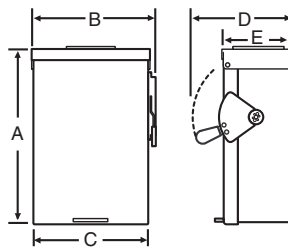

Fig. B
 General Duty - NEMA Type 3R, 30 through 100A

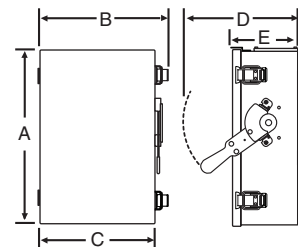

Fig. C
 General Duty - NEMA Type 3R Side Swing, 200A

Technical Data

Heavy Duty Safety Switches

Model Number	Enclosure Style ¹	Cabinet Dimensions (inches)					Knockout Figure ²
		Height (A)	Width (B)	Width (C)	Depth (D)	Depth (E)	
MHF221N	A	10-3/10	7-1/10	6-3/10	6-1/10	3-3/10	1
MHF221NR	B	10-1/2	6-3/5	6-1/5	7-7/10	3-1/10	4
MHF222N	A	17-3/5	10-1/10	9-2/5	9	5	2
MHF222NR	B	17-1/5	9-7/10	9-1/5	7-9/10	4-4/5	5
MHF223N	A	21-3/10	10-1/10	9-3/10	9-4/5	4-4/5	2
MHF223NR	B	22-1/10	10-1/5	9-3/10	9-4/5	4-9/10	5
MHF224N	A	31-1/2	14-1/10	13-3/10	10-1/2	5-1/10	3
MHF224NR	C	31-3/10	14-1/5	13-2/5	9-1/2	5-1/10	9
MHF321N	A	10-3/10	7-1/10	6-3/10	6-1/10	3-3/10	1
MHF321NR	B	10-1/2	6-3/5	6-1/5	7-7/10	3-1/10	4
MHF322N	A	17-3/5	10-1/10	9-2/5	9	5	2
MHF322NR	B	17-1/5	9-7/10	9-1/5	7-9/10	4-4/5	5
MHF323N	A	21-3/10	10-1/10	9-3/10	9-4/5	4-4/5	2
MHF323NR	B	22-1/10	10-1/5	9-3/10	9-4/5	4-9/10	5
MHF324N	A	31-1/2	14-1/10	13-3/10	10-1/2	5-1/10	3
MHF324NR	C	31-3/10	14-1/5	13-2/5	9-1/2	5-1/10	9
MHF361	A	12-3/5	9-1/2	8-3/10	7-3/5	4	7
MHF361R	B	13-1/10	8-9/10	8-1/5	7-9/10	4	8
MHF362	A	21-3/10	9-2/5	9-1/10	8-3/5	5	2
MHF362R	B	22	9-7/10	9-1/5	7-9/10	4-4/5	5
MHF363	A	22-3/10	10-1/10	9-3/10	9-4/5	4-4/5	6
MHF363R	B	22-1/10	10-1/5	9-3/10	9-4/5	4-9/10	5
MHF364	A	31-1/2	14-1/10	13-3/10	10-1/2	5-1/10	3
MHF364R	C	31-3/10	14-1/5	13-2/5	9-1/2	5-1/10	9
MHU361	A	10-3/10	9-3/10	8-3/10	7-7/10	4	7
MHU361R	B	13-1/10	8-9/10	8-1/5	7-9/10	4	8
MHU362	A	17-3/5	10-1/10	9-2/5	9	5	2
MHU362R	B	17-1/5	9-7/10	9-1/5	7-9/10	4-4/5	5
MHU363	A	17-3/5	10-1/10	9-3/10	9-4/5	4-4/5	2
MHU363R	B	17-3/10	10-1/5	9-3/10	9-4/5	4-9/10	5
MHU364	A	31-1/2	14-1/10	13-3/10	10-1/2	5-1/10	3
MHU364R	C	31-3/10	14-1/5	13-2/5	9-1/2	5-1/10	9

¹ Enclosure Styles shown below.

² Knockout Figures on page 6-9.

Enclosure Styles / Cabinet Dimensions

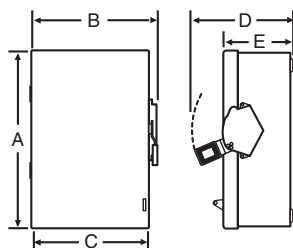

Fig. A
 Heavy Duty - NEMA Type 1

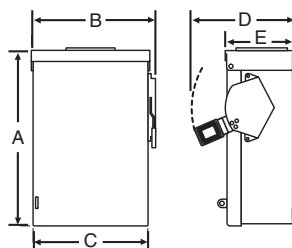

Fig. B
 Heavy Duty - NEMA Type 3R, 30 through 100A

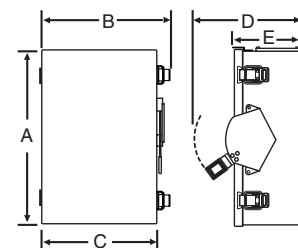

Fig. C
 Heavy Duty - NEMA Type 3R Side Swing, 200A

Data subject to change without notice.

Safety Switches

Knockout Configurations

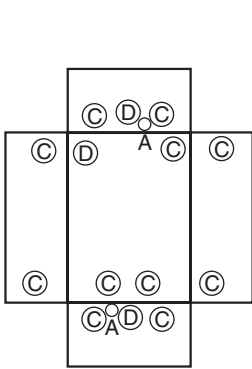

Fig. 1

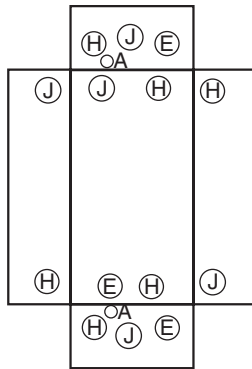

Fig. 2

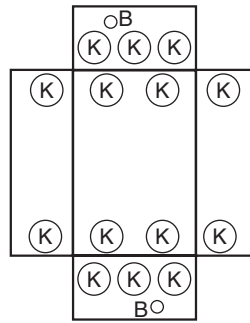

Fig. 3

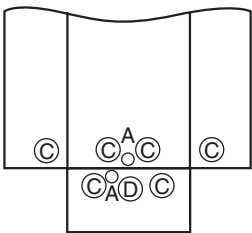

Fig. 4

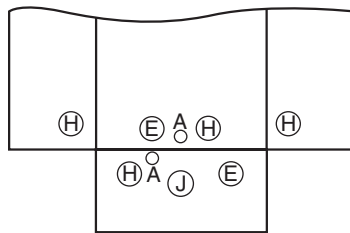

Fig. 5

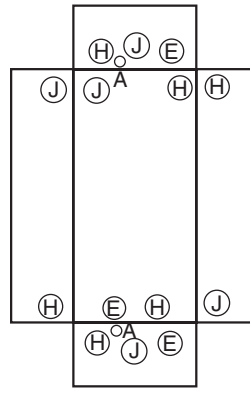

Fig. 6

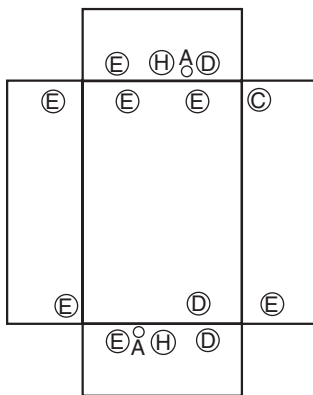

Fig. 7

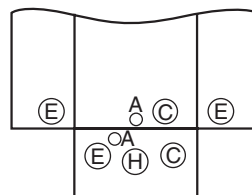

Fig. 8

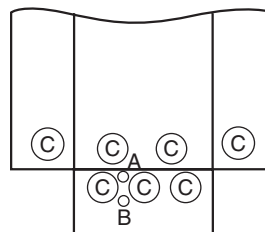

Fig. 9

Knockout Key

- A = 9/32"
- B = 1/2"
- C = 1/2", 3/4"
- D = 1/2", 3/4", 1"
- E = 1/2", 3/4", 1", 1-1/4"
- H = 3/4", 1", 1-1/4", 1-1/2"
- J = 1", 1-1/4", 1-1/2", 2"
- K = 1", 1-1/2", 2", 2-1/2"
- M = 2", 2-1/2", 3", 3-1/2"
- N = 2-1/2", 3"

* Knockouts shown for size not for exact positions.

Outline Drawings

General Duty Safety Switches

Type	Amps	Outline Drawing No.
Indoor	30-60	10103093SH4
	100-200	10103093SH8
Outdoor	30-60	10103093SH3
	100	10103093SH7
	200	10103093SH10

Outline drawings can be found at www.midwestelectric.com

Heavy Duty Safety Switches

Type	Amps	Outline Drawing No.
Indoor	30-60	10103093SH2
	100-200	10103093SH5
Outdoor	30-60	10103093SH1
	100	10103093SH6
	200	10103093SH9

Outline drawings can be found at www.midwestelectric.com

Midwest Electric Products

Section 7

AC Disconnects



Application Information

Article 440 of the National Electrical Code applies to electric motor-driven air conditioning and refrigerating equipment, and to the branch circuits and controllers for such equipment. It provides for the special considerations necessary for circuits supplying hermetic refrigerant motor-compressors and for any air conditioning and/or refrigerating equipment that is supplied from an individual branch circuit.

The National Electric Code Requirements

Disconnecting means shall be located within sight from and readily accessible from the air-conditioning or refrigerating equipment. The disconnecting means shall be permitted to be installed on or within the air-conditioning or refrigerating equipment. The disconnecting means shall not be located on panels that are designed to allow access to the air-conditioning or refrigeration equipment or to obscure the equipment nameplates.

Additionally, the National Electric Code states that listed or labeled equipment shall be used or installed in accordance with any instructions included in the listing or labeling.

Thus, when an equipment's label or instruction specifies circuit breaker protection, Article 110.3(b) can be met with a branch circuit breaker in the load center while article 440.14 can most economically be met using a disconnect without overcurrent protection. When an equipment's label or instructions specifies fuse protection, Article 110.3(b) mandates that fuse(s) must be present in the branch circuit. Since most load centers are of the circuit breaker variety, fuses must be installed elsewhere in the branch circuit. The most economical installation involves combining the fuse protection and disconnecting functions into a single device to be installed per Article 440.14. See illustration.

Air Conditioner Disconnect Selection Guide

Existing Branch Circuit Protection	Sight Disconnect Selection
Fusible ¹	Non-Fusible or Fusible
Circuit Breaker	Fusible
HACR ²	Non-Fusible or Fusible

¹ See Air Conditioner nameplate for correct selection.
² HACR = Heating, air conditioning, refrigeration type circuit breaker.

Features and Benefits

Flexibility

- 30-100 Amps
- 240 volts AC
- 1-phase or 3-phase fusible or non-fusible
- Horsepower rated
- 10kAIC
- Available with GFCI receptacle

Rugged Durability

- NEMA 3R weatherproof enclosure
- Noryl[®] thermoplastic enclosure is corrosion resistant and extremely durable, giving long maintenance free service
- Metallic models are made of G90 galvanized steel for superior corrosion protection and have a durable polyester powder coat finish which resists chipping and fading

User Safety

- Padlock provision on door helps prevent unauthorized access

Installation Ease

- Three-piece construction that opens up mounting and wiring areas
- Terminals approved for 60°C and 75°C wire, accepts solid 14-8 copper, 12-8 aluminum or stranded 14-3 copper, 12-3 aluminum
- Numerous knockouts reduce installation time
- Straight-in, straight-out wiring saves time and money

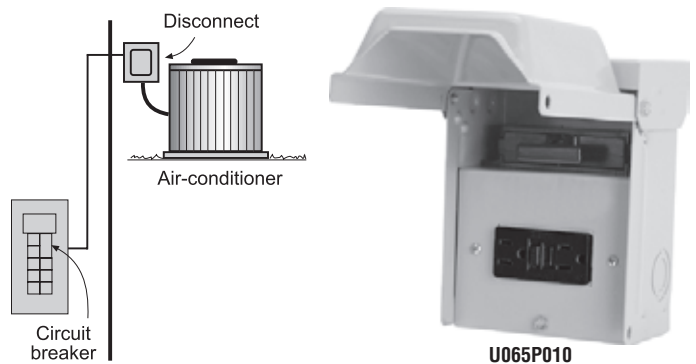

<p>Material</p> <p>P = Plastic U = Metallic</p>	<p>Amp Rating</p> <p>035 = 30 Amps 065 = 60 Amps 045 = 90 Amps Heat Pump 220 = 20 Amps Evap Cooler 261 = 40 Amps Evap Cooler 610 = 100 Amps Heat Pump</p>	<p>Phase</p> <p>Blank = Single Phase 3 = Three Phase</p>	<p>Fusing</p> <p>F = Fusible P = Non-Fusible PC = Non-Fusible, 20 GFI, Receptacle H = DPST, SPST Switch, Evap Cooler NA = Non-Fusible, Non-Automatic</p>	<p>Other Features</p> <p>1 = Midwest Assigned 2 = Midwest Assigned 1010 = Single Phase GFCI Receptacle 010 = Single Phase GFCI Receptacle</p>
---	---	---	---	---

Data subject to change without notice.

Non-Metallic

Fusible / Non-Fusible, 30 – 60 Amps, 120/240V

Fusible disconnects are available in 30 and 60 Amp models. Pullers are removable or reinstallable in the OFF position for user safety during equipment maintenance. The P065F UL listing includes the ability to field replace the 60 Amp puller with a 30 Amp puller (FR352) for installation flexibility. Listed for use as service entrance.

Non-fusible disconnect pullers are removable or reinstallable in the OFF position for user safety during equipment maintenance.

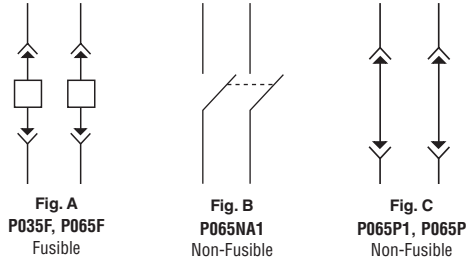

Fig.	Model Number		Amps	Horsepower Rating	Wire Range*	Cabinet Size	Unit Wt.	Std Pkg.	UL
	Fusible	Non-Fusible							
A	P035F	—	30	3	D	6 x 8	2	6	cULus
A	P065F	—	60	10		6 x 8			
B	—	P065NA1	60	10		5 x 7			
C	—	P065P1	60	10		5 x 7			
C	—	P065P	60	10		6 x 8			

* Wire Range Table on page 7-7. See Technical Data on page 7-6 for available replacement parts.

Metallic

1-Phase / 3-Phase, Fusible / Non-Fusible, 30 – 60 Amps, 120/240V or 240V

Fusible disconnects are available in 30 and 60 Amp models. Pullers are removable or reinstallable in the OFF position for user safety during equipment maintenance. Listed for use as service entrance.

Non-fusible disconnect pullers are removable or reinstallable in the OFF position for user safety during equipment maintenance.

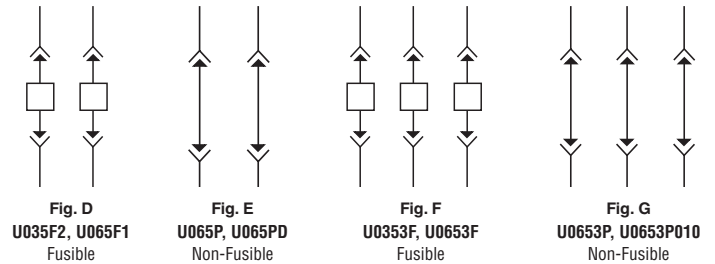

Fig.	Model Number		Amps	Horsepower Rating	Wire Range*	Cabinet Size	Unit Wt.	Std Pkg.	UL
	Fusible	Non-Fusible							
Phase 1 – 120/240V									
D	U035F2	—	30	3	D	5 x 7	2.5	6	cULus
D	U065F1	—	60	10		5 x 9	3.5		
E	—	U065P	60	10		5 x 7	3		
E	—	U065PD	60	10		7 x 10	7	1	
Phase 3 – 240V									
E	U0353F	—	30	3-7.5	D	6 x 14	8.5	4	cULus
F	U0653F	—	60	7.5-15					
G	—	U0653P	60	7.5-15					
G	—	U0653P010	60	7.5-15					

* Wire Range Table on page 7-7. See Technical Data on page 7-6 for available replacement parts.

Key

□ = Accepts Class H fuses (fuses not included)

Data subject to change without notice.

Non-Automatic

1-Phase, 60 Amps, 120/240V

Model Number	Phase	Amps	Horsepower Rating	Wire Range*	Cabinet Size	Unit Wt.	Std Pkg.	UL
U065NA1	1	60	10	D	5 x 7	2.5	6	cUL _{us}
U065NA2	1	60	10	D	7 x 10	6.5	6	cUL

* Wire Range Table on page 7-7.

Heat Pump

Fusible, 90 – 100 Amps, 120/240V

Multiple disconnect devices are offered for heat pump applications that require individual disconnects for the heating and cooling cycles. All pullers are removable or reinstallable in the OFF position for user safety during equipment maintenance. Their UL listing includes the ability to field replace the 60 Amp puller in the left fuse block with a 30 Amp puller (FR352) for installation flexibility but prohibits the interchangeability of pullers between fuse blocks to insure the proper fuse/puller combination is always reinstalled into the proper fuse block.

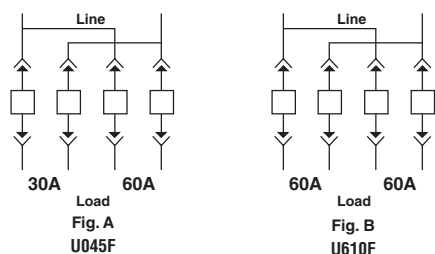

Fig.	Model Number	Amps	Horsepower Rating	Neutral Bar	Wire Range*	Cabinet Size	Unit Wt.	Std Pkg.	UL
	Fusible								
A	U045F	90	10	NU100B2	Y	9 x 17	13.5	1	Y
B	U610F	100							

* Wire Range Table on page 7-7. See Technical Data on page 7-6 for available replacement parts.

AC with Ground Fault

1-Phase / 3-Phase, 30 – 60 Amps, 120/240V or 240V

Model Number	Phase	Receptacle	Amps	Horsepower Rating	Wire Range*	Cabinet Size	Unit Wt.	Std Pkg.	UL
Phase 1 – 120/240V									
U035F010	1	5-15R2GFI	30	3	D	5 x 7	4	4	cUL
U065F010	1	5-15R2GFI	60	3-10	D	7 x 9-1/10	6.44	1	Y
U065P010	1	5-15R2GFI	60	10	D	5 x 7	4.3	6	cUL _{us}
U065NA1010	1	5-15R2GFI					4	6	
U065PC2	1	5-20R2					4.3	4	
Phase 3 – 240V									
U0353F010	3	5-20R2GFI	30	7.5-15	D	7 x 14	9.5	4	Y
U0653F010	3	5-20R2GFI	60				8.5	4	cUL

* Wire Range Table on page 7-7. See Technical Data on page 7-6 for available replacement parts.

Evaporative Cooler

Fusible, 20 – 40 Amps, 120/240V

Evaporative cooler applications not only require fusing but switching or receptacle functions depending on equipment type and local codes. Two models are offered to meet these varied evaporative cooler applications.

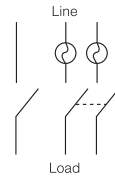

Fig. A
U220H

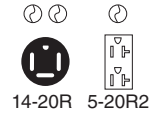

Fig. B
U261F

Fig.	Model Number	Receptacle	Circuit Protection	Amps	Wire Range*	Cabinet Size	Unit Wt.	Std Pkg.	UL
	Fusible								
A	U220H	DPST, SPST Switch	(2) FH1	20	AR	5 x 7	4.5	4	N
B	U261F	14-20R, 5-20R2	(3) FH1	40	E	6 x 9	6		UL

* Wire Range Table on page 7-7.

Key

□ = Accepts Class H fuses (fuses not included)

⊙ = Edison plug fuse base (fuses not included)

Mounting Bracket

Exterior

Fig.	Model Number	Orientation	Description	Std Pkg.
C	STC1	Exterior	For AC and AC/GFI in aluminum, vinyl siding and stucco applications	6

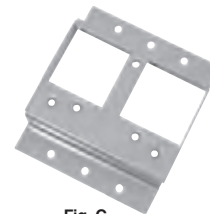

Fig. C
STC1

Technical Data

Model Number	Replacement Parts			Cabinet Size	Enclosure Style	Cabinet Dimensions (inches)				Knockout Figure ¹
	Complete Block and Puller	Fuse Block Only	Puller Only			Height (A)	Width (B)	Depth (C)	Depth (D)	
P035F	FR39	—	FR352	6 x 8	C	8	5-3/4	3-1/8	—	5
P065F	FR69	—	FH682	6 x 8	C	8	5-3/4	3-1/8	—	5
P065NA1	—	—	—	5 x 7	D	7-1/4	5	2-1/8	2-3/4	1
P065P	—	NF65	NF652	6 x 8	D	8	6	5-3/4	2-3/4	5
P065P1	—	NF65	NF652	5 x 7	D	7	5	2-1/8	2-3/4	1
U035F010	FR35R	—	FR352R	9 x 7	A	9	6-3/5	3-4/5	5-1/5	7
U035F2	FR35R	—	FR352R	5 x 7	A	7	5	2-1/8	2-3/4	1
U0353F	265A6035G27	—	265A6035G27	6 x 14	B	14-3/8	7-1/4	5-3/16	—	6
U0353F010	265A6035G27	—	265A6035G27	7 x 14	B	14	7	5-3/16	—	6
U045F	FR35XFR67	—	FR352, FH682	9 x 17	B	17-3/8	9-3/4	5-3/16	—	2
U0653F	265A6036G69	—	265A6036G69	6 x 14	B	14-3/8	7-1/4	5-3/16	—	6
U0653F010	265A6036G69	—	265A6036G69	7 x 14	B	14	7	5-3/16	—	6
U0653P	265A6036G73	—	265A6036G73	6 x 14	B	14-3/8	7-1/4	5-3/16	—	6
U0653P010	—	—	—	7 x 14	B	14	7	5-3/16	—	6
U065F010	FR69	—	FH682	9 x 7	B	9	7	5-1/5	—	7
U065F1	FR65	—	FH682	5 x 9	A	9	5	2-1/8	2-3/4	1
U065NA1	—	—	—	5 x 7	D	7	5	2-1/8	2-3/4	1
U065NA2	—	—	—	7 x 10	E	10	7-1/2	4	—	8
U065NA1010	—	—	—	5 x 7	D	7	5	3-5/8	5-3/16	3
U065P	—	NF65	NF652	5 x 7	A	7-1/4	5	2-1/8	2-3/4	1
U065PD	—	NF65	NF652	7 x 10	E	10	7-1/2	4	—	8
U065P010	—	NF65	NF652	5 x 7	D	7	5	3-5/8	5-3/16	3
U065PC2	—	NF65	NF652	5 x 7	D	7	5	2-1/8	2-3/4	3
U220H	—	FH1	—	5 x 7	B	7-1/8	5-3/4	5-3/16	—	3
U261F	—	FH1	—	6 x 9	B	9-1/8	7-1/4	5-3/16	—	4
U610F	FR67X2	—	FH682	9 x 17	B	17-3/8	9-3/4	5-3/16	—	2

¹ Knockout Figures on page 7-7.

Enclosure Styles / Cabinet Dimensions

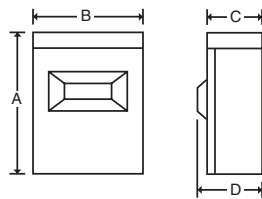

Fig. A

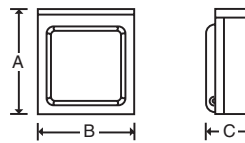

Fig. B

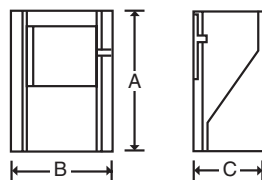

Fig. C

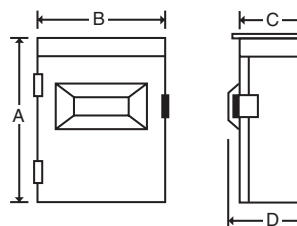

Fig. D

Knockout Configurations

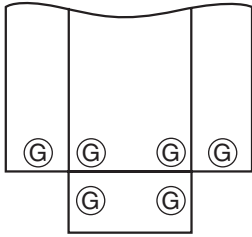

Fig. 1

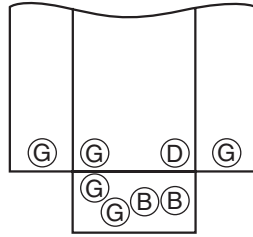

Fig. 2

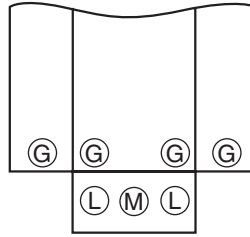

Fig. 3

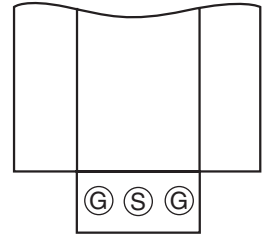

Fig. 4

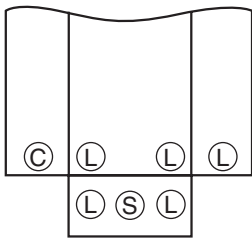

Fig. 5

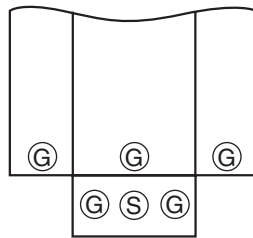

Fig. 6

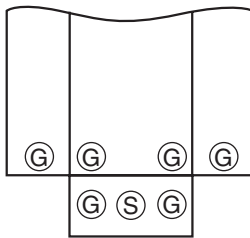

Fig. 7

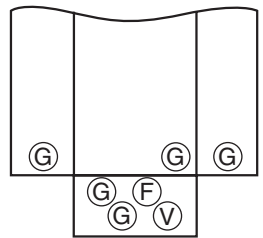

Fig. 8

Knockout Key

- B = 1", 1-1/4", 1-1/2"
- C = 3/4", 1-1/4"
- D = 3/4", 1", 1-1/4"
- F = 1/2"
- G = 1/2", 3/4", 1"
- L = 1/2", 3/4"
- M = 1/2", 3/4", 1", 1-1/4"
- S = 1/2", 3/4", 1", 1-1/4", 1-1/2"
- V = 3/4", 1", 1-1/4", 1-1/2"
- W = 3/4", 1"
- Y = 1", 1-1/4"

* Knockouts shown for size not for exact positions.

Wire Range Tables

D

Connector	Copper		Aluminum	
	Solid	Strand	Solid	Strand
Line	14-8	14-2	12-8	12-2
Load	14-8	14-2	12-8	12-2
Neutral	—	—	—	—
Equipment Ground	12-8	12-2	12-8	12-2

E

Connector	Copper		Aluminum	
	Solid	Strand	Solid	Strand
Line	14-10	14-10	—	—
Load	14-10	14-10	—	—
Neutral	14-10	14-10	—	—
Equipment Ground	12-8	12-2	—	—

Y

Connector	Copper		Aluminum	
	Solid	Strand	Solid	Strand
Line	14-8	14-1/0	12-8	12-1/0
Load	14-8	14-2	12-1/0	12-2
Neutral	14-8	14-1/0	12-8	12-1/0

AR

Connector	Copper		Aluminum	
	Solid	Strand	Solid	Strand
Line	14-10	14-10	—	—
Load	14-10	14-10	—	—
Neutral	—	—	—	—
Equipment Ground	12-8	12-2	—	—

Notes

Section 8

Transfer Switches / Power Inlets



Application Information

Midwest Electric heavy duty manual transfer switches help provide reliable transfer of power from the normal utility-supplied source to a standby generator, enabling the user to readily maintain power during utility outages. Use them anywhere an extended outage would result in severe loss, damage or inconvenience.

Designed to be operational and switchable at full rated capacity, Midwest Electric transfer switches are available in single- and three-phase configurations at ratings through 600V. The double-throw mechanism helps prevent dangerous backfeeding of generator power into the utility system.



Features and Benefits

Electrical Ratings

- 100-400 amperes
- 240V or 600V models
- 10kAIC

Rugged Durability

- Break before make switch mechanism*
- All-in-one construction with factory-assured terminations
- Bus bars interconnect main and standby switches*
- Knife blade switch contacts help provide long life
- NEMA 3R weatherproof enclosure
- G90 galvanized steel construction for superior corrosion protection
- Durable polyester powder coat finish resists chipping and fading
- High quality, user-tested components designed for long life

User Protection

- Interlock allows door opening only when switch is in the OFF position*
- Padlock provision in all three ON-OFF-ON transfer positions
- Padlock provision on door

Installation Ease

- Optional neutral kits available for both 240V and 600V models
- Broad range of concentric knockouts accommodate varying wiring needs
- All terminals accept copper or aluminum wire for installation flexibility



* On most models.

Steel Enclosures

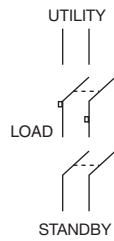

Fig. A
GS1101B12UL, GS1201B20UL, GS1202B20UL,
GS1402B01UL, GS1404B01UL

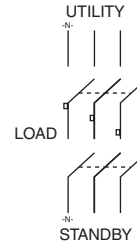

Fig. B
GS3402B01UL, GS3404B01UL, GS3161B12UL,
GS3262B25UL, GS3464B01UL

Two Pole, 100 – 400 Amps, 120/240V

Fig.	Model Number	Switch Ratings		Optional Neutral Kit ¹	Unit Wt.	UL
		Amps				
		Main	Standby			
A	GS1101B12UL	100	100	NEU102	31	cUL ^{us}
	GS1201B20UL	200	100	NEU202	42	
	GS1202B20UL	200	200	NEU202	46	
	GS1402B01UL	400	200	NEU407	71	cUL ^{us}
	GS1404B01UL	400	400	NEU407	80	

¹ Order Neutral Kit for 3-wire system (120/240).

Three Pole, 200 – 400 Amps, 240V

Fig.	Model Number	Switch Ratings		Optional Neutral Kit ¹	Unit Wt.	UL
		Amps				
		Main	Standby			
B	GS3402B01UL	400	200	NEU407	107	cUL ^{us}
	GS3404B01UL	400	400		120	

¹ Order Neutral Kit for 4-wire system (280Y/120).

Three Pole, 100 – 400 Amps, 600V

Fig.	Model Number	Switch Ratings		Optional Neutral Kit ¹	Unit Wt.	UL
		Amps				
		Main	Standby			
B	GS3161B12UL	100	100	NEU102	31	cUL ^{us}
	GS3262B25UL	200	200	NEU202	48	
	GS3464B01UL	400	400	NEU407	120	

¹ Order Neutral Kit for 4-wire systems (208Y/120, 480Y/277, 600Y/347).

All three pole models are suitable for use in 1-Phase, 3-wire, switched neutral applications – no neutral required.

Light Duty Transfer Switches with Aluminum Enclosures

Two Pole, 100 – 200 Amps, 120/240V or 240V

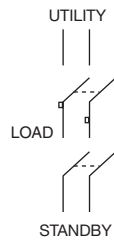

Fig. A
GS316G, GS1202B20M

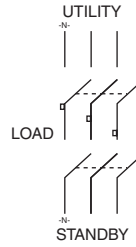

Fig. B
GS3262G

Fig.	Model Number	Switch Ratings		Neutral Kit	Unit Wt.	UL
		Amps				
		Main	Standby			
Two Pole – 120/240V						
A	GS3161G	100	100	Factory Installed	11	
Two Pole – 240V						
B	GS3262G	200	200	Factory Installed	43	

Transfer Switch with Attached Meter Socket and Steel Enclosure

Two Pole, 200 Amps, 120/240V

Fig.	Model Number	Switch Ratings		Neutral Kit	Unit Wt.	UL
		Amps				
		Main	Standby			
A	GS1202B20M	200	200	Factory Installed	50	N

Technical Data

Model Number	Wire Range (cu/al)	Conduit Hub/Opening ¹		Enclosure Style	Cabinet Dimensions (inches)				Knockout Figure
		Qty.	Size		Height (A)	Width (B)	Depth (C)	Depth (D)	
GS1101B12UL	12-1/0	1	1-1/4	A	26	13	6-3/4	10-5/8	1
GS3161B12UL					26	13	6-3/4	10-5/8	1
GS1201B20UL	6-250	1	2	A	32	15-3/4	6-3/4	10-5/8	2
GS1202B20M			2-1/2	B	36-1/10	14-3/10	4-4/5	—	5
GS1202B20UL			2	A	35	15-3/4	7	10-5/8	2
GS3262B25UL			2-1/2	A	34-3/4	15-3/4	6-3/4	10-5/8	2
GS1402B01UL	2-600 or (2) 1/0-250	2	Closure Caps	A	43-1/2	18-1/2	9-1/4	14-1/8	3
GS1404B01UL					43-3/4	18-1/2	9-1/4	14-1/8	3
GS3161G	14-1/0			A	15-1/4	8	5-2/5	6-9/10	6
GS3262G	6-250	1	Closure Cap	A	30-1/4	15-3/10	8-3/5	11-4/5	7
GS3402B01UL	2-600 or (2) 1/0-250	2	Closure Caps	A	42-1/2	24	9-1/4	14-1/8	4
GS3404B01UL					43-1/2	24	9	14-1/8	4
GS3464B01UL					43-1/2	24	9	14-1/8	4

¹ Switch includes conduit hub or closure cap(s) as indicated. Alternate conduit hub sizes on page 14-3.

Enclosure Styles / Cabinet Dimensions

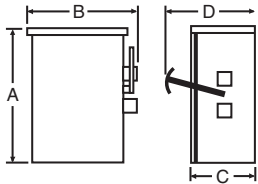

Fig. A

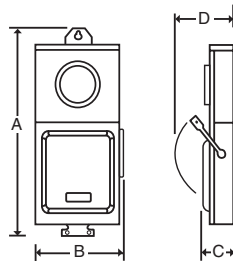

Fig. B

Knockout Configurations

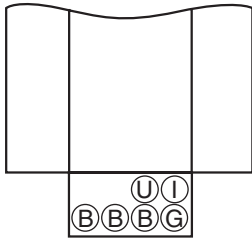

Fig. 1

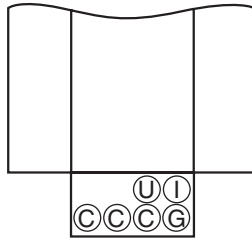

Fig. 2

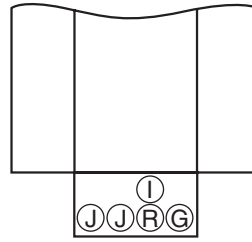

Fig. 3

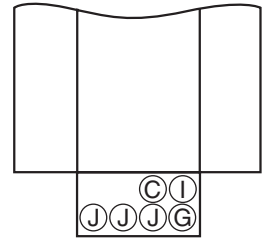

Fig. 4

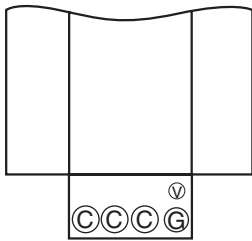

Fig. 5

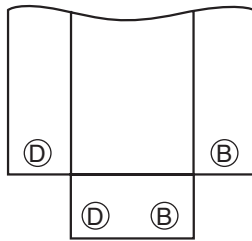

Fig. 6

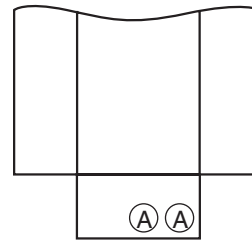

Fig. 7

Knockout Key

- A = 1-1/2", 2", 2-1/2"
- B = 1", 1-1/4", 1-1/2"
- C = 1-1/4", 1-1/2", 2"
- D = 3/4", 1", 1-1/4"
- G = 1/2", 3/4", 1"
- I = 11/16"
- J = 2", 2-1/2", 3", 3-1/2"
- R = 3/4", 1", 1-1/4", 1-1/2", 2"
- U = 1/4"
- V = 1/2"

* Knockouts shown for size not for exact positions.

Power Inlets

Power inlets from Midwest Electric work with the manual transfer switches for standby power. Each inlet comes in a single enclosure for maximum protection against weather and normal field use.

Features and Benefits

- All-in-one construction with factory-assured terminations help reduce installation time
- NEMA 3R weatherproof enclosure
- G90 galvanized steel construction for superior corrosion protection
- Durable polyester powder coat finish resists chipping and fading
- Rolled edge door for cord protection
- Cover design accommodates cords in place while maintaining NEMA 3R integrity
- Padlockable to help prevent unauthorized access
- Deadfront constructions help prevent accidental contact with live parts



U030N

Technical Data



Fig. A
U020N
 L14-20



Fig. B
U030N
 L14-30



Fig. C
U050N
 CS6375

20 – 50 Amps, 120/240V

Fig.	Model Number	Amps	Receptacles	Dimensions (inches)		
				Height	Width	Depth
A	U020N	20	L14-20	14-3/8	6-3/4	5-3/16
B	U030N	30	L14-30			
C	U050N	50	CS6375 ²			

¹ Also includes (2) MHQL1120 20A circuit breakers and one breaker space.

² California Standard, three pole, 4 wire grounded non-NEMA.

Knockout Configuration

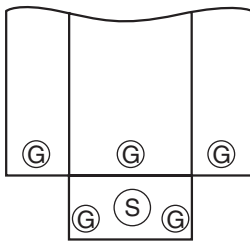

Fig. 1

Knockout Key

G = 1/2", 3/4", 1"

S = 1/2", 3/4", 1", 1-1/4", 1-1/2"

* Knockouts shown for size not for exact positions.

Section 9

Temporary Power



Application Information

Prior to permanently installing service equipment on a new structure, temporary power is typically installed to support the various construction trades. Electricians that are not familiar with Midwest Electric's Site-Power™ line usually construct their own temporary power arrangement using a combination of individual outdoor rated components (meter box, load center and multiple receptacles) assembled on a sheet of plywood and anchored to the ground with dimension lumber. While sufficient to do the job, this arrangement is labor intensive, has multiple conduit connections with the potential for water intrusion and is not well protected against unauthorized use.

Site-Power™ temporary power equipment from Midwest Electric combines the metering, circuit protection and power outlet combinations that are required on most construction sites. Every unit is delivered to the job site ready to go with factory installed and wired components — giving you the assurance needed for a reliable and safe temporary power unit. All Site-Power™ enclosures are constructed from heavy-gauge G90 galvanized steel for superior corrosion resistance. The durable polyester powder coat finish resists chipping and fading. The equipment door is designed to protect power cords and plugs and has a padlock provision to guard against unauthorized use or vandalism.



U055C010P

Features and Benefits

Rugged Durability

- Rolled edge door for cord protection
- Continuous duty meter socket with meter guides and reinforced jaws – ringless and ring type
- Utility accepted meter sealing accommodations
- NEMA 3R weatherproof construction
- G90 galvanized steel construction for superior corrosion resistance
- Durable polyester powder coat finish resists chipping and fading
- 10kAIC
- All GFCI duplexes are listed as weather resistant and tamper resistant as required by NEC in Article 406.8 and 406.11

Installation Ease

- All components factory wired and assembled, reducing installation time
- Door removable for installation ease; stay open position for user convenience
- All terminals accept copper or aluminum wire for added installation flexibility
- Wide range of receptacle configurations
- Broad range of concentric knockouts to accommodate varied wiring needs
- All units with factory installed Cu/Al equipment ground lug

User Safety

- Dead front construction prevents accidental contact with live parts
- Padlock provision to prevent unauthorized access

All-In-One Design

- Includes circuit breakers, receptacles and meter socket (if required)
- Available with GFI circuit breakers
- Eliminates construction delays due to red tag code violations
- All ringless meter socket models have standard horn bypass
- Conforms to NEC and NEMA standards

Unmetered

30 – 40 Amps, 120/240V

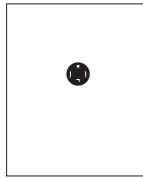

Fig. A
U030
 14-30R

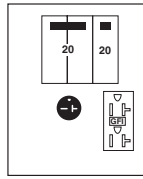

Fig. B
U036C010
 6-20R, 5-20R2GFCI

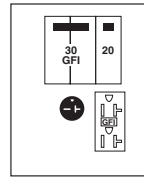

Fig. C
U036C033
 6-20R, 5-20R2GFCI

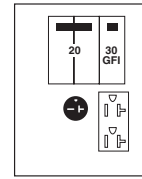

Fig. D
U036G
 6-20R, 5-20R2

Fig.	Model Number	Receptacles	Circuit Protection	Amps	Wire Range*	Cabinet Size	Hub Opening	Load & Neutral Bar	Unit Wt.	Std Pkg.	UL
A	U030	14-30R	—	30	G	5 x 7	Y	—	4.5	1	Y
B	U036C010	6-20R, 5-20R2GFCI	THQL2120, THQL1120	40	K	6 x 14		LC33N7	10	4	cULus
C	U036C033	6-20R, 5-20R2GFCI	THQL2130GFT, THQL1120	40	K	6 x 14		LC33N7	10	4	
D	U036G	6-20R, 5-20R2	THQL2120, THQL2130GFT	40	K	6 x 14		LC33N7	10	4	

* Wire Range Table on page 9-12.

Unmetered

70 Amps, 120/240V

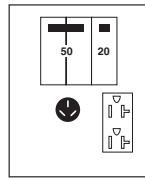

Fig. A
U051C
 10-50R, 5-20R2

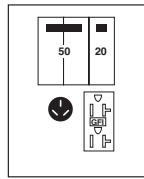

Fig. B
U051C010
 10-50R, 5-20R2GFCI

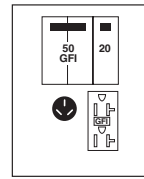

Fig. C
U051C033
 10-50R, 5-20R2GFCI

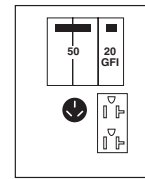

Fig. D
U051G
 10-50R, 5-20R2

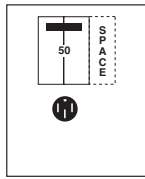

Fig. E
U054C
 BR54U

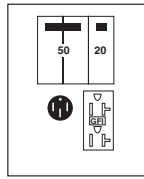

Fig. F
U055C010P
 BR54U, 5-20R2GFCI

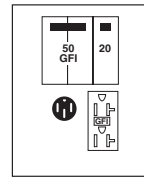

Fig. G
U055C033
 BR54U, 5-20R2GFCI

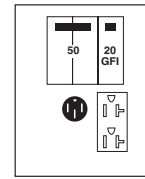

Fig. H
U055G
 BR54U, 5-20R2

Fig.	Model Number	Receptacles	Circuit Protection	Amps	Wire Range*	Cabinet Size	Hub Opening	Load & Neutral Bar	Unit Wt.	Std Pkg.	UL
A	U051C	10-50R, 5-20R2	THQL2150, THQL1120	70	K	6 x 14	Y	LC33N7	10	4	N
B	U051C010	10-50R, 5-20R2GFCI	THQL2150, THQL1120	70	K						
C	U051C033	10-50R, 5-20R2GFCI	THQL2150GFT, THQL1120	70	K						
D	U051G	10-50R, 5-20R2	THQL2150, THQL1120GFT	70	K						
E	U054C	BR54U	THQL2150, Space THQL1120	70	O						cULus
F	U055C010P	BR54U, 5-20R2GFCI	THQL2150, THQL1120	70	K						
G	U055C033	BR54U, 5-20R2GFCI	THQL2150GFT, THQL1120	70	K						
H	U055G	BR54U, 5-20R2	THQL2150, THQL1120GFT	70	K						

* Wire Range Table on page 9-12.

Unmetered

90 – 125 Amps, 120/240V

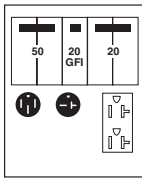

Fig. A
U073G
BR54U, 6-20R, 5-20R2

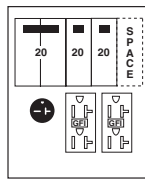

Fig. B
U038C010
6-20R, (2) 5-20R2GFCI

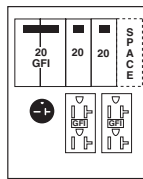

Fig. C
U038C033
6-20R, (2) 5-20R2GFCI

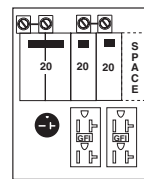

Fig. D
U038CTL010
6-20R, (2) 5-20R2GFCI

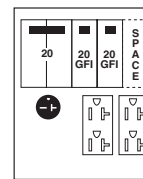

Fig. E
U038G
6-20R, (2) 5-20R2

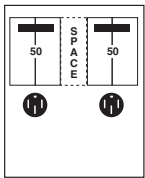

Fig. F
U072C
(2) BR54U

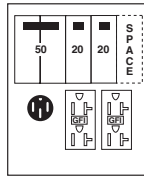

Fig. G
U076C010
BR54U, (2) 5-20R2GFCI

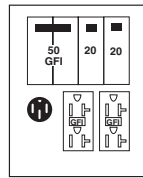

Fig. H
U076C033
BR54U, (2) 5-20R2GFCI

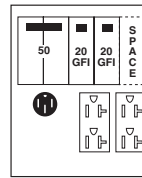

Fig. I
U076G
BR54U, (2) 5-20R2

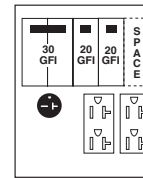

Fig. J
U038G033
6-20R, (2) 5-20R2

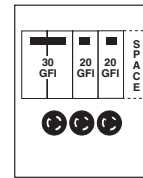

Fig. K
U039G6
L6-30R, (2) L5-20R

Fig.	Model Number	Receptacles	Circuit Protection	Amps	Wire Range*	Cabinet Size	Hub Opening	Load & Neutral Bar	Unit Wt.	Std Pkg.	UL
A	U073G	BR54U, 6-20R, 5-20R2	THQL2150, THQL2120, THQL1120GFT	90	U	9 x 17	Y	LC55N1	16	1	UL
B	U038C010	6-20R, (2) 5-20R2GFCI	THQL2120, (2) THQL1120	100	AA	9 x 17		LC55N1	15	1	
C	U038C033	6-20R, (2) 5-20R2GFCI	THQL2120GFT, (2) THQL1120, Space THQL1120	100	AA	9 x 17		LC55N1	15	1	
D	U038CTL010 ¹	6-20R, (2) 5-20R2GFCI	THQL2120, (2) THQL1120, Space THQL1120	100	AA	9 x 17		LC55N1T	16	1	
E	U038G	6-20R, (2) 5-20R2	THQL2120, (2) THQL2120GFT, Space THQL1120	100	U	9 x 17		LC55N1	15	1	
F	U072C	(2) BR54U	(2) THQL2150, Space THQL1120	100	V	9 x 17		LC55N1	16	1	
G	U076C010	BR54U, (2) 5-20R2GFCI	THQL2150, (2) THQL1120, Space THQL1120	100	AA	9 x 17		LC55N1	16	1	
H	U076C033	BR54U, (2) 5-20R2GFCI	(2) THQL1120, THQL2150GFT	100	AA	9 x 17		LC55N1	16	1	
I	U076G	BR54U, (2) 5-20R2	THQL2150, (2) THQL1120GFT, Space THQL1120	100	U	9 x 17		LC55N1	16	1	
J	U038G033	6-20R, (2) 5-20R2	THQL2130GFT, (2) THQL1120GFT, Space THQL1120	100	U	9 x 17		LC55N1	15	1	
K	U039G6	L6-30R, (2) L5-20R	THQL2130GFT, (2) THQL1120GFT, Space THQL1120	125	C	9 x 21		LC88PC	16	1	

¹ Available with GFI dual-pole breaker in place of GFI receptacle – replace "010" with "033". Order U038CTL033.

* Wire Range Table on page 9-12.

Metered

Top Feed, 40 – 90 Amps, 120/240V

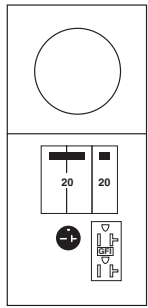

Fig. A
M036C010, R036C010
6-20R, 5-20R2GFCI

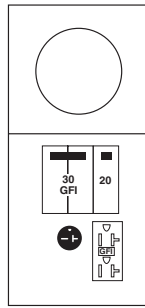

Fig. B
M036C033
6-20R, 5-20R2GFCI

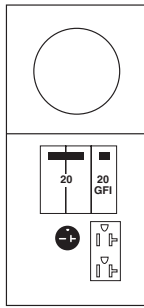

Fig. C
M036G, R036G
6-20R, 5-20R2

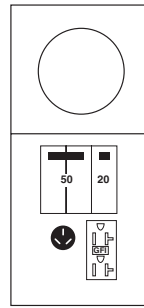

Fig. D
M051C010
10-50R, 5-20R2GFCI

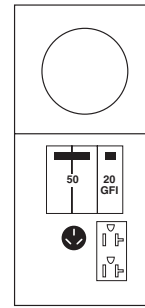

Fig. E
M051G
10-50R, 5-20R2

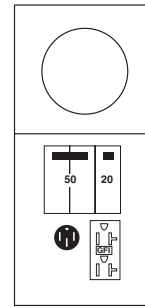

Fig. F
M055C010, R055C010
BR54U, 5-20R2GFCI

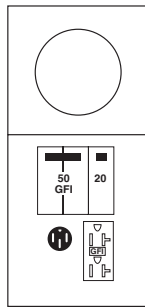

Fig. G
M055C033, R055C033
BR54U, 5-20R2GFCI

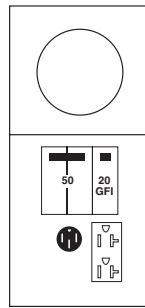

Fig. H
M055G, R055G
BR54U, (2) 5-20R2

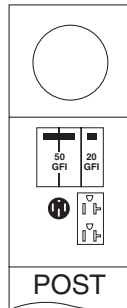

Fig. I
M055GP6033
BR54U, 5-20R2

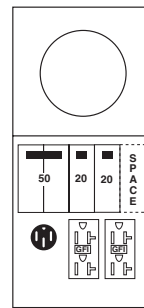

Fig. J
M076C010, R076C010
BR54U, (2) 5-20R2GFCI

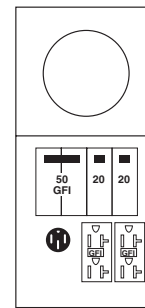

Fig. K
M076C033, R076C033
BR54U, (2) 5-20R2GFCI

Fig.	Model Number		Receptacles	Circuit Protection	Amps	Wire Range*	Cabinet Size	Hub Opening	Load & Neutral Bar	Unit Wt.	Std Pkg.	UL
	Ringtype	Ringless										
A	M036C010	R036C010	6-20R, 5-20R2GFCI	THQL2120, THQL1120	40	AA	9 x 30		LC33N1	25		UL
B	M036C033	—	6-20R, 5-20R2GFCI	THQL2130GFT, THQL1120	40	AA	9 x 30		LC33N1	23		
C	M036G	R036G	6-20R, 5-20R2	THQL2120, THQL1120GFT	40	AA	9 x 30		LC33N1	25		
D	M051C010	—	10-50R, 5-20R2GFCI	THQL2150, THQL1120	70	AA	9 x 30		LC33N1	25		
E	M051G	—	10-50R, 5-20R2	THQL2150, THQL1120GFT	70	AA	9 x 30		LC33N1	25		
F	M055C010	R055C010	BR54U, 5-20R2GFCI	THQL2150, THQL1120	70	K	9 x 30	Y	LC33N1	25	1	
G	M055C033	R055C033	BR54U, 5-20R2GFCI	THQL2150GFT, THQL1120	70	K	9 x 30		LC33N1	23		
H	M055G	R055G	BR54U, 5-20R2	THQL2150, THQL1120GFT	70	AA	9 x 30		LC33N1	25		
I	M055GP6033 ¹	—	BR54U, 5-20R2	THQL1120GFT, THQL2150GFT	70	A2	9 PT		LC33N1	51		
J	M076C010	R076C010	BR54U, (2) 5-20R2GFCI	THQL2150, (2) THQL1120, Space THQL1120	90	AA	9 x 30		LC55N1	25		
K	M076C033	R076C033	BR54U, (2) 5-20R2GFCI	THQL2150GFT, (2) THQL1120, Space THQL1120	90	AA	9 x 30		LC55N1	25		

¹ Earth Burial Post. See page 11-25 for post mounted dimensions.
* Wire Range Table on page 9-12.

Metered

Top Feed, 40 – 100 Amps, 120/240V

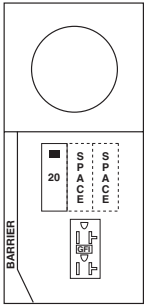

Fig. A
M009C010
5-20R2GFCI

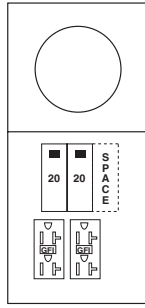

Fig. B
M011C010, R011C010
(2) 5-20R2GFCI

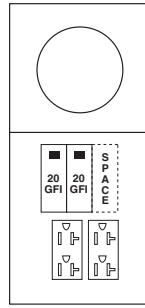

Fig. C
M011G, R011G
(2) 5-20R2

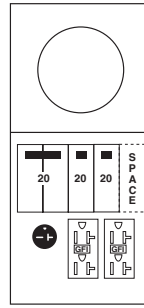

Fig. D
M038C010, R038C010
6-20R, (2) 5-20R2GFCI

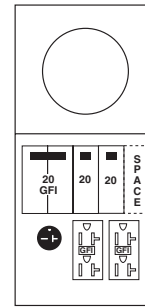

Fig. E
M038C033, R038C033
6-20R, (2) 5-20R2GFCI

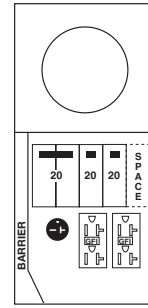

Fig. F
M038CB1010
6-20R, (2) 5-20R2GFCI

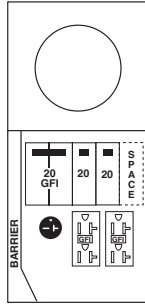

Fig. G
M038CB1033
6-20R, (2) 5-20R2GFCI

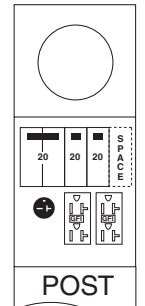

Fig. H
R038CP4010
6-20R, (2) 5-20R2GFCI

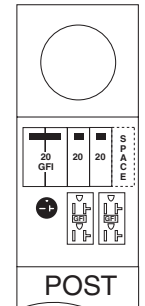

Fig. I
R038CP4033
6-20R, (2) 5-20R2GFCI

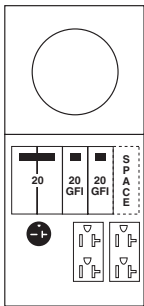

Fig. J
M038G, R038G
6-20R, (2) 5-20R

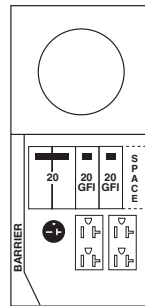

Fig. K
M038GB1
6-20R, (2) 5-20R

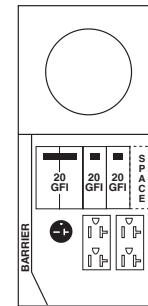

Fig. L
M038GB1033
6-20R, (2) 5-20R

Fig.	Model Number		Receptacles	Circuit Protection	Amps	Wire Range*	Cabinet Size	Hub Opening	Load & Neutral Bar	Unit Wt.	Std Pkg.	UL
	Ringtype	Ringless										
A	M009C010	—	5-20R2GFCI	THQL1120, Space (2) THQL1120	40	AA	9 x 30	Y	LC33N1	22	1	cULus
B	M011C010	R011C010	(2) 5-20R2GFCI	(2) THQL1120, Space THQL1120	100	AA	9 x 30		LC33N1	21	1	
C	M011G	R011G	(2) 5-20R2	(2) THQL1120GFT, Space THQL1120	100	AA	9 x 30		LC33N1	21	1	
D	M038C010	R038C010	6-20R, (2) 5-20R2GFCI	THQL2120, (2) THQL1120, Space THQL1120	100	AA	9 x 30		LC55N1	25	1	
E	M038C033	R038C033	6-20R, (2) 5-20R2GFCI	THQL2120GFT, (2) THQL1120, Space THQL1120	100	AA	9 x 30		LC55N1	24	1	
F	M038CB1010	—	6-20R, (2) 5-20R2GFCI	THQL2120, (2) THQL1120, Space THQL1120	100	AA	14 x 26		LC55N1	33	1	
G	M038CB1033	—	6-20R, (2) 5-20R2GFCI	THQL2120GFT, (2) THQL1120, Space THQL1120	100	AA	14 x 26		LC55N1	33	1	
H	—	R038CP4010 ¹	6-20R, (2) 5-20R2GFCI	THQL2120, (2) THQL1120, Space THQL1120	100	A2	9 PT		LC55N1	45	1	cULus
I	—	R038CP4033 ¹	6-20R, (2) 5-20R2GFCI	THQL2120GFT, (2) THQL1120, Space THQL1120	100	A2	9 PT		LC55N1	45	1	
J	M038G	R038G	6-20R, (2) 5-20R	THQL2120, (2) THQL1120GFT, Space THQL1120	100	AA	9 x 30		LC55N1	25	4	Y
K	M038GB1	—	6-20R, (2) 5-20R	THQL2120, (2) THQL1120GFT, Space THQL1120	100	AA	14 x 26		LC55N1	35	1	
L	M038GB1033	—	6-20R, (2) 5-20R2	THQL2120GFT, (2) THQL1120GFT, Space THQL1120	100	AA	14 x 26		LC55N1	35	1	

¹ Pad Mount Post. See page 11-25 for post mounted dimensions. * Wire Range Table on page 9-12.

Data subject to change without notice.

Metered

Bottom Feed, 40 – 100 Amps, 120/240V

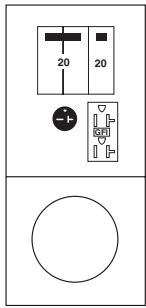

Fig. A
M036C010U
6-20R, 5-20R2GFCI

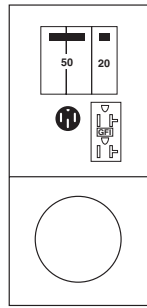

Fig. B
M055C010U, R055C010U
BR54U, 5-20R2GFCI

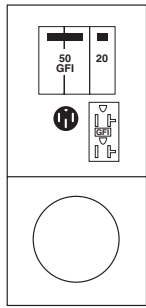

Fig. C
M055C033U, R055C033U
BR54U, 5-20R2GFCI

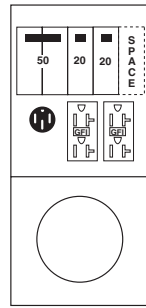

Fig. D
M076C010U, R076C010U
BR54U, (2) 5-20R2GFCI

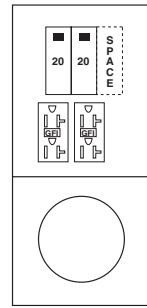

Fig. E
M011C010U, R011C010U
(2) 5-20R2GFCI

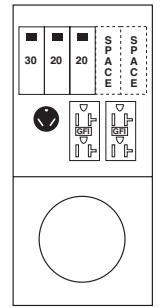

Fig. F
R031C010U
R32U, (2) 5-20R2GFCI

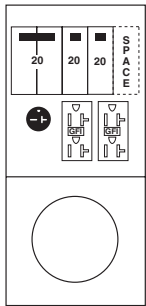

Fig. G
M038C010U, R038C010U
6-20R, (2) 5-20R2GFCI

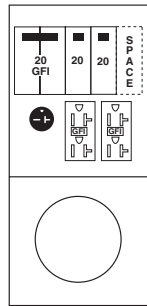

Fig. H
M038C033U, R038C033U
6-20R, (2) 5-20R2GFCI

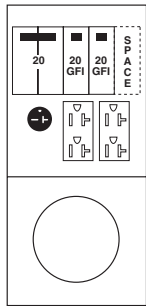

Fig. I
R038GU
6-20R, (2) 5-20R2

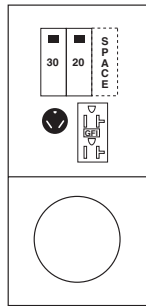

Fig. J
M041C010U
R32U, 5-20R2GFCI

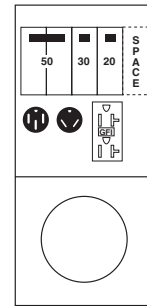

Fig. K
M075C010U, R075C010U
BR54U, R32U, 5-20R2GFCI

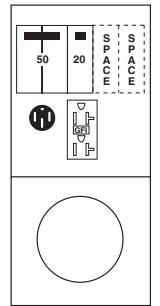

Fig. L
M355C010U
BR54U, 5-20R2GFCI

Fig.	Model Number		Receptacles	Circuit Protection	Amps	Wire Range*	Cabinet Size	Hub Opening	Load & Neutral Bar	Unit Wt.	Std Pkg.	UL
	Ringtype	Ringless										
A	M036C010U	—	6-20R, 5-20R2GFCI	THQL2120, THQL1120	40	X	9 x 30U	N	LC33N1	25	1	UL
B	M055C010U	R055C010U	BR54U, 5-20R2GFCI	THQL2150, THQL1120	70	H	9 x 30U	N	LC33N1	25		
C	M055C033U	R055C033U	BR54U, 5-20R2GFCI	THQL2150GFT, THQL1120	70	H	9 x 30U	Y	LC33N1	23		
D	M076C010U	R076C010U	BR54U, (2) 5-20R2GFCI	THQL2150, (2) THQL1120, Space THQL1120	90	X	9 x 30U	N	LC55N1	25		
E	M011C010U	R011C010U	(2) 5-20R2GFCI	(2) THQL1120, Space THQL1120	100	X	9 x 30U	N	LC33N1	21		
F	—	R031C010U	R32U, (2) 5-20R2GFCI	THQL1130, (2) THQL1120	100	AA	9 x 30U	Y	LC55N1	25		
G	M038C010U	R038C010U	6-20R, (2) 5-20R2GFCI	THQL2120, (2) THQL1120, Space THQL1120	100	X	9 x 30U	N	LC55N1	25		
H	M038C033U	R038C033U	6-20R, (2) 5-20R2GFCI	THQL2120GFT, (2) THQL1120, Space THQL1120	100	X	9 x 30U	Y	LC55N1	26		
I	—	R038GU	6-20R, (2) 5-20R2	THQL2120, (2) THQL1120GFT	100	X	9 x 30U	N	LC55N1	25		
J	M041C010U	—	R32U, 5-20R2GFCI	THQL1130, THQL1120, Space THQL1120	100	AA	9 x 30U	Y	LC33N1	25		
K	M075C010U	R075C010U	BR54U, R32U, 5-20R2GFCI	THQL2150, THQL1130, THQL1120, (1) Space	100	AA	9 x 30U	Y	LC55N1	25		
L	M355C010U	—	BR54U, 5-20R2GFCI	THQL2150, THQL1120, (2) Space THQL1120	100	AA	9 x 30U	Y	LC55N1	25		

* Wire Range Table on page 9-12.

Technical Data

Model Number	Replacement Parts	Cabinet Size	Enclosure Style ¹	Cabinet Dimensions (inches)			Knockout Figure ²
	Meter Socket			Height (A)	Width (B)	Depth (C)	
M009C010	MSM100930	9 x 30	B	30	9-3/4	5-3/16	2
M011C010	MSM100930	9 x 30	B	30	9-3/4	5-3/16	2
M011C010U	MSM100EZ	9 x 30U	C	30	9-3/4	5-3/16	3
M011G	MSM100930	9 x 30	B	30	9-3/4	5-3/16	2
M036C010	MSM100930	9 x 30	B	30	9-3/4	5-3/16	2
M036C010U	MSM100EZ	9 x 30U	C	30	9-3/4	5-3/16	3
M036C033	MSM100930	9 X 30	B	30	9-3/4	5-3/16	2
M036G	MSM100930	9 x 30	B	30	9-3/4	5-3/16	2
M038C010	MSM100930	9 x 30	B	30	9-3/4	5-3/16	2
M038C010U	MSM100EZ	9 x 30U	C	30	9-3/4	5-3/16	3
M038C033	MSM100930	9 X 30	B	30	9-3/4	5-3/16	2
M038C033U	MSM100EZ	9 X 30U	C	30	9-3/4	5-3/16	3
M038CB1010	MSM10014	14 x 26	B	26-1/4	14-3/4	4-9/16	4
M038CB1033	MSM10014	14 x 26	B	26-1/4	14-3/4	4-9/16	4
M038G	MSM100930	9 x 30	B	30	9-3/4	5-3/16	2
M038GB1	MSM10014	14 x 26	B	26-1/4	14-3/4	4-9/16	4
M038GB1033	MSM10014	14 x 26	B	26-1/4	14-3/4	4-9/16	4
M041C010U	MSM100EZ	9 x 30U	C	30	9-3/4	5-3/16	4
M051C010	MSM100930	9 x 30	B	30	9-3/4	5-3/16	2
M051G	MSM100930	9 x 30	B	30	9-3/4	5-3/16	2
M055C010	MSM100930	9 x 30	B	30	9-3/4	5-3/16	2
M055C010U	MSM100EZ	9 x 30U	C	30	9-3/4	5-3/16	3
M055C033	MSM100930	9 x 30	B	30	9-3/4	5-3/16	2
M055C033U	MSM100EZ	9 x 30U	C	30	9-3/4	5-3/16	3
M055G	MSM100930	9 x 30	B	30	9-3/4	5-3/16	2
M055GP6033	MSM100930	9 x 30	B	30	9-3/4	5-3/16	2
M075C010U	MSM100EZ	9 x 30U	C	30	9-3/4	5-3/16	4
M076C010	MSM100930	9 x 30	B	30	9-3/4	5-3/16	2
M076C010U	MSM100EZ	9 x 30U	C	30	9-3/4	5-3/16	3
M076C033	MSM100930	9 x 30	B	30	9-3/4	5-3/16	2
M355C010U	MSM100EZ	9 x 30U	C	30	9-3/4	5-3/16	4
R011C010	MSR100930	9 x 30	B	30	9-3/4	5-3/16	2
R011C010U	MSM100EZ	9 x 30U	C	30	9-3/4	5-3/16	3
R011G	MSR100930	9 x 30	B	30	9-3/4	5-3/16	2
R031C010U	MSM100EZ	9 x 30U	C	30	9-3/4	5-3/16	4
R036C010	MSR100930	9 x 30	B	30	9-3/4	5-3/16	2
R036G	MSR100930	9 x 30	B	30	9-3/4	5-3/16	2
R038C010	MSR100930	9 x 30	B	30	9-3/4	5-3/16	2
R038C010U	MSM100EZ	9 x 30U	C	30	9-3/4	5-3/16	3
R038C033	MSR100930	9 x 30	B	30	9-3/4	5-3/16	2
R038C033U	MSM100EZ	9 x 30U	C	30	9-3/4	5-3/16	3
R038CP4010	MSR100EZ	9 PT	B	30	9-3/4	5-3/16	2
R038CP4033	MSR100EZ	9 PT	B	30	9-3/4	5-3/16	2
R038G	MSR100930	9 x 30	B	30	9-3/4	5-3/16	2
R038GU	MSM100EZ	9 x 30U	C	30	9-3/4	5-3/16	3
R055C010	MSR100930	9 x 30	B	30	9-3/4	5-3/16	2
R055C010U	MSM100EZ	9 x 30U	C	30	9-3/4	5-3/16	3
R055C033	MSR100930	9 x 30	B	30	9-3/4	5-3/16	2
R055C033U	MSM100EZ	9 X 30U	C	30	9-3/4	5-3/16	3
R055G	MSR100930	9 x 30	B	30	9-3/4	5-3/16	2
R075C010U	MSM100EZ	9 x 30U	C	30	9-3/4	5-3/16	4
R076C010	MSR100930	9 x 30	B	30	9-3/4	5-3/16	2
R076C010U	MSM100EZ	9 x 30U	C	30	9-3/4	5-3/16	3
R076C033	MSR100930	9 X 30	B	30	9-3/4	5-3/16	2

¹ Enclosure Styles on page 9-10.

² Knockout Figures on page 9-11.

Technical Data

Model Number	Replacement Parts	Cabinet Size	Enclosure Style ¹	Cabinet Dimensions (inches)			Knockout Figure ²
	Meter Socket			Height (A)	Width (B)	Depth (C)	
U030	—	5 x 7	A	7-1/8	5-3/4	5-3/16	1
U036C010	—	6 x 14	A	14-3/8	6-3/4	5-3/16	1
U036C033	—	6 x 14	A	14-3/8	6-3/4	5-3/16	1
U036G	—	6 x 14	A	14-3/8	6-3/4	5-3/16	1
U038C010	—	9 x 17	A	17-3/8	9-3/4	5-3/16	2
U038C033	—	9 x 17	A	17-3/8	9-3/4	5-3/16	2
U038CTL010	—	9 x 17	A	17-3/8	9-3/4	5-3/16	2
U038CTL033	—	9 x 17	A	17-3/8	9-3/4	5-3/16	2
U038G	—	9 x 17	A	17-3/8	9-3/4	5-3/16	2
U038G033	—	9 x 17	A	17-3/8	9-3/4	5-3/16	2
U039G6	—	9 x 21	D	21	9-3/4	5-3/16	5
U051C	—	6 x 14	A	14-3/8	6-3/4	5-3/16	1
U051C010	—	6 x 14	A	14-3/8	6-3/4	5-3/16	1
U051C033	—	6 x 14	A	14-3/8	6-3/4	5-3/16	1
U051G	—	6 x 14	A	14-3/8	6-3/4	5-3/16	1
U054C	—	6 x 14	A	14-3/8	6-3/4	5-3/16	1
U055C010P	—	6 x 14	A	14-3/8	6-3/4	5-3/16	1
U055C033	—	6 x 14	A	14-3/8	6-3/4	5-3/16	1
U055G	—	6 x 14	A	14-3/8	6-3/4	5-3/16	1
U072C	—	9 x 17	A	17-3/8	9-3/4	5-3/16	2
U073G	—	9 x 17	A	17-3/8	9-3/4	5-3/16	2
U076C010	—	9 x 17	A	17-3/8	9-3/4	5-3/16	2
U076C033	—	9 x 17	A	17-3/8	9-3/4	5-3/16	2
U076G	—	9 x 17	A	17-3/8	9-3/4	5-3/16	2

¹ Enclosure Styles on page 9-10.
² Knockout Figures on page 9-11.

Enclosure Styles / Cabinet Dimensions

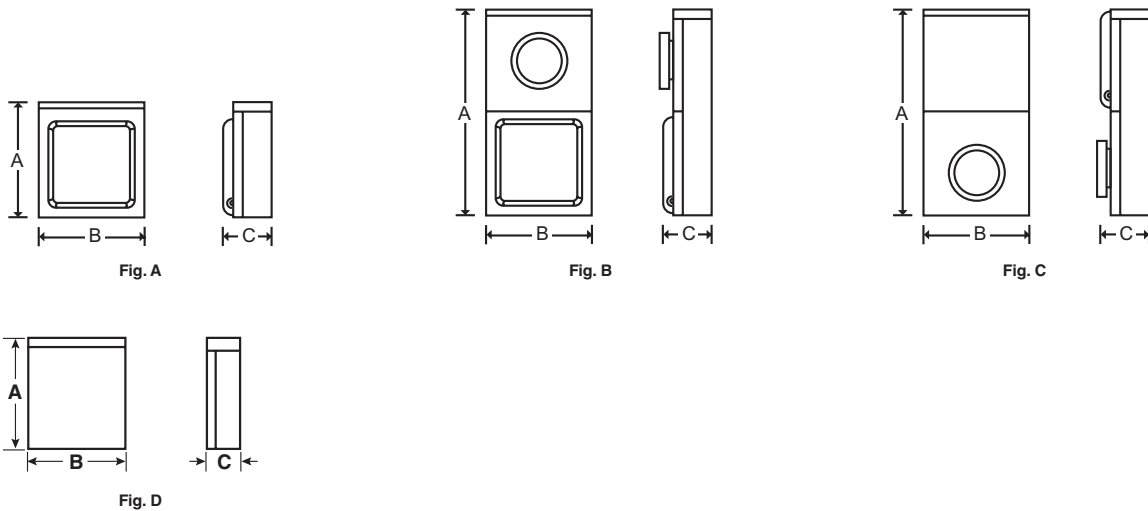

Knockout Configurations

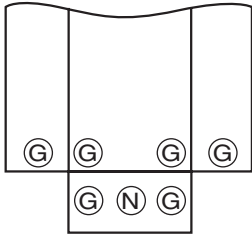

Fig. 1

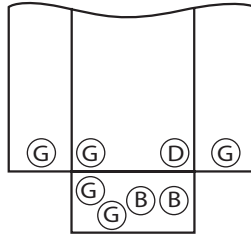

Fig. 2

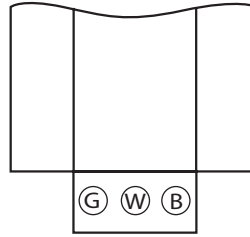

Fig. 3

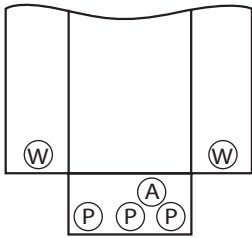

Fig. 4

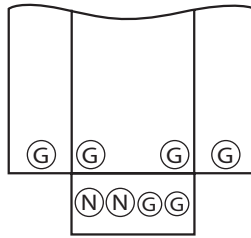

Fig. 5

Knockout Key

- A = 1/2"
- B = 1", 1-1/4", 1-1/2"
- D = 3/4", 1", 1-1/4"
- G = 1/2", 3/4", 1"
- N = 1/2", 3/4", 1", 1-1/4", 1-1/2"
- P = 1/2", 3/4", 1", 1-1/4", 1-1/2", 2", 2-1/2"
- W = 1/2", 3/4", 1", 1-1/4", 2"

* Knockouts shown for size not for exact positions.

Wire Range Tables

AA

Connector	Copper		Aluminum	
	Solid	Strand	Solid	Strand
Line	—	6-1/0	—	6-1/0
Load	14-10	14-10	—	—
Neutral - Large Hole	12-8	12-1/0	10-8	10-1/0
Neutral - Small Hole	14-8	14-4	12-8	12-4
Equipment Ground	12-8	12-2	12-8	12-2

A2

Connector	Copper		Aluminum	
	Solid	Strand	Solid	Strand
Line	—	6-1/0	—	6-1/0
Load	14-10	14-10	—	—
Neutral - Large Hole	12-8	12-1/0	10-8	10-1/0
Neutral - Small Hole	14-8	14-4	12-8	12-4
Equipment Ground	12-8	12-2	12-8	12-2
Post Line Connectors Suitable for Loop Feed	2-250 kcmil		2-250 kcmil	
Equipment Ground	12-2	12-2	12-2	12-2

C

Connector	Copper		Aluminum	
	Solid	Strand	Solid	Strand
Line	—	1-300	—	1-300
Ground - Large Hole	12-8	12-1/0	12-10	10-1/0
Ground - Small Hole	14-8	14-4	12-10	10-1/0
Neutral - Large Hole	14-1/0	14-1/0	14-1/0	14-1/0
Neutral - Small Hole	14-6	14-6	14-6	14-6

G

Connector	Copper	
	Solid	Strand
Line	12-8	12-4
Load	—	—
Neutral	12-8	12-4
Equipment Ground	12-8	12-2

H

Connector	Copper		Aluminum	
	Solid	Strand	Solid	Strand
Line	14-8	14-2	12-8	12-2
Load	14-10	14-10	—	—
Neutral	—	6-350	—	6-350
Neutral	—	1-300	—	1-300
Equipment Ground	12-8	12-2	12-8	12-2

K

Connector	Copper		Aluminum	
	Solid	Strand	Solid	Strand
Line	14-8	14-2	12-8	12-2
Load	14-10	14-10	—	—
Neutral - End Hole	14-8	14-2	12-8	12-2
Neutral - Side Hole	14-8	14-4	12-8	12-4
Equipment Ground	12-8	12-2	12-8	12-2

O

Connector	Copper		Aluminum	
	Solid	Strand	Solid	Strand
Line	14-8	14-2	12-8	12-2
Load	—	—	—	—
Neutral - End Hole	14-8	14-2	12-8	12-2
Neutral - Side Hole	14-8	14-4	12-8	12-4
Equipment Ground	12-8	12-2	12-8	12-2

U

Connector	Copper		Aluminum	
	Solid	Strand	Solid	Strand
Line	14-8	14-1/0	12-8	12-1/0
Load	14-10	14-10	—	—
Neutral - Large Hole	12-8	12-1/0	10-8	10-1/0
Neutral - Small Hole	14-8	14-4	12-8	12-4
Equipment Ground	12-8	12-2	12-8	12-2

V

Connector	Copper		Aluminum	
	Solid	Strand	Solid	Strand
Line	14-8	14-1/0	12-8	12-1/0
Load	—	—	—	—
Neutral - Large Hole	12-8	12-1/0	10-8	10-1/0
Neutral - Small Hole	14-8	14-4	12-8	12-4
Equipment Ground	12-8	12-2	12-8	12-2

X

Connector	Copper		Aluminum	
	Solid	Strand	Solid	Strand
Line	—	6-1/0	—	6-1/0
Load	14-10	14-10	—	—
Neutral	—	6-350	—	6-350
Neutral	—	1-300	—	1-300
Equipment Ground	12-8	12-2	12-8	12-2

Section 10

Power Outlets



Application Information

Portable equipment requiring electricity continues to increase steadily in both number and variety. This creates the need for conveniently located receptacles to provide power for cord connected equipment. Midwest Electric Power Outlets provide one or more receptacles, with or without overcurrent protection, in a single enclosure, eliminating the need for several separately mounted components while providing maximum protection against weather and normal field use. Additionally, many models also include disconnecting, metering, and/or pedestal mounting functions in a single NEMA 3R enclosure/assembly.

Features and Benefits

- NEMA 3R weatherproof construction
- G90 galvanized steel construction for superior corrosion resistance
- Durable polyester powder coat finish resists chipping and fading
- All in one construction for factory assured terminations
- Rolled edge door for cord protection
- Cover design allows cords to exist while maintaining the NEMA 3R integrity
- Wide assortments of concentric knockouts offer flexibility in the installation
- All GFCI duplexes are listed as weather resistant and tamper resistant as required by NEC in Article 406.8 and 406.11
- Padlockable door to help prevent unauthorized access
- Dead front construction prevents accidental contact with live parts
- All components factory wired and assembled



U013



U014C010

Unmetered

Surface, 20 – 30 Amps, 120V

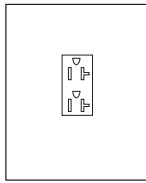

Fig. A
U010
5-20R2

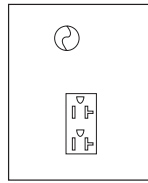

Fig. B
U010F
5-20R2

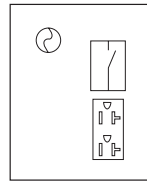

Fig. C
U010H
5-20R2

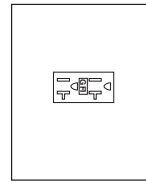

Fig. D
U010SEP
5-20R2GFCI

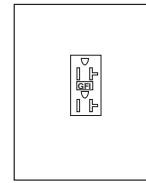

Fig. E
U010010
5-20R2GFCI

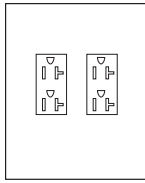

Fig. F
U011
(2) 5-20R2

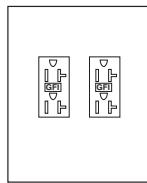

Fig. G
U011010, U012010
(2) 5-20R2GFCI



Fig. H
U013
R32U

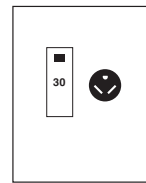

Fig. I
U013C
R32U

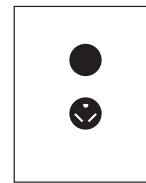

Fig. J
U013F
R32U

Fig.	Model Number	Receptacles	Circuit Protection	Amps	Wire Range*	Cabinet Size	Hub Opening	Load & Neutral Bar	Unit Wt.	Std Pkg.	UL
A	U010	5-20R2	—	20	E	5 x 7	Y	—	4.5	4	cULus
B	U010F	5-20R2	FH2	20	E	5 x 7		—	4.5		
C	U010H	5-20R2	FH2, SP Switch	20	E	5 x 7		—	5		
D	U010SEP	5-20R2GFCI	—	20	E	5 x 7	N	—	4.5		
E	U010010	5-20R2GFCI	—	20	E	5 x 7	Y	—	4.5		
F	U011	(2) 5-20R2	—	20	E	5 x 7		—	4.5		
G	U011010	(2) 5-20R2GFCI	—	20	E	5 x 7		—	4.5		
G	U012010	(2) 5-20R2GFCI	—	20	E	5 x 7	N	—	4.5		
H	U013	R32U	—	30	F	5 x 7	Y	—	4.5		
I	U013C	R32U	THQL1130	30	A	6 x 9		LC31N3	7		
J	U013F	R32U	FH3	30	F	5 x 7		—	4.5		

* Wire Range Table on pages 10-13-10-14.

Unmetered

Surface, 20 – 50 Amps, 120/240V

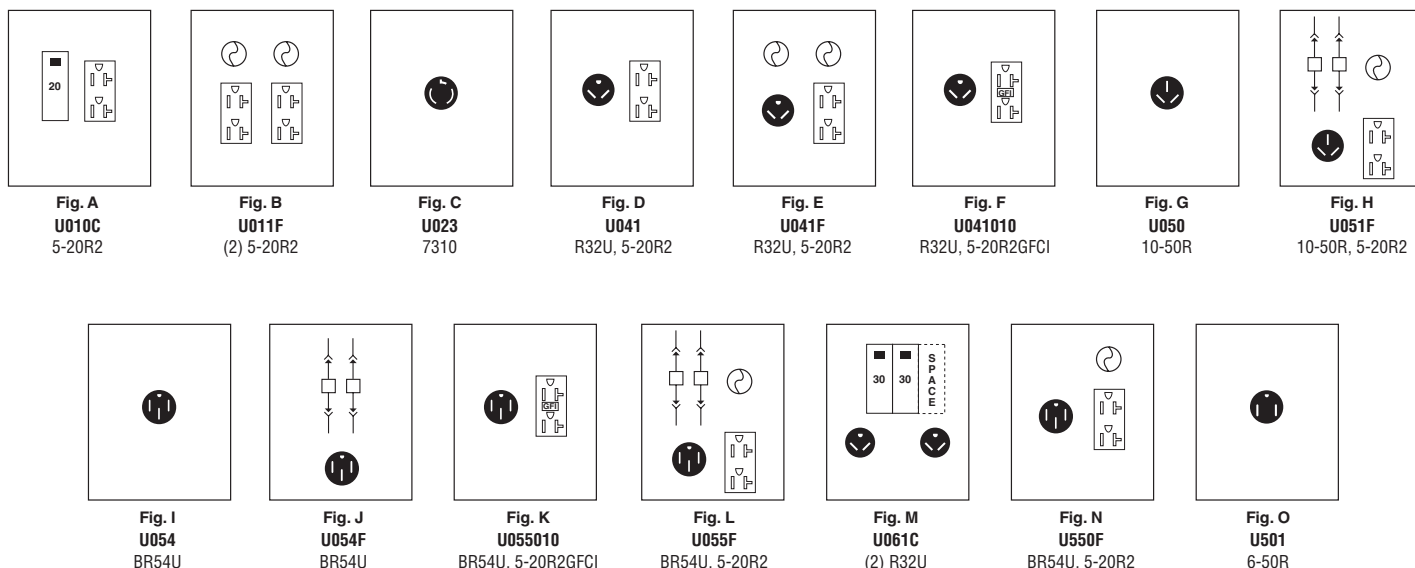

Fig.	Model Number	Receptacles	Circuit Protection	Amps	Wire Range*	Cabinet Size	Hub Opening	Load & Neutral Bar	Unit Wt.	Std Pkg.	UL
A	U010C	5-20R2	THQL1120	20	B	6 x 9	Y	LC31N3	7	4	c(UL)US
B	U011F	(2) 5-20R2	(2) FH2	20	E	6 x 9		—	9		
C	U023	7310	—	20	F	5 x 7		—	4.5		N
D	U041	R32U, 5-20R2	—	30	E	6 x 9		—	6		c(UL)US
E	U041F	R32U, 5-20R2	FH3, FH2	30	E	6 x 9		—	7		
F	U041010	R32U, 5-20R2GFCI	—	30	J	6 x 9		—	9		
G	U050	10-50R	—	50	G	5 x 7		—	4.5		N
H	U051F	10-50R, 5-20R2	FH2	50	K	6 x 14		FR66	10		c(UL)US
I	U054	BR54U	—	50	G	5 x 7		—	5		
J	U054F	BR54U	—	50	O	6 x 14		FR67	10		
K	U055010	BR54U, 5-20R2GFCI	—	50	J	6 x 9		—	9		
L	U055F	BR54U, 5-20R2	—	50	L	6 x 14		FR66, FH2	9		
M	U061C ¹	(2) R32U	(2) THQL1130, Space THQL1120	50	O	6 x 14		LC33N7	10		
N	U550F	BR54U, 5-20R2	FH2	50	M	6 x 14		—	6		

¹ Model number is also suitable for use as temporary site service equipment when installed in accordance with the NEC.
* Wire Range Table on pages 10-13–10-14.

Surface, 50 Amps, 240V

Fig.	Model Number	Receptacles	Circuit Protection	Amps	Wire Range*	Cabinet Size	Hub Opening	Load & Neutral Bar	Unit Wt.	Std Pkg.	UL
O	U501	6-50R	—	50	P	5 x 7	Y	—	5	4	Y

* Wire Range Table on page 10-14.

Unmetered

Surface, 60 – 100 Amps, 120/240V

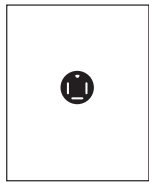

Fig. A
U546
14-60R

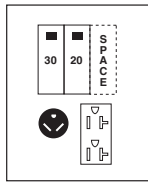

Fig. B
U041C
R32U, 5-20R2

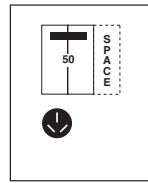

Fig. C
U050C
10-50R

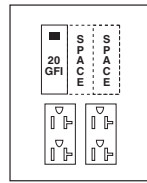

Fig. D
U361G
(2) 5-20R2

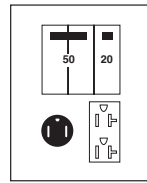

Fig. E
U511C
6-50R, 5-20R2

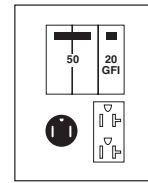

Fig. F
U511G
6-50R, 5-20R2

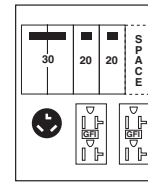

Fig. G
U666C010
10-30R, (2) 5-20R2GFCI

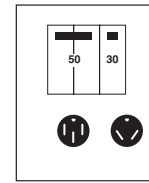

Fig. H
U058C
BR54U, BR32U

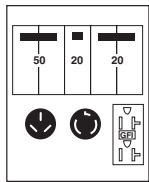

Fig. I
U070C
10-50R, 7310, 5-20R2

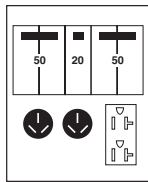

Fig. J
U002C
(2) 10-50R, 5-20R2

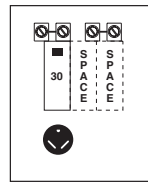

Fig. K
U132CTL
R32U

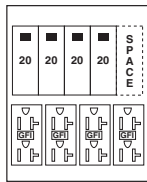

Fig. L
U014C010
(4) 5-20R2GFCI

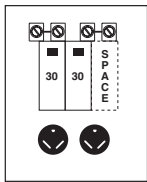

Fig. M
U061CTL
(2) R32U

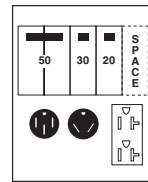

Fig. N
U075C
BR54U, R32U, 5-20R2

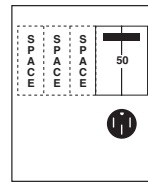

Fig. O
U354C
BR54U

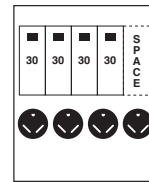

Fig. P
U614C
(2) R32U, (2) BR32U

Fig.	Model Number	Receptacles	Circuit Protection	Amps	Wire Range*	Cabinet Size	Hub Opening	Load & Neutral Bar	Unit Wt.	Std Pkg.	UL
A	U546	14-60R	—	60	G	6 x 9	Y	—	5	4	N
B	U041C	R32U, 5-20R2	THQL1130, THQL1120, Space THQL1120	70	K	6 x 14		LC33N7	10		cULus
C	U050C	10-50R	THQL2150, Space THQL1120	70	O	6 x 14		LC33N7	10		N
D	U361G	(2) 5-20R2	THQL1120GFT	70	K	6 x 14		LC33N7	9		cULus
E	U511C	6-50R, 5-20R2	THQL2150, THQL1120	70	K	6 x 14		LC33N7	10		cULus
F	U511G	6-50R, 5-20R2	THQL2150, THQL1120GFT	70	K	6 x 14		LC33N7	10		cULus
G	U666C010	10-30R, (2) 5-20R2GFCI	THQL2130, (2) THQL1120, Space THQL1120	70	U	9 x 17		LC55N1	16	N	1
H	U058C ¹	BR54U, BR32U	THQL2150, THQL1130	80	V	9 x 17		LC33N1	15	cULus	
I	U070C	10-50R, 7310, 5-20R2	THQL2150, THQL2120, THQL1120	90	U	9 x 17		LC55N1	16	N	
J	U002C	(2) 10-50R, 5-20R2	(2) THQL2150, THQL1120	100	U	14 x 21		LC55N1	31	N	
K	U132CTL	R32U	THQL1130, Space (2) THQL1120	100	V	9 x 17		LC33N1T	11	cULus	
L	U014C010 ²	(4) 5-20R2GFCI	(4) THQL1120, Space THQL1120	100	U	9 x 17		LC55N1	28	cULus	
M	U061CTL	(2) R32U	(2) THQL1130, Space THQL1120	100	O	9 x 17		LC33N1T	14	cULus	
N	U075C	BR54U, R32U, 5-20R2	THQL2150, THQL1130, THQL1120, Space THQL1120	100	U	9 x 17		LC55N1	16	cULus	
O	U354C	BR54U	THQL2150, Space (3) THQL1120	100	V	9 x 17		LC55N1	16	cULus	
P	U614C ¹	(2) R32U, (2) BR32U	(4) THQL1130, Space THQL1120	100	V	14 x 21		LC55N1	30	cULus	

¹ Model number is also suitable for use as temporary site service equipment when installed in accordance with the NEC.

² Earth Burial Model U014CP6010.

* Wire Range Table on page 10-14.

Unmetered

Surface, 100 – 200 Amps, 120/240V

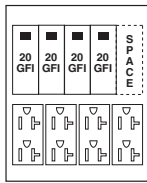

Fig. A
U014GWTR
 (4) 5-20R2GFCI

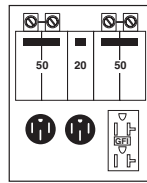

Fig. B
U004CTL010
 (2) BR54U, 5-20R2GFCI

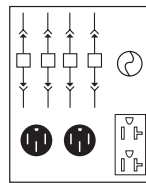

Fig. C
U004F
 (2) BR54U, 5-20R2

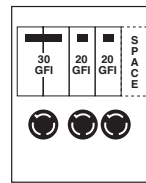

Fig. D
U870G6
 L6-30R, (2) L5-20R

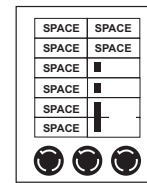

Fig. E
U239G
 L6-30R, (2) L5-20R

Fig.	Model Number	Receptacles	Circuit Protection	Amps	Wire Range*	Cabinet Size	Hub Opening	Load & Neutral Bar	Unit Wt.	Std Pkg.	UL
A	U014GWTR	(4) 5-20R2	(4) THQL1120GFT, Space THQL1120	100	U	9 x 17	Y	LC55N1T	15	1	cULus
B	U004CTL010	(2) BR54U, 5-20R2GFCI	(2) THQL2150, THQL1120	120	U	9 x 17		LC55N1T	17		
C	U004F	(2) BR54U, 5-20R2	FH2	120	U	14 x 21		FR64X2	30		
D	U870G6	L6-30R, (2) L5-20R	THQL2130GFT, (2) THQL1120GFT, Space THQL1120	125	Q	9 x 21		LC1212PC	16		
E	U239G	L6-30R, (2) L5-20R	THQL2130GFT, (2) THQL1120GFT	200	N	14 x 21		LC1212PC	30		

* Wire Range Table on page 10-14.

Metered

Surface, 80 – 100 Amps, 120V/240V

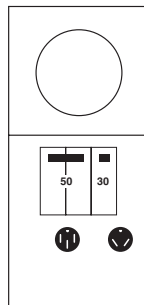

Fig. F
R058C
 BR54U, R32U

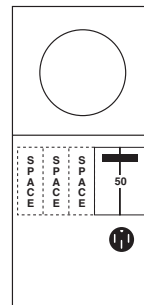

Fig. G
M354C
 BR54U

Fig.	Model Number	Receptacles	Circuit Protection	Amps	Wire Range*	Cabinet Size	Hub Opening	Load & Neutral Bar	Unit Wt.	Std Pkg.	UL
F	R058C ¹	BR54U, R32U	THQL2150, THQL1130	80	AD	9 x 30	Y	LC33N1	25	1	cULus
G	M354C	BR54U	THQL2150, Space (3) THQL1120	100	AD	9 x 30		LC55N1			

¹ Model number is also suitable for use as temporary site service equipment when installed in accordance with the NEC.

* Wire Range Table on page 10-13.

Unmetered

Surface, 20 Amps, 120V

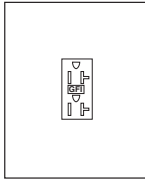

Fig. A
U010010GRP
 5-20R2GFCI

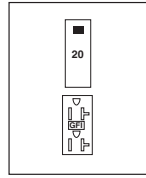

Fig. B
U010C025
 5-20R2GFCI

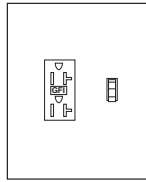

Fig. C
U010S010, U010S010GRP
 5-20R2GFCI, Switch

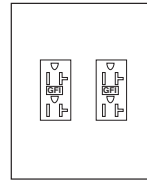

Fig. D
U012010GRP
 (2) 5-20R2GFCI

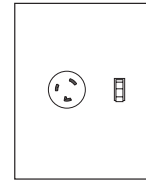

Fig. E
U025S
 L6-20R Twist Lock, Switch

Fig.	Model Number	Receptacles	Number of GFI	Amps	Wire Range*	Cabinet Size	Hub Opening	Enclosure Color	Unit Wt.	Std Pkg.	UL
A	U010010GRP ¹	5-20R2GFCI	1	20	E	5 x 7	N	Camo Green	4	1	cUL ^{us}
B	U010C025	5-20R2GFCI	1	20	BB	6-1/2 x 9	Y		7		
C	U010S010	5-20R2GFCI, Switch	1	20	R	5 x 7	N	Gray	4		
C	U010S010GRP ¹	5-20R2GFCI, Switch	1	20	R	5 x 7	N	Camo Green	3		
D	U012010GRP ¹	(2) 5-20R2GFCI	2	20	J	5 x 7	N	Camo Green	3		

Surface, 20 Amps, 240V

Fig.	Model Number	Receptacles	Number of GFI	Amps	Wire Range*	Cabinet Size	Hub Opening	Enclosure Color	Unit Wt.	Std Pkg.	UL
E	U025S	L6-20R Twist Lock, Switch	—	20	R	5 x 7	N	Gray	4	4	cUL ^{us}

* Wire Range Table on pages 10-13–10-14.

Unmetered

Pedestal, 70 – 80 Amps, 120/240V

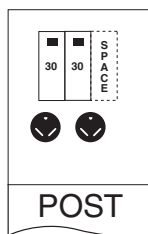

Fig. A
U061CP6
 (2) R32U

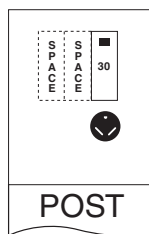

Fig. B
U132CP6
 R32U

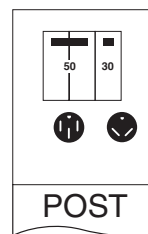

Fig. C
U058CP6
 BR54U, R32U

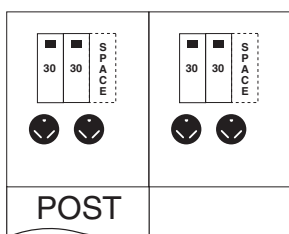

Fig. D
U061CB6
 (2) R32U

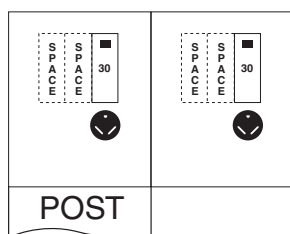

Fig. E
U132CB6
 R32U

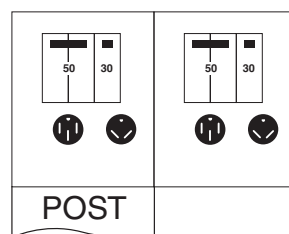

Fig. F
U058CB6
 BR54U, R32U

Fig.	Model Number	Receptacles	Circuit Protection	Amps	Wire Range*	Cabinet Size	Hub Opening	Load & Neutral Bar	Unit Wt.	Std Pkg.	UL
A	U061CP6 ¹	(2) R32U	(2) THQL1130, Space THQL1120	70	AJ	6PT	N	LC33N7	32	1	cULus
B	U132CP6 ¹	R32U	THQL1130, Space (2) THQL1120	70	AH	6PT		LC33N7	48		
C	U058CP6 ¹	BR54U, R32U	THQL2150, THQL1130	80	AG	9PT		LC33N1	20		

Back-to-Back

Fig.	Model Number	Receptacles	Circuit Protection	Amps	Wire Range*	Cabinet Size	Hub Opening	Load & Neutral Bar	Unit Wt.	Std Pkg.	UL
D	U061CB6 ¹	(2) R32U	(2) THQL1130, Space THQL1120	70	AM	6PT	N	LC33N1	46	1	cULus
E	U132CB6 ¹	R32U	THQL1130, Space (2) THQL1120	70	AM	6PT			59		
F	U058CB6	BR54U, R32U	THQL2150, THQL1130	80	AK	9PT			62		

¹ Model number is also suitable for use as temporary site service equipment when installed in accordance with the NEC.

* Wire Range Table on page 10-13.

Metered

Pedestal, 80 – 100 Amps, 120/240V

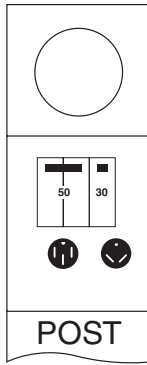

Fig. A
R058CP6
 BR54U, R32U

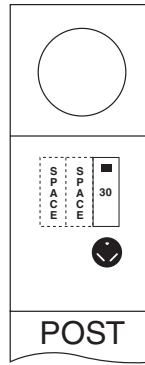

Fig. B
M132CP6
 R32U

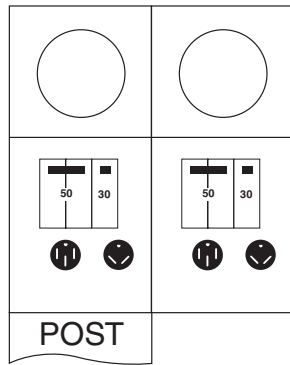

Fig. C
R058CB6
 BR54U, R32U

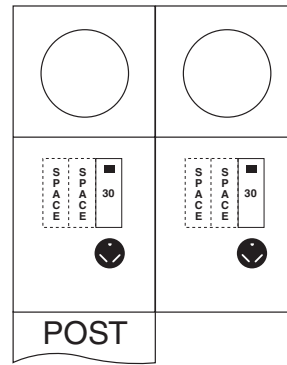

Fig. D
M132CB6
 R32U

Fig.	Model Number	Receptacles	Circuit Protection	Amps	Wire Range*	Cabinet Size	Hub Opening	Load & Neutral Bar	Unit Wt.	Std Pkg.	UL
A	R058CP6 ¹	BR54U, R32U	THQL2150, THQL1130	80	AQ	9PT	N	LC33N1	59	1	UL _{us}
B	M132CP6 ¹	R32U	THQL1130, Space (2) THQL1120	100					56		

Back-to-Back

Fig.	Model Number	Receptacles	Circuit Protection	Amps	Wire Range*	Cabinet Size	Hub Opening	Load & Neutral Bar	Unit Wt.	Std Pkg.	UL
C	R058CB6 ¹	BR54U, R32U	THQL2150, THQL1130	80	AT	9PT	N	LC33N1	82	1	UL _{us}
D	M132CB6 ¹	R32U	THQL1130, Space (2) THQL1120	100	AU						

¹ Model number is also suitable for use as temporary site service equipment when installed in accordance with the NEC.
 * Wire Range Table on page 10-13.

Technical Data

Model Number	Replacement Parts		Cabinet Size	Enclosure Style ¹	Cabinet Dimensions (inches)			Knockout Figure ²
	Meter Socket	Post Lugs			Height (A)	Width (B)	Depth (C)	
M132CB6	MSM100P9	LT100B350	9PT	See page 10-12				
M132CP6	MSM100P9	LT100S350	9PT	See page 10-12				
M354C	—	—	9 x 30	B	30	9-3/4	5-3/16	6
R058C	MSR100930	—	9 x 30	B	30	9-3/4	5-3/16	2
R058CB6	MSR100P9	LT100B350	9PT	See page 10-12				
R058CP6	MSR100P9	LT100S350	9PT	See page 10-12				
U002C	—	—	9 x 17	A	17-3/8	9-3/4	5-3/16	2
U004F	—	—	14 x 21	A	21-3/8	14-3/4	6-7/16	3
U004CTL010	—	—	9 x 17	A	17-3/8	9-3/4	5-3/16	2
U010	—	—	5 x 7	A	7-1/8	5-3/4	5-3/16	4
U010010	—	—	5 x 7	A	7-1/8	5-3/4	5-3/16	4
U010010GRP	—	—	5 x 7	A	7-1/8	5-3/4	5-3/16	4
U010C	—	—	6 x 9	A	9-1/8	7-1/4	5-3/16	1
U010C025	—	—	6-1/2 x 9	A	9-1/8	7-1/4	5-3/16	1
U010F	—	—	5 x 7	A	7-1/8	5-3/4	5-3/16	4
U010H	—	—	5 x 7	A	7-1/8	5-3/4	5-3/16	4
U010SEP	—	—	5 x 7	A	7	5-3/10	5	4
U010S010	—	—	5 x 7	A	7-1/8	5-3/4	5-3/16	4
U010S010GRP	—	—	5 x 7	A	7-1/8	5-3/4	5-3/16	4
U011	—	—	5 x 7	A	7-1/8	5-3/4	5-3/16	4
U011010	—	—	5 x 7	A	7-1/8	5-3/4	5-3/16	4
U011F	—	—	6 x 9	A	9-1/8	7-1/4	5-3/16	1
U012010	—	—	5 x 7	A	7-1/8	5-3/4	5-3/16	4
U012010GRP	—	—	5 x 7	A	7-1/8	5-3/4	5-3/16	4
U013	—	—	5 x 7	A	7-1/8	5-3/4	5-3/16	4
U013C	—	—	6 x 9	A	9-1/8	7-1/4	5-3/16	1
U013F	—	—	5 x 7	A	7-1/8	5-3/4	5-3/16	4
U014C010	—	—	9 x 17	A	17	9-1/2	5-1/5	2
U014CP6010	—	LT100S350	9PT	See page 10-12				
U014GWTR	—	—	9 x 17	A	17	9-1/2	5-1/5	2
U023	—	—	5 x 7	A	7-1/8	5-3/4	5-3/16	4
U025S	—	—	5 x 7	A	7-1/8	5-3/4	5-3/16	4
U041	—	—	6 x 9	A	9-1/8	7-1/4	5-3/16	1
U041010	—	—	6 x 9	A	9-1/8	7-1/4	5-3/16	1
U041C	—	—	6 x 14	A	14-3/8	7-1/4	5-3/16	1
U041F	—	—	6 x 9	A	9-1/8	7-1/4	5-3/16	1
U050	—	—	5 x 7	A	7-1/8	5-3/4	5-3/16	4
U050C	—	—	6 x 14	A	14-3/8	7-1/4	5-3/16	1
U051F	—	—	6 x 14	A	14-3/8	7-1/4	5-3/16	1
U054	—	—	5 x 7	A	7-1/8	5-3/4	5-3/16	4
U054F	—	—	6 x 14	A	14-3/8	7-1/4	5-3/16	1
U055010	—	—	6 X 9	A	9-1/8	7-1/4	5-3/16	1
U055F	—	—	6 x 14	A	14-3/8	7-1/4	5-3/16	1
U058C	—	—	9 x 17	A	17-3/8	9-1/4	5-3/16	2
U058CB6	—	LT100B350	9PT	See page 10-12				
U058CP6	—	LT100S350	9PT	See page 10-12				
U061C	—	—	6 x 14	A	14-3/8	7-1/4	5-3/16	1
U061CB6	—	LT100B350	6PT	See page 10-12				
U061CP6	—	LT100S350	6PT	See page 10-12				
U061CTL	—	—	9 x 17	A	17-3/8	9-3/4	5-3/16	2
U070C	—	—	9 x 17	A	17-3/8	9-3/4	5-3/16	2
U075C	—	—	9 x 17	A	17-3/8	9-3/4	5-3/16	2
U132CB6	—	LT100B350	6PT	See page 10-12				
U132CP6	—	LT100S350	6PT	See page 10-12				
U132CTL	—	—	9 x 17	A	17-3/8	9-1/4	5-3/16	2

¹ Enclosure Styles on page 10-11.
² Knockout Figures on page 10-11.

Data subject to change without notice.

Technical Data

Power Outlets

Model Number	Replacement Parts		Cabinet Size	Enclosure Style ¹	Cabinet Dimensions (inches)			Knockout Figure ²
	Meter Socket	Post Lugs			Height (A)	Width (B)	Depth (C)	
U239G	—	—	14 x 21	A	21-3/8	14-1/4	6-7/16	3
U354C	—	—	9 x 17	A	17-3/8	9-3/4	5-3/16	2
U361G	—	—	6 x 14	A	14-3/8	7-1/4	5-3/16	1
U501	—	—	5 x 7	A	7-1/8	5-3/4	5-3/16	4
U511C	—	—	6 x 14	A	14-3/8	7-1/4	5-3/16	1
U511G	—	—	6 x 14	A	14-3/8	7-1/4	5-3/16	1
U546	—	—	6 x 9	A	9-1/8	7-1/4	5-3/16	1
U550F	—	—	6 x 14	A	14-3/8	7-1/4	5-3/16	1
U614C	—	—	14 x 21	A	21-3/8	14-3/4	6-7/16	3
U666C010	—	—	9 x 17	A	17-3/8	9-3/4	5-3/16	2
U870G6	—	—	9 x 21	A	21-5/8	9-1/2	4-3/4	5

¹ Enclosure Styles see below.
² Knockout Figures see below.

Enclosure Styles / Cabinet Dimensions

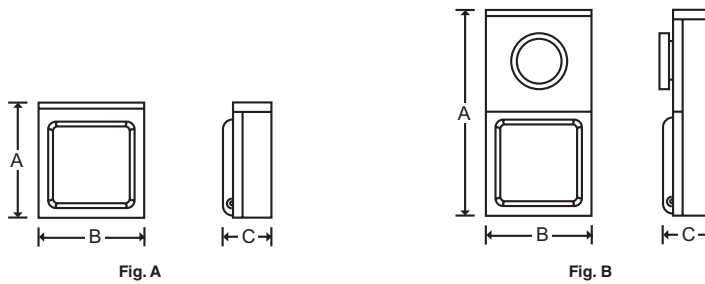

Knockout Configurations

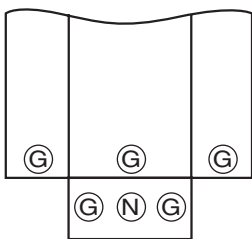

Fig. 1

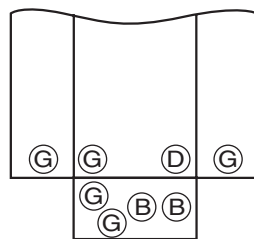

Fig. 2

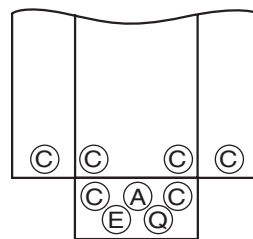

Fig. 3

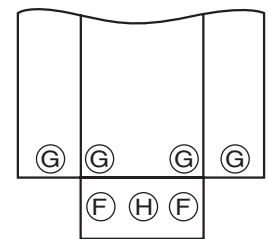

Fig. 4

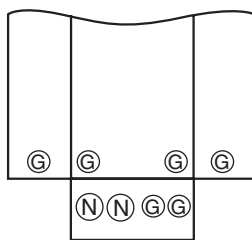

Fig. 5

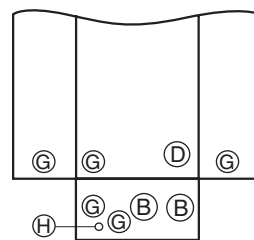

Fig. 6

Knockout Key

- A = 1-1/2", 2", 2-1/2"
- B = 1", 1-1/4", 1-1/2"
- C = 1-1/4", 1-1/2", 2"
- D = 3/4", 1", 1-1/4"
- E = 3/4"
- F = 1/2", 3/4"
- G = 1/2", 3/4", 1"
- H = 1/2", 3/4", 1", 1-1/4"
- N = 1/2", 3/4", 1", 1-1/4", 1-1/2"
- Q = 1"

* Knockouts shown for size not for exact positions.

Data subject to change without notice.

Post Dimensions

Earth Burial

6PT

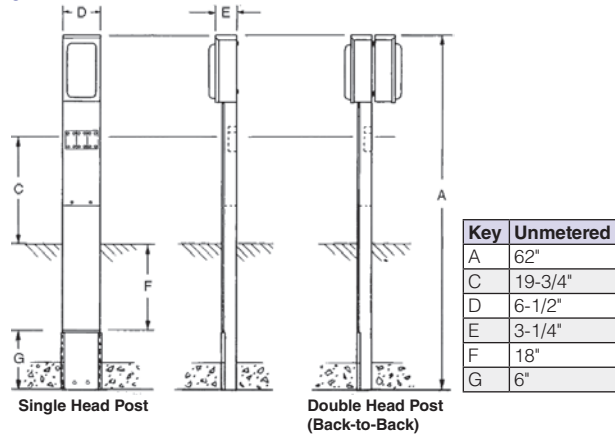

Pad Mount

6PT

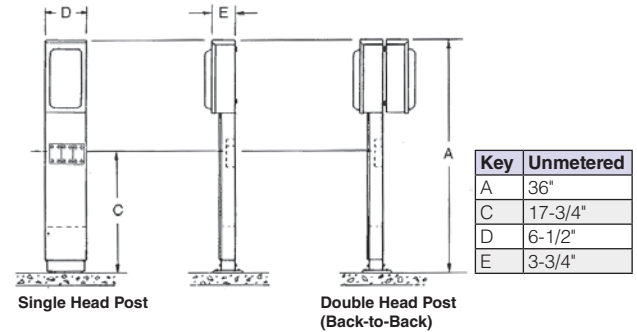

9PT

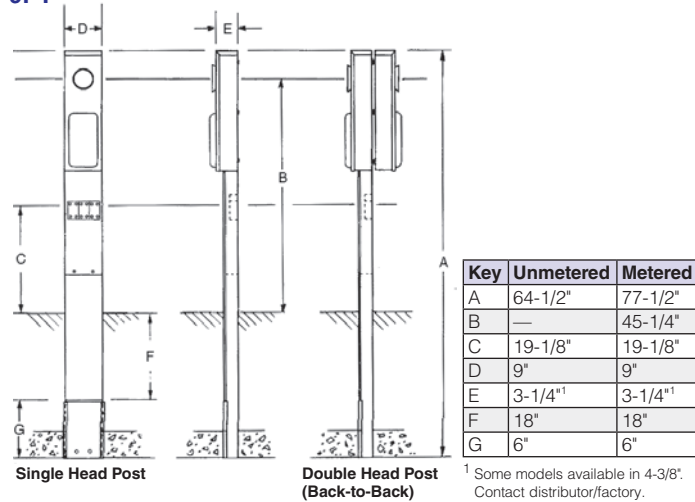

9PT

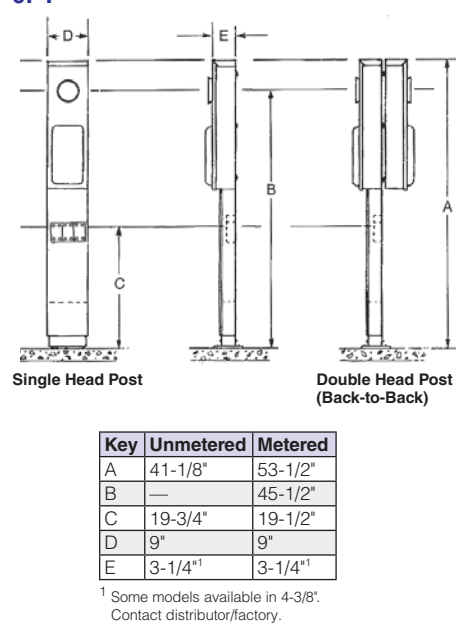

14PT

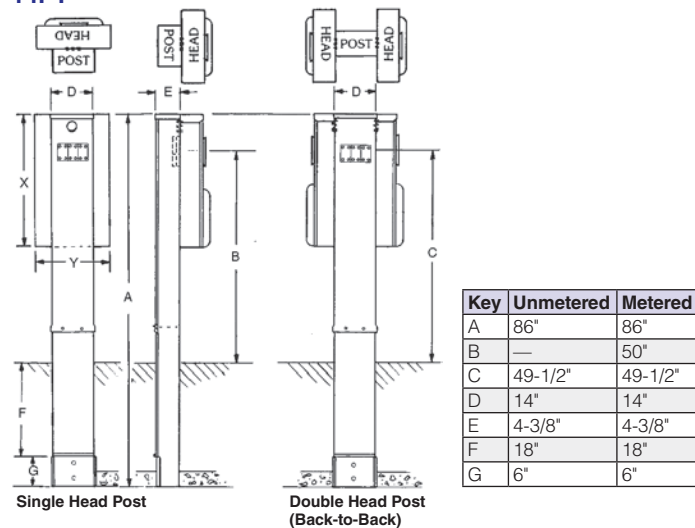

Dimensions Key

- A = Post Length
- B = Meter Center to Grade
- C = Terminal Bar to Grade
- D = Post Width
- E = Post Depth
- F = Grade to Wire Opening
- G = Wire Opening

Wire Range Tables

A

Connector	Copper		Aluminum	
	Solid	Strand	Solid	Strand
Line	14-8	14-6	12-8	12-6
Load	—	—	—	—
Neutral	12-8	12-6	12-8	12-6
Equipment Ground	12-8	12-2	12-8	12-2

AD

Connector	Copper		Aluminum	
	Solid	Strand	Solid	Strand
Line	—	6-1/0	—	6-1/0
Load	—	—	—	—
Neutral - Large Hole	12-8	12-1/0	10-8	10-1/0
Neutral - Small Hole	14-8	14-4	12-8	12-4
Equipment Ground	12-8	12-2	12-8	12-2

AG

Connector	Copper		Aluminum	
	Solid	Strand	Solid	Strand
Line	14-8	14-1/0	12-8	12-1/0
Load	—	—	—	—
Neutral	14-4	14-4	14-4	14-4
Equipment Ground- Distribution	12-8	12-2	12-8	12-2
Post Line Connectors - Loop Feed	1-300 kcmil		1-300 kcmil	
Equipment Ground- Pedestal	12-2	12-2	12-2	12-2

AH

Connector	Copper		Aluminum	
	Solid	Strand	Solid	Strand
Line	14-8	14-2	12-8	12-2
Load	—	—	—	—
Neutral	14-4	14-4	14-4	14-4
Equipment Ground- Distribution	12-8	12-2	12-8	12-2
Post Line Connectors - Loop Feed	1-300 kcmil		1-300 kcmil	
Equipment Ground- Pedestal	12-2	12-2	12-2	12-2

AJ

Connector	Copper		Aluminum	
	Solid	Strand	Solid	Strand
Line	14-8	14-2	12-8	12-2
Load	—	—	—	—
Neutral - End Hole	14-8	14-2	12-8	12-2
Neutral - Side Hole	14-8	14-4	12-8	12-4
Equipment Ground- Distribution	12-8	12-2	12-8	12-2
Post Line Connectors - Loop Feed	14-1/0		14-1/0	
Equipment Ground- Pedestal	12-2	12-2	12-2	12-2

AK

Connector	Copper		Aluminum	
	Solid	Strand	Solid	Strand
Line	14-8	14-1/0	12-8	12-1/0
Load	—	—	—	—
Neutral	12-8	12-1/0	10-8	10-1/0
Neutral	14-8	14-4	12-8	12-4
Equipment Ground- Distribution	12-8	12-2	12-8	12-2
Post Line Connectors - Loop Feed	6-350 kcmil		6-350 kcmil	
Equipment Ground- Pedestal	12-2	12-2	12-2	12-2

AM

Connector	Copper		Aluminum	
	Solid	Strand	Solid	Strand
Line	14-8	14-2	12-8	12-2
Load	—	—	—	—
Neutral - End Hole	14-8	14-2	12-8	12-2
Neutral - Side Hole	14-8	14-4	12-8	12-4
Equipment Ground- Distribution	12-8	12-2	12-8	12-2
Post Line Connectors - Loop Feed	2-250 kcmil		2-250 kcmil	
Equipment Ground- Pedestal	12-2	12-2	12-2	12-2

AQ

Connector	Copper		Aluminum	
	Solid	Strand	Solid	Strand
Line	—	6-1/0	—	6-1/0
Load	—	—	—	—
Neutral	14-4	14-4	14-4	14-4
Equipment Ground- Distribution	12-8	12-2	12-8	12-2
Post Line Connectors - Loop Feed	1-300 kcmil		1-300 kcmil	
Equipment Ground- Pedestal	12-2	12-2	12-2	12-2

AT

Connector	Copper		Aluminum	
	Solid	Strand	Solid	Strand
Line	—	6-1/0	—	6-1/0
Load	—	—	—	—
Neutral	12-8	12-1/0	10-8	10-1/0
Neutral	14-8	14-4	12-8	12-4
Equipment Ground- Distribution	12-8	12-2	12-8	12-2
Post Line Connectors - Loop Feed	6-350 kcmil		6-350 kcmil	
Equipment Ground- Pedestal	12-2	12-2	12-2	12-2

AU

Connector	Copper		Aluminum	
	Solid	Strand	Solid	Strand
Line	—	6-1/0	—	6-1/0
Load	—	—	—	—
Neutral	12-8	12-1/0	10-8	10-1/0
Neutral	14-8	14-4	12-8	12-4
Equipment Ground- Distribution	12-8	12-2	12-8	12-2
Post Line Connectors - Loop Feed	2-250 kcmil		2-250 kcmil	
Equipment Ground- Pedestal	12-2	12-2	12-2	12-2

B

Connector	Copper		Aluminum	
	Solid	Strand	Solid	Strand
Line	14-8	14-6	12-8	12-6
Load	14-10	14-10	—	—
Neutral	12-8	12-6	12-8	12-6
Equipment Ground	12-8	12-2	12-8	12-2

E

Connector	Copper	
	Solid	Strand
Line	14-10	14-10
Load	14-10	14-10
Neutral	14-10	14-10
Equipment Ground	12-8	12-2

Wire Range Tables

F

Connector	Copper	
	Solid	Strand
Line	14-10	14-10
Load	—	—
Neutral	14-10	14-10
Equipment Ground	12-8	12-2

G

Connector	Copper	
	Solid	Strand
Line	12-8	12-4
Load	—	—
Neutral	12-8	12-4
Equipment Ground	12-8	12-2

J

Connector	Copper		Aluminum	
	Solid	Strand	Solid	Strand
Line	14-10	14-10	—	—
Load	14-10	14-10	—	—
Neutral	14-10	14-10	—	—
Equipment Ground	12-8	12-2	12-8	12-2

K

Connector	Copper		Aluminum	
	Solid	Strand	Solid	Strand
Line	14-8	14-2	12-8	12-2
Load	14-10	14-10	—	—
Neutral - End Hole	14-8	14-2	12-8	12-2
Neutral - Side Hole	14-8	14-4	12-8	12-4
Equipment Ground	12-8	12-2	12-8	12-2

L

Connector	Copper		Aluminum	
	Solid	Strand	Solid	Strand
Line	14-8	14-3	12-8	12-3
Load	14-10	14-10	—	—
Neutral - End Hole	14-8	14-2	12-8	12-2
Neutral - Side Hole	14-8	14-4	12-8	12-4
Equipment Ground	12-8	12-2	12-8	12-2

M

Connector	Copper	
	Solid	Strand
Line	12-8	12-4
Load	14-10	14-10
Neutral	12-8	12-4
Equipment Ground	12-8	12-2
Line - FH2 Fuseholder	14-10	14-10
Neutral	14-10	14-10

N

Connector	Copper		Aluminum	
	Solid	Strand	Solid	Strand
Line - Meter Socket	—	1-300	—	—
Load - Base Lugs	—	—	—	—
Neutral - Large Single Lug	—	1-300	—	1-300
Neutral - Small Single Lug	14-8	14-1/0	12-8	12-1/0
Neutral - Large Hole	14-8	10-4	—	6-4
Neutral - Small Hole	14-8	12-8	12-8	12-8
Equipment Ground - Large Hole	12-8	12-1/0	12-1/0	10-1/0
Equipment Ground - Small Hole	14-8	14-4	12-10	12-4

O

Connector	Copper		Aluminum	
	Solid	Strand	Solid	Strand
Line	14-8	14-2	12-8	12-2
Load	—	—	—	—
Neutral - End Hole	14-8	14-2	12-8	12-2
Neutral - Side Hole	14-8	14-4	12-8	12-4
Equipment Ground	12-8	12-2	12-8	12-2

P

Connector	Copper	
	Solid	Strand
Line	12-8	12-4
Load	—	—
Neutral	—	—
Equipment Ground	12-8	12-2

Q

Connector	Copper	
	Solid	Strand
Line	14-8	14-1/0
Load	14-10	14-10
Neutral - Large Hole	12-8	12-1/0
Neutral - Small Hole	14-8	14-4
Equipment Ground	12-8	12-2

R

Connector	Copper		Aluminum	
	Solid	Strand	Solid	Strand
Line - Switch	14-10	14-10	—	—
Equipment Ground	12-8	12-2	12-8	12-2
Line - Receptacle	14-10	14-10	—	—
Load - Receptacle	14-10	14-10	—	—
Neutral - Receptacle	14-10	14-10	—	—

U

Connector	Copper		Aluminum	
	Solid	Strand	Solid	Strand
Line	14-8	14-1/0	12-8	12-1/0
Load	14-10	14-10	—	—
Neutral - Large Hole	12-8	12-1/0	10-8	10-1/0
Neutral - Small Hole	14-8	14-4	12-8	12-4
Equipment Ground	12-8	12-2	12-8	12-2

V

Connector	Copper		Aluminum	
	Solid	Strand	Solid	Strand
Line	14-8	14-1/0	12-8	12-1/0
Load	—	—	—	—
Neutral - Large Hole	12-8	12-1/0	10-8	10-1/0
Neutral - Small Hole	14-8	14-4	12-8	12-4
Equipment Ground	12-8	12-2	12-8	12-2

Section 11

RV Park Equipment



RV Park Equipment

Successful camp ground owners provide their campers with the amenities that keep them coming back year after year: fun, recreation, relaxation, clean and well maintained facilities, friendly staff, and last but not least, hassle free RV hookups! That's where Midwest Electric Products comes in. Midwest offers a complete line of RV power outlets designed with both the camper and the campground owner in mind.

Camper Safety

- Designed and tested to stringent UL safety standards
- Personal protection against ground faults is accomplished via GFCI circuit breaker or receptacle (your choice)
- Duplex outlets are weather resistant and tamper resistant
- In-use covers and grade panels prevent cord and incoming cable abrasion
- Painted dead front panel separates the camper from all electrical wiring
- Power units and access panels can be padlocked to prevent unauthorized access/use

Customer Convenience

- RV power outlets are offered with a wide range of receptacle and circuit breaker combinations
- Power heads provide stay-open, in-use cover
- Convenience features include: light, TV, cable and water connections

Installation and Maintenance

- Installation and maintenance ease, durability, and aesthetics
- Factory wired circuit breakers and receptacles
- Surface mounted power heads have ample concentric knockouts
- Pedestal models are equipped with factory installed loop feed lugs to accommodate down-stream power outlets
- All mechanical lugs are rated for copper and aluminum wire, including the factory installed equipment ground lug
- G90 galvanized steel which provides superior corrosion protection and years of trouble free maintenance
- Durable, fade resistant, polyester powder coat paint finish that is baked on for extra protection

If you're a long-time Midwest RV power outlet customer, thank you for your continued business (many of our repeat customers have been buying from Midwest for over thirty years). If you're new to Midwest, welcome. We'll do our best to make you a believer in all Midwest Electric Products.



Metallic RV

ParkMate™



Application Information

Midwest Metallic RV power centers are a cost effective favorite among campground owners seeking to offer the essential amenities to their campers while keeping their upfront and lifetime costs to a minimum. All components are factory assembled and wired to reduce installation time. The power centers are manufactured using heavy gauge galvanized steel that are top-coated with a durable power coat finish for years of maintenance free operation. These dependable power centers are available in either single-sided or double-sided construction and have a variety of circuit protection, receptacles and convenience options available. Mounting options include surface mount, pad mount, or earth burial post. This versatility gives campground owners the features that their campers expect.



Features and Benefits

Rugged Durability

- Rolled edge door for cord protection
- All-in-one construction for factory assured terminations
- G90 galvanized steel construction for superior corrosion and fading resistance
- Welded flange NEMA 3R construction for lasting service in outdoor installations
- 10kAIC

Installation Ease

- All components factory wired and assembled, reducing installation time
- Door has stay open position for user convenience
- All terminals accept copper or aluminum wire for added installation flexibility
- Wide range of receptacle configurations
- Broad range of concentric knockouts to accommodate varied wiring needs
- Post door removable for installation ease

User Safety

- Dead front construction prevents accidental contact with live parts
- Padlock provision to prevent unauthorized access
- GFCI weather and tamper resistant GFI receptacles
- Rolled edge post bottoms to protect incoming service cable



Unmetered

Surface, 20 Amps, 120V

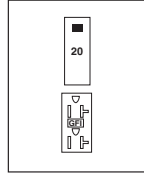

Fig. A
U010C010,
 5-20R2GFCl

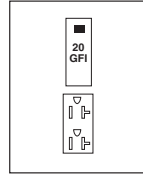

Fig. B
U010G
 5-20R2

Fig.	Model Number	Receptacles	Circuit Protection	Amps	Lug Type	Wire Range*	Cabinet Size	Hub Opening	Load & Neutral Bar	Unit Wt.	Std Pkg.	UL
A	U010C010	5-20R2GFCl	THQL1120	20	Standard	B	6 x 9	Y	—	7	4	Y ¹
B	U010G	5-20R2	THQL1120GFT	20	Standard	B	6 x 9	Y	—	7	4	Y ¹

¹ cULus approved.
 * Wire Range Table on page 11-27.

Surface, 70 – 80 Amps, 120/240V

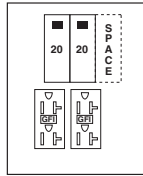

Fig. C
U011C010
 (2) 5-20R2GFCl

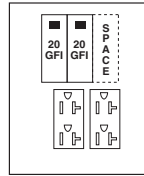

Fig. D
U011G
 (2) 5-20R2

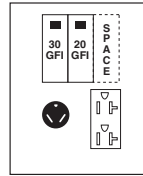

Fig. E
U040G
 R32U, 5-20R2

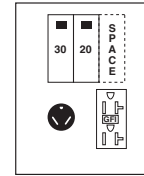

Fig. F
U041C010P
 R32U, 5-20R2GFCl

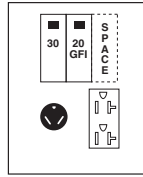

Fig. G
U041G
 R32U, 5-20R2

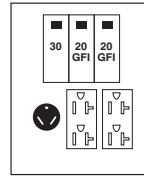

Fig. H
U412G
 BR32U, (2) 5-20R2

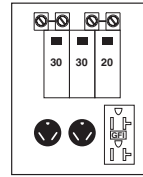

Fig. I
U611CTL010
 (2) BR32U, 5-20R2GFCl

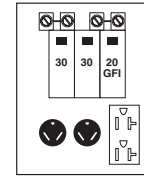

Fig. J
U611GTL
 (2) BR32U, 5-20R2

Fig.	Model Number	Receptacles	Circuit Protection	Amps	Lug Type	Wire Range*	Cabinet Size	Hub Opening	Load & Neutral Bar	Unit Wt.	Std Pkg.	UL
C	U011C010	(2) 5-20R2GFCl	(2) THQL1120, Space THQL1120	70	Standard	P	6 x 14	Y	LC33N7	10	4	Y ¹
D	U011G	(2) 5-20R2	(2) THQL1120GFT, Space THQL1120	70	Standard	P	6 x 14		LC33N7	10	4	
E	U040G	R32U, 5-20R2	THQL1130GFT, THQL1120GFT, Space THQL1120	70	Standard	P	6 x 14		LC33N7	10	4	
F	U041C010P	R32U, 5-20R2GFCl	THQL1130, THQL1120, Space THQL1120	70	Standard	P	6 x 14		LC33N7	10	4	
G	U041G	R32U, 5-20R2	THQL1130, THQL1120GFT, Space THQL1120	70	Standard	P	6 x 14		LC33N7	10	4	
I	U412G	BR32U, (2) 5-20R2	THQL1130, (2) THQL1120GFT	70	Standard	U	9 x 17		LC33N1	16	1	
J	U611CTL010	(2) BR32U, 5-20R2GFCl	(2) THQL1130, THQL1120	80	Loop Feed	W	9 x 17		LC33N1T	16	1	
K	U611GTL	(2) BR32U, 5-20R2	(2) THQL1130, THQL1120GFT	80	Loop Feed	W	9 x 17		LC33N1T	15	1	

¹ cULus approved.
 * Wire Range Table on page 11-27-11-28.

Unmetered

Surface, 100 – 125 Amps, 120/240V

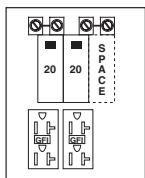

Fig. A
U011CTL010
(2) 5-20R2GFCI

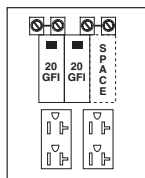

Fig. B
U011GTL
(2) 5-20R2

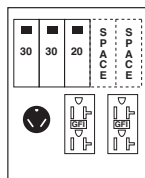

Fig. C
U031C010
R32U, (2) 5-20R2GFCI

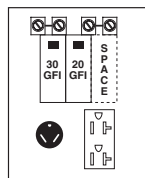

Fig. D
U040GTL
R32U, 5-20R2

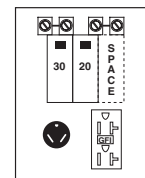

Fig. E
U041CTL010
R32U, 5-20R2GFCI

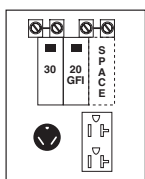

Fig. F
U041GTL
BR32U, 5-20R2

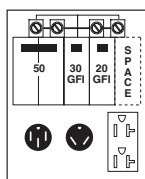

Fig. G
U074GTL
BR54U, R32U, 5-20R2

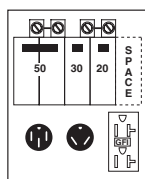

Fig. H
U075CTL010
BR54U, R32U, 5-20R2GFCI

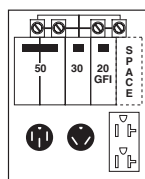

Fig. I
U075GTL
BR54U, R32U, 5-20R2

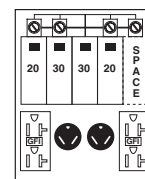

Fig. J
U131CTL010
(2) BR32U, (2) 5-20R2GFCI

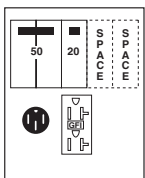

Fig. K
U355C010
BR54U, 5-20R2GFCI

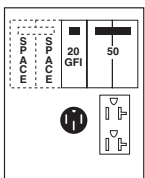

Fig. L
U355G
BR54U, 5-20R2

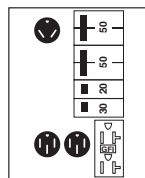

Fig. M
U775C010
(2) 14-50R, BR32U, 5-20R2GFCI

Fig.	Model Number	Receptacles	Circuit Protection	Amps	Lug Type	Wire Range*	Cabinet Size	Hub Opening	Load & Neutral Bar	Unit Wt.	Std Pkg.	UL
A	U011CTL010	(2) 5-20R2GFCI	(2) THQL1120, Space THQL1120	100	Loop Feed	W	9 x 17		LC33N1T	14		Y ¹
B	U011GTL	(2) 5-20R2	(2) THQL1120GFT, Space THQL1120	100	Loop Feed	W	9 x 17		LC33N1T	14		
C	U031C010	R32U, (2) 5-20R2GFCI	THQL1130, (2) THQL1120, Space (2) THQL1120	100	Standard	AA	9 x 17		LC55N1	16		
D	U040GTL	R32U, 5-20R2	THQL1130GFT, THQL1120GFT, Space THQL1120	100	Loop Feed	W	9 x 17		LC33N1T	14		
E	U041CTL010	R32U, 5-20R2GFCI	THQL1130, THQL1120, Space THQL1120	100	Loop Feed	W	9 x 17		LC33N1T	14		
F	U041GTL	BR32U, 5-20R2	THQL1130, THQL1120GFT, Space THQL1120	100	Loop Feed	W	9 x 17		LC33N1T	14		Y
G	U074GTL	BR54U, R32U, 5-20R2	THQL2150, THQL1130GFT, THQL1120GFT, Space THQL1120	100	Loop Feed	W	9 x 17	Y	LC55N1T	16	1	
H	U075CTL010	BR54U, R32U, 5-20R2GFCI	THQL2150, THQL1130, THQL1120, Space THQL1120	100	Loop Feed	W	9 x 17		LC55N1T	16		
I	U075GTL	BR54U, R32U, 5-20R2	THQL2150, THQL1130, THQL1120GFT, Space THQL1120	100	Loop Feed	W	9 x 17		LC55N1T	16		Y ¹
J	U131CTL010	(2) BR32U, (2) 5-20R2GFCI	(2) THQL1130, (2) THQL1120, Space THQL1120	100	Loop Feed	U	14 x 21		LC55N1T	28		
K	U355C010	BR54U, 5-20R2GFCI	THQL2150, THQL1120, (2) Spaces 100A Max	100	Standard	U	9 x 17		LC55N1	16		
L	U355G	BR54U, 5-20R2	THQL2150, THQL1120GFT, (2) Spaces 100A Max	100	Standard	U	9 x 17		LC55N1	15		
M	U775C010	(2) 14-50R, BR32U, 5-20R2GFCI	(2) THQL2150T, THQL1130, THQP120	125	Standard	W	9 x 17		—	15		

¹ cULus approved.

* Wire Range Table on page 11-27-11-28.

Metered

Surface, 70 – 120 Amps, 120/240V

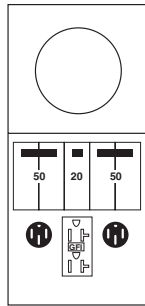

Fig. A
M004C010
(2) BR54U, 5-20R2GFCI

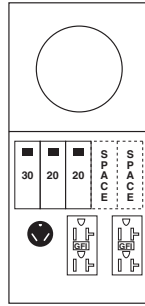

Fig. B
M031C010, R031C010
R32U, (2) 5-20R2GFCI

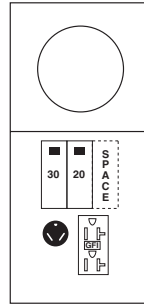

Fig. C
M041C010, R041C010
BR32U, 5-20R2GFCI

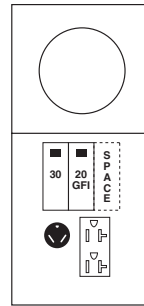

Fig. D
M041G, R041G
BR32U, 5-20R2

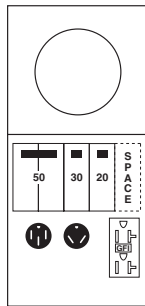

Fig. E
M075C010, R075C010
BR54U, BR32U, 5-20R2GFCI

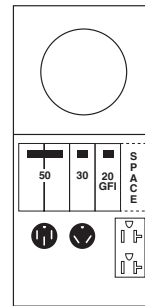

Fig. F
M075G
BR54U, BR32U, 5-20R2

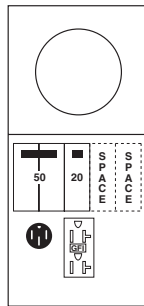

Fig. G
M355C010
BR54U, 5-20R2GFCI

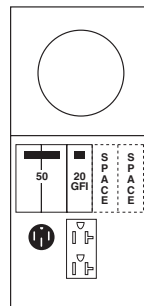

Fig. H
M355G, R355G
BR54U, 5-20R2

Fig.	Model Number		Receptacles	Circuit Protection	Amps	Wire Range*	Cabinet Size	Hub Opening	Load & Neutral Bar	Unit Wt.	Std Pkg.	UL
	Ring Type	Ringless										
A	M004C010	—	(2) BR54U, 5-20R2GFCI	(2) THQL2150, THQL1120	100	AA	9 x 30	Y	LC55N1	26	1	Y ¹
B	M031C010	R031C010	R32U, (2) 5-20R2GFCI	THQL1130, (2) THQL1120, (2) SPACE THQL1120	100				LC55N1	25		
C	M041C010	R041C010	BR32U, 5-20R2GFCI	THQL1130, THQL1120, Space THQL1120	100				LC33N1	24		
D	M041G	R041G	BR32U, 5-20R2	THQL1130, THQL1120GFT, Space THQL1120	100				LC33N1	25		
E	M075C010	R075C010	BR54U, BR32U, 5-20R2GFCI	THQL2150, THQL1130, THQL1120, Space THQL1120	100				LC55N1	25		
F	M075G	—	BR54U, BR32U, 5-20R2	THQL2150, THQL1130, THQL1120GFT, Space THQL1120	100				LC55N1	25		
G	M355C010	—	BR54U, 5-20R2GFCI	THQL2150, THQL1120, (2) Space THQL1120	100				LC55N1	25		
H	M355G	R355G	BR54U, 5-20R2	THQL2150, THQL1120GFT, (2) Space THQL1120	100				LC55N1	25		

¹ cULus approved.

* Wire Range Table on page 11-27.

Unmetered

Pedestal, 30 Amps, 120V

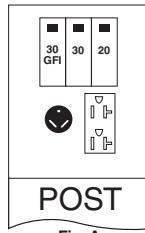

Fig. A
U042GP6
R32U, 5-20R2

Fig.	Model Number		Receptacles	Circuit Protection	Amps	Wire Range*	Cabinet Size	Hub Opening	Load & Neutral Bar	Unit Wt.	Std Pkg.	UL
	Earth Burial	Pad Mount										
A	U042GP6	—	R32U, 5-20R2	THQL1130GFT Main, THQL1130, THQL1120	30	Z	6PT	N	LC33N7	32	1	Y ¹

¹ cULus approved.

* Wire Range Table on page 11-28.

Pedestal, 70 Amps, 120/240V

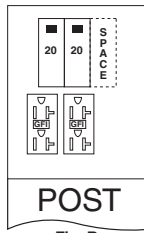

Fig. B
U011CP6010, U011CP4010
(2) 5-20R2GFCI

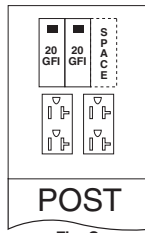

Fig. C
U011GP6, U011GP4
(2) 5-20R2

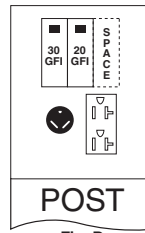

Fig. D
U040GP6, U040GP4
R32U, 5-20R2

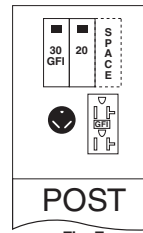

Fig. E
U040GP6010
R32U, 5-20R2GFCI

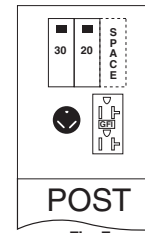

Fig. F
U041CP6010, U041CP4010
R32U, 5-20R2GFCI

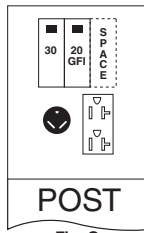

Fig. G
U041GP6, U041GP4
R32U, 5-20R2

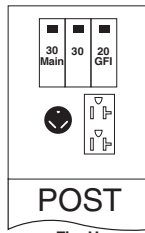

Fig. H
U043GP6
R32U, 5-20R2

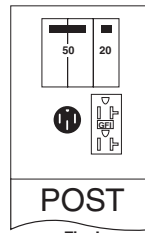

Fig. I
U055CP6010, U055CP4010
BR54U, 5-20R2GFCI

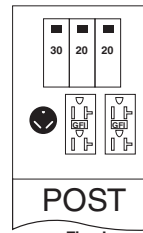

Fig. J
U412CP6010
BR32U, (2) 5-20R2GFCI

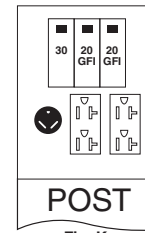

Fig. K
U412GP6
BR32U, (2) 5-20R2

Fig.	Model Number		Receptacles	Circuit Protection	Amps	Wire Range*	Cabinet Size	Hub Opening	Load & Neutral Bar	Unit Wt.	Std Pkg.	UL
	Earth Burial	Pad Mount										
B	U011CP6010	U011CP4010	(2) 5-20R2GFCI	(2) THQL1120, Space THQL1120	70	Z	6PT	N	LC33N7	32	1	Y ¹
C	U011GP6	U011GP4	(2) 5-20R2	(2) THQL1120GFT, Space THQL1120			6PT					
D	U040GP6	U040GP4	R32U, 5-20R2	THQL1130GFT, THQL1120GFT, Space THQL1120			9PT					
E	U040GP6010	—	R32U, 5-20R2GFCI	THQL1130GFT, THQL1120, Space THQL1120			9PT					
F	U041CP6010 ²	U041CP4010 ²	R32U, 5-20R2GFCI	THQL1130, THQL1120, Space THQL1120			6PT					
G	U041GP6	U041GP4	R32U, 5-20R2	THQL1130, THQL1120GFT, Space THQL1120			6PT					
H	U043GP6	—	R32U, 5-20R2	THQL1130, THQL1120GFT, THQL1130 Main			6PT					
I	U055CP6010	U055CP4010	BR54U, 5-20R2GFCI	THQL2150, THQL1120			6PT					
J	U412CP6010	—	BR32U, (2) 5-20R2GFCI	THQL1130, (2) THQL1120			9PT					
K	U412GP6	—	BR32U, (2) 5-20R2	THQL1130, (2) THQL1120GFT			9PT					

¹ cULus approved.

² Available with factory installed TV/Telephone – U041CP6031, U041CP4031. See pages 11-23–11-24 for TV/Telephone model diagrams.

* Wire Range Table on page 11-28.

Data subject to change without notice.

Unmetered

Pedestal, 80 – 125 Amps, 120/240V

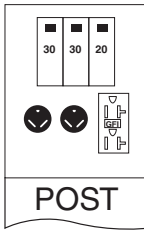

Fig. A
U611CP6010, U611CP4010
(2) BR32U, 5-20R2GFCI

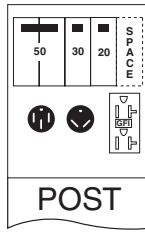

Fig. B
U075CP6010, U075CP4010
BR54U, BR32U, 5-20R2GFCI

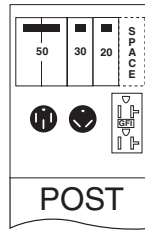

Fig. C
U075CP6010D
BR54U, BR32U, 5-20R2GFCI

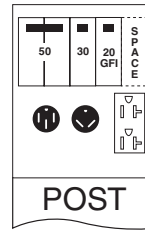

Fig. D
U075GP6, U075GP4
BR54U, BR32U, 5-20R2

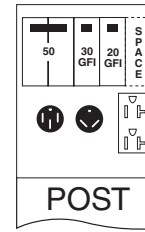

Fig. E
U075GP6019
BR54U, BR32U, 5-20R2

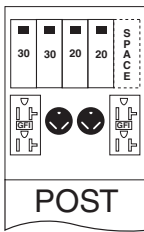

Fig. F
U131CP6010
(2) BR32U, (2) 5-20R2GFCI

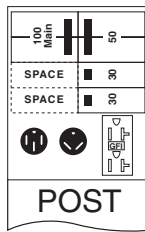

Fig. G
U175CP6HP010
BR54U, BR32U, 5-20R2GFCI

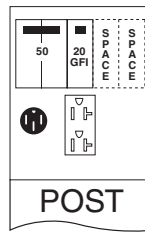

Fig. H
U355GP6
BR54U, 5-20R2

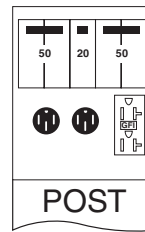

Fig. I
U004CP6010, U004CP4010
(2) BR54U, 5-20R2GFCI

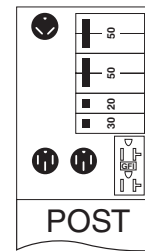

Fig. J
U775CP6010, U775CP4010
(2) 14-50R, BR32U, 5-20R2GFCI

Fig.	Model Number		Receptacles	Circuit Protection	Amps	Wire Range*	Cabinet Size	Hub Opening	Load & Neutral Bar	Unit Wt.	Std Pkg.	UL
	Earth Burial	Pad Mount										
A	U611CP6010	U611CP4010	(2) BR32U, 5-20R2GFCI	(2) THQL1130, THQL1120	80	Z	9PT	N	LC33N1	47	1	Y ¹
B	U075CP6010 ^{2,3,4}	U075CP4010 ^{2,3}	BR54U, BR32U, 5-20R2GFCI	THQL2150, THQL1130, THQL1120, Space THQL1120	100	X	9PT		LC55N1	47		
C	U075CP6010D ⁵	—	BR54U, BR32U, 5-20R2GFCI	THQL2150, THQL1130, THQL1120, Space THQL1120	100	X	9PT		LC55N1	47		
D	U075GP6 ⁷	U075GP4	BR54U, BR32U, 5-20R2	THQL2150, THQL1130, THQL1120GFT	100	Z	9PT		LC55N1	47		
E	U075GP6019	—	BR54U, BR32U, 5-20R2	THQL2150, THQL1130GFT, THQL1120GFT	100	Z	9PT		LC55N1	47		
F	U131CP6010	—	(2) BR32U, (2) 5-20R2GFCI	(2) THQL1130, (2) THQL1120, Space THQL1120	100	Z	14PT		LC55N1	47		
G	U175CP6HP010	—	BR54U, BR32U, 5-20R2GFCI	THQP250 Main, THQL2150, THQL1130, THQL1120	100	W	14PT		198B8627G14	89		
H	U355GP6	—	BR54U, 5-20R2	THQL2150, THQL1120GFT, (2) Space 100A Max	100	Z	9PT		LC55N1	47		
I	U004CP6010 ⁶	U004CP4010 ²	(2) BR54U, 5-20R2GFCI	(2) THQL2150, THQL1120	120	Z	9PT		LC55N1	47		
J	U775CP6010	U775CP4010	(2) 14-50R, BR32U, 5-20R2GFCI	(2) THQP250, THQL1130, THQP120	125	Z	9PT		265A6250G34	97		

¹ cULus approved.

² Available with factory installed TV/Telephone – U075CP6031, U075CP4031, U004CP4031.

See pages 11-23–11-24 for TV/Telephone model diagrams.

³ Available in bronze paint – U075CP6010BZ, U075CP4010Z1.

⁴ Available in tan paint – U075CP6010T.

⁵ Post depth dimension is non-standard (4-3/8”).

⁶ Available with light and GFCI receptacles – U004CP6L10.

⁷ Available with CU conductors – U075GP6C.

* Wire Range Table on page 11-28.

Unmetered

Pedestal, Earth Burial, 125 Amps, 120/208V

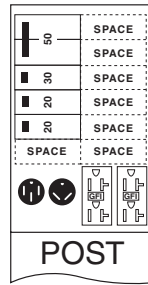

Fig. A
5S3S2S2SES
 BR54U, BR32U, (2) 5-20R2GFCI

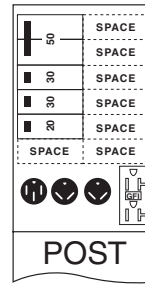

Fig. B
5S3S3S2SES
 BR54U, (2) BR32U, 5-20R2GFCI

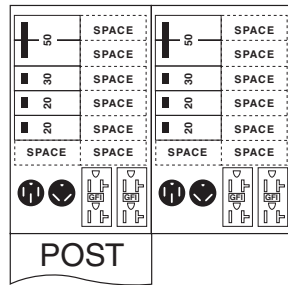

Fig. C
5S3S2S2SEB
 BR54U, BR32U, (2) 5-20R2GFCI

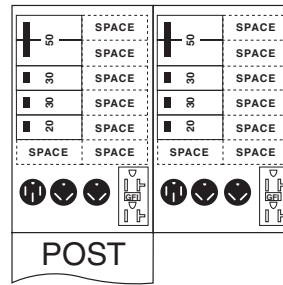

Fig. D
5S3S3S2SEB
 BR54U, (2) BR32U, 5-20R2GFCI

3-Phase

Fig.	Model Number	Receptacles	Circuit Protection	Sides	Amps	Wire Range*	Cabinet Size	Hub Opening	Load & Neutral Bar	Unit Wt.	Std Pkg.	UL
A	5S3S2S2SES	BR54U, BR32U, (2) 5-20R2GFCI	THQL2150, THQL1130, (2) THQL1120	1	125	6-350 kcmil ²	14PT	N	3-Phase, 4 Wire	—	1	Y ¹
B	5S3S3S2SES	BR54U, (2) BR32U, 5-20R2GFCI	THQL2150, (2) THQL1130, THQL1120									

3-Phase, Back-to-Back

Fig.	Model Number	Receptacles	Circuit Protection	Sides	Amps	Wire Range*	Cabinet Size	Hub Opening	Load & Neutral Bar	Unit Wt.	Std Pkg.	UL
C	5S3S2S2SEB	BR54U, BR32U, (2) 5-20R2GFCI	THQL2150, THQL1130, (2) THQL1120	2	125	6-350 kcmil ²	14PT	N	3-Phase, 4 Wire	—	1	Y ¹
D	5S3S3S2SEB	BR54U, (2) BR32U, 5-20R2GFCI	THQL2150, (2) THQL1130, THQL1120									

¹ cULus approved.

² Loop Lugs – Line/Neutral/Ground.

* Wire Range Table on page 11-27.

Unmetered

Pedestal, Back-to-Back, 30 Amps, 120V

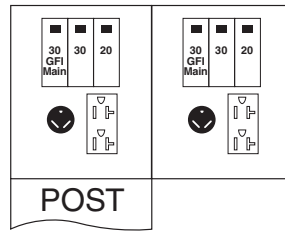

Fig. A
U042GB
R32U, 5-20R2

Fig.	Model Number		Receptacles	Circuit Protection	Amps	Wire Range*	Cabinet Size	Hub Opening	Load & Neutral Bar	Unit Wt.	Std Pkg.	UL
	Earth Burial	Pad Mount										
A	U042GB6	—	R32U, 5-20R2	THQL1130GFT Main, (2) THQL1120	30	Z	6PT	N	LC33N7	47	1	Y ¹

* Wire Range Table on page 11-28.

Pedestal, Back-to-Back, 70 Amps, 120/240V

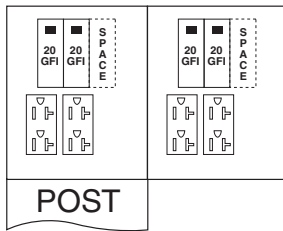

Fig. B
U011GB6, U011GB4
(2) 5-20R2

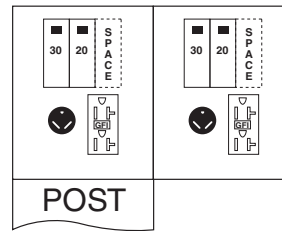

Fig. C
U041CB6010, U041CB4010
R32U, 5-20R2GFCI

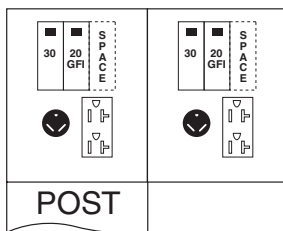

Fig. D
U041GB6, U041GB4
R32U, 5-20R2

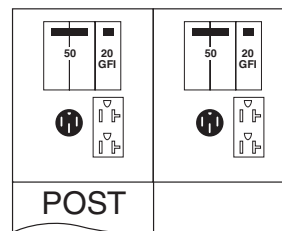

Fig. E
U055GB6
BR54U, 5-20R2

Fig.	Model Number		Receptacles	Circuit Protection	Amps	Wire Range*	Cabinet Size	Hub Opening	Load & Neutral Bar	Unit Wt.	Std Pkg.	UL
	Earth Burial	Pad Mount										
B	U011GB6	U011GB4	(2) 5-20R2	(2) THQL1120GFT, Space THQL1120	70	Z	6PT	N	LC33N7	47	1	Y ¹
C	U041CB6010	U041CB4010	R32U, 5-20R2GFCI	THQL1130, THQL1120, Space THQL1120								
D	U041GB6	U041GB4	R32U, 5-20R2	THQL1130, THQL1120GFT, Space THQL1120								
E	U055GB6	—	BR54U, 5-20R2	THQL2150, THQL1120GFT								

¹ cULus approved.

* Wire Range Table on page 11-28.

Unmetered

Pedestal, Back-to-Back, 80 – 120 Amps, 120/240V

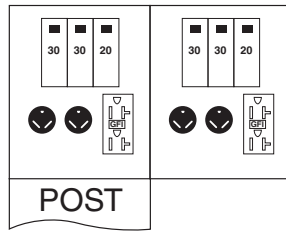

Fig. A

U611CB6010, U611CB4010
(2) R32U, 5-20R2GFCI

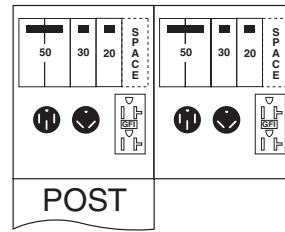

Fig. B

U075CB6010, U075CB4010
BR54U, R32U, 5-20R2GFCI

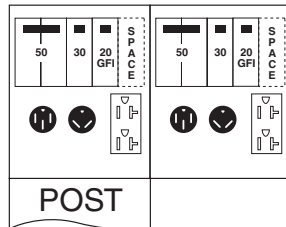

Fig. C

U075GB6
BR54U, R32U, 5-20R2

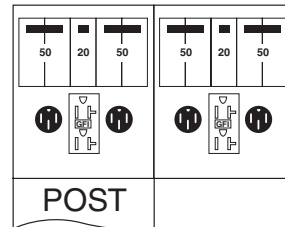

Fig. D

U004CB6010, U004CB4010
(2) BR54U, 5-20R2GFCI

Fig.	Model Number		Receptacles	Circuit Protection	Amps	Wire Range*	Cabinet Size	Hub Opening	Load & Neutral Bar	Unit Wt.	Std Pkg.	UL
	Earth Burial	Pad Mount										
A	U611CB6010	U611CB4010	(2) R32U, 5-20R2GFCI	(2) THQL1130, THQL1120	80	Z	9PT	N	LC33N1	62	1	Y ¹
B	U075CB6010 ²	U075CB4010 ²	BR54U, R32U, 5-20R2GFCI	THQL2150, THQL1130, THQL1120, Space THQL1120	100	S	9PT		LC55N1			
C	U075GB6	—	BR54U, R32U, 5-20R2	THQL2150, THQL1130, THQL1120GFT, Space THQL1120	100	S	9PT		LC55N1			
D	U004CB6010	U004CB4010	(2) BR54U, 5-20R2GFCI	(2) THQL2150, THQL1120	120	S	9PT		LC55N1			

¹ cULus approved.

² Available with factory installed TV/Telephone – U075CB6031, U075CB4031. See pages 11-23–11-24 for TV/Telephone model diagrams.

* Wire Range Table on page 11-27–11-28.

Metered

Pedestal, Earth Burial, 70 – 100 Amps, 120/240V

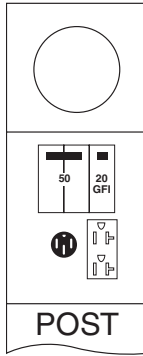

Fig. A
M055GP6
BR54U, 5-20R2

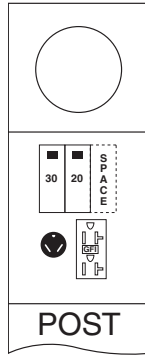

Fig. B
M041CP6010, R041CP6010
R32U, 5-20R2GFCI

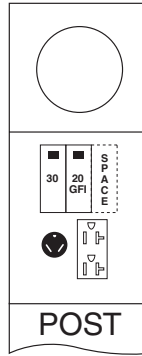

Fig. C
M041GP6, R041GP6
R32U, 5-20R2

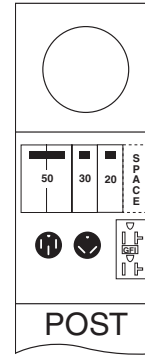

Fig. D
M075CP6010, R075CP6010,
R075CP6010FMG
BR54U, R32U, 5-20R2GFCI

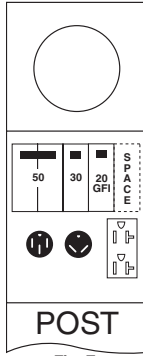

Fig. E
M075GP6, R075GP6
BR54U, R32U, 5-20R2

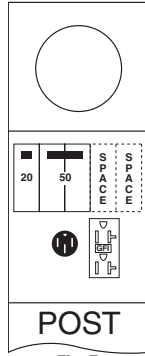

Fig. F
M355CP6010, R355CP6010
BR54U, 5-20R2GFCI

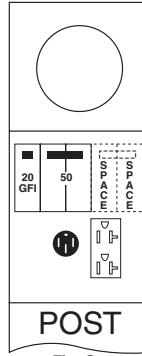

Fig. G
M355GP6, R355GP6
BR54U, 5-20R2

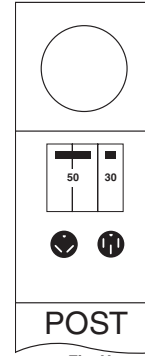

Fig. H
M358CP6
BR54U, R32U

Fig.	Model Number		Receptacles	Circuit Protection	Amps	Wire Range*	Cabinet Size	Hub Opening	Load & Neutral Bar	Unit Wt.	Std Pkg.	UL
	Ring Type	Ringless										
A	M055GP6	—	BR54U, 5-20R2	THQL2150, THQL1120GFT	70	Z	9PT	N	LC33N1	59	1	UL
B	M041CP6010	R041CP6010	R32U, 5-20R2GFCI	THQL1130, THQL1120, Space THQL1120	100	Z		N	LC33N1	53		
C	M041GP6	R041GP6	R32U, 5-20R2	THQL1130, THQL1120GFT, Space THQL1120	100	Z		N	LC33N1	59		
D	M075CP6010 ^{1,2}	R075CP6010, ^{1,3} R075CP6010FMG	BR54U, R32U, 5-20R2GFCI	THQL2150, THQL1130, THQL1120, Space THQL1120	100	Y		N	LC55N1	59	UL, MEG	
E	M075GP6	R075GP6	BR54U, R32U, 5-20R2	THQL1120GFT, Space THQL1120	100	Z		N	LC55N1	59		
F	M355CP6010	R355CP6010 ²	BR54U, 5-20R2GFCI	THQL2150, THQL1120, (2) Space THQL1120	100	Z		Y	LC55N1	59	UL	
G	M355GP6	R355GP6	BR54U, 5-20R2	THQL2150, THQL1120GFT, (2) Space THQL1120	100	Z		N	LC55N1	59		
H	M358CP6	—	BR54U, R32U	THQL2150, THQL1130	100	Z		N	LC55N1	53		

¹ Available with factory installed TV/Telephone – M075CP6031, R075CP6031, R355CP6031. See pages 11-23–11-24 for TV/Telephone model diagrams.

² Available in camo green – M075CP6010GR.

³ Available in bronze finish – R075CP6010Z1.

* Wire Range Table on page 11-28.

Metered

Pedestal, Earth Burial, 120 – 200 Amps, 120/240V

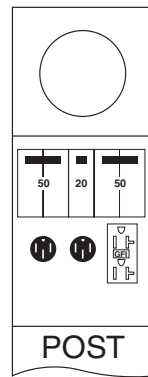

Fig. A
M004CP6010
(2) BR54U, 5-20R2GFCI

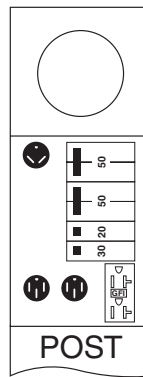

Fig. B
M775CP6010
(2) BR54U, BR32U, 5-20R2GFCI

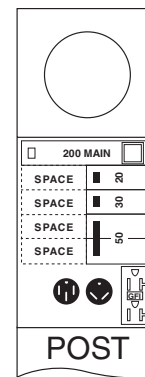

Fig. C
M275CP6010
BR54U, BR32U, 5-20R2GFCI

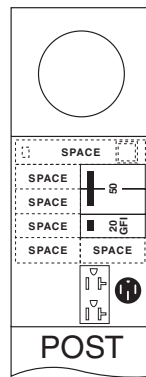

Fig. D
M655GP6
BR54U, 5-20R2

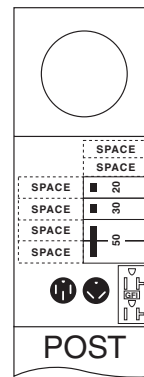

Fig. E
M675CP6010
BR54U, BR32U, 5-20R2GFCI

Fig.	Model Number		Receptacles	Circuit Protection	Amps	Wire Range*	Cabinet Size	Hub Opening	Load & Neutral Bar	Unit Wt.	Std Pkg.	UL
	Ring Type	Ringless										
A	M004CP6010	—	(2) BR54U, 5-20R2GFCI	(2) THQL2150, THQL1120	100	Z	9PT	N	LC55N1	48		
B	M775CP6010	—	(2) BR54U, BR32U, 5-20R2GFCI	(2) THQP250, THQL1130, THQP120	125	Z	9PT	N	—	59		
C	M275CP6010 ²	—	BR54U, BR32U, 5-20R2GFCI	TQDL or equivalent Main, THQL2150, THQL1130, THQL1120	200	BX	14PT	N	LC1212PC	89	1	Y ¹
D	M655GP6	—	BR54U, 5-20R2	THQL2150, THQL1120GFT, Space TQDL or equivalent, Space (5) THQL1120 200A Max	200	Z	14PT	N	LC1212PC	85		
E	M675CP6010	—	BR54U, BR32U, 5-20R2GFCI	THQL2150, THQL1130, THQL1120	200	BY	14PT	N	LC1212PC	87		

¹ cULus approved.

² Available in green paint – order as M275CP6010G1.

* Wire Range Table on page 11-27–11-28.

Metered

Pedestal, Earth Burial, Back-to-Back, 100 – 200 Amps, 120/240V

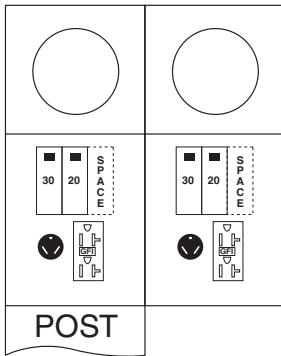

Fig. A
M041CB6010
R32U, 5-20R2GFCI

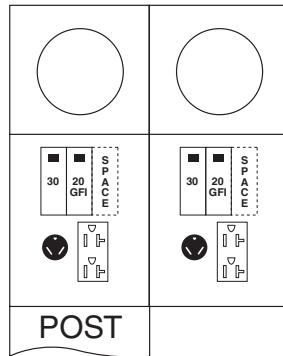

Fig. B
M041GB6, R041GB6
R32U, 5-20R2

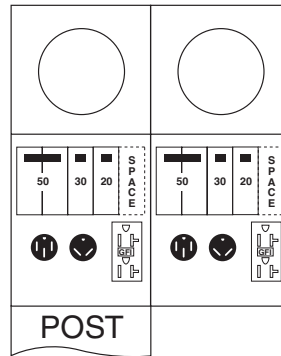

Fig. C
M075CB6010, R075CB6010, R075CB6010FMG
BR54U, R32U, 5-20R2GFCI

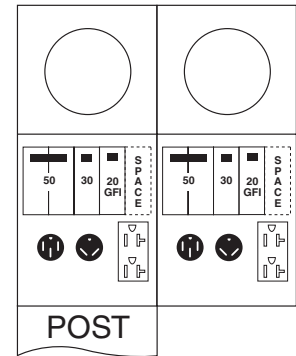

Fig. D
M075GB6, R075GB6
BR54U, R32U, 5-20R2

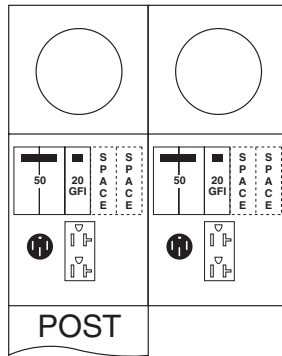

Fig. E
M355GB6
BR54U, 5-20R2

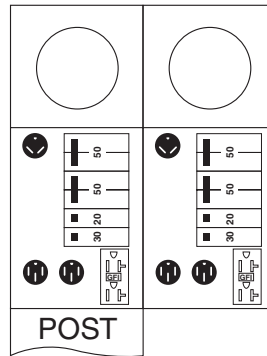

Fig. F
M775CB6010
(2) BR54U, BR32U, 5-20R2GFCI

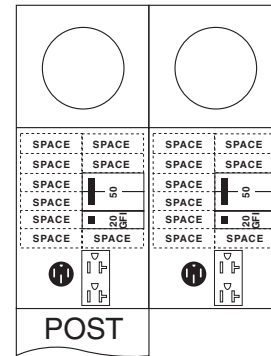

Fig. G
M655GB6
BR54U, 5-20R2

Fig.	Model Number		Receptacles	Circuit Protection	Amps	Wire Range*	Cabinet Size	Hub Opening	Load & Neutral Bar	Unit Wt.	Std Pkg.	UL
	Ring Type	Ringless										
A	M041CB6010	—	R32U, 5-20R2GFCI	THQL1130, THQL1120, Space THQL1120	100	S	9PT	N	LC33N1	82	1	UL US
B	M041GB6	R041GB6	R32U, 5-20R2	THQL1130, THQL1120GFT, Space THQL1120	100		9PT	N	LC33N1	82		
C	M075CB6010 ¹	R075CB6010, R075CB6010FMG	BR54U, R32U, 5-20R2GFCI	THQL2150, THQL1130, THQL1120, Space THQL1120	100		9PT	N	LC55N1	82	1	UL, MEG
D	M075GB6	R075GB6	BR54U, R32U, 5-20R2	THQL2150, THQL1130, THQL1120GFT, Space THQL1120	100		9PT	N	LC55N1	82		
E	M355GB6	—	BR54U, 5-20R2	THQL2150, THQL1120GFT, (2) Space THQP250	100		9PT	N	LC55N1	82	1	UL US
F	M775CB6010	—	(2) BR54U, BR32U, 5-20R2GFCI	(2) THQP250, THQL1130, THQP120	125		9PT	N	—	82		
G	M655GB6	—	BR54U, 5-20R2	THQL2150, THQL1120GFT, (9) Space THQL1120	200		14PT	N	LC12122PC, N1200A4	80		

¹ Available with factory installed TV/Telephone – M075CB6031. See pages 11-23-11-24 for TV/Telephone model diagrams.
* Wire Range Table on page 11-27.

RV Equip – Metallic

Metered

Pedestal, Pad Mount, 100 Amps, 120/240V

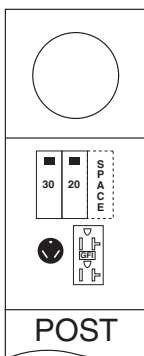

Fig. A
M041CP4010
R32U, 5-20R2GFCI

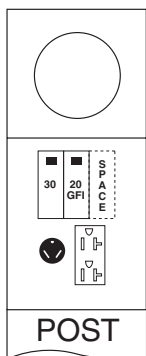

Fig. B
M041GP4
R32U, 5-20R2

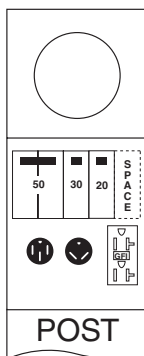

Fig. C
M075CP4010, R075CP4010
BR54U, R32U, 5-20R2GFCI

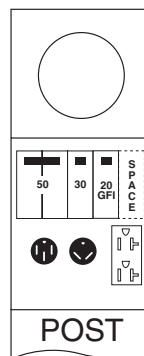

Fig. D
M075GP4
BR54U, R32U, 5-20R2

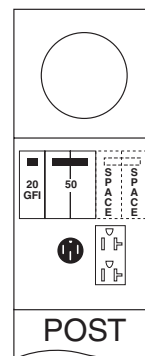

Fig. E
M355GP4
BR54U, 5-20R2

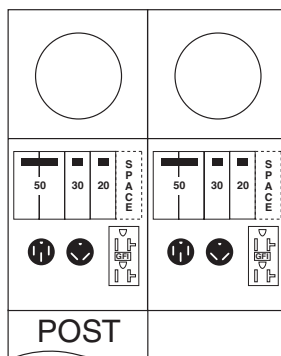

Fig. F
M075CB4010
BR54U, R32U, 5-20R2GFCI

Fig.	Model Number		Receptacles	Circuit Protection	Amps	Wire Range*	Cabinet Size	Hub Opening	Load & Neutral Bar	Unit Wt.	Std Pkg.	UL
	Ring Type	Ringless										
A	M041CP4010	—	R32U, 5-20R2GFCI	THQL1130, THQL1120, Space THQL1120	100	Z	9PT	N	LC33N1	53	1	Y ¹
B	M041GP4	—	R32U, 5-20R2	THQL1130, THQL1120GFT, Space THQL1120					LC33N1	59		
C	M075CP4010	R075CP4010	BR54U, R32U, 5-20R2GFCI	THQL2150, THQL1130, THQL1120, Space THQL1120					LC55N1	59		
D	M075GP4	—	BR54U, R32U, 5-20R2	THQL2150, THQL1130, THQL1120GFT, Space THQL1120					LC55N1	59		
E	M355GP4	—	BR54U, 5-20R2	THQL2150, THQL1120GFT, Space THQP250					LC55N1	59		

Back-to-Back

Fig.	Model Number		Receptacles	Circuit Protection	Amps	Wire Range*	Cabinet Size	Hub Opening	Load & Neutral Bar	Unit Wt.	Std Pkg.	UL
	Ring Type	Ringless										
F	M075CB4010	—	BR54U, R32U, 5-20R2GFCI	THQL2150, THQL1130, THQL1120, Space THQL1120	100	S	9PT	N	LC55N1	82	1	Y ¹

¹ cULus approved.

* Wire Range Table on page 11-27–11-28.

Unmetered

Lighted, Surface 100 Amps, 120/240V

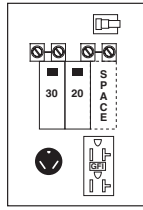

Fig. A
U041CTLL10
 R32U, 5-20R2GFCI

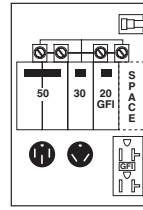

Fig. B
U075CTLL10
 BR32U, R32U, 5-20R2

Fig.	Model Number	Receptacles	Circuit Protection	Amps	Lug Type	Wire Range*	Cabinet Size	Hub Opening	Load & Neutral Bar	Unit Wt.	Std Pkg.	UL
A	U041CTLL10	R32U, 5-20R2GFCI	THQL1130, THQL1120	100	Loop Feed	W	9 x 17	N	LC33N1T	14	1	Y ¹
B	U075CTLL10 ²	BR32U, R32U 5-20R2GFCI	THQL2150, THQL1130, Space THQL1120						LC55N1T	16		

¹ cULus approved.
² Available with light and 50A ground fault breaker – U075CTL035.
 * Wire Range Table on page 11-28.

Light Socket Assembly.

Metered

Lighted, Pedestal, 100 Amps, 120/240V

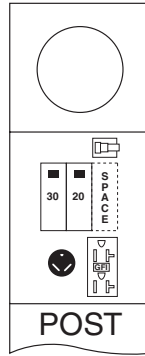

Fig. C
M041CP6L10, M041CP4L10
 R32U, 5-20R2GFCI

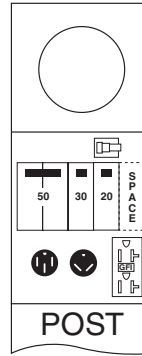

Fig. D
M075CP6L10, M075CP4L10
 BR54U, R32U, 5-20R2GFCI

Fig.	Model Number		Receptacles	Circuit Protection	Amps	Wire Range*	Cabinet Size	Hub Opening	Load & Neutral Bar	Unit Wt.	Std Pkg.	UL
	Earth Burial	Pad Mount										
C	M041CP6L10	M041CP4L10 ²	R32U, 5-20R2GFCI	THQL1130, THQL1120, Space THQL1120	100	Z	9PT	Y	LC33N1	50	1	Y ¹
D	M075CP6L10 ²	M075CP4L10 ²	BR54U, R32U, 5-20R2GFCI	THQL2150, THQL1130, THQL1120, Space THQL1120					LC55N1	59		

¹ cULus approved.
² Available with factory installed TV/Telephone – M041CP4L31, M075CP6L31, M075CP4L31. See pages 11-23–11-24 for TV/Telephone model diagrams.
 * Wire Range Table on page 11-28.

Light Socket Assembly.

Unmetered

Lighted, Pedestal, 70 – 100 Amps, 120/240V

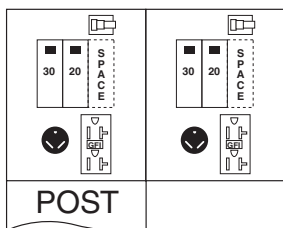

Fig. A
U041CB6L10, U041CB4L10
 R32U, 5-20R2GFC

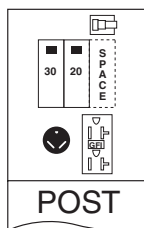

Fig. B
U041CP6L10, U041CP4L10
 R32U, 5-20R2GFCI

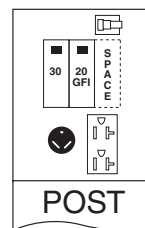

Fig. C
U041GP6L, U041GP4L10
 BR54U, R32U, 5-20R2

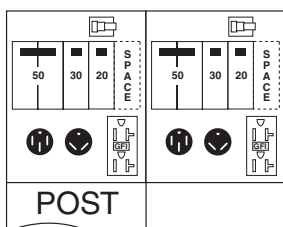

Fig. D
U075CB6L10, U075CB4L10
 BR54U, R32U, 5-20R2GFCI

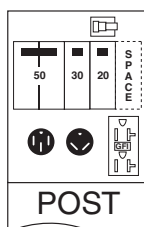

Fig. E
U075CP6L10, U075GP4L10
 BR54U, R32U, 5-20R2GFCI

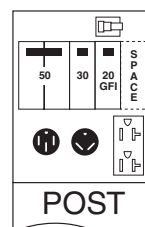

Fig. F
U075GP6L, U075GP4L
 BR54U, R32U, 5-20R2

Fig.	Model Number		Receptacles	Circuit Protection	Amps	Wire Range*	Cabinet Size	Hub Opening	Load & Neutral Bar	Unit Wt.	Std Pkg.	UL
	Earth Burial	Pad Mount										
A	U041CB6L10	U041CB4L10	R32U, 5-20R2GFCI	THQL1130, THQL1120, Space THQL1120	70	Z	6PT	N	LC33N1	42	1	Y ¹
B	U041CP6L10	U041CP4L10	R32U, 5-20R2GFCI	THQL1130, THQL1120, Space THQL1120	70	Z	6PT		LC33N1	30		
C	U041GP6L	U041GP4L	BR54U, R32U, 5-20R2	THQL1130, THQL1120GFT, THQL2150, Space THQL1120	70	Z	6PT		LC33N1	30		
D	U075CB6L10	U075CB4L10	BR54U, R32U, 5-20R2GFCI	THQL1120, Space THQL1120, THQL2150, THQL1130	100	S	9PT		LC55N1	62		
E	U075CP6L10 ^{2,3}	U075CP4L10 ²	BR54U, R32U, 5-20R2GFCI	THQL2150, THQL1130, THQL1120, Space THQL1120	100	Z	9PT		LC55N1	36		
F	U075GP6L	U075GP4L	BR54U, R32U, 5-20R2	THQL2150, THQL1130, THQL1120GFT, Space THQL1120	100	Z	9PT		LC55N1	62		

¹ cULus approved.

² Available with factory installed TV/Telephone – U075CP6L31, U075CP4L31. See pages 11-23–11-24 for TV/Telephone model diagrams.

³ Available with factory installed TV/Telephone, light and bronze finish – U075CP6L31BZ.

* Wire Range Table on page 11-27–11-28.

Light Socket Assembly.

RV Equip – Metallic

Technical Data

Model Number	Replacement Parts		Cabinet Size	Enclosure Style ¹	Cabinet Dimensions (inches) ³			Knockout Figure ²
	Meter Socket	Post Lugs			Height (A)	Width (B)	Depth (C)	
5S3S2S2SEB	—	LT100B350	14PT	—	—	—	—	—
5S3S2S2SES	—	LT100S350	14PT	—	—	—	—	—
5S3S3S2SEB	—	LT100B350	14PT	—	—	—	—	—
5S3S3S2SES	—	LT100S350	14PT	—	—	—	—	—
M004C010	MSM100930	—	9 x 30	B	30	9-3/4	5-3/16	2
M004CP6010	MSM100P9	LT100S350	9PT	—	—	—	—	—
M031C010	MSM100930	—	9 x 30	B	30	9-3/4	5-3/16	2
M041C010	MSM100930	—	9 x 30	B	30	9-3/4	5-3/16	2
M041CB6010	MSM100P9, MSM100HP ⁴	LT100B350	9PT	A	—	—	—	—
M041CP4010	MSM100P9	LT100S350	9PT	—	—	—	—	—
M041CP4L10	MSM100P9	LT100S350	9PT	—	—	—	—	—
M041CP4L31	MSM100P9	LT100S350	9PT	—	—	—	—	—
M041CP6010	MSM100P9	LT100S350	9PT	—	—	—	—	—
M041CP6L10	MSM100P9	LT100S350	9PT	—	—	—	—	—
M041G	MSM100930	—	9 x 30	B	30	9-3/4	5-3/16	2
M041GB6	MSM100P9, MSM100HP ⁴	LT100B350	9PT	A	—	—	—	—
M041GP4	MSM100P9	LT100S350	9PT	—	—	—	—	—
M041GP6	MSM100P9	LT100S350	9PT	—	—	—	—	—
M055GP6	MSM100P9	LT100S350	9PT	—	—	—	—	—
M075C010	MSM100930	—	9 x 30	B	30	9-3/4	5-3/16	2
M075CB4010	MSM100P9, MSM100HP ⁴	LT100B350	9PT	A	—	—	—	—
M075CB6010	MSM100P9, MSM100HP ⁴	LT100B350	9PT	A	—	—	—	—
M075CB6031	MSM100P9, MSM100HP ⁴	LT100B350	9PT	A	—	—	—	—
M075CP4010	MSM100P9	LT100S350	9PT	—	—	—	—	—
M075CP4L10	MSM100P9	LT100S350	9PT	—	—	—	—	—
M075CP4L31	MSM100P9	LT100S350	9PT	—	—	—	—	—
M075CP6010	MSM100P9	LT100S350	9PT	—	—	—	—	—
M075CP6010GR	MSM100P9	LT100S350	9PT	—	—	—	—	—
M075CP6031	MSM100P9	LT100S350	9PT	—	—	—	—	—
M075CP6L10	MSM100P9	LT100S350	9PT	—	—	—	—	—
M075CP6L31	MSM100P9	LT100S350	9PT	—	—	—	—	—
M075G	MSM100930	—	9 x 30	B	30	9-3/4	5-3/16	2
M075GB6	MSM100P9, MSM100HP ⁴	LT100B350	9PT	A	—	—	—	—
M075GP4	MSM100P9	LT100S350	9PT	—	—	—	—	—
M075GP6	MSM100P9	LT100S350	9PT	—	—	—	—	—
M275CP6010	— ⁶	LT200S350	14PT	—	—	—	—	—
M275CP6010G1	— ⁶	LT200S350	14PT	—	—	—	—	—
M355C010	MSM100930	—	9 x 30	B	30	9-3/4	5-3/16	2
M355CP6010	MSM100P9	LT100S350	9PT	—	—	—	—	—
M355G	MSM100930	—	9 x 30	B	30	9-3/4	5-3/16	2
M355GB6	MSM100P9, MSM100HP ⁴	LT100B350	9PT	A	—	—	—	—
M355GP4	MSM100P9	LT100S350	9PT	—	—	—	—	—
M355GP6	MSM100P9	LT100S350	9PT	—	—	—	—	—
M358CP6	MSM100P9	LT100B350	9PT	—	—	—	—	—
M655GB6	MW200M	LT200B350	14PT	—	—	—	—	—
M655GP6	MW200M	LT200S350	14PT	—	—	—	—	—
M675CP6010	— ⁶	LT200S350	14PT	—	—	—	—	—
M775CB6010	MSM100P9, MSM100HP ⁴	LT100B350	9PT	A	—	—	—	—
M775CP6010	MSM100P9	LT100S350	9PT	—	—	—	—	—
R031C010	MSR100930	—	9 x 30	B	30	9-3/4	5-3/16	2
R041C010	MSR100930	—	9 x 30	B	30	9-3/4	5-3/16	2
R041CP6010	MSR100P9	LT100S350	9PT	—	—	—	—	—
R041G	MSR100930	—	9 x 30	B	30	9-3/4	5-3/16	2
R041GB6	MSR100P9, MSR100HP ⁵	LT100B350	9PT	B	—	—	—	—
R041GP6	MSR100P9	LT100S350	9PT	—	—	—	—	—
R075C010	MSR100930	—	9 x 30	B	30	9-3/4	5-3/16	2
R075CB6010	MSR100P9	LT100B350	9PT	—	—	—	—	—

¹ Enclosure Styles on page 11-22.² Knockout Figures on page 11-22.³ Post Cabinet sizes and dimensions on page 11-22.⁴ Front (inline side) – MSM100P9; Back (powerhead side) – MSM100HP.⁵ Front (inline side) – MSR100P9; Back (powerhead side) – MSR100HP.⁶ No replacement meter socket set up in system.

Technical Data

Model Number	Replacement Parts		Cabinet Size	Enclosure Style ¹	Cabinet Dimensions (inches) ³			Knockout Figure ²
	Meter Socket	Post Lugs			Height (A)	Width (B)	Depth (C)	
R075CB6010FMG	MSR100P9	LT100B350	9PT	—	—			—
R075CP4010	MSR100P9	LT100S350	9PT	—	—			—
R075CP6010	MSR100P9	LT100S350	9PT	—	—			—
R075CP6010FMG	MSR100P9	LT100S350	9PT	—	—			—
R075CP6010Z1	MSR100P9	LT100S350	9PT	—	—			—
R075CP6031	MSR100P9	LT100S350	9PT	—	—			—
R075GB6	MSR100P9, MSR100HP ⁴	LT100B350	9PT	B	—			—
R075GP6	MSR100P9	LT100S350	9PT	—	—			—
R355CP6010	MSR100P9	LT100S350	9PT	—	—			—
R355CP6031	MSR100P9	LT100S350	9PT	—	—			—
R355G	MSR100930	—	9 x 30	B	30	9-3/4	5-3/16	2
R355GP6	MSR100P9	—	9PT	—	—			—
U004CB4010	—	LT100B350	9PT	—	—			—
U004CB6010	—	LT100B350	9PT	—	—			—
U004CP4010	—	LT100S350	9PT	—	—			—
U004CP4031	—	LT100S350	9PT	—	—			—
U004CP6010	—	LT100S350	9PT	—	—			—
U004CP6L10	—	LT100S350	9PT	—	—			—
U010C010	—	—	6 x 9	A	9-1/8	7-1/4	5-3/16	1
U010G	—	—	6 x 9	A	9-1/8	7-1/4	5-3/16	1
U011C010	—	—	6 x 14	A	14-3/8	7-1/4	5-3/16	1
U011CP4010	—	LT100S350	6PT	—	—			—
U011CP6010	—	LT100S350	6PT	—	—			—
U011CTL010	—	—	9 x 17	A	17-3/8	9-3/4	5-3/16	2
U011G	—	—	6 x 14	A	14-3/8	7-1/4	5-3/16	1
U011GB4	—	LT100B350	6PT	—	—			—
U011GB6	—	LT100B350	6PT	—	—			—
U011GP4	—	LT100S350	6PT	—	—			—
U011GP6	—	LT100S350	6PT	—	—			—
U011GTL	—	—	9 x 17	A	17-3/8	9-3/4	5-3/16	2
U031C010	—	—	9 x 17	A	17-3/8	9-3/4	5-3/16	2
U040G	—	—	6 x 14	A	14-3/8	7-1/4	5-3/16	1
U040GP4	—	LT100S350	6PT	—	—			—
U040GP6	—	LT100S350	6PT	—	—			—
U040GP6010	—	LT100S350	6PT	—	—			—
U040GTL	—	—	9 x 17	A	17-3/8	9-3/4	5-3/16	2
U041C010P	—	—	6 x 14	A	14-3/8	7-1/4	5-3/16	1
U041CB4010	—	LT100B350	6PT	—	—			—
U041CB4L10	—	LT100B350	6PT	—	—			—
U041CB6010	—	LT100B350	6PT	—	—			—
U041CB6L10	—	LT100B350	6PT	—	—			—
U041CP4010	—	LT100S350	6PT	—	—			—
U041CP4031	—	LT100S350	6PT	—	—			—
U041CP4L10	—	LT100S350	6PT	—	—			—
U041CP6010	—	LT100S350	6PT	—	—			—
U041CP6031	—	LT100S350	6PT	—	—			—
U041CP6L10	—	LT100S350	6PT	—	—			—
U041CTL010	—	—	9 x 17	A	17-3/8	9-3/4	5-3/16	2
U041CTLL10	—	—	9 x 17	A	17-3/8	9-3/4	5-3/16	2
U041G	—	—	6 x 14	A	14-3/8	7-1/4	5-3/16	1
U041GB4	—	LT100B350	6PT	—	—			—
U041GB6	—	LT100B350	6PT	—	—			—
U041GP4	—	LT100S350	6PT	—	—			—
U041GP4L	—	LT100S350	6PT	—	—			—
U041GP6	—	LT100S350	6PT	—	—			—
U041GP6L	—	LT100S350	6PT	—	—			—

¹ Enclosure Styles on page 11-22.

² Knockout Figures on page 11-22.

³ Post Cabinet sizes and dimensions on page 11-22.

⁴ Front (inline side) – MSR100P9; Back (powerhead side) – MSR100HP.

Technical Data

Model Number	Replacement Parts		Cabinet Size	Enclosure Style ¹	Cabinet Dimensions (inches) ³			Knockout Figure ²
	Meter Socket	Post Lugs			Height (A)	Width (B)	Depth (C)	
U041GTL	—	—	9 x 17	A	17-3/8	9-3/4	5-3/16	2
U042GB6	—	LT100B350	6PT	—	—	—	—	—
U042GP6	—	LT100S350	6PT	—	—	—	—	—
U043GP6	—	LT100S350	6PT	—	—	—	—	—
U055CP4010	—	LT100S350	6PT	—	—	—	—	—
U055CP6010	—	LT100S350	6PT	—	—	—	—	—
U055GB6	—	LT100B350	6PT	—	—	—	—	—
U074GTL	—	—	9 x 17	A	17-3/8	9-3/4	5-3/16	2
U075CB4010	—	LT100B350	9PT	—	—	—	—	—
U075CB4031	—	LT100B350	9PT	—	—	—	—	—
U075CB4L10	—	LT100B350	9PT	—	—	—	—	—
U075CB6010	—	LT100B350	9PT	—	—	—	—	—
U075CB6031	—	LT100B350	9PT	—	—	—	—	—
U075CB6L10	—	LT100B350	9PT	—	—	—	—	—
U075CP4010	—	LT100S350	9PT	—	—	—	—	—
U075CP4010ZI	—	LT100S350	9PT	—	—	—	—	—
U075CP4031	—	LT100S350	9PT	—	—	—	—	—
U075CP4L10	—	LT100S350	9PT	—	—	—	—	—
U075CP4L31	—	LT100S350	9PT	—	—	—	—	—
U075CP6010	—	LT100S350	9PT	—	—	—	—	—
U075CP6010BZ	—	LT100S350	9PT	—	—	—	—	—
U075CP6010D	—	LT100S350	9PT	—	—	—	—	—
U075CP6010T	—	LT100S350	9PT	—	—	—	—	—
U075CP6031	—	LT100S350	9PT	—	—	—	—	—
U075CP6L10	—	LT100S350	9PT	—	—	—	—	—
U075CP6L31	—	LT100S350	9PT	—	—	—	—	—
U075CP6L31BZ	—	LT100S350	9PT	—	—	—	—	—
U075CTL010	—	—	9 x 17	A	17-3/8	9-3/4	5-3/16	2
U075CTL035	—	—	9 x 17	A	17-3/8	9-3/4	5-3/16	2
U075CTLL10	—	—	9 X 17	A	17-3/8	9-3/4	5-3/16	2
U075GB6	—	LT100B350	9PT	—	—	—	—	—
U075GP4	—	LT100S350	9PT	—	—	—	—	—
U075GP4L	—	LT100S350	9PT	—	—	—	—	—
U075GP6	—	LT100S350	9PT	—	—	—	—	—
U075GP6C	—	LT100S350	9PT	—	—	—	—	—
U075GP6019	—	LT100S350	9PT	—	—	—	—	—
U075GP6L	—	LT100S350	9PT	—	—	—	—	—
U075GTL	—	—	9 x 17	A	17-3/8	9-3/4	5-3/16	2
U131CP6010	—	LT100S350	14PT	—	—	—	—	—
U131CTL010	—	—	14 x 21	A	21-3/8	14-3/4	6-7/16	3
U175CP6HP010	—	—	14PT	—	—	—	—	—
U355C010	—	—	9 x 17	A	17-3/8	9-3/4	5-3/16	2
U355G	—	—	9 x 17	A	17-3/8	9-3/4	5-3/16	2
U355GP6	—	LT100S350	9PT	—	—	—	—	—
U412CP6010	—	LT100S350	9PT	—	—	—	—	—
U412G	—	—	9 x 17	A	17-3/8	9-3/4	5-3/16	2
U412GP6	—	LT100S350	9PT	—	—	—	—	—
U611CB4010	—	LT100B350	9PT	—	—	—	—	—
U611CB6010	—	LT100B350	9PT	—	—	—	—	—
U611CP4010	—	LT100S350	9PT	—	—	—	—	—
U611CP6010	—	LT100S350	9PT	—	—	—	—	—
U611CTL010	—	—	9 x 17	A	17-3/8	9-3/4	5-3/16	2
U611GTL	—	—	9 x 17	A	17-3/8	9-3/4	5-3/16	2
U775C010	—	—	9 X 17	A	17-3/8	9-3/4	5-3/16	2
U775CP4010	—	LT100S350	9PT	—	—	—	—	—
U775CP6010	—	LT100S350	9PT	—	—	—	—	—

¹ Enclosure Styles on page 11-22.² Knockout Figures on page 11-22.³ Post Cabinet sizes and dimensions on page 11-22.

Technical Data

RV Power Outlets

Cabinet Size	Enclosure Style	Cabinet Dimensions (inches)			Knockout Figure
		Height (A)	Width (B)	Depth (C)	
6 x 9	A	9-1/8	7-1/4	5-3/16	1
6 x 14	A	14-3/8	7-1/4	5-3/16	1
9 x 17	A	17-3/8	9-3/4	5-3/16	2
9 x 30	B	30	9-3/4	5-3/16	2
14 x 21	A	21-3/8	14-3/4	6-7/16	3

Enclosure Styles / Cabinet Dimensions

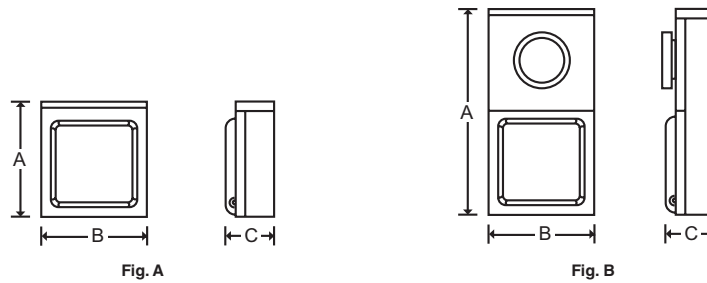

Knockout Configurations

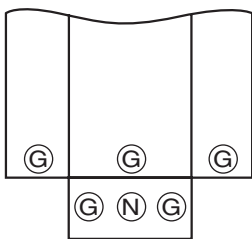

Fig. 1

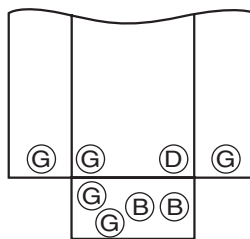

Fig. 2

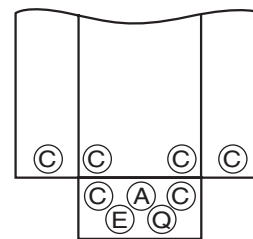

Fig. 3

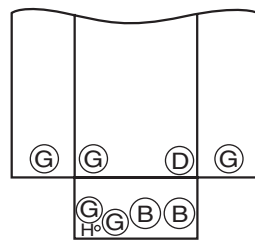

Fig. 4

Knockout Key

- A = 1-1/2", 2", 2-1/2"
- B = 1", 1-1/4", 1-1/2"
- C = 1-1/4", 1-1/2", 2"
- D = 3/4", 1", 1-1/4"
- E = 3/4"
- G = 1/2", 3/4", 1"
- H = 9/32"
- N = 1/2", 3/4", 1", 1-1/4", 1-1/2"
- Q = 1"

* Knockouts shown for size not for exact positions.

Data subject to change without notice.

Post Dimensions

TV/Telephone Unmetered

U004CP4031

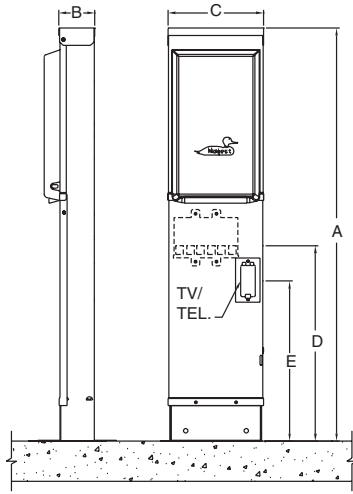

Key	Unmetered
A	41-1/8"
B	3-1/8"
C	9"
D	19-1/2"
E	16"

U075CP4031

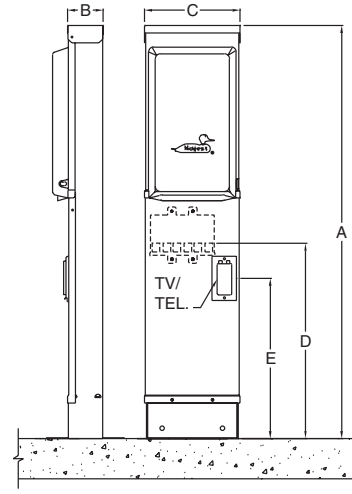

Key	Unmetered
A	41-1/8"
B	3-3/8"
C	9"
D	19-1/2"
E	16"

U041CP6031

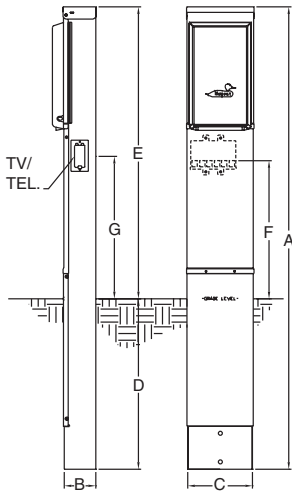

Key	Unmetered
A	65-1/8"
B	4-1/2"
C	9"
D	24"
E	41-1/8"
F	19-1/2"
G	20"

U075CP4L31

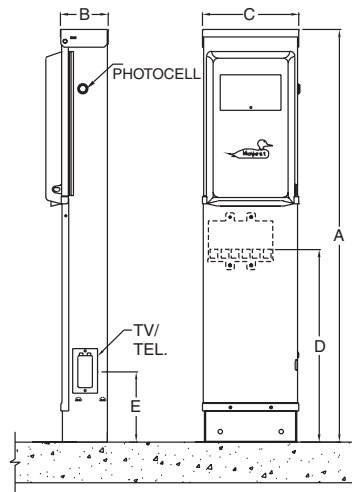

Key	Unmetered
A	40-1/2"
B	4-1/2"
C	9"
D	19"
E	7"

U075CB4031

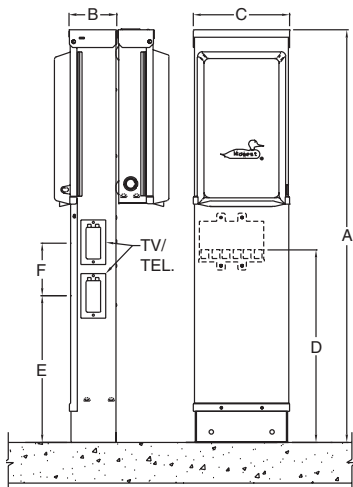

Key	Unmetered
A	40-1/2"
B	4-1/2"
C	9"
D	19"
E	14-1/2"
F	5-1/4"

U075CP6L31

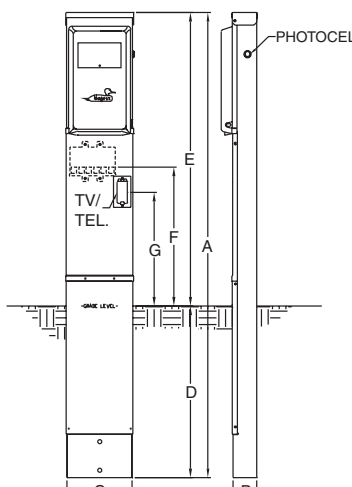

Key	Unmetered
A	65-1/8"
B	3-3/8"
C	9"
D	24"
E	41-1/8"
F	19-1/2"
G	16"

Data subject to change without notice.

RV Equip – Metallic

Post Dimensions

TV/Telephone Unmetered

U075CB6031

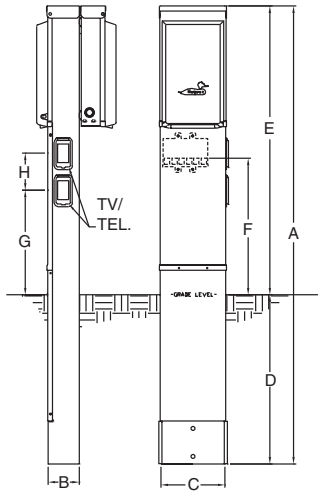

Key	Unmetered
A	65-1/8"
B	4-1/2"
C	9"
D	24"
E	41-1/8"
F	19-1/2"
G	15"
H	5-1/4"

U075CP6031

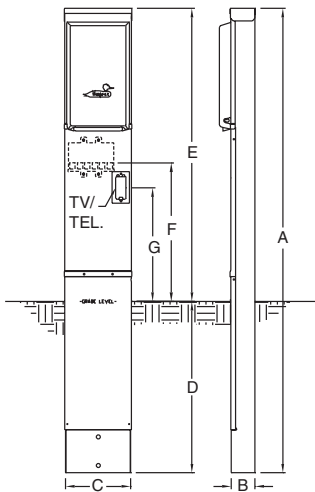

Key	Unmetered
A	65-1/8"
B	3-3/8"
C	9"
D	24"
E	41-1/8"
F	19-1/2"
G	16"

Flip-Cover for TV/Telephone is standard with padlock provision.

Dimensions Key

- A = Post Length
- B = Meter Center to Grade
- C = Terminal Bar to Grade
- D = Post Width
- E = Post Depth
- F = Grade to Wire Opening
- G = Wire Opening

Post Dimensions

Earth Burial

6PT

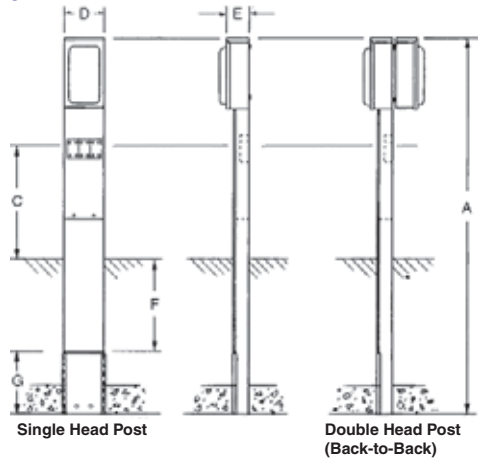

Key	Unmetered
A	62"
C	19-3/4"
D	6-1/2"
E	3-1/4"
F	18"
G	6"

14PT

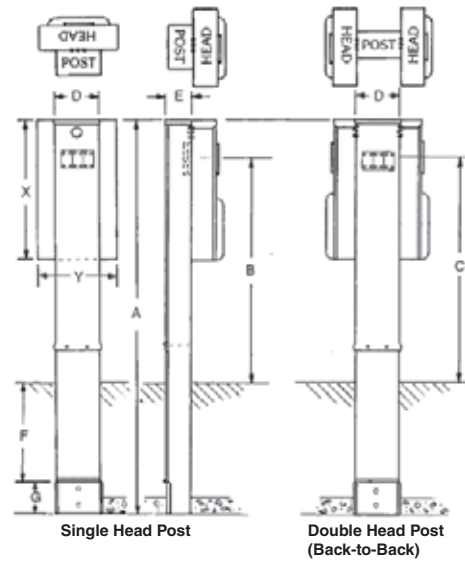

Key	Unmetered	Metered
A	83-1/2"	86"
B	—	50"
C	49-1/2"	49-1/2"
D	9"	9"
E	3-1/2"	3-1/2" ¹
F	18"	18"
G	6"	6"

¹ Some models available in 4-3/8".
 Contact distributor/factory.

9PT

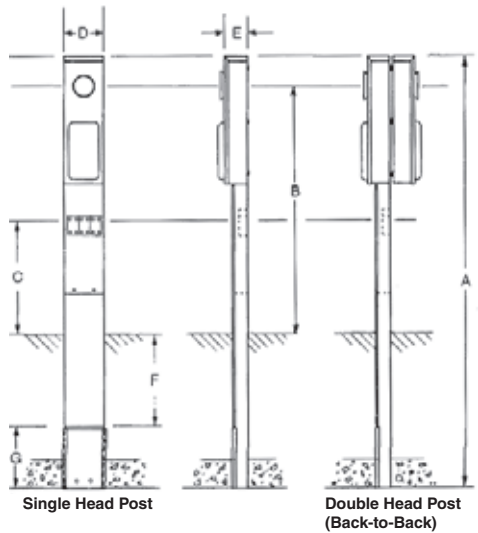

Key	Unmetered	Metered
A	65"	77-1/2"
B	—	45-1/4"
C	19-1/8"	19-1/8"
D	9"	9"
E	3-1/2" ¹	3-1/2" ¹
F	18"	18"
G	6"	6"

¹ Some models available in 4-3/8".
 Contact distributor/factory.

Post Dimensions

Pad Mount

6PT

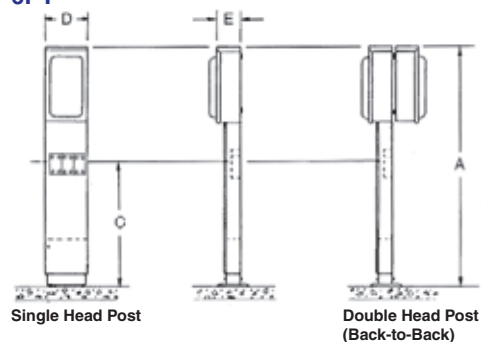

Key	Unmetered
A	36"
C	17-3/4"
D	6-1/2"
E	3-3/4"

9PT

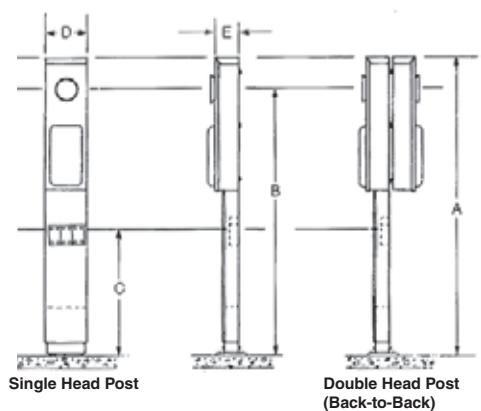

Key	Unmetered	Metered
A	41-1/8"	53-1/2"
B	—	45-1/2"
C	19-3/4"	19-1/2"
D	9"	9"
E	3-1/2" ¹	3-1/2" ¹

¹ Some models available in 4-3/8".
 Contact distributor/factory.

Dimensions Key

- A = Post Length
- B = Meter Center to Grade
- C = Terminal Bar to Grade
- D = Post Width
- E = Post Depth
- F = Grade to Wire Opening
- G = Wire Opening

Wire Range Tables

AA

Connector	Copper		Aluminum	
	Solid	Strand	Solid	Strand
Line	—	6-1/0	—	6-1/0
Load	14-10	14-10	—	—
Neutral - Large Hole	12-8	12-1/0	10-8	10-1/0
Neutral - Small Hole	14-8	14-4	12-8	12-4
Equipment Ground	12-8	12-2	12-8	12-2

AR

Connector	Copper		Aluminum	
	Solid	Strand	Solid	Strand
Line	14-10	14-10	—	—
Load	14-10	14-10	—	—
Neutral	—	—	—	—
Equipment Ground	12-8	12-2	—	—

B

Connector	Copper		Aluminum	
	Solid	Strand	Solid	Strand
Line	14-8	14-6	12-8	12-6
Load	14-10	14-10	—	—
Neutral	12-8	12-6	12-8	12-6
Equipment Ground	12-8	12-2	12-8	12-2

BB

Connector	Copper	
	Solid	Strand
Line	14-10	14-10
Load	14-10	14-10
Neutral	14-10	14-10
Equipment Ground	12-8	12-2

BX

Connector	Copper		Aluminum	
	Solid	Strand	Solid	Strand
Line - Meter Socket	—	1/0-250	—	1/0-250
Load - Plug Duplex	14-10	14-10	—	—
Load - CB Base Lugs	—	1/0-4/0	—	1/0-4/0
Neutral	—	2-250	—	2-250
Neutral	14-8	14-1/0	12-8	12-1/0
Neutral	14-8	10-4	—	6-4
Neutral	14-8	12-8	12-8	12-8
Equipment Ground	12-8	12-2	12-8	12-2
Post Line Connectors Suitable for Loop Feed	6-350 kcmil		6-350 kcmil	

BY

Connector	Copper		Aluminum	
	Solid	Strand	Solid	Strand
Line	—	1/0-250	—	1/0-250
Load	14-10	14-10	—	—
Neutral	—	2-250	—	2-250
Neutral	14-8	14-1/0	12-8	12-1/0
Neutral	14-8	10-4	—	12-8
Neutral	14-8	12-8	12-8	12-8
Equipment Ground	12-8	12-2	12-8	12-2
Post Line Connectors Suitable for Loop Feed	6-350 kcmil		6-350 kcmil	

P

Connector	Copper		Aluminum	
	Solid	Strand	Solid	Strand
Line	14-8	14-1/0	12-8	12-1/0
Load	14-10	14-10	—	—
Neutral - End Hole	14-8	14-2	12-8	12-2
Neutral - Side Hole	14-8	14-4	12-8	12-4
Equipment Ground	12-8	12-2	12-8	12-2

S

Connector	Copper		Aluminum	
	Solid	Strand	Solid	Strand
Post Line Connectors Suitable for Loop Feed	6-350 kcmil		6-350 kcmil	
Equipment Ground	12-2		12-2	

U

Connector	Copper		Aluminum	
	Solid	Strand	Solid	Strand
Line	14-8	14-1/0	12-8	12-1/0
Load	14-10	14-10	—	—
Neutral - Large Hole	12-8	12-1/0	10-8	10-1/0
Neutral - Small Hole	14-8	14-4	12-8	12-4
Equipment Ground	12-8	12-2	12-8	12-2

UX

Connector	Copper		Aluminum	
	Solid	Strand	Solid	Strand
Line	14-8	14-1/0	12-10	12-1/0
Neutral - Large Hole	12-8	12-1/0	10	10-1/0
Neutral - Small Hole	14-8	14-4	12-10	12-4
Equipment Ground	14-2/0	14-2/0	14-2/0	14-2/0

Wire Range Tables

W

Connector	Copper		Aluminum	
	Solid	Strand	Solid	Strand
Line - Loop Feed	14-8	14-1/0	12-8	12-1/0
Load	14-8	14-1/0	—	—
Neutral - Large Hole	12-8	12-1/0	10-8	10-1/0
Neutral - Small Hole	14-8	14-4	12-8	12-4
Equipment Ground	12-8	12-2	12-8	12-2

X

Connector	Copper		Aluminum	
	Solid	Strand	Solid	Strand
Line - CB Base (JL-100)	14-8	14-1/0	12-8	12-1/0
Load - Plug Duplex	14-10	14-10	—	—
Neutral	14-4	14-4	14-4	14-4
Equipment Ground – Post	14-2/0	14-2/0	14-2/0	14-2/0

Y

Connector	Copper		Aluminum	
	Solid	Strand	Solid	Strand
Line - Meter Socket	—	6-1/0	—	6-1/0
Load - Plug Duplex	14-10	14-10	—	—
Neutral	14-4	14-4	14-4	14-4
Equipment Ground – Post	14-2/0	14-2/0	14-2/0	14-2/0

Z

Connector	Copper		Aluminum	
	Solid	Strand	Solid	Strand
Post Line Connectors Suitable for Loop Feed	6-350 kcmil		6-350 kcmil	
Equipment Ground	14-2/0		14-2/0	

ZZ

Connector	Copper		Aluminum	
	Solid	Strand	Solid	Strand
Line - Meter Socket	—	1/0-250	—	1/0-250
Load - CB Base Lugs	—	2-250	—	2-250
Neutral - Large Single Lugs	—	2-250	—	2-250
Neutral - Small Single Lugs	14-8	14-1/0	12-8	12-1/0
Neutral - 6 Large Hole	14-8	10-4	—	6-4
Neutral - 8 Small Hole	14-8	12-8	12-8	12-8
Equipment Ground	12-8	12-2	12-8	12-2



Application Information

ParkMate™ represents Midwest's premium line of RV power centers – offering superior corrosion protection against harsh coastal environments and in areas where roadways are heavily salted. The power center body is injection molded with impact and corrosion resistant VALOX™ engineered thermoplastic which is designed to provide years of maintenance free service. Post bodies are manufactured using heavy gauge galvanized steel. (Stainless steel posts are also available for the harshest environments.) Similar to our Metallic RV offering, ParkMate power centers are offered with the most common circuit protection, receptacles and convenience options. Choose ParkMate for the highest level of confidence in your RV power centers – you'll be glad you did!



Features and Benefits

Rugged Durability

- VALOX thermoplastic enclosure and internal components are corrosion resistant
- Earth burial posts are galvanized and features 350 KCMIL loop-feed lugs

Installation Ease

- Easy to wire terminal lugs
- Four circuit load center installed
- All units with factory installed Cu/Al equipment ground lug
- 10kAIC

User Safety

- Hinged cover closes over plugs and cords maintaining a safe, weather tight enclosure
- Padlock provision to prevent unauthorized access

Optional Features

- Available accessories – electronic meter, light, photocell
- Available add on accessory – TV/telephone
- Factory wired power receptacles are available in 20, 30 or 50 amp configurations protected by thermal magnetic circuit breakers
- Photoelectric sensor automatically turns lights on and off
- 7 watt fluorescent light illuminates receptacle for easy night time plug in while providing security lighting and easy identification of power center location – light circuit is protected by a 20 amp circuit breaker
- Additional accessories available – see pages 14-1-14-14

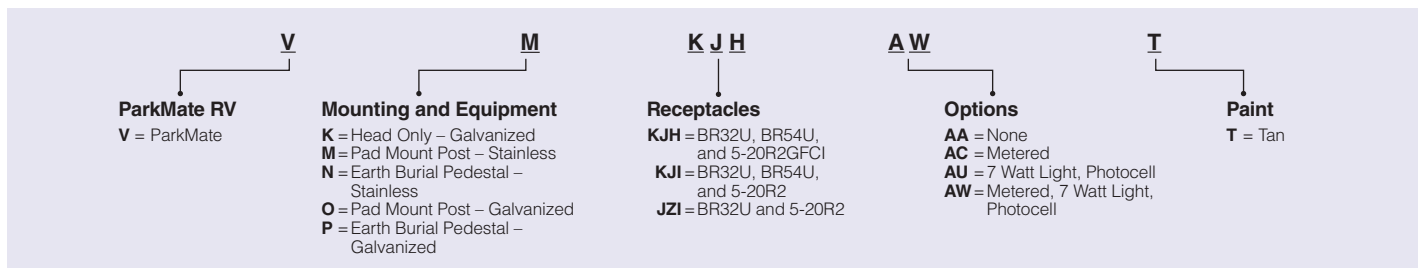

Head Only and Galvanized Steel Post

100 Amps, 120/240V

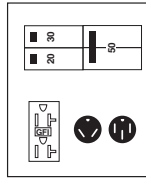

Fig. A
VVKJHAAT, VPKJHAAT,
VOKJHAAT
BR32U, BR54U, 5-20R2GFCl

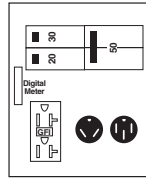

Fig. B
VKKJHACT, VPKJHACT,
VOKJHACT
BR32U, BR54U, 5-20R2GFCl

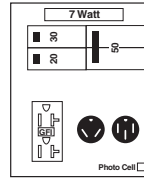

Fig. C
VKKJHAUT, VPKJHAUT,
VOKJHAUT
BR32U, BR54U, 5-20R2GFCl

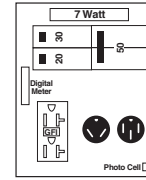

Fig. D
VKKJHAWT, VPKJHAWT,
VOKJHAWT
BR32U, BR54U, 5-20R2GFCl

Head Only

Fig.	Model Number ¹	Options	Receptacles	Circuit Protection	Amps	Cabinet Size	Load Center	Unit Wt.	Std Pkg.	UL
A	VKKJHAAT	—	BR32U, BR54U, 5-20R2GFCl	THQL2150, THQL1130, THQL1120	100	13.5 x 10	LC44X1	9	1	Y
B	VKKJHACT	Metered						10		
C	VKKJHAUT	7 Watt Light, Photocell						10		
D	VKKJHAWT	Metered, 7 Watt Light, Photocell						10		

Earth Burial, Galvanized Steel Post

Fig.	Model Number ¹	Options	Receptacles	Circuit Protection	Amps	Cabinet Size	Load Center	Unit Wt.	Std Pkg.	UL
A	VPKJHAAT	—	BR32U, BR54U, 5-20R2GFCl	THQL2150, THQL1130, THQL1120	100	13.5 x 10	LC44X1	45	1	Y
B	VPKJHACT	Metered						46		
C	VPKJHAUT	7 Watt Light, Photocell						46		
D	VPKJHAWT	Metered, 7 Watt Light, Photocell						46		

Pad Mount, Galvanized Steel Post

Fig.	Model Number ¹	Options	Receptacles	Circuit Protection	Amps	Cabinet Size	Load Center	Unit Wt.	Std Pkg.	UL
A	VOKJHAAT	—	BR32U, BR54U, 5-20R2GFCl	THQL2150, THQL1130, THQL1120	100	13.5 x 10	LC44X1	42	1	Y
B	VOKJHACT	Metered						43		
C	VOKJHAUT	7 Watt Light, Photocell						43		
D	VOKJHAWT	Metered, 7 Watt Light, Photocell						43		

¹ See page 11-33 for dimensions.

Stainless Steel Post

100 Amps, 120/240V

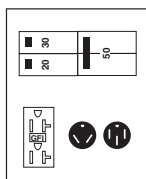

Fig. A
VNKJHAAT, VMKJHAAT
 BR32U, BR54U, 5-20R2GFCI

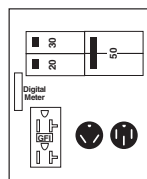

Fig. B
VNKJHACT, VMKJHACT
 BR32U, BR54U, 5-20R2GFCI

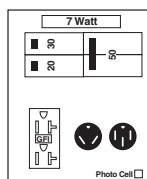

Fig. C
VNKJHAUT, VMKJHAUT
 BR32U, BR54U, 5-20R2GFCI

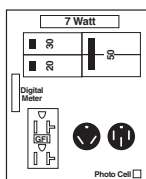

Fig. D
VNKJHAWT, VMKJHAWT
 BR32U, BR54U, 5-20R2GFCI

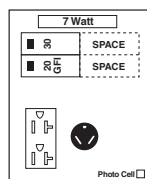

Fig. E
VMJZIAUT
 BR32U, 5-20R2

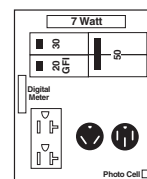

Fig. F
VMKJIAWT
 BR32U, BR54U, 5-20R2

Earth Burial

Fig.	Model Number ¹	Options	Receptacles	Circuit Protection	Amps	Cabinet Size	Load Center	Unit Wt.	Std Pkg.	UL
A	VNKJHAAT	—	BR32U, BR54U, 5-20R2GFCI	THQL2150, THQL1130, THQL1120	100	13.5 x 10	LC44X1	45	1	Y
B	VNKJHACT	Metered						46		
C	VNKJHAUT	7 Watt Light, Photocell						46		
D	VNKJHAWT	Metered, 7 Watt Light, Photocell						46		

Pad Mount

Fig.	Model Number ¹	Options	Receptacles	Circuit Protection	Amps	Cabinet Size	Load Center	Unit Wt.	Std Pkg.	UL
A	VMKJHAAT	—	BR32U, BR54U, 5-20R2GFCI	THQL2150, THQL1130, THQL1120	100	13.5 x 10	LC44X1	42	1	Y
B	VMKJHACT	Metered						43		
C	VMKJHAUT	7 Watt Light, Photocell						43		
D	VMKJHAWT	Metered, 7 Watt Light, Photocell						43		
E	VMJZIAUT	7 Watt Light, Photocell	BR32U, 5-20R2	THQL1130, THQL1120GF, (2) Spaces THQL1120				43		
F	VMKJIAWT	Metered, 7 Watt Light, Photocell	BR32U, BR54U, 5-20R2	THQL2150, THQL1130, THQL1120GF				43		

¹ See page 11-33 for dimensions.

Dimensions

ParkMate™

Head Only

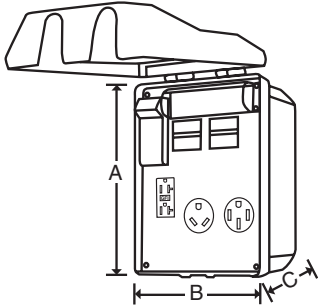

Key	Front
A	13-1/2"
B	10"
C	8"

Key	Back
A	12-1/8"
B	9-3/16"
C	8"

Water Shroud

UH90G / UH90GT

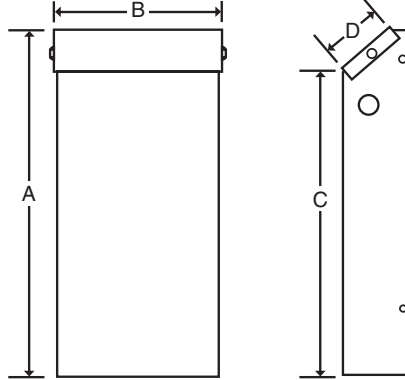

Key	Dimensions
A	15-1/4"
B	9-1/2"
C	13-1/4"
D	2-5/6"

Post (Earth Burial and Pad Mount)

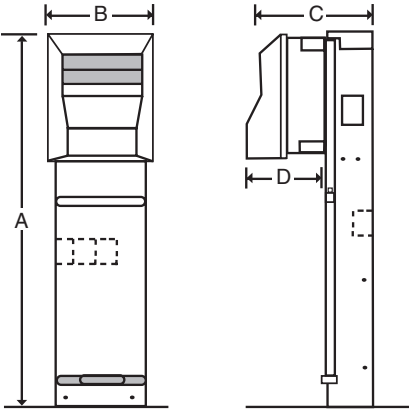

Key	Dimensions
A	41-1/2"
B	10"
C	12-3/4"
D	8"

UH90STL

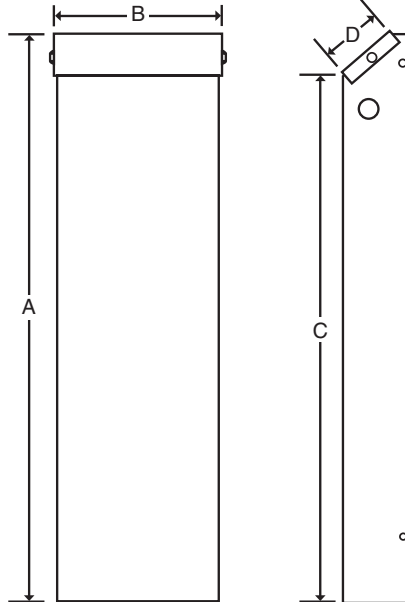

Key	Dimensions
A	27-1/4"
B	9-1/2"
C	25-1/4"
D	2-5/6"

TV/Telephone

TTV100T

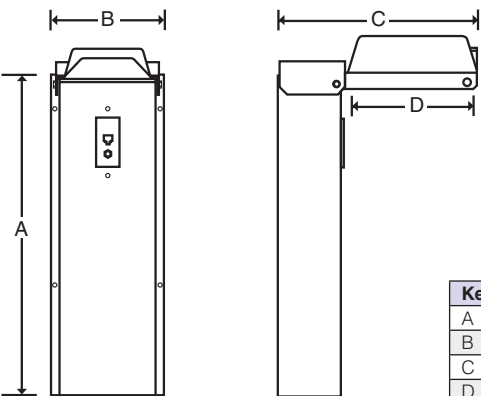

Key	Dimensions
A	17-4/5"
B	6-1/5"
C	9-1/10"
D	6"

Wire Range Table

Connector	Head Only	Post	
		Earth Burial	Pad Mount
Line Lug	14-1/0	1-350 kcmil	
Neutral	14-1/0	1-350 kcmil	
Ground Lug	12-2	12-2	

Notes

Section 12

Terminal Boxes



Application Information

Terminal Boxes convert overhead to underground services and are used for multi-circuit wiring. The NEMA 3R enclosure provides protection for all terminations inside and provides a convenient, time-saving means of wire splices and connections.

Midwest offers a full line of terminal boxes for 240 volt or 400 volt single-phase and three-phase 600 volt ratings to meet your application requirements. Typical applications, both indoor and outdoor, include inter-building wiring on farms, convenient splicing means for industrial use and commercial construction.

Features and Benefits

Installation Ease

- Rated for indoor and outdoor installations (NEMA 1/3R)
- Factory installed terminal bars accept copper or aluminum wire
- Plenty of concentric knockouts to reduce installation time
- Doors feature stay-open position or remove entirely to simplify wiring
- Stationary mounted terminations simplify circuit tracing
- Rolled edge door for cord protection

Durable, Safe, Long-lasting Construction

- G90 galvanized steel construction for superior corrosion protection
- Durable polyester powder coat finish resists chipping and fading
- Padlock provision helps prevent unauthorized entry
- Insulated lugs comply with NEC 314.28 E(4)
- All components factory wired and assembled



Terminal Boxes

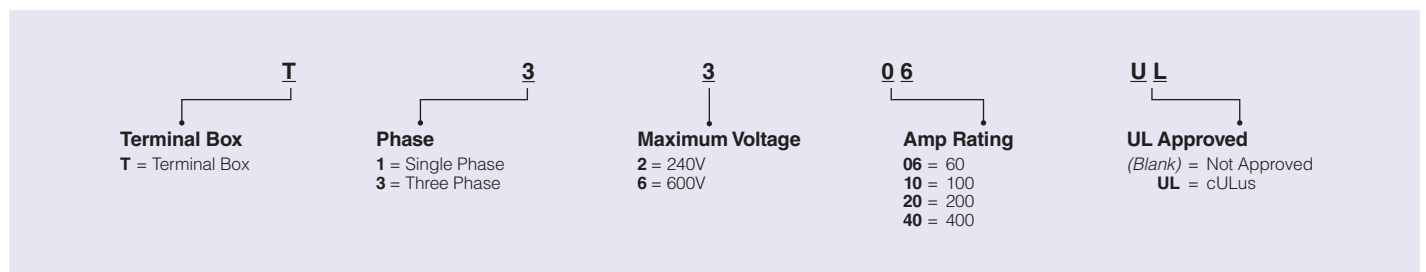

Data subject to change without notice.

Terminal Boxes

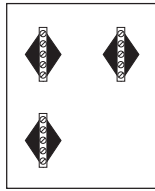

Fig. A
T1206, T1210, T1220

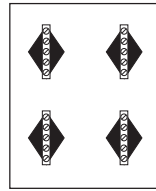

Fig. B
**T3210, T3220,
 T3610, T3620**

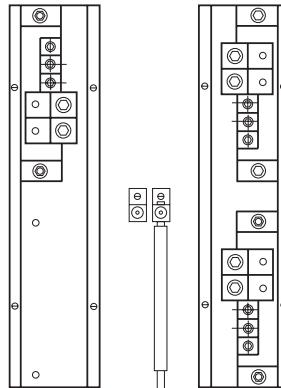

Fig. C
T1240UL

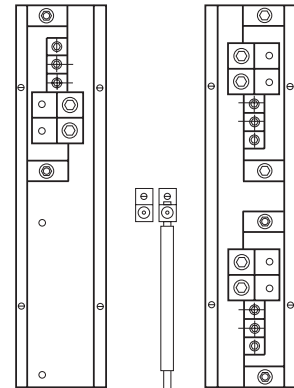

Fig. D
T3640UL

AC, 60 – 200 Amps, 240V Max

Fig.	Model Number	Wire Range	Phase	Amps	Cabinet Size	Hub Opening	Unit Wt.	Std Pkg.	UL
A	T1206	(4) 14-4	1	60	7 x 10	Y	6	4	Y ¹
A	T1210	(5) 14-1/0	1	100	9 x 17		11		
B	T3210	(5) 14-1/0	3	100	9 x 17		12		
A	T1220	(3) 1/0-250, (3) 12-1/0	1	200	14 x 21		19		
B	T3220	(3) 1/0-250, (3) 12-1/0	3	200	14 x 21		19		

¹ cULus approved.

AC, 400 Amps, 240V Max

Fig.	Model Number	Wire Range	Phase	Amps	Cabinet Size	Hub Opening	Unit Wt.	Std Pkg.	UL
C	T1240UL	(2) 2-600, (3) 6-350	1	400	16 x 29	Y ²	28	1	Y ¹

¹ cULus approved.

² Non-standard/Universal hub opening. Hub no longer furnished. Will accept U40 only – order separately. Consult Manufacturer.

AC, 100 – 400 Amps, 600V Max

Fig.	Model Number	Wire Range	Phase	Amps	Cabinet Size	Hub Opening	Unit Wt.	Std Pkg.	UL
B	T3610	(5) 14-1/0	3	100	9 x 17	Y	12	1	Y ¹
B	T3620	(3) 1/0-250, (3) 12-1/0		200	14 x 21		19		
D	T3640UL	(2) 2-600, (3) 6-350		400	16 x 29	Y ²	29		

¹ cULus approved.

² Non-standard/Universal hub opening. Hub no longer furnished. Will accept U40 only – order separately. Consult Manufacturer.

Technical Data

Model Number ¹	Replacement Parts Lug Assembly	Lug Cover Kit ³	Number of Bars	Lugs Per Bar	Cabinet Size	Cabinet Dimensions (inches)			Knockout Figure
						Height (A)	Width (B)	Depth (C)	
T1206	NI60B2	TBK100A	3	4	7 x 10	10	7-1/4	4	1
T1210	NI100B2	TBK100A	3	5	9 x 17	17-1/2	9-3/4	3-1/2	2
T1220	NI200	TBK200A	3	6	14 x 21	21-1/2	14-1/2	4-3/4	3
T1240UL	198B8615G1	TBK400A	3	5	16 x 29	29-1/2	16	5	4
T3210	NI100B2	TBK200A	4	5	9 x 17	17-1/2	9-3/4	3-1/2	2
T3220	NI200	TBK100B	4	6	14 x 21	21-1/2	14-1/2	4-3/4	3
T3610	NI100B2	TBK100B	4	5	9 x 17	17-1/2	9-3/4	3-1/2	2
T3620	NI200A5	TBK400A	4	6	14 x 21	21-1/2	14-1/2	4-3/4	3
T3640UL	198B8615G2	TBK400A	4	5	16 x 29	29-1/2	16	5	4

¹ All models include closure plate. Order conduit hub separately.

² Use large style universal hub.

³ Terminal boxes manufactured prior to 2013 can be retrofitted to comply with NEC 314.28 E(4). Order quantity (1) kit per terminal box.

Hubs (Order Separately)

Hub Opening (inches)	Midwest Hub Number	Universal Hub Number	
		Small	Large
3/4	B07	—	—
1	B10	U10	—
1-1/4	B12	U12	—
1-1/2	B15	U15	—
2	B20	U20	U27
2-1/2	B25	U25	U28
3	—	—	U30
3-1/2	—	—	U35
4	—	—	U40
Closure Plate	B01	U01	U04

Enclosure Styles / Cabinet Dimensions

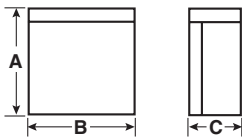

Fig. A

* See model specific dimensions in Technical Data table above.

Knockout Configurations

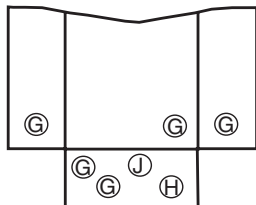

Fig. 1

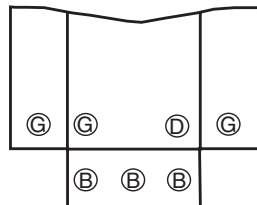

Fig. 2

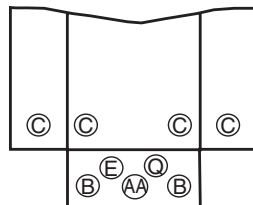

Fig. 3

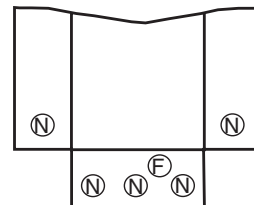

Fig. 4

Knockout Key

- AA = 1-1/2", 2", 2-1/2"
- B = 1", 1-1/4", 1-1/2"
- C = 1-1/4", 1-1/2", 2"
- D = 3/4", 1", 1-1/4"
- E = 3/4"
- F = 1/2", 3/4"
- G = 1/2", 3/4", 1"
- H = 1/2", 3/4", 1", 1-1/4", 1-1/2"
- N = 2", 2-1/2", 3"
- Q = 1"

* Knockouts shown for size not for exact positions.

Data subject to change without notice.

Section 13

Transformers



Transformers

Our transformers are setting new standards for quality — in design, manufacturing and testing. Before leaving the factory, every Midwest transformer must pass a series of rigorous tests to ensure that you get the highest initial quality and years of trouble-free operation. These tests are performed with advanced equipment on a range of specific requirements.

- **Coil insulation integrity** to ensure high initial quality and years of trouble-free operation
- **Current and loss** to ensure peak efficiency, low noise and lowest operating cost possible
- **Voltage ratio** to ensure that input and output voltage parameters are exactly as specified
- **Impedance** to ensure the transformer is producing power that is friendly to your building and equipment



3-Phase Vented

- 15-500kVA DOE 2016 Efficiency
- General purpose
- K-Factor
- Low temperature rise
- Low noise
- Electronic noise isolation
- Harmonic mitigating
- Drive isolation (DIT)
- Stainless steel enclosure available



1-Phase Vented

- 15-250kVA
- DOE 2016 Efficiency
- Low temperature rise



Enclosed & Encapsulated

- 1-Phase
- 0.05-15kVA
- NEMA 3R



Buck-Boost

- 1-Phase
- 0.05-3kVA
- NEMA 3R



Control Power Core & Coil

- 1-Phase
- Fully encapsulated
- 0.05-3kVA
- Terminal board connection
- Leads out connection

Features and Benefits

DOE 2016 Efficiency Standards

- General Purpose
- K-Factor
- Low Noise
- Guard I & II Noise Isolation Transformer
- Guard III Harmonic Mitigating

Key Features

- Copper or aluminum windings
- Standard NEMA 2 drip-proof enclosure with optional weathershield conversion kit for NEMA 3R outdoor
- NEMA 3R stainless steel (Type 316) enclosure available up to 150kVA
- Lug kit included up to 150kVA
- Copper ground bar kit included
- 200% neutral
- Copper ground strap
- Taps
 - 300kVA and smaller have two 2.5% above nominal and four 2.5% below nominal
 - 500kVA and larger have two 2.5% above nominal and two 2.5% below nominal
- Robust packaging with top and edge protection
- 220°C insulation system
- 40°C ambient
- 10kV BIL

Installation and Service Ease

- Accessible mounting flanges with front/back slotted mounting holes
- Single-piece front/back is easily removable
- Outward facing mounting feet for faster installation

User Safety

- Clear, comprehensive documentation and labeling
- Seismic qualified to the requirements of ASCE 7.05, IEEE-693-2005 and IBC-2006
- Larger interior clearances for easier wiring and enhanced safety



Dry Type Transformers

Midwest Dry Type Transformers are brand contractors trust for trouble-free installation and years of reliable ser-vice. We have a wide array of transformers. The selection guide below will help you choose the correct transformer for some of the most common applications.



Application	General Purpose	K-Factor (K=4)	K-Factor (K=13)	K-Factor (K=20)	K-Factor (K=30)	Low Noise	Drive Isolation
AC or DC variable speed drives							■
Computer installations				■	■		
Critical care facilities				■	■	■	
Data processing equipment circuits				■	■		
HID lighting		■					
Hospital operating rooms				■	■		
Incandescent lighting	■	■					
Induction heaters		■					
Instrumentation				■	■		
Motor generators (without solid state drives)	■	■					
Motors	■	■					
Multiple receptacle circuits in heath care facilities			■				
Office buildings			■			■	
PLC & solid state controls		■					
Production or assembly line equipment			■				
Programmable controllers				■			
Rectifier outputs							■
Resistance heating	■	■					
Schools & classroom facilities			■			■	
SCR variable speed drives				■			
UPS with optional input filtering		■					
UPS without optional input filtering			■				
Welders		■					
X-ray equipment				■			
Technical Data ¹ (MET-028 page numbers)	3-9	10,14,18,20	11,15,18,20	12,16,19,21	13,17,19,21	22-23	24-29

¹ Refer to MET-028 Midwest Dry Type Transformers for additional transformers including Totally Enclosed, Non-ventilated, Midtapped, Buck-Boost Encapsulated, and Open Core and Coil.

General Purpose

1-Phase, DOE 2016 Efficiency, NEMA 2, Taps (+2, -4, 2.5%)

240 x 480 Primary, 120/240 Secondary, 150°C Rise

kVA	Aluminum			Copper		
	Model Number	Accessory Group	Approx. Net Wt.	Model Number	Accessory Group	Approx. Net Wt.
15	9T83W2670	YF171	320	9T83X2570	YF171	350
25	9T83W2671	YF171	320	9T83X2571	YF171	350
37.5	9T83W2672	YF171	320	9T83X2572	YF172	500
50	9T83W2673	YF172	400	9T83X2573	YF173	520
75	9T83W2674	YF174	510	9T83X2574	YF174	635
100	9T83W2675	YF175	900	9T83X2575	YF175	1050
167	9T83W2676	YF176	1360	9T83X2576	YF176	1675
250	9T83W2677	YF177	1700	—	—	—

240 x 480 Primary, 120/240 Secondary, 115°C Rise

kVA	Aluminum			Copper		
	Model Number	Accessory Group	Approx. Net Wt.	Model Number	Accessory Group	Approx. Net Wt.
15	9T83W2670G15	YF171	320	9T83X2570G15	YF171	350
25	9T83W2671G15	YF171	320	9T83X2571G15	YF171	350
37.5	9T83W2672G15	YF172	400	9T83X2572G15	YF172	500
50	9T83W2673G15	YF173	500	9T83X2573G15	YF173	520
75	9T83W2674G15	YF174	510	9T83X2574G15	YF174	635
100	9T83W2675G15	YF175	900	9T83X2575G15	YF175	1050
167	9T83W2676G15	YF176	1360	9T83X2576G15	YF176	1675

240 x 480 Primary, 120/240 Secondary, 80°C Rise

kVA	Aluminum			Copper		
	Model Number	Accessory Group	Approx. Net Wt.	Model Number	Accessory Group	Approx. Net Wt.
15	9T83W2670G80	YF171	320	9T83X2570G80	YF171	350
25	9T83W2671G80	YF171	320	9T83X2571G80	YF171	350
37.5	9T83W2672G80	YF172	400	9T83X2572G80	YF172	500
50	9T83W2673G80	YF174	510	9T83X2573G80	YF174	635
75	9T83W2674G80	YF175	900	9T83X2574G80	YF175	1050
100	9T83W2675G80	YF176	1360	9T83X2575G80	YF176	1675
167	9T83W2676G80	YF177	1700	9T83X2576G80	YF177	1960

General Purpose

3-Phase, DOE 2016 Efficiency, Vented, NEMA 2

480 Primary, 480/277 Secondary, 150°C Rise

kVA	Aluminum		
	Model Number	Accessory Group	Approx. Net Wt.
15	9T10W1171	UX71A	231
30	9T10W1172	UX72A	330
45	9T10W1173	UX73A	444
75	9T10W1174	UY74A	561
112.5	9T10W1175	DY75A	680
150	9T10W1176	DY76A	1030
225	9T10W1177	DY77A	1450
300	9T10W1178	DY78A	1670
500	9T10W1179	DX79A	2900

480 Primary, 208Y/120 Secondary, 150°C Rise

kVA	Aluminum			Copper		
	Model Number	Accessory Group	Approx. Net Wt.	Model Number	Accessory Group	Approx. Net Wt.
15	9T10W1001	UX71A	231	9T10X1001	UX71C	230
30	9T10W1002	UX72A	330	9T10X1002	UX72C	353
45	9T10W1003	UX73A	444	9T10X1003	UX73C	480
75	9T10W1004	UY74A	561	9T10X1004	UY74C	661
112.5	9T10W1005	DY75A	680	9T10X1005	DY75C	790
150	9T10W1006	DY76A	1030	9T10X1006	DY76C	1085
225	9T10W1007	DY77A	1450	9T10X1007	DY77C	1610
300	9T10W1008	DY78A	1670	9T10X1008	DY78C	1970
500	9T10W1009	DX79A	2900	9T10X1009	DX79C	3720

480 Primary, 208Y/120 Secondary, 115°C Rise

kVA	Aluminum			Copper		
	Model Number	Accessory Group	Approx. Net Wt.	Model Number	Accessory Group	Approx. Net Wt.
15	9T10W1001G31	UX71A	231	9T10X1001G31	UX71C	230
30	9T10W1002G31	UX72A	330	9T10X1002G31	UX72C	353
45	9T10W1003G31	UX73A	444	9T10X1003G31	UX73C	480
75	9T10W1004G31	UX74A	603	9T10X1004G31	UX74C	748
112.5	9T10W1005G31	DX75A	830	9T10X1005G31	DX75C	900
150	9T10W1006G31	DX76A	1250	9T10X1006G31	DX76C	1240
225	9T10W1007G31	DX77A	1670	9T10X1007G31	DX77C	1847
300	9T10W1008G31	DX78A	1985	9T10X1008G31	DX78C	2150
500	9T10W1009G31	DX79A	2900	—	—	—

480 Primary, 208Y/120 Secondary, 80°C Rise

kVA	Aluminum			Copper		
	Model Number	Accessory Group	Approx. Net Wt.	Model Number	Accessory Group	Approx. Net Wt.
15	9T10W1001G61	UX72A	330	9T10X1001G61	UX72C	353
30	9T10W1002G61	UX73A	444	9T10X1002G61	UX73C	480
45	9T10W1003G61	UY74A	561	9T10X1003G61	UY74C	661
75	9T10W1004G61	DY75A	680	9T10X1004G61	DY75C	790
112.5	9T10W1005G61	DY76A	1030	9T10X1005G61	DY76C	1085
150	9T10W1006G61	DY77A	1450	9T10X1006G61	DY77C	1610
225	9T10W1007G61	DX78A	1985	9T10X1007G61	DX78C	2150
300	9T10W1008G61	DX79A	2900	9T10X1008G61	DX79C	3720

Data subject to change without notice.

General Purpose

3-Phase, Vented, DOE 2016 Efficiency, NEMA 2

480 Primary, 240/120 Secondary, 150°C Rise

kVA	Aluminum		
	Model Number	Accessory Group	Approx. Net Wt.
15	9T10W1181	UX71A	231
30	9T10W1182	UX72A	330
45	9T10W1183	UX73A	444
75	9T10W1184	UY74A	561
112.5	9T10W1185	DX75A	830
150	9T10W1186	DY76A	1030
225	9T10W1187	DY77A	1450
300	9T10W1188	DY78A	1670
500	9T10W1189	DX79A	2900

480 Primary, 240 Secondary, 150°C Rise

kVA	Copper		
	Model Number	Accessory Group	Approx. Net Wt.
15	9T10X1191	UX71C	230
30	9T10X1192	UX72C	353
45	9T10X1193	UX73C	480
75	9T10X1194	UY74C	661
112.5	9T10X1195	DY75C	790
150	9T10X1196	DY76C	1085
225	9T10X1197	DY77C	1610
300	9T10X1198	DY78C	1970
500	9T10X1199	DX79C	3720

240 Primary, 480/277 Secondary, 150°C Rise

kVA	Aluminum		
	Model Number	Accessory Group	Approx. Net Wt.
15	9T10W1531	UX71A	231
30	9T10W1532	UX72A	330
45	9T10W1533	UX73A	444
75	9T10W1534	UY74A	561
112.5	9T10W1535	DY75A	680
150	9T10W1536	DY76A	1030
225	9T10W1537	DY77A	1450
300	9T10W1538	DY78A	1670
500	9T10W1539	DX79A	2900

240 Primary, 208Y/120 Secondary, 150°C Rise

kVA	Aluminum		
	Model Number	Accessory Group	Approx. Net Wt.
15	9T10W1611	UX71A	231
30	9T10W1612	UX72A	330
45	9T10W1613	UX73A	444
75	9T10W1614	UY74A	561
112.5	9T10W1615	DY75A	680
150	9T10W1616	DY76A	1030
225	9T10W1617	DY77A	1450
300	9T10W1618	DY78A	1670
500	9T10W1619	DX79A	2900

208 Primary, 480/277 Secondary, 150°C Rise

kVA	Aluminum		
	Model Number	Accessory Group	Approx. Net Wt.
15	9T10W1341	UX71A	231
30	9T10W1342	UX72A	330
45	9T10W1343	UY74A	561
75	9T10W1344	DY75A	680
112.5	9T10W1345	DY76A	1030
150	9T10W1346	DX76A	1250
225	9T10W1347	DY78A	1670
300	9T10W1348	DX79A	2900

208 Primary, 208Y/120 Secondary, 150°C Rise

kVA	Aluminum		
	Model Number	Accessory Group	Approx. Net Wt.
15	9T10W1451	UX71A	231
30	9T10W1452	UX72A	330
45	9T10W1453	UY74A	561
75	9T10W1454	DY75A	680
112.5	9T10W1455	DY76A	1030
150	9T10W1456	DX76A	1250
225	9T10W1457	DY78A	1670
300	9T10W1458	DX79A	2900

600 Primary, 208Y/120 Secondary, 150°C Rise

kVA	Copper		
	Model Number	Accessory Group	Approx. Net Wt.
15	9T10X2401	UX71C	230
30	9T10X2402	UX72C	353
45	9T10X2403	UX73C	480
75	9T10X2404	UY74C	661
112.5	9T10X2405	DY75C	790
150	9T10X2406	DY76C	1085
225	9T10X2407	DY77C	1610
300	9T10X2408	DY78C	1970
500	9T10X2409	DX79C	3720

Data subject to change without notice.

K-Factor

3-Phase, K=4, DOE 2016 Efficiency

480 Primary, 208Y/120 Secondary, 150°C Rise

kVA	Aluminum			Copper		
	Model Number	Accessory Group	Approx. Net Wt.	Model Number	Accessory Group	Approx. Net Wt.
15	9T14W1001G03	UX71A	231	9T14X1001G03	UX71C	230
30	9T14W1002G03	UX73A	444	9T14X1002G03	UX72C	353
45	9T14W1003G03	UX73A	444	9T14X1003G03	UX73C	480
75	9T14W1004G03	DY75A	603	9T14X1004G03	DY74C	661
112.5	9T14W1005G03	DY76A	1030	9T14X1005G03	DY75C	790
150	9T14W1006G03	DX76A	1250	9T14X1006G03	DY77C	1610
225	9T14W1007G03	DY78A	1670	9T14X1007G03	DX77C	1847
300	9T14W1008G03	DX79A	2900	9T14X1008G03	DX79C	3720

480 Primary, 208Y/120 Secondary, 115°C Rise

kVA	Aluminum			Copper		
	Model Number	Accessory Group	Approx. Net Wt.	Model Number	Accessory Group	Approx. Net Wt.
15	9T14W1001G33	UX71A	231	9T14X1001G33	UX72C	353
30	9T14W1002G33	UX73A	444	9T14X1002G33	UX73C	480
45	9T14W1003G33	UY74A	561	9T14X1003G33	UY74C	661
75	9T14W1004G33	DY75A	680	9T14X1004G33	UX74C	748
112.5	9T14W1005G33	DY76A	1250	9T14X1005G33	DX75C	900
150	9T14W1006G33	DX76A	1250	9T14X1006G33	DY77C	1610
225	9T14W1007G33	DY78A	1670	9T14X1007G33	DX78C	2150
300	9T14W1008G33	DX79A	2900	9T14X1008G33	DX79C	3720
500	—	—	—	9T14X1009G33	Call Tech Supp	Call Tech Supp

480 Primary, 208Y/120 Secondary, 80°C Rise

kVA	Aluminum			Copper		
	Model Number	Accessory Group	Approx. Net Wt.	Model Number	Accessory Group	Approx. Net Wt.
15	9T14W1001G63	UX72A	330	9T14X1001G63	UX72C	353
30	9T14W1002G63	UX73A	444	9T14X1002G63	UX73C	480
45	9T14W1003G63	UY74A	561	9T14X1003G63	UY74C	661
75	9T14W1004G63	DX75A	830	9T14X1004G63	DY75C	790
112.5	9T14W1005G63	DX76A	1250	9T14X1005G63	DY76C	1085
150	9T14W1006G63	DX77A	1670	9T14X1006G63	DX77C	1610
225	9T14W1007G63	DY78A	1985	9T14X1007G63	DX78C	2150
500	—	—	—	9T14X1008G63	DX79C	3720

K-Factor

3-Phase, K=13, DOE 2016 Efficiency

480 Primary, 208Y/120 Secondary, 150°C Rise

kVA	Aluminum			Copper		
	Model Number	Accessory Group	Approx. Net Wt.	Model Number	Accessory Group	Approx. Net Wt.
15	9T11W1001G03	UX71A	231	9T11X1001G03	UX71C	230
30	9T11W1002G03	UX73A	444	9T11X1002G03	UX72C	353
45	9T11W1003G03	UX73A	444	9T11X1003G03	UX73C	480
75	9T11W1004G03	UX74A	603	9T11X1004G03	DY75C	790
112.5	9T11W1005G03	DY76A	1030	9T11X1005G03	DY75C	790
150	9T11W1006G03	DX76A	1250	9T11X1006G03	DY77C	1610
225	9T11W1007G03	DY78A	1670	9T11X1007G03	DX78C	2150
300	9T11W1008G03	DX79A	2900	9T11X1008G03	DX79C	3720

480 Primary, 208Y/120 Secondary, 115°C Rise

kVA	Aluminum			Copper		
	Model Number	Accessory Group	Approx. Net Wt.	Model Number	Accessory Group	Approx. Net Wt.
15	9T11W1001G33	UX71A	231	9T11X1001G33	UX72C	353
30	9T11W1002G33	UX73A	444	9T11X1002G33	UX73C	480
45	9T11W1003G33	UY74A	561	9T11X1003G33	UY74C	661
75	9T11W1004G33	DY75A	680	9T11X1004G33	DY75C	790
112.5	9T11W1005G33	DX76A	1250	9T11X1005G33	DY76C	1085
150	9T11W1006G33	DY77A	1450	9T11X1006G33	DY77C	1610
225	9T11W1007G33	DY78A	1670	9T11X1007G33	DX79C	3270
300	9T11W1008G33	DX79A	2900	9T11X1008G33	DX79C	3720
500	—	—	—	9T11X1009G33	Call Tech Supp	Call Tech Supp

480 Primary, 208Y/120 Secondary, 80°C Rise

kVA	Aluminum			Copper		
	Model Number	Accessory Group	Approx. Net Wt.	Model Number	Accessory Group	Approx. Net Wt.
15	9T11W1001G63	UX72A	330	9T11X1001G63	UX72C	353
30	9T11W1002G63	UY74A	561	9T11X1002G63	UX73C	480
45	9T11W1003G63	UY74A	561	9T11X1003G63	UY74C	661
75	9T11W1004G63	DX75A	830	9T11X1004G63	DY75C	790
112.5	9T11W1005G63	DX77A	1670	9T11X1005G63	DY76C	1085
150	9T11W1006G63	DY78A	1670	9T11X1006G63	DY77C	1610
225	9T11W1007G63	DX79A	2900	9T11X1007G63	DX79C	3720
500	—	—	—	9T11X1008G63	Call Tech Supp	Call Tech Supp

K-Factor Low Noise

3-Phase, K=4, DOE 2016 Efficiency, -3dB Below NEMA ST-20 Standard

480 Primary, 208Y/120 Secondary, 150°C Rise

kVA	Aluminum			Copper		
	Model Number	Accessory Group	Approx. Net Wt.	Model Number	Accessory Group	Approx. Net Wt.
15	9T14W1001G04	UX71A	231	9T14X1001G04	UX71C	230
30	9T14W1002G04	UX73A	444	9T14X1002G04	UX73C	353
45	9T14W1003G04	UX73A	444	9T14X1003G04	UX73C	480
75	9T14W1004G04	UX74A	603	9T14X1004G04	UX74C	661
112.5	9T14W1005G04	DY76A	1030	9T14X1005G04	DY75C	790
150	9T14W1006G04	DX76A	1250	9T14X1006G04	DY77C	1610
225	9T14W1007G04	DY78A	1670	9T14X1007G04	DY78C	1970
300	9T14W1008G04	DX79A	2900	9T14X1008G04	DX79C	3720

480 Primary, 208Y/120 Secondary, 115°C Rise

kVA	Aluminum			Copper		
	Model Number	Accessory Group	Approx. Net Wt.	Model Number	Accessory Group	Approx. Net Wt.
15	9T14W1001G34	UX71A	231	9T14X1001G34	UX72C	353
30	9T14W1002G34	UX73A	444	9T14X1002G34	UX72C	353
45	9T14W1003G34	UY74A	561	9T14X1003G34	UY74C	661
75	9T14W1004G34	DY75A	680	9T14X1004G34	DY75C	790
112.5	9T14W1005G34	DY76A	1030	9T14X1005G34	DX75C	900
150	9T14W1006G34	DX76A	1250	9T14X1006G34	DY77C	1610
225	9T14W1007G34	DY78A	1670	9T14X1007G34	DX78C	2150
300	9T14W1008G34	DX79A	2900	9T14X1008G34	DX79C	3720

480 Primary, 208Y/120 Secondary, 80°C Rise

kVA	Aluminum			Copper		
	Model Number	Accessory Group	Approx. Net Wt.	Model Number	Accessory Group	Approx. Net Wt.
15	9T14W1001G64	UX72A	330	9T14X1001G64	UX72C	353
30	9T14W1002G64	UX73A	444	9T14X1002G64	UX73C	480
45	9T14W1003G64	UY74A	561	9T14X1003G64	UY74C	661
75	9T14W1004G64	DX75A	830	9T14X1004G64	DX75C	790
112.5	9T14W1005G64	DX76A	1250	9T14X1005G64	DX76C	1240
150	9T14W1006G64	DX77A	1670	9T14X1006G64	DX77C	1610
225	9T14W1007G64	DY78A	1670	9T14X1007G64	DX79C	3720
300	9T14W1008G64	DX79A	2900	—	—	—

K-Factor Low Noise

3-Phase, K=13, DOE 2016 Efficiency, -3dB Below NEMA ST-20 Standard

480 Primary, 208Y/120 Secondary, 150°C Rise

kVA	Aluminum			Copper		
	Model Number	Accessory Group	Approx. Net Wt.	Model Number	Accessory Group	Approx. Net Wt.
15	9T11W1001G04	UX71A	231	9T11X1001G04	UX71C	230
30	9T11W1002G04	UX73A	444	9T11X1002G04	UX72C	353
45	9T11W1003G04	UX73A	444	9T11X1003G04	UX73C	480
75	9T11W1004G04	UX74A	603	9T11X1004G04	DY75C	790
112.5	9T11W1005G04	DY76A	1030	9T11X1005G04	DY75C	790
150	9T11W1006G04	DX76A	1250	9T11X1006G04	DY77C	1610
225	9T11W1007G04	DY78A	1670	9T11X1007G04	DY78C	1970
300	9T11W1008G04	DX79A	2900	9T11X1008G04	DX79C	2900

480 Primary, 208Y/120 Secondary, 115°C Rise

kVA	Aluminum			Copper		
	Model Number	Accessory Group	Approx. Net Wt.	Model Number	Accessory Group	Approx. Net Wt.
15	9T11W1001G34	UX71A	231	9T11X1001G34	UX72C	353
30	9T11W1002G34	UX73A	444	9T11X1002G34	UX73C	480
45	9T11W1003G34	UY74A	561	9T11X1003G34	UY74C	661
75	9T11W1004G34	DY75A	680	9T11X1004G34	DY75C	790
112.5	9T11W1005G34	DX76A	1250	9T11X1005G34	DY76C	1085
150	9T11W1006G34	DY77A	1450	9T11X1006G34	DY77C	1610
225	9T11W1007G34	DY78A	1670	9T11X1007G34	DX79C	3720
300	9T11W1008G34	DX79A	2900	9T11X1008G34	DX79C	3720

480 Primary, 208Y/120 Secondary, 80°C Rise

kVA	Aluminum			Copper		
	Model Number	Accessory Group	Approx. Net Wt.	Model Number	Accessory Group	Approx. Net Wt.
15	9T11W1001G64	UX72A	330	9T11X1001G64	UX72C	353
30	9T11W1002G64	UY74A	561	9T11X1002G64	UY74C	661
45	9T11W1003G64	UY74A	561	9T11X1003G64	UY74C	661
75	9T11W1004G64	DY75A	680	9T11X1004G64	DY75C	790
112.5	9T11W1005G64	DX77A	1670	9T11X1005G64	DX76C	1240
150	9T11W1006G64	DY78A	1670	9T11X1006G64	DY77C	1610
225	—	—	—	9T11X1007G64	DX79C	3720

K-Factor Low Noise

3-Phase, K=20, DOE 2016 Efficiency, -3dB Below NEMA ST-20 Standard

480 Primary, 208Y/120 Secondary, 150°C Rise

kVA	Aluminum			Copper		
	Model Number	Accessory Group	Approx. Net Wt.	Model Number	Accessory Group	Approx. Net Wt.
15	9T10W1001G02	UX71A	231	9T10X1001G02	UX71C	230
30	9T10W1002G02	UX72A	330	9T10X1002G02	UX72C	353
45	9T10W1003G02	UX73A	444	9T10X1003G02	UX73C	480
75	9T10W1004G02	UY74A	561	9T10X1004G02	UY74C	661
112.5	9T10W1005G02	DY75A	680	9T10X1005G02	DY75C	790
150	9T10W1006G02	DY76A	1030	9T10X1006G02	DY76C	1085
225	9T10W1007G02	DY77A	1450	9T10X1007G02	DY77C	1610
300	9T10W1008G02	DY78A	1670	9T10X1008G02	DY78C	1970
500	9T10W1009G02	DX79A	2900	9T10X1009G02	DX79C	3720

480 Primary, 208Y/120 Secondary, 115°C Rise

kVA	Aluminum			Copper		
	Model Number	Accessory Group	Approx. Net Wt.	Model Number	Accessory Group	Approx. Net Wt.
15	9T10W1001G32	UX71A	231	9T10X1001G32	UX71C	230
30	9T10W1002G32	UX72A	330	9T10X1002G32	UX72C	353
45	9T10W1003G32	UX73A	444	9T10X1003G32	UX73C	480
75	9T10W1004G32	UX74A	603	9T10X1004G32	UX74C	748
112.5	9T10W1005G32	DX75A	830	9T10X1005G32	DX75C	900
150	9T10W1006G32	DX76A	1250	9T10X1006G32	DX76C	1240
225	9T10W1007G32	DX77A	1670	9T10X1007G32	DX77C	1847
300	9T10W1008G32	DX79A	1985	9T10X1008G32	DX79C	2150
500	9T10W1009G32	DX79A	2900	9T10X1009G32	DX79C	3720

480 Primary, 208Y/120 Secondary, 80°C Rise

kVA	Aluminum			Copper		
	Model Number	Accessory Group	Approx. Net Wt.	Model Number	Accessory Group	Approx. Net Wt.
15	9T10W1001G62	UX72A	330	9T10X1001G62	UX72C	353
30	9T10W1002G62	UX73A	444	9T10X1002G62	UX73C	480
45	9T10W1003G62	UY74A	561	9T10X1003G62	UY74C	661
75	9T10W1004G62	DY75A	680	9T10X1004G62	DY75C	790
112.5	9T10W1005G62	DY76A	1030	9T10X1005G62	DY76C	1085
150	9T10W1006G62	DY77A	1450	9T10X1006G62	DY77C	1610
225	9T10W1007G62	DX78A	1985	9T10X1007G62	DX78C	2150
300	9T10W1008G62	DX79A	2900	9T10X1008G62	DX79C	3720

Noise Isolation

3-Phase, DOE 2016 Efficiency, Guard 1 (Electrostatic Shield)

480 Primary, 208Y/120 Secondary, 150°C Rise

kVA	Aluminum			Copper		
	Model Number	Accessory Group	Approx. Net Wt.	Model Number	Accessory Group	Approx. Net Wt.
15	9T10W1001G03	UX71A	231	9T10X1001G03	UX71C	230
30	9T10W1002G03	UX72A	330	9T10X1002G03	UX72C	353
45	9T10W1003G03	UX73A	444	9T10X1003G03	UX73C	480
75	9T10W1004G03	UY74A	561	9T10X1004G03	UY74C	661
112.5	9T10W1005G03	DY75A	680	9T10X1005G03	DY75C	790
150	9T10W1006G03	DY76A	1030	9T10X1006G03	DY76C	1085
225	9T10W1007G03	DX77A	1450	9T10X1007G03	DY77C	1610
300	9T10W1008G03	DY78A	1670	9T10X1008G03	DY78C	1970
500	9T10W1009G03	DX79A	2900	9T10X1009G03	DX79C	3720

480 Primary, 208Y/120 Secondary, 115°C Rise

kVA	Aluminum			Copper		
	Model Number	Accessory Group	Approx. Net Wt.	Model Number	Accessory Group	Approx. Net Wt.
15	9T10W1001G33	UX71A	231	9T10X1001G33	UX71C	230
30	9T10W1002G33	UX72A	330	9T10X1002G33	UX72C	353
45	9T10W1003G33	UX73A	444	9T10X1003G33	UX73C	480
75	9T10W1004G33	UY74A	603	9T10X1004G33	UX74C	748
112.5	9T10W1005G33	DX75A	830	9T10X1005G33	DX75C	900
150	9T10W1006G33	DX76A	1250	9T10X1006G33	DX76C	1240
225	9T10W1007G33	DX77A	1670	9T10X1007G33	DX77C	1847
300	9T10W1008G33	DX78A	1985	9T10X1008G33	DX78C	2150
500	9T10W1009G33	DX79A	2900	9T10X1009G33	DX79C	3720

480 Primary, 208Y/120 Secondary, 80°C Rise

kVA	Aluminum			Copper		
	Model Number	Accessory Group	Approx. Net Wt.	Model Number	Accessory Group	Approx. Net Wt.
15	9T10W1001G63	UX72A	330	9T10X1001G63	UX72C	353
30	9T10W1002G63	UX73A	444	9T10X1002G63	UX73C	480
45	9T10W1003G63	UY74A	561	9T10X1003G63	UY74C	661
75	9T10W1004G63	DY75A	680	9T10X1004G63	DY75C	790
112.5	9T10W1005G63	DY76A	1030	9T10X1005G63	DY76C	1085
150	9T10W1006G63	DY77A	1450	9T10X1006G63	DY77C	1610
225	9T10W1007G63	DX78A	1985	9T10X1007G63	DX78C	2150
300	9T10W1008G63	DX79A	2900	9T10X1008G63	DX79C	3720

Midtapped

3-Phase, DOE 2016 Efficiency, 60 Hz

480 Primary, 240/120 Secondary, 150°C Rise

kVA	Aluminum			Copper		
	Model Number	Accessory Group	Approx. Net Wt.	Model Number	Accessory Group	Approx. Net Wt.
15	9T10W1181	UX71A	231	9T10X1181	UX71C	230
30	9T10W1182	UX72A	330	9T10X1182	UX72C	353
45	9T10W1183	UX73A	444	9T10X1183	UX73C	480
75	9T10W1184	UY74A	561	9T10X1184	UY74C	661
112.5	9T10W1185	DX75A	830	9T10X1185	DY75C	790
150	9T10W1186	DY76A	1030	9T10X1186	DY76C	1085
225	9T10W1187	DY77A	1450	9T10X1187	DY77C	1610
300	9T10W1188	DY78A	1670	9T10X1188	DY78C	1970
500	9T10W1189	DX79A	2900	9T10X1189	DX79C	3720

480 Primary, 240/120 Secondary, 115°C Rise

kVA	Aluminum			Copper		
	Model Number	Accessory Group	Approx. Net Wt.	Model Number	Accessory Group	Approx. Net Wt.
15	9T10W1181G31	UX71A	231	9T10X1181G31	UX71C	230
30	9T10W1182G31	UX72A	330	9T10X1182G31	UX72C	353
45	9T10W1183G31	UX73A	444	9T10X1183G31	UX73C	480
75	9T10W1184G31	UX74A	603	9T10X1184G31	UX74C	748
112.5	9T10W1185G31	DX75A	830	9T10X1185G31	DX75C	900
150	9T10W1186G31	DX76A	1250	9T10X1186G31	DX76C	1240
225	9T10W1187G31	DX77A	1670	9T10X1187G31	DX77C	1847
300	9T10W1188G31	DX78A	1985	9T10X1188G31	DX78C	2150
500	9T10W1189G31	DX79A	2900	9T10X1189G31	DX79C	3720

480 Primary, 240/120 Secondary, 80°C Rise

kVA	Aluminum			Copper		
	Model Number	Accessory Group	Approx. Net Wt.	Model Number	Accessory Group	Approx. Net Wt.
15	9T10W1181G61	UX72A	330	9T10X1181G61	UX72C	353
30	9T10W1182G61	UX73A	444	9T10X1182G61	UX73C	480
45	9T10W1183G61	UY74A	561	9T10X1183G61	UY74C	661
75	9T10W1184G61	DY75A	680	9T10X1184G61	DY75C	790
150	9T10W1186G61	DY77A	1450	9T10X1185G61	DY76C	1085
225	9T10W1187G61	DX78A	1985	9T10X1186G61	DY77C	1610
300	—	—	—	9T10X1187G61	DX78C	2150
500	—	—	—	9T10X1188G61	DX79C	3720

Accessories and Lugs

1-Phase and 3-Phase

Rainshield Kit

Accessory Group	Model Number
UX71A	9T18W1071G06
UX71C	9T18W1071G06
UX72A	9T18W1072G06
UX72C	9T18W1072G06
UX73A	9T18W1072G06
UX73C	9T18W1072G06
UY74A	9T18W1074G06
UX74A	9T18W1074G06
UY74C	9T18W1074G06
UX74C	9T18W1074G06
DY75A	9T18W1074G06
DY75C	9T18W1074G06
DX75A	9T18W1076G06
DX75C	9T18W1074G06
DY76A	9T18W1076G06
DY76C	9T18W1076G06
DX76A	9T18W1077G06
DX76C	9T18W1076G06
DX77A	9T18W1077G06
DX77C	9T18W1077G06
DY77A	9T18W1077G06
DY77C	9T18W1077G06
DY78C	9T18W1077G06
DY78A	9T18W1077G06
DX78A	9T18W1077G06
DX78C	9T18W1077G06
DX79A	9T18W1079G06
DX79C	9T18W1079G06
YF171	9T18W4317G05
YF172	9T18W4317G06
YF173	9T18W4317G06
YF174	9T18W4317G06
YF175	9T18W4322G77
YF176	9T18W4322G79
YF177	9T18W4322G79

Lug Kit

Accessory Group	Model Number
UX71A	9T18W1071G10
UX71C	9T18W1071G10
UX72A	9T18W1072G10
UX73A	9T18W1072G10
UX72C	9T18W1072G10
UX73C	9T18W1072G10
UY74A	9T18W1074G10
UX74A	9T18W1074G10
UY74C	9T18W1074G10
UX74C	9T18W1074G10
DY75A	9T18W1075G10
DY75C	9T18W1075G10
DX75C	9T18W1075G10
DY76A	9T18W1076G10
DY76C	9T18W1076G10
DX75A	9T18W1076G10
DX76C	9T18W1076G10
DY77A	9T18W1077G10
DY77C	9T18W1077G10
DX76A	9T18W1077G10
DX77A	9T18W1077G10
DX77C	9T18W1077G10
DY78A	9T18W1078G10
DY78C	9T18W1078G10
DX78A	9T18W1078G10
DX78C	9T18W1078G10
DX79A	9T18W1079G10
DX79C	9T18W1079G10
YF171	9T18W7240G02
YF172	9T18W7241G03
YF173	—
YF174	9T18W7240G03
YF175	9T18W7242G07
YF176	9T18W7242G05
YF177	—

Wall Mount Bracket

Accessory Group	Model Number
UX71A	9T18W1071G07
UX71C	9T18W1071G07
UX72A	9T18W1071G07
UX72C	9T18W1071G07
UX73A	9T18W1071G07
UX73C	9T18W1071G07
UX74A	9T18W1074G07
UX74C	9T18W1074G07
UY74A	9T18W1074G07
UY74C	9T18W1074G07
DX75C	9T18W1074G07
DY75A	9T18W1074G07
DY75C	9T18W1074G07
YF171	9T18W5042
YF172	9T18W5043
YF173	9T18W5043
YF174	9T18W5043
YF175	Not available
YF176	Not available
YF177	Not available

Accessories and Lugs

1-Phase and 3-Phase

Bottom Panel

Accessory Group	Model Number
DX76A	9T18W1077G09
DX77A	9T18W1077G09
DX77C	9T18W1077G09
DY77A	9T18W1077G09
DY77C	9T18W1077G09
DX78A	9T18W1078G09
DX78C	9T18W1078G09
DY78A	9T18W1078G09
DY78C	9T18W1078G09
DX79A	9T18W1079G09
DX79C	9T18W1079G09
YF175	9T18W4504G77
YF176	9T18W4504G79
YF177	9T18W4504G79

316 Stainless Steel Rainshield Kit

Accessory Group	Model Number
UX71A	9T18W1171G06
UX71C	9T18W1171G06
UX72A	9T18W1172G06
UX73A	9T18W1172G06
UX72C	9T18W1172G06
UX73C	9T18W1172G06
UY74A	9T18W1174G06
UX74A	9T18W1174G06
UY74C	9T18W1174G06
UX74C	9T18W1174G06
DY75A	9T18W1174G06
DY75C	9T18W1174G06
DX75C	9T18W1174G06
DY76A	9T18W1176G06
DY76C	9T18W1176G06
DX75A	9T18W1176G06
DX76C	9T18W1176G06

Ground Bar Kit

Accessory Group	Model Number
UX71A	9T18W1071G11
UX71C	9T18W1071G11
UX72A	9T18W1071G11
UX73A	9T18W1071G11
UX72C	9T18W1071G11
UX73C	9T18W1071G11
UY74A	9T18W1074G11
UX74A	9T18W1074G11
UY74C	9T18W1074G11
UX74C	9T18W1074G11
DY75A	9T18W1074G11
DY76A	9T18W1074G11
DY75C	9T18W1074G11
DY76C	9T18W1074G11
DX75A	9T18W1074G11
DX75C	9T18W1074G11
DX76C	9T18W1074G11

Accessories and Lugs

1-Phase and 3-Phase

Lug Kit Information, 1-Phase

Accessory Group	Typical Transformer Size	Primary Bus Bar Holes (Qty/Diameter)	Secondary Bus Bar Holes (Qty/Diameter)	Kit Number	Specified Lug Kit					
					Lug Size No. 1			Lug Size No. 2		
					Qty.	Conductor Size	Stud Hole Size	Qty.	Conductor Size	Stud Hole Size
YF171	15/25 kVA (2670/2671)	(2) .406	(2) .406	9T18W7240G02 ¹	8	6 AWG – 250 MCM	5/16	—	—	—
YF171	37.5 kVA (2672)	(2) .563	(2) .563	9T18W7240G02	8	6 AWG – 250 MCM	5/16	—	—	—
YF172	50 kVA (2673)	(2) .563	(2) .563	9T18W7241G03	4	6 AWG – 250 MCM	5/16	4	6 AWG – 350 MCM	3/8
YF174	75 kVA (2674)	(2) .563	(2) .563	9T18W7240G03	12	6 AWG – 250 MCM	5/16	—	—	—
YF175	100 kVA (2675)	(2) .563	(2) .563	9T18W7242G07	12	6 AWG – 350 MCM	3/8	—	—	—
YF176	167 kVA (2676)	(4) .563	(4) .563	9T18W7242G05	8	6 AWG – 350 MCM	3/8	12	4 AWG – 500 MCM	3/8

Lug Kit Information, 3-Phase

Accessory Group	Typical Transformer Size	Primary Bus Bar Holes (Qty/Diameter)	Secondary Bus Bar Holes (Qty/Diameter)	Kit Number	Specified Lug Kit					
					Lug Size No. 1			Lug Size No. 2		
					Qty.	Conductor Size	Stud Hole Size	Qty.	Conductor Size	Stud Hole Size
UX71A/UX71C	15 kVA (001)	(2) .406	(2) .406	9T18W1071G10 ¹	7	14 AWG – 1/0 AWG	1/4	—	—	—
UX72A/UX72C/ UX73A/UX73C	30/45 kVA (002/003)	(2) .406	(2) .406	9T18W1072G10 ¹	7	6 AWG – 250 MCM	5/16	—	—	—
UX74A/UX74C/ UY74A/UY74C	75 kVA (004)	(2) .406	(2) .406	9T18W1074G10	3	6 AWG – 250 MCM	5/16	8	6 AWG – 350 MCM	3/8
DX75C/DY75A/ DY75C	112.5 kVA (005)	(1) .563	(2) .563	9T18W1075G10	11	6 AWG – 350 MCM	3/8	—	—	—
DX75A/DX76C/ DY76A/DY76C	150 kVA (006)	(1) .563	(2) .563	9T18W1076G10	3	6 AWG – 350 MCM	3/8	8	4 AWG – 500 MCM	3/8
DX76A/DX77A/ DX77C/DY77A/ DY77C	225 kVA (007)	(2) .563	(4) .563	9T18W1077G10	22	6 AWG – 350 MCM	3/8	—	—	—
DX78A/DX78C/ DY78A/DY78C	300 kVA (008)	(2) .563	(4) .563	9T18W1078G10	6	6 AWG – 350 MCM	3/8	16	4 AWG – 500 MCM	3/8
DX79A/DX79C	400-500 kVA (009)	(4) .563	(6) .563	9T18W1079G10	9	6 AWG – 350 MCM	3/8	24	4 AWG – 500 MCM	3/8

¹ Proximity of bus bars would prohibit dual lugs per bus bar.

Enclosure Parts

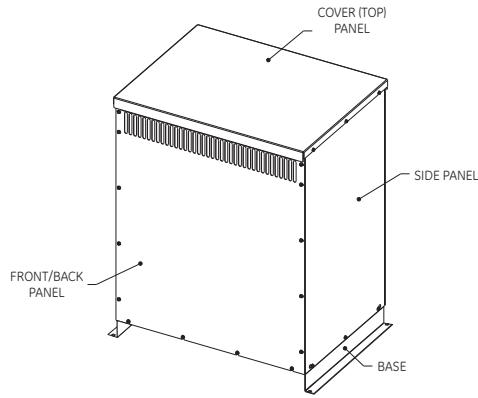

Fig. A

DX75A, DX75C, DY75A, DY75C, DY76A, DY76C, UX71A, UX71C, UX72A, UX72C, UX73A, UX73C, UX74A, UX74C, UY74A, UY74C
Enclosure kit: 1 cover + 2 sides + 2 fronts

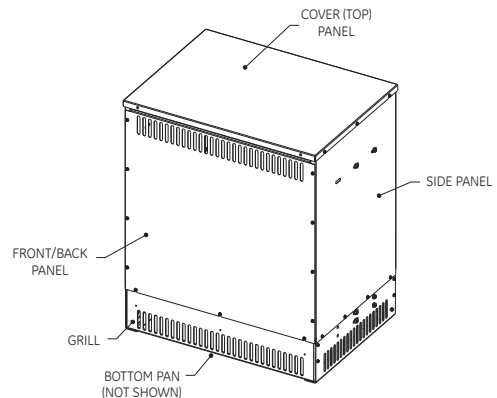

Fig. B

DX76A, DX76C, DX77A, DX77C, DX78A, DX78C, DX79A, DY77A, DY77C, DY78A, DY78C, DY79C
Enclosure kit: 1 cover + 2 sides + 2 fronts

Enclosure Kit

Fig.	Accessory Group	Model Number
A	UX71A	9T18W1071
A	UX72A	9T18W1072
A	UX73A	9T18W1072
A	UX72C	9T18W1072
A	UX73C	9T18W1072
A	UY74A	9T18W1074
A	UX74A	9T18W1074
A	UY74C	9T18W1074
A	UX74C	9T18W1074
A	DY75A	9T18W1075
A	DY75C	9T18W1075
A	DX75C	9T18W1075
A	DY76A	9T18W1076
A	DY76C	9T18W1076
A	DX75A	9T18W1076
B	DX76C	9T18W1076
B	DY77A	9T18W1077
B	DY77C	9T18W1077
B	DX76A	9T18W1077
B	DX77A	9T18W1077
B	DX77C	9T18W1077
B	DY78A	9T18W1078
B	DY78C	9T18W1078
B	DX78A	9T18W1078
B	DX78C	9T18W1078
B	DX79A	9T18W1079
B	DY79C	9T18W1079

Cover (Top) Panel

Fig.	Accessory Group	Model Number
A	UX71A	9T18W1071G05
A	UX71C	9T18Y1071G05
A	UX72A	9T18Y1072G05
A	UX73A	9T18Y1072G05
A	UX72C	9T18Y1072G05
A	UX73C	9T18Y1072G05
A	UY74A	9T18Y1074G05
A	UX74A	9T18Y1074G05
A	UY74C	9T18Y1074G05
A	UX74C	9T18Y1074G05
A	DY75A	9T18Y1074G05
A	DY75C	9T18Y1074G05
A	DX75C	9T18Y1074G05
A	DY76A	9T18Y1076G05
A	DY76C	9T18Y1076G05
A	DX75A	9T18Y1076G05
B	DX76C	9T18Y1076G05
B	DY77A	9T18Y1077G05
B	DY77C	9T18Y1077G05
B	DX76A	9T18Y1077G05
B	DX77A	9T18Y1077G05
B	DX77C	9T18Y1077G05
B	DY78A	9T18Y1078G05
B	DY78C	9T18Y1078G05
B	DX78A	9T18Y1078G05
B	DX78C	9T18Y1078G05
B	DX79A	9T18Y1079G05
B	DY79C	9T18Y1079G05

Enclosure Parts

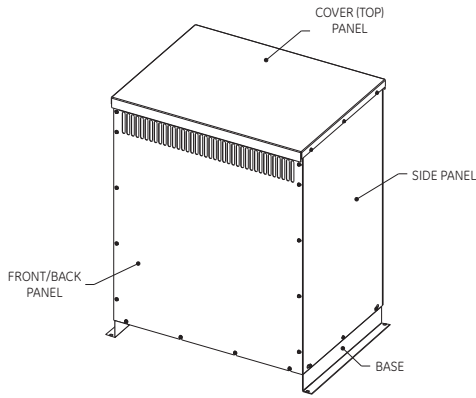

Fig. A

UX71A, UX71C, UX72A, UX72C, UX73A, UX73C, UX74A, UX74C, UY74A, UY74C,
DX75A, DX75C, DY75A, DY75C, DY76A, DY76C
Enclosure kit: 1 cover + 2 sides + 2 fronts

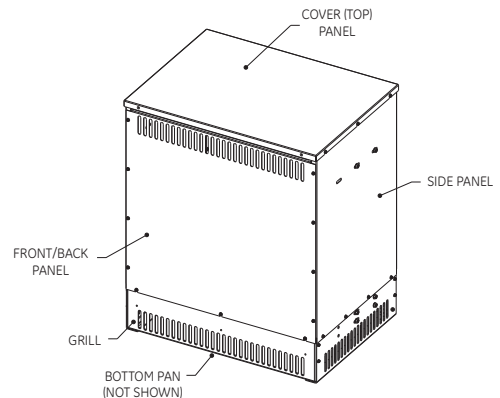

Fig. B

DX75A, DX76A, DX76C, DX77A, DX77C, DX78A, DX78C, DX79A,
DY77A, DY77C, DY78A, DY78C, DY79C,
Enclosure kit: 1 cover + 2 sides + 2 fronts

Front/Back Panel

Fig.	Accessory Group	Model Number
A	UX71A	9T18W1071G03
A	UX71C	9T18W1071G03
A	UX72A	9T18W1072G03
A	UX73A	9T18W1072G03
A	UX72C	9T18W1072G03
A	UX73C	9T18W1072G03
A	UY74A	9T18W1074G03
A	UX74A	9T18W1074G03
A	UY74C	9T18W1074G03
A	UX74C	9T18W1074G03
A	DY75A	9T18W1075G03
A	DY75C	9T18W1075G03
A	DX75C	9T18W1075G03
A	DY76A	9T18W1076G03
A	DY76C	9T18W1076G03
B	DX75A	9T18W1076G03
B	DX76C	9T18W1076G03
B	DY77A	9T18W1077G03
B	DY77C	9T18W1077G03
B	DX76A	9T18W1077G03
B	DX77A	9T18W1077G03
B	DX77C	9T18W1077G03
B	DY78A	9T18W1078G03
B	DY78C	9T18W1078G03
B	DX78A	9T18W1078G03
B	DX78C	9T18W1078G03
B	DX79A	9T18W1079G03
B	DY79C	9T18W1079G03



Side Panel

Fig.	Accessory Group	Model Number
A	UX71A	9T18W1071G04
A	UX71C	9T18W1071G04
A	UX72A	9T18W1072G04
A	UX73A	9T18W1072G04
A	UX72C	9T18W1072G04
A	UX73C	9T18W1072G04
A	UY74A	9T18W1074G04
A	UX74A	9T18W1074G04
A	UY74C	9T18W1074G04
A	UX74C	9T18W1074G04
A	DY75A	9T18W1075G04
A	DY75C	9T18W1075G04
A	DX75C	9T18W1075G04
A	DY76A	9T18W1076G04
A	DY76C	9T18W1076G04
A	DX75A	9T18W1076G04
B	DX76C	9T18W1076G04
B	DY77A	9T18W1077G04
B	DY77C	9T18W1077G04
B	DX76A	9T18W1077G04
B	DX77A	9T18W1077G04
B	DX77C	9T18W1077G04
B	DY78A	9T18W1078G04
B	DY78C	9T18W1078G04
B	DX78A	9T18W1078G04
B	DX78C	9T18W1078G04
B	DX79A	9T18W1079G04
B	DY79C	9T18W1079G04



General Purpose Encapsulated

1-Phase, NEMA 3R, .05 – 3 kVA, Indoor/Outdoor





240 x 480 Primary, 120/240 Secondary, 60 Hz

kVA	Model Number	Unit Wt.	Accessory Group	Taps	UL
.05	9T51W0002	6	6100	No Taps	 
.075	9T51W0003	6	6200		
.1	9T51W0004	6	6200		
.15	9T51W0005	10	8175		
.25	9T51W0007	10	8175		
.5	9T51W0008	16	10200		
.75	9T51W0009	25	12200		
1	9T51W0010	25	12225		
1.5	9T51W0011	40	14200		
2	9T51W0012	45	14250		
3	9T51W0013	55	14350		

480 Primary, 120/240 Secondary, 60 Hz

kVA	Model Number	Unit Wt.	Accessory Group	Taps	UL
1	9T51W0050	25	12225	(-2 5.0%)	 
1.5	9T51W0051	40	14200		
2	9T51W0052	45	14250		
3	9T51W0053	55	14350		
3	9T51W0135	55	14350	(+2,-2 2.5%)	

600 Primary, 120/240 Secondary, 60 Hz



kVA	Model Number	Unit Wt.	Accessory Group	Taps	UL
1	9T51W0070	25	12225	(-2 5.0%)	 
1.5	9T51W0071	40	14200		
2	9T51W0072	45	14250		
3	9T51W0073	55	14350		
.05	9T51W0082	6	6100	No Taps	 
.075	9T51W0083	6	6200		
.1	9T51W0084	6	6200		
.15	9T51W0085	10	8175		
.25	9T51W0087	10	8175		
.5	9T51W0088	16	10200		
.75	9T51W0089	25	12200		
1	9T51W0090	25	12225		
1.5	9T51W0091	40	14200		
2	9T51W0092	45	14250		
3	9T51W0093	55	14350		

* For Wiring Diagrams, refer to MET-028.



General Purpose Encapsulated

1-Phase, NEMA 3R, .05 – 3 kVA, Indoor/Outdoor



120 x 240 Primary, 120/240 Secondary, 60 Hz

kVA	Model Number	Unit Wt.	Accessory Group	Taps	UL
.05	9T51W0022	6	6100	No Taps	 
.1	9T51W0024	6	6200		
.15	9T51W0025	10	8175		
.25	9T51W0027	10	8175		
.5	9T51W0028	16	10200		
.75	9T51W0029	25	12200		
1	9T51W0030	25	12225		
1.5	9T51W0031	40	14200		
2	9T51W0032	45	14250		
3	9T51W0033	60	14400		

208 Primary, 120/240 Secondary, 60 Hz

kVA	Model Number	Unit Wt.	Accessory Group	Taps	UL
.5	9T51W0158	16	10200	No Taps	 
.75	9T51W0159	25	12200		
1	9T51W0160	25	12225		
2	9T51W0156	45	14250		
3	9T51W0157	55	14350		

277 Primary, 120/240 Secondary, 60 Hz



kVA	Model Number	Unit Wt.	Accessory Group	Taps	UL
.25	9T51W0187	10	8175	(-2 5.1%)	 
.5	9T51W0188	16	10200		
.75	9T51W0189	25	12200		
1	9T51W0190	30	12275		
1.5	9T51W0191	40	14200		
2	9T51W0192	45	14250		
3	9T51W0193	55	14350		

* For Wiring Diagrams, refer to MET-028.



General Purpose Encapsulated

1-Phase, NEMA 3R, 5 – 25 kVA, Indoor/Outdoor, 115°C Rise



120 x 240 Primary, 120/240 Secondary, 60 Hz

kVA	Model Number	Unit Wt.	Accessory Group	Taps	UL
5	9T21W1001G02	103	16350	No Taps	 
7.5	9T21W1002G02	147	16600		
10	9T21W1003G02	198	19400		
10	9T21W1054G02	198	19400		
15	9T21W9101	220	19500		
15	9T21W9131	233	19550		
25	9T21W9102	233	19550		

208 Primary, 120/240 Secondary, 60 Hz

kVA	Model Number	Unit Wt.	Accessory Group	Taps	UL
5	9T21W1028G02	103	16350	No Taps	 
7.5	9T21W1029G02	147	16600		
10	9T21W1030G02	198	19400		
15	9T21W9119	220	19500		
25	9T21W9120	388	50500		

277 Primary, 120/240 Secondary, 60 Hz



kVA	Model Number	Unit Wt.	Accessory Group	Taps	UL
5	9T21W1046G02	103	16350	(-2 5.1%)	 
5	9T21W1265G02	103	16350	(-2 2.5%)	
7.5	9T21W1047G02	147	16600	(-2 5.1%)	
10	9T21W1048G02	198	19400	(-2 5.1%)	
10	9T21W1266G02	198	19400	(-2 2.5%)	
15	9T21W9143	220	19500	(-2 5.1%)	
25	9T21W9144	388	50500	(-2 4.7%)	

* For Wiring Diagrams, refer to MET-028.



General Purpose Encapsulated

1-Phase, NEMA 3R, 5 – 25 kVA, Indoor/Outdoor, 115°C Rise



240 x 480 Primary, 120/240 Secondary, 60 Hz

kVA	Model Number	Unit Wt.	Accessory Group	Taps	UL
5	9T21W1004G02	103	16350	No Taps	 
7.5	9T21W1005G02	147	16600		
10	9T21W1006G02	198	19400		
15	9T21W9103	220	19500		
25	9T21W9104	388	50500		

480 Primary, 120/240 Secondary, 60 Hz

kVA	Model Number	Unit Wt.	Accessory Group	Taps	UL
5	9T21W1007G02	103	16350	(-2 5.0%)	 
5	9T21W1013G02	103	16350	(+2,-2 2.5%)	
7.5	9T21W1008G02	147	16600	(-2 5.0%)	
7.5	9T21W1014G02	147	16600	(+2,-2 2.5%)	
10	9T21W1009G02	198	19400	(-2 4.9%)	
10	9T21W1015G02	198	19400	(+2,-2 2.6%)	
15	9T21W9105	220	19500	(-2 5.0%)	
15	9T21W9109	220	19500	(+2,-2 2.5%)	
25	9T21W9106	388	50500	(-2 5.0%)	
25	9T21W9110	388	50500	(+2,-2 2.5%)	

600 Primary, 120/240 Secondary, 60 Hz

kVA	Model Number	Unit Wt.	Accessory Group	Taps	UL
5	9T21W1016G02	103	16350	No Taps	 
5	9T21W1019G02	103	16350	(-2 5.0%)	
5	9T21W1025G02	107	16350	(+2,-2 2.5%)	
7.5	9T21W1020G02	147	16600	(-2 5.0%)	
10	9T21W1021G02	198	19400	(-2 4.9%)	
15	9T21W9111	220	19500	No Taps	
15	9T21W9113	220	19500	(-2 4.8%)	
25	9T21W9114	388	50500	(-2 5.0%)	

* For Wiring Diagrams, refer to MET-028.

Buck-Boost Encapsulated

Buck-boost transformers are small, single-phase, dry type distribution transformers designed and shipped as insulating/isolating transformers. They have a dual voltage primary and a dual voltage secondary. These transformers can be connected for a wide range of voltage combinations. The most common use is to buck (lower) or boost (raise) the supply voltage a small amount, usually 5 to 27%. Buck-boost transformers comply with NEC Article 210-9, Exception 1, when field connected as an autotransformer.

Midwest bucking and boosting transformers provide an economical and convenient means for bucking or boosting voltage, usually no more than $\pm 20\%$ on single- and three-phase circuits. They are compact, relatively light in weight, and can be easily installed for indoor or outdoor service.

Buck-boost transformers are employed primarily for boosting single- and three-phase circuits by connecting them as autotransformers. When connected as an autotransformer, only the low-voltage, high-current capacity secondary windings are required to carry the load. Because this load is only transformed over a small change in voltage, the buck-boost transformer can handle loads many times its nameplate kVA rating.

The transformers with series-multiple 12/24, 24/48, or 16/32 Volt secondary windings are suitable for a wide variety of applications. Two or more units can be used in various combinations to obtain many other special voltages.



Indoor/Outdoor Type Buck-Boost Transformer,
1-Phase

Key Features

- Convenient and least expensive method of matching line voltage with equipment voltage
- More efficient than equivalent isolation transformers
- Ability to handle loads up to 20 times nameplate rating when connected as an autotransformer
- Ideal for changing line voltages by small amounts
- Primary voltages include 120V, 240V and 480V
- Secondary voltages include 12V, 16V, 24V, 32V, 48V
- Qualified to the seismic requirements of IEEE 693-1997 and IBC-2003
- Efficient insulating materials permit compact size and light weight
- For maximum versatility has dual voltage primary and dual voltage secondary

Installation and Service Ease

- Large, front-accessible wiring compartment permits fast, easy wiring
- Convenient conduit knockouts located on side, bottom and back of wiring compartment
- Many Midwest buck-boost transformers fit competitor mounting footprints
- Indoor or outdoor service

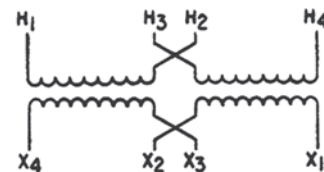

Wiring Diagram for Low Voltage Loads

Buck-Boost Encapsulated

1-Phase, Indoor/Outdoor, For Bucking and Boosting Voltage

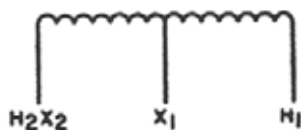

1-Phase Wiring Diagram



3-Phase Wiring Diagram

240/120 Primary, 120 or 240/120 Secondary, 3 wire, 60 Hz

kVA	Model Number	Unit Wt.	Accessory Group	Dimensions (inches)			UL
				Height	Width	Depth	
.5	9T51W0136 ¹	10	8175	7-3/8	6-1/8	4-1/4	
.75	9T51W0137 ¹	16	10200	8-3/8	6-7/8	4-7/8	
1	9T51W0138 ¹	16	10200	8-3/8	6-7/8	4-7/8	
1.5	9T51W0139 ¹	25	12200	9-5/8	7-7/8	5-1/2	
2	9T51W0140 ¹	25	12225	9-5/8	7-7/8	5-1/2	
3	9T51W0141 ¹	40	14200	11-1/8	9-3/8	6-3/4	
5	9T51W0142	60	14400	11-1/8	9-3/8	6-3/4	
10 ²	9T21W4553G02	103	16350	14-1/2	10-5/8	11	
15 ²	9T21W9201	147	16600	17	10-5/8	11	
25 ²	9T21W9202	220	19500	17	12-1/2	12-1/2	

208Y/120 Primary, 230/133 Secondary, 60 Hz

kVA ³	Model Number	Unit Wt.	Accessory Group	Dimensions (inches)			UL
				Height	Width	Depth	
6	9T51W0143	10	8175	7-3/8	6-1/8	4-1/4	
9	9T51W0144	16	10200	8-3/8	6-7/8	4-7/8	
15	9T51W0145	20	10225	8-3/8	6-7/8	4-7/8	
30	9T51W0146	30	12275	9-5/8	7-7/8	5-1/2	
45	9T51W0147	40	14200	11-1/8	9-3/8	6-3/4	
75	9T51W0148	60	14400	11-1/8	9-3/8	6-3/4	

208Y/120 Primary, 240/120 Secondary, 60 Hz

kVA ³	Model Number	Unit Wt.	Accessory Group	Dimensions (inches)			UL
				Height	Width	Depth	
6	9T51W0150	10	8175	7-3/8	6-1/8	4-1/4	
15	9T51W0152	25	12200	9-5/8	7-7/8	5-1/2	
30	9T51W0153	40	14200	11-1/8	9-3/8	6-3/4	
45	9T51W0154	45	14250	11-1/8	9-3/8	6-3/4	

¹ CSA Certified.



² kVA output at 120 Volts, 2 wire, or allowable unbalance at 240/120 Volts, 3 wire.

³ Bank of (3) 1-Phase autotransformers to be connected wye. Price is for one single unit. Dimensions and weights are for each unit in bank. Each single autotransformer is rated 1/3 of the bank kVA rating. Order (3) 1-Phase transformers for each 3-Phase bank.



Buck-Boost Encapsulated

1-Phase, Indoor/Outdoor, For Bucking and Boosting Voltage



120/240 Primary, 12/24 Secondary, 60 Hz

kVA	Model Number	Unit Wt.	Accessory Group	Dimensions (inches)			UL
				Height	Width	Depth	
.05	9T51W0102	6	6100	6-3/8	5-1/8	3-1/4	 
.075	9T51W0103	6	6200	6-3/8	5-1/8	3-1/4	
.1	9T51W0104	6	6200	6-3/8	5-1/8	3-1/4	
.15	9T51W0105	10	8175	7-3/8	6-1/8	4-1/4	
.25	9T51W0107	10	8175	7-3/8	6-1/8	4-1/4	
.5	9T51W0108	20	10225	8-3/8	6-7/8	4-7/8	
.75	9T51W0109	25	12200	9-5/8	7-7/8	5-1/2	
1	9T51W0110	25	12225	9-5/8	7-7/8	5-1/2	
1.5	9T51W0111	40	14200	11-1/8	9-3/8	6-3/4	
2	9T51W0112	50	14300	11-1/8	9-3/8	6-3/4	
3	9T51W0113	55	14350	11-1/8	9-3/8	6-3/4	
5	9T21W1037G02	103	16350	14-1/2	10-5/8	11	

120/240 Primary, 16/32 Secondary, 60 Hz

kVA	Model Number	Unit Wt.	Accessory Group	Dimensions (inches)			UL
				Height	Width	Depth	
.05	9T51W0122	6	6100	6-3/8	5-1/8	3-1/4	 
.075	9T51W0123	6	6200	6-3/8	5-1/8	3-1/4	
.1	9T51W0124	6	6200	6-3/8	5-1/8	3-1/4	
.15	9T51W0125	10	8175	7-3/8	6-1/8	4-1/4	
.25	9T51W0127	10	8175	7-3/8	6-1/8	4-1/4	
.5	9T51W0128	20	10225	8-3/8	6-7/8	4-7/8	
.75	9T51W0129	25	12200	9-5/8	7-7/8	5-1/2	
1	9T51W0130	30	12300	9-5/8	7-7/8	5-1/2	
1.5	9T51W0131	40	14200	11-1/8	9-3/8	6-3/4	
2	9T51W0132	50	14300	11-1/8	9-3/8	6-3/4	
3	9T51W0133	55	14350	11-1/8	9-3/8	6-3/4	
5	9T21W1040G02	115	16400	14-1/2	10-5/8	11	

120/480 Primary, 24/48 Secondary, 60 Hz

kVA	Model Number	Unit Wt.	Accessory Group	Dimensions (inches)			UL
				Height	Width	Depth	
.05	9T51W0202	6	6100	6-3/8	5-1/8	3-1/4	 
.075	9T51W0203	6	6200	6-3/8	5-1/8	3-1/4	
.1	9T51W0204	6	6200	6-3/8	5-1/8	3-1/4	
.15	9T51W0205	10	8175	7-3/8	6-1/8	4-1/4	
.25	9T51W0207	10	8175	7-3/8	6-1/8	4-1/4	
.5	9T51W0208	20	10225	8-3/8	6-7/8	4-7/8	
.75	9T51W0209	25	12200	9-5/8	7-7/8	5-1/2	
1	9T51W0210	30	12275	9-5/8	7-7/8	5-1/2	
1.5	9T51W0211	40	14200	11-1/8	9-3/8	6-3/4	
2	9T51W0212	50	14300	11-1/8	9-3/8	6-3/4	
3	9T51W0213	55	14350	11-1/8	9-3/8	6-3/4	

Control Power Core and Coil

Control Power Core and coil transformers are used to provide voltage to control devices in applications where regulation and minimum space are important. Welded cores provide the highest quality electrical performance and quiet operation.

Standards and Listings

- Conforms to NEMA ST20
- UL listed under UL-5085, File E2739
- CSA Certified under C22.2, Number 66, File 3272

Insulation Classes

- 150VA and below
 - 105°C insulation class, 55°C rise
- 200VA and above
 - 185°C (NEMA) 180°C (UL) insulation class, 115°C rise

Frequency

- 60 Hz standard; 50 Hz optional
- Voltage Regulation
 - All designs 2.0kVA and below are compensated for voltage drop
 - Compensation ranges from 10% in the smallest rating to 3% for the largest

Series-Multiple Secondary Connections

- 120/240V secondaries (series-multiple) may be connected for 120V, 240V or 240/120V three-wire

Overcurrent Protection

- Low impedance transformers that require overcurrent protection for most applications
- Provides optional integral primary and/or secondary fusing

Installation and Service Ease

- Lightweight, small and designed for minimum mounting dimensions
- Many transformers fit competitor mounting footprints

User Safety

- Finger-safe terminals offer added protection and safety
- Pressure plate terminals ensure secure connections
- Wide variety of fusing options

Key Features – Terminal Board Connection

- Rugged, high-impact plastic terminal board
- Full head #8 brass screws assure quick, easy terminations with maximum connection integrity
- Copper windings
- Flexible design allows input or output voltage to match any application
- Available fuse-blocks offer simple, low-cost fusing



Terminal Board Connection





Leads Out Connection



Control Power Core and Coil

1-Phase, Fully Encapsulated, Terminal Board Connection



240 x 440 / 230 x 460 / 240 x 480 Primary,
110/115/120 Secondary, 60 Hz

kVA	Model Number	Unit Wt.	Accessory Group	UL
.05	9T58W0042	2.4	6100	 
.08	9T58W0043	2.8	6125	
.1	9T58W0044	3.6	8100	
.15	9T58W0045	5.1	8150	
.2	9T58W0046	5.8	8175	
.25	9T58W0047	6.5	8200	
.3	9T58W0048	7.6	8250	
.38	9T58W0049	7.6	8250	
.5	9T58W0050	10.7	10225	
.75	9T58W0051	12	12225	
1	9T58W0052	16.1	12300	
2	9T58W0053	26.7	14225	
2	9T58W0054	32.7	14300	
3	9T58W0055	47.4	14475	

208/277/380 Primary, 115/95 Secondary, 50/60 Hz

kVA	Model Number	Unit Wt.	Accessory Group	UL
.05	9T58W0082	3.1	6150	 
.08	9T58W0083	3.6	8100	
.1	9T58W0084	5.1	8150	
.15	9T58W0085	6.5	8200	
.2	9T58W0086	6.5	8200	
.25	9T58W0087	7.6	8250	
.3	9T58W0088	10.7	10225	
.38	9T58W0089	10.7	10225	
.5	9T58W0090	10.7	10225	
.75	9T58W0091	16.1	12300	
1	9T58W0092	26.7	14225	
1.5	9T58W0093	32.7	14300	
2	9T58W0094	47.4	14475	

230/460/575 Primary, 115/95 Secondary, 50/60 Hz

kVA	Model Number	Unit Wt.	Accessory Group	UL
.05	9T58W0062	3.1	6150	 
.08	9T58W0063	3.6	8100	
.1	9T58W0064	5.1	8150	
.15	9T58W0065	6.5	8200	
.2	9T58W0066	6.5	8200	
.25	9T58W0067	7.6	8250	
.3	9T58W0068	10.7	10225	
.38	9T58W0069	10.7	10225	
.5	9T58W0070	10.7	10225	
.75	9T58W0071	16.1	12300	
1	9T58W0072	26.7	14225	
1.5	9T58W0073	32.7	14300	
2	9T58W0074	47.4	14475	

* For Wiring Diagrams, refer to MET-028.

Control Power Core and Coil

1-Phase, Fully Encapsulated, Terminal Board Connection

240 x 280 Primary, 120/240 Secondary, 60 Hz

kVA	Model Number	Unit Wt.	Accessory Group	UL
.05	9T58W2802	2.4	6100	
.08	9T58W2803	2.8	6125	
.1	9T58W2804	3.6	8100	
.15	9T58W2805	5.1	8150	
.2	9T58W2806	5.8	8175	
.25	9T58W2807	6.5	8200	
.3	9T58W2808	6.5	8200	
.38	9T58W2809	7.6	8250	
.5	9T58W2810	10.7	10225	
.75	9T58W2811	12	12225	
1	9T58W2812	16.1	12300	
1.5	9T58W2813	26.7	14225	
2	9T58W2814	32.7	14300	
3	9T58W2815	47.4	14475	

120 x 240 Primary, 12/24 Secondary, 60 Hz

kVA	Model Number	Unit Wt.	Accessory Group	UL
.05	9T58W2873	2.4	6100	
.075	9T58W2874	2.8	6125	
.1	9T58W2875	3.6	8100	
.15	9T58W2876	5.1	8150	
.2	9T58W2877	5.8	8175	
.25	9T58W2878	6.5	8200	
.3	9T58W2879	6.5	8200	

240 x 480 Primary, 12/24 Secondary, 60 Hz

kVA	Model Number	Unit Wt.	Accessory Group	UL
.25	9T58W3024	6.5	8200	
.05	9T58W3164	2.4	6100	
.1	9T58W4132	3.6	8100	
.15	9T58W4133	5.1	8150	

600 Primary, 120/240 Secondary, 60 Hz

kVA	Model Number	Unit Wt.	Accessory Group	UL
.08	9T58W2823	2.8	6125	
.1	9T58W2824	3.6	8100	
.2	9T58W2826	5.8	8175	
.25	9T58W2827	6.5	8200	
.3	9T58W2828	6.5	8200	
.5	9T58W2830	10.7	10225	
.75	9T58W2831	12	12225	
1	9T58W2832	16.1	12300	
1.5	9T58W2833	26.7	14225	
2	9T58W2834	32.7	14300	
3	9T58W2835	47.4	14475	

208 x 240 Primary, 12/24 Secondary, 60 Hz

kVA	Model Number	Unit Wt.	Accessory Group	UL
.05	9T58W4050	2.4	6100	
.1	9T58W4051	3.6	8100	
.15	9T58W4052	5.1	8150	
.25	9T58W4053	6.5	8200	

380/400/416 Primary, 115/230 Secondary, 50/60 Hz

kVA	Model Number	Unit Wt.	Accessory Group	UL
.25	9T58W2975	6.5	8200	
.5	9T58W2978	10.7	10225	
.75	9T58W2979	16.1	12300	
1	9T58W2980	26.7	14225	
1.5	9T58W2981	32.7	14300	
2	9T58W2982	47.4	14475	
3	9T58W2983	47.4	14475	

120 x 240 Primary, 120/240 Secondary, 60 Hz



kVA	Model Number	Unit Wt.	Accessory Group	UL
.1	9T58W2907	3.6	8100	
.2	9T58W2909	5.8	8175	
.3	9T58W2911	6.5	8200	
.5	9T58W2913	10.7	10225	
.75	9T58W2914	12	12225	
1	9T58W2915	16.1	12300	
2	9T58W2917	32.7	14300	
3	9T58W2918	47.4	14475	

* For Wiring Diagrams, refer to MET-028.



Control Power Core and Coil

1-Phase, Fully Encapsulated, Leads Out Connection



120 x 240 Primary, 120/240 Secondary¹, 60 Hz

kVA	Model Number	Unit Wt.	Accessory Group	UL
.05	9T58W1873G07	2.4	6100	 
.075	9T58W1874G07	2.8	6125	
.1	9T58W1875G07	3.6	8100	
.15	9T58W1876G07	5.1	8150	
.2	9T58W1877G07	5.8	8175	
.25	9T58W1878G07	6.5	8200	
.3	9T58W1879G07	6.5	8200	
.5	9T58W1881G07	10.7	10225	
.75	9T58W1882G07	12	12225	
1	9T58W1883G07	26.7	14225	



600 Primary, 120/240 Secondary¹, 60 Hz

kVA	Model Number	Unit Wt.	Accessory Group	UL
0.1	9T58W1824G07	3.6	8100	 
0.2	9T58W1826G07	5.8	8175	
0.3	9T58W1828G07	6.5	8200	
0.5	9T58W1830G07	10.7	10225	
1	9T58W1832G07	26.7	14225	
2	9T58W1834G07	32.7	14300	
3	9T58W1835G07	47.4	14475	

380/400/416 Primary, 115/230 Secondary¹, 50/60 Hz

kVA	Model Number	Unit Wt.	Accessory Group	UL
.5	9T58W1978G07	10.7	10225	 
.75	9T58W1979G07	16.1	12300	
1	9T58W1980G07	26.7	14225	
1.5	9T58W1981G07	32.7	14300	

240 x 480 Primary, 120/240 Secondary¹, 60 Hz

kVA	Model Number	Unit Wt.	Accessory Group	UL
.05	9T58W1802G07	2.4	6100	 
.075	9T58W1803G07	2.8	6125	
.1	9T58W1804G07	3.6	8100	
.15	9T58W1805G07	5.1	8150	
.2	9T58W1806G07	5.8	8175	
.25	9T58W1807G07	6.5	8200	
.3	9T58W1808G07	6.5	8200	
.375	9T58W1809G07	7.6	8250	
.5	9T58W1810G07	10.7	10225	
.75	9T58W1811G07	12	12225	
1	9T58W1812G07	16.1	12300	
1.5	9T58W1813G07	26.7	14225	
2	9T58W1814G07	32.7	14300	
3	9T58W1815G07	47.4	14475	

¹ Secondary fusing not available.

* For Wiring Diagrams, refer to MET-028.

Terminal Strip Connection

Universal Voltage, Multitap, 50/60 Hz

kVA	Model Number	Accessory Group
.25	9T58W3715	10225
.35	9T58W3716	10225
.5	9T58W3717	12225
.75	9T58W3718	12300
1	9T58W3719	14225
1.5	9T58W3720	14300
2	9T58W3721	14475

Voltage

Incoming Voltage				Output Voltage		
H1 H2	H1 H3	H1 H4	H1 H5	X1 X2	X1 X3	X1 X4
208	—	—	500	85	100	110
—	—	415	—	86	104	113
220	380	440	550	91	110	120
230	40	460	575	95	115	125
240	416	480	600	99	120	130

Data subject to change without notice.

Fusing Options

Control Power Core and Coil Transformer Options

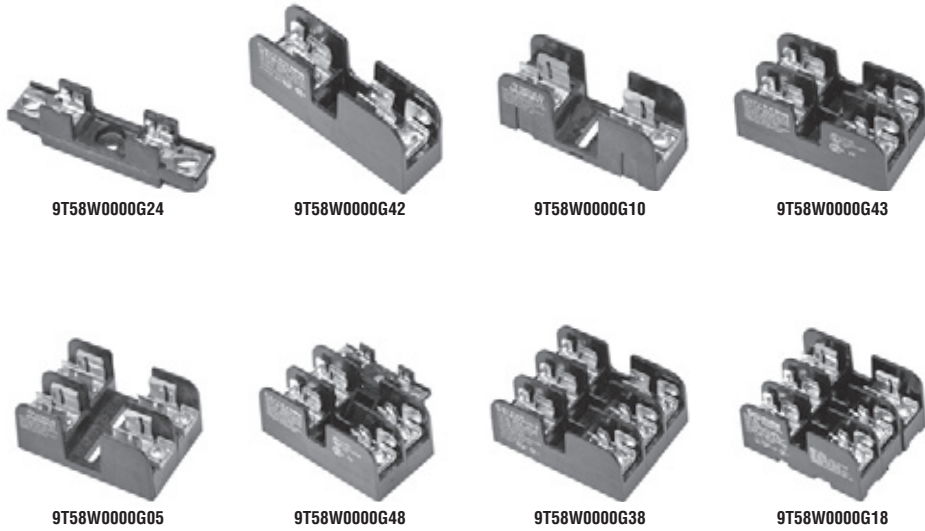

Model Number	Accessory Description
9T58W0000G24	(1) Quarter-Inch Fuseholder
9T58W0000G42	(1) Midget Fuseholder
9T58W0000G10	(1) H/K Fuseholder
9T58W0000G43	(2) CC Fuseholder
9T58W0000G05	(2) H/K Fuseholder
9T58W0000G48	(2) CC + (1) Quarter-Inch Fuseholder
9T58W0000G38	(2) CC + (1) Midget Fuseholder
9T58W0000G18	(2) CC + (1) H/K Fuseholder
9T58W0000G46	(2) CC Fuseholder
9T58W0000G47	(2) CC + (1) Midget Fuseholder
9T58W0000G01	Jumper Links

Fusing Options

Fuse Guide

Midget Class CC Rejection Fuse

Primary Voltage	Transformer Continuous Power Rating (VA)								
	Fuse Rating (Amperes)								
	50	75	100	150	200	250	300	375	500
100	1.50	2.00	3.00	4.00	3.00	4.00	5.00	6.00	8.00
110	1.25	2.00	2.50	4.00	5.00	3.00	4.00	5.00	7.00
120	1.25	1.60	2.50	3.00	5.00	3.00	4.00	5.00	6.00
200	0.75	1.00	1.50	2.00	3.00	3.00	4.00	5.00	4.00
208	0.60	1.00	1.25	2.00	2.50	3.00	4.00	5.00	4.00
220	0.60	1.00	1.25	2.00	2.50	3.00	4.00	5.00	3.00
230	0.60	0.80	1.25	1.60	2.50	3.00	3.00	4.00	3.00
240	0.60	0.80	1.25	1.60	2.50	3.00	3.00	4.00	3.00
277	0.50	0.80	1.00	1.60	2.00	2.50	3.00	4.00	5.00
380	0.30	0.50	0.75	1.00	1.50	1.60	2.00	2.50	3.00
400	0.30	0.50	0.75	1.00	1.50	1.60	2.00	2.50	3.00
416	0.30	0.50	0.60	1.00	1.25	1.60	2.00	2.50	3.00
440	0.30	0.50	0.60	1.00	1.25	1.60	2.00	2.50	3.00
460	0.30	0.40	0.60	0.80	1.25	1.60	1.60	2.00	3.00
480	0.30	0.40	0.60	0.80	1.25	1.50	1.60	2.00	3.00
550	0.25	0.40	0.50	0.80	1.00	1.25	1.60	2.00	2.50
575	0.25	0.30	0.50	0.75	1.00	1.25	1.50	1.60	2.50
600	0.25	0.30	0.50	0.75	1.00	1.25	1.50	1.60	2.50

Secondary Fuse Selection, Glass Fuse

Secondary Voltage	Transformer Continuous Power Rating (VA)													
	Fuse Rating (Amperes)													
	50	75	100	150	200	250	300	375	500	750	1000	1500	2000	3000
12	6.00	10.00	12.00	15.00	20.00	25.00	30.00	—	—	—	—	—	—	—
24	3.00	5.00	6.00	10.00	12.00	12.00	15.00	—	25.00	—	—	—	—	—
36	2.00	3.00	4.00	6.00	8.00	10.00	12.00	—	15.00	—	—	—	—	—
48	1.50	2.50	3.00	5.00	6.00	8.00	10.00	12.00	12.00	—	—	—	—	—
95	0.80	1.25	1.60	2.50	3.00	4.00	5.00	6.00	8.00	12.00	15.00	20.00	25.00	—
110	0.75	1.00	1.50	2.00	3.00	3.00	4.00	5.00	7.00	10.00	12.00	20.00	25.00	30.00
115	0.60	1.00	1.25	2.00	2.50	3.00	4.00	5.00	7.00	10.00	12.00	20.00	20.00	30.00
120	0.60	1.00	1.25	2.00	2.50	3.00	4.00	5.00	6.00	10.00	12.00	15.00	20.00	30.00
208	0.40	0.60	0.80	1.00	1.60	2.00	2.00	3.00	4.00	6.00	8.00	12.00	15.00	20.00
220	0.30	0.50	0.75	1.00	1.50	1.60	2.00	2.50	3.00	5.00	7.00	10.00	12.00	20.00
230	0.30	0.50	0.60	1.00	1.25	1.60	2.00	2.50	3.00	5.00	7.00	10.00	12.00	20.00
240	0.30	0.50	0.60	1.00	1.25	1.60	2.00	2.50	3.00	5.00	6.00	10.00	12.00	15.00

Notes

Section 14

Parts/Accessories / Application Data



Temporary Adapters

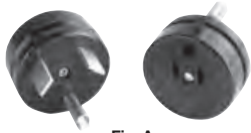

Fig. A
AD2030



Fig. B
AD3020

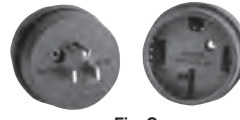







Fig. C
AD5020

Fig.	Model Number	Description	Symbol	UL
A	AD2030	30 Amp / 125 Volt Plug; 15 Amp / 125 Volt Receptacle	 to 	N
B	AD3020	15 Amp / 125 Volt Plug; 30 Amp / 125 Volt Receptacle	 to 	
C	AD5020	15 Amp / 125 Volt Plug; 50 Amp / 125 Volt Receptacle	 to 	

Receptacles and Angle Plugs

Angle Plugs

- Plugs into receptacles at an angle for increased flexibility in limited space
- Molded of Zytel® Nylon – a rugged, impact resistant material



Wiring	Volts	Amps	NEMA Configuration	Model Number		
				Receptacles ²	Receptacles on Plates	Angle Plugs
2 Pole 3-Wire Grounding	125	20A	5-20R (w/ GFCI)	520R2GFI	—	—
		30A	TT-30R ¹	BR32U	PR32U	C32U
R32U	PR32U			C32U		
3 Pole 3-Wire	125/250	30A	10-30R	BR33	PR33	C33
		50A	10-50R	BR53	PR53	C53
3 Pole 4-Wire Grounding	125/250	30A	14-30R	BR34	PR34	C34
		50A	14-50R	BR54U	PR54U	C54U
		60A	14-60R	BR64U	PR64U	C64U
4 Pole 4-Wire	120/208	60A	18-60R	—	—	C54

¹ Travel Trailer use only.

² "BR" prefix models include base mount bracket - "R" prefix = panel mount.

Post Only (with cover)

Features

- Post only with 3 wire openings (back and both sides)
- Earth burial and pad mounted
- Terminal bar assembly with loop feed lugs standard
- Surface mount units may be field installed on these posts (not UL listed)
- Swing-down hasp (latch) for padlock provision
- Painted 16 gauge galvanized steel

Model Number	Style	Terminal Assembly (factory installed)	Dimensions (inches)		
			Height	Width	Depth
P5POST	Pad Mount	LT200B350	59-1/2	9	4-1/2
P6POST	Earth Burial		83-1/2	9	4-1/2



Post Kits



Fig. A
EK126, EK129



Fig. B
MS62

Fig.	Model Number	Style	Kit Components	Dimensions (inches)		
				Height	Width	Depth
A	EK126	Post Extension	(1) Post extension bracket, (2) 1/2" bolts, (2) 1/2" nuts, (4) 1/2" flatwashers	18	6	2
	EK129 ¹			18	9	2
B	MS62	Post Stake	(1) Post stake bracket, (2) 1/2" bolts, (2) 1/2" nuts, (4) 1/2" flatwashers	44	3	1

¹ Add "CW" for WEPCO approved model.

TV/Telephone Add-On

Features

- Bolts on to back of pad mount post, earth burial post or wall at ground level
- Open back and bottom for easy wiring access
- TV/Telephone receptacle may be field replaced with data (Cat5) or other similar feature receptacle
- Includes in use cover



Model Number	Components	Dimensions (inches)			UL
		Height	Width	Depth	
TTV001 ¹	Empty opening at 12" high	18	5	4-1/2	N
TTV001T ^{1,2}					
TTV100 ¹	RJ11 Phone Jack (12" high)				
TTV100T ^{1,2}					
TTV150 ¹	RJ45 Ethernet Connector (12" high)				
TTV150T ^{1,2}					
TTV200	(2) TV/Telephone Openings				

¹ Unit is non-NEMA.

² Unit is used with ParkMate models and tan in color.

Data subject to change without notice.

Raintight (Bolt-on) Hub



Threaded

Hub Opening (inches)	Midwest Hub Number	Universal Hub Number		Std. Pkg.
		Small	Large	
3/4	B07	—	—	10
1	B10	U10	—	
1-1/4	B12	U12	—	
1-1/2	B15	U15	—	
2	B20	U20	U27	
2-1/2	B25	U25	U28	
3	—	—	U30	1
3-1/2	—	—	U35	
4	—	—	U40	
Closure Plate ¹	B01	U01	U04	10

¹ Closure Plate is standard with most Midwest products.

Stabilizer Kits

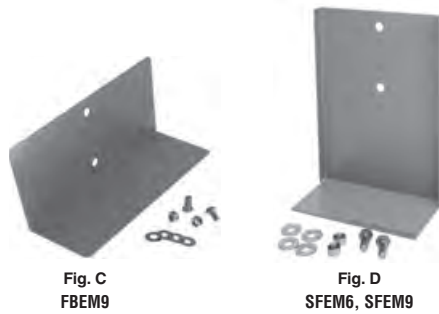

Fig. C
FBEM9

Fig. D
SFEM6, SFEM9

Fig.	Model Number	Style	Wire Install (direction)	Size (inches)
C	FBEM9	Stabilizer Base Kit (Earth Burial Installation)	Back Only	9
D	SFEM6	Stabilizer Foot Kit	Side or Back	6
	SFEM9			9

Top Barrier Kit

Use with Surface Models



Model Number	Description	Size
MSB14T	Isolates load conductors in meter compartment	Fits 14 x 26 surface model

Data subject to change without notice.

Sealing Ring

Use with Ring Type Meter Sockets

Model Number	Style	Type
ASR1	Screw	Aluminum
SNPR1	Snap on	



Meter Socket Cover Plate

Model Number	Style	Type
ARP00920MEP	Screw	Plastic



Circuit Breaker Filler Plates

Model Number	Size (inches)	Type
265A5003P1	1	Metal
265A5003P2	2	

Touch-Up Paint

Model Number	Sherwin-Williams Paint
UHT2-20011	Tan
UGT2-20015	Camo Green
PNS4-C0002	Bronze
PGT2-20042	Gray

* Owner is responsible for purchasing touch-up paint.

Terminal Kit

Model Number	Description
121	5th Terminal Kit

Replacement Deadfront Kit

50 Amp Receptacle Lockout Panel

Model Number	Amps	Kit Components	Cut-out
PLK50	50	Replacement Deadfront and Plate Cover for all U075- or M075- series models	GFCI Duplex

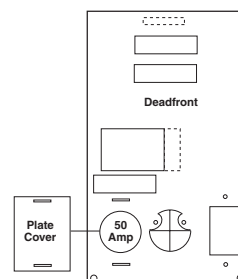

Data subject to change without notice.

Water Shroud

Fig.	Model Number	Color	Description	Dimensions (inches)	
				Height	Width
A	UH60G	Gray	Adapts to 6" wide galvanized steel post	15-1/4	6-3/4
	UH90G	Gray	Adapts to 9" wide galvanized steel post	15-1/4	9-1/2
	UH90GT	Tan		15-1/4	9-1/2
	UH90STL	Stainless		27-1/4	9-1/2



Fig. A
UH60G, UH90G, UH90GT, UH90STL

Water Shroud with TV/Telephone

Fig.	Model Number	Number of Receptacles	Color	Description	Dimensions (inches)	
					Height	Width
A	UH90GTTV1	1	Gray	Adapts to 9" wide galvanized steel post	15-1/4	9-1/2
B	UH90GTTV2	2				



Fig. A
UH90GTTV1



Fig. B
UH90GTTV2

3/4-Turn Hose Bib

Fig.	Model Number	Description	Dimensions (inches)	
			Height	Width
A	UWATER34	Turn knob	2.50	2.13
B	UWATER34L	Lever	2.58	3.87
C	UWATER34WN	Wing nut	2.58	3.87



Fig. A
UWATER34



Fig. B
UWATER34L



Fig. C
UWATER34WN

Meter Kits

Model Number	Description
S-02S-CA20023E	200 Amp Cyclometer California Type Approved Watthour Meter – 240V
S-02S-CA20023LCD	200 Amp Solid State California Type Approved Watthour Meter – 240V
4-GE-727X200001	200 Amp Solid State Watthour Meter – 1PH3W 240V
4-GE-727X100001	100 Amp Solid State Watthour Meter – 1PH2W 120V

Meter Kit Accessories

Model Number	Description
4-PK-BKIT-MIDWEST	BKIT-M = Consists of 4-MS-A4T100R1H1 + 4-MA-HUB1-M + 4-MA-NIP1 + 4-MA-PLSL
4-MS-A4T100R1H1	SKT 4 Term 100A RND 1" 1 Hub
4-MA-HUB1-M	BKIT-M Meter Hub 1"
4-MA-NIP1	BKIT-M Meter Nipple 1"
4-MA-PLSL	BKIT-M Meter Seal Plastic Padlock
4-PK-C1-MIDWEST	CKIT-M = Consists of 4-MS-A4T100R1.25H1 + 4-MA-HUB1.25-M + 4-MA-NIP1.25 + 4-MA-PLSL
4-MS-A4T100R1.25H1	SKT 4 TERM 100A RND 1.25" 1 HUB
4-MA-HUB1.25-M	CKIT-M Meter HUB 1 1/4" Midwest
4-MA-NIP1.25	CKIT-M Meter Nipple 1 1/4"

Data subject to change without notice.

Fuse Holder, Fuse Block, Fuse Block and Pullout

20 – 100 Amps



Fig. A
FH2
 14-20 Cu Only

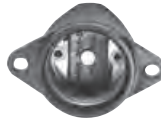

Fig. B
FH1
 14-20 Cu Only



Fig. C
FH3
 14-10 Cu Only



Fig. D
NF65
 14-3

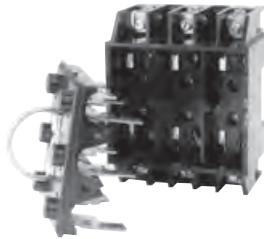

Fig. E
 265A6035G27, 265A6036G69



Fig. F
FR35R

Fuse Holder

Fig.	Model Number	Amps	Wire Range	Description
A	FH2	20	14-10 Cu Only	—
B	FH1	30		
C	FH3	30		

Fuse Block

Fig.	Model Number	Amps	Wire Range	Description
D	NF65	60	14-3 Cu/Al	—

Fuse Block and Pullout

Fig.	Model Number	Amps	Wire Range	Description
E	265A6035G27	30	—	Use for U0353F
E	265A6036G69	60		Use for U0653F
F	FR35R	—		Use for U035F2, FR35R

Pullout, Puller

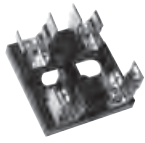

Fig. A
FR352



Fig. B
FR352R

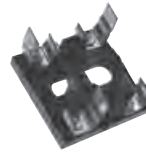

Fig. C
FH682

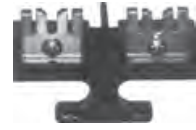

Fig. D
NF652



Fig. E
FR35, FR65
12-3



Fig. F
FR39, FR69
12-3



Fig. G
FR64X2
12-3



Fig. H
FR65X2
12-3

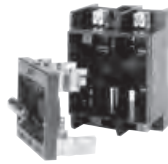

Fig. I
FR66
12-3



Fig. J
FR67
12-3

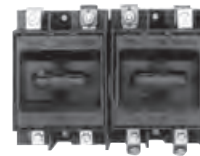

Fig. K
FR67X2
12-1/0

Pullout

Fig.	Model Number	Amps	Wire Range	Description
A	FR352	—	—	Use for P035F, FR35, FR39
B	FR352R			Use for U035F2, FR35R
C	FH682			Use for FR69, FR67, FR66, FR65, FR67X2, FR65X2, FR64X2
D	NF652			Use for NF65

Pullers

Fig.	Model Number	Amps	Wire Range	Description
E	FR35	30	12-3 Cu/Al	—
F	FR39	30		
G	FR64X2	60		
E	FR65	60		
H	FR65X2	60		
I	FR66	60		
J	FR67	60		
F	FR69	60		
K	FR67X2	100	12-1/0 Cu/Al	

Circuit Breakers



Figs. A – E
CB115 / THQL115



Figs. F – E
CB115T / THQP115



Figs. K – O, S – U
CB220 / THQL2120



Figs. P – R
CB220T / THQP220



Figs. V – V2
CB2200B / TQDL or Equivalent



Figs. W – AC
GF115 / THQL115GFT



Figs. BB – DD, QQ – SS
CB2201 / TQD22200WL



Figs. LL – MM
CBT2201



Figs. EE – GG
CBL2201



Figs. HH – JJ
LCB2201

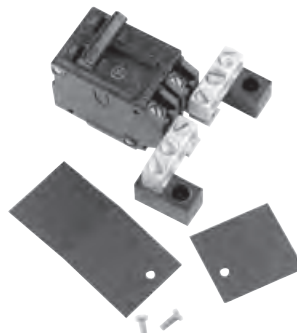

Figs. KK
CBT2102

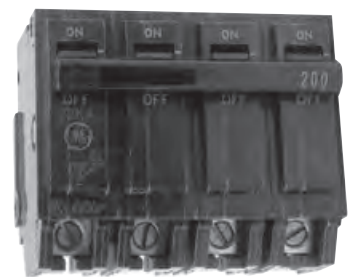

Figs. NN – OO
CB4200H / THQM200WLBP

Circuit Breakers

10kAIC, 15 – 200 Amps, 120/240V

Fig.	Midwest Model Number ¹ (Midwest Circuit Breakers Will Become Obsolete)	New Model Number		Amps	Number of Poles	Circuit Breaker Description
		1" Module	1/2" Module			
Single Pole						
A	CB115	THQL115	—	15	1	Plug-In
F	CB115T ¹	—	THQP115	15		
B	CB120	THQL1120	—	20		
G	CB120T ¹	—	THQP120	20		
C	CB130	THQL1130	—	30		
D	CB140	THQL1140	—	40		
E	CB150	THQL1150	—	50		
Double Pole						
K	CB215	THQL2115	—	15	2	Plug-In
L	CB220	THQL2120	—	20		
P	CB220T ¹	—	THQP220	20		
M	CB230	THQL2130	—	30		
Q	CB230T ¹	—	THQP230	30		
N	CB240	THQL2140	—	40		
O	CB250	THQL2150	—	50		
R	CB250T ¹	—	THQP250	50		
S	CB260	THQL2160	—	60		
T	CB270	THQL2170	—	70		
U	CB2100	THQL21100	—	100		
V	CB2150B	TQDL or equivalent	—	150		
V2	CB2200B	TQDL or equivalent	—	200		
Single and Double Pole						
W	GFI115	THQL1115GFT	—	15	1	Ground Fault Circuit Interrupter
X	GFI120	THQL1120GFT	—	20		
Y	GFI130	THQL1130GFT	—	30		
Z	GFI220	THQL2120GFT	—	20	2	
AA	GFI230	THQL2130GFT	—	30		
AB	GFI240	THQL2140GFT	—	40		
AC	GFI250	THQL2150GFT	—	50		

¹ Phasing out Midwest circuit breakers. Use new model number.

² Models ending in "T" (1/2" thinline breakers) not available for all load centers. Consult Manufacturer.

10kAIC, 100 – 225 Amps, 240V

Fig.	Midwest Model Number ¹ (Midwest Circuit Breakers Will Become Obsolete)	New Model Number		Amps	Number of Poles	Circuit Breaker Description
		1" Module	1/2" Module			
Double Pole, Bolt-on						
BB	CB2101	TQD22100WL	—	100	2	100 Amp Bolt-On
CC	CB2151	TQD22150WL	—	150		150 Amp Bolt-On
DD	CB2201	TQD22200WL	—	200		200 Amp Bolt-On
Special Purpose						
EE	CBL2101	—	—	100	2	Bolt-On w/Auxiliary Load Lugs
KK	CBT2102	—	—	100		Plug-In for 100 T Series
HH	LCB2101	—	—	100		Bolt-On w/Auxiliary Load Lugs
FF	CBL2151	—	—	150		Bolt-On w/Auxiliary Load Lugs
II	LCB2151	—	—	150		Bolt-On w/Auxiliary Load Lugs
GG	CBL2201	—	—	200		Bolt-On w/Auxiliary Load Lugs
LL	CBT2201	—	—	200		Bolt-On for 200 T Series
JJ	LCB2201	—	—	200		Bolt-On w/Auxiliary Load Lugs
MM	CBT2201N	—	—	225		Bolt-On, Non-Auto T Series

NOTE: Factory added modification parts to breakers, not available.

¹ Phasing out Midwest circuit breakers. Use new model number.

22kAIC, 100 – 200 Amps, 240V

Fig.	Midwest Model Number ¹ (Midwest Circuit Breakers Will Become Obsolete)	New Model Number		Amps	Number of Poles	Circuit Breaker Description
		1" Module	1/2" Module			
Plug-In						
	CB2100H	THHQL21100	—	100	2	Plug-In
OO	CB4150H	THQMV150WLBP	—	150		
NN	CB4200H	THQMV200WLBP	—	200		
Bolt-On						
QQ	CB2101H	THQD22100WL	—	100	2	Bolt-On
SS	CB2201H	THQD22200WL	—	200		

¹ Phasing out Midwest circuit breakers. Use new model number.

Data subject to change without notice.

Load Center Interiors

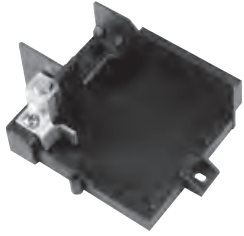

Fig. A
LC31X3



Fig. B
LC31N3

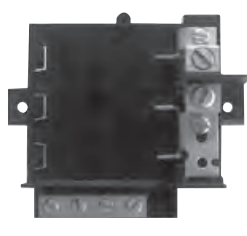

Fig. C
LC33N7

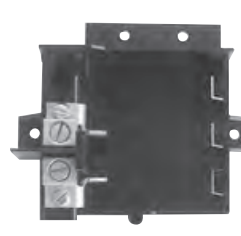

Fig. D
LC32X1

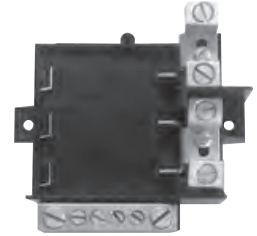

Fig. E
LC33N1



Fig. F
LC33N1T

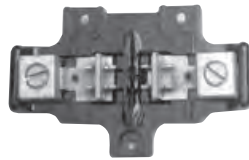

Fig. G
LC44X1

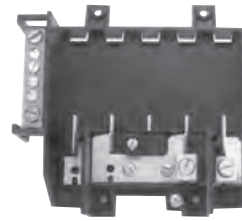

Fig. H
LC55N1

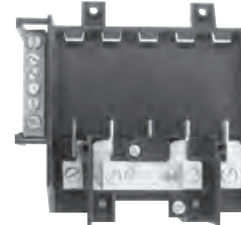

Fig. I
LC55N1T

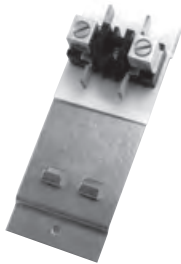

Fig. J
PC2LC

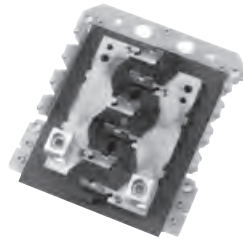

Fig. K
LC88PC



Fig. L
LC88X2

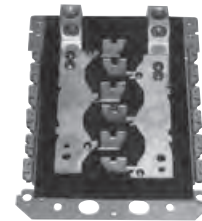

Fig. M
LC1212PC

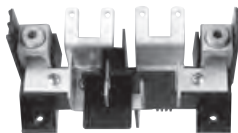

Fig. N
LCBS

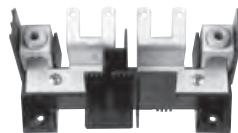

Fig. O
LCBNS



Fig. P
LCTL



Fig. Q
LCTNL

Load Center Interiors

30 Amps, 120V

Fig.	Model Number	Circuits	Amps	Line Lug Size	Neutral Lug Size
A	LC31X3	1	30	#14-1/0 Cu/Al	None
B	LC31N3				(2) #12-2 Cu/Al

70 – 200 Amps, 120/240V

Fig.	Model Number	Circuits	Amps	Line Lug Size	Neutral Lug Size
C	LC33N7	3	70	#14-1/0 Cu/Al	(4) #14-2 Cu/Al
D	LC32X1	2	100	#14-1/0 Cu/Al	None
E	LC33N1	3	100	#14-1/0 Cu/Al	(2) #14-1/0, (2) #14-4 Cu/Al
F	LC33N1T	3	100	(2) #14-1/0 Cu/Al/Phase	(2) #14-1/0, (2) #14-4 Cu/Al
G	LC44X1	4	100	#14-1/0 Cu/Al	None
H	LC55N1	5	100	#14-1/0 Cu/Al	(2) #14-1/0, (2) #14-4 Cu/Al
I	LC55N1T	5	100	(2) #14-1/0 Cu/Al/Phase	(2) #14-1/0, (2) #14-4 Cu/Al
J	PC2LC	2	125	#6-2/0 Cu/Al	None
K	LC88PC	8	200	#6-250 kcmil	None
L	LC88X2	8	200	(2) #1-300 kcmil Cu/Al	None
M	LC1212PC	12	200	#6-250 kcmil	None
N	LCBS	4	200	#1-4/0	#1-4/0, #6-2/0, #14-4
O	LCBNS	1	200	#1-4/0	#1-4/0, #6-2/0, #14-4
P	LCTL	4	200	#1-4/0	#1-4/0, #6-2/0, #14-4
Q	LCTNL	4	200	#1-4/0	#1-4/0, #6-2/0, #14-4

Lug Assemblies



Fig. A
NI60B2



Fig. B
NEU102



Fig. C
NEU100B2



Fig. D
NEU202



Fig. E
NI200



Fig. F
NI200A5



Fig. G
NEU407



Fig. H
NI400A1



Fig. I
GL3

Fig.	Part Number	Qty. and Lug Size
A	NI60B2	(4) #14-4 Cu/Al
B	NEU102	(5) #12-1/0 Cu/Al
C	NEU100B2	(5) #14-1/0 Cu/Al
D	NEU202	(2) #14-1/0 Cu/Al, (3) #6-250 kcmil Cu/Al
E	NI200	(3) 1/0-250 kcmil, (3) #12-1/0 Cu/Al
F	NI200A5	(3) 1/0-250 kcmil, (3) #12-1/0 Cu/Al
G	NEU407	(2) #14-1/0, (3) #2-600 kcmil
H	NI400A1	(2) 1/0-600 kcmil, (3) 1/0-250 kcmil Cu/Al
I	GL3	(2) #12-2 Cu/Al

Meter Door Replacement Kits

Meter door replacement kits are available for Service Entrance, Temporary Power, and RV metallic metered units. Please consult manufacturer to ensure the proper kit is ordered for your model.

Loop Feed Lug Terminal Bars

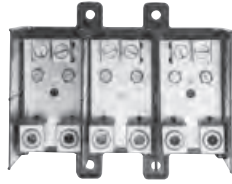

Fig. A
LT100B250

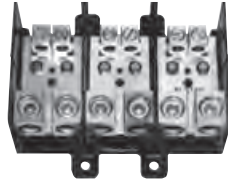

Fig. B
LT100B350

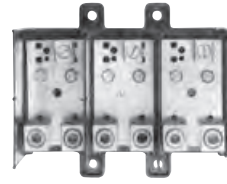

Fig. C
LT100S250

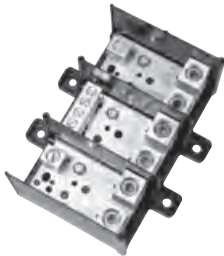

Fig. D
LT100S300

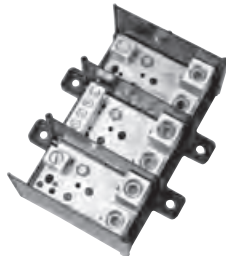

Fig. E
LT100S350

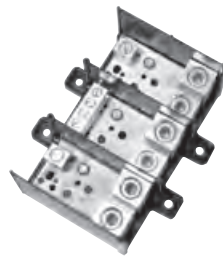

Fig. F
LT200B350



Fig. G
LT200B350RF



Fig. H
LT200S350



Fig. I
LT200SS

Fig.	Part Number	Load Amps	Load Lugs (Copper/Aluminum)	Line Amps	Line Lugs (Copper/Aluminum)
A	LT100B250	100	(2) #14-1/0 per Phase	200	(2) #1-300 kcmil per Phase
B	LT100B350		(2) #14-1/0 per Phase		(2) #6-350 kcmil per Phase
C	LT100S250		(1) #14-1/0 per Phase		(2) #1-300 kcmil per Phase
D	LT100S300		(2) #14-1/0, (4) #14-4		(6) #1-300 kcmil
E	LT100S350		(2) #14-1/0 CU, (4) #14-4		(6) #1-350 kcmil
F	LT200B350	200	(2) #2-250 kcmil per Phase		(2) #6-350 kcmil per Phase
G	LT200B350RF		(2) #14-1/0 per Phase		(3) #6-300 kcmil per Phase (Radial feed may go two different ways in row site)
H	LT200S350		(1) #2-250 kcmil per Phase		(2) #6-350 kcmil per Phase
I	LT200SS		(2) #2-250 kcmil per Phase		3/8" –16 Double Stud per Phase

Meter Bases

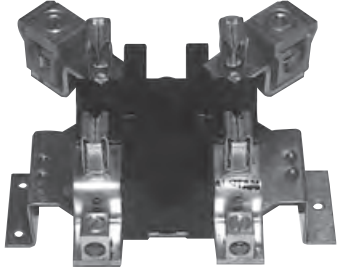

MSM100930

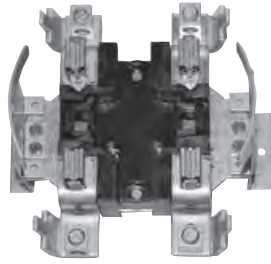

MSR100P9



MSM20014



MW200R

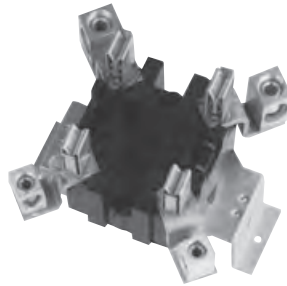

MW200M

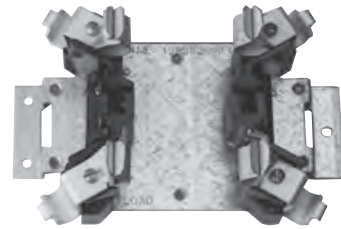

MS1S

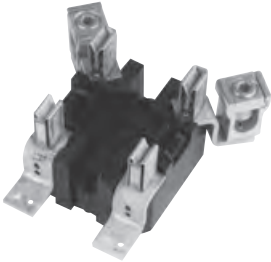

MSMS



MSRS



MSMP

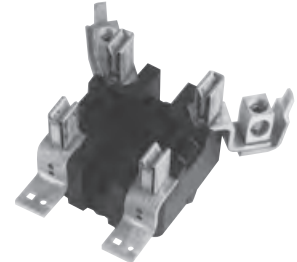

MSRP

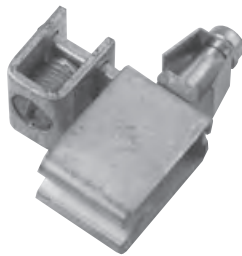

MS5 (5TH JAW)



MSBN1A



MSBN4

Meter Bases

Meter Sockets Manufactured after February 1995, 100 Amps

Replacement Model Number	Type	Rating	Lug Style	Line Lug Wire Range	Optional Neutral Kit	Description
MSM100EZ	Ring Type	100	Lay In	6-350 kcmil	À	EZ-Site Underground Surface Panels
MSR100EZ	Ringless				À	EZ-Site Underground Surface Panels
MSM100930 ¹	Ring Type				MSBN4	9" x 30" Surface Panels
MSR100930	Ringless				MSBN4	9" x 30" Surface Panels
MSM100P9 ¹	Ring Type				MSBN4	9PT Single Sided Post
MSR100P9	Ringless				MSBN4	9PT Single Sided Post
MSM10014	Ring Type				MSBN4	11" Wide and 14" wide Surface Panels

À Neutral Factory installed in EZ-Site (Temporary Power) enclosure

¹ Midwest Electric manufactured meter socket only.

Meter Socket Manufactured between 1984 and February 1995, 100 Amps

Replacement Model Number	Type	Rating	Lug Style	Line Lug Wire Range	Optional Neutral Kit	Description
MS1H	Ring Type	100	Lay In	6-1/0	MSBN1A	Post Models, 14" Wide Surface Panels
MS1S ¹						Surface Mount, Rear Socket on Posts

¹ Midwest Electric manufactured meter socket only.

Meter Socket Manufactured after 1984, 200 Amp

Replacement Model Number	Type	Rating	Lug Style	Line Lug Wire Range	Optional Neutral Kit	Description
MSM20014 ¹	Ring Type	200	Lay In	6-350 kcmil	MSBN4	14" wide Surface Panels
MSR20014	Ringless		Lay In	6-350 kcmil	MSBN4	14" wide Surface Panels
MW200M ¹	Ring Type		Box Style	1/0-350 kcmil	MSBN4	All Other Panels and Post Units
MW200R ¹	Ringless		Box Style	1/0-350 kcmil	MSBN4	All Other Panels and Post Units
MSMS ¹	Ring Type		Lay In	—	—	28" and 18" Series Service End Surface Mount
MSRS ¹	Ringless		Lay In	—	—	28" and 18" Series Service End Surface Mount
MSMP ¹	Ring Type		Box Style	—	—	28" and 18" Series Service End Posts
MSRP ¹	Ringless		Box Style	—	—	28" and 18" Series Service End Posts
265A5264P8	Ringless	200/320 ²	Lay In	6-350 kcmil	Comes with 5th Jaw Neutral	14" Lever Bypass Series SE Surface/Pedestal

¹ Midwest Electric manufactured meter socket only.

² 320 Amp rated for bypass.

Lever Bypass Meter Socket, 400 Amp

Replacement Model Number	Type	Rating	Lug Style	Line Lug Wire Range	Optional Neutral Kit	Description
265A5264P10	Ringless	400/320 ²	Double Box Style	6-350 kcmil	—	14" Lever Bypass Series SE Surface/Pedestal

¹ Models ending in "T" (1/2" thinline breakers) not available for all load centers. Consult Manufacturer.

NEMA Receptacle Configurations

The configurations shown below all comply with National Electrical Manufacturers Association (NEMA) standards. These configurations represent a significant breakthrough on insuring the proper application and use of wiring devices to safeguard against accidents.

This breakthrough was accomplished with the completion of a systematic grouping of non-interchangeable general purpose receptacle and plug configurations. Use of NEMA's unique configuration design for standard usage current and voltage ratings reduce the unsafe interchangeability of devices which existed prior to their adoption.

System Voltage	NEMA	Straight Blade				NEMA	Locking Blade		
		20 Amps	30 Amps	50 Amps	60 Amps		20 Amps	30 Amps	
2 Pole, 3 Wire, Grounding	125V	5	5-20R	5-30R	5-50R	—	L-5	L5-20R	L5-30R
	250V	6	6-20R	6-30R	6-50R	—	L-6	L6-20R	L6-30R
	277VAC	7	7-20R	7-30R	7-50R	—	L-7	L7-20R	L7-30R
	480VAC	8	Reserved for Future Configurations				L-8	L8-20R	L8-30R
	600VAC	9	Reserved for Future Configurations				L-9	L9-20R	L9-30R
3 Pole, 3 Wire	125/250V	10	10-20R	10-30R, R-33	10-50R, R-53	—	L-10	L10-20R	L10-30R
	3Ø 250V	11	11-20R	11-30R	11-50R	—	L-11	L11-20R	L11-30R
	3Ø 480V	12	Reserved for Future Configurations				L-12	L12-20R	L12-30R
	3Ø 600V	13	Reserved for Future Configurations				L-13	—	L13-30R
3 Pole, 4 Wire, Grounding	125/250V	14	14-20R	14-30R, R-34	14-50R, R-54-U	14-60R	L-14	L14-20R	L14-30R
	3Ø 250V	15	15-20R	15-30R	15-50R	15-60R	L-15	L15-20R	L15-30R
	3Ø 480V	16	Reserved for Future Configurations				L-16	L16-20R	L16-30R
	3Ø 600V	17	Reserved for Future Configurations				L-17	—	L17-30R
4 Pole, 4 Wire	3Ø 120/208V	18	18-20R	18-30R	18-50R	18-60R, R-54	L-18	L18-20R	L18-30R

Other Receptacle Configurations

Configuration	Amps	Volts	Description
	20	125/250	7310
	30	125	TT-30R – 2 pole, 3 wire
	50	125/250	L6-50R (63CM69) Twist Lock – 2 pole, 3 wire
	50	125	L5-50R (63CM70) Twist Lock – 3 pole, 4 wire

Data subject to change without notice.

Section 14 – Application Data

Allowable ampacities of insulated conductors rated 0 through 2000 Volts, 60°C to 90°F (140° to 194°F) not more than three current-carrying conductors in raceway or cable or earth (directly buried), based on ambient temperature of 30°C (86°F).

Temperature Rating of Conductor								
Size	Copper			Aluminum or Copper-Clad Aluminum			Size	
AWG kcmil	Types							AWG kcmil
	TW=, UF=	FEPW=, RH=, RHW=, THHW=, THW=, THWN=, XHHW=, USE=, ZW=	TBS, SA, SIS, FEP=, FEPB=, MI, RHH=, RHW-2, THHN=, THHW=, THW-2=, THWN-2=, USE-2, XHH, XHHW=, XHHW-2, ZW-2	TW=, UF=	RH=, RHW=, THHW=, THW=, THWN=, XHHW=, USE=	TBS, SA, SIS, THHN=, THHW=, THW-2, THWN-2, RHH=, RHW-2, RHH=, RHW-2, USE-2, XHH, XHHW, XHHW-2, ZW-2		
	60°C (140°F)	75°C (167°F)	90°C (194°F)	60°C (140°F)	75°C (167°F)	90°C (194°F)		
18	14	
16	18	
14	20=	20=	25=	
12	25=	25=	30=	20=	20=	25=	12	
10	30	35=	40=	25	30=	35=	10	
8	40	50	55	30	40	45	8	
6	55	65	75	40	50	60	6	
4	70	85	95	55	65	75	4	
3	85	100	110	65	75	85	3	
2	95	115	130	75	90	100	2	
1	110	130	150	85	100	115	1	
1/0	125	150	170	100	120	135	1/0	
2/0	145	175	195	115	135	150	2/0	
3/0	165	200	225	130	155	175	3/0	
4/0	195	230	260	150	180	205	4/0	
250	215	255	290	170	205	230	250	
300	240	285	320	190	230	255	300	
350	260	310	350	210	250	280	350	
400	280	335	380	225	270	305	400	
500	320	380	430	260	310	350	500	
600	355	420	475	285	340	385	600	
700	385	460	520	310	375	420	700	
750	400	475	535	320	385	435	750	
800	410	490	555	330	395	450	800	
900	435	520	585	355	425	480	900	
1000	455	545	615	375	445	500	1000	
1250	495	590	665	405	485	545	1250	
1500	520	625	705	435	520	585	1500	
1750	545	650	735	455	545	615	1750	
2000	560	665	750	470	560	630	2000	

Correction Factors							
Ambient Temp. C	For ambient temperatures other than 30°C (86°F), multiply the allowable ampacities shown above by the appropriate factor shown below.						Ambient Temp. F
21-25	1.08	1.05	1.04	1.08	1.05	1.04	70-77
26-30	1.00	1.00	1.00	1.00	1.00	1.00	78-86
31-35	.91	.94	.96	.91	.94	.96	87-95
36-40	.82	.88	.91	.82	.88	.91	96-104
41-45	.71	.82	.87	.71	.82	.87	105-113
46-50	.58	.75	.82	.58	.75	.82	114-122
51-55	.41	.67	.76	.41	.67	.76	123-131
56-6058	.7158	.71	132-140
61-7033	.5833	.58	141-158
71-804141	159-176

Approximate Voltage Drop (Copper Conductor)

Wire Size AWG or MCM	Per Ampere per 100 feet – 80% Power Factor	
	Single Phase	Three Phase
14	.4762	.4167
12	.3125	.2632
10	.1961	.1677
8	.1250	.1087
6	.0833	.0714
4	.0538	.0463
3	.0431	.0379
2	.0370	.0323
1	.0323	.0278
1/0	.0269	.0231
2/0	.0222	.0196
3/0	.0190	.0163
4/0	.0161	.0139
250	.0147	.0128
300	.0131	.0114
350	.0121	.0106
400	.0115	.0091
500	.0101	.0088
600	.0094	.0082
700	.0089	.0077
750	.0086	.0075
800	.0085	.0074
900	.0081	.0071
1000	.0079	.0069

Data subject to change without notice.

= Unless otherwise specifically permitted elsewhere in this Code, the overcurrent protection for conductor types marked with an obelisk (=) shall not exceed 15 amperes for No. 14, 20 amperes for No. 12, and 30 amperes for No. 10 copper; or 15 amperes for No. 12 and 25 amperes for No. 10 aluminum and copper-clad aluminum after any correction factors for ambient temperature and number of conductors have been applied.

Authorized Manufacturer's Sales Representatives

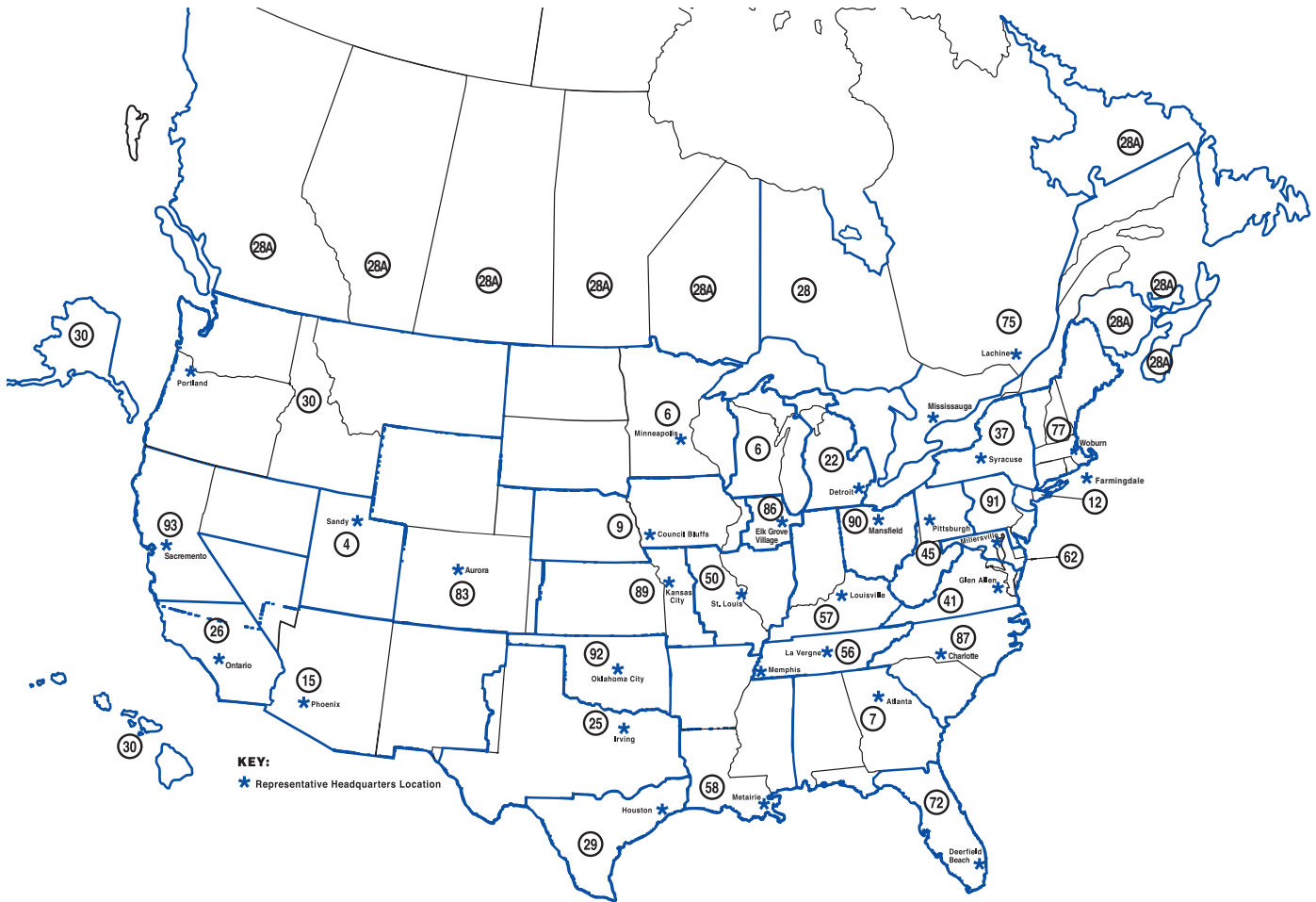

4 **MBT Group**
 Sandy, UT 84070
 Phone: (801) 979-3665
 www.mbt-group.com

6 **Lesco, Inc.**
 Minneapolis, MN 55427
 Phone: (763) 542-8242
 Fax: (763) 542-9309
 www.lesco-inc.com

7 **Bishop & Brogdon**
 Atlanta, GA 30336
 Phone: (404) 494-4333
 (800) 241-2963
 Fax: (404) 344-3696

9 **Bixler Marketing Group**
 Council Bluffs, IA 51501
 Phone: (712) 328-1841
 (888) 924-9537
 Fax: (712) 328-7449
 www.bixlermarketing.com

12 **Gumersell Cashdan, Inc.**
 Farmingdale, NY 11735
 Phone: (631) 752-9440
 Fax: (631) 752-9415
 www.gumcash.com

15 **Desert States Electrical Sales**
 Phoenix, AZ 85040
 Phone: (602) 268-7008
 Fax: (602) 268-7125
 www.desertstates.com

22 **Deperro / Team Diversified**
 Detroit, MI 48211
 Phone: (313) 875-4010
 (800) 875-9120
 Fax: (313) 872-5544

25 **Electra Sales of N. Texas**
 Irving, TX 75061
 Phone: (972) 554-8200
 Fax: (972) 554-7861
 www.electrasales.net

26 **Blanchard Associates**
 Ontario, CA 91761
 Phone: (888) 974-0111
 Fax: 909-974-0117
 www.blanchardassociates.com

Section 15 – Authorized Reps

- 28 **Intralec Electrical Products**
Mississauga, ON L5S 1P6
Phone: (905) 670-0970
Fax: (905) 670-3098
www.intralec.com
- 28A **CHD Group**
Kitchener, ON N2R 1H4
Phone: (888) 849-4349
Fax: (888) 849-4349
www.chdgroup.ca
- 29 **E-Tel**
Houston, TX 77028
Phone: (713) 678-4460
Fax: (713) 678-4371
www.etelinc.com
- 30 **Robert A. Amey Company**
Portland, OR 97229
Phone: (503) 646-7196
Fax: (503) 626-8569
www.ameyco.com
- 37 **Electro-Lines, Inc.**
Syracuse, NY 13208
Phone: (315) 455-5701
(800) 962-5760
Fax: (315) 455-7114
www.electrolines.com
- 41 **L.W. French, Inc.**
Glen Allen, VA 23060
Phone: (804) 270-3205
Fax: (804) 270-0885
www.lwfrench.com
- 45 **Gemco Sales, Inc.**
Pittsburgh, PA 15201
Phone: (412) 562-9300
Fax: (412) 562-9028
- 50 **Vector Electrical Sales**
St. Charles, MO 63303
Phone: (636) 949-5925
Fax: (636) 949-5926
- 56 **John Moore & Associates**
La Vergne, TN 37086
Phone: (615) 287-0500
Fax: (615) 287-0662
www.jmaone.com
- Memphis, TN 38114
Phone: (901) 948-0193
Fax: (901) 948-0194
- 57 **Summit Sales & Marketing**
Louisville, KY 40217
Phone: (502) 636-3339
Fax: (502) 636-2575
www.summitsales-mkt.com
- 58 **Burrus & Matthews, Inc.**
Metairie, LA 70002
Phone: (504) 835-7825
(800) 535-7619
Fax: (504) 835-7853
www.b-m.com
- 62 **O.T. Hall & Son, Inc.**
Millersville, MD 21108
Phone: (410) 987-5990
(888) 621-7435
Fax: (410) 987-9691
www.othall.com
- 72 **Metra Associates, Inc.**
Deerfield Beach, FL 33442
Phone: (954) 428-4444
(800) 201-3465
Fax: (954) 428-4455
www.metra-assoc.com
- 75 **Theovine, Inc.**
Lachine, Quebec, Canada
Phone: (514) 637-0050
Fax: (514) 637-4630
www.theovine.com
- 77 **David Role & Co.**
Woburn, MA 01801
Phone: (781) 932-8810
(800) 878-0852
Fax: (781) 932-8815
- 83 **EAC/TSC**
Aurora, CO 80011
Phone: (303) 363-4152
Fax: (303) 344-8580
- 86 **Lake Michigan Sales, LLC**
Elk Grove Village, IL 60007
Phone: (847) 378-8045
Fax: (847) 307-8975
www.lakemichigansales.com
- 87 **Robert W. Chapman Company**
Charlotte, NC 28224
Phone: (704) 525-2421
Fax: (704) 527-1289
www.rwchapman.com
- 89 **Convergence**
North Kansas City, MO 64116
Phone: (816) 581-6300
Fax: (816) 581-6301
www.convergerep.com
- 90 **Gobeille-Robinson & Associates, Inc.**
Mansfield, OH 44907
Phone: (419) 526-1010
Fax: (419) 526-0291
www.gobrob.com
- 91 **Cusick Electrical Sales**
Willow Grove, PA 19090
Phone: (215) 659-6666
(888) 644-2744
Fax: (215) 659-6674
www.cusicksales.com
- 92 **Windshine LLC**
Oklahoma City, OK 73170
Phone: (405) 735-6999
www.wsokla.com
- 93 **Empire Electric Sales**
Sacramento, CA 95826
Phone: (916) 383-1399
www.empireelectricsales.com

Product Index

Model Number	Page	Model Number	Page	Model Number	Page
121.....	14-5	9T10W1002G61.....	13-5	9T10W1008G63.....	13-12
1004709DMEP.....	2-3, 2-10	9T10W1002G62.....	13-11	9T10W1009.....	13-5
1004710EMEP.....	2-3, 2-10	9T10W1002G63.....	13-12	9T10W1009G02.....	13-11
1006385BMEP.....	2-3, 2-10	9T10W1003.....	13-5	9T10W1009G03.....	13-12
1006630AMEP.....	2-9, 3-5	9T10W1003G02.....	13-11	9T10W1009G31.....	13-5
1006737BMEP.....	3-3, 3-6	9T10W1003G03.....	13-12	9T10W1009G32.....	13-11
1007003CMEP.....	2-3, 2-10	9T10W1003G31.....	13-5	9T10W1009G33.....	13-12
1007361CMEP.....	2-3, 2-10	9T10W1003G32.....	13-11	9T10W1171.....	13-5
1007665AMEP.....	2-3, 2-10	9T10W1003G33.....	13-12	9T10W1172.....	13-5
1007665MEP.....	2-3, 2-10	9T10W1003G61.....	13-5	9T10W1173.....	13-5
1007670MEP.....	2-6, 2-10	9T10W1003G62.....	13-11	9T10W1174.....	13-5
1007672MEP.....	2-5, 2-9, 2-10	9T10W1003G63.....	13-12	9T10W1175.....	13-5
1008068MEP.....	2-5, 2-10	9T10W1004.....	13-5	9T10W1176.....	13-5
1008435MEP.....	2-5, 2-9, 2-10	9T10W1004G02.....	13-11	9T10W1177.....	13-5
1008801MEP.....	2-10	9T10W1004G03.....	13-12	9T10W1178.....	13-5
1008836MEP.....	2-5, 2-10	9T10W1004G31.....	13-5	9T10W1179.....	13-5
1008837MEP.....	2-5, 2-10	9T10W1004G32.....	13-11	9T10W1181.....	13-6, 13-13
1009260MEP.....	2-5, 2-9, 2-10	9T10W1004G33.....	13-12	9T10W1181G31.....	13-13
1009788AMEP.....	2-5, 2-9, 2-10	9T10W1004G61.....	13-5	9T10W1181G61.....	13-13
1009995MEP.....	2-3, 2-10	9T10W1004G62.....	13-11	9T10W1182.....	13-6, 13-13
1011692MEP.....	2-3, 2-10	9T10W1004G63.....	13-12	9T10W1182G31.....	13-13
265A5003P1.....	14-5	9T10W1005.....	13-5	9T10W1182G61.....	13-13
265A5003P2.....	14-5	9T10W1005G02.....	13-11	9T10W1183.....	13-6, 13-13
265A5264P8.....	14-16	9T10W1005G03.....	13-12	9T10W1183G31.....	13-13
265A6035G27.....	14-7	9T10W1005G31.....	13-5	9T10W1183G61.....	13-13
265A6036G69.....	14-7	9T10W1005G32.....	13-11	9T10W1184.....	13-6, 13-13
4-GE-727X100001.....	14-6	9T10W1005G33.....	13-12	9T10W1184G31.....	13-13
4-GE-727X200001.....	14-6	9T10W1005G61.....	13-5	9T10W1184G61.....	13-13
4-MA-HUB1-M.....	14-6	9T10W1005G62.....	13-11	9T10W1185.....	13-6, 13-13
4-MA-HUB1.25-M.....	14-6	9T10W1005G63.....	13-12	9T10W1185G31.....	13-13
4-MA-NIP1.....	14-6	9T10W1006.....	13-5	9T10W1185G61.....	13-13
4-MA-NIP1.25.....	14-6	9T10W1006G02.....	13-11	9T10W1186.....	13-6, 13-13
4-MA-PLSL.....	14-6	9T10W1006G03.....	13-12	9T10W1186G31.....	13-13
4-MS-A4T100R1.25H1.....	14-6	9T10W1006G31.....	13-5	9T10W1186G61.....	13-13
4-MS-A4T100R1H1.....	14-6	9T10W1006G32.....	13-11	9T10W1187.....	13-6, 13-13
4-PK-BKIT-MIDWEST.....	14-6	9T10W1006G33.....	13-12	9T10W1187G31.....	13-13
4-PK-C1-MIDWEST.....	14-6	9T10W1006G61.....	13-5	9T10W1187G61.....	13-13
5S3S2S2SEB.....	11-10, 11-19	9T10W1006G62.....	13-11	9T10W1188.....	13-6, 13-13
5S3S2S2SES.....	11-10, 11-19	9T10W1006G63.....	13-12	9T10W1188G31.....	13-13
5S3S3S2SEB.....	11-10, 11-19	9T10W1007.....	13-5	9T10W1188G61.....	13-13
5S3S3S2SES.....	11-10, 11-19	9T10W1007G02.....	13-11	9T10W1189.....	13-6, 13-13
9T10W1001.....	13-5	9T10W1007G03.....	13-12	9T10W1189G31.....	13-13
9T10W1001G02.....	13-11	9T10W1007G31.....	13-5	9T10W1341.....	13-6
9T10W1001G03.....	13-12	9T10W1007G32.....	13-11	9T10W1342.....	13-6
9T10W1001G31.....	13-5	9T10W1007G33.....	13-12	9T10W1343.....	13-6
9T10W1001G32.....	13-11	9T10W1007G61.....	13-5	9T10W1344.....	13-6
9T10W1001G33.....	13-12	9T10W1007G62.....	13-11	9T10W1345.....	13-6
9T10W1001G61.....	13-5	9T10W1007G63.....	13-12	9T10W1346.....	13-6
9T10W1001G62.....	13-11	9T10W1008.....	13-5	9T10W1347.....	13-6
9T10W1001G63.....	13-12	9T10W1008G02.....	13-11	9T10W1348.....	13-6
9T10W1002.....	13-5	9T10W1008G03.....	13-12	9T10W1451.....	13-6
9T10W1002G02.....	13-11	9T10W1008G31.....	13-5	9T10W1452.....	13-6
9T10W1002G03.....	13-12	9T10W1008G32.....	13-11	9T10W1453.....	13-6
9T10W1002G31.....	13-5	9T10W1008G33.....	13-12	9T10W1454.....	13-6
9T10W1002G32.....	13-11	9T10W1008G61.....	13-5	9T10W1455.....	13-6
9T10W1002G33.....	13-12	9T10W1008G62.....	13-11	9T10W1456.....	13-6

Midwest Electric Products
Section 16 – Product Index

Model Number	Page
9T10W1457	13-6
9T10W1458	13-6
9T10W1531	13-6
9T10W1532	13-6
9T10W1533	13-6
9T10W1534	13-6
9T10W1535	13-6
9T10W1536	13-6
9T10W1537	13-6
9T10W1538	13-6
9T10W1539	13-6
9T10W1611	13-6
9T10W1612	13-6
9T10W1613	13-6
9T10W1614	13-6
9T10W1615	13-6
9T10W1616	13-6
9T10W1617	13-6
9T10W1618	13-6
9T10W1619	13-6
9T10X100	13-5
9T10X1001G02	13-11
9T10X1001G03	13-12
9T10X1001G31	13-5
9T10X1001G32	13-11
9T10X1001G33	13-12
9T10X1001G61	13-5
9T10X1001G62	13-11
9T10X1001G63	13-12
9T10X1002	13-5
9T10X1002G02	13-11
9T10X1002G03	13-12
9T10X1002G31	13-5
9T10X1002G32	13-11
9T10X1002G33	13-12
9T10X1002G61	13-5
9T10X1002G62	13-11
9T10X1002G63	13-12
9T10X1003	13-5
9T10X1003G02	13-11
9T10X1003G03	13-12
9T10X1003G31	13-5
9T10X1003G32	13-11
9T10X1003G33	13-12
9T10X1003G61	13-5
9T10X1003G62	13-11
9T10X1003G63	13-12
9T10X1004	13-5
9T10X1004G02	13-11
9T10X1004G03	13-12
9T10X1004G31	13-5
9T10X1004G32	13-11
9T10X1004G33	13-12
9T10X1004G61	13-5
9T10X1004G62	13-11
9T10X1004G63	13-12

Model Number	Page
9T10X1005	13-5
9T10X1005G02	13-11
9T10X1005G03	13-12
9T10X1005G31	13-5
9T10X1005G32	13-11
9T10X1005G33	13-12
9T10X1005G61	13-5
9T10X1005G62	13-11
9T10X1005G63	13-12
9T10X1006	13-5
9T10X1006G02	13-11
9T10X1006G03	13-12
9T10X1006G31	13-5
9T10X1006G32	13-11
9T10X1006G33	13-12
9T10X1006G61	13-5
9T10X1006G62	13-11
9T10X1006G63	13-12
9T10X1007	13-5
9T10X1007G02	13-11
9T10X1007G03	13-12
9T10X1007G31	13-5
9T10X1007G32	13-11
9T10X1007G33	13-12
9T10X1007G61	13-5
9T10X1007G62	13-11
9T10X1007G63	13-12
9T10X1008	13-5
9T10X1008G02	13-11
9T10X1008G03	13-12
9T10X1008G31	13-5
9T10X1008G32	13-11
9T10X1008G33	13-12
9T10X1008G61	13-5
9T10X1008G62	13-11
9T10X1008G63	13-12
9T10X1009	13-5
9T10X1009G02	13-11
9T10X1009G03	13-12
9T10X1009G32	13-11
9T10X1009G33	13-12
9T10X1181	13-13
9T10X1181G31	13-13
9T10X1181G61	13-13
9T10X1182	13-13
9T10X1182G31	13-13
9T10X1182G61	13-13
9T10X1183	13-13
9T10X1183G31	13-13
9T10X1183G61	13-13
9T10X1184	13-13
9T10X1184G31	13-13
9T10X1184G61	13-13
9T10X1185	13-13
9T10X1185G31	13-13
9T10X1185G61	13-13

Model Number	Page
9T10X1186	13-13
9T10X1186G31	13-13
9T10X1186G61	13-13
9T10X1187	13-13
9T10X1187G31	13-13
9T10X1187G61	13-13
9T10X1188	13-13
9T10X1188G31	13-13
9T10X1188G61	13-13
9T10X1189	13-13
9T10X1189G31	13-13
9T10X1191	13-6
9T10X1192	13-6
9T10X1193	13-6
9T10X1194	13-6
9T10X1195	13-6
9T10X1196	13-6
9T10X1197	13-6
9T10X1198	13-6
9T10X1199	13-6
9T10X240	13-6
9T10X2402	13-6
9T10X2403	13-6
9T10X2404	13-6
9T10X2405	13-6
9T10X2406	13-6
9T10X2407	13-6
9T10X2408	13-6
9T10X2409	13-6
9T11W1001G03	13-8
9T11W1001G04	13-10
9T11W1001G33	13-8
9T11W1001G34	13-10
9T11W1001G63	13-8
9T11W1001G64	13-10
9T11W1002G03	13-8
9T11W1002G04	13-10
9T11W1002G33	13-8
9T11W1002G34	13-10
9T11W1002G63	13-8
9T11W1002G64	13-10
9T11W1003G03	13-8
9T11W1003G04	13-10
9T11W1003G33	13-8
9T11W1003G34	13-10
9T11W1003G63	13-8
9T11W1003G64	13-10
9T11W1004G03	13-8
9T11W1004G04	13-10
9T11W1004G33	13-8
9T11W1004G34	13-10
9T11W1004G63	13-8
9T11W1004G64	13-10
9T11W1005G03	13-8
9T11W1005G04	13-10
9T11W1005G33	13-8

Data subject to change without notice.

Midwest Electric Products
Section 16 – Product Index

Model Number	Page
9T11W1005G34.....	13-10
9T11W1005G63.....	13-8
9T11W1005G64.....	13-10
9T11W1006G03.....	13-8
9T11W1006G04.....	13-10
9T11W1006G33.....	13-8
9T11W1006G34.....	13-10
9T11W1006G63.....	13-8
9T11W1006G64.....	13-10
9T11W1007G03.....	13-8
9T11W1007G04.....	13-10
9T11W1007G33.....	13-8
9T11W1007G34.....	13-10
9T11W1007G63.....	13-8
9T11W1008G03.....	13-8
9T11W1008G04.....	13-10
9T11W1008G33.....	13-8
9T11W1008G34.....	13-10
9T11X1001G03.....	13-8
9T11X1001G04.....	13-10
9T11X1001G33.....	13-8
9T11X1001G34.....	13-10
9T11X1001G63.....	13-8
9T11X1001G64.....	13-10
9T11X1002G03.....	13-8
9T11X1002G04.....	13-10
9T11X1002G33.....	13-8
9T11X1002G34.....	13-10
9T11X1002G63.....	13-8
9T11X1002G64.....	13-10
9T11X1003G03.....	13-8
9T11X1003G04.....	13-10
9T11X1003G33.....	13-8
9T11X1003G34.....	13-10
9T11X1003G63.....	13-8
9T11X1003G64.....	13-10
9T11X1004G03.....	13-8
9T11X1004G04.....	13-10
9T11X1004G33.....	13-8
9T11X1004G34.....	13-10
9T11X1004G63.....	13-8
9T11X1004G64.....	13-10
9T11X1005G03.....	13-8
9T11X1005G04.....	13-10
9T11X1005G33.....	13-8
9T11X1005G34.....	13-10
9T11X1005G63.....	13-8
9T11X1005G64.....	13-10
9T11X1006G03.....	13-8
9T11X1006G04.....	13-10
9T11X1006G33.....	13-8
9T11X1006G34.....	13-10
9T11X1006G63.....	13-8
9T11X1006G64.....	13-10
9T11X1007G03.....	13-8
9T11X1007G04.....	13-10

Model Number	Page
9T11X1007G33.....	13-8
9T11X1007G34.....	13-10
9T11X1007G63.....	13-8
9T11X1007G64.....	13-10
9T11X1008G03.....	13-8
9T11X1008G04.....	13-10
9T11X1008G33.....	13-8
9T11X1008G34.....	13-10
9T11X1008G63.....	13-8
9T11X1009G33.....	13-8
9T14W1001G03.....	13-7
9T14W1001G04.....	13-9
9T14W1001G33.....	13-7
9T14W1001G34.....	13-9
9T14W1001G63.....	13-7
9T14W1001G64.....	13-9
9T14W1002G03.....	13-7
9T14W1002G04.....	13-9
9T14W1002G33.....	13-7
9T14W1002G34.....	13-9
9T14W1002G63.....	13-7
9T14W1002G64.....	13-9
9T14W1003G03.....	13-7
9T14W1003G04.....	13-9
9T14W1003G33.....	13-7
9T14W1003G34.....	13-9
9T14W1003G63.....	13-7
9T14W1003G64.....	13-9
9T14W1004G03.....	13-7
9T14W1004G04.....	13-9
9T14W1004G33.....	13-7
9T14W1004G34.....	13-9
9T14W1004G63.....	13-7
9T14W1004G64.....	13-9
9T14W1005G03.....	13-7
9T14W1005G04.....	13-9
9T14W1005G33.....	13-7
9T14W1005G34.....	13-9
9T14W1005G63.....	13-7
9T14W1005G64.....	13-9
9T14W1006G03.....	13-7
9T14W1006G04.....	13-9
9T14W1006G33.....	13-7
9T14W1006G34.....	13-9
9T14W1006G63.....	13-7
9T14W1006G64.....	13-9
9T14W1007G03.....	13-7
9T14W1007G04.....	13-9
9T14W1007G33.....	13-7
9T14W1007G34.....	13-9
9T14W1007G63.....	13-7
9T14W1007G64.....	13-9
9T14W1008G03.....	13-7
9T14W1008G04.....	13-9
9T14W1008G33.....	13-7
9T14W1008G34.....	13-9

Model Number	Page
9T14W1008G64.....	13-9
9T14X1001G03.....	13-7
9T14X1001G04.....	13-9
9T14X1001G33.....	13-7
9T14X1001G34.....	13-9
9T14X1001G63.....	13-7
9T14X1001G64.....	13-9
9T14X1002G03.....	13-7
9T14X1002G04.....	13-9
9T14X1002G33.....	13-7
9T14X1002G34.....	13-9
9T14X1002G63.....	13-7
9T14X1002G64.....	13-9
9T14X1003G03.....	13-7
9T14X1003G04.....	13-9
9T14X1003G33.....	13-7
9T14X1003G34.....	13-9
9T14X1003G63.....	13-7
9T14X1003G64.....	13-9
9T14X1004G03.....	13-7
9T14X1004G04.....	13-9
9T14X1004G33.....	13-7
9T14X1004G34.....	13-9
9T14X1004G63.....	13-7
9T14X1004G64.....	13-9
9T14X1005G03.....	13-7
9T14X1005G04.....	13-9
9T14X1005G33.....	13-7
9T14X1005G34.....	13-9
9T14X1005G63.....	13-7
9T14X1005G64.....	13-9
9T14X1006G03.....	13-7
9T14X1006G04.....	13-9
9T14X1006G33.....	13-7
9T14X1006G34.....	13-9
9T14X1006G63.....	13-7
9T14X1006G64.....	13-9
9T14X1007G03.....	13-7
9T14X1007G04.....	13-9
9T14X1007G33.....	13-7
9T14X1007G34.....	13-9
9T14X1007G63.....	13-7
9T14X1007G64.....	13-9
9T14X1008G03.....	13-7
9T14X1008G04.....	13-9
9T14X1008G33.....	13-7
9T14X1008G34.....	13-9
9T14X1008G63.....	13-7
9T14X1009G33.....	13-7
9T18W1071.....	13-17
9T18W1071G03.....	13-18
9T18W1071G04.....	13-18
9T18W1071G05.....	13-17
9T18W1071G06.....	13-14
9T18W1071G07.....	13-14
9T18W1071G10.....	13-14

Data subject to change without notice.

Midwest Electric Products
Section 16 – Product Index

Model Number	Page
9T18W1071G101.....	13-16
9T18W1071G11.....	13-15
9T18W1072.....	13-17
9T18W1072G03.....	13-18
9T18W1072G04.....	13-18
9T18W1072G06.....	13-14
9T18W1072G10.....	13-14
9T18W1072G101.....	13-16
9T18W1074.....	13-17
9T18W1074G03.....	13-18
9T18W1074G04.....	13-18
9T18W1074G06.....	13-14
9T18W1074G07.....	13-14
9T18W1074G10.....	13-14, 13-16
9T18W1074G11.....	13-15
9T18W1075.....	13-17
9T18W1075G03.....	13-18
9T18W1075G04.....	13-18
9T18W1075G10.....	13-14, 13-16
9T18W1076.....	13-17
9T18W1076G03.....	13-18
9T18W1076G04.....	13-18
9T18W1076G06.....	13-14
9T18W1076G10.....	13-14, 13-16
9T18W1077.....	13-17
9T18W1077G03.....	13-18
9T18W1077G04.....	13-18
9T18W1077G06.....	13-14
9T18W1077G09.....	13-15
9T18W1077G10.....	13-14, 13-16
9T18W1078.....	13-17
9T18W1078G03.....	13-18
9T18W1078G04.....	13-18
9T18W1078G09.....	13-15
9T18W1078G10.....	13-14, 13-16
9T18W1079.....	13-17
9T18W1079G03.....	13-18
9T18W1079G04.....	13-18
9T18W1079G06.....	13-14
9T18W1079G09.....	13-15
9T18W1079G10.....	13-14, 13-16
9T18W1171G06.....	13-15
9T18W1172G06.....	13-15
9T18W1174G06.....	13-15
9T18W1176G06.....	13-15
9T18W4317G05.....	13-14
9T18W4317G06.....	13-14
9T18W4322G77.....	13-14
9T18W4322G79.....	13-14
9T18W4504G77.....	13-15
9T18W4504G79.....	13-15
9T18W5042.....	13-14
9T18W5043.....	13-14
9T18W7240G02.....	13-14, 13-16
9T18W7240G021.....	13-16
9T18W7240G03.....	13-14, 13-16

Model Number	Page
9T18W7241G03.....	13-14, 13-16
9T18W7242G05.....	13-14, 13-16
9T18W7242G07.....	13-14, 13-16
9T18Y1071G05.....	13-17
9T18Y1072G05.....	13-17
9T18Y1074G05.....	13-17
9T18Y1076G05.....	13-17
9T18Y1077G05.....	13-17
9T18Y1078G05.....	13-17
9T18Y1079G05.....	13-17
9T21W1001G02.....	13-21
9T21W1002G02.....	13-21
9T21W1003G02.....	13-21
9T21W1004G02.....	13-22
9T21W1005G02.....	13-22
9T21W1006G02.....	13-22
9T21W1007G02.....	13-22
9T21W1008G02.....	13-22
9T21W1009G02.....	13-22
9T21W1013G02.....	13-22
9T21W1014G02.....	13-22
9T21W1015G02.....	13-22
9T21W1016G02.....	13-22
9T21W1019G02.....	13-22
9T21W1020G02.....	13-22
9T21W1021G02.....	13-22
9T21W1025G02.....	13-22
9T21W1028G02.....	13-21
9T21W1029G02.....	13-21
9T21W1030G02.....	13-21
9T21W1037G02.....	13-25
9T21W1040G02.....	13-25
9T21W1046G02.....	13-21
9T21W1047G02.....	13-21
9T21W1048G02.....	13-21
9T21W1054G02.....	13-21
9T21W1265G02.....	13-21
9T21W1266G02.....	13-21
9T21W4553G02.....	13-24
9T21W9101.....	13-21
9T21W9102.....	13-21
9T21W9103.....	13-22
9T21W9104.....	13-22
9T21W9105.....	13-22
9T21W9106.....	13-22
9T21W9109.....	13-22
9T21W9110.....	13-22
9T21W9111.....	13-22
9T21W9113.....	13-22
9T21W9114.....	13-22
9T21W9119.....	13-21
9T21W9120.....	13-21
9T21W9131.....	13-21
9T21W9143.....	13-21
9T21W9144.....	13-21
9T21W9201.....	13-24

Model Number	Page
9T21W9202.....	13-24
9T51W0002.....	13-19
9T51W0003.....	13-19
9T51W0004.....	13-19
9T51W0005.....	13-19
9T51W0007.....	13-19
9T51W0008.....	13-19
9T51W0009.....	13-19
9T51W0010.....	13-19
9T51W0011.....	13-19
9T51W0012.....	13-19
9T51W0013.....	13-19
9T51W0022.....	13-20
9T51W0024.....	13-20
9T51W0025.....	13-20
9T51W0027.....	13-20
9T51W0028.....	13-20
9T51W0029.....	13-20
9T51W0030.....	13-20
9T51W0031.....	13-20
9T51W0032.....	13-20
9T51W0033.....	13-20
9T51W0050.....	13-19
9T51W0051.....	13-19
9T51W0052.....	13-19
9T51W0053.....	13-19
9T51W0070.....	13-19
9T51W0071.....	13-19
9T51W0072.....	13-19
9T51W0073.....	13-19
9T51W0082.....	13-19
9T51W0083.....	13-19
9T51W0084.....	13-19
9T51W0085.....	13-19
9T51W0087.....	13-19
9T51W0088.....	13-19
9T51W0089.....	13-19
9T51W0090.....	13-19
9T51W0091.....	13-19
9T51W0092.....	13-19
9T51W0093.....	13-19
9T51W0102.....	13-25
9T51W0103.....	13-25
9T51W0104.....	13-25
9T51W0105.....	13-25
9T51W0107.....	13-25
9T51W0108.....	13-25
9T51W0109.....	13-25
9T51W0110.....	13-25
9T51W0111.....	13-25
9T51W0112.....	13-25
9T51W0113.....	13-25
9T51W0122.....	13-25
9T51W0123.....	13-25
9T51W0124.....	13-25
9T51W0125.....	13-25

Data subject to change without notice.

Midwest Electric Products
Section 16 – Product Index

Model Number	Page	Model Number	Page	Model Number	Page
9T51W0127	13-25	9T58W0000G46	13-30	9T58W1815G07	13-29
9T51W0128	13-25	9T58W0000G47	13-30	9T58W1824G07	13-29
9T51W0129	13-25	9T58W0000G48	13-30	9T58W1826G07	13-29
9T51W0130	13-25	9T58W00042	13-27	9T58W1828G07	13-29
9T51W0131	13-25	9T58W00043	13-27	9T58W1830G07	13-29
9T51W0132	13-25	9T58W00044	13-27	9T58W1832G07	13-29
9T51W0133	13-25	9T58W00045	13-27	9T58W1834G07	13-29
9T51W0135	13-19	9T58W00046	13-27	9T58W1835G07	13-29
9T51W01361	13-24	9T58W00047	13-27	9T58W1873G07	13-29
9T51W01371	13-24	9T58W00048	13-27	9T58W1874G07	13-29
9T51W01381	13-24	9T58W00049	13-27	9T58W1875G07	13-29
9T51W01391	13-24	9T58W00050	13-27	9T58W1876G07	13-29
9T51W01401	13-24	9T58W00051	13-27	9T58W1877G07	13-29
9T51W01411	13-24	9T58W00052	13-27	9T58W1878G07	13-29
9T51W0142	13-24	9T58W00053	13-27	9T58W1879G07	13-29
9T51W0143	13-24	9T58W00054	13-27	9T58W1881G07	13-29
9T51W0144	13-24	9T58W00055	13-27	9T58W1882G07	13-29
9T51W0145	13-24	9T58W00062	13-27	9T58W1883G07	13-29
9T51W0146	13-24	9T58W00063	13-27	9T58W1978G07	13-29
9T51W0147	13-24	9T58W00064	13-27	9T58W1979G07	13-29
9T51W0148	13-24	9T58W00065	13-27	9T58W1980G07	13-29
9T51W0150	13-24	9T58W00066	13-27	9T58W1981G07	13-29
9T51W0152	13-24	9T58W00067	13-27	9T58W2802	13-28
9T51W0153	13-24	9T58W00068	13-27	9T58W2803	13-28
9T51W0154	13-24	9T58W00069	13-27	9T58W2804	13-28
9T51W0156	13-20	9T58W00070	13-27	9T58W2805	13-28
9T51W0157	13-20	9T58W00071	13-27	9T58W2806	13-28
9T51W0158	13-20	9T58W00072	13-27	9T58W2807	13-28
9T51W0159	13-20	9T58W00073	13-27	9T58W2808	13-28
9T51W0160	13-20	9T58W00074	13-27	9T58W2809	13-28
9T51W0187	13-20	9T58W00082	13-27	9T58W2810	13-28
9T51W0188	13-20	9T58W00083	13-27	9T58W2811	13-28
9T51W0189	13-20	9T58W00084	13-27	9T58W2812	13-28
9T51W0190	13-20	9T58W00085	13-27	9T58W2813	13-28
9T51W0191	13-20	9T58W00086	13-27	9T58W2814	13-28
9T51W0192	13-20	9T58W00087	13-27	9T58W2815	13-28
9T51W0193	13-20	9T58W00088	13-27	9T58W2823	13-28
9T51W0202	13-25	9T58W00089	13-27	9T58W2824	13-28
9T51W0203	13-25	9T58W00090	13-27	9T58W2826	13-28
9T51W0204	13-25	9T58W00091	13-27	9T58W2827	13-28
9T51W0205	13-25	9T58W00092	13-27	9T58W2828	13-28
9T51W0207	13-25	9T58W00093	13-27	9T58W2830	13-28
9T51W0208	13-25	9T58W00094	13-27	9T58W2831	13-28
9T51W0209	13-25	9T58W1802G07	13-29	9T58W2832	13-28
9T51W0210	13-25	9T58W1803G07	13-29	9T58W2833	13-28
9T51W0211	13-25	9T58W1804G07	13-29	9T58W2834	13-28
9T51W0212	13-25	9T58W1805G07	13-29	9T58W2835	13-28
9T51W0213	13-25	9T58W1806G07	13-29	9T58W2873	13-28
9T58W0000G01	13-30	9T58W1807G07	13-29	9T58W2874	13-28
9T58W0000G05	13-30	9T58W1808G07	13-29	9T58W2875	13-28
9T58W0000G10	13-30	9T58W1809G07	13-29	9T58W2876	13-28
9T58W0000G18	13-30	9T58W1810G07	13-29	9T58W2877	13-28
9T58W0000G24	13-30	9T58W1811G07	13-29	9T58W2878	13-28
9T58W0000G38	13-30	9T58W1812G07	13-29	9T58W2879	13-28
9T58W0000G42	13-30	9T58W1813G07	13-29	9T58W2907	13-28
9T58W0000G43	13-30	9T58W1814G07	13-29	9T58W2909	13-28

Data subject to change without notice.

Midwest Electric Products
Section 16 – Product Index

Model Number	Page	Model Number	Page	Model Number	Page
9T58W2911	13-28	9T83X2572	13-4	BR53	14-2
9T58W2913	13-28	9T83X2572G15	13-4	BR54U	14-2
9T58W2914	13-28	9T83X2572G80	13-4	BR64U	14-2
9T58W2915	13-28	9T83X2573	13-4	C32U	14-2
9T58W2917	13-28	9T83X2573G15	13-4	C33	14-2
9T58W2918	13-28	9T83X2573G80	13-4	C34	14-2
9T58W2975	13-28	9T83X2574	13-4	C53	14-2
9T58W2978	13-28	9T83X2574G15	13-4	C54U	14-2
9T58W2979	13-28	9T83X2574G80	13-4	C64U	14-2
9T58W2980	13-28	9T83X2575	13-4	CB115	14-10
9T58W2981	13-28	9T83X2575G15	13-4	CB115T	14-10
9T58W2982	13-28	9T83X2575G80	13-4	CB120	14-10
9T58W2983	13-28	9T83X2576	13-4	CB120T	14-10
9T58W3024	13-28	9T83X2576G15	13-4	CB130	14-10
9T58W3164	13-28	9T83X2576G80	13-4	CB140	14-10
9T58W3715	13-29	AD2030	14-2	CB150	14-10
9T58W3716	13-29	AD3020	14-2	CB2100	14-10
9T58W3717	13-29	AD5020	14-2	CB2100H	14-10
9T58W3718	13-29	ARP0002MEP	2-9, 3-5	CB2101	14-10
9T58W3719	13-29	ARP00003MEP	2-9, 3-5	CB2101H	14-10
9T58W3720	13-29	ARP00004MEP	2-9, 3-5	CB215	14-10
9T58W3721	13-29	ARP00005MEP	2-9, 3-5	CB2150B	14-10
9T58W4050	13-28	ARP00006MEP	2-9, 3-5	CB2151	14-10
9T58W4051	13-28	ARP00007MEP	2-9, 3-5	CB220	14-10
9T58W4052	13-28	ARP00008MEP	2-9, 3-5	CB2200B	14-10
9T58W4053	13-28	ARP00015MEP	2-9, 3-5	CB2201	14-10
9T58W4132	13-28	ARP00016MEP	2-9, 3-5	CB2201H	14-10
9T58W4133	13-28	ARP00017MEP	2-9, 3-5	CB220T	14-10
9T83W2670	13-4	ARP00018MEP	2-9, 3-5	CB230	14-10
9T83W2670G15	13-4	ARP00019MEP	2-9, 3-5	CB230T	14-10
9T83W2670G80	13-4	ARP00020MEP	2-9, 3-5	CB240	14-10
9T83W2671	13-4	ARP00021MEP	2-9, 3-5	CB250	14-10
9T83W2671G15	13-4	ARP00023MEP	2-9, 3-5	CB250T	14-10
9T83W2671G80	13-4	ARP00035MEP	2-9, 3-5	CB260	14-10
9T83W2672	13-4	ARP00118MEP	2-9, 3-5	CB270	14-10
9T83W2672G15	13-4	ARP00129MEP	2-9, 3-5	CB4150H	14-10
9T83W2672G80	13-4	ARP00326MEP	2-9, 3-5	CB4200H	14-10
9T83W2673	13-4	ARP00427MEP	2-9	CBL2101	14-10
9T83W2673G15	13-4	ARP00429MEP	2-9, 3-5	CBL2151	14-10
9T83W2673G80	13-4	ARP00759MEP	2-9	CBL2201	14-10
9T83W2674	13-4	ARP00920MEP	2-9, 3-5, 14-5	CBT2102	14-10
9T83W2674G15	13-4	ARP00984MEP	2-9, 3-5	CBT2201	14-10
9T83W2674G80	13-4	ARP01590MEP	2-9, 3-5	CBT2201N	14-10
9T83W2675	13-4	ARP01595MEP	2-9	EK126	14-3
9T83W2675G15	13-4	ARP90015932MEP	2-9, 3-5	EK129	14-3
9T83W2675G80	13-4	ASR1	14-5	FBEM9	14-4
9T83W2676	13-4	B01	4-9, 14-4	FH1	14-7
9T83W2676G15	13-4	B07	4-9, 14-4	FH2	14-7
9T83W2676G80	13-4	B10	4-9, 14-4	FH3	14-7
9T83W2677	13-4	B12	4-9, 14-4	FH682	14-8
9T83X257	13-4	B15	4-9, 14-4	FR35	14-8
9T83X2570	13-4	B20	4-9, 14-4	FR352R	14-8
9T83X2570G15	13-4	B25	4-9, 14-4	FR35R	14-7
9T83X2570G80	13-4	BR32U	14-2	FR39	14-8
9T83X2571G15	13-4	BR33	14-2	FR64X2	14-8
9T83X2571G80	13-4	BR34	14-2	FR65	14-8

Data subject to change without notice.

Midwest Electric Products
Section 16 – Product Index

Model Number	Page	Model Number	Page	Model Number	Page
FR65X2.....	14-8	M009C010.....	9-7, 9-9	M076C010.....	9-6, 9-9
FR66.....	14-8	M011C010.....	9-7, 9-9	M076C010U.....	9-8, 9-9
FR67.....	14-8	M011C010U.....	9-8, 9-9	M076C033.....	9-6, 9-9
FR67X2.....	14-8	M011G.....	9-7, 9-9	M100C.....	1-3, 1-16
FR69.....	14-8	M031C010.....	11-7, 11-19	M100T.....	1-3, 1-16
GFI115.....	14-10	M036C010.....	9-6, 9-9	M101C.....	1-3, 1-16
GFI120.....	14-10	M036C010U.....	9-8, 9-9	M101CB2.....	1-3, 1-16
GFI130.....	14-10	M036C033.....	9-6, 9-9	M101CB6.....	1-11, 1-16
GFI220.....	14-10	M036G.....	9-6, 9-9	M101CB6HP.....	1-11, 1-16
GFI230.....	14-10	M038C010.....	9-7, 9-9	M101CC.....	1-3, 1-16
GFI240.....	14-10	M038C010U.....	9-8, 9-9	M101CP4.....	1-11, 1-16
GFI250.....	14-10	M038C033.....	9-7, 9-9	M101CP6.....	1-11, 1-16
GL3.....	14-13	M038C033U.....	9-8, 9-9	M101CP6C.....	1-11, 1-16
GS1101B12UL.....	8-3, 8-5	M038CB1010.....	9-7, 9-9	M101CP6HP.....	1-11, 1-16
GS1201B20UL.....	8-3, 8-5	M038CB1033.....	9-7, 9-9	M101CP6HP010.....	1-11, 1-16
GS1202B20M.....	8-4, 8-5	M038G.....	9-7, 9-9	M102CB2.....	1-3, 1-16
GS1202B20UL.....	8-3, 8-5	M038GB1.....	9-7, 9-9	M102CB2010.....	1-3, 1-16
GS1402B01UL.....	8-3, 8-5	M038GB1033.....	9-7, 9-9	M102E.....	1-3, 1-16
GS1404B01UL.....	8-3, 8-5	M041C010.....	11-7, 11-19	M108CP6HP010.....	1-11, 1-16
GS3161B12UL.....	8-3, 8-5	M041C010U.....	9-8, 9-9	M132CB6.....	10-9, 10-10
GS3161G.....	8-4, 8-5	M041CB6010.....	11-15, 11-19	M132CP6.....	10-9, 10-10
GS3262B25UL.....	8-3, 8-5	M041CP4010.....	11-16, 11-19	M181CB1.....	1-4, 1-16
GS3262G.....	8-4, 8-5	M041CP4L10.....	11-17, 11-19	M181CB1GP.....	1-4, 1-16
GS3402B01UL.....	8-3, 8-5	M041CP4L31.....	11-17, 11-19	M208CP6HP.....	1-12, 1-16
GS3404B01UL.....	8-3, 8-5	M041CP6010.....	11-13, 11-19	M208CR2A.....	1-6, 1-16
GS3464B01UL.....	8-3, 8-5	M041CP6L10.....	11-17, 11-19	M208CR2B.....	1-6, 1-16
LC1212PC.....	14-12	M041G.....	11-7, 11-19	M208CR2B010.....	1-7, 1-16
LC31N3.....	14-12	M041GB6.....	11-15, 11-19	M2100SB.....	4-9
LC31X3.....	14-12	M041GP4.....	11-16, 11-19	M2200LSB.....	4-9
LC32X1.....	14-12	M041GP6.....	11-13, 11-19	M2201SB.....	4-9
LC33N1.....	14-12	M051C010.....	9-6, 9-9	M2201SBP.....	4-9
LC33N1T.....	14-12	M051G.....	9-6, 9-9	M2201SBR.....	4-9
LC33N7.....	14-12	M055C010.....	9-6, 9-9	M254C.....	1-7, 1-16
LC44X1.....	14-12	M055C010U.....	9-8, 9-9	M254CP6.....	1-12, 1-16
LC55N1.....	14-12	M055C033.....	9-6, 9-9	M255GP6.....	1-12, 1-16
LC55N1T.....	14-12	M055C033U.....	9-8, 9-9	M275CP6010.....	11-14, 11-19
LC88PC.....	14-12	M055G.....	9-6, 9-9	M275CP6010G1.....	11-14, 11-19
LC88X2.....	14-12	M055GP6.....	11-13, 11-19	M280TM1.....	1-7, 1-16
LCB2101.....	14-10	M055GP6033.....	9-6, 9-9	M281C1.....	1-7, 1-16
LCB2151.....	14-10	M075C010.....	11-7, 11-19	M281C1B6H.....	1-13, 1-16
LCB2201.....	14-10	M075C010U.....	9-8, 9-9	M281C1P6H.....	1-12, 1-16
LCBNS.....	14-12	M075CB4010.....	11-16, 11-19	M281C1P6H010.....	1-12, 1-16
LCBS.....	14-12	M075CB6010.....	11-15, 11-19	M281C1P6HFB.....	1-12, 1-16
LCTL.....	14-12	M075CB6031.....	11-15, 11-19	M281C1S6H.....	1-12, 1-16
LCTNL.....	14-12	M075CP4010.....	11-16, 11-19	M281C1S6HC.....	1-12, 1-16
LT100B250.....	14-14	M075CP4L10.....	11-17, 11-19	M281CB1.....	1-6, 1-16
LT100B350.....	14-14	M075CP4L31.....	11-17, 11-19	M281CB1GP.....	1-6, 1-16
LT100S250.....	14-14	M075CP6010.....	11-13, 11-19	M281E1B6H.....	1-13, 1-16
LT100S300.....	14-14	M075CP6010GR.....	11-13, 11-19	M281E1P6H.....	1-12, 1-16
LT100S350.....	14-14	M075CP6031.....	11-13, 11-19	M281EB1.....	1-6, 1-16
LT200B350.....	14-14	M075CP6L10.....	11-17, 11-19	M282C1B6H.....	1-13, 1-16
LT200B350RF.....	14-14	M075CP6L31.....	11-17, 11-19	M282C1C.....	1-7, 1-16
LT200S350.....	14-14	M075G.....	11-7, 11-19	M282C1P6H.....	1-12, 1-16
LT200SS.....	14-14	M075GB6.....	11-15, 11-19	M282C1P6H010.....	1-12, 1-16
M004C010.....	11-7, 11-19	M075GP4.....	11-16, 11-19	M282C1P6HC.....	1-12, 1-16
M004CP6010.....	11-14, 11-19	M075GP6.....	11-13, 11-19	M282C1S6H.....	1-12, 1-16

Data subject to change without notice.

Midwest Electric Products
Section 16 – Product Index

Model Number	Page
M282CB1.....	1-6, 1-16
M282CB1C.....	1-6, 1-16
M282E1B6H.....	1-13, 1-16
M282E1P6H.....	1-12, 1-16
M282E1P6H010.....	1-12, 1-16
M282EB1.....	1-6, 1-16
M285T.....	1-7, 1-16
M354C.....	1-3, 1-16, 10-6, 10-10
M354CB6.....	1-11, 1-16
M354CP6.....	1-11, 1-16
M355C010.....	11-7, 11-19
M355C010U.....	9-8, 9-9
M355CP6010.....	11-13, 11-19
M355G.....	11-7, 11-19
M355GB6.....	11-15, 11-19
M355GP4.....	11-16, 11-19
M355GP6.....	11-13, 11-19
M358CP6.....	11-13, 11-19
M654CP6.....	1-12, 1-16
M655GB6.....	11-15, 11-19
M655GP6.....	1-12, 1-16
M655GP6.....	11-14, 11-19
M675CP6010.....	11-14, 11-19
M775CB6010.....	11-15, 11-19
M775CP6010.....	11-14, 11-19
MAUX21D.....	6-5, 6-6
MAUX61S.....	6-5, 6-6
MAUX64D.....	6-5, 6-6
MBSB.....	4-9
MEPKR1AS1BTZ.....	2-3, 2-10
MEPKR1CS1BT.....	2-3, 2-10
MEPKR1DH1DQRZ.....	2-3, 2-10
MEPKR2CS1ET.....	3-3, 3-6
MEPKR3CS1ET.....	3-3, 3-6
MEPKR4CS1ET.....	3-4, 3-6
MEPKR5CS1ET.....	3-4, 3-6
MEPKR6CS1ET.....	3-4, 3-6
MEPKS1AS1BT.....	2-3, 2-10
MEPKS1AS1BTV.....	2-3, 2-10
MEPKS1CS1BJT.....	2-3, 2-10
MEPKS1CS1BJTV.....	2-3, 2-10
MEPKS1CS1DT.....	2-3, 2-10
MEPKS1CS1DTV.....	2-3, 2-10
MEPKS1DS1AT.....	2-3, 2-10
MEPKS1DS1ATV.....	2-3, 2-10
MEPKU1CW3CT.....	2-3, 2-10
MEPKU1FS1EMT.....	2-5, 2-10
MGF221N.....	6-3, 6-6, 6-7
MGF221NR.....	6-3, 6-6, 6-7
MGF222N.....	6-3, 6-6, 6-7
MGF222NR.....	6-3, 6-6, 6-7
MGF223N.....	6-3, 6-6, 6-7
MGF223NR.....	6-3, 6-6, 6-7
MGF224N.....	6-3, 6-6, 6-7
MGF224NR.....	6-3, 6-6, 6-7
MGF321N.....	6-3, 6-6, 6-7

Model Number	Page
MGF321NR.....	6-3, 6-6, 6-7
MGF322N.....	6-3, 6-6, 6-7
MGF322NR.....	6-3, 6-6, 6-7
MGF323N.....	6-3, 6-6, 6-7
MGF323NR.....	6-3, 6-6, 6-7
MGF324N.....	6-3, 6-6, 6-7
MGF324NR.....	6-3, 6-6, 6-7
MGK12.....	4-8
MGK24.....	4-8
MGK32.....	4-8
MGK4.....	4-8
MGK42.....	4-8
MGL1.....	4-8
MGL2.....	4-8, 6-5, 6-6
MGL20.....	4-8
MGL4.....	6-5, 6-6
MGL8.....	4-8
MGR12.....	6-5, 6-6
MGR22.....	6-5, 6-6
MGR42.....	6-5, 6-6
MGU321.....	6-3, 6-6, 6-7
MGU321R.....	6-3, 6-6, 6-7
MGU322.....	6-6, 6-7
MGU3222.....	6-3
MGU322R.....	6-6, 6-7
MGU322R2.....	6-3
MGU323.....	6-6, 6-7
MGU3232.....	6-3
MGU323R.....	6-6, 6-7
MGU323R2.....	6-3
MGU324.....	6-3, 6-6, 6-7
MGU324R.....	6-3, 6-6, 6-7
MHF221N.....	6-4, 6-6, 6-8
MHF221NR.....	6-4, 6-6, 6-8
MHF222N.....	6-4, 6-6, 6-8
MHF222NR.....	6-4, 6-6, 6-8
MHF223N.....	6-4, 6-6, 6-8
MHF223NR.....	6-4, 6-6, 6-8
MHF224N.....	6-4, 6-6, 6-8
MHF224NR.....	6-4, 6-6, 6-8
MHF321N.....	6-4, 6-6, 6-8
MHF321NR.....	6-4, 6-6, 6-8
MHF322N.....	6-4, 6-6, 6-8
MHF322NR.....	6-4, 6-6, 6-8
MHF323N.....	6-4, 6-6, 6-8
MHF323NR.....	6-4, 6-6, 6-8
MHF324N.....	6-4, 6-6, 6-8
MHF324NR.....	6-4, 6-6, 6-8
MHF361.....	6-4, 6-6, 6-8
MHF361R.....	6-4, 6-6, 6-8
MHF362.....	6-4, 6-6, 6-8
MHF362R.....	6-4, 6-6, 6-8
MHF363.....	6-4, 6-6, 6-8
MHF363R.....	6-4, 6-6, 6-8
MHF364.....	6-4, 6-6, 6-8
MHF364R.....	6-4, 6-6, 6-8

Model Number	Page
MHLK2125.....	4-8
MHLK2150.....	4-8
MHLK2200.....	4-8
MHQLRK.....	4-9
MHQLRK1.....	4-9
MHQLRK2.....	4-9
MHQLRK3.....	4-9
MHQLRK4.....	4-9
MHQMVSBF.....	4-9
MHR12.....	6-5, 6-6
MHR16.....	6-5
MHR22.....	6-5, 6-6
MHR26.....	6-5
MHR46.....	6-5, 6-6
MHU361.....	6-6, 6-8
MHU361.....	6-4
MHU361R.....	6-6
MHU361R.....	6-8
MHU361R.....	6-8
MHU361R.....	6-4
MHU362.....	6-4, 6-6, 6-8
MHU362R.....	6-4, 6-6, 6-8
MHU363.....	6-4, 6-6, 6-8
MHU363R.....	6-4, 6-6, 6-8
MHU364.....	6-4, 6-6, 6-8
MHU364R.....	6-4, 6-6, 6-8
ML240RCU.....	4-3, 4-6
ML240SCU.....	4-3, 4-6
ML270RCU.....	4-3, 4-6
ML270SCU.....	4-3, 4-6
ML412C.....	4-6
ML412C2.....	4-3
ML412R1.....	4-3, 4-6
MLK300.....	4-8
MLM1212CCU.....	4-4, 4-6
MLM1212RCU.....	4-4, 4-6
MLM1612CCU.....	4-4, 4-6
MLM1620CCU.....	4-5, 4-6
MLM1620RCU.....	4-5, 4-6
MLM2020CCU.....	4-5, 4-6
MLM2020RCU.....	4-5, 4-6
MLM2412CCU.....	4-4, 4-6
MLM2412RCU.....	4-4, 4-6
MLM2415RCU.....	4-4, 4-6
MLM3220CCU.....	4-5, 4-6
MLM3220RCU.....	4-5, 4-6
MLM4020CCU.....	4-5, 4-6
MLM4020RCU.....	4-5, 4-6
MLM612FCU.....	4-3, 4-6
MLM612RCU.....	4-3, 4-6
MLM612SCU.....	4-3, 4-6
MLM812FCUD.....	4-3, 4-6
MLM812RCU.....	4-3, 4-6
MLM812SCUD.....	4-3, 4-6
MLSB.....	4-9
MLSB2P.....	4-9

Midwest Electric Products
Section 16 – Product Index

Model Number	Page
MLSBF.....	4-9
MLSBR.....	4-9
MLSBS.....	4-9
MM820RCUFL.....	4-5, 4-6
MNG3.....	4-8
MNG6.....	4-8
MNK1.....	6-5, 6-6
MNK2.....	6-5, 6-6
MNK2A.....	6-5, 6-6
MNK3.....	6-5, 6-6
MNK3A.....	6-5, 6-6
MNK4A.....	6-5, 6-6
MNLK20.....	4-8
MNLK250.....	4-8
MPL412R.....	4-3
MPL412R.....	4-6
MQMH000.....	4-12
MS125E.....	1-4, 1-16
MS150C.....	1-4, 1-16
MS150CGP.....	1-4, 1-16
MS151C.....	1-4, 1-17
MS1H.....	14-16
MS1S.....	14-16
MS2453C.....	1-5, 1-17
MS250C.....	1-5, 1-17
MS250CGP.....	1-5, 1-17
MS251C.....	1-5, 1-17
MS252C.....	1-5, 1-17
MS252E014.....	1-5, 1-17
MS45500C.....	1-10, 1-17
MS45508C.....	1-10, 1-17
MS62.....	14-3
MSB.....	4-9
MSB14T.....	14-4
MSBN1A.....	14-16
MSBN4.....	14-16
MSM10014.....	14-16
MSM1009301.....	14-16
MSM100EZ.....	14-16
MSM100P91.....	14-16
MSM200141.....	14-16
MSMP.....	14-16
MSMS.....	14-16
MSR100930.....	14-16
MSR100EZ.....	14-16
MSR100P9.....	14-16
MSR20014.....	14-16
MSRP.....	14-16
MSRS.....	14-16
MW200M.....	14-16
MW200R.....	14-16
NEU100B2.....	14-13
NEU102.....	14-13
NEU202.....	14-13
NEU407.....	14-13
NF65.....	14-7

Model Number	Page
NF652.....	14-8
NI200.....	14-13
NI200A5.....	14-13
NI400A1.....	14-13
NI60B2.....	14-13
P035F.....	7-3, 7-6
P065F.....	7-3, 7-6
P065NA1.....	7-3, 7-6
P065P.....	7-3, 7-6
P065P1.....	7-3, 7-6
P5POST.....	14-2
P6POST.....	14-2
PC2LC.....	14-12
PGT2-20042.....	14-5
PLK50.....	14-5
PNS4-C0002.....	14-5
PR32U.....	14-2
PR33.....	14-2
PR34.....	14-2
PR53.....	14-2
PR54U.....	14-2
PR64U.....	14-2
R011C010.....	9-7, 9-9
R011C010U.....	9-8, 9-9
R011G.....	9-7, 9-9
R031C010.....	11-7, 11-19
R031C010U.....	9-8, 9-9
R036C010.....	9-6, 9-9
R036G.....	9-6, 9-9
R038C010.....	9-7, 9-9
R038C010U.....	9-8, 9-9
R038C033.....	9-7, 9-9
R038C033U.....	9-8, 9-9
R038CP4010.....	9-7, 9-9
R038CP4033.....	9-7, 9-9
R038G.....	9-7, 9-9
R038GU.....	9-8, 9-9
R041C010.....	11-7, 11-19
R041CP6010.....	11-13, 11-19
R041G.....	11-7, 11-19
R041GB6.....	11-15, 11-19
R041GP6.....	11-13, 11-19
R055C010.....	9-6, 9-9
R055C010U.....	9-8, 9-9
R055C033.....	9-6, 9-9
R055C033U.....	9-8, 9-9
R055G.....	9-6, 9-9
R058C.....	10-6, 10-10
R058CB6.....	10-9, 10-10
R058CP6.....	10-9, 10-10
R075C010.....	11-7, 11-19
R075C010U.....	9-8, 9-9
R075CB6010.....	11-15, 11-19
R075CB6010FMG.....	11-15, 11-20
R075CP4010.....	11-16, 11-20
R075CP6010.....	11-13, 11-20

Model Number	Page
R075CP6010FMG.....	11-13, 11-20
R075CP6010Z1.....	11-13, 11-20
R075CP6031.....	11-13, 11-20
R075GB6.....	11-15, 11-20
R075GP6.....	11-13, 11-20
R076C010.....	9-6, 9-9
R076C010U.....	9-8, 9-9
R076C033.....	9-6, 9-9
R100C.....	1-3, 1-17
R100T.....	1-17
R100T4.....	1-3
R101C.....	1-3, 1-17
R101CB2.....	1-3, 1-17
R101CB2010.....	1-3, 1-17
R101CB2ETG.....	1-3, 1-17
R101CB2LK.....	1-3, 1-17
R101CB6.....	1-11, 1-17
R101CB6HP.....	1-11, 1-17
R101CP4.....	1-11, 1-17
R101CP6.....	1-11, 1-17
R101CP6HP.....	1-11, 1-17
R102CB2.....	1-3, 1-17
R102CB2LK.....	1-3, 1-17
R102E.....	1-3, 1-17
R102EN.....	1-3, 1-17
R108CP6HP034.....	1-14, 1-17
R158CR2TLFMG.....	1-4, 1-17
R181CB1.....	1-4, 1-17
R181CB1GP.....	1-4, 1-17
R200T.....	1-7, 1-17
R208CP6HP.....	1-12, 1-17
R208CR2A.....	1-6, 1-17
R208CR2A034.....	1-14, 1-17
R208CR2AETG.....	1-6, 1-17
R208CR2TLFMG.....	1-6, 1-17
R225CP6.....	1-12, 1-17
R2502CP6.....	1-12, 1-17
R255CB6010.....	1-11, 1-17
R255CP6010.....	1-12, 1-17
R256EB1018A.....	1-6, 1-17
R256EB118AETG.....	1-6, 1-17
R256EB118FMG.....	1-6, 1-17
R256EB1A.....	1-6, 1-17
R256EB1AETG.....	1-6, 1-17
R256EB1FMG.....	1-6, 1-17
R256EB1NA.....	1-6, 1-17
R256EB1NAETG.....	1-6, 1-17
R256EB1NFMG.....	1-6, 1-17
R280T.....	1-7, 1-17
R280TP6HP.....	1-7, 1-17
R281C1.....	1-7, 1-17
R281C1034.....	1-14, 1-17
R281C1B6H.....	1-13, 1-17
R281C1B6H034.....	1-15, 1-17
R281C1P6H.....	1-12, 1-17
R281C1P6H034.....	1-15, 1-17

Data subject to change without notice.

Midwest Electric Products
Section 16 – Product Index

Model Number	Page
R281C1P6H4.....	1-12, 1-18
R281C1S6HC	1-12, 1-18
R281CB1	1-6, 1-18
R281CB1034	1-14, 1-18
R281CB1AEP	1-6, 1-18
R281CB1ETG	1-6, 1-18
R281CB1GP	1-6, 1-18
R281CB1LK.....	1-6, 1-18
R281E1B6H.....	1-13, 1-18
R281E1B6H034.....	1-15, 1-18
R281E1P6H.....	1-12, 1-18
R281E1P6H034.....	1-15, 1-18
R281EB1.....	1-6, 1-18
R281EB1034.....	1-14, 1-18
R282C1B6H.....	1-13, 1-18
R282C1P6H.....	1-12, 1-18
R282CB1	1-6, 1-18
R282CB1LK.....	1-6, 1-13, 1-18
R282E1B6H.....	1-13, 1-18
R282E1P6H.....	1-12, 1-18
R282EB1.....	1-6, 1-18
R283CB1	1-6, 1-18
R283CB1AP.....	1-6, 1-18
R28TP6HP	1-17
R32U.....	14-2
R355CP6010	11-13, 11-20
R355CP6031	11-13, 11-20
R355G	11-7, 11-20
R355GP6	11-13, 11-20
R400P6034	1-15, 1-18
R455CP6034	1-15, 1-18
R481C1P6H034.....	1-15, 1-18
RS150C	1-4, 1-18
RS150CGP	1-4, 1-18
RS250C	1-5, 1-18
RS250CGP	1-5, 1-18
RS251C	1-5, 1-18
RS43308C	1-10, 1-18
RS43308CGP	1-10, 1-18
RS45500C	1-10, 1-18
RS45500CAEP.....	1-10, 1-18
RS45508C	1-10, 1-18
RS45508CAEP.....	1-10, 1-18
RS45508CGP	1-10, 1-18
RS45524CFMG.....	1-10, 1-18
S-02S-CA20023E.....	14-6
S-02S-CA20023LCD.....	14-6
SFEM6.....	14-4
SFEM9.....	14-4
SNPR1	14-5
STC1.....	7-5
T1206.....	12-3, 12-4
T1210.....	12-3, 12-4
T1220.....	12-3, 12-4
T1240UL.....	12-3, 12-4
T3210.....	12-3, 12-4

Model Number	Page
T3220.....	12-3, 12-4
T3610.....	12-3, 12-4
T3620.....	12-3, 12-4
T3640UL.....	12-3, 12-4
THHQL1115.....	4-11
THHQL1115AF2.....	4-13
THHQL1115DF.....	4-13
THHQL1115GFT.....	4-13
THHQL1115HID	4-14
THHQL1120.....	4-11
THHQL1120AF2.....	4-13
THHQL1120DF.....	4-13
THHQL1120GFT.....	4-13
THHQL1120HID	4-14
THHQL1125.....	4-11
THHQL1125GFT.....	4-13
THHQL1130.....	4-11
THHQL1130GFT.....	4-13
THHQL1130HID	4-14
THHQL1135.....	4-11
THHQL1140.....	4-11
THHQL1145.....	4-11
THHQL1150.....	4-11
THHQL21100.....	4-11, 4-12, 14-10
THHQL21110.....	4-11, 4-12
THHQL21125.....	4-11, 4-12
THHQL2115.....	4-11, 4-12
THHQL2115HID	4-14
THHQL2120.....	4-11, 4-12
THHQL2120HID	4-14
THHQL2125.....	4-11, 4-12
THHQL2130.....	4-11, 4-12
THHQL2130HID	4-14
THHQL2135.....	4-11, 4-12
THHQL2140.....	4-11, 4-12
THHQL2145.....	4-11, 4-12
THHQL2150.....	4-11, 4-12
THHQL2160.....	4-11, 4-12
THHQL2170.....	4-11, 4-12
THHQL2180.....	4-11, 4-12
THHQL2190.....	4-11, 4-12
THQD22100WL	14-10
THQD22200WL	14-10
THQL1115	4-11
THQL1115AF2.....	4-13
THQL1115DF.....	4-13
THQL1115GFEP.....	4-13
THQL1115GFT	4-13, 14-10
THQL1115HID	4-14
THQL1115HM.....	4-14
THQL1115ST1	4-14
THQL1120	4-11, 14-10
THQL1120AF2.....	4-13
THQL1120DF.....	4-13
THQL1120GFEP.....	4-13
THQL1120GFT	4-13, 14-10

Model Number	Page
THQL1120HID	4-14
THQL1120HM.....	4-14
THQL1120ST1.....	4-14
THQL1125	4-11
THQL1125GFT	4-13
THQL1125HM.....	4-14
THQL1130	4-11, 14-10
THQL1130GFEP.....	4-13
THQL1130GFT	4-13, 14-10
THQL1130HID	4-14
THQL1130HM.....	4-14
THQL1130ST1.....	4-14
THQL1135	4-11
THQL1135ST1.....	4-14
THQL1140	4-11, 14-10
THQL1140HM.....	4-14
THQL1140ST1.....	4-14
THQL1145	4-11
THQL1145ST1.....	4-14
THQL115	14-10
THQL1150	4-11, 14-10
THQL1150HM.....	4-14
THQL1150ST1.....	4-14
THQL21100	4-11, 4-12, 14-10
THQL21100ST1	4-14
THQL21110	4-11, 4-12
THQL21125	4-11, 4-12
THQL2115	4-11, 4-12, 14-10
THQL2115GFEP.....	4-13
THQL2115GFT	4-13
THQL2115HID	4-14
THQL2115ST1.....	4-14
THQL2120	4-11, 4-12, 14-10
THQL2120GFEP.....	4-13
THQL2120GFT	4-13, 14-10
THQL2120HID	4-14
THQL2120ST1.....	4-14
THQL2125	4-11, 4-12
THQL2125GFT	4-13
THQL2130	4-11, 4-12, 14-10
THQL2130GFEP.....	4-13
THQL2130GFT	4-13, 14-10
THQL2130HID	4-14
THQL2130ST1.....	4-14
THQL2135	4-11, 4-12
THQL2135ST1.....	4-14
THQL2140	4-11, 4-12, 14-10
THQL2140GFT	4-13, 14-10
THQL2140ST1.....	4-14
THQL2145	4-11, 4-12
THQL2145ST1.....	4-14
THQL2150	4-11, 4-12, 14-10
THQL2150GFT	4-13, 14-10
THQL2150ST1.....	4-14
THQL2160	4-11, 4-12, 14-10
THQL2160ST1.....	4-14

Midwest Electric Products
Section 16 – Product Index

Model Number	Page
THQL2170	4-11, 4-12, 14-10
THQL2170ST1	4-14
THQL2180	4-11, 4-12
THQL2180ST1	4-14
THQL2190	4-11, 4-12
THQL2190ST1	4-14
THQMV100D	4-12
THQMV125D	4-12
THQMV150D	4-12
THQMV150WLBP	14-10
THQMV175D	4-12
THQMV200D	4-12
THQMV200WLBP	14-10
THQMV225D	4-12
THQP115	4-11, 14-10
THQP120	4-11, 14-10
THQP125	4-11
THQP130	4-11
THQP135	4-11
THQP140	4-11
THQP145	4-11
THQP150	4-11
THQP215	4-11
THQP220	4-11, 14-10
THQP225	4-11
THQP230	4-11, 14-10
THQP235	4-11
THQP240	4-11
THQP245	4-11
THQP250	4-11, 14-10
TQD22100WL	14-10
TQD22150WL	14-10
TQD22200WL	14-10
TQDL	14-10
TTV001	14-3
TTV001T	14-3
TTV100	14-3
TTV100T	14-3
TTV150	14-3
TTV150T	14-3
TVTV200	14-3
TXQL1115	4-11
TXQL1120	4-11
TXQL1125	4-11
TXQL1130	4-11
TXQL2115	4-11
TXQL2120	4-11
TXQL2125	4-11
TXQL2130	4-11
U002C	10-5, 10-10
U004CB4010	11-12, 11-20
U004CB6010	11-12, 11-20
U004CP4010	11-9, 11-20
U004CP4031	11-9, 11-20
U004CP6010	11-9, 11-20
U004CP6L10	11-9, 11-20

Model Number	Page
U004CTL010	10-6, 10-10
U004F	10-6, 10-10
U01	14-4
U010	10-3, 10-10
U010010	10-3, 10-10
U010010GRP	10-7, 10-10
U010C	10-4, 10-10
U010C010	11-5, 11-20
U010C025	10-7, 10-10
U010F	10-3, 10-10
U010G	11-5, 11-20
U010H	10-3, 10-10
U010S010	10-7, 10-10
U010S010GRP	10-7, 10-10
U010SEP	10-3, 10-10
U011	10-3, 10-10
U011010	10-3, 10-10
U011C010	11-5, 11-20
U011CP4010	11-8, 11-20
U011CP6010	11-8, 11-20
U011CTL010	11-6, 11-20
U011F	10-4, 10-10
U011G	11-5, 11-20
U011GB4	11-11, 11-20
U011GB6	11-11, 11-20
U011GP4	11-8, 11-20
U011GP6	11-8, 11-20
U011GTL	11-6, 11-20
U012010	10-3, 10-10
U012010GRP	10-7, 10-10
U013	10-3, 10-10
U013C	10-3, 10-10
U013F	10-3, 10-10
U014C010	10-10
U014C0102	10-5
U014CP6010	10-5, 10-10
U014GWTR	10-6, 10-10
U023	10-4, 10-10
U025S	10-7, 10-10
U030	9-3, 9-10
U031C010	11-6, 11-20
U0353F	7-3, 7-6
U0353F010	7-4, 7-6
U035F010	7-4, 7-6
U035F2	7-3, 7-6
U036C010	9-3, 9-10
U036C033	9-3, 9-10
U036G	9-3, 9-10
U038C010	9-5, 9-10
U038C033	9-5, 9-10
U038CTL010	9-5, 9-10
U038CTL033	9-5, 9-10
U038G	9-5, 9-10
U038G033	9-5, 9-10
U039G6	9-5, 9-10
U04	4-9, 14-4

Model Number	Page
U040G	11-5, 11-20
U040GP4	11-8, 11-20
U040GP6	11-8, 11-20
U040GP6010	11-8, 11-20
U040GTL	11-6, 11-20
U041	10-4, 10-10
U041010	10-4, 10-10
U041C	10-5, 10-10
U041C010P	11-5, 11-20
U041CB4010	11-11, 11-20
U041CB4L10	11-18, 11-20
U041CB6010	11-11, 11-20
U041CB6L10	11-18, 11-20
U041CP4010	11-8, 11-20
U041CP4031	11-8, 11-20
U041CP4L10	11-18, 11-20
U041CP6010	11-8, 11-20
U041CP6031	11-8, 11-20
U041CP6L10	11-18, 11-20
U041CTL010	11-6, 11-20
U041CTLL10	11-17, 11-20
U041F	10-4, 10-10
U041G	11-5, 11-20
U041GB4	11-11, 11-20
U041GB6	11-11, 11-20
U041GP4	11-8, 11-20
U041GP4L	11-18, 11-20
U041GP6	11-8, 11-20
U041GP6L	11-18, 11-20
U041GTL	11-6, 11-21
U042GB6	11-11, 11-21
U042GP6	11-8, 11-21
U043GP6	11-8, 11-21
U045F	7-4, 7-6
U050	10-4, 10-10
U050C	10-5, 10-10
U051C	9-4, 9-10
U051C010	9-4, 9-10
U051C033	9-4, 9-10
U051F	10-4, 10-10
U051G	9-4, 9-10
U054	10-4, 10-10
U054C	9-4, 9-10
U054F	10-4, 10-10
U055010	10-4, 10-10
U055C010P	9-4, 9-10
U055C033	9-4, 9-10
U055CP4010	11-8, 11-21
U055CP6010	11-8, 11-21
U055F	10-4, 10-10
U055G	9-4, 9-10
U055GB6	11-11, 11-21
U058C	10-5, 10-10
U058CB6	10-8, 10-10
U058CP6	10-8, 10-10
U061C	10-4, 10-10

Data subject to change without notice.

Midwest Electric Products
Section 16 – Product Index

Model Number	Page	Model Number	Page	Model Number	Page
U061CB6	10-8, 10-10	U101CP6	1-13, 1-18	U775CP6010	11-9, 11-21
U061CP6	10-8, 10-10	U102E	1-8, 1-18	U870G6	10-6, 10-11
U061CTL	10-5, 10-10	U102EP6	1-13, 1-18	U92197CCCPLMEP	2-3, 2-10
U0653F	7-3, 7-6	U12	14-4	UAFHTRS202BSHMEP	2-3, 2-10
U0653F010	7-4, 7-6	U131CP6010	11-9, 11-21	UAFHTRS223ASHMEP	2-3, 2-10
U0653P	7-3, 7-6	U131CTL010	11-6, 11-21	UAFTH4330TSHMEP	2-5, 2-10
U0653P010	7-3, 7-6	U132CB6	10-8, 10-10	UAFTH4336TSHMEP	2-5, 2-10
U065F010	7-4, 7-6	U132CP6	10-8, 10-10	UAFTH5213BNDMEP	2-8, 2-10
U065F1	7-3, 7-6	U132CTL	10-5, 10-10	UAFTH7213TSHMEP	2-6, 2-10
U065NA1	7-4, 7-6	U15	14-4	UAFTH7330TSHMEP	2-7, 2-10
U065NA1010	7-4, 7-6	U175CP6HP010	11-9, 11-21	UAFTH7336TSHMEP	2-7, 2-10
U065NA2	7-4, 7-6	U180C1	1-9, 1-18	UATH4203BFLMEP	2-4, 2-10
U065P	7-3, 7-6	U181C1	1-9, 1-18	UATH4203TFLMEP	2-4, 2-10
U065P010	7-4, 7-6	U20	14-4	UATH4213CFLMEP	2-4, 2-10
U065PC2	7-4, 7-6	U208C	1-9, 1-18	UATH4213UFLMEP	2-4, 2-10
U065PD	7-3, 7-6	U208CP6HP	1-13, 1-18	UATH4300TFLMEP	2-5, 2-10
U070C	10-5, 10-10	U220H	7-5, 7-6	UATH5203BFLMEP	2-8, 2-10
U072C	9-5, 9-10	U239G	10-6, 10-11	UATH5203TFLMEP	2-8, 2-10
U073G	9-5, 9-10	U25	14-4	UATH5213CFLMEP	2-8, 2-10
U074GTL	11-6, 11-21	U261F	7-5, 7-6	UATH5213UFLMEP	2-8, 2-10
U075C	10-5, 10-10	U27	4-9, 14-4	UATH5300TFLMEP	2-8, 2-10
U075CB4010	11-12, 11-21	U28	4-9, 14-4	UATH5330UFLMEP	2-8, 2-10
U075CB4031	11-12, 11-21	U280C1	1-9, 1-18	UATH7203BFLMEP	2-6, 2-10
U075CB4L10	11-18, 11-21	U281C1	1-9, 1-18	UATH7203TFLMEP	2-6, 2-10
U075CB6010	11-12, 11-21	U281C1P6H	1-13, 1-18	UATH7213CFLMEP	2-6, 2-10
U075CB6031	11-12, 11-21	U281E1	1-9, 1-18	UATH7213UFLMEP	2-6, 2-10
U075CB6L10	11-18, 11-21	U281E1P6H	1-13, 1-18	UATH7300TFLMEP	2-7, 2-10
U075CP4010	11-9, 11-21	U2R2332UMEP	3-3, 3-6	UATH7300UFLMEP	2-7, 2-11
U075CP4010Z1	11-9, 11-21	U30	4-9, 14-4	UATH7330UFLMEP	2-7, 2-11
U075CP4031	11-9, 11-21	U35	4-9, 14-4	UATRS202BFLMEP	2-4, 2-11
U075CP4L10	11-18, 11-21	U354C	1-8, 1-18	UATRS212CFLMEP	2-4, 2-11
U075CP4L31	11-18, 11-21	U354C	10-5, 10-11	UATRS213AFLMEP	2-4, 2-11
U075CP6010	11-9, 11-21	U355C010	11-6, 11-21	UATRS213CFLMEP	2-4, 2-11
U075CP6010BZ	11-9, 11-21	U355G	11-6, 11-21	UATRS223AFLMEP	2-4, 2-11
U075CP6010D	11-9, 11-21	U355GP6	11-9, 11-21	UATZRS101CFLMEP	2-3, 2-11
U075CP6010T	11-9, 11-21	U361G	10-5, 10-11	UBC7213BMEP	2-6, 2-11
U075CP6031	11-9, 11-21	U40	4-9, 14-4	UBH2R1121BMEP	3-3, 3-6
U075CP6L10	11-18, 11-21	U412CP6010	11-8, 11-21	UBH2R2332TMEP	3-3, 3-6
U075CP6L31	11-18, 11-21	U412G	11-5, 11-21	UBH3R1121BMEP	3-3, 3-6
U075CP6L31BZ	11-18, 11-21	U412GP6	11-8, 11-21	UBH3R2332TMEP	3-3, 3-6
U075CTL010	11-6, 11-21	U501	10-4, 10-11	UBH7213TMEP	2-6, 2-11
U075CTL035	11-17, 11-21	U511C	10-5, 10-11	UBHRS101BMEP	2-3, 2-11
U075CTLL10	11-17, 11-21	U511G	10-5, 10-11	UBHRS202BMEP	2-4, 2-11
U075GB6	11-12, 11-21	U546	10-5, 10-11	UBHRS212BMEP	2-4, 2-11
U075GP4	11-9, 11-21	U550F	10-4, 10-11	UBTH4330TMEP	2-9
U075GP4L	11-18, 11-21	U610F	7-4, 7-6	UFHT2R2332TMEP	3-3, 3-6
U075GP6	11-9, 11-21	U611CB4010	11-12, 11-21	UFHT3R2332TMEP	3-3, 3-6
U075GP6019	11-9, 11-21	U611CB6010	11-12, 11-21	UFHT4R2352TMEP	3-4, 3-6
U075GP6C	11-9, 11-21	U611CP4010	11-9, 11-21	UFHT5R2392TTMEP	3-4, 3-6
U075GP6L	11-18, 11-21	U611CP6010	11-9, 11-21	UFHT6R2392TTMEP	3-4, 3-6
U075GTL	11-6, 11-21	U611CTL010	11-5, 11-21	UFHTRS101BMEP	2-3, 2-11
U076C010	9-5, 9-10	U611GTL	11-5, 11-21	UFHTRS202BMEP	2-4, 2-11
U076C033	9-5, 9-10	U614C	10-5, 10-11	UFHTRS223AMEP	2-4, 2-11
U076G	9-5, 9-10	U666C010	10-5, 10-11	UFHTRS233CMEP	2-4, 2-11
U10	14-4	U775C010	11-6, 11-21	UFTH4213CMEP	2-4, 2-11
U101C	1-8, 1-18	U775CP4010	11-9, 11-21	UFTH4330TMEP	2-5, 2-11

Data subject to change without notice.

Midwest Electric Products
Section 16 – Product Index

Model Number	Page
UFTH4336TMEP	2-5, 2-11
UFTH5213BNDMEP	2-8, 2-11
UFTH7213BMEP	2-6, 2-11
UFTH7213TMEP	2-6, 2-11
UFTH7330TMEP	2-7, 2-11
UFTH7336TMEP	2-7, 2-11
UFTTH7213TMEP	2-6, 2-11
UFTTH7330TMEP	2-7, 2-11
UFTTH7336TMEP	2-7, 2-11
UG2R5332CKCMEP	3-3, 3-6
UG412RMW250	5-2
UG412RMW260	5-2
UGHRS212CKCMEP	2-4, 2-11
UGHTRS101BMEP	2-3, 2-11
UGHTRS213BMEP	2-4, 2-11
UGT2-20015	14-5
UGTH4213CMEP	2-4, 2-11
UGTH4330TMEP	2-9
UGTRS213CMEP	2-4, 2-11
UH4213CMEP	2-4, 2-11
UH43068TCPLMEP	2-5, 2-11
UH60G	14-6
UH7213CKCMEP	2-6, 2-11
UH7213CMEP	2-6, 2-11
UH90G	14-6
UH90GT	14-6
UH90STL	14-6
UHT2-20011	14-5
UHT2R2332TMEP	3-3, 3-6
UHT3R2332TMEP	3-3, 3-6
UHT4R2352TMEP	3-4, 3-6
UHT6R2392TTMEP	3-4, 3-6
UHTRS101BMEP	2-3, 2-11
UHTRS202BMEP	2-4, 2-11
UHTRS223AMEP	2-4, 2-11
UL412RMW	1-8, 1-18
URS101BCPLMEP	2-3, 2-11
URS101CCPLMEP	2-3, 2-11
URSTS132CMEP	2-6, 2-11
URTRS213AMEP	2-4, 2-11
UT2R1121BMEP	3-3, 3-6
UT2R2332TMEP	3-3, 3-6
UT2R2332UFLMEP	3-3, 3-6
UT2R5332BMEP	3-3, 3-6
UT3R1121BMEP	3-3, 3-6
UT3R2332TMEP	3-3, 3-6
UT3R2332UFLMEP	3-3, 3-6
UT3R5632BMEP	3-3, 3-6
UT4R1121BMEP	3-4, 3-6
UT4R2352TMEP	3-4, 3-6
UT4R2352UFLMEP	3-4, 3-6
UT4R5632BMEP	3-4, 3-6
UT5R1121BMEP	3-4, 3-6
UT5R2392TTMEP	3-4, 3-6
UT5R2392UUFLMEP	3-4, 3-6
UT6R1131BMEP	3-4, 3-6

Model Number	Page
UT6R2392TTMEP	3-4, 3-6
UT6R2392UUFLMEP	3-4, 3-6
UT92197CCFLMEP	2-4, 2-11
UTH4203BFLMEP	2-4, 2-11
UTH4203TFLMEP	2-4, 2-11
UTH4213BMEP	2-4, 2-11
UTH4213CFLMEP	2-4, 2-11
UTH4213CMEP	2-4, 2-11
UTH4213UFLMEP	2-4, 2-11
UTH4300TFLMEP	2-5, 2-11
UTH4300TMEP	2-5, 2-11
UTH4330TMEP	2-5, 2-9, 2-11
UTH43369TMEP	2-5, 2-11
UTH5203BFLMEP	2-8, 2-11
UTH5203BMEP	2-8, 2-12
UTH5203TFLMEP	2-8, 2-12
UTH5213BNDMEP	2-8, 2-12
UTH5213CFLMEP	2-8, 2-12
UTH5213CMEP	2-8, 2-12
UTH5213UFLMEP	2-8, 2-12
UTH5233CMEP	2-8, 2-12
UTH5300TFLMEP	2-8, 2-12
UTH5330UFLMEP	2-8, 2-12
UTH7203BFLMEP	2-6, 2-12
UTH7203TFLMEP	2-6, 2-12
UTH7203TMEP	2-6, 2-12
UTH7213BMEP	2-6, 2-12
UTH7213CMEP	2-6, 2-12
UTH7213THLMEP	2-6, 2-12
UTH7213TMEP	2-6, 2-12
UTH7213UMEP	2-6, 2-12
UTH7300TFLMEP	2-7, 2-12
UTH73069THLMEP	2-5, 2-12
UTH7330TMEP	2-7, 2-12
UTH7330UFLMEP	2-7, 2-12
UTH73369THLMEP	2-7, 2-12
UTJ7300UMEP	2-7, 2-12
UTRS101BMEP	2-3, 2-12
UTRS202BMEP	2-4, 2-12
UTRS212BMEP	2-4, 2-12
UTRS212CMEP	2-4, 2-12
UTRS2138BMEP	2-5, 2-12
UTRS213AFLMEP	2-5, 2-12
UTRS213BMEP	2-5, 2-12
UTRS213CFLMEP	2-5, 2-12
UTRS213CMEP	2-5, 2-12
UTRS223AFLMEP	2-5, 2-12
UTRS223AMEP	2-5, 2-12
UTRS502BMEP	2-3, 2-12
UTTH4330TMEP	2-9
UTZ2R1121CFLMEP	3-3, 3-6
UTZ3R1121CFLMEP	3-3, 3-6
UTZ4R1121CFLMEP	3-4, 3-6
UTZ5R1121CFLMEP	3-4, 3-6
UTZ6R1131CFLMEP	3-4, 3-6
UTZRS101CFLMEP	2-3, 2-12

Model Number	Page
UWATER34	14-6
UWATER34L	14-6
UWATER34WN	14-6

Product Index

Data subject to change without notice.

Notes

Notes

Information provided is subject to change without notice. Please verify all details with Midwest Electric Products. All values are design or typical values when measured under laboratory conditions, and Midwest makes no warranty or guarantee, express or implied, that such performance will be obtained under end-use conditions.

Midwest Electric Products
41 Woodford Avenue
Plainville, CT 06062
Customer Service: 866-685-0577 • Fax: 804-965-1041
www.midwestelectric.com

© 2018 Midwest Electric Products

MET017G (3/18)

