

## QS30 Series

Diffuse-Mode Laser Sensors



### QS30 Laser Features

- Visible laser beam for diffuse sensing
- Available with Class 1 or long-range Class 2 laser
- Excellent optical performance throughout sensing range, even close up
- Easy-to-set Expert-style TEACH options† including Static, Dynamic, and Single-Point programming plus manual adjustment for fine-tuning
- Easy-to-read operating status indicators, with 8-segment bargraph display
- Bipolar discrete outputs, PNP and NPN
- Selectable 30 millisecond OFF-delay
- Models available with 2 m or 9 m (6.5' or 30') cable or integral quick-disconnect
- Compact housing, mounting versatility – popular 30 mm threaded nose or side-mount

†U.S. Patent #5,808,296

### QS30 Laser Models

Model	Laser Class	Range	Spot Size at Focus	Cable*	Supply Voltage	Output Type	Excess Gain	Beam Pattern		
QS30LD	Class 1	400 mm (16")	Approx. 1 mm at 400 mm (0.039" at 16")	2 m (6.5') 5-wire Cable	10 - 30V dc	Bipolar NPN/PNP				
QS30LDQ				Integral 5-pin Euro-style QD						
QS30LDL	Class 2	800 mm (32")	Approx. 1 mm at 800 mm (0.039" at 32")	2 m (6.5') 5-wire Cable			10 - 30V dc	Bipolar NPN/PNP		
QS30LDLQ				Integral 5-pin Euro-style QD						

\*9 m (30') cables are available by adding suffix "W/30" to the model number of any cabled sensor (e.g., QS30LD W/30).  
A model with a QD connector requires a mating cable (see page 10).



#### **WARNING . . . Not To Be Used for Personnel Protection**

**Never use this product as a sensing device for personnel protection. Doing so could lead to serious injury or death.**

This product does NOT include the self-checking redundant circuitry necessary to allow its use in personnel safety applications. A sensor failure or malfunction can cause either an energized or de-energized sensor output condition. Consult your current Banner Safety Products catalog for safety products which meet OSHA, ANSI and IEC standards for personnel protection.

# QS30 Series Diffuse-Mode Laser Sensor

## QS30 Laser Overview

The QS30 is an easy-to-use, high-performance laser sensor whose many configuration options make it suitable for demanding applications. It provides high-performance sensing in low-contrast applications at relatively long range. It features static, dynamic and single-point TEACH-mode programming, in addition to manual fine adjustment, remote programming and security lockout options. A SETUP mode also may be used to change the sensor's output response (see page 8).

The sensor features two identically configured outputs, one each NPN and PNP.

The sensor's compact housing has a large, easy-to-see bar graph display plus bright LEDs for easy programming and status monitoring during operation. The sensor can be side-mounted, using its integral mounting holes, or front-mounted, via its 30 mm threaded barrel.

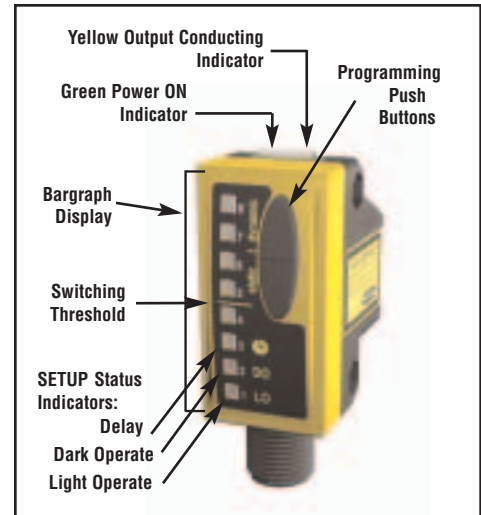

Figure 1. QS30 features

## QS30 Laser Specifications

<b>Sensing Beam</b>	<b>Class 1:</b> 650 nm visible red <b>Class 2:</b> 658 nm visible red
<b>Beam Size at Aperture</b>	Approx. 2 mm
<b>Laser Classification</b>	Class 1 or Class 2, depending on model (see page 3)
<b>Supply Voltage</b>	10 to 30V dc (10% max. ripple @ 10% duty cycle) @ 35 mA max current, exclusive of load
<b>Supply Protection Circuitry</b>	Protected against reverse polarity, over voltage, and transient voltages
<b>Delay at Power Up</b>	1 second max.; outputs do not conduct during this time
<b>Output Configuration</b>	Bipolar: 1 current sourcing (PNP) and 1 current sinking (NPN)
<b>Output Rating</b>	150 mA maximum load <b>OFF-state leakage current:</b> < 10 $\mu$ A at 30V dc <b>ON-state saturation voltage:</b> <b>NPN:</b> < 1.0V @ 150 mA load <b>PNP:</b> < 2.0V @ 150 mA load
<b>Output Protection</b>	Protected against output short-circuit, continuous overload, transient over-voltages, and false pulse on power up
<b>Output Response Time</b>	500 microseconds
<b>Repeatability</b>	70 microseconds
<b>Adjustments</b>	2 push buttons and remote wire <ul style="list-style-type: none"> <li>• <i>Expert</i> Teach programming (two-point static, dynamic, and single-point static)</li> <li>• Manually adjust (+/-) thresholds (from buttons only)</li> <li>• LO/DO and OFF-delay configuration options</li> <li>• Push-button lockout (from remote wire only)</li> </ul>
<b>Indicators</b>	<b>8-segment red bargraph:</b> Signal strength relative to switch-point <b>Green LED:</b> Power ON <b>Yellow LED:</b> Output conducting
<b>Construction</b>	ABS plastic housing; acrylic lens cover
<b>Environmental Rating</b>	IP67, NEMA 6
<b>Connections</b>	5-conductor 2 m (6.5') PVC cable, 9 m (30') PVC cable, or 5-pin integral Euro-style quick-disconnect fitting
<b>Operating Temperature</b>	-10° to +50°C, 90% relative humidity @ 50°C (non-condensing)
<b>Vibration and Mechanical Shock</b>	All models meet Mil. Std. 202F requirements. Method 201A (Vibration: 10 to 60Hz max. double amplitude 0.06", maximum acceleration 10G). Also meets IEC 947-5-2 requirements: 30G, 11 ms duration, half sine wave.
<b>Certifications</b>	CE

# QS30 Series Diffuse-Mode Laser Sensor

## Description of Laser Classes



### Class 1

Lasers that are safe under reasonably foreseeable conditions of operation, including the use of optical instruments for intrabeam viewing.  
Reference 60825-1 Amend. 2 © IEC:2001(E), section 8.2.

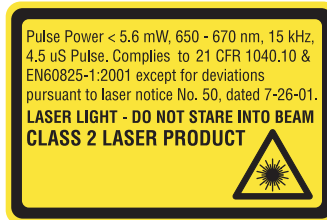

### Class 2

Lasers that emit visible radiation in the wavelength range from 400 nm to 700 nm where eye protection is normally afforded by aversion responses, including the blink reflex. This reaction may be expected to provide adequate protection under reasonably foreseeable conditions of operation, including the use of optical instruments for intrabeam viewing.  
Reference 60825-1 Amend. 2 © IEC:2001(E), section 8.2.

### Class 2 Laser Safety Notes:

Low-power lasers are, by definition, incapable of causing eye injury within the duration of the blink (aversion response) of 0.25 seconds. They also must emit only visible wavelengths (400 - 700 nm). Therefore, an ocular hazard can exist only if an individual overcomes their natural aversion to bright light and stares directly into the laser beam.

### For safe laser use:

- Do not permit a person to stare at the laser from within the beam.
- Do not point the laser at a person's eye at close range.
- Terminate the beam emitted by a Class 2 laser product at the end of its useful path. Locate open laser beam paths either above or below eye level, where practical.



### CAUTION

Use of controls or adjustments or performance of procedures other than those specified herein may result in hazardous radiation exposure; per EN 60825. **Do NOT attempt to disassemble this sensor for repair.** A defective unit must be returned to the manufacturer.

# QS30 Series Diffuse-Mode Laser Sensor

---

## Sensor Programming

Sensor configuration is accomplished through TEACH-mode programming and SETUP mode. After TEACH mode has defined the sensing parameters, SETUP mode may be used to add an OFF-delay or change the light/dark operate status. Manual Adjust may be used to fine-tune the thresholds (see page 7). Two push buttons, Dynamic (+) and Static (-), or the remote wire, may be used to access and set programming parameters.

Sensor programming may be accomplished using any of three TEACH methods. A single switching threshold may be programmed using either dynamic (on-the-fly) or static TEACH. In addition, Single-Point Static TEACH may be used to define a sensing window, centered on a single taught condition. Single-Point TEACH programming may be accomplished only statically.

## Remote Programming

The Remote Programming function may be used to program the sensor remotely or to disable the push buttons for security. Connect the gray wire of the sensor to ground (0V dc), with a remote programming switch connected between them. Pulse the remote line according to the diagrams in the programming procedures. The length of the individual programming pulses is equal to the value T:

$$0.04 \text{ seconds} \leq T \leq 0.8 \text{ seconds}$$

## Returning to RUN Mode

TEACH and SETUP modes each may be exited either after the 60-second time-out, or by exiting (cancelling out of) the process:

- In Static TEACH mode, press and hold the Static (-) button (or hold the remote line) for 2 seconds to exit. The sensor returns to RUN mode without saving any new settings.
- In SETUP mode, press and hold both the Static (-) and Dynamic (+) buttons (or hold the remote line) for 2 seconds to exit. The sensor returns to RUN mode and saves the current setting.

# QS30 Series Diffuse-Mode Laser Sensor

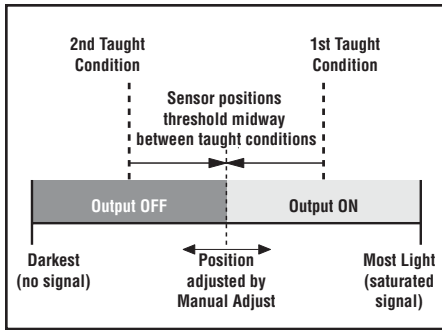

Figure 2. Two-Point TEACH (Light Operate shown)

Bargraph LED Number	Relative Contrast/ Recommendation
6 to 8	<b>Excellent:</b> Very stable operation.
4 to 5	<b>Good:</b> Minor sensing variables will not affect sensing reliability.
2 to 3	<b>Low:</b> Minor sensing variables will affect sensing reliability.
1	<b>Marginal:</b> Consider an alternate sensing scheme.

## Two-Point Static TEACH

- Two-point TEACH
- Sets a single switching threshold
- Threshold is adjustable using “+” and “-” buttons (Manual Adjust)

Two-Point Static TEACH is the traditional setup method, used when two conditions can be presented by the user. The sensor locates a single sensing threshold (the switch point) midway between the two taught conditions, with the Output ON condition on one side, and the Output OFF condition on the other (see Figure 2).

The first condition taught is the ON condition. The Output ON and OFF conditions can be reversed by changing Light/Dark Operate status in SETUP mode.

### Two-Point TEACH and Manual Adjust

Using Manual Adjust with Two-Point TEACH moves the switching threshold. The lighted LED on the light bar will move to exhibit the relative amount of received signal.

	Push Button	Remote Line	Display Shows
<b>Access TEACH Mode</b>	<ul style="list-style-type: none"> <li>• Press and Hold</li> </ul>	<ul style="list-style-type: none"> <li>No action required; sensor is ready for 1st TEACH condition.</li> </ul>	<ul style="list-style-type: none"> <li>Power LED: OFF</li> <li>Output LED: ON</li> <li>Bargraph: #5 &amp; 6 Flashing</li> </ul>
<b>Learn Output ON Condition</b>	<ul style="list-style-type: none"> <li>• Present Output ON condition</li> <li>• Click</li> </ul>	<ul style="list-style-type: none"> <li>• Present Output ON condition</li> <li>• Single-pulse remote line</li> </ul>	<ul style="list-style-type: none"> <li>Power LED: OFF</li> <li>Output LED: OFF</li> <li>Bargraph: #5 &amp; 6 Flashing</li> </ul>
<b>Learn Output OFF Condition</b>	<ul style="list-style-type: none"> <li>• Present Output OFF condition</li> <li>• Click</li> </ul>	<ul style="list-style-type: none"> <li>• Present Output OFF condition</li> <li>• Single-pulse remote line</li> </ul>	<ul style="list-style-type: none"> <li><b>Teach Accepted</b></li> <li>Power LED: ON</li> <li>Bargraph: One LED flashes to show relative contrast (good contrast shown; see table above)</li> <li>Sensor returns to RUN mode</li> </ul>
			<ul style="list-style-type: none"> <li><b>Teach Unacceptable</b></li> <li>Power LED: OFF</li> <li>Bargraph: #1, 3, 6, 8 flash to show fail</li> <li>Sensor returns to “Learn Output ON” condition</li> </ul>

# QS30 Series Diffuse-Mode Laser Sensor

## Dynamic TEACH and Adaptive Thresholds

- Teach on-the-fly
- Sets a single switching threshold
- Threshold position is adjustable using “+” and “-” buttons (Manual Adjust)

Dynamic TEACH is best used when a machine or process may not be stopped for teaching. A variation of two-point TEACH, it programs the sensor during actual machine run conditions, taking multiple samples of the light and dark conditions and automatically setting the threshold at the optimum level (see Figure 3).

Dynamic TEACH activates the sensor’s adaptive threshold system, which continuously tracks minimum and maximum signal levels, and automatically maintains centering of the switch point between the light and dark conditions. The adaptive threshold system remains in effect during RUN mode. The adaptive routine saves to non-volatile memory at least once per hour.

When Dynamic TEACH mode is used, the Output ON state (light or dark operate) will remain as it was last programmed. To change the Output ON state, use SETUP mode (see page 8).

The sensing set point may be adjusted (fine-tuned) whenever the sensor is in RUN mode by clicking the “+” and “-” buttons. However, when a manual adjustment is made, the adaptive threshold system is disabled (cancelled).

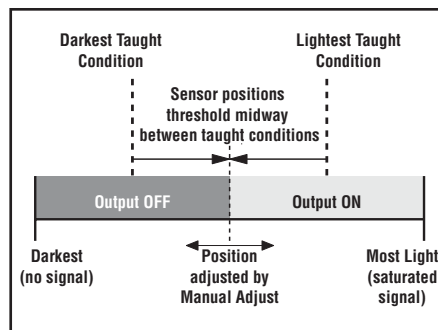

Figure 3. Two-Point Dynamic TEACH (Light Operate shown)

Bargraph LED Number	Relative Contrast/ Recommendation
6 to 8	<b>Excellent:</b> Very stable operation.
4 to 5	<b>Good:</b> Minor sensing variables will not affect sensing reliability.
2 to 3	<b>Low:</b> Minor sensing variables will affect sensing reliability.
1	<b>Marginal:</b> Consider an alternate sensing scheme.

	Push Button	Remote Line	Display Shows
<b>Access TEACH Mode</b>	<ul style="list-style-type: none"> <li>• Press and Hold</li> </ul>	<ul style="list-style-type: none"> <li>• Hold remote line low (to ground)</li> </ul>	Power LED: OFF Bargraph: #7 & 8 flashing 
<b>Learn Output ON and OFF</b>	<ul style="list-style-type: none"> <li>• Present Output ON and OFF conditions</li> <li>• Continue to hold</li> </ul>	<ul style="list-style-type: none"> <li>• Present Output ON and OFF conditions</li> <li>• Continue to hold remote line low (to ground)</li> </ul>	Power LED: OFF Bargraph: #7 & 8 flashing 
<b>Finish Learning</b>	<ul style="list-style-type: none"> <li>• Release</li> </ul>	<ul style="list-style-type: none"> <li>• Release remote line/switch</li> </ul>	<b>Teach Accepted</b> Power LED: ON Bargraph: One LED flashes to show relative contrast (good contrast shown; see table above) Sensor returns to RUN mode with new settings 
			<b>Teach Unacceptable</b> Power LED: OFF Bargraph: #1, 3, 6, 8 flash to show fail Sensor returns to RUN mode without changing settings 

# QS30 Series Diffuse-Mode Laser Sensor

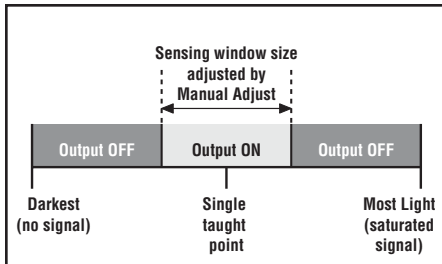

Figure 4. Single-Point TEACH (Light Operate shown)

## Single-Point Static TEACH (Sensing Window)

- Sets a single ON condition
- All other conditions (lighter or darker) result in OFF output
- Sensing window size (sensitivity) is adjustable using “+” and “-” buttons (Manual Adjust)

Single-Point TEACH is most useful when a product may not always appear in the same place, or when other signals may appear. Single-Point TEACH programs a sensing window, with the Output ON condition inside the window, and the Output OFF conditions outside the window (see Figure 4). Output ON and OFF conditions can be reversed by changing Light/Dark Operate status in SETUP mode.

Single-Point TEACH programming may be accomplished only using Static TEACH. The sensor learns a single sensing condition, and adds switching thresholds above and below the taught condition to create a sensing window.

### Single-Point TEACH and Manual Adjust

Using Manual Adjust with Single-Point TEACH expands or contracts the size of the window. The lighted LEDs on the light bar separate to a greater or lesser extent to exhibit the relative sensing window size.

	Push Button	Remote Line	Display Shows
<b>Access TEACH Mode</b>	<ul style="list-style-type: none"> <li>• Press and Hold</li> </ul>	<ul style="list-style-type: none"> <li>• Present Output ON condition</li> <li>• Single-pulse remote line</li> </ul>	Power LED: OFF Output LED: ON (Push Button) Output LED: OFF (Remote) Bargraph: #5 & 6 flashing 
<b>Learn Set Point (Output ON) Condition</b>	<ul style="list-style-type: none"> <li>• Present Output ON condition</li> <li>• Double-click</li> </ul>	<ul style="list-style-type: none"> <li>• Double-pulse remote line</li> </ul>	<b>Teach Accepted</b> Power LED: ON Bargraph: #3 & 6 flash to show Single-Point TEACH Sensor returns to RUN mode with new settings 
			<b>Teach Unacceptable</b> Power LED: OFF Bargraph: #1, 3, 6, 8 flash to show fail, then #5 & 6 begin to flash Sensor waits for valid Teach condition 

# QS30 Series Diffuse-Mode Laser Sensor

## SETUP Mode

SETUP mode is used to change sensor output response for:

- Light or Dark operate
- 30-millisecond pulse stretcher (OFF delay), if required.

The status LEDs, active only during SETUP mode, indicate the output response configuration when the sensor will be in RUN mode. Four combinations are possible:

Light Operate, No Delay  
Dark Operate, No Delay  
Dark Operate, 30 ms Delay  
Light Operate, 30 ms Delay

### To access SETUP mode and change the output response settings:

- 1) Press and hold BOTH push buttons (or double-pulse Remote line) until the green LED indicator turns OFF.
- 2) Click EITHER push button (or pulse Remote line) to toggle through the four possible setting combinations.
- 3) Press and hold both push buttons (or hold Remote line) until the green LED indicator turns ON, indicating return to RUN mode.

- NOTES:
- If SETUP mode programming is interrupted and remains inactive for 60 seconds, the sensor returns to RUN mode with the most recent settings (i.e., exits and saves current selection).
  - SETUP mode operates in the “background”, while the outputs are active.

## Manual Adjust

Use during RUN mode, accomplished via push buttons only.

### Two-Point TEACH (Static or Dynamic):

- Fine-tunes sensing threshold set-point value
- Press “+” to increase; press “-” to decrease

### Single-Point TEACH:

- Adjusts sensing window size (tolerance) for the single-point target condition
- Press “+” to increase; press “-” to decrease

The lighted bargraph LEDs move to reflect the increase or decrease.

## Push Button Disable

In addition to its programming function, Remote Programming may be used to disable the push buttons for security. Disabling the push buttons prevents undesired tampering with the programming settings. Connect the gray wire of the sensor as described on page 4, and four-pulse to either enable or disable the push buttons:

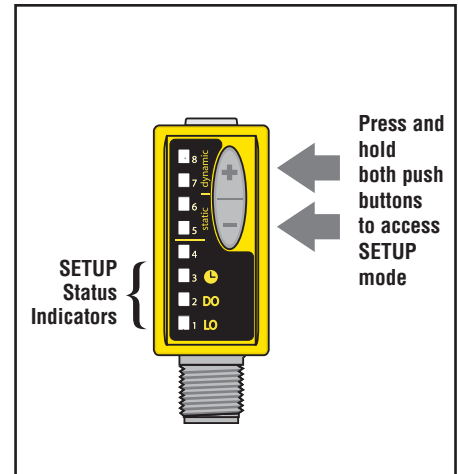

Figure 5. SETUP mode



# QS30 Series Diffuse-Mode Laser Sensor

## Dimensions

### Cabled Models

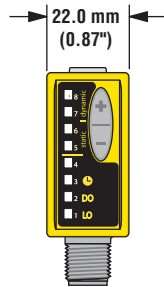
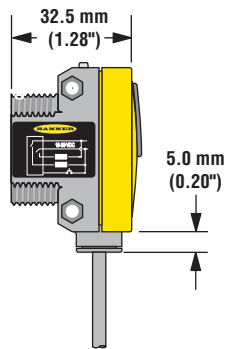

### QD Models

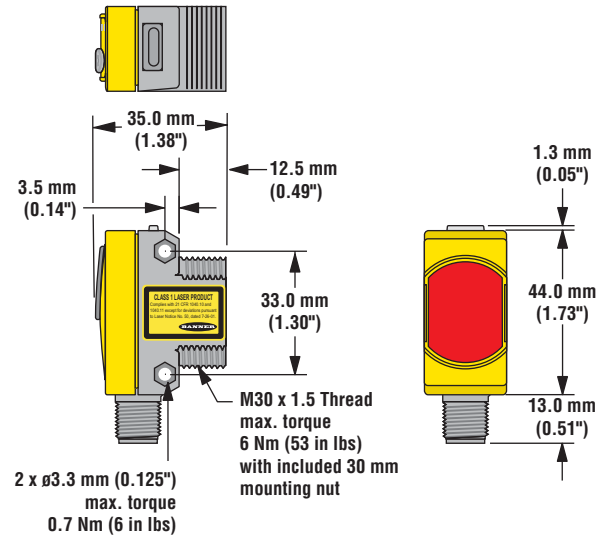

## Hookups

### Cabled Models

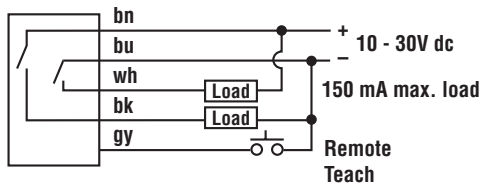

### QD Models

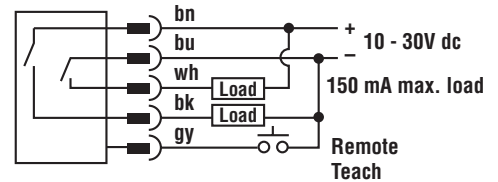

# QS30 Series Diffuse-Mode Laser Sensor

Quick-Disconnect Cables				
Style	Model	Length	Dimensions	Pin-out
5-pin Euro-style straight	<b>MQDC1-506</b> <b>MQDC1-515</b> <b>MQDC1-530</b>	2 m (6.5') 5 m (15') 9 m (30')		
5-pin Euro-style right-angle	<b>MQDC1-506RA</b> <b>MQDC1-515RA</b> <b>MQDC1-530RA</b>	2 m (6.5') 5 m (15') 9 m (30')		

# QS30 Series Diffuse-Mode Laser Sensor

## Brackets

<p><b>SMBQS30L</b></p>	<ul style="list-style-type: none"> <li>• 14-gauge, stainless steel right-angle bracket for cable models</li> <li>• Clearance for M4 (#8) hardware</li> <li>• <math>\pm 12^\circ</math> tilt adjustment</li> </ul>	<p><b>SMBQS30LT</b></p>	<ul style="list-style-type: none"> <li>• 14-gauge stainless steel for QD models with right-angle cables</li> <li>• Tall right-angle mounting bracket</li> <li>• <math>\pm 8^\circ</math> Tilt adjustment</li> </ul>
<p><b>SMBQS30Y</b></p>	<ul style="list-style-type: none"> <li>• Heavy-duty die-cast bracket</li> <li>• M18 vertical mounting option</li> <li>• <math>\pm 8^\circ</math> tilt adjustment with cabled units</li> <li>• Nuts and lockwasher included</li> </ul>	<p><b>Other Compatible Mounting Brackets:</b></p> <ul style="list-style-type: none"> <li>• SMB30MM</li> <li>• SMB30SC</li> <li>• SMB30A</li> </ul>	
	<p><b>Other Compatible Mounting Brackets:</b></p> <ul style="list-style-type: none"> <li>• SMB30MM</li> <li>• SMB30SC</li> <li>• SMB30A</li> </ul>		

# QS30 Series Diffuse-Mode Laser Sensor

---



**WARRANTY:** Banner Engineering Corp. warrants its products to be free from defects for one year. Banner Engineering Corp. will repair or replace, free of charge, any product of its manufacture found to be defective at the time it is returned to the factory during the warranty period. This warranty does not cover damage or liability for the improper application of Banner products. This warranty is in lieu of any other warranty either expressed or implied.