

Small Nonmetallic Raceway Systems For Communications and Power Applications

Eclipse™ PN03, PN05, and PN10 Series Raceways are single compartment raceways designed for communication or power applications. They are ideal for use in classrooms, offices, and hotel applications, or anywhere a small, low profile raceway is needed.

Eclipse PN03, PN05, and PN10 Series Raceways are specifically designed for the workstation. They accept Ortronics® Series II and TracJack® modules, Pass & Seymour® Activate Series inserts, and Wiremold Open System communication modules.



Eclipse PN05 Series Raceway shown in an office installation.

FEATURES & BENEFITS

- **Available in three sizes.** PN03, PN05, and PN10 provide flexibility for meeting various capacity requirements. Perfect for most small drops and horizontal runs to work stations.
- **Durable, flexible co-extruded hinge construction (on latching profiles).** Allows for repeated openings and closings while maintaining product integrity and aesthetics.
- **Snap-on latching cover.** Provides security with access to wiring for changes or additions.
- **Three standard colors.** Stock colors are ivory, white, and fog white (matches with Ortronics® White). Consult factory for custom colors. Paintable using latex paint.
- **1" (25mm) bend radius compliant fittings.** Full capacity, aesthetically pleasing fittings provide 1" (25mm) bend radius.
- **Adhesive backing for low-voltage (under 50V) applications.** Allows base to be pressed onto surface, speeds installation.
- **Lightweight and easy to handle.** Saves time and labor costs. Standard 8' (2.44m) lengths can be installed by one person.
- **Designed for use with Ortronics® TracJack and Series II modules.** A wide variety of media interface inserts to ensure a reliable, cost-effective activation for the most demanding communication system designs.
- **PSB3 Device Box accommodates wireless.** Designed for use with Ortronics® Wi-Jack™ Wireless Access Points.
- **Accommodates communication or power wiring.** Can be used for communications, computer lines, surveillance systems, fire alarms, outlets, and more.
- **Easy to align.** All base and fittings have unique alignment guides built in to help avoid unsightly gaps and uneven installations. All fitting covers have 1/4" (6.4mm) overlap to hide uneven cuts of raceway.
- **Ceiling fitting slips over suspended ceiling grid.** Saves time and labor by eliminating need to cut metal ceiling grid.
- **FT-4 Flame Spread Rating.** Eclipse™ Raceway meets the definition of "resistant to the spread of fire" in Article 760 of the NEC and is therefore suitable for use with Type NPLF non-power-limited fire alarm cable and Type FPL power-limited fire alarm cable.
- **Datacom connectivity options.** Accepts industry standard and proprietary devices from a wide range of manufacturers to provide a seamless and aesthetically pleasing communications interface at the point of use.
- **Ratings:** 600VAC, FT-4 Rated for Canada
- **UL and cUL Listed component raceways.** File E90378 Guide RJTX, Fittings: File E90377 Guide RJYT. Meets Article 386 of NEC and meets Section 12-1600 of CEC.

Eclipse Raceways shown in typical installations.



Eclipse Series PN03, PN05, and PN10 System Layout

- A – PN03L08, PN03L10, PN05L08, PN05L10, PN10L08, PN10L10
- B – PN03F06, PN05F06, PN10F06
- C – PN03F11, PN05F11, PN10F11
- D – PN03F15, PN05F15, PN10F15
- E – PN03F17, PN05F17, PN10F17
- F – PN03F18, PN05F18, PN10F17
- G – PN03F19, PN05F19, PN10F19
- H – PN05F86, PN10F86
- I – PN10F21
- J – PSB2
- K – PSB1
- L – PSB3
- M – PDB1CM, PDB1S2, PDB2TJ, PDB2CM, PDB2S2, PDB4TJ, PBB2S2, PBB4TJ
- N – PN153R

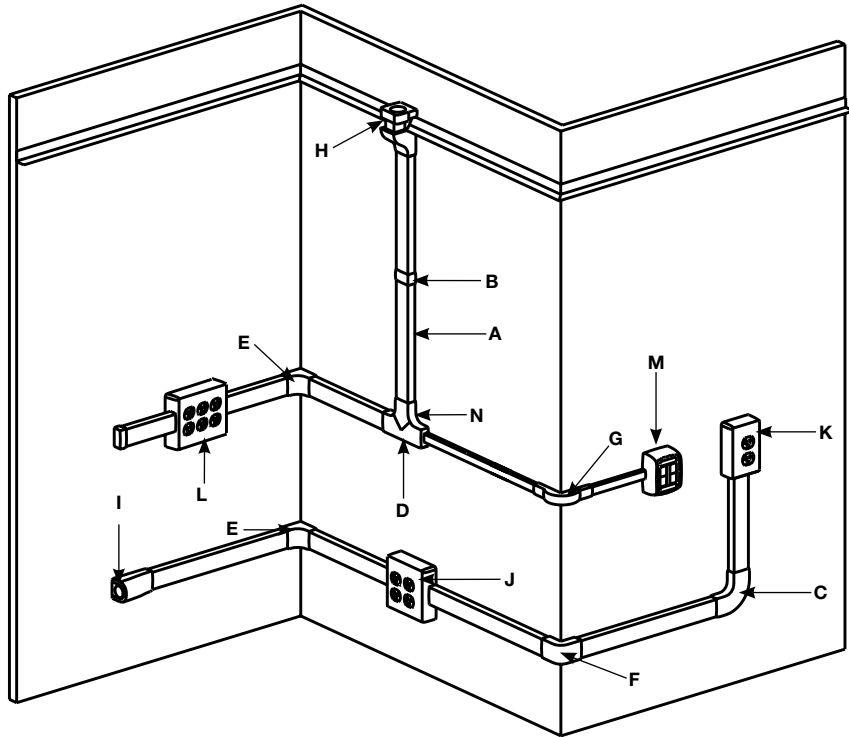

Eclipse Series Raceway Wire Fill Capacities for Communications

	CABLE/WIRE SIZE	O.D.		PN03L		PN05L		PN10L	
		Inches	(mm)	20%*	40%**	20%*	40%**	20%*	40%**
UNSHIELDED TWISTED PAIR	4-pair, 24 AWG Cat 3	0.190	(4.8)	1	3	3	6	6	13
	4-pair, 24 AWG Cat. 5e	0.210	(5.3)	1	2	2	5	5	11
	4-pair, 24 AWG Cat. 6	0.250	(6.3)	0	1	1	3	4	8
	4-pair, 24 AWG Cat. 6a	0.351	(9.0)	0	0	0	1	2	4
TELEPHONE	2-pair, 24 AWG	0.140	(3.6)	2	5	5	11	12	25
	3-pair, 24 AWG	0.150	(3.8)	2	4	4	9	11	22
	4-pair, 24 AWG	0.190	(4.8)	1	3	3	6	6	13
	25-pair, 24 AWG	0.410	(10.4)	0	0	0	1	1	3
COAXIAL	RG58/U	0.195	(5.0)	1	2	2	5	6	13
	RG59/U	0.242	(6.1)	0	1	1	3	4	8
	RG62/U	0.242	(6.1)	0	1	1	3	4	8
	RG6/U	0.270	(6.9)	0	1	1	3	3	6
TWINAXIAL	100 Ohm	0.330	(8.4)	0	1	1	2	2	4
SHIELDED TWISTED PAIR	TYPE 1	0.390	(9.9)	0	0	0	1	1	3
	TYPE 2	0.465	(11.8)	0	0	0	1	1	2
	TYPE 3	0.245	(6.2)	0	1	1	3	4	8
FIBER	Mini Zip Cord	0.079 x 0.157	(2 x 4)	3	7	7	14	15	31
	Zip Cord	0.118 x 0.236	(3 x 6)	1	3	3	6	7	14
	Round 4 Strand Fiber	0.187	(4.8)	1	3	3	6	7	14
	Round 6 Strand Fiber	0.256	(6.5)	0	1	1	3	3	7

* 20% cable fill is calculated to approximate reduction in cable capacity due to connectors mounted within raceway and fittings that may restrict cross sectional area.

** 40% cable fill is the maximum designed cable fill based on a proposed revision to TIA/EIA 569-A.

Eclipse Series Raceway Wire Fill Capacities for Power

WIRE SIZE THHN/THWN	O.D.		NUMBER OF CONDUCTORS		
	Inches	(mm)	PN03	PN05	PN10
14 AWG	0.111	(2.8)	8	16	22
12 AWG	0.130	(3.3)	7	14	20
10 AWG	0.164	(4.2)	0	0	19

Eclipse Series PN03, PN05, and PN10 Raceway Profiles

Catalog No./Item	Description/Specifications
PN03L08* PN03L10** PN05L08* PN05L10** PN10L08* PN10L10**	One-Piece Raceway – Co-extruded hinged, one-piece raceway.

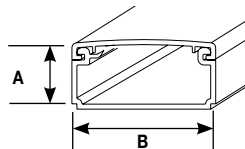

Cat No.	A	B
PN03L08	1/2" (12.7mm)	13/16" (20.6mm)
PN03L10	1/2" (12.7mm)	13/16" (20.6mm)
PN05L08	5/8" (15.9mm)	1 1/8" (29mm)
PN05L10	5/8" (15.9mm)	1 1/8" (29mm)
PN10L08	13/16" (20.6mm)	1 11/16" (43mm)
PN10L10	13/16" (20.6mm)	1 11/16" (43mm)

* Add **-“WH”** suffix for White finish, **-“FW”** for Fog White finish, or **-“V”** for Ivory finish.
 ** 10' (3.05m) lengths available in Fog White finish only.



Download this product's PEP ecopassport[®] environmental product declaration at www.legrand.us/resources-and-downloads. This declaration conforms with ISO 14025 and 14040 and is in alignment with EN 15804.

Eclipse Series PN03, PN05, and PN10 Surface Nonmetallic Raceway Fittings

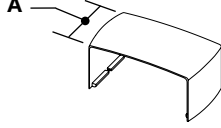
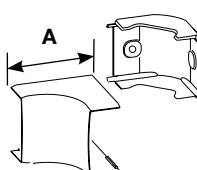
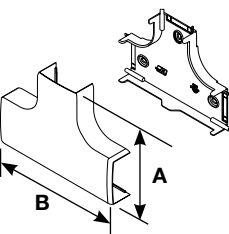
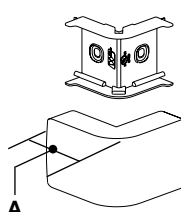
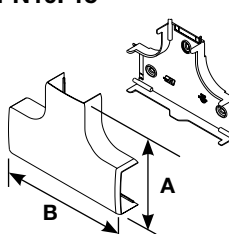
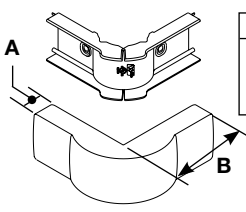
Catalog No./Item	Description/Specifications	Catalog No./Item	Description/Specifications												
PN03F06 PN05F06 PN10F06	Cover Clip – Covers seam where two lengths of PN03, PN05, or PN10 Series Raceway meet.		<table border="1" style="border-collapse: collapse;"> <thead> <tr> <th style="width: 10%;">Cat No.</th> <th style="width: 20%;">A</th> </tr> </thead> <tbody> <tr> <td>PN03F06</td> <td>1" (25mm)</td> </tr> <tr> <td>PN05F06</td> <td>1" (25mm)</td> </tr> <tr> <td>PN10F06</td> <td>1" (25mm)</td> </tr> </tbody> </table>	Cat No.	A	PN03F06	1" (25mm)	PN05F06	1" (25mm)	PN10F06	1" (25mm)				
Cat No.	A														
PN03F06	1" (25mm)														
PN05F06	1" (25mm)														
PN10F06	1" (25mm)														
PN03F11 PN05F11 PN10F11	90° Flat Elbow – Makes right angle turns on same surface. 1" (25mm) bend radius.		<table border="1" style="border-collapse: collapse;"> <thead> <tr> <th style="width: 10%;">Cat No.</th> <th style="width: 20%;">A</th> </tr> </thead> <tbody> <tr> <td>PN03F11</td> <td>2 11/16" (68mm)</td> </tr> <tr> <td>PN05F11</td> <td>2 15/16" (75mm)</td> </tr> <tr> <td>PN10F11</td> <td>3 11/16" (94mm)</td> </tr> </tbody> </table>	Cat No.	A	PN03F11	2 11/16" (68mm)	PN05F11	2 15/16" (75mm)	PN10F11	3 11/16" (94mm)				
Cat No.	A														
PN03F11	2 11/16" (68mm)														
PN05F11	2 15/16" (75mm)														
PN10F11	3 11/16" (94mm)														
PN03F15 PN05F15 PN10F15	Tee – Branches raceway at right angles on the same surface. 1" (25mm) bend radius.		<table border="1" style="border-collapse: collapse;"> <thead> <tr> <th style="width: 10%;">Cat No.</th> <th style="width: 20%;">A</th> <th style="width: 20%;">B</th> </tr> </thead> <tbody> <tr> <td>PN03F15</td> <td>2 11/16" (68mm)</td> <td>4 5/16" (110mm)</td> </tr> <tr> <td>PN05F15</td> <td>2 15/16" (75mm)</td> <td>4 3/4" (121mm)</td> </tr> <tr> <td>PN10F15</td> <td>3 11/16" (94mm)</td> <td>5 5/16" (135mm)</td> </tr> </tbody> </table>	Cat No.	A	B	PN03F15	2 11/16" (68mm)	4 5/16" (110mm)	PN05F15	2 15/16" (75mm)	4 3/4" (121mm)	PN10F15	3 11/16" (94mm)	5 5/16" (135mm)
Cat No.	A	B													
PN03F15	2 11/16" (68mm)	4 5/16" (110mm)													
PN05F15	2 15/16" (75mm)	4 3/4" (121mm)													
PN10F15	3 11/16" (94mm)	5 5/16" (135mm)													
PN03F17 PN05F17 PN10F17	Internal Elbow – Makes right angle turns around internal corners. 1" (25mm) bend radius.		<table border="1" style="border-collapse: collapse;"> <thead> <tr> <th style="width: 10%;">Cat No.</th> <th style="width: 20%;">A</th> </tr> </thead> <tbody> <tr> <td>PN03F17</td> <td>2 1/8" (54mm)</td> </tr> <tr> <td>PN05F17</td> <td>2 1/8" (54mm)</td> </tr> <tr> <td>PN10F17</td> <td>2 1/8" (54mm)</td> </tr> </tbody> </table>	Cat No.	A	PN03F17	2 1/8" (54mm)	PN05F17	2 1/8" (54mm)	PN10F17	2 1/8" (54mm)				
Cat No.	A														
PN03F17	2 1/8" (54mm)														
PN05F17	2 1/8" (54mm)														
PN10F17	2 1/8" (54mm)														
PN03F18 PN05F18 PN10F18	External Elbow – Makes right angle turns around external corners.		<table border="1" style="border-collapse: collapse;"> <thead> <tr> <th style="width: 10%;">Cat No.</th> <th style="width: 20%;">A</th> </tr> </thead> <tbody> <tr> <td>PN03F18</td> <td>1 5/8" (41mm)</td> </tr> <tr> <td>PN05F18</td> <td>1 5/8" (41mm)</td> </tr> <tr> <td>PN10F18</td> <td>1 5/8" (41mm)</td> </tr> </tbody> </table>	Cat No.	A	PN03F18	1 5/8" (41mm)	PN05F18	1 5/8" (41mm)	PN10F18	1 5/8" (41mm)				
Cat No.	A														
PN03F18	1 5/8" (41mm)														
PN05F18	1 5/8" (41mm)														
PN10F18	1 5/8" (41mm)														
PN03F19 PN05F19 PN10F19	90° External Elbow – Makes right angle turns around external corners. 1" (25mm) bend radius.		<table border="1" style="border-collapse: collapse;"> <thead> <tr> <th style="width: 10%;">Cat No.</th> <th style="width: 20%;">A</th> <th style="width: 20%;">B</th> </tr> </thead> <tbody> <tr> <td>PN03F19</td> <td>15/16" (23.8mm)</td> <td>3 1/8" (79mm)</td> </tr> <tr> <td>PN05F19</td> <td>1 3/16" (30mm)</td> <td>3 1/8" (79mm)</td> </tr> <tr> <td>PN10F19</td> <td>1 3/16" (30mm)</td> <td>3 3/8" (116mm)</td> </tr> </tbody> </table>	Cat No.	A	B	PN03F19	15/16" (23.8mm)	3 1/8" (79mm)	PN05F19	1 3/16" (30mm)	3 1/8" (79mm)	PN10F19	1 3/16" (30mm)	3 3/8" (116mm)
Cat No.	A	B													
PN03F19	15/16" (23.8mm)	3 1/8" (79mm)													
PN05F19	1 3/16" (30mm)	3 1/8" (79mm)													
PN10F19	1 3/16" (30mm)	3 3/8" (116mm)													

NOTE: Add **-“WH”** suffix for White finish, **-“FW”** for Fog White finish, or **-“V”** for Ivory finish.

Eclipse Series PN03, PN05, and PN10 Surface Nonmetallic Raceway Fittings

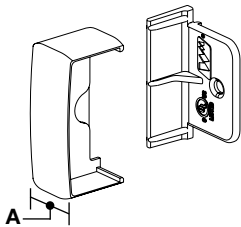
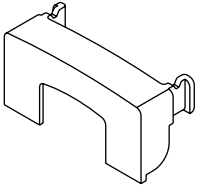
Catalog No./Item	Description/Specifications								
PN03F20 PN05F20 PN10F20	Blank End Fitting – Closes off open end of raceway. <table border="1" style="margin-top: 10px; width: 100%; border-collapse: collapse;"> <thead> <tr> <th style="width: 15%;">Cat No.</th> <th style="width: 15%;">A</th> </tr> </thead> <tbody> <tr> <td>PN03F20</td> <td>1 1/16" (17.5mm)</td> </tr> <tr> <td>PN05F20</td> <td>1 1/16" (17.5mm)</td> </tr> <tr> <td>PN10F20</td> <td>1 1/16" (17.5mm)</td> </tr> </tbody> </table>	Cat No.	A	PN03F20	1 1/16" (17.5mm)	PN05F20	1 1/16" (17.5mm)	PN10F20	1 1/16" (17.5mm)
Cat No.	A								
PN03F20	1 1/16" (17.5mm)								
PN05F20	1 1/16" (17.5mm)								
PN10F20	1 1/16" (17.5mm)								
									
PN153R	Reducer Adapter – Connects PN03 or PN05 Series Raceway to PN10 Series Raceway. Use with a PN10F15 Tee Fitting. <div style="text-align: center; margin-top: 10px;">  </div>								

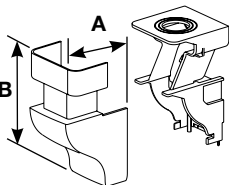
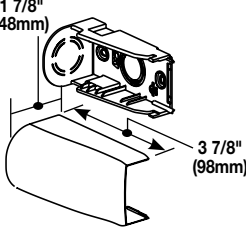
Catalog No./Item	Description/Specifications									
PN05F86 PN10F86	Drop Ceiling Connector – Connects cables from ceiling into PN03, PN05 or PN10 Series Raceway. Includes PN153R Reducer Adapter for use with PN03 Series Raceway. <table border="1" style="margin-top: 10px; width: 100%; border-collapse: collapse;"> <thead> <tr> <th style="width: 15%;">Cat No.</th> <th style="width: 15%;">A</th> <th style="width: 15%;">B</th> </tr> </thead> <tbody> <tr> <td>PN05F86</td> <td>1 15/16" (49mm)</td> <td>4 3/8" (111mm)</td> </tr> <tr> <td>PN10F86</td> <td>2 1/2" (64mm)</td> <td>4 3/8" (111mm)</td> </tr> </tbody> </table>	Cat No.	A	B	PN05F86	1 15/16" (49mm)	4 3/8" (111mm)	PN10F86	2 1/2" (64mm)	4 3/8" (111mm)
Cat No.	A	B								
PN05F86	1 15/16" (49mm)	4 3/8" (111mm)								
PN10F86	2 1/2" (64mm)	4 3/8" (111mm)								
										
PN10F21	Entrance End fitting – Connects 1/2" and 3/4" trade size conduit or armored cable with PN03, PN05 and PN10 Series Raceway. Includes PN153R Reducer Adapter for use with PN03 and PN05 Series Raceway. <div style="text-align: center; margin-top: 10px;">  </div>									

NOTE: Add -"WH" suffix for White finish, -"FW" for Fog White finish, or -"V" for Ivory finish.

Eclipse Series PN03, PN05, and PN10 Series Device Boxes

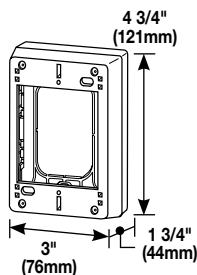
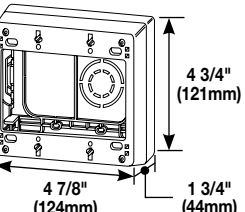
Catalog No./Item	Description/Specifications
PSB1	One-Gang Power Box – Accepts all standard single-gang NEMA face-plates. Concentric twist-outs on all four sides for PN03, PN05, and PN10 Series Raceway. <div style="text-align: center; margin-top: 10px;">  </div>
PSB2	Two-Gang Device Box – Accepts all standard two-gang NEMA faceplates. Concentric twist-outs on all four sides for PN03, PN05, and PN10 Series Raceway. <div style="text-align: center; margin-top: 10px;">  </div>

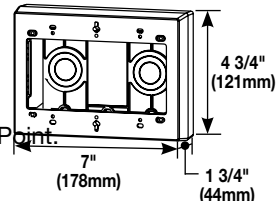
Catalog No./Item	Description/Specifications
PSB3	Three-Gang Device Box – Accepts all standard three-gang NEMA faceplates. Concentric twist-outs on all four sides for PN03, PN05, and PN10 Series Raceway. Designed for use with Ortronics® Wi-Jack™ Wireless Access <div style="text-align: center; margin-top: 10px;">  </div>

NOTE: Add -"WH" suffix for White finish, -"FW" for Fog White finish, or -"V" for Ivory finish.

Eclipse Series PN03, PN05, and PN10 Communication Boxes

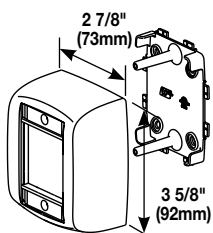
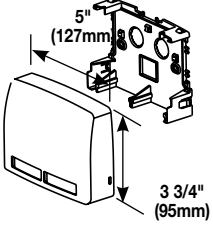
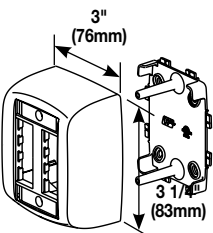
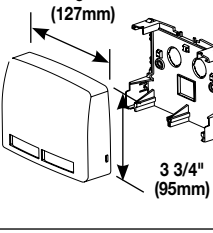
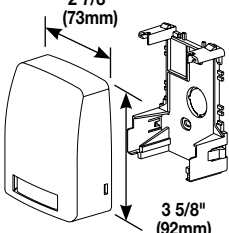
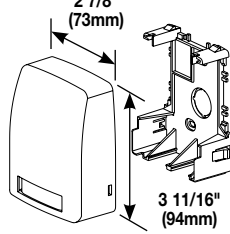
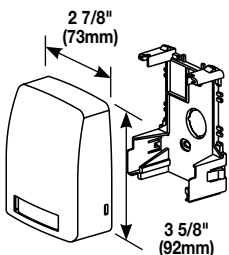
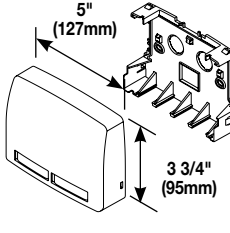
Catalog No./Item	Description/Specifications	Catalog No./Item	Description/Specifications
PBB2S2 	Bezel Box – Surface mount box for use with Eclipse Series Raceway or standalone application. Accepts two front-loaded outward facing devices including Ortronics® Series II devices	PDB2CM 	Large Data Box – Surface mount box for use with Eclipse Series Raceway or standalone application. Accepts two front-loaded downward facing devices including Pass & Seymour® Activate Series inserts and Wiremold Open System communication modules.
PBB4TJ 	Bezel Box – Surface mount box for use with Eclipse Series Raceway or standalone application. Accepts four front-loaded outward facing devices including Ortronics® TracJack devices.	PDB2S2 	Large Data Box – Surface mount box for use with Eclipse Series Raceway or standalone application. Accepts two front-loaded downward facing devices including Ortronics® Series II devices.
PDB1S2 	Small Data Box – Surface mount box for use with Eclipse Series Raceway or standalone application. Accepts one front-loaded downward facing device including Ortronics® Series II devices.	PDB2TJ 	Small Data Box – Surface mount box for use with Eclipse Series Raceway or standalone application. Accepts two front-loaded downward facing devices including Ortronics® TracJack devices.
PDB1CM 	Small Data Box – Surface mount box for use with Eclipse Series Raceway or standalone application. Accepts one front-loaded downward facing device including Pass & Seymour® Activate Series inserts and Wiremold Open System communication modules.	PDB4TJ 	Large Data Box – Surface mount box for use with Eclipse Series Raceway or standalone application. Accepts four front-loaded downward facing devices including Ortronics® TracJack devices.

NOTE: Add -“WH” suffix for White finish, -“FW” for Fog White finish, or -“V” for Ivory finish.

NOTES

NOTE: All brand and product names referenced in this document are registered trademarks or trademarks of their respective holders.



NOTE: The paper used to print this document is an environmentally responsible paper with 10% post consumer waste, with FSC and SFI Chain of Custody certifications, Lacey Act compliant. 100% of the electricity used to manufacture Flo sheets is generated with Green-e certified renewable energy.



Electrical Wiring Systems

60 Woodlawn Street
West Hartford, CT 06110
Phone: 1.877.BY.LEGRAND (295-3472)
www.legrand.us

570 Applewood Crescent
Vaughan, Ontario L4K 4B4
Phone: 905.738.9195
www.legrand.ca



Small Nonmetallic Raceway Systems For Communications and Power Applications

Eclipse™ PN03, PN05, and PN10 Series Raceways are single compartment raceways designed for communication or power applications. They are ideal for use in classrooms, offices, and hotel applications, or anywhere a small, low profile raceway is needed.

Eclipse PN03, PN05, and PN10 Series Raceways are specifically designed for the workstation. They accept Ortronics® Series II and TracJack® modules, Pass & Seymour® Activate Series inserts, and Wiremold Open System communication modules.



Eclipse PN05 Series Raceway shown in an office installation.

FEATURES & BENEFITS

- **Available in three sizes.** PN03, PN05, and PN10 provide flexibility for meeting various capacity requirements. Perfect for most small drops and horizontal runs to work stations.
- **Durable, flexible co-extruded hinge construction (on latching profiles).** Allows for repeated openings and closings while maintaining product integrity and aesthetics.
- **Snap-on latching cover.** Provides security with access to wiring for changes or additions.
- **Three standard colors.** Stock colors are ivory, white, and fog white (matches with Ortronics® White). Consult factory for custom colors. Paintable using latex paint.
- **1" (25mm) bend radius compliant fittings.** Full capacity, aesthetically pleasing fittings provide 1" (25mm) bend radius.
- **Adhesive backing for low-voltage (under 50V) applications.** Allows base to be pressed onto surface, speeds installation.
- **Lightweight and easy to handle.** Saves time and labor costs. Standard 8' (2.44m) lengths can be installed by one person.
- **Designed for use with Ortronics® TracJack and Series II modules.** A wide variety of media interface inserts to ensure a reliable, cost-effective activation for the most demanding communication system designs.
- **PSB3 Device Box accommodates wireless.** Designed for use with Ortronics® Wi-Jack™ Wireless Access Points.
- **Accommodates communication or power wiring.** Can be used for communications, computer lines, surveillance systems, fire alarms, outlets, and more.
- **Easy to align.** All base and fittings have unique alignment guides built in to help avoid unsightly gaps and uneven installations. All fitting covers have 1/4" (6.4mm) overlap to hide uneven cuts of raceway.
- **Ceiling fitting slips over suspended ceiling grid.** Saves time and labor by eliminating need to cut metal ceiling grid.
- **FT-4 Flame Spread Rating.** Eclipse™ Raceway meets the definition of "resistant to the spread of fire" in Article 760 of the NEC and is therefore suitable for use with Type NPLF non-power-limited fire alarm cable and Type FPL power-limited fire alarm cable.
- **Datacom connectivity options.** Accepts industry standard and proprietary devices from a wide range of manufacturers to provide a seamless and aesthetically pleasing communications interface at the point of use.
- **Ratings:** 600VAC, FT-4 Rated for Canada
- **UL and cUL Listed component raceways.** File E90378 Guide RJTX, Fittings: File E90377 Guide RJYT. Meets Article 386 of NEC and meets Section 12-1600 of CEC.

Eclipse Raceways shown in typical installations.



Eclipse Series PN03, PN05, and PN10 System Layout

- A – PN03L08, PN03L10, PN05L08, PN05L10, PN10L08, PN10L10
- B – PN03F06, PN05F06, PN10F06
- C – PN03F11, PN05F11, PN10F11
- D – PN03F15, PN05F15, PN10F15
- E – PN03F17, PN05F17, PN10F17
- F – PN03F18, PN05F18, PN10F18
- G – PN03F19, PN05F19, PN10F19
- H – PN05F86, PN10F86
- I – PN10F21
- J – PSB2
- K – PSB1
- L – PSB3
- M – PDB1CM, PDB1S2, PDB2TJ, PDB2CM, PDB2S2, PDB4TJ, PBB2S2, PBB4TJ
- N – PN153R

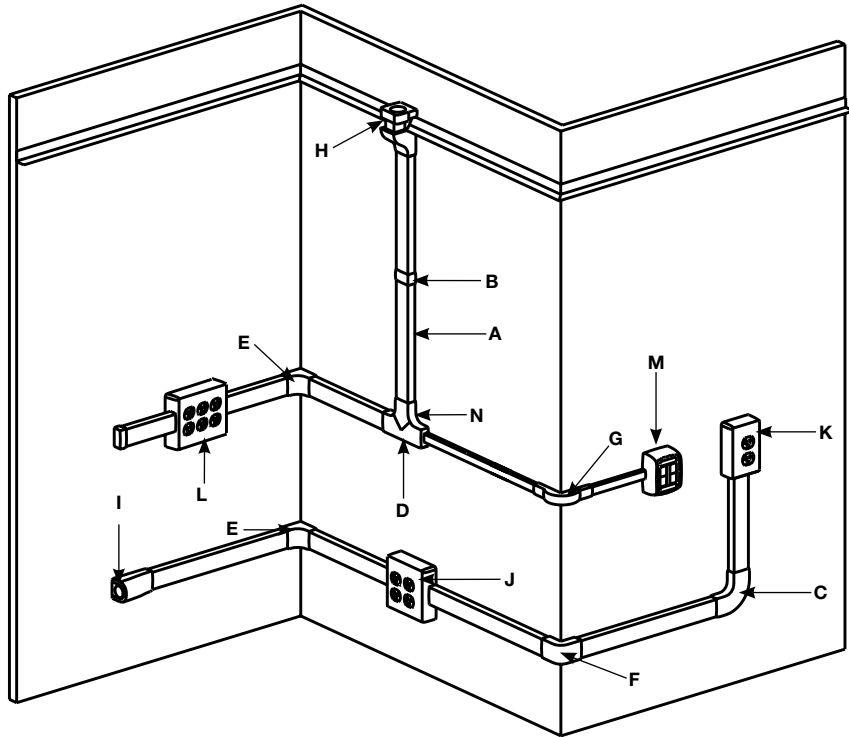

Eclipse Series Raceway Wire Fill Capacities for Communications

	CABLE/WIRE SIZE	O.D.		PN03L		PN05L		PN10L	
		Inches	(mm)	20%*	40%**	20%*	40%**	20%*	40%**
UNSHIELDED TWISTED PAIR	4-pair, 24 AWG Cat 3	0.190	(4.8)	1	3	3	6	6	13
	4-pair, 24 AWG Cat. 5e	0.210	(5.3)	1	2	2	5	5	11
	4-pair, 24 AWG Cat. 6	0.250	(6.3)	0	1	1	3	4	8
	4-pair, 24 AWG Cat. 6a	0.351	(9.0)	0	0	0	1	2	4
TELEPHONE	2-pair, 24 AWG	0.140	(3.6)	2	5	5	11	12	25
	3-pair, 24 AWG	0.150	(3.8)	2	4	4	9	11	22
	4-pair, 24 AWG	0.190	(4.8)	1	3	3	6	6	13
	25-pair, 24 AWG	0.410	(10.4)	0	0	0	1	1	3
COAXIAL	RG58/U	0.195	(5.0)	1	2	2	5	6	13
	RG59/U	0.242	(6.1)	0	1	1	3	4	8
	RG62/U	0.242	(6.1)	0	1	1	3	4	8
	RG6/U	0.270	(6.9)	0	1	1	3	3	6
TWINAXIAL	100 Ohm	0.330	(8.4)	0	1	1	2	2	4
SHIELDED TWISTED PAIR	TYPE 1	0.390	(9.9)	0	0	0	1	1	3
	TYPE 2	0.465	(11.8)	0	0	0	1	1	2
	TYPE 3	0.245	(6.2)	0	1	1	3	4	8
FIBER	Mini Zip Cord	0.079 x 0.157	(2 x 4)	3	7	7	14	15	31
	Zip Cord	0.118 x 0.236	(3 x 6)	1	3	3	6	7	14
	Round 4 Strand Fiber	0.187	(4.8)	1	3	3	6	7	14
	Round 6 Strand Fiber	0.256	(6.5)	0	1	1	3	3	7

* 20% cable fill is calculated to approximate reduction in cable capacity due to connectors mounted within raceway and fittings that may restrict cross sectional area.

** 40% cable fill is the maximum designed cable fill based on a proposed revision to TIA/EIA 569-A.

Eclipse Series Raceway Wire Fill Capacities for Power

WIRE SIZE THHN/THWN	O.D.		NUMBER OF CONDUCTORS		
	Inches	(mm)	PN03	PN05	PN10
14 AWG	0.111	(2.8)	8	16	22
12 AWG	0.130	(3.3)	7	14	20
10 AWG	0.164	(4.2)	0	0	19

Eclipse Series PN03, PN05, and PN10 Raceway Profiles

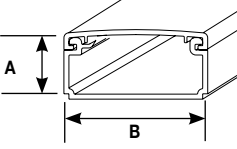
Catalog No./Item	Description/Specifications																					
PN03L08* PN03L10** PN05L08* PN05L10** PN10L08* PN10L10**	One-Piece Raceway – Co-extruded hinged, one-piece raceway.																					
	<table border="1" style="margin: auto;"> <thead> <tr> <th>Cat No.</th> <th>A</th> <th>B</th> </tr> </thead> <tbody> <tr> <td>PN03L08</td> <td>1/2" (12.7mm)</td> <td>13/16" (20.6mm)</td> </tr> <tr> <td>PN03L10</td> <td>1/2" (12.7mm)</td> <td>13/16" (20.6mm)</td> </tr> <tr> <td>PN05L08</td> <td>5/8" (15.9mm)</td> <td>1 1/8" (29mm)</td> </tr> <tr> <td>PN05L10</td> <td>5/8" (15.9mm)</td> <td>1 1/8" (29mm)</td> </tr> <tr> <td>PN10L08</td> <td>13/16" (20.6mm)</td> <td>1 11/16" (43mm)</td> </tr> <tr> <td>PN10L10</td> <td>13/16" (20.6mm)</td> <td>1 11/16" (43mm)</td> </tr> </tbody> </table>	Cat No.	A	B	PN03L08	1/2" (12.7mm)	13/16" (20.6mm)	PN03L10	1/2" (12.7mm)	13/16" (20.6mm)	PN05L08	5/8" (15.9mm)	1 1/8" (29mm)	PN05L10	5/8" (15.9mm)	1 1/8" (29mm)	PN10L08	13/16" (20.6mm)	1 11/16" (43mm)	PN10L10	13/16" (20.6mm)	1 11/16" (43mm)
Cat No.	A	B																				
PN03L08	1/2" (12.7mm)	13/16" (20.6mm)																				
PN03L10	1/2" (12.7mm)	13/16" (20.6mm)																				
PN05L08	5/8" (15.9mm)	1 1/8" (29mm)																				
PN05L10	5/8" (15.9mm)	1 1/8" (29mm)																				
PN10L08	13/16" (20.6mm)	1 11/16" (43mm)																				
PN10L10	13/16" (20.6mm)	1 11/16" (43mm)																				

* Add **-“WH”** suffix for White finish, **-“FW”** for Fog White finish, or **-“V”** for Ivory finish.
 ** 10' (3.05m) lengths available in Fog White finish only.



Download this product's PEP ecopassport[®] environmental product declaration at www.legrand.us/resources-and-downloads. This declaration conforms with ISO 14025 and 14040 and is in alignment with EN 15804.

Eclipse Series PN03, PN05, and PN10 Surface Nonmetallic Raceway Fittings

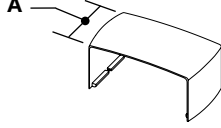
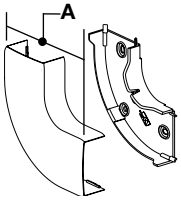
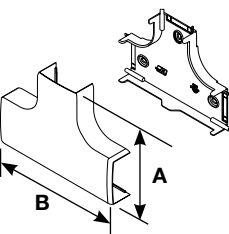
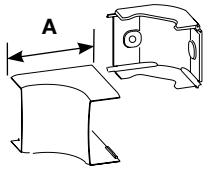
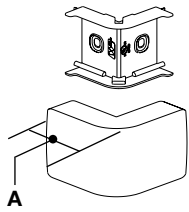
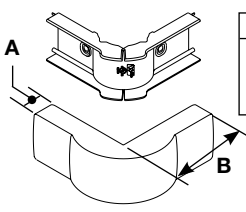
Catalog No./Item	Description/Specifications												
PN03F06 PN05F06 PN10F06	Cover Clip – Covers seam where two lengths of PN03, PN05, or PN10 Series Raceway meet.												
	<table border="1" style="margin: auto;"> <thead> <tr> <th>Cat No.</th> <th>A</th> </tr> </thead> <tbody> <tr> <td>PN03F06</td> <td>1" (25mm)</td> </tr> <tr> <td>PN05F06</td> <td>1" (25mm)</td> </tr> <tr> <td>PN10F06</td> <td>1" (25mm)</td> </tr> </tbody> </table>	Cat No.	A	PN03F06	1" (25mm)	PN05F06	1" (25mm)	PN10F06	1" (25mm)				
Cat No.	A												
PN03F06	1" (25mm)												
PN05F06	1" (25mm)												
PN10F06	1" (25mm)												
PN03F11 PN05F11 PN10F11	90° Flat Elbow – Makes right angle turns on same surface. 1" (25mm) bend radius.												
	<table border="1" style="margin: auto;"> <thead> <tr> <th>Cat No.</th> <th>A</th> </tr> </thead> <tbody> <tr> <td>PN03F11</td> <td>2 11/16" (68mm)</td> </tr> <tr> <td>PN05F11</td> <td>2 15/16" (75mm)</td> </tr> <tr> <td>PN10F11</td> <td>3 11/16" (94mm)</td> </tr> </tbody> </table>	Cat No.	A	PN03F11	2 11/16" (68mm)	PN05F11	2 15/16" (75mm)	PN10F11	3 11/16" (94mm)				
Cat No.	A												
PN03F11	2 11/16" (68mm)												
PN05F11	2 15/16" (75mm)												
PN10F11	3 11/16" (94mm)												
PN03F15 PN05F15 PN10F15	Tee – Branches raceway at right angles on the same surface. 1" (25mm) bend radius.												
	<table border="1" style="margin: auto;"> <thead> <tr> <th>Cat No.</th> <th>A</th> <th>B</th> </tr> </thead> <tbody> <tr> <td>PN03F15</td> <td>2 11/16" (68mm)</td> <td>4 5/16" (110mm)</td> </tr> <tr> <td>PN05F15</td> <td>2 15/16" (75mm)</td> <td>4 3/4" (121mm)</td> </tr> <tr> <td>PN10F15</td> <td>3 11/16" (94mm)</td> <td>5 5/16" (135mm)</td> </tr> </tbody> </table>	Cat No.	A	B	PN03F15	2 11/16" (68mm)	4 5/16" (110mm)	PN05F15	2 15/16" (75mm)	4 3/4" (121mm)	PN10F15	3 11/16" (94mm)	5 5/16" (135mm)
Cat No.	A	B											
PN03F15	2 11/16" (68mm)	4 5/16" (110mm)											
PN05F15	2 15/16" (75mm)	4 3/4" (121mm)											
PN10F15	3 11/16" (94mm)	5 5/16" (135mm)											
PN03F17 PN05F17 PN10F17	Internal Elbow – Makes right angle turns around internal corners. 1" (25mm) bend radius.												
	<table border="1" style="margin: auto;"> <thead> <tr> <th>Cat No.</th> <th>A</th> </tr> </thead> <tbody> <tr> <td>PN03F17</td> <td>2 1/8" (54mm)</td> </tr> <tr> <td>PN05F17</td> <td>2 1/8" (54mm)</td> </tr> <tr> <td>PN10F17</td> <td>2 1/8" (54mm)</td> </tr> </tbody> </table>	Cat No.	A	PN03F17	2 1/8" (54mm)	PN05F17	2 1/8" (54mm)	PN10F17	2 1/8" (54mm)				
Cat No.	A												
PN03F17	2 1/8" (54mm)												
PN05F17	2 1/8" (54mm)												
PN10F17	2 1/8" (54mm)												
PN03F18 PN05F18 PN10F18	External Elbow – Makes right angle turns around external corners.												
	<table border="1" style="margin: auto;"> <thead> <tr> <th>Cat No.</th> <th>A</th> </tr> </thead> <tbody> <tr> <td>PN03F18</td> <td>1 5/8" (41mm)</td> </tr> <tr> <td>PN05F18</td> <td>1 5/8" (41mm)</td> </tr> <tr> <td>PN10F18</td> <td>1 5/8" (41mm)</td> </tr> </tbody> </table>	Cat No.	A	PN03F18	1 5/8" (41mm)	PN05F18	1 5/8" (41mm)	PN10F18	1 5/8" (41mm)				
Cat No.	A												
PN03F18	1 5/8" (41mm)												
PN05F18	1 5/8" (41mm)												
PN10F18	1 5/8" (41mm)												
PN03F19 PN05F19 PN10F19	90° External Elbow – Makes right angle turns around external corners. 1" (25mm) bend radius.												
	<table border="1" style="margin: auto;"> <thead> <tr> <th>Cat No.</th> <th>A</th> <th>B</th> </tr> </thead> <tbody> <tr> <td>PN03F19</td> <td>15/16" (23.8mm)</td> <td>3 1/8" (79mm)</td> </tr> <tr> <td>PN05F19</td> <td>1 3/16" (30mm)</td> <td>3 1/8" (79mm)</td> </tr> <tr> <td>PN10F19</td> <td>1 3/16" (30mm)</td> <td>3 3/8" (116mm)</td> </tr> </tbody> </table>	Cat No.	A	B	PN03F19	15/16" (23.8mm)	3 1/8" (79mm)	PN05F19	1 3/16" (30mm)	3 1/8" (79mm)	PN10F19	1 3/16" (30mm)	3 3/8" (116mm)
Cat No.	A	B											
PN03F19	15/16" (23.8mm)	3 1/8" (79mm)											
PN05F19	1 3/16" (30mm)	3 1/8" (79mm)											
PN10F19	1 3/16" (30mm)	3 3/8" (116mm)											

NOTE: Add **-“WH”** suffix for White finish, **-“FW”** for Fog White finish, or **-“V”** for Ivory finish.

Eclipse Series PN03, PN05, and PN10 Surface Nonmetallic Raceway Fittings

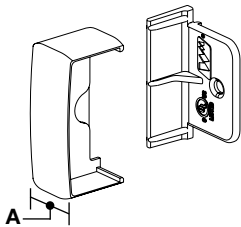
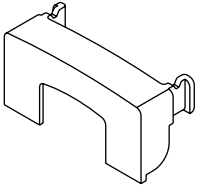
Catalog No./Item	Description/Specifications								
PN03F20 PN05F20 PN10F20	Blank End Fitting – Closes off open end of raceway. <table border="1" style="margin-top: 10px; width: 100%; border-collapse: collapse;"> <thead> <tr> <th style="width: 15%;">Cat No.</th> <th>A</th> </tr> </thead> <tbody> <tr> <td>PN03F20</td> <td>1 1/16" (17.5mm)</td> </tr> <tr> <td>PN05F20</td> <td>1 1/16" (17.5mm)</td> </tr> <tr> <td>PN10F20</td> <td>1 1/16" (17.5mm)</td> </tr> </tbody> </table>	Cat No.	A	PN03F20	1 1/16" (17.5mm)	PN05F20	1 1/16" (17.5mm)	PN10F20	1 1/16" (17.5mm)
Cat No.	A								
PN03F20	1 1/16" (17.5mm)								
PN05F20	1 1/16" (17.5mm)								
PN10F20	1 1/16" (17.5mm)								
									
PN153R	Reducer Adapter – Connects PN03 or PN05 Series Raceway to PN10 Series Raceway. Use with a PN10F15 Tee Fitting. <div style="text-align: center; margin-top: 10px;">  </div>								

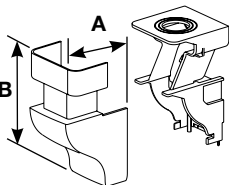
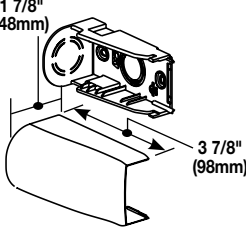
Catalog No./Item	Description/Specifications									
PN05F86 PN10F86	Drop Ceiling Connector – Connects cables from ceiling into PN03, PN05 or PN10 Series Raceway. Includes PN153R Reducer Adapter for use with PN03 Series Raceway. <table border="1" style="margin-top: 10px; width: 100%; border-collapse: collapse;"> <thead> <tr> <th style="width: 15%;">Cat No.</th> <th>A</th> <th>B</th> </tr> </thead> <tbody> <tr> <td>PN05F86</td> <td>1 15/16" (49mm)</td> <td>4 3/8" (111mm)</td> </tr> <tr> <td>PN10F86</td> <td>2 1/2" (64mm)</td> <td>4 3/8" (111mm)</td> </tr> </tbody> </table>	Cat No.	A	B	PN05F86	1 15/16" (49mm)	4 3/8" (111mm)	PN10F86	2 1/2" (64mm)	4 3/8" (111mm)
Cat No.	A	B								
PN05F86	1 15/16" (49mm)	4 3/8" (111mm)								
PN10F86	2 1/2" (64mm)	4 3/8" (111mm)								
										
PN10F21	Entrance End fitting – Connects 1/2" and 3/4" trade size conduit or armored cable with PN03, PN05 and PN10 Series Raceway. Includes PN153R Reducer Adapter for use with PN03 and PN05 Series Raceway. <div style="text-align: center; margin-top: 10px;">  </div>									

NOTE: Add -"WH" suffix for White finish, -"FW" for Fog White finish, or -"V" for Ivory finish.

Eclipse Series PN03, PN05, and PN10 Series Device Boxes

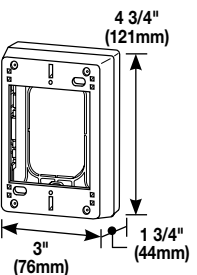
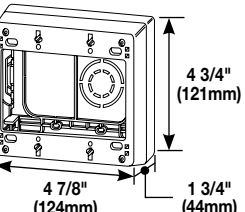
Catalog No./Item	Description/Specifications
PSB1	One-Gang Power Box – Accepts all standard single-gang NEMA face-plates. Concentric twist-outs on all four sides for PN03, PN05, and PN10 Series Raceway. <div style="text-align: center; margin-top: 10px;">  </div>
PSB2	Two-Gang Device Box – Accepts all standard two-gang NEMA faceplates. Concentric twist-outs on all four sides for PN03, PN05, and PN10 Series Raceway. <div style="text-align: center; margin-top: 10px;">  </div>

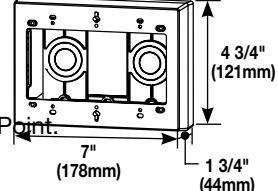
Catalog No./Item	Description/Specifications
PSB3	Three-Gang Device Box – Accepts all standard three-gang NEMA faceplates. Concentric twist-outs on all four sides for PN03, PN05, and PN10 Series Raceway. Designed for use with Ortronics® Wi-Jack™ Wireless Access <div style="text-align: center; margin-top: 10px;">  </div>

NOTE: Add -"WH" suffix for White finish, -"FW" for Fog White finish, or -"V" for Ivory finish.

Eclipse Series PN03, PN05, and PN10 Communication Boxes

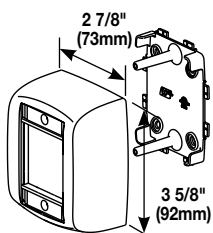
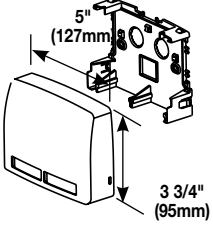
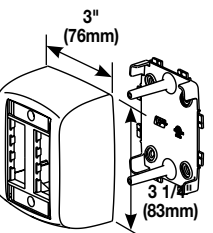
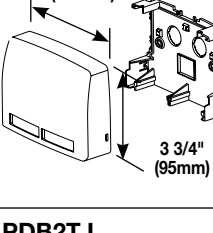
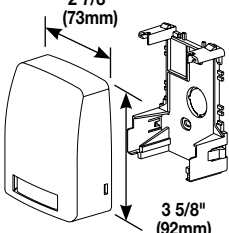
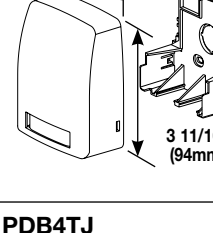
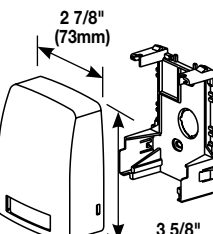
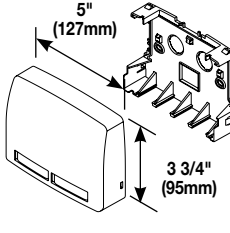
Catalog No./Item	Description/Specifications	Catalog No./Item	Description/Specifications
PBB2S2 	Bezel Box – Surface mount box for use with Eclipse Series Raceway or standalone application. Accepts two front-loaded outward facing devices including Ortronics® Series II devices	PDB2CM 	Large Data Box – Surface mount box for use with Eclipse Series Raceway or standalone application. Accepts two front-loaded downward facing devices including Pass & Seymour® Activate Series inserts and Wiremold Open System communication modules.
PBB4TJ 	Bezel Box – Surface mount box for use with Eclipse Series Raceway or standalone application. Accepts four front-loaded outward facing devices including Ortronics® TracJack devices.	PDB2S2 	Large Data Box – Surface mount box for use with Eclipse Series Raceway or standalone application. Accepts two front-loaded downward facing devices including Ortronics® Series II devices.
PDB1S2 	Small Data Box – Surface mount box for use with Eclipse Series Raceway or standalone application. Accepts one front-loaded downward facing device including Ortronics® Series II devices.	PDB2TJ 	Small Data Box – Surface mount box for use with Eclipse Series Raceway or standalone application. Accepts two front-loaded downward facing devices including Ortronics® TracJack devices.
PDB1CM 	Small Data Box – Surface mount box for use with Eclipse Series Raceway or standalone application. Accepts one front-loaded downward facing device including Pass & Seymour® Activate Series inserts and Wiremold Open System communication modules.	PDB4TJ 	Large Data Box – Surface mount box for use with Eclipse Series Raceway or standalone application. Accepts four front-loaded downward facing devices including Ortronics® TracJack devices.

NOTE: Add -"WH" suffix for White finish, -"FW" for Fog White finish, or -"V" for Ivory finish.

NOTES

NOTE: All brand and product names referenced in this document are registered trademarks or trademarks of their respective holders.



NOTE: The paper used to print this document is an environmentally responsible paper with 10% post consumer waste, with FSC and SFI Chain of Custody certifications, Lacey Act compliant. 100% of the electricity used to manufacture Flo sheets is generated with Green-e certified renewable energy.



Electrical Wiring Systems

60 Woodlawn Street
West Hartford, CT 06110
Phone: 1.877.BY.LEGRAND (295-3472)
www.legrand.us

570 Applewood Crescent
Vaughan, Ontario L4K 4B4
Phone: 905.738.9195
www.legrand.ca

