

# P1000® & P1001 CHANNELS

FOR 1 5/8" (41 MM) WIDTH SERIES CHANNEL

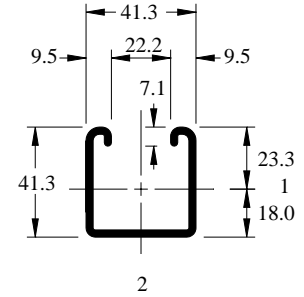

## P1000

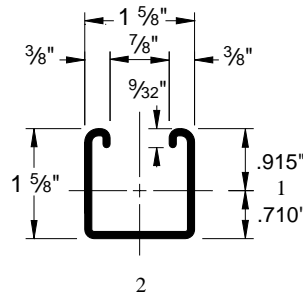
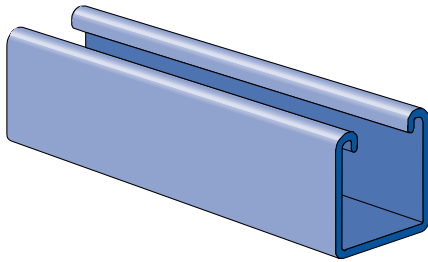

Pierced channels are found on pages 60 and 61.

Weight: 190 Lbs/C Ft (283 kg/100 m)

## P1001

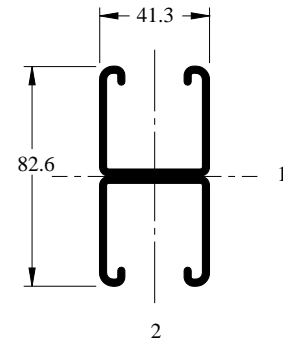
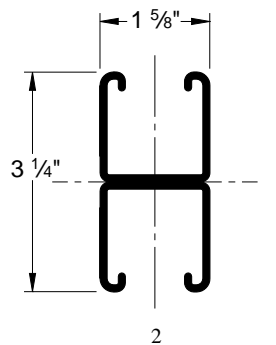
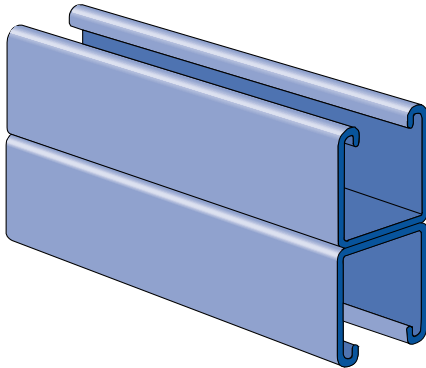

Weight: 380 Lbs/C Ft (566 kg/100 m)

## BEAM LOAD\*

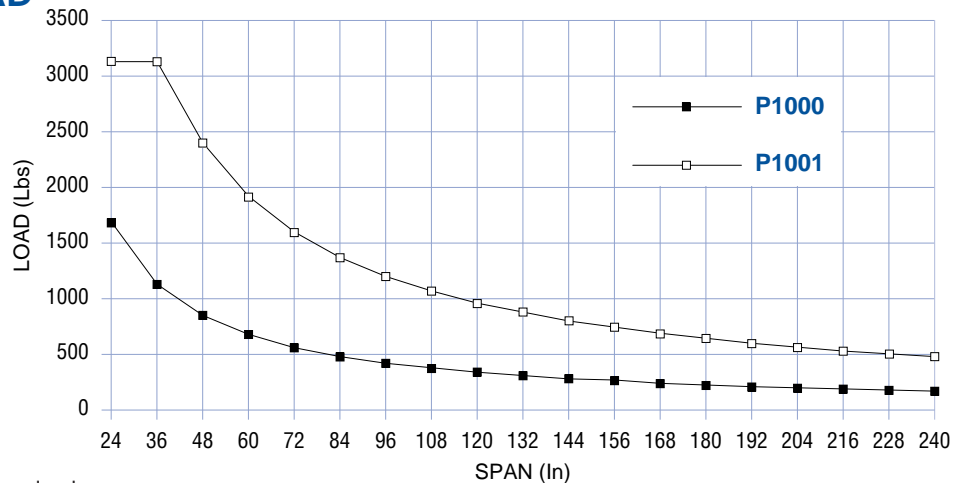

\*Maximum allowable uniform load.

Channel	Weight		Allowable Moment		Material Thickness		Standard Lengths		Finishes				Other Materials	
	Lbs/Ft	kg/m	In-Lb	N*m	In	mm	10'	20'	PL	GR	HG	PG	SS	EA
P1000	1.90	2.8	5,080	570	.105	2.7	■	■	■	■	■	■	■	■
P1001	3.80	5.7	14,390	1630	.105	2.7	■	■	■	■	■	■	■	■

Nominal thickness of 12 gage strip steel is .105 inches.

- 1 5/8" Channels
- Nuts & Hardware
- General Fittings
- Pipe/Conduit Supports
- Electrical Fittings
- Concrete Inserts
- 1 1/4" Framing System
- 1 3/16" Framing System
- Spec. Metals & Fiberglass
- Index

# CHANNELS & COMBINATIONS

FOR 1½" (41 MM) WIDTH SERIES CHANNEL



1 5/8" Channels
Nuts & Hardware
General Fittings
Pipe/Conduit Supports
Electrical Fittings
Concrete Inserts
1¼" Framing System
13/16" Framing System
Spec. Metals & Fiberglass
Index

	Page
<b>P1000</b> 12 Gage	23
<b>P1100</b> 14 Gage	32
<b>P2000</b> 16 Gage	36
<b>P3000</b> 12 Gage	40
<b>P3300</b> 12 Gage	43
<b>P4000</b> 16 Gage	46
<b>P4100</b> 14 Gage	50
<b>P5000</b> 12 Gage	53
<b>P5500</b> 12 Gage	56
<b>Closure Strips</b>	59
<b>Pierced Sections</b>	60
<b>P9000 Series</b> 12 Gage	62



### MATERIAL

Unistrut channels are accurately and carefully cold formed to size from low-carbon strip steel.

Spot-welded combination members are welded 3" (maximum) on center.

#### STEEL: PLAIN

12 Ga. (2.7 mm), 14 Ga.(1.9 mm)  
ASTM A570 GR 33  
16 Ga. (1.5 mm) ASTM A366

#### STEEL: PRE-GALVANIZED

12 Ga. (2.7 mm), 14 Ga. (1.9 mm)  
and 16 Ga. (1.5mm) ASTM A653  
GR 33

For other materials, see Special Metals and Fiberglass section.

### FINISHES

All channels are available in: Perma Green II (GR), pre-galvanized (PG), conforming to ASTM A653; Hot-dipped galvanized (HG), conforming to ASTM A123 or A153; and plain (PL).

### STANDARD LENGTHS

Standard lengths are 10 feet (3.05m) and 20 feet (6.10m). Tolerances are +⅛" (3.2 mm) to +½" (12.7 mm) to allow for cutting. Special lengths are available for a small cutting charge with a tolerance of ±⅛" (3.2mm).

### CURVED CHANNEL

Many Unistrut 1½" (41mm) channel sections are available as curved pieces in both single and combination styles. Contact your local Unistrut Service Center or Unistrut Corporation for ordering information.

### DIMENSIONS

Imperial dimensions are illustrated in inches. Metric dimensions are shown in millimeters and rounded to one decimal place.

### LOAD DATA

All beam and column load data pertains to carbon steel and stainless steel channels. Load tables and charts are constructed to be in accordance with the SPECIFICATION FOR THE DESIGN OF COLD-FORMED STEEL STRUCTURAL MEMBERS AUGUST 19, 1986 EDITION with DECEMBER 11, 1989 ADDENDUM published by the AMERICAN IRON AND STEEL INSTITUTE.

# CHANNELS & COMBINATIONS

FOR 1 5/8" (41 MM) WIDTH SERIES CHANNEL



1 5/8" Channels

Nuts & Hardware

General Fittings

Pipe/Conduit Supports

Electrical Fittings

Concrete Inserts

1/4" Framing System

3/16" Framing System

Spec. Metals & Fiberglass

Index

## CHANNEL SELECTION CHART

Channel	Channel Dimensions				Material & Thickness			Hole Pattern Styles					
	Width		Height		Steel	Stain-less Steel	Alum.	KO	T	SL	HS	DS	H3
	In	mm	In	mm									
<b>P1000</b>	1 5/8	41	1 5/8	41	12 ga	12 ga	.109						
<b>P1100</b>	1 5/8	41	1 5/8	41	14 ga	14 ga	—						
<b>P2000</b>	1 5/8	41	1 5/8	41	16 ga	—	—						
<b>P3000</b>	1 5/8	41	1 3/8	35	12 ga	—	—						
<b>P3300</b>	1 5/8	41	7/8	22	12 ga	12 ga	—						
<b>P4000</b>	1 5/8	41	13/16	21	16 ga	16 ga	.078						
<b>P4100</b>	1 5/8	41	13/16	21	14 ga	—	—						
<b>P5000</b>	1 5/8	41	3/4	83	12 ga	—	—						
<b>P5500</b>	1 5/8	41	27/16	62	12 ga	—	.109						

- This reference chart reflects the available channels and hole patterns manufactured by Unistrut Corporation.
- Stainless steel sections are also available on special order in "T," "SL" and "HS" hole pattern.
- Metric equivalent for material thickness: 12 ga. (2.7 mm); 14 ga. (1.9 mm); and 16 ga. (1.5 mm).

\* Not available in aluminum.

## CHANNELS & COMBINATIONS IN DESCENDING ORDER OF STRENGTH

Channel	S in <sup>3</sup>	I in <sup>4</sup>	Area in <sup>2</sup>	Weight Lbs/Ft
<b>P5001</b>	1.716*	5.578*	1.794	6.10
<b>P1004 A</b>	1.673	4.079	1.978	6.70
<b>P5501</b>	1.153	2.811	1.453	4.94
<b>P1001 C41</b>	1.145	1.860	2.223	7.60
<b>P5000</b>	.628	1.099	.897	3.05
<b>P1001</b>	.572	.930	1.112	3.80
<b>P1101</b>	.456	.741	.834	2.84
<b>P3001</b>	.431	.593	1.007	3.40
<b>P5500</b>	.391	.523	.726	2.47
<b>P2001</b>	.379	.616	.681	2.32
<b>P9200</b>	.297	.278	.489	2.23

Channel	S in <sup>3</sup>	I in <sup>4</sup>	Area in <sup>2</sup>	Weight Lbs/Ft
<b>P9000</b>	.203	.164	.384	2.05
<b>P3301</b>	.202	.177	.797	2.70
<b>P1000</b>	.202	.185	.556	1.90
<b>P1100</b>	.166	.149	.417	1.42
<b>P3000</b>	.154	.121	.503	1.70
<b>P4101</b>	.141	.114	.574	1.94
<b>P2000</b>	.140	.124	.340	1.16
<b>P4001</b>	.125	.101	.478	1.64
<b>P3300</b>	.072	.037	.398	1.35
<b>P4100</b>	.053	.025	.287	.97
<b>P4000</b>	.048	.023	.239	.82

\* Effective section properties.

# P1000 & P1001 CHANNELS

FOR 1<sup>5</sup>/<sub>8</sub>" (41 MM) WIDTH SERIES CHANNEL



## BEAM LOADING DATA

Span	Channel	Max. Allowable Uniform Load		Deflection at Uniform Load		Uniform Loading at Deflections					
						Span/180		Span/240		Span/360	
						In	mm	Lbs	kN	Lbs	kN
24	P1000 P1001	1690 3130*	7.5 13.9	0.06 0.02	1 1	1690 3130*	7.5 13.9	1690 3130*	7.5 13.9	1690 3130*	7.5 13.9
36	P1000 P1001	1130 3130*	5.0 13.9	0.13 0.07	3 2	1130 3130*	5.0 13.9	1130 3130*	5.0 13.9	900 3130*	4.0 13.9
48	P1000 P1001	850 2400	3.8 10.7	0.22 0.13	6 3	850 2400	3.8 10.7	760 2400	3.4 10.7	510 2400	2.3 10.7
60	P1000 P1001	680 1920	3.0 8.5	0.35 0.20	9 5	650 1920	2.9 8.5	490 1920	2.2 8.5	320 1630	1.4 7.3
72	P1000 P1001	560 1600	2.5 7.1	0.50 0.28	13 7	450 1600	2.0 7.1	340 1600	1.5 7.1	220 1130	1.0 5.0
84	P1000 P1001	480 1370	2.1 6.1	0.68 0.39	17 10	330 1370	1.5 6.1	250 1240	1.1 5.5	170 830	0.8 3.7
96	P1000 P1001	420 1200	1.9 5.3	0.89 0.50	23 13	250 1200	1.1 5.3	190 950	0.8 4.2	130 640	0.6 2.8
108	P1000 P1001	380 1070	1.7 4.8	1.14 0.64	29 16	200 1000	0.9 4.4	150 750	0.7 3.3	100 500	0.4 2.2
120	P1000 P1001	340 960	1.5 4.3	1.40 0.79	36 20	160 810	0.7 3.6	120 610	0.5 2.7	80 410	0.4 1.8
144	P1000 P1001	280 800	1.2 3.6	1.99 1.13	51 29	110 560	0.5 2.5	80 420	0.4 1.9	60 280	0.3 1.2
168	P1000 P1001	240 690	1.1 3.1	2.72 1.55	69 39	80 410	0.4 1.8	60 310	0.3 1.4	40 210	0.2 0.9
192	P1000 P1001	210 600	0.9 2.7	3.55 2.02	90 51	60 320	0.3 1.4	50 240	0.2 1.1	NR 160	NR 0.7
216	P1000 P1001	190 530	0.8 2.4	4.57 2.53	116 64	50 250	0.2 1.1	40 190	0.2 0.8	NR 130	NR 0.6
240	P1000 P1001	170 480	0.8 2.1	5.61 3.15	142 80	40 200	0.2 0.9	NR 150	NR 0.7	NR 100	NR 0.4

NR = Not Recommended

\*Load limited by spot weld shear.

Notes:

- Above loads include the weight of the member. This weight must be deducted to arrive at the net allowable load the beam will support.
- Long span beams should be supported in such a manner as to prevent rotation and twist.
- Allowable uniformly distributed loads are listed for various simple spans, that is, a beam on two supports. If load is concentrated at the center of the span, multiply load from the table by 0.5 and corresponding deflection by 0.8.
- See page 66 for lateral bracing load reduction charts.

# P1000 & P1001 CHANNELS

FOR 1 5/8" (41 MM) WIDTH SERIES CHANNEL



## COLUMN LOADING DATA

Unbraced Height		Channel	Max. Allowable Load at Slot Face		Maximum Column Load Applied at C.G.							
					K = .65		K = .80		K = 1.0		K = 1.2	
In	mm		Lbs	kN	Lbs	kN	Lbs	kN	Lbs	kN	Lbs	kN
24	610	P1000	3400	15.1	9600	42.7	9500	42.3	9320	41.5	9100	40.5
		P1001	6360	28.3	23820	106.0	23560	104.8	23130	102.9	22610	100.6
36	914	P1000	3000	13.3	7640	34.0	7400	32.9	7000	31.1	6490	28.9
		P1001	6190	27.5	23190	103.2	22610	100.6	21640	96.3	20460	91.0
48	1219	P1000	2570	11.4	5910	26.3	5530	24.6	4980	22.2	4430	19.7
		P1001	5970	26.6	22310	99.2	21270	94.6	19560	87.0	17460	77.7
60	1524	P1000	2230	9.9	4780	21.3	4390	19.5	3850	17.1	3330	14.8
		P1001	5690	25.3	21180	94.2	19560	87.0	16870	75.0	13590	60.5
72	1829	P1000	1970	8.8	4090	18.2	3680	16.4	3140	14.0	2650	11.8
		P1001	5360	23.8	19790	88.0	17460	77.7	13590	60.5	9570	42.6
84	2134	P1000	1760	7.8	3600	16.0	3170	14.1	2630	11.7	2160	9.6
		P1001	4970	22.1	18150	80.7	14980	66.6	10130	45.1	7030	31.3
96	2438	P1000	1580	7.0	3220	14.3	2770	12.3	2240	10.0	1800	8.0
		P1001	4510	20.1	16270	72.4	12120	53.9	7750	34.5	5380	23.9
108	2743	P1000	1430	6.4	2910	12.9	2450	10.9	1930	8.6	**	**
		P1001	4030	17.9	14120	62.8	9570	42.6	6130	27.3	4250	18.9
120	3048	P1000	1290	5.7	2640	11.7	2180	9.7	**	**	**	**
		P1001	3610	16.1	11750	52.3	7750	34.5	4960	22.1	**	**

\*\* $\frac{KL}{r} > 200$

## ELEMENTS OF SECTION

Channel	Areas of Section		Axis 1 - 1						Axis 2 - 2					
			I		S		r		I		S		r	
	In <sup>2</sup>	cm <sup>2</sup>	In <sup>4</sup>	cm <sup>4</sup>	In <sup>3</sup>	cm <sup>3</sup>	In	cm	In <sup>4</sup>	cm <sup>4</sup>	In <sup>3</sup>	cm <sup>3</sup>	In	cm
P1000	.556	3.6	.185	7.7	.202	3.3	.577	1.5	.236	9.8	.290	4.7	.651	1.7
P1001	1.112	7.2	.930	38.7	.572	9.4	.915	2.3	.472	19.6	.580	9.5	.651	1.7

I - Moment of Inertia

S - Section Modulus

r - Radius of Gyration

1 5/8" Channels

Nuts & Hardware

General Fittings

Pipe/Conduit Supports

Electrical Fittings

Concrete Inserts

1 1/4" Framing System

1 3/16" Framing System

Spec. Metals & Fiberglass

Index