

Ballasts For High Intensity Discharge Lamps

Universal Means Higher Expectations In High Intensity Discharge

Universal Lighting Technologies (“Universal”) offers a wide array of ballasts for High Intensity Discharge (HID) lamps. Applications include Metal Halide (MH), Pulse Start Metal Halide (PSMH), and High Pressure Sodium (HPS) lamps ranging from 35 to 1650 watts.

We’re the technology leader in every category of HID ballasts. Our Universal Precise™ line is the latest innovation in magnetic core & coil technology in years.



Universal offers a complete line of HID ballasts for applications ranging from 35 - 1650 watts.

Product Overview

Core & Coil

Core & coil ballasts are used in over 90% of all HID fixtures. Universal's core & coil models are available for all HID lamp types, including single-, dual-, tri-, quad- and multi-volt designs. For added versatility and reduced inventory costs, Universal has also introduced the industry's first Multi-5™ ballast (120, 208, 240, 277, or 480 volt), featuring a 480-volt tap on a conventional quad-tap ballast.

Our core & coil models are ideal for a wide variety of lighting applications, including factories, warehouses, gymnasiums and retail stores. All these ballasts feature precision-wound coils, ensuring even heat dissipation and the highest electrical integrity.

Universal's Universal Precise™ is the next generation in core & coil technology, featuring a smaller, light-weight design and improved temperature performance. Universal Precise™ fits virtually all applications, and has no exposed live metal parts. There are no plastic extrusions, which prevents breakage during shipping. Color-coded leads make installation easy.

50 Hertz

Universal offers 50 Hz core & coil ballasts to meet the rapid growth in demand in international markets. Our ballasts are available for 220, 230, and 240 volt electrical systems.

F-Can

These ballasts are used primarily for indoor downlighting applications where quiet operation is essential. All the components of these ballasts are enclosed in a fluorescent-style ballast can and are thermally protected.



F-Can Ballasts



Core and Coil Ballasts



HID Ballast Kits

Product Overview

For maximum safety and reliability, all Universal capacitors come with built-in bleed (discharge) resistors in accordance with applicable safety UL, CSA, and IEC standards. Environmental safety of oil filled capacitors is assured by use of biodegradable, nontoxic (no PCBs) dielectric fluid (soybean oil). Oil filled capacitors are equipped with protective devices to prevent capacitor case rupture. Dry-film capacitors do not include protective devices. Since they can fail in a hazardous manner, it is the responsibility of the purchaser to take appropriate precautions.

Capacitors

Universal has a comprehensive line of capacitors in metal cases (up to 525V ratings) and plastic cases (up to 400V ratings). All Universal capacitors are designed for 60,000 hours of continuous life. They're exceptionally reliable because we put them through accelerated life testing at 125% rated voltage and rated temperature +10°C.

Universal capacitors are normally packaged with ballasts. They may also be ordered separately, bulk packaged, or individually boxed with the suffix "BH" (metal cases only). Capacitor weights vary from 1/4 lb. to 1 lb. each.

Dry Capacitors

Type "P" plastic case capacitors described in this section are dry and do NOT contain safety interrupters (or oil). Plastic cases are UL rated "94V-0" (for use up to 100°C maximum). Type "P" capacitors are supplied with stranded copper wire leads 8 inches long (18 awg, with 150°C rated insulation). Capacitor rolls are sealed inside plastic cases using epoxy. Design and testing of Universal capacitors follow specifications in Electronic Industries Association (EIA) Standard 456-A, titled "Metalized Film Dielectric Capacitors for Alternating Current Application."

"P" capacitors are designed and rated for continuous duty AC voltages 400VAC and below @ 50 or 60 Hz. Capacitors used with HID ballasts at voltages above 400VAC should contain interrupters (available from Universal in oval "MF" and round "RMF" oil-filled metal cases).

Plastic Dry Type Capacitors

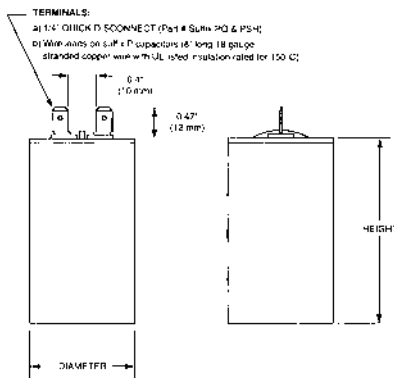

Metal and Oil Filled Capacitors

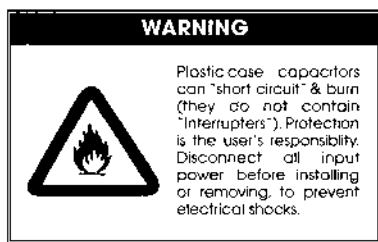
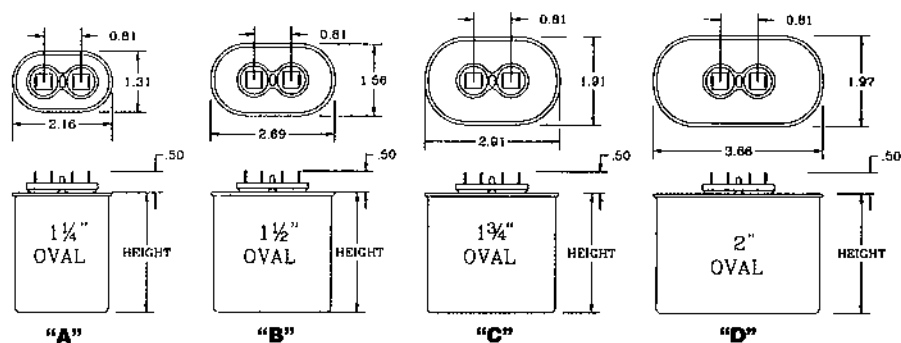

Protective Device (Only in metal cases) Protective device to prevent case rupture

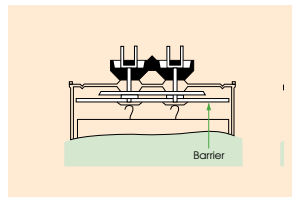

Normal Position of Protective Device

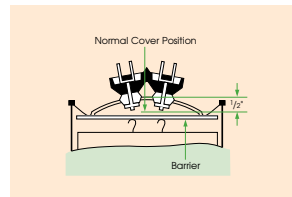

Position of Protective Device After Activation

Oil-Filled Capacitors

μF	VACr	Part #	Case	Ht (")	μF	VACr	Part #	Case	Ht (")
5.0	300	005-1466-BH	1.25 oval	2.2	22.5	300	005-1419-BH	1.50 oval	3.5
6.0	300	005-1561-BH	1.25 oval	2.2	24.0	360	005-3160-BH	1.75 oval	3.1
7.0	300	005-1410-BH	1.25 oval	2.2	24.0	400	005-2664-BH	1.75 oval	3.1
8.0	330	005-1411-BH	1.25 oval	2.2	24.0	480	005-2779-BH	1.75 oval	3.9
10.0	330	005-1413-BH	1.25 oval	2.7	24.5	300	005-3278-BH	1.75 oval	2.7
10.0	400	005-1184-BH	1.50 oval	2.7	26.0	330	005-2669-BH	1.75 oval	3.1
10.0	400	005-2167-BH	1.75 dia	2.9	26.0	525	005-2776-BH	1.75 oval	4.3
12.0	300	005-1467-BH	1.25 oval	3.1	28.0	240	005-1886-BH	1.75 dia	2.3
12.0	400	005-2799-BH	1.50 oval	2.7	28.0	300	005-1468-BH	1.75 oval	3.1
12.0	440	005-1464-BH	1.50 oval	3.1	28.0	425	005-1799-BH	1.75 oval	3.9
13.0	300	005-1414-BH	1.25 oval	3.1	30.0	440	005-1475-BH	1.75 oval	3.9
14.0	240	005-1884-BH	1.75 dia	2.3	32.0	300	005-2351-BH	1.75 oval	3.1
14.0	300	005-1415-BH	1.50 oval	2.7	32.0	525	005-1474-BH	2.00 oval	3.9
15.0	400	005-1185-BH	1.75 oval	2.7	33.0	300	005-1470-BH	1.75 oval	3.1
16.0	300	005-1498-BH	1.50 oval	2.7	35.0	330	005-1421-BH	1.75 oval	3.1
17.5	300	005-1417-BH	1.50 oval	3.1	36.0	525	005-2793-BH	2.00 oval	4.3
18.0	440	005-1401-BH	1.75 oval	3.1	40.0	240	005-1887-BH	1.75 dia	2.7
18.5	330	005-1796-BH	1.50 oval	3.1	40.0	300	005-1768-BH	1.75 oval	3.9
20.0	240	005-1885-BH	1.75 dia	2.3	48.0	330	005-1422-BH	1.75 oval	3.9
20.0	330	005-1418-BH	1.50 oval	3.1	52.0	240	005-1888-BH	2.00 dia	2.9
20.5	400	005-3262-BH	1.75 oval	3.1	55.0	240	005-1594-BH	1.75 oval	3.5
21.0	525	005-1495-BH	1.75 oval	3.9	55.0	300	005-2117-BH	1.75 oval	3.9

Dry Capacitors

-- µF	V	100°C Rated Part #	DIA (")	L (")	-- µF	V	100°C Rated Part #	DIA (")	L (")
5.0	280	R17058511-BH	1.26	2.36	20.0	170	R17058501-BH	1.65	2.83
5.0	280	R17058512-BH	1.26	2.83	20.0	280	R17058526-BH	1.65	3.82
5.0	330	R17058539-BH	1.26	2.24	20.0	330			
6.0	280	R17058513-BH	1.26	2.36	20.0	400	R17058564-BH	1.85	3.82
6.0	280	R17058514-BH	1.26	2.83	20.5	400	R17058565-BH	1.85	3.82
7.0	280	R17058515-BH	1.65	2.83	21.0	400	R17058567-BH	1.85	3.82
8.0	300	R17058535-BH	1.65	2.83	22.0	400	R17058569-BH	1.85	3.82
8.0	330	R17058541-BH	1.65	2.83	22.5	280	R17058527-BH	1.65	3.15
10.0	280	R17058517-BH	1.26	2.83	22.5	280	R17058528-BH	1.65	3.82
10.0	280	R17058519-BH	1.65	2.83	24.0	280	R17058529-BH	1.65	3.82
10.0	330	R17058578-BH	1.65	2.83	24.0	400	R17058571-BH	1.85	3.82
10.0	400	R17058555-BH	1.65	2.83	24.0	400			
10.0	400	R17058557-BH	1.65	3.82	24.5	330	R17058552-BH	1.65	4.76
11.0	400	R17058558-BH	1.65	2.83	26.0	300	R17058537-BH	1.65	4.76
12.0	300	R17058536-BH	1.65	2.83	26.5	400	R17058574-BH	1.85	4.76
12.0	330	R17058543-BH	1.65	2.83	28.0	170	R17058502-BH	1.65	2.83
12.0	400	R17058580-BH	1.65	3.82	28.0	280	R17058530-BH	1.65	4.76
13.0	330				28.0	330	R17058553-BH	1.85	3.82
14.0	170	R17058500-BH	1.26	2.83	35.0	280	R17058531-BH	1.65	3.82
14.0	280	R17058520-BH	1.65	2.83	35.0	280	R17058532-BH	1.85	4.76
14.0	280	R17058520-BH	1.65	2.83	40.0	240	R17058505-BH	1.65	3.82
14.0	400	R17058560-BH	1.65	3.82	40.0	240	R17058506-BH	1.65	4.76
15.0	400	R17058562-BH	1.65	3.82	48.0	280	R17058533-BH	1.85	4.76
15.0	400	R17058563-BH	1.85	3.82	48.0	330	R17058554-BH	2.05	4.76
16.0	280	R17058522-BH	1.65	2.83	52.0	170	R17058503-BH	1.85	3.82
16.0	280	R17058522-BH	1.65	2.83	52.0	280	R17058534-BH	1.85	4.76
16.0	330	R17058547-BH	1.65	2.83	55.0	240	R17058507-BH	1.85	3.82
17.0	400	R17058588-BH	1.65	3.82	55.0	240	R17058509-BH	1.85	4.76
17.5	280	R17058523-BH	1.65	3.82	55.0	300	R17058538-BH	1.85	4.76

Application And Operating Information

Underwriters' Laboratories, Inc. Acceptance

All F-Can and Weatherproof ballasts listed in this catalog are Underwriters' Laboratories, Inc. white card listed, except those for 347 volt operation. All Core & Coil and Potted Core & Coil ballasts listed in this catalog are Underwriters' Laboratories, Inc. yellow card listed (component recognized).

Ballast Replacement

Ballast replacement presents the possibility of exposure to potentially hazardous voltages and should be performed only by qualified personnel. All installation, inspection and maintenance should be performed only with the entire circuit power to fixture or equipment turned off. Installation shall be in accordance with National Electric Code.

Heat

A ballast, like any other electrical device, generates heat during normal operation. Planning for maximum heat dissipation with proper fixture design, installation planning and ballast selection will minimize the possibility of a heat-related problem arising. Excessive temperature will have an adverse effect on ballast life.

Normal temperature limits:

F-Can Ballasts

Maximum case temperature: 90°C

Potted Core & Coil Ballasts and

Core & Coil Ballasts

Insulation: Class 180°C

Maximum coil temperature: 165°C

(measured by change of resistance method)

All F-Can ballasts listed in this catalog are equipped with built-in automatic resetting internal thermal protection as a standard feature.

Whenever a ballast with thermal protection is used, it is imperative that the fixture/ballast/lamp combination be heat tested under actual or simulated installation conditions to assure that the ballast will not cycle. The resetting thermal protector functions as a thermostat which will open and temporarily deactivate the ballast when it exceeds the permissible

temperature. The ballast will continue to cycle until the cause of overheating is eliminated. If the ballast is defective, it must be replaced. If the cause is external, the ballast will resume normal operation after abnormal conditions are eliminated.

To attain normal ballast life, the maximum coil temperature of the ballast should not exceed the rating of the insulation system. A temperature increase of 10° C results in a 50% reduction of ballast life.

Low Ambient Temperature (cold)

As temperatures drop, less and less vaporized gas is available within the arc tube of a high intensity discharge lamp, thereby causing an increase in the open circuit voltage required to initiate an arc in the lamp, until a point is reached where the lamp cannot be started. The minimum temperature at which any ballast listed in this catalog will provide reliable starting is listed with the electrical characteristics.

Ballasts should be protected from weather, moisture, or other abnormal atmospheric conditions, unless specifically designed for use under adverse conditions.

Fusing

The purpose of fusing an HID ballast is to remove the ballast from the power line in the event of a ballast system failure. A fuse does not protect the ballast from failing.

Because the temperature in the ballast compartment is high, typically 90°C, fuse ratings are specified at 25°C, and that this rating declines as the temperature increases, HID fuse recommendations are made between 2 and 3 times the maximum current the ballast will draw during all normal conditions.

Fast-blow fuses should not be used due to the possibility of high inrush currents. These currents are due to the fact that the power can be applied at any point in the AC voltage waveform. Standard and slow-blow are acceptable.

When using the 120V tap for auxiliary lighting, a slow-blow fuse should be used to protect the ballast from damage from a fault in the auxiliary lighting circuit.

REMOTE MOUNTING DISTANCE

Maximum Length in Feet for Remote Mounting of HID Ballasts to Lamp

ANSI	Lamp Type	Watts	12 GA	14 GA	16 GA	18 GA
M57	Metal Halide	175	272	171	107	67
M58	Metal Halide	250	194	122	77	48
M59	Metal Halide	400	132	83	52	33
M47	Metal Halide	1000	196	123	77	48
M48	Metal Halide	1500	146	92	58	36

For proper installation, insure that remote ballasts are properly vented and mounted to a heat-dissipating surface.

Application And Operating Information

Sound

High intensity discharge lamp ballasts, like all electromagnetic devices, produce noise, or “hum.” It is the degree of noise which determines the existence of a problem. Ballast noise will only be noticeable when it exceeds the ambient sound level of the installation. It is obvious that a ballast designed primarily for outdoor or factory use would not be suitable in an office environment.

The vast improvements in all high intensity discharge lamps and ballasts, and their excellent energy efficiency, have made them viable options for many indoor applications. The ballasts being considered should be carefully analyzed to insure that there will not be an objectionable level of ballast noise.

All F-Can ballasts listed in this catalog are “Sound Rated” to aid in the selection of a ballast which is proper for the environment in which it will operate.

Potted Core & Coil ballasts are also designed to operate at reduced sound levels, generally several decibels lower than a standard Core & Coil ballast. Core & Coil ballasts are not sound rated.

In situations where light output necessitates using a ballast with a sound rating or noise level not normally acceptable, the ballast should be remotely mounted. Note, however, that not all ballasts listed in this catalog are designed or recommended for remote mounting.

Polarity

Polarity refers to the proper connection of ballast lead wires to line wires. To aid you in making a correct installation, Universal ballast leads are color-coded for easy identification. The white or yellow ballast lead is to be connected to the neutral or common. Choose the appropriate ballast voltage lead to connect to the line.

Grounding

Ballasts and capacitors or starters in metallic casings must always be grounded. Ballasts and components may be grounded to the fixture or otherwise connected to ground. It would be hazardous to make

contact with an ungrounded fixture, ballast or other electrical component while in operation.

Operating Line Voltage Limits

To receive the full benefits of rated lamp output and to prolong ballast life, it is essential that the voltage supplied to an installation be maintained within the prescribed limits.

In general, the line voltage supplied to a lag type ballast (reactor or high reactance autotransformer) should be maintained within 5% of the voltage for which the ballast is rated. The line voltage to lead type ballasts (constant wattage autotransformer or constant wattage isolated) should be maintained within 10%.

Subjecting a ballast to excessive voltage for an extended period of time results in the deterioration of the coil insulation. This insulation breakdown will cause early ballast failure.

Low voltage has no damaging effect on the ballast. It could, however, have an adverse effect on lamp performance and starting dependability.

Maintenance

Selecting and installing an adequate and efficient lighting system means nothing if it is not properly maintained. Maintenance must always be considered as part of the life cycle cost of any high intensity discharge lighting installation in order to assure the continued performance of the system as originally specified.

First and foremost in importance is proper lamp maintenance. High intensity discharge lamps do not “burn out” like an incandescent bulb, but rather, undergo changes within the arc tube which prevent the lamp from starting properly, warming up and producing full light output. The beginning of difficulties such as these generally indicates the end of a lamp’s useful life. Also, a dead lamp left in a fixture can be very damaging to the ignitor in systems which utilize them. To overcome this problem, Universal offers automatic shutoff ignitors, which are described in the ignitor section of this catalog.

Application And Operating Information

In difficult locations, group replacement of all the lamps, working or not, is often more economical and convenient than spot replacement. The same, of course, applies to ballasts which might be approaching the end of their life. Only you can decide what is right for your lighting system, but what is important is that you have a maintenance program.

Periodic cleaning of the fixtures' lenses and reflectors is also important in maintaining proper light output. For indoor systems, maintenance of reflective surfaces, such as walls and ceilings, will also help assure proper levels of illumination.

STANDBY LIGHTING AND PACKAGING

Standby Lighting

To provide light during a high intensity discharge lamp's warmup period, or the cool-down period following a power interruption which has extinguished it, incandescent standby lighting can be incorporated. This is accomplished by use of a standby lighting device, or remote, that switches off an incandescent lamp incorporated into the fixture once an arc has been established, or reestablished, in the HID lamp. Generally, standby lighting devices operate on 120 volts, so a tap must be provided on ballasts designed to operate at higher line voltages.

The 120 volt terminal or lead on all Universal dual-, tri-, quad- and multi-volt ballasts can be used as a tap for standby lighting when the ballast is utilized for any of the higher voltages. Many single voltage ballasts are available with a 120 volt tap and are listed throughout the Core & Coil data section. Other single voltage ballasts may be available in this version. Consult our Customer Service Department for availability and price information.

Any connection to the 120 volt tap must be accomplished by means of a slow-blow fuse. This fuse will protect the ballast from abnormal conditions in the standby lamp circuit or its control device. The fuse should be located in the coolest place in the fixture (below 80°C). The recommended fuse amperage and maximum auxiliary lamp wattage are listed in this catalog for each ballast suitable

for standby lighting applications. Be sure to follow the wiring instructions of the standby lighting device manufacturer. All applicable requirements of the National Electrical Code must be met.

Packaging

Standard Pack

Universal's high intensity discharge lamp ballasts are routinely packed in easy-to-handle cartons containing from 1 to 20 units per carton, depending on the size and weight of the ballasts. Consult Customer Service for the number of "units per carton" for shipment with attached mounting brackets, capacitors (for high power factor units), and ignitors (if required). Other ordering criteria may cause packaging to vary.

Tray Pack

For the convenience of large quantity users who request it, Universal ballasts may be packed in trays. The number of units depends upon the size and weight of each ballast. These trays are large corrugated cartons with lids and sides that come off easily. This type of packaging affords Universal customers a savings of time and money on their own production costs. There are fewer cartons to open, break up and dispose of on the assembly line; warehouse handling is reduced and inventory control is easier. There is no additional charge for tray packing.

Individual Cartons

All Distributor Replacement Kits, Weatherproof, Potted Core & Coil and other larger ballasts are packaged in individual cartons.

Individual cartons serve a threefold purpose: as a display carton, a stock package, and a shipping container for the retail market. Individual cartons may be packed in master cartons, depending on weight and size.

Individual carton packaging may be available for other ballasts. Contact our Customer Service Department for availability and cost.

Nomenclature

UNIVERSAL PRECISE™

ABBREVIATIONS

CWA	Constant Wattage Autotransformer
CWI	Constant Wattage Isolated
ISO	Regulated Lag
R-HPF	Reactor—High Power Factor
R-NPF	Reactor—Normal Power Factor
HX-HPF	Lag Type — High Reactance Autotransformer—High Power Factor
HX-NPF	Lag Type — High Reactance Autotransformer—Normal Power Factor

UL Bench Top Rise Temperature Code

To facilitate UL inspection, the UL Bench Top Rise Temperature Code is shown on the Universal Core & Coil Ballast label as 1029X. 1029 is the UL Standard for HID Ballasts, and the X is the temperature code. If a fixture is UL listed for 1029D, then automatically all ballasts with an A, B, C or D temperature classification are acceptable for use within that same fixture.

UL Bench Top Rise Letter Code Temperature Range for Class H (180° C) Ballasts

A < 75°C	B 75°C < 80°C	C 80°C < 85°C
D 85°C < 90°C	E 90°C < 95°C	F 95°C < 100°C

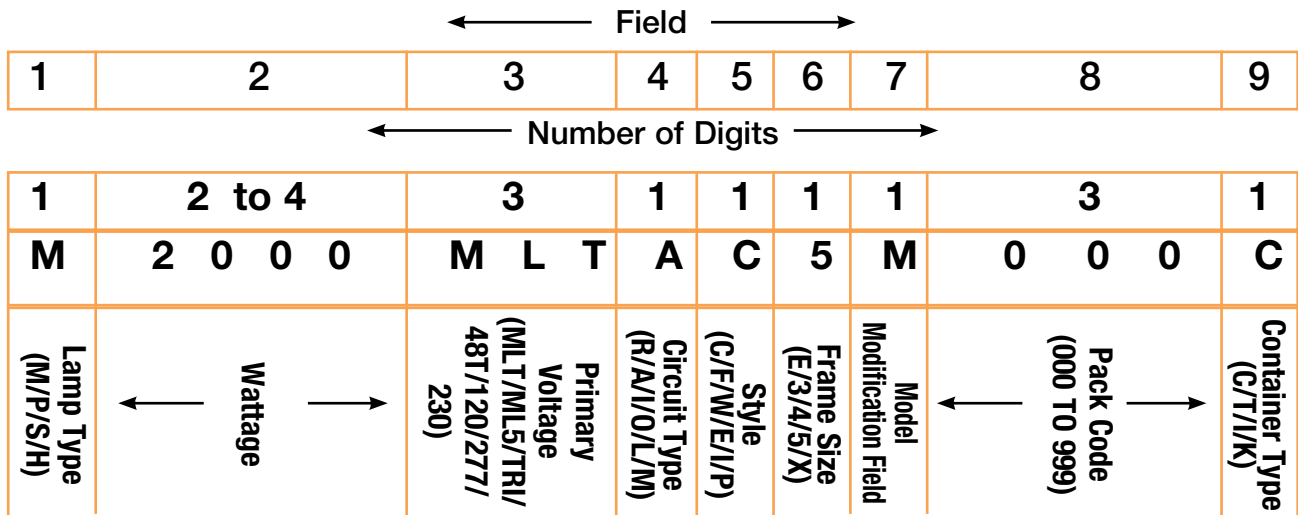

Field	Description
1	(M) Metal Halide, (P) Pulse Start Metal Halide, (S) High Pressure Sodium
2	35 to 1500 Watts (Varies from two to four digits)
3	(MLT) Quad, (ML5) Multi-5, (TRI) TriVolt, (48T) 480/120, (120) 120, (277) 277, (230) 230V/50Hz
4	(R) Reactor, (A) CWA, (I) CWI, (O) IsoReg, (L) High Reactance/Lag, (M) MagLag
5	(C), C&C, (F) F-Can, (W) Weatherproof, (E) Encased/Potted C&C (I) Indoor Encased
6	(E) E&I, (3) 3x4, (4) 4-3/4, (5) 5-3/4, (X) Non Core and Coil
7	Model Modification Field
8	Pack Code (000 to 999, per pack code listing)
9	(C) Carton, (T) Tray, (I) Individual, (K) Kit

Specifications

TYPICAL SPECIFICATIONS FOR HID BALLASTS

1. Ballasts shall be designed in accordance with all applicable ANSI specifications including ANSI C82.4.
2. The Core & Coil ballast shall be designed with class "H" (180°C) or higher insulation system and vacuum impregnated with a 100% solid based resin.
3. All coils shall be precision wound.
4. Core & Coil ballasts shall be designed to operate at least 180 cycles of 12 hours on and 12 hours off, with the lamp circuit in an open or short-circuited condition and without undue reduction in ballast life.
5. Core & Coil ballast and starter combinations shall be designed to provide a reliable lamp starting down to -40°C for High Pressure Sodium and Pulse Start Metal Halide and -30°C for Metal Halide and Mercury at minimum rated line voltage.
6. Manufacturer shall provide written warranty against defects in workmanship, including replacement, for two years from date of manufacture.

CAPACITORS

1. All capacitors will be provided with a self-contained internal bleeder resistor.
2. All oil-filled capacitors will be housed in corrosion-resistant steel cans and contain .25" quick disconnect terminals.
3. All capacitors will be supplied by ballast manufacturer.

IGNITORS

1. All ignitors will be epoxy-filled with either a plastic or aluminum external housing.
2. The ignitor shall be so designed to provide six months of lamp open circuit operation without failure.

KITS

1. All HID kits shall be precision wound to insure proper insulation.
2. All HID kits shall be pre-wired.
3. All HID kits shall be built with color-coded leads.
4. All HID kits are to be UL and CSA recognized following the guidelines found in UL 1029 and CAN/CSA-22.2 No. 74-92 (part 2 and 3).
5. Universal Model _____ (or approved equal).

Distributor Replacement Kits

Universal's HID distributor replacement kits contain the appropriate core & coil, a properly rated capacitor, and all other components required for ballast replacement. Our kits are the quickest and easiest to install of any on the market, thanks to unique design features like:

- Prewired capacitor and ignitor (if required) to save installation time and reduce wiring errors.
- Color-coded leads to reduce risk of incorrect wiring inside the fixture.
- Features that exceed UL standards, including capacitors that offer trip fault protection.
- Simple installation instructions and troubleshooting tips.
- UPS shippable box.

Our kit offerings include many quad voltage (120, 208, 240, or 277 volt) and 480 volt core & coil ballasts, as well as the new Multi-5 five-voltage ballast. 480 volt ballasts are equipped with a 120 volt tap to accommodate stand by lighting.

Also available for Metal Halide and High Pressure Sodium applications, Universal Lighting's Multi-5™ Ballast-Lamp Replacement Kit. This easy to carry convenient all-in-one kit ensures ballast lamp compatibility.

Distributor replacement kit cartons are packaged in master cartons in quantities from 1 to 6 units. Master carton quantities can be found on Universal's list and distributor price sheets.

Quad, 480 Volt, Multi-5™ and Multi-5™ Uni-Pak™ Distributor Replacement Kits

LampType	Wattage	Voltage	Frame Size	Old Part Number	New Part Number
Metal Halide	175	120/208/240/277	3 x 4	1130-91R-500K	M175MLTAC3M500K
	175	Multi-5	3 x 4	New	M175ML5AC3M500K
	175	Multi-5™ Uni-Pak™	3 x 4	New	M175ML5AC3M555K
	175	480-120	3 x 4	1130-31-500K	M17548TAC3M500K
	250	120/208/240/277	3 x 4	1130-92-500K	M250MLTAC3M500K
	250	Multi-5	3 x 4	New	M250ML5AC3M500K
	250	Multi-5™ Uni-Pak™	3 x 4	New	M250ML5AC3M555K
	250	480-120	3 x 4	1130-32-500K	M25048TAC3M500K
	250	120/208/240/277	4.25 x 4.75	1130-92R-500K	M250MLTAC4M500K
	250	Multi-5	4.25 x 4.75	New	M250ML5AC4M500K
	250	Multi-5™ Uni-Pak™	4.25 x 4.75	New	M250ML5AC4M555K
	250	480-120	4.25 x 4.75	1130-32R-500K	M25048TAC4M500K
	400	120/208/240/277	4.25 x 4.75	1130-93U-500K	M400MLTAC4M500K
	400	Multi-5	4.25 x 4.75	1130-826S-500K	M400ML5AC4M500K
	400	Multi-5™ Uni-Pak™	4.25 x 4.75	New	M400ML5AC4M555K
	400	480-120	4.25 x 4.75	1130-33R-500K	M40048TAC4M500K
	1000	120/208/240/277	4.25 x 5.75	1130-97-500K	M1000MLTAC5M500K
	1000	Multi-5	4.25 x 5.75	New	M1000ML5AC5M500K
	1000	Multi-5™ Uni-Pak™	4.25 x 5.75	New	M1000ML5AC5M555K
	1000	480-120	4.25 x 5.75	1130-57-500K	M100048TAC5M500K
1500	120/208/240/277	4.25 x 5.75	1130-99R-500K	M1500MLTAC5M500K	
1500	480-120	4.25 x 5.75	1130-69R-500K	M150048TAC5M500K	

Distributor Replacement Kits

Quad, 480 Volt, Multi-5™ and Multi-5™ Uni-Pak™ Distributor Replacement Kits

LampType	Wattage	Voltage	Frame Size	Old Part Number	New Part Number
Pulse Start Metal Halide	35	120/208/240/277	3 x 4	New	M35MLTLC3M500K
	50	120/208/240/277	3 x 4	11310-95-500K	M50MLTLC3M500K
	70	120/208/240/277	3 x 4	11310-510-500K	M70MLTLC3M500K
	70	480-120	3 x 4	New	M7048TLC3M500K
	70	120/208/240/277	3 x 4	New	M70MLTLC3D500K
	100	120/208/240/277	3 x 4	M100MLTLC3M	M100MLTLC3O500K
	100	120/208/240/277	3 x 4	New	M100MLTLC3D500K
	100	480-120	3 x 4	New	M10048TLC3M500K
	150	120/208/240/277	3 x 4	11310-543-500K	M150MLTLC3M500K
	150	120/208/240/277	3 x 4	New	M150MLTAC3M500K
	150	120/208/240/277	3 x 4	New	M150MLTLC3D500K
	150	480-120	3 x 4	New	M15048TLC3M500K
	175	120/208/240/277	3 x 4	New	P175MLTAC3M500K
	175	120/208/240/277	3 x 4	New	P175MLTAC3L500K
	175	Multi-5	3 x 4	New	P175ML5AC3M500K
	175	120/208/240/277	4.25 x 5.75	New	P175MLTAC4L500K
	175	480-120	3 x 4	New	P17548TAC3L500K
	175	480-120	4.25 x 5.75	New	P17548TAC4L500K
	200	120/208/240/277	3 x 4	New	P200MLTAC3L500K
	200	Multi-5	3 x 4	New	P200ML5AC3M500K
	200	480-120	3 x 4	New	P20048TAC3L500K
	250	120/208/240/277	4.25 x 4.75	New	P250MLTAC4L500K
	250	Multi-5	4.25 x 4.75	New	P250ML5AC4L500K
	250	480-120	4.25 x 4.75	New	P25048TAC4L500K
	320	120/208/240/277	4.25 x 4.75	1130-827-500K	P320MLTAC4O500K
	320	Multi-5	4.25 x 4.75	New	P320ML5AC4M500K
	320	Multi-5	4.25 x 4.75	New	P320ML5AC4L500K
	320	480-120	4.25 x 4.75	New	P32048TAC4L500K
	350	120/208/240/277	4.25 x 4.75	1130-622-500K	P350MLTAC4M500K
	350	Multi-5	4.25 x 4.75	P350ML5AC4M	P350ML5AC4O500K
	350	Multi-5	4.25 x 4.75	New	P350ML5AC4L500K
	350	480-120	4.25 x 4.75	New	P35048TAC4L500K
	400	120/208/240/277	4.25 x 4.75	1130-829-500K	P400MLTAC4L500K
	400	Multi-5	4.25 x 4.75	New	P400ML5AC4L500K
	400	480-120	4.25 x 4.75	New	P40048TAC4L500K
	450	120/208/240/277	4.25 x 4.75	New	P450MLTAC4L500K
	450	Multi-5	4.25 x 4.75	New	P450ML5AC4L500K
	450	480-120	4.25 x 4.75	New	P45048TAC4L500K
	750	120/208/240/277	4.25 x 5.75	New	P750MLTAC5M500K
	750	Multi-5	4.25 x 5.75	New	P750ML5AC5M500K
750	480-120	4.25 x 5.75	New	P75048TAC5M500K	
875	120/208/240/277	4.25 x 5.75	New	P875MLTAC5M500K	
1000	120/208/240/277	4.25 x 5.75	New	P1000MLTAC5M500K	
1000	Multi-5	4.25 x 5.75	New	P1000ML5AC5M500K	

Distributor Replacement Kits

Quad, 480 Volt, Multi-5™ and Multi-5™ Uni-Pak™ Distributor Replacement Kits

LampType	Wattage	Voltage	Frame Size	Old Part Number	New Part Number
H.P.S.	50	120/208/240/277	3 x 4	12310-95-500K	S50MLTLC3M500K
	70	120/208/240/277	3 x 4	12310-153-500K	S70MLTLC3M500K
	70	480-120	3 x 4	12310-148R-500K	S7048TLC3M500K
	100	120/208/240/277	3 x 4	12310-90-500K	S100MLTLC3M500K
	100	480-120	3 x 4	12310-30R-500K	S10048TLC3M500K
	150	120/208/240/277	3 x 4	S150MLTLC3M	S150MLTLC3O500K
	150	480-120	3 x 4	12310-160S-500K	S15048TLC3M500K
	200	120/208/240/277	4.25 x 4.75	New	S200MLTAC4M500K
	200	480-120	4.25 x 4.75	New	S20048TAC4M500K
	250	Multi-5	4.25 x 4.75	S250ML5AC4M	S250ML5AC4O500K
	250	120/208/240/277	4.25 x 4.75	1230-92S-500K	S250MLTAC4M500K
	250	480-120	4.25 x 4.75	1230-32S-500K	S25048TAC4M500K
	250	Multi-5™ Uni-Pak™	4.25 x 4.75	New	S250ML5AC4M555K
	400	Multi-5	4.25 x 4.75	New	S400ML5AC4M500K
	400	120/208/240/277	4.25 x 4.75	1230-93U-500K	S400MLTAC4M500K
	400	480-120	4.25 x 4.75	1230-33U-500K	S40048TAC4M500K
	400	Multi-5	4.25 x 5.75	New	S400ML5AC5M500K
	400	120/208/240/277	4.25 x 5.75	1230-93S-500K	S400MLTAC5M500K
	400	480-120	4.25 x 5.75	1230-33S-500K	S40048TAC5M500K
	400	Multi-5™ Uni-Pak™	4.25 x 4.75	New	S400ML5AC4M555K
	400	Multi-5™ Uni-Pak™	4.25 x 4.75	New	S400ML5AC5M555K
	600	120/208/240/277	4.25 x 5.75	New	S600MLTAC5M500K
	1000	120/208/240/277	4.25 x 5.75	1230-97S-500K	S1000MLTAC5M500K
	1000	Multi-5	4.25 x 5.75	New	S1000ML5AC5M500K
	1000	Multi-5™ Uni-Pak™	4.25 x 5.75	New	S1000ML5AC5M555K
	1000	480-120	4.25 x 5.75	1230-57S-500K	S100048TAC5M500K

HID

Distributor Replacement Kits



Canadian Tri-Tap Distributor Replacement Kits

LampType	Wattage	Voltage	Frame Size	Old Part Number	New Part Number
Metal Halide	175	120/277/347	3 x 4	1130-605-502K	M175TRIAC30502K
	250	120/277/347	3 x 4	New	M250TRIAC3M502K
	250	120/277/347	4.25 x 4.75	1130-593R-502K	M250TRIAC4M502K
	400	120/277/347	4.25 x 4.75	M400TRIAC4M	M400TRIAC4O502K
	1000	120/277/347	4.25 x 5.75	1130-598-502K	M1000TRIAC5M502K
Pulse Start Metal Halide	1500	120/277/347	4.25 x 5.75	1130-599-502K	M1500TRIAC5M502K
	35	120/277/347	3 x 4	New	M35TRILC3M502K
	50	120/277/347	3 x 4	New	M50TRILC3M502K
	70	120/277/347	3 x 4	11310-604-502K	M70TRILC3M502K
	100	120/277/347	3 x 4	11310-584-502K	M100TRILC3M502K
	150	120/277/347	3 x 4	11310-590-502K	M150TRILC3M502K
	175	120/277/347	3 x 4	New	P175TRIAC3M502K
	200	120/277/347	3 x 4	New	P200TRIAC3M502K
	250	120/277/347	4.25 x 4.75	New	P250TRIAC4M502K
	320	120/277/347	4.25 x 4.75	New	P320TRIAC4M502K
	350	120/277/347	4.25 x 4.75	New	P350TRIAC4M502K
	400	120/277/347	4.25 x 4.75	New	P400TRIAC4M502K
	750	120/277/347	4.25 x 5.75	New	P750TRIAC5M502K
H.P.S.	70	120/277/347	3 x 4	12310-579-502K	S70TRILC3M502K
	100	120/277/347	3 x 4	12310-584-502K	S100TRILC3M502K
	150	120/277/347	3 x 4	12310-588-502K	S150TRILC3M502K
	200	120/277/347	4.25 x 4.75	-	S200TRILC4M502K
	250	120/277/347	4.25 x 4.75	1230-593S-502K	S250TRIAC4M502K
	400	120/277/347	4.25 x 4.75	1230-595U-502K	S400TRIAC4M502K
	400	120/277/347	4.25 x 5.75	1230-595S-502K	S400TRIAC5M502K
	1000	120/277/347	4.25 x 5.75	1230-598S-502K	S1000TRIAC5M502K

HID CORE & COIL BALLASTS
METAL HALIDE

- 60 Hz
- Minimum starting temperature: -30° C
- Normal and High Power Factor models available

Input Volts	Catalog* Number	Circuit Type	Watts Input	Max Input Current	Nom Open Circuit Voltage	Fuse Rating	Wir Dia	Ref Dwg	Dimensions			Capacitor				Total Weight (lbs.)	Ignitor		UL Bench Top Rise		
									A	B	µF	Min Volt	Dry Film Dia	Ht	Oil Filled Oval		Ht	Catalog Number		Max Distance to lamp (ft)	
(1) 175 WATT M57, M107 METAL HALIDE LAMP																					
120 or 277 or 347	M175TRIAC30	CWA	211	2.15	305	2	3	PC1	2.45	3.75	10	400	1.65	3.82	1.56x2.69	2.7	6.8	n/a	n/a	C	
				0.75																	2
120 or 208 or 240 or 277				M175MLTAC3M																	CWA
	1.10	3																			
	0.95	3																			
	0.85	2																			
120 or 208 or 240 or 277 or 480	M175ML5AC3M	CWA	208	1.90	300	3	2	PC1	2.3	3.60	10	400	1.65	2.83	1.56x2.69	2.7	6.75	n/a	n/a	B	
				1.10																	5
				0.95																	3
				0.85																	3
480	M17548TAC3M	CWA	210	0.51	315	2	4	PC1	2.0	3.3	10	400	1.65	2.83	1.56x2.69	2.7	5.6	n/a	n/a	D	
(1) 250 WATT M58 METAL HALIDE LAMP - 4" Frame																					
120 or 277 or 347	M250TRIAC3M	CWA	295	2.8	320	3	3	PC1	3.0	4.35	15	400	1.65	3.82	1.91x2.91	2.7	8.0	n/a	n/a	B D D	
				1.20																	3
				0.95																	3
120 or 208 or 240 or 277	M250MLTAC3M	CWA	297	2.60	315	5	1	PC1	3.0	4.25	15	400	1.65	3.82	1.91x2.91	2.7	9.0	n/a	n/a	D	
				1.50																	4
				1.30																	3
				1.10																	3
120 or 208 or 240 or 277 or 480	M250ML5AC3M	CWA	295	2.50	285	4	2	PC1	3.0	4.5	15	400	1.65	3.82	1.91x2.91	2.7	9.2	n/a	n/a	A A B C B	
				1.40																	5
				1.25																	3
				1.10																	3
				0.65																	2
480	M25048TAC3M	CWA	292	0.64	320	2	4	PC1	3.0	4.3	15	400	1.65	3.82	1.91x2.91	2.7	9.0	n/a	n/a	D	

³ Capacitors are available as an option for high power factor operation.

See page 4-19 for Reference Drawings and Wiring Diagrams.

HID CORE & COIL BALLASTS

METAL HALIDE

- 60 Hz
- Minimum starting temperature: -30° C
- High Power Factor models available
- Feature CWA design

MH
250-400
WATT

Input Volts	Catalog* Number	Circuit Type	Watts Input	Max Input Current	Nom Open Circuit Voltage	Fuse Rating	Wir Dia	Dimensions			Capacitor				Total Weight (lbs.)	Ignitor		UL Bench Top Rise		
								Ref Dwg	A	B	µF	Min Volt	Dry Film Dia	Ht		Oil Filled Oval	Ht		Catalog Number	Max Distance to lamp (ft)
(1) 250 WATT M58 METAL HALIDE LAMP - 4.75" Frame																				
120 or	M250MLTAC4M	CWA	290	2.40	310	8	1	PC2	3.35	3.53	15	400	1.65	3.82	1.91x2.91	2.7	8.0	n/a	n/a	B
208 or				1.40		5														
240 or				1.20		4														
277				1.05		4														
120 or	M250ML5AC4M	CWA	290	2.42	300	8	2	PC2	1.82	3.62	15	360	1.65	3.82	1.91x2.91	2.7	10.8	n/a	n/a	A
208 or				1.40		5														
240 or				1.20		4														
277 or				1.00		3														
480				0.60		2														
(1) 400 WATT M59 METAL HALIDE LAMP																				
120	M400120AC4M	CWA	454	4.00	300	10	5	PC2	2.0	3.86	24	360	1.85	3.82	1.91x2.91	3.1	9.3	n/a	n/a	E
120 or	M400TRIAC4M	CWA	455	3.80	297	10	3	PC2	2.00	3.90	24	360	1.85	3.82	1.91x2.91	3.1	10.5	n/a	n/a	D
277 or				1.50		5														
347				1.30		5														
120 or				4.00		10														
208 or	M400MLTAC4M	CWA	458	2.30	300	8	1	PC2	2.0	3.86	24	360	1.85	3.82	1.91x2.91	3.1	10.0	n/a	n/a	E
240 or				2.00		5														
277				1.70		5														
120 or				4.00		10														
208 or				2.30		8														
240 or	M400ML5AC4M	CWA	458	2.00	300	5	2	PC2	2.0	3.86	24	360	1.85	3.82	1.91x2.91	3.1	11.0	n/a	n/a	E
277 or	M40048TAC4M	CWA	458	1.70	300	5	3	PC2	2.0	3.9	24	360	1.85	3.82	1.91x2.91	3.1	11.0	n/a	n/a	E
480				1.00		50														

See page 4-19 for Reference Drawings and Wiring Diagrams.

Input Volts	Catalog Number	Circuit Type	Watts Input	Max Input Current	Nom Open Circuit Voltage	Fuse Rating	Wir Dia	Dimensions			Capacitor				Total Weight (lbs.)	Ignitor		UL Bench Top Rise		
								Ref Dwg	A	B	Min Volt	Dry Film		Oil Filled		Catalog Number	Max Distance to lamp (ft)			
(1) 1000 WATT M47 METAL HALIDE LAMP																				
120	M1000120AC5M	CWA	1080	9.00	425	23	5	PC3	2.9	4.75	24	480	n/a	n/a	1.91x2.91	3.9	18.0	n/a	n/a	D
120 or 277 or 347	M1000TRIAC5M	CWA	1080	9.00 3.90 3.20	435	20 10 8														D D E
120 or 208 or 240 or 277	M1000MLTAC5M	CWA	1080	8.95 5.15 4.50 3.90	425	20 15 10 10	1	PC3	2.9	5.05	24	480	n/a	n/a	1.91x2.91	3.9	22.0	n/a	n/a	D
120 or 208 or 240 or 277 or 480	M1000ML5AC5M	CWA	1080	9.15 5.25 4.55 3.95 2.30	420	20 15 10 10 6	3	PC3	2.9	5.05	24	480	n/a	n/a	1.91x2.91	3.9	22.0	n/a	n/a	F E E E E
480	M100048TAC5M	CWA	1080	2.30	410	6	4	PC3	2.85	4.75	24	480	n/a	n/a	1.91x2.91	3.9	22.0	n/a	n/a	D
(1) 1050 WATT METAL HALIDE LAMP																				
120	M105020AC5M	CWA	1130	9.40	440	25	5	PC3	3.1	4.95	24	480	n/a	n/a	1.91x2.91	3.9	20.0	n/a	n/a	D
120	M1050120AN4M	CWA	1130	9.40	420	25	5	PC2	3.35	5.25	24	480	n/a	n/a	1.91x2.91	3.9	19.0	n/a	n/a	A*
(1) 1250 WATT M180 METAL HALIDE LAMP																				
120 or 240	M125024DAC5M	CWA	1360	11.50 5.75	435	30 15	19	PC3	4.15	6.10	30	480	n/a	n/a	1.91x2.91	3.9	27.0	n/a	n/a	D B
(1) 1500 WATT M48 METAL HALIDE LAMP																				
120 or 277 or 347	M1500TRIAC5M	CWA	1610	13.70 6.00 4.70	460	40 20 15	2	PC3	4.38	6.38	32	525	n/a	n/a	1.96x3.65	3.88	29.5	n/a	n/a	G
120 or 208 or 240 or 277	M1500MLTAC5M	CWA	1615	14.30 8.30 7.20 6.20	455	40 25 20 20	1	PC3	4.4	6.4	32	525	n/a	n/a	1.96x3.65	3.88	30.0	n/a	n/a	F G F E
480 or 208 or 240 or 277 or 480	M150048TAC5M	CWA	1620	3.50 7.90 7.00 6.00 3.50	445	10 25 20 18 10	4	PC3	4.4	6.4	32	525	n/a	n/a	1.96x3.65	3.88	30.0	n/a	n/a	E G E G G
208 or 240 or 277 or 480	M1650MLHAC5M	CWA	1765	8.75 7.60 6.60 3.80	480	25 20 18 10	16	PC3	4.50	6.60	34	550	n/a	n/a	1.96x3.65	3.75	32	n/a	n/a	F F F G

* Insulation Class 200 (N)

See page 4-19 for Reference Drawings and Wiring Diagrams.

HID CORE & COIL BALLASTS

METAL HALIDE

MH

Description of popular ballast modifications (Fields 8 and 9 see p. 4-10)	
000	Core & Coil ballast only (no bracket, no capacitor)
200	Core & Coil ballast with welded bracket and without capacitor
500	Core & Coil ballast with standard capacitor, no bracket
500K	Core & Coil ballast distributor replacement kit with capacitor and adjustable mounting brackets
502K	Core & Coil ballast distributor replacement kit with capacitor and adjustable mounting brackets plus capacitor boot. Available for tri-volt products for Canadian market
518	Core & Coil ballast with dry capacitor, no bracket
700	Core & Coil ballast with standard capacitor, and welded bracket
718	Core & Coil ballast with dry capacitor, and welded bracket

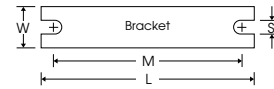

Ref. Dwg.	L	W	M	S
PC1	5.25"	1.25"	4.60"	0.25"
PC2	7.75"	2.75"	6.10"	0.25"
PC3	7.75"	2.75"	6.10"	0.25"

See p. 4-6 for adjustable mounting brackets and detailed bracket drawings.

REFERENCE DRAWING PC1

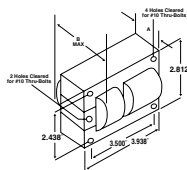

REFERENCE DRAWING PC2

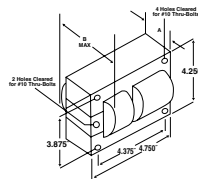

REFERENCE DRAWING PC3

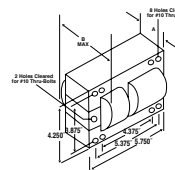

WIRING DIAGRAMS

Wiring Diagram 1

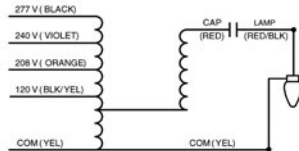

Wiring Diagram 2

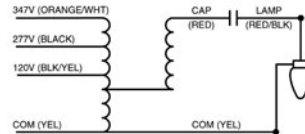

Wiring Diagram 3

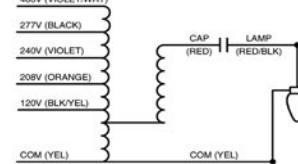

Wiring Diagram 4

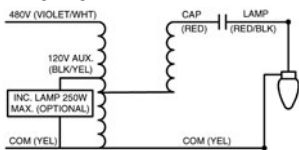

Wiring Diagram 5

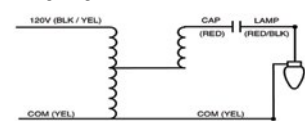

Wiring Diagram 6

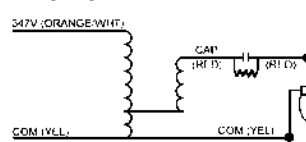

Wiring Diagram 16

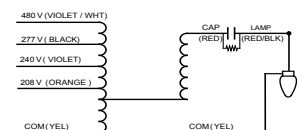

Note: Nominal dimensions provided above
Contact Universal for drawings and/or tolerances

Wiring Diagram 19

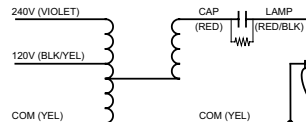

HID
CORE & COIL

**HID CORE & COIL BALLASTS
PULSE START METAL HALIDE**

- 60 Hz
- Minimum starting temperature: -30° C

Input Volts	Catalog Number	Circuit Type	Watts Input	Max Input Current	Nom Open Circuit Voltage	Fuse Rating	Wir Dia	Dimensions			Capacitor				Total Weight (lbs.)	Ignitor				
								Ref Dwg	A	B	µF	Min Volt	Dry Film Dia	Ht		Oil Filled Oval	Ht	Catalog Number	Max Distance to lamp (ft)	UL Bench Top Rise
(1) 35/39 WATT M130 METAL HALIDE LAMP																				
120 or 277 or 347	M35TRILC3M	HX-HPF	54	.84 .40 .30	235	1	9	PC1	0.85	2.15	5	300	1.26	2.36	1.31x2.16	2.2	1.7	MH100-3A	5	A
120 or 208 or 240 or 277	M35MLTLC3M	HX-HPF	50	.82 .48 .42 .36	230	1	10	PC1	0.85	2.0	5	277	1.26	2.83	1.31x2.16	2.2	1.7	MH100-3A	5	A
(1) 50 WATT M110 METAL HALIDE LAMP — Medium Base																				
120 or 277 or 347	M50TRILC3M*	HX-HPF	65	1.25 0.55 0.45	250	2	9	PC1	1.05	2.40	6	280	1.26	2.83	1.31x2.16	2.2	4.25	MH100-3A	10	A
120 or 208 or 240 or 277	M50MLTLC3M*	HX-HPF	65	1.25 0.70 0.60 0.55	255	3	10	PC1	1.05	2.40	6	280	1.26	2.83	1.31x2.16	2.2	3.6	MH100-3A	10	A
(1) 70 WATT M98 / M143 (C98) METAL HALIDE LAMP - Medium Base																				
120 or 277 or 347	M70TRILC3E*	HX-HPF	89	1.75 0.75 0.60	260	2	9	PC1	1.5	2.65	8	280	1.65	2.83	1.31x2.16	2.2	5.0	MH100-3A	10	A A A
120 or 277 or 347	M70TRILC3M	HX-HPF	91	1.85 0.80 0.65	260	2	9	PC1	1.5	2.65	8	280	1.65	2.83	1.31x2.16	2.2	5.0	MH100-3A	10	A
120 or 208 or 240 or 277	M70MLTLC3E*	HX-HPF	89	1.70 1.00 0.85 0.75	255	3	10	PC1	1.30	2.65	8	280	1.65	2.83	1.31x2.16	2.2	4.5	MH100-3A	10	A A A B
120 or 208 or 240 or 277	M70MLTLC3M	HX-HPF	90	1.70 1.00 0.85 0.75	255	3	10	PC1	1.30	2.65	8	280	1.65	2.83	1.31x2.16	2.2	4.5	MH100-3A	10	A
480	M7048TLC3E*	HX-HPF	91	0.45	260	1	8	PC1	1.35	2.80	8	300	1.65	2.83	1.31x2.16	2.2	4.2	MH100-3A	10	C
480	M7048TLC3M	HX-HPF	95	0.45	260	1	8	PC1	1.35	2.80	8	300	1.65	2.83	1.31x2.16	2.2	4.2	MH100-3A	10	E
(1) 70 WATT M85 METAL HALIDE LAMP - Double Ended																				
120 or 208 or 240 or 277	M70MLTLC3D	HX-HPF	90	1.70 1.00 0.85 0.75	255	3	10	PC1	1.30	2.65	8	280	1.65	2.83	1.31x2.16	4.5	4.25	MH70-3B	10	A
(1) 100 WATT M90 / M92 / M140 METAL HALIDE LAMP - Medium Base																				
120 or 277 or 347	M100TRILC3E*	HX-HPF	124	2.60 1.15 0.90	265	3	9	PC1	1.6	2.95	12	280	1.65	2.83	1.31x2.16	3.13	5.5	MH100-3A	10	A A A
120 or 277 or 347	M100TRILC3M	HX-HPF	129	2.60 1.15 0.90	265	3	9	PC1	1.6	2.95	12	280	1.65	2.83	1.31x2.16	3.13	5.5	MH100-3A	10	A
120 or 208 or 240 or 277	M100MLTLC3E*	HX-HPF	124	2.60 1.55 1.30 1.15	260	5	10	PC1	1.5	2.8	12	280	1.65	2.83	1.31x2.16	n/a	4.5	MH100-3A	10	C C B B
120 or 208 or 240 or 277	M100MLTLC30	HX-HPF	127	2.60 1.55 1.30	260	5	10	PC1	1.5	2.8	12	280	1.65	2.83	1.31x2.16	n/a	4.5	MH100-3A	10	C C B
277	M10048TLC3M*	HX-HPF	127	1.15	285	4	8	PC1	1.7	3.0	10	300	1.65	2.83	1.31x2.16	2.7	5.5	MH100-3A	10	B
480	M10048TLC3M*	HX-HPF	127	0.60	285	2	8	PC1	1.7	3.0	10	300	1.65	2.83	1.31x2.16	2.7	5.5	MH100-3A	10	C

* Meets DOE requirements for metal halide lighting fixtures and CSA C863-16 efficiency requirements for metal halide ballasts

See page 4-26 for Reference Drawings and Wiring Diagrams.

HID CORE & COIL BALLASTS

PULSE START METAL HALIDE

- 60 Hz
- Minimum Starting Temperature: -30° C

**PULSE START
MH
150-175 WATT**

Input Volts	Catalog Number	Circuit Type	Watts Input	Max Input Current	Nom Open Circuit Voltage	Fuse Rating	Wir Dia	Dimensions			Capacitor				Total Weight (lbs.)	Ignitor					
								Ref Dwg	A	B	µF	Min Volt	Dry Film			Oil Filled		Catalog Number	Max Distance to lamp (ft)	UL Bench Top Rise	
(1) 150 WATT M102/M142 METAL HALIDE LAMP - Medium Base																					
120 or 277 or 347	M150TRILC3E*	HX-HPF	182	3.35	250	10	9	PC1	2.38	3.65	16	280	1.65	2.83	1.56x2.69	2.7	7.25	MH100-3A	10	C	
				1.45		4															D
				1.15		3															C
120 or 277 or 347	M150TRILC3M	HX-HPF	185	3.32	245	10	9	PC1	2.38	3.65	16	280	1.65	2.83	1.56x2.69	2.7	7.25	MH100-3A	10	D	
				1.48		4															
120 or 208 or 240 or 277	M150MLTLC3M	HX-HPF	185	3.40	260	10	10	PC1	2.38	3.7	16	280	1.65	2.83	1.56x2.69	2.7	7.0	MH100-3A	10	A	
				1.93		5															
				1.70		5															
120 or 208 or 240 or 277	M150MLTAC3M	CWA	188	1.60	210	4	1	PC1	2.5	3.75	16	330	1.65	3.82	n/a	n/a	7.1	MH150-1A	10	C	
				1.00		3															D
				0.80		3															C
480	M15048TLC3M	HX-HPF	187	1.00	260	3	8	PC1	2.3	3.6	16	280	1.65	2.83	1.56x2.69	2.7	7.0	MH100-3A	10	F	
				3.40		10															
120 or 208 or 240 or 277	M150MLTLC3E*	HX-HPF	182	1.93	260	5	10	PC1	2.38	3.7	16	280	1.65	2.83	1.56x2.69	2.7	7.0	MH100-3A	10	A	
				1.70		5															
				1.50		4															
120 or 208 or 240 or 277	M150MLTAC3E*	CWA	182	1.60	210	4	1	PC1	2.5	3.75	16	330	1.65	3.82	n/a	n/a	7.1	MH150-1A	10	C	
				1.00		3															D
				0.80		3															C
480	M15048TLC3E*	HX-HPF	185	1.00	260	3	8	PC1	2.3	3.6	16	280	1.65	2.83	1.56x2.69	2.7	7.0	MH100-3A	10	C	
				0.70		2															C
(1) 150 WATT M81 METAL HALIDE LAMP - Double Ended																					
120 or 208 or 240 or 277	M150MLTLC3D	HX-HPF	185	3.40	260	10	10	PC1	2.38	3.70	16	280	1.65	2.83	1.56x2.69	2.7	7.0	MH70-3B	10	A	
				1.95		5															
				1.70		5															
				1.50		4															
(1) 175 WATT M152 / M137 METAL HALIDE PULSE START LAMP (4" FRAME)																					
120 or 208 or 240 or 277	P175MLTAC3M	CWA	208	2.09	306	5	1	PC1	2.5	3.6	10	400	1.65	2.83	1.31x2.16	3.9	6.75	MH350-1A	10	A	
				1.26		3															
				1.02		3															
				0.96		2															
120 or 208 or 240 or 277	P175MLTAC3L*	CWA	198	1.95	285	5	1	PC1	3.10	4.20	11	370	1.65	2.83	n/a	n/a	8.5	MH350-1A	2	A	
				1.10		3															
				1.00		3															
120 or 208 or 240 or 277 or 480	P175ML5AC3M	CWA	210	1.80	295	5	4	PC1	2.65	4.0	10	400	1.65	2.83	1.91x2.91	2.7	8.0	MH350-1A	10	B	
				1.05		3															
				0.90		3															
				0.80		2															
480	P17548TAC4L*	CWA	198	0.45	285	2	4	PC1	3.10	4.20	11	360	1.65	2.83	n/a	n/a	8.5	MH350-1A	10	A	
				0.50		2															

* Meets DOE requirements for metal halide lighting fixtures and CSA C863-16 efficiency requirements for metal halide ballasts

See page 4-26 for Reference Drawings and Wiring Diagrams.

HID
CORE & COIL

**HID CORE & COIL BALLASTS
PULSE START METAL HALIDE**

- 60 Hz
- Minimum Starting Temperature: -30° C

Input Volts	Catalog Number	Circuit Type	Watts Input	Max Input Current	Nom Open Circuit Voltage	Fuse Rating	Wir Dia	Dimensions			Capacitor				Total Weight (lbs.)	Ignitor		UL Bench Top Rise			
								Ref Dwg	A	B	µF	Min Volt	Dry Film			Oil Filled			Catalog Number	Max Distance to lamp (ft)	
(1) 175 WATT M152 / M137 METAL HALIDE PULSE START LAMP (4.75" FRAME)																					
120 or 208 or 240 or 277	P175MLTAC40*	CWA	190	1.75	280	3	1	PC2	1.65	3.40	11	360	1.65	2.83	n/a	n/a	10	MH350-1A	10	A	
				0.50																	3
				0.75																	2
				1.70																	5
120 or 208 or 240 or 277	P175MLTAC4L*	CWA	198	0.95	270	3	1	PC2	1.77	3.30	12.5	330	1.65	2.83	n/a	n/a	9.5	MH350-1A	10	A	
				0/85																	3
				0.75																	2
				1.80																	5
120 or 208 or 240 or 277 or	P175ML5AC3E*	CWA	198	1.05	275	3	4	PC2	2.05	3.90	12.5	330	1.65	2.83	n/a	n/a	11	MH350-1A	10	A	
				0.90																	3
				0.75																	2
				1.80																	5
480	P17548TAC4E*	CWA	198	0.45	275	2	4	PC2	1.80	3.50	12.5	330	1.65	2.83	n/a	n/a	9.6	MH350-1A	10	A	
(1) 200 WATT M136 METAL HALIDE PULSE START LAMP																					
120 or 208 or 240 or 277	P200MLTAC3L*	CWA	227	2.10	245	4	1	PC1	2.90	4.25	15	330	1.85	3.82	n/a	n/a	9.0	MH100-5A	10	A	
				1.22																	5
				1.05																	4
				0.95																	4
120 or 208 or 240 or 277 or 480	P200ML5AC3M	CWA	233	2.66	303	3	2	PC1	2.75	4.30	11	400	1.65	2.83	n/a	n/a	8.0	MH350-1A	10	C	
				1.52																	4
				1.31																	3
				1.12																	3
				0.68																	2
(1) 250 WATT M153 METAL HALIDE PULSE START LAMP																					
120or 277or 347	P250TRIAC4E*	CWA	281	2.45	305	3	3	PC2	1.36	3.30	14	400	1.65	3.82	1.45x2.27	3.19	9.0	MH350-1A	10	A	
				1.05																	3
				0.85																	3
120 or 208 or 240 or 277	P250MLTAC4L	CWA	283	2.40	270	5	1	PC2	2.05	3.90	17	330	1.65	3.82	n/a	n/a	11.0	MH350-1A	15	A	
				1.40																	5
				1.20																	5
				1.05																	3
120 or 208 or 240 or 277 or 480	P250ML5AC4L	CWA	283	2.50	270	5	2	PC2	1.85	3.75	17	330	1.65	3.82	n/a	n/a	10.5	MH350-1A	10	A	
				1.40																	5
				1.25																	3
				1.05																	3
				0.60																	2
120 or 208 or 240 or 277	P250MLTAC4E*	CWA	281	2.40	270	5	1	PC2	2.05	3.90	17	330	1.65	3.82	n/a	n/a	11.0	MH350-1A	15	A	
				1.40																	5
				1.20																	5
				1.05																	3
120 or 208 or 240 or 277 or 480	P250ML5AC4E*	CWA	281	2.40	270	5	2	PC2	1.85	3.75	17	330	1.65	3.82	n/a	n/a	11.0	MH350-1A	10	A	
				1.35																	5
				1.20																	3
				1.00																	3
				0.60																	2
480	P25048TAC4L*	CWA	283	0.60	275	2	4	PC2	1.9	3.6	17	360	1.65	3.82	n/a	n/a	10.0	MH350-1A	10	A	

* Meets DOE requirements for metal halide lighting fixtures and CSA C863-16 efficiency requirements for metal halide ballasts

See page 4-26 for Reference Drawings and Wiring Diagrams.

HID CORE & COIL BALLASTS

PULSE START METAL HALIDE

- 60 Hz
- Minimum Starting Temperature: -30° C

**PULSE START
MH
320-350 WATT**

Input Volts	Catalog Number	Circuit Type	Watts Input	Max Input Current	Nom Open Circuit Voltage	Fuse Rating	Wir Dia	Dimensions			Capacitor				Total Weight (lbs.)	Ignitor		UL Bench Top Rise		
								Ref Dwg	A	B	µF	Min Volt	Dry Film			Oil Filled			Catalog Number	Max Distance to lamp (ft)
(1) 320 WATT M132 / M154 METAL HALIDE PULSE START LAMP																				
277	P320277RCEM*	RX-NPF RX-HPF	348	3.70 2.34	277	10	7	5	1.5	3.28	22.5	280	n/a 1.865	n/a 3.115	n/a n/a	n/a n/a	6.8	MH350-1A	10	A
120 or 277 or 347	P320TRIC4E*	CWA	356	3.75 1.65	290	10 5	3	PC2	2.0	3.90	20.5	360	1.85	3.82	1.91x2.91	3.25	11.0	MH350-1A	10	A A
120 or 208 or 240 or 277				P320MLTAC40		CWA														364
120 or 208 or 240 or 277 or 480	P320ML5AC4M	CWA	370	4.00 2.40	280	10 7	2	PC2	2.0	3.86	20.5	360	1.8	3.82	1.91x2.91	3.6	11.3	MH350-1A	10	D C D D C
120 or 208 or 240 or 277 or 480				P320MLTAC4E*		CWA														356
120 or 208 or 240 or 277 or 480	P320ML5AC4E*	CWA	357	3.10 1.80	275	8 5	2	PC2	1.88	3.80	21.0	360	1.85	3.82	1.91x2.91	3.6	12.0	MH350-1A	10	A
120 or 208 or 240 or 277 or 480				P320ML5AC4L		CWA														363
480	P32048TAC4L*	CWA	361	0.80	280	3	4	PC2	2.0	3.9	21	360	1.85	3.82	2.91	3.13	11.0	MH350-1A	10	A
(1) 350 WATT M131 METAL HALIDE PULSE START LAMP																				
120 or 277 or 347	P350TRIC4E*	CWA	389	3.75 1.65	290	10 5	3	PC2	2.00	4.00	21.0	360	1.85	3.82	1.51x2.51	3.25	11.5	MH350-1A	10	A A A
120 or 208 or 240 or 277				P350MLTAC4M		CWA														400
120 or 208 or 240 or 277 or 480	P350ML5AC40	CWA	397	1.70 1.45	280	5 4	4	PC2	2.2	4.25	22.5	345	1.85	3.82	n/a	n/a	12	MH350-1A	10	B
120 or 208 or 240 or 277 or 480				P350ML5AC4L		CWA														397
120 or 208 or 240 or 277 or 480	P350ML5AC4M	CWA	405	0.85 2.49	275	10 7	2	PC2	2.0	3.86	21.0	400	1.85	3.82	n/a	n/a	11.3	MH350-1A	10	D
480				P35048TAC4L		CWA														397
120 or 208 or 240 or 277 or 480	P350MLTAC4E*	CWA	389	3.25 1.80	270	9 6	1	PC2	1.92	3.95	22.5	345	1.85	3.82	n/a	n/a	11.0	MH350-1A	10	A
480				P35048TAC4E*		CWA														393

* Meets DOE requirements for metal halide lighting fixtures and CSA C863-16 efficiency requirements for metal halide ballasts

See page 4-26 for Reference Drawings and Wiring Diagrams.

**HID CORE & COIL BALLASTS
PULSE START METAL HALIDE**

- 60 Hz
- Minimum Starting Temperature: -30° C

Input Volts	Catalog Number	Circuit Type	Watts Input	Max Input Current	Nom Open Circuit Voltage	Fuse Rating	Wir Dia	Dimensions			Capacitor				Total Weight (lbs.)	Ignitor		UL Bench Top Rise		
								Ref Dwg	A	B	µF	Min Volt	Dry Film			Oil Filled			Catalog Number	Max Distance to lamp (ft)
(1) 400 WATT M155 / M135 / M128 / M172 METAL HALIDE PULSE START LAMP																				
120 or	P400TRIAC4E*	CWA	442	3.70	295	5	3	PC2	2.0	3.9	24	400	1.85	3.82	1.19x2.91	3.1	12	MH350-1A	10	A
277 or				1.60																A
347				1.30																A
120 or	P400TRIAC4M	CWA	454	4.05	285	5	3	PC2	2.0	3.9	24	400	1.85	3.82	1.91x2.91	3.1	12	MH350-1A	10	D
277 or				1.75																
347				1.40																
120 or	P400MLTAC4L	CWA	454	3.90	280	7	1	PC2	2.30	4.20	26	330	1.85	3.82	n/a	n/a	11	MH350-1A	10	B
208 or				2.25																B
240 or				1.95																B
277				1.70																C
120 or	P400ML5AC4M	CWA	457	3.90	285	5	26	PC2	2.0	3.9	24	400	1.85	3.82	1.91x2.91	3.1	12.5	MH350-1A	10	D
208 or				2.25																
240 or				1.95																
277 or				1.70																
480				0.95																
120 or	P400ML5AC4L	CWA	454	3.90	280	5	2	PC2	2.35	4.25	26	330	1.85	3.82	1.91x2.91	3.1	12	MH350-1A	10	C
208 or				2.25																D
240 or				1.90																C
277 or				1.65																C
480				0.95																D
480	P40048TAC4L	CWA	454	1.00	285	3	4	PC2	2.35	4.25	26	330	1.85	3.82	n/a	n/a	12.5	MH350-1A	10	D
120 or	P400MLTAC4E*	CWA	442	3.90	280	7	1	PC2	2.30	4.20	26	330	1.85	3.82	n/a	n/a	12	MH350-1A	10	A
208 or				2.25																
240 or				1.95																
277				1.70																
120 or	P400ML5AC4E*	CWA	442	3.80	280	5	2	PC2	2.35	4.25	26	330	1.85	3.82	n/a	n/a	12.5	MH350-1A	10	A
208 or				2.20																C
240 or				1.90																B
277 or				1.60																B
480				0.95																B
480	P40048TAC4E*	CWA	447	1.00	285	3	4	PC2	2.35	4.25	26	330	1.85	3.82	n/a	n/a	12.5	MH350-1A	10	B

* Meets DOE requirements for metal halide lighting fixtures and CSA C863-16 efficiency requirements for metal halide ballasts

See page 4-26 for Reference Drawings and Wiring Diagrams.

HID CORE & COIL BALLASTS

PULSE START METAL HALIDE

- 60 Hz
- Minimum Starting Temperature: -30° C

**PULSE START
MH
450-1000 WATT**

Input Volts	Catalog Number	Circuit Type	Watts Input	Max Input Current	Nom Open Circuit Voltage	Fuse Rating	Wir Dia	Dimensions			Capacitor				Total Weight (lbs.)	Ignitor		UL Bench Top Rise		
								Ref Dwg	A	B	µF	Min Volt	Dry Film Dia	Dry Film Ht		Oil Filled Oval	Oil Filled Ht		Catalog Number	Max Distance to lamp (ft)
(1) 450 WATT M144 METAL HALIDE PULSE START LAMP																				
120 or 208 or 240 or 277	P450MLTAC4L	CWA	508	4.35	280	10	1	PC2	2.25	4.00	26.5	400	1.85	4.76	n/a	n/a	13.0	MH350-1A	10	B
				2.55		8														C
				2.15		7														C
				1.90		5														C
120 or 208 or 240 or 277 or 480	P450ML5AC4M	CWA	510	4.44	305	12	2	PC2	2.66	4.66	26.5	400	1.85	4.76	1.91x2.91	3.9	12.0	MH350-1	10	C
				2.56		8														B
				2.38		7														C
				1.92		5														C
120 or 208 or 240 or 277	P450MLTAC4E*	CWA	496	4.35	280	10	1	PC2	2.25	4.00	26.5	400	1.85	4.76	n/a	n/a	14.0	MH350-1A	10	A
				2.55		8														
				2.15		7														
				1.90		5														
480	P45048TAC4E*	CWA	501	1.10	270	3	4	PC2	2.40	4.25	26.5	360	1.85	4.76	n/a	n/a	14.5	MH350-1A	10	D
(1) 750 WATT M149 METAL HALIDE PULSE START LAMP																				
120 or 277 or 347	P750TRIAC5M*	CWA	820	7.05	340	15	3	PC3	2.8	4.6	28	400	n/a	n/a	1.91x2.91	3.88	18.0	P750-1B	10	B
				3.05		8														C
				2.45		8														C
120 or 208 or 240 or 277	P750MLTAC5M*	CWA	825	7.10	340	18	1	PC3	2.8	4.8	28	400	n/a	n/a	1.91x2.91	3.88	18.0	P750-1B	10	D
				4.10		10														A
				3.55		10														B
				3.10		8														B
120 or 208 or 240 or 277 or 480	P750ML5AC5M*	CWA	820	6.95	340	18	2	PC3	2.8	4.9	28	400	n/a	n/a	1.91x2.91	3.88	19.0	P750-1B	15	C
				4.00		10														C
				3.50		10														D
				3.00		8														D
480	P75048TAC5M*	CWA	822	1.80	335	5	4	PC3	2.8	4.75	28	400	n/a	n/a	1.91x2.91	3.88	18.0	P750-1B	10	D
(1) 875 WATT M166 METAL HALIDE PULSE START LAMP																				
120 or 208 or 240 or 277	P875MLTAC5M*	CWA	945	7.90	395	20	1	PC3	2.8	4.8	24	480	n/a	n/a	1.91x2.91	3.9	17.5	HPS1000-4B	10	D
				4.55		15														C
				3.95		10														A
				3.45		10														C
(1) 1000 WATT M141 METAL HALIDE PULSE START LAMP																				
347 or 480	P1000483AC5M*	CWA	1068		425	8	23	PC3	2.85	5.00	24	480	n/a	n/a	1.91x2.91	3.9	23.0	HPS1000-4B	20	C
				6		D														
120 or 208 or 240 or 277	P1000MLTAC5M	CWA	1080	9.00	420	20	1	PC3	2.9	5.05	24	480	n/a	n/a	1.91x2.91	3.9	22.0	HPS1000-4B	20	D
				5.20		15														
				4.50		10														
				3.90		10														
120 or 208 or 240 or 277 or 480	P1000ML5AC5M	CWA	1080	8.95	420	20	2	PC3	2.9	5.05	24	480	n/a	n/a	1.91x2.91	3.9	22.0	HPS1000-4B	20	G
				5.15		15														B
				4.45		10														C
				3.85		10														C
480	P100048TAC5M*	CWA	1080	2.25	410	10														C
120 or 208 or 240 or 277	P1000MLTAC5E*	CWA	1068	2.30	420	6	4	PC3	2.85	4.75	24	480	n/a	n/a	1.91x2.91	3.9	18.0	HPS1000-4B	15	D2
				9.00		20														
				5.20		15														
				4.50		10														
120 or 208 or 240 or 277 or 480	P1000ML5AC5E*	CWA	1068	3.90	420	10	1	PC3	2.9	5.05	24	480	n/a	n/a	1.91x2.91	3.9	22.0	HPS1000-4B	20	D
				8.95		20														
				5.15		15														
				4.45		10														
120 or 208 or 240 or 277 or 480	P1000ML5AC5E*	CWA	1068	2.25	420	6	2	PC3	2.9	5.05	24	480	n/a	n/a	1.91x2.91	3.9	22.0	HPS1000-4B	20	G
				8.95		20														B
				5.15		15														C
				4.45		10														C
120 or 208 or 240 or 277 or 480	P1000ML5AC5E*	CWA	1068	3.85	420	10	2	PC3	2.9	5.05	24	480	n/a	n/a	1.91x2.91	3.9	22.0	HPS1000-4B	20	C
				3.85		10														C
				2.25		6														C
				2.25		6														C

* Meets DOE requirements for metal halide lighting fixtures and CSA C863-16 efficiency requirements for metal halide ballasts

See page 4-26 for Reference Drawings and Wiring Diagrams.

Description of popular ballast modifications (Fields 8 and 9 see p. 4-10)	
000	Core & Coil ballast only (no bracket, no capacitor)
200	Core & Coil ballast with welded bracket and without capacitor
500	Core & Coil ballast with standard capacitor, no bracket
500K	Core & Coil ballast distributor replacement kit with capacitor and adjustable mounting brackets
502K	Core & Coil ballast distributor replacement kit with capacitor and adjustable mounting brackets plus capacitor boot. Available for tri-volt products for Canadian market
518	Core & Coil ballast with dry capacitor, no bracket
700	Core & Coil ballast with standard capacitor, and welded bracket
718	Core & Coil ballast with dry capacitor, and welded bracket

REFERENCE DRAWING PC1

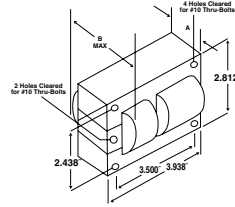

REFERENCE DRAWING PC2

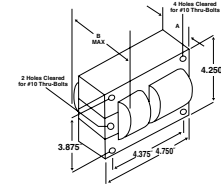

REFERENCE DRAWING PC3

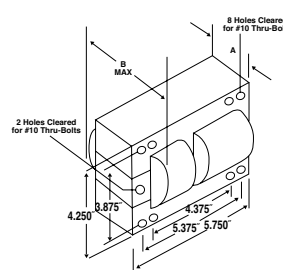

REFERENCE DRAWING 2

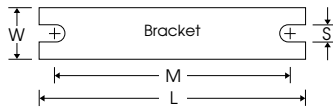
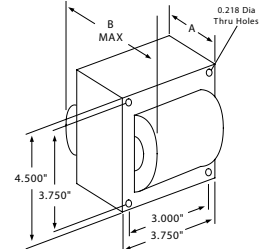

Ref. Dwg.	L	W	M	S
PC1	5.25"	1.25"	4.60"	0.25"
PC2	7.75"	1.25"	5.75"	0.25"
PC3	7.75"	2.75"	6.10"	0.25"
2	4.00"	0.75"	3.35"	0.25"

See p. 4-6 for adjustable mounting brackets and detailed bracket drawings.

WIRING DIAGRAMS

Wiring Diagram 1

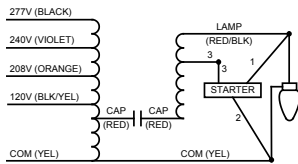

Wiring Diagram 2

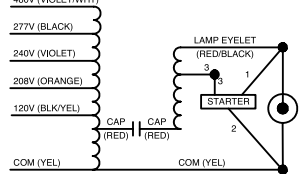

Wiring Diagram 3

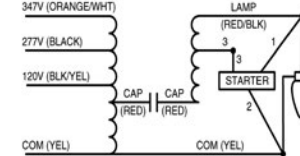

Wiring Diagram 4

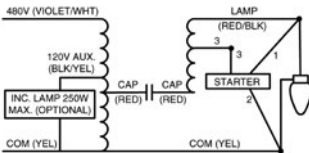

Wiring Diagram 7

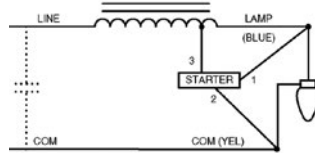

Wiring Diagram 8

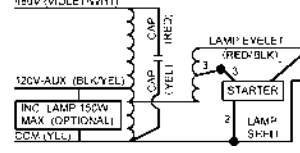

Wiring Diagram 10

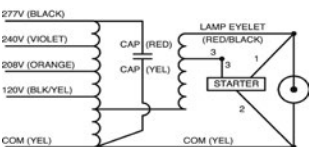

Wiring Diagram 9

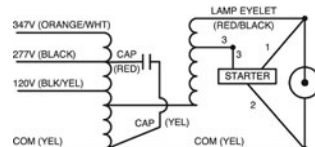

Wiring Diagram 23

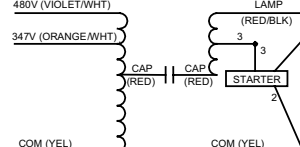

Note: Nominal dimensions provided above
Contact Universal for drawings and/or tolerances

HID CORE & COIL BALLASTS

HIGH PRESSURE SODIUM

- 60 Hz
- Minimum Starting Temperature: -40° C
- Normal and High Power Factor Models

HPS
35-100
WATT

Input Volts	Catalog* Number	Circuit Type	Watts Input	Max Input Current	Nom Open Circuit Voltage	Fuse Rating	Wir Dia	Dimensions			Capacitor				Total Weight (lbs.)	Ignitor		UL Bench Top Rise		
								Ref Dwg	A	B	µF	Min Volt	Dry Film			Oil Filled			Catalog Number	Max Distance to lamp (ft)
												Dia	Ht	Oval	Ht					
(1) 35 WATT S76 HIGH PRESSURE SODIUM LAMP																				
120 ¹	1233-251W♦	R-HPF ₃	43	0.65 1.15	120	2 3	11	1	0.63	2.0	14	120	1.87	2.25	1.56x2.69	2.7	1.5	HPS150-3A Permanently Attached	3	A
120	S35120RCEM	RX-NPF RX-HPF	44	0.85 0.65	120	2 3	7	5	0.55	1.75	14	220	1.87	2.25	1.9	2.3	1.2	HPS150-3A	10	A
(1) 50 WATT S68 HIGH PRESSURE SODIUM LAMP																				
120 ¹	1233-35W♦	R-HPF ₃	60	0.90 1.50	120	3 5	11	1	0.94	2.40	20	120	1.65	2.83	1.56x2.69	3.1	2.0	HPS150-3A Permanently Attached	3	A
120	S50120RCEM	RX-NPF RX-HPF	60	0.90 1.10	120	3 4	7	5	0.83	1.95	20	240	1.87	2.25	1.9	2.3	1.5	HPS150-3A	3	A
120 or 208 or 240 or 277	S50MLTLC3M	HX-HPF	66	1.24 0.60 0.52 0.45	130	5 3 3 2	10	PC1	1.3	2.7	5	300	1.2	2.2	2.2	2.2	4.1	HPS150-3A	5	A
(1) 70 WATT S62 HIGH PRESSURE SODIUM LAMP																				
120	1233-142W♦	R-HPF	83	1.30 2.10	120	8 8	11	1	1.32	2.7	2.8	120	1.65	4.75	n/a	n/a	2.5	HPS150-3A Permanently Attached	3	A
120	S70120RCEM	RX-NPF RX-HPF	82	1.30 2.10	120	4 6	7	5	1.10	2.25	28	120	1.87	2.25	1.3	2.7	2.0	HPS150-3A	3	A
120 or 277 or 347	S70TRILC3M	HX-HPF	94	1.50 0.65 0.50	120	4 2 2	9	PC1	1.38	2.7	7	280	1.65	2.83	1.31x2.16	2.2	4.4	HPS150-3A	10	B A A
120 or 208 or 240 or 277	S70MLTLC3M	HX-HPF	98	1.50 0.88 0.75 0.65	120	5 3 3 2	10	PC1	1.38	2.74	7	280	1.65	2.83	1.31x2.16	2.2	4.1	HPS150-3A	10	B
480	S7048TLC3M	HX-HPF	94	0.34	120	2	8	PC1	1.85	3.0	7	280	1.65	3.00	1.31x2.16	2.2	6.0	HPS150-3A	10	A
(1) 100 WATT S54 HIGH PRESSURE SODIUM LAMP																				
120 ¹	1233-10W♦	R-HPF ₃	114	1.80 2.90	120	5 8	11	1	1.5	2.9	40	120	1.87	2.78	1.87	2.9	2.8	HPS150-3A Permanently Attached	3	A
120	S100120RCEM	RX-NPF RX-HPF	115	2.90 1.80	120	8 5	7	5	1.50	2.75	40	120	1.87	2.78	1.8	2.7	2.0	HPS150-3A	10	A
120 or 277 or 347	S100TRILC3M	HX-HPF	130	2.20 0.95 0.69	120	8 3 2	9	PC1	2.0	3.5	10	330	1.2	2.7	1.31x2.16	2.7	5.9	HPS150-3A	10	B
120 or 208 or 240 or 277	S100MLTLC3M	HX-HPF	122	2.20 1.30 1.10 0.95	120	7 5 3 3	10	PC1	2.0	3.36	10	280	1.26	2.83	1.31x2.16	2.7	6.0	HPS150-3A	10	B
480	S10048TLC3M	HX-HPF	132	0.57	120	2	8	PC1	2.0	3.3	10	280	1.26	2.83	1.31x2.16	2.2	6.0	HPS150-3A	5	E

¹ Also can be used on a 277 volt line in conjunction with the step down transformers
³ Capacitors are available as an option for High Power Factor operation
♦ Ballast has built-in starter.

See pages 4-31 and 4-32 for Reference Drawings and Wiring Diagrams.

HID
CORE & COIL

HID CORE & COIL BALLASTS
HIGH PRESSURE SODIUM

- 60 Hz
- Minimum Starting Temperature: -40° C
- CWA, Normal and High Power Factor Models

Input Volts	Catalog* Number	Circuit Type	Watts Input	Max Input Current	Nom Open Circuit Voltage	Fuse Rating	Wir Dia	Dimensions			Capacitor				Total Weight (lbs.)	Ignitor		UL Bench Top Rise		
								Ref Dwg	A	B	µF	Min Volt	Dry Film			Oil Filled			Catalog Number	Max Distance to lamp (ft)
												Dia	Ht	Oval	Ht					
(1) 150 WATT S55 HIGH PRESSURE SODIUM LAMP																				
120 ¹	I233-154W	R-HPF ₃	170	2.35 4.40	120	6 12	11	1	2.0	3.4	52	240	1.85	3.82	2.12	2.9	3.5	HPS150-3A <small>Permanently Attached</small>	3	A
120	S150120RCEM	RX-NPF RX-HPF	170	2.35 4.40	120	12 6	7	5	2.0	3.05	50	120	1.87	n/a	2.0	2.9	3.25	HPS150-3A	3	A
120 or 277 or 347	S150TRILC3M	HX-HPF	188	3.00 1.35 1.00	120	10 5 4	9	PC1	2.38	3.68	14	300	1.6	2.8	1.56x2.69	2.7	7.0	HPS150-3A	10	B C B
120 or 208 or 240 or 277	S150MLTLC3O	HX-HPF	188	3.00 1.65 1.50 1.30	120	10 5 5 4	10	PC1	2.5	3.85	14	280	1.6	2.8	2.7	2.7	7.0	HPS150-3A	10	E D E D
480	S15048TLC3M	HX-HPF	189	0.72	120	2	8	PC1	3.0	4.5	14	280	1.6	2.83	1.56x2.69	2.7	8.75	HPS150-3A	10	D
(1) 200 WATT S66 HIGH PRESSURE SODIUM LAMP																				
120	S200TRIAC4M	CWA	240	2.00 0.86 0.68	184	7 3 3	3	PC2	1.45	3.25	28	280	1.65	4.76	1.91x2.91	3.1	8.65	HPS400-3A	10	C
120 or 208 or 240 or 277	S200MLTAC4M	CWA	240	2.10 1.20 1.00 0.88	175	7 4 4 4	1	PC2	1.2	3.0	28	280	1.65	4.76	1.91x2.91	3.1	8.5	HPS400-3A	10	B
480	S20048TAC4M	CWA	240	0.56	172	2	4	PC2	1.2	3.0	28	280	1.65	4.76	1.91x2.91	3.1	8.5	HPS400-3A	10	C
(1) 250 WATT S50 HIGH PRESSURE SODIUM LAMP																				
120 or 277 or 347	S250TRIAC4M	CWA	295	2.40 1.05 0.85	185	7 3 3	3	PC2	1.8	3.55	35	240	1.65	3.82	1.91x2.91	3.1	10	HPS400-3A	10	B B C
120 or 208 or 240 or 277	S250MLTAC4M	CWA	295	2.50 1.45 1.25 1.10	190	7 4 4 3	1	PC2	1.8	3.55	35	240	1.65	3.82	1.91x2.91	3.1	10	HPS400-3A	10	B
120 or 208 or 240 or 277 or 480	S250ML5AC4O	CWA	300	2.50 1.55 1.25 1.05 0.65	188	8 4 4 3 2	2	PC2	1.95	3.70	35	240	1.65	3.82	1.91x2.91	3.1	11	HPS400-3A	10	C C B B B
480	S25048TAC4M	CWA	298	0.65	190	2	4	PC2	1.85	3.65	35	240	1.65	3.82	1.91x2.91	3.1	10	HPS400-3A	5	A

* Ballast has built-in starter.

* Also can be used on a 277 volt line in conjunction with the step-down transformers described on page 5-53.

³ Capacitors are available as an option for high power factor operation.

See pages 4-31 and 4-32 for Reference Drawings and Wiring Diagrams.

HID CORE & COIL BALLASTS

HIGH PRESSURE SODIUM- FEATURING MULTI-5™

- 60 Hz
- Minimum Starting Temperature: -40° C
- CWA, Normal and High Power Factors Models Available

**HPS
400-430
WATT**

Input Volts	Catalog* Number	Circuit Type	Watts Input	Max Input Current	Nom Open Circuit Voltage	Fuse Rating	Wir Dia	Dimensions			Capacitor				Total Weight (lbs.)	Ignitor		UL Bench Top Rise			
								Ref Dwg	A	B	µF	Min Volt	Dry Film			Oil Filled			Catalog Number	Max Distance to lamp (ft)	
(1) 400 WATT S51 HIGH PRESSURE SODIUM LAMP - 4 3/8" Frame																					
120 or 277 or 347	S400TRIAC4M	CWA	465	3.95	190	10	3	PC2	2.32	4.1	55	240	1.77	3.74	1.91x2.91	3.5	14.0	HPS400-3A	10	D	
				1.70		5															4
				1.35		4															
120 or 208 or 240 or 277	S400MLTAC4M	CWA	463	3.80	190	10	1	PC2	2.32	4.1	55	240	1.77	3.74	1.91x2.91	3.5	14.0	HPS400-3A	10	D	
				2.20		6															
				1.90		5															
				1.90		5															
120 or 208 or 240 or 277 or 480	S400ML5AC4M	CWA	465	3.95	190	10	2	PC2	2.44	4.3	55	240	1.77	3.74	1.91x2.91	3.5	14.0	HPS400-3A	10	D	
				2.30		6															
				2.00		5															
				1.70		5															
				1.00		3															
480	S40048TAC4M	CWA	464	1.00	190	3	4	PC2	2.32	4.1	55	240	1.77	3.74	1.91x2.91	3.5	14.0	HPS400-3A	10	D	
(1) 400 WATT S51 HIGH PRESSURE SODIUM LAMP - 5 3/8" Frame																					
120 or 208 or 240 or 277	S400MLTAC5M	CWA	465	3.95	200	10	1	PC3	2.25	4.1	48	280	2.05	4.76	1.91x2.91	3.9	16.0	HPS400-3A	10	D	
				2.30		6															
				2.00		5															
				1.70		5															
120 or 208 or 240 or 277 or 480	S400ML5AC5M	CWA	468	4.00	200	10	2	PC3	2.5	4.5	48	300	2.05	4.76	1.91x2.91	3.9	17.5	HPS400-3A	10	D	
				2.30		6															
				2.00		5															
				1.75		5															
				1.00		3															
480	S40048TAC5M	CWA	467	1.00	200	3	4	PC3	2.25	4.1	48	280	2.05	4.76	1.91x2.91	3.9	16.0	HPS400-3A	10	D	

³ Capacitors are available as an option for high power factor operation.

**See pages 4-31 and 4-32 for
Reference Drawings and Wiring Diagrams.**

HID
CORE & COIL

HID CORE & COIL BALLASTS
HIGH PRESSURE SODIUM

- 60 Hz
- Minimum Starting Temperature: -40° C
- CWA models available

Input Volts	Catalog* Number	Circuit Type	Watts Input	Max Input Current	Nom Open Circuit Voltage	Fuse Rating	Wir Dia	Dimensions			Capacitor				Total Weight (lbs.)	Ignitor		UL Bench Top Rise		
								Ref Dwg	A	B	µF	Min Volt	Dry Film			Oil Filled			Catalog Number	Max Distance to lamp (ft)
(1) 600 WATT S106 HIGH PRESSURE SODIUM LAMP																				
120 or 208 or 240 or 277	S600MLTAC5M	CWA	640	5.10 3.10 2.70 2.35	240	20 15 10 10	1	PC3	3.0	5.0	55	300	1.8	4.7	1.91x2.91	3.9	21.0	HPS600-1B	10	A
(1) 1000 WATT S52 HIGH PRESSURE SODIUM LAMP																				
120 or 277 or 347	S1000TRIAC5M	CWA	1100	9.60 4.30 3.40	440	20 10 10	3	PC3	3.8	5.75	26	525	n/a	n/a	1.91x2.91	4.25	27.0	HPS1000-4B	15	D
120 or 208 or 240 or 277	S1000MLTAC5M	CWA	1100	9.50 5.50 4.80 4.20	440	24 15 12 10	1	PC3	3.8	5.7	26	525	n/a	n/a	1.91x2.91	4.25	26.0	HPS1000-4B	15	C
120 or 208 or 240 or 277 or 480	S1000ML5AC5M	CWA	1048	9.45 5.45 4.75 4.10 2.35	440	20 15 10 10 8	2	PC3	3.75	5.65	26	525	n/a	n/a	1.91x2.91	4.25	26.0	HPS1000-4B	15	D
480	S1000480AC5M	CWA	1100	2.45	440	8	4	PC3	3.8	5.7	26	525	n/a	n/a	1.91x2.91	4.25	25.0	HPS1000-4B	15	D
480	S100048TAC5M	CWA	1100	2.45	440	8	4	PC3	3.8	5.7	26	525	n/a	n/a	1.91x2.91	4.25	25.0	HPS1000-4B	15	D

See pages 4-31 and 4-32 for Reference Drawings and Wiring Diagrams.

HID CORE & COIL BALLASTS

HIGH PRESSURE SODIUM

HPS

Description of popular ballast modifications (Fields 8 and 9 see p. 4-10)	
000	Core & Coil ballast only (no bracket, no capacitor)
200	Core & Coil ballast with welded bracket and without capacitor
500	Core & Coil ballast with standard capacitor, no bracket
500K	Core & Coil ballast distributor replacement kit with capacitor and adjustable mounting brackets
502K	Core & Coil ballast distributor replacement kit with capacitor and adjustable mounting brackets plus capacitor boot. Available for tri-volt products for Canadian market
518	Core & Coil ballast with dry capacitor, no bracket
700	Core & Coil ballast with standard capacitor, and welded bracket
718	Core & Coil ballast with dry capacitor, and welded bracket

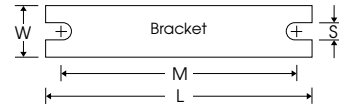

Ref. Dwg.	L	W	M	S
1, 1a, 5	4.00"	0.75"	3.35"	0.25"
PC1, 4	5.25"	1.25"	4.60"	0.25"
PC2, PC3	7.75"	1.25"	5.75"	0.25"

See p. 4-6 for adjustable mounting brackets and detailed bracket drawings.

REFERENCE DRAWING 1

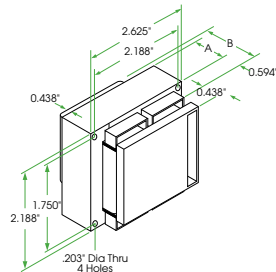

REFERENCE DRAWING 5

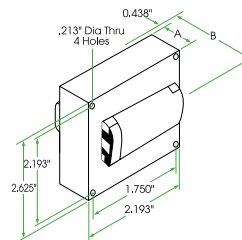

REFERENCE DRAWING PC1

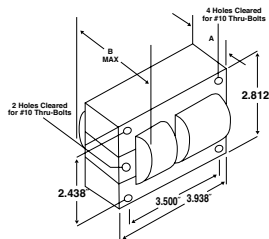

REFERENCE DRAWING PC2

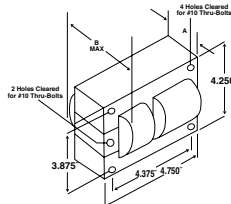

REFERENCE DRAWING PC3

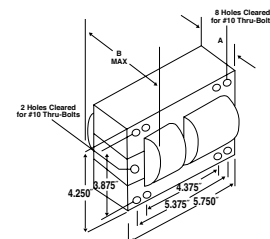

Note: Nominal dimensions provided above
Contact Universal for drawings and/or tolerances

WIRING DIAGRAMS

Wiring Diagram 1

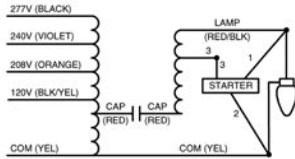

Wiring Diagram 7

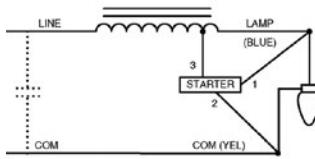

Wiring Diagram 11

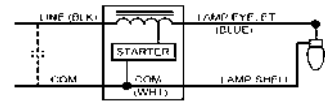

Wiring Diagram 2

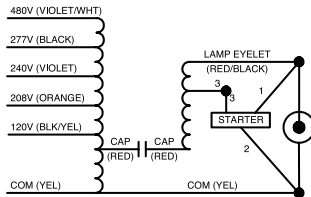

Wiring Diagram 8

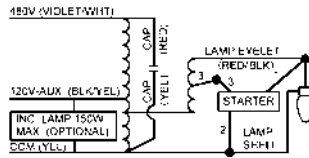

Wiring Diagram 12

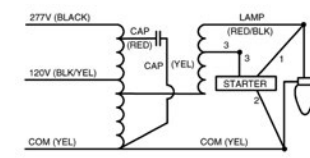

Wiring Diagram 3

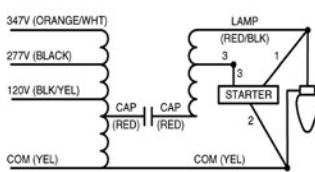

Wiring Diagram 9

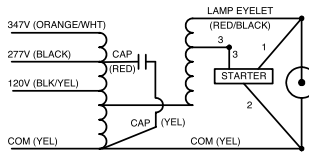

Wiring Diagram 13

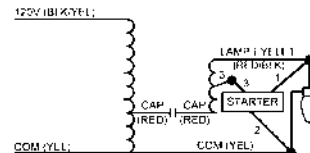

Wiring Diagram 4

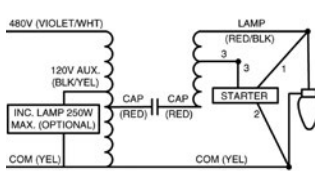

Wiring Diagram 10

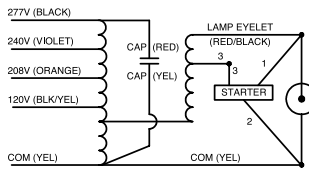

Wiring Diagram 14

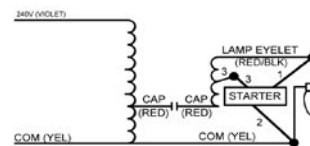

HID CORE & COIL BALLASTS

50 HERTZ

- 50 Hz
- Minimum Starting Temperature: -40° C
- CWA, Normal and High Power factor models available

MH & HPS
50 HZ

Input Volts	Catalog* Number	Circuit Type	Input Watts	Max Input Curr.	Nom Open Circuit Volt.	Fuse Rating	Wir Dia	Dimensions			Capacitor				Total Wt. (lbs.)	Ignitor		UL Bench Top Rise		
								Ref Dwg	A	B	µF	Min Volt	Dry Film			Oil Filled			Catalog Number	Max Dist. lamp
												Dia	Ht	Oval	Ht					
(1) 175 WATT M57 METAL HALIDE LAMP																				
230	M175230AC3M	CWA	205	1.00	310	3	15	PC1	2.25	3.55	12	400	6.5	3.82	1.5	3.13	6.7	n/a	n/a	C
(1) 250 WATT M58 METAL HALIDE LAMP																				
230	M250230AC3M	CWA	282	1.40	285	4	15	PC1	3.0	4.3	18	400	n/a	n/a	2.01x3.01	3.1	9	n/a	n/a	D
(1) 400 WATT M59 METAL HALIDE LAMP																				
230	M400230AC4M	CWA	448	2.20	300	6	15	PC2	2.13	3.75	28	425	n/a	n/a	1.91x2.91	3.9	13	n/a	n/a	D
(1) 1000 WATT M47 METAL HALIDE LAMP																				
230	M1000230AC5M	CWA	1080	4.70	420	13	18	PC3	3.4	5.3	30	440	n/a	n/a	2.01x3.01	3.9	21	n/a	n/a	C
(1) 1500 WATT M48 METAL HALIDE LAMP																				
220				7.20		20														
230	M1500230AC5M	CWA	1605	7.29	430	20	18	PC3	4.38	6.18	42(2x21)	480	n/a	n/a	1.97x3.66	3.9	30	n/a	n/a	C
240				6.80		20														
(1) 70 WATT S62 HIGH PRESSURE SODIUM LAMP																				
220				0.95		2														
230	S70230LC3M	HX-HPF	88	1.10	120	2	18	PC1	1.9	3.2	10	280	1.26	2.83	n/a	n/a	5.7	HPS150-3A	3	A
240				1.05		2														
(1) 250 WATT S50 HIGH PRESSURE SODIUM LAMP																				
220				1.33		5														
230	S250230AC4M	CWA	280	1.24	188	5	18	PC2	1.78	3.58	40	300	n/a	n/a	2.01x3.01	3.9	10.3	HPS400-3A	3	B
240				1.15		5														
(1) 400 WATT S51 HIGH PRESSURE SODIUM LAMP (continued)																				
220				2.00		8														
230	S400230AC4M	CWA	465	2.05	190	8	18	PC2	2.5	4.3	64	300	n/a	n/a	1.91x2.91	3.1	15.5	HPS400-3A	3	D
240				2.10		8														
(1) 1000 WATT S52 HIGH PRESSURE SODIUM LAMP																				
220				5.10		15														
230	S1000230AC5M	CWA	1100	4.90	445	15	15	PC3	4.0	5.8	36	525	n/a	n/a	1.96x3.65	4.25	27	HPS1000-4B	10	D
240				4.80		15														

See page 4-34 for Reference Drawings and Wiring Diagrams.

HID
CORE & COIL

Description of popular ballast modifications (Fields 8 and 9 see p. 4-10)	
000	Core & Coil ballast only (no bracket, no capacitor)
200	Core & Coil ballast with welded bracket and without capacitor
500	Core & Coil ballast with standard capacitor, no bracket
500K	Core & Coil ballast distributor replacement kit with capacitor and adjustable mounting brackets
502K	Core & Coil ballast distributor replacement kit with capacitor and adjustable mounting brackets plus capacitor boot. Available for tri-volt products for Canadian market
518	Core & Coil ballast with dry capacitor, no bracket
700	Core & Coil ballast with standard capacitor, and welded bracket
718	Core & Coil ballast with dry capacitor, and welded bracket

REFERENCE DRAWING PC1

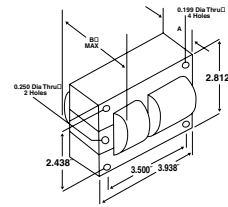

REFERENCE DRAWING PC3

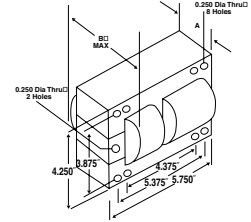

REFERENCE DRAWING PC2

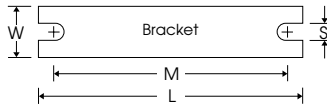
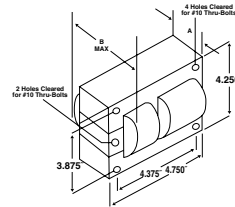

Ref. Dwg.	L	W	M	S
PC1	5.25"	1.25"	4.60"	0.25"
PC2	7.75"	1.25"	5.75"	0.25"
PC3	7.75"	2.75"	6.10"	0.25"

See p. 4-6 for adjustable mounting brackets and detailed bracket drawings.

WIRING DIAGRAMS

Wiring Diagram 15

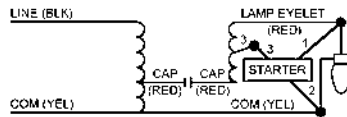

Wiring Diagram 16

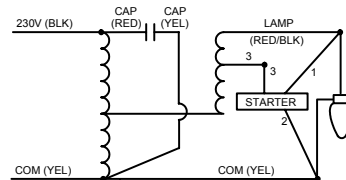

Wiring Diagram 17

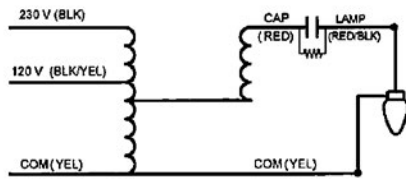

Optional 120V Standby Lamp 400 Watts Max.

Wiring Diagram 18

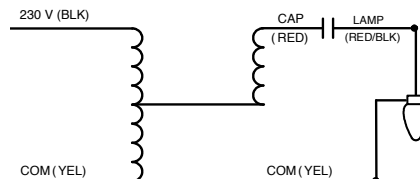

Note: Nominal dimensions provided above
Contact Universal for drawings and/or tolerances

F-CAN BALLASTS

METAL HALIDE

- 60 Hz
- Minimum Starting Temperature: -30° C
- CWA and High Power Factor Designs

MH
35-400
WATT

Input Volts	Catalog Number	Circuit Type	Input Watts	Max Input Current	Nom Open Circuit Voltage	Fuse Rating	Wir Dia	Dimensions			Total Weight	Max Dist To Lamp (ft)	Sound Rating	Certifications	
								Overall Length	Case Length	Mtg Dim				UL	CSA
(1) 35/39 WATT M130 METAL HALIDE (with built-in ignitor)															
120	1120-251A-TC	CWA	55	0.50	225	2	21	9.50	8.35	8.85	3.0	20	B	Yes	Yes
(1) 50 WATT M110 METAL HALIDE (with built-in ignitor)															
120 or 277	11210-236C-TC	HX-HPF	70	0.64 0.28	240	3 2	20	11.75	10.56	11.14	11.0	20	B	Yes	Yes
(1) 70 WATT M85 METAL HALIDE (with built-in ignitor)															
120 or 277	11210-277C-TC ⁷	HX-HPF	98	2.00 0.90	250	6 3	20	11.75	10.56	11.14	11.0	20	B	Yes	Yes
(1) 70 WATT M98 METAL HALIDE (with built-in ignitor)															
120 or 277	11210-506C-TC ²²	HX-HPF	90	2.00 0.90	250	6 3	20	11.75	10.56	11.14	11.0	20	B	Yes	Yes
120 or 347	11210-554C-TC	HX-HPF	90	2.00 0.80	250	6 3	20	11.75	10.56	11.14	11.0	20	B	No	Yes
(1) 100 WATT M90 METAL HALIDE (with built-in ignitor)															
120 or 277	11210-239C-TC	HX-HPF	125	2.20 1.00	250	8 4	20	11.75	10.56	11.14	11.0	20	B	Yes	Yes
120 or 347	11210-606C-TC	HX-HPF	125	2.20 0.70	250	8 2	20	11.75	10.56	11.14	11.0	20	B	No	Yes
(1) 150 WATT M81 METAL HALIDE (with built-in ignitor)															
120 or 277	11210-242C-TC	HX-HPF	185	3.70 1.60	260	10 5	20	14.31	13.19	13.75	14.0	20	B	Yes	Yes
(1) 150 WATT M102 METAL HALIDE (with built-in ignitor)															
120 or 277	11210-539C-TC	HX-HPF	185	3.70 1.60	260	10 4	20	14.31	13.19	13.75	14.0	20	B	Yes	Yes
(1) 175 WATT M57 METAL HALIDE LAMP															
120 or 277	1110-245SC-TC	CWA	202	2.00 0.85	300	5 3	20	14.32	13.19	13.75	14.0	*	B	Yes	Yes
120 or 347	1110-564C-TC	CWA	205	1.75 0.62	300	5 2	20	11.75	10.55	11.10	14.0	*	B	Yes	Yes
(1) 250 WATT M58 METAL HALIDE LAMP															
120 or 277	1110-246C-TC ^{8*}	CWA	295	2.50 1.10	280	8 4	20	16.75	15.57	16.13	18.0	*	C	Yes	Yes
120 or 277	1111-246C-TC ²³	CWA	300	2.50 1.10	300	8 4	22	11.75	10.55	11.10	11.0	*	B	Yes	Yes
120 or 347	1110-566C-TC	CWA	295	2.50 0.95	285	8 3	20	16.65	15.55	16.10	17.5	*	C	Yes	Yes
(1) 400 WATT M59 METAL HALIDE LAMP															
120 or 277	1110-247SC-TC	CWA	463	4.00 1.75	300	10 5	20	19.25	18.06	18.63	22.0	*	C	Yes	Yes
120 or 277	1111-247SC-TC ²³	CWA	460	4.00 1.75	300	10 5	22	14.31	13.19	13.75	14.0	*	B	Yes	Yes
120 or 347	1110-568C-TC	CWA	460	4.30 1.50	300	10 4	20	19.25	18.05	18.60	22.0	*	C	Yes	Yes

⁷ This ballast may also be used with (1) 70 watt S88 High Pressure Sodium lamp.

²² M98 Designates Venture Lighting catalog numbers MH70/4/MED, C/4/MED or MS70/C/84/MED/W

^{8*} This ballast can be used with a MH200 ignitor to operate (1) 250 watt M103 lamp. Consult Universal for instructions.

²³ Two of these ballasts are required to operate the lamp. Electrical data is for two ballasts, except for "Sound Rating," which is for each ballast

* Refer to Page 5-5.

See page 4-40 for Reference Drawings and Wiring Diagrams.

**HID
CORE & COIL 50 HERTZ**

F-CAN BALLASTS
HIGH PRESSURE SODIUM

- 60 Hz
- Minimum Starting Temperature: -40° C
- CWA and High Power Factor Designs

Input Volts	Catalog Number	Circuit Type	Input Watts	Max Input Current	Nom Open Circuit Voltage	Fuse Rating	Wir Dia	Dimensions			Total Weight	Max Dist To Lamp (ft)	Sound Rating	Certifications	
								Overall Length	Case Length	Mtg Dim				UL	CSA
(1) 35 WATT S76 HIGH PRESSURE SODIUM (with built-in starter)															
120 or 277	12210-261C-TC	HX-HPF	55	0.80 0.35	120	5 2	20	11.75	10.55	11.10	9.0	10	B	Yes	Yes
(1) 50 WATT S68 HIGH PRESSURE SODIUM (with built-in starter)															
120 or 277	12210-236C-TC	HX-HPF	71	1.05 0.45	125	3 2	20	11.75	10.55	11.10	9.0	10	B	Yes	Yes
(1) 70 WATT S62 HIGH PRESSURE SODIUM (with built-in starter)															
120 or 277	12210-237C-TC	HX-HPF	97	1.60 0.70	140	5 2	20	11.75	10.56	11.14	9.15	10	B	Yes	Yes
(1) 100 WATT S54 HIGH PRESSURE SODIUM (with built-in starter)															
120 or 277	12210-239C-TC	HX-HPF	125	2.00 0.90	130	5 3	20	11.75	10.55	11.10	10.4	10	B	Yes	Yes
(1) 150 WATT S55 HIGH PRESSURE SODIUM (with built-in starter)															
120 or 277	12210-241C-TC	HX-HPF	185	2.80 1.20	120	8 4	20	14.30	13.15	13.75	14.0	10	B	Yes	Yes

See page 4-40 for Reference Drawings and Wiring Diagrams.

F-CAN BALLASTS OPTIONAL ACCESSORIES

Mounting Bracket Assemblies

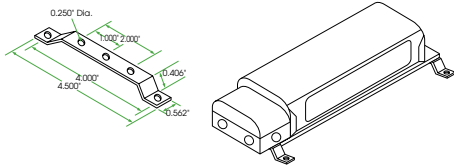

Catalog Number 2-BMB-1.

Available for the remote installation of ballasts. Each assembly consists of two (2) mounting brackets, four (4) screws, four (4) washers and four (4) nuts.

Tee-Pee Lead Wire Covers

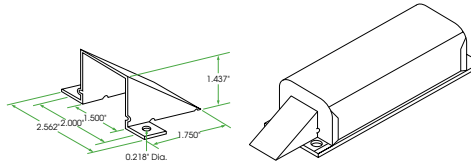

Catalog Number TP5. Ref. part #001-2013.

For use where ballast is attached to the surface of an enclosure or raceway.

Splice Box

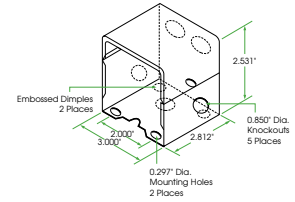

Catalog Number SB-4. Ref. part #001-2009

For use with all F-Can Ballasts. It is easily installed on the anchor bracket provided on each F-Can ballast. It contains five (5) 7/8\"/>

REFERENCE DRAWING FOR F-CAN

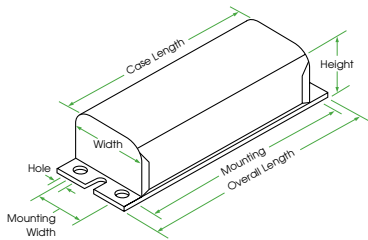

WIRING DIAGRAMS

Wiring Diagram 20

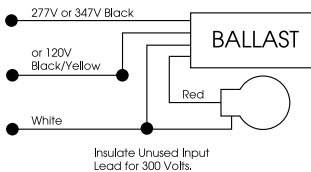

Wiring Diagram 21

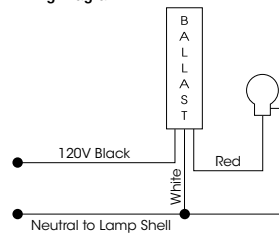

Wiring Diagram 22

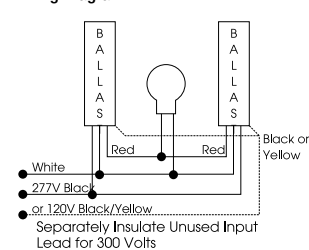

Note: Nominal dimensions provided above
Contact Universal for drawings and/or tolerances

STANDARD IGNITORS • INSTANT RESTRIKE IGNITORS • LONG DISTANCE IGNITORS • AUTOMATIC SHUTOFF IGNITORS • SHUTOFF DEVICES

Catalog Number	Description	Reference Drawing Number
--STANDARD IGNITORS		(See pg. 5-43)
PULSE START METAL HALIDE		
MH 70-3B ¹³	For double-ended MH lamps with HX-HPF ballasts: 70 watt (M85), 100 watt (M91), and 150 watt (M81)	29
MH 100-3A	For MH lamps with HX-HPF ballasts: 35/39w(M130), 50w(M110), 70w(M98), 100w(M90/M140), and 150w(M102/M142)	25
MH 150-1A	For 150 watt (M102/M142) lamp with CWA ballast	26
MH 350-1A	For MH lamps with CWA ballasts: 175 watt (M152/M137), 200 watt (M136), 250 watt (M153/M138), 320 watt (M154/M132), 350 watt (M131), 400 watt (M155/M135), and 450 watt (M144)	26
P 750-1B ¹³	For 750 watt (M149) MH lamp	29
HPS 1000-4B ¹³	For MH lamps: 875 watt (M166) and 1000 watt (M141). It is also used for 1000W HPS lamps	29
HIGH PRESSURE SODIUM		
HPS 150-3A	For HPS lamps of 150 watt or less with HX-HPF ballast, except 150 watt S56 lamp	26
HPS 400-3A	For HPS lamps from 200 to 400 watts and 150 watt S56 lamp with CWA ballasts	26
HPS 600-1B	For 600 watt lamps.	27
HPS 1000-4B ¹³	For 1000 watt HPS and Pulse Start Metal Halide lamps. With attached mounting bracket.	29
HIGH PRESSURE SODIUM		
HPS 150-G01	For HPS lamps of 150 watt or less with HX-HPF ballast, except 150 watt S56 lamp	32
HPS 400-G05	For HPS lamps from 200 to 400 watts and 150 watt S56 lamp with CWA ballasts	32
INSTANT RESTRIKE IGNITORS		
HIGH PRESSURE SODIUM		
HPS 150-5B ¹³	Instant Restrike Ignitor — for lamps of 150 watts or less except 150 watt S56. Ignitor has attached mounting bracket.	30
LONG DISTANCE IGNITORS		
PULSE START METAL HALIDE		
MH 100-5A	For MH lamps from 35 to 50 watts. Max Ballast to Lamp Distance ($\approx 20'$)	25
MH 100-5A	For MH lamps from 70 to 150 watts. Max Ballast to Lamp Distance ($\approx 30'$)	25
MH UNV-5B	For MH lamps from 35 to 450 watts. Ignitor incorporates automatic resetting thermal protection. Max Ballast to Lamp Distance ($\approx 50'$)	33
HIGH PRESSURE SODIUM		
HPS 150-4A	For HPS lamps of 150 watt or less, except 150 watt S56 lamp. Max Ballast to Lamp Distance ($\approx 20'$)	24
HPS 400-4A	For HPS lamps from 200 to 400 watts and 150 watt S56 lamp. Max Ballast to Lamp Distance ($\approx 25'$)	33
AUTOMATIC SHUTOFF IGNITORS		
PULSE START METAL HALIDE		
P 750-15B ¹³	For 750 watt (M149) MH lamp	31
HIGH PRESSURE SODIUM		
HPS 150-45B ¹³	For lamps of 150 watts or less except 150 watt S56. With attached mounting bracket.	27
HPS 400-45B ¹³	For lamps from 200 to 400 watts and 150 watt S56 with constant wattage autotransformer ballasts. With attached mounting bracket.	27

¹³ May also be available without attached mounting bracket. Substitute "A" suffix for "B" suffix when ordering. Minimum quantities may apply.

Lamp Watts	ANSI Code	Circuit Type	Standard Igniters	Auto Shutoff	Instant Restrike	Long Distance Igniters
HIGH PRESSURE SODIUM IGNITORS						
35	S76	Reactor	HPS 150-3A	HPS 150-45B	HPS 150-5B	HPS 150-4A
50	S68	Reactor, HX	HPS 150-3A	HPS 150-45B	HPS 150-5B	HPS 150-4A
70	S62	Reactor, HX	HPS 150-3A	HPS 150-45B	HPS 150-5B	HPS 150-4A
100	S54	Reactor, HX	HPS 150-3A	HPS 150-45B	HPS 150-5B	HPS 150-4A
150	S55	Reactor, HX	HPS 150-3A	HPS 150-45B	HPS 150-5B	HPS 150-4A
150	S56	CWA	HPS 400-3A	HPS 400-45B	—	HPS 400-4A
250	S50	Reactor	—	HPS 400-45B	—	HPS 400-4A
250	S50	CWA	HPS 400-3A	HPS 400-45B	—	HPS 400-4A
250	S50	HX	—	HPS 400-45B	—	HPS 400-4A
400	S51	Reactor	—	HPS 400-45B	—	HPS 400-4A
400	S51	CWA	HPS 400-3A	HPS 400-45B	—	HPS 400-4A
400	S51	HX	—	HPS 400-45B	—	HPS 400-4A
600	S106	CWA	HPS 600-1B	—	—	—
1000	S52	CWA	HPS 1000-4B	—	—	—

STANDARD IGNITORS

Standard ignitors are supplied with all Universal High Pressure Sodium and Metal Halide ballasts requiring ignitors. These ballasts are supplied with an appropriate external ignitor unless the ignitor is permanently attached to or built into the ballast.

INSTANT RESTRIKE IGNITORS

An Instant Restrike Ignitor generates multiple pulses to restrike a lamp arc after a brief power interruption has extinguished it, without the typical 3-minute cool-down time. A Standard Ignitor cannot restrike an arc until the lamp has had time to sufficiently cool. Even though an Instant Restrike Ignitor can reinitiate the lamp arc immediately upon restoration of power, the lamp is still subject to warmup. The following chart is based on an S55 lamp.

Time Lamp Is Extinguished	Restrike Time	Light Output On Reignition	Lamp Warmup Time
1 second	2 seconds	87%	35 seconds
5 seconds	Instant	83%	70 seconds
15 seconds	Instant	76%	130 seconds
30 seconds	Instant	62%	190 seconds
1 minute	Instant	46%	255 seconds
Cold Start	Instant	36%	360 seconds

PLUG REPLACEABLE IGNITORS

Incorporates terminals and a separate mounting base to simplify construction and replacement.

Lamp Watts	ANSI Code	Circuit Type	Standard Igniters	Long Distance Igniters
METAL HALIDE IGNITORS				
35	M130	Reactor	MH 100-3A	MH 100-5A
50	M110	HX	MH 100-3A	MH 100-5A
70	M85	HX	MH 70-3B	MH 100-5A
70	M98	HX	MH 100-3A	MH 100-5A
100	M90	Reactor	MH 100-3A	MH 100-5A
100	M90	CWA	MH 100-3A	MH 100-5A
100	M91	HX	MH 70-3B	—
150	M81	HX	MH 70-3B	—
150	M81	CWA	MH 150-35B	—
150	M102	HX	MH 100-3A	MH 100-5A
350	M131	Reactor	MH 70-3B	—
350	M131	HX	MH 70-3B	—

LONG DISTANCE IGNITORS

Long Distance Ignitors are used in situations where a ignitor must be mounted further from the lamp than is recommended for a standard ignitor. The maximum lamp to ignitor distance for these ignitors is 50 feet, which may vary depending on the type of lamp, ballast, fixture, and wiring.

AUTOMATIC SHUTOFF IGNITORS

In the event of a lamp failure, a Standard Ignitor will continue to pulse, trying to start the lamp. This may reduce the life of the ignitor. An Automatic Shutoff Ignitor will apply pulses for 10 to 12 minutes and then deactivate if a lamp arc cannot be initiated. Resetting the ignitor is accomplished by momentarily interrupting the power to the ballast. For this reason, these ignitors are not recommended for use on unswitched circuits.

AUTOMATIC SHUTOFF DEVICES

Automatic shutoff devices can be used with a standard ignitor to convert standard ignitor into an automatic shutoff ignitor. Simply use the automatic shutoff device with appropriate standard ignitor. Matching ignitors are listed in the table on previous page. Automatic shutoff device coupled with standard ignitor is equivalent to automatic shutoff ignitor. Wiring diagrams of SA-100 automatic shutoff device are shown on Ref. Drawings 34a and 34b.

TEMPERATURE RATING

Most ignitors are rated for a 105°C maximum case temperature. Consult ballast specification sheets at www.unvlt.com for specific details.

REFERENCE DRAWINGS

All dimensions in decimals.
All lead lengths: 13 inches ±1

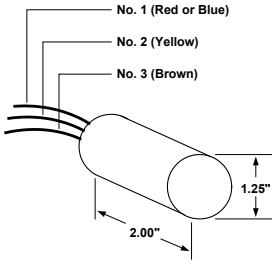

Ref. Drawing 24

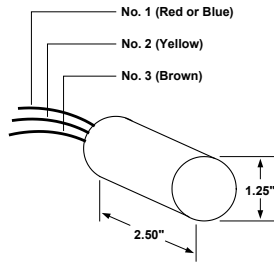

Ref. Drawing 25

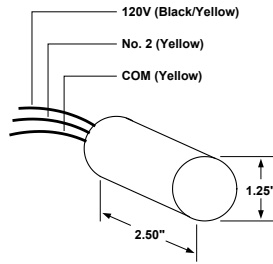

Ref. Drawing 25a

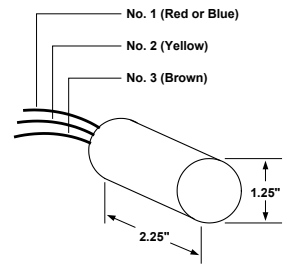

Ref. Drawing 26

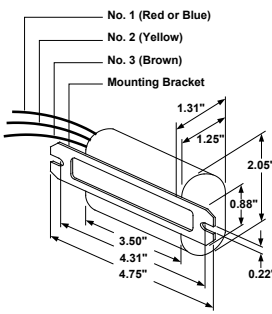

Ref. Drawing 27

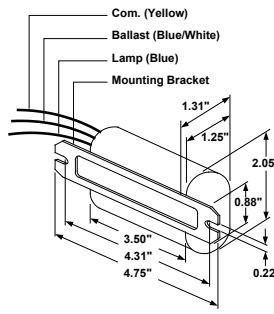

Ref. Drawing 27a

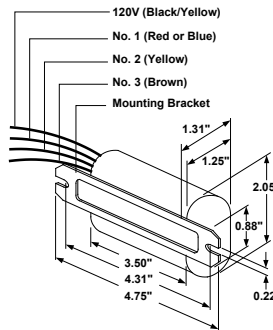

Ref. Drawing 28

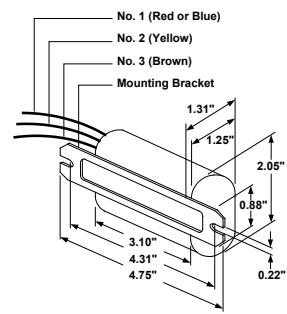

Ref. Drawing 29

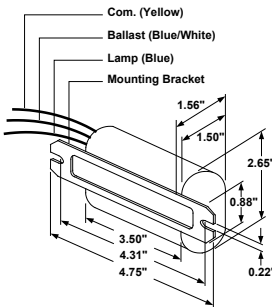

Ref. Drawing 30

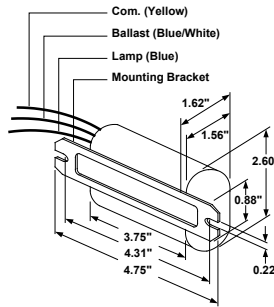

Ref. Drawing 31

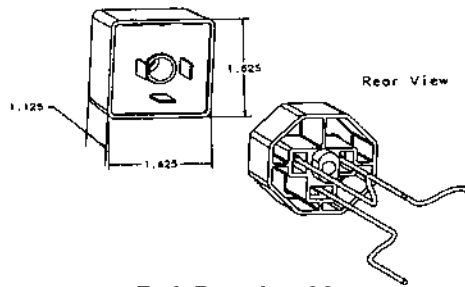

Ref. Drawing 32

Note: Nominal dimensions provided above
Contact Universal for drawings and/or tolerances

Notes

*It's **EASY**
to **REACH US...***



UNIVERSAL LIGHTING TECHNOLOGIES, INC.
51 Century Blvd., Suite 230
Nashville, TN 37214-3683

GENERAL INFO: **(615) 316-5100**

For Technical Engineering Services (TES),
application support and warranty information,
call **1-800-225-5278**

WEBSITE: **unvlt.com**
EMAIL: **webmaster@unvlt.com**

LIT#: BNC092517