

**NEW!**  
more on  
reverse

# SNAP<sup>2</sup>IT<sup>®</sup> Push-On Connectors

for Liquid-Tight Conduit

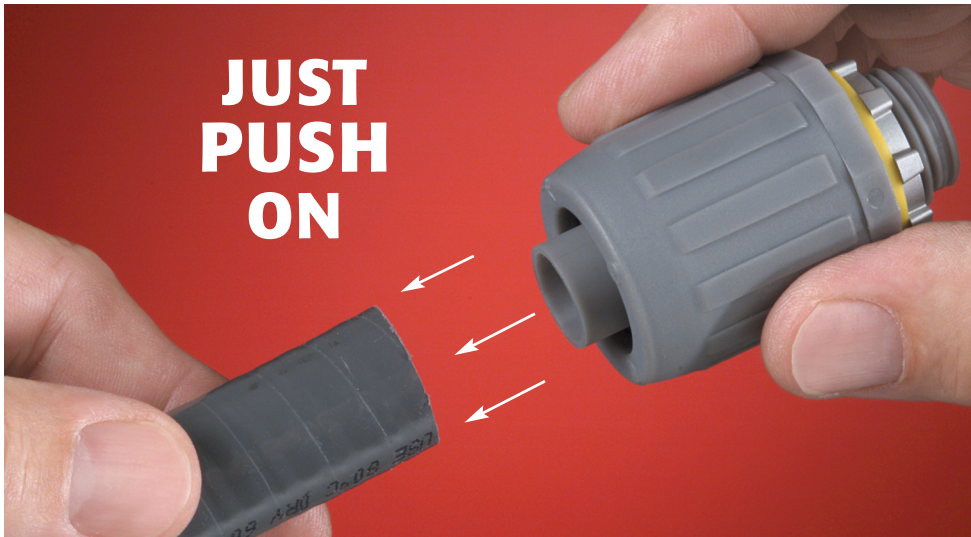

Save time and money with Arlington's **SNAP<sup>2</sup>It** Fittings! They offer the fastest, easiest installation on liquid-tight conduit.

**PUT YOUR TOOLS AWAY!**

To install these connectors, simply **PUSH ON** to conduit. That's it!

You'll get a super-secure, liquid-tight seal. Plus, they ship fully assembled – no disassembly required. Removable and reusable too!

Available in:

- Straight and 90°
- 1/2", 3/4", 1" trade sizes
- **Non-metallic** for non-metallic liquid-tight conduit, type B
- **Zinc** for metallic and non-metallic liquid-tight conduit, type B

**Competitively  
Priced**



**Arlington**

1 Stauffer Industrial Park  
Scranton, PA 18517

800/233.4717

Fax 570/562.0646

[www.aifittings.com](http://www.aifittings.com)

# SNAP<sup>2</sup>IT<sup>®</sup> Push-On Connectors

Plastic or Zinc • Push-On Installation • NO TOOLS!

PLASTIC

## Non-Metallic Fittings

Catalog Number	UPC/DEI/NAED Mfg. #018997	Description/Size	Unit Pkg	Std Pkg
NMLT5	54576	1/2" NM liquid-tight straight connector	25	100
NMLT905	54578	1/2" NM liquid-tight 90° connector	10	50
NMLT7	54577	3/4" NM liquid-tight straight connector	10	50
NMLT907	54579	3/4" NM liquid-tight 90° connector	10	50
NMLT10	54102	1" NM liquid-tight straight connector	5	25
NMLT9010	54104	1" NM liquid-tight 90° connector	5	25

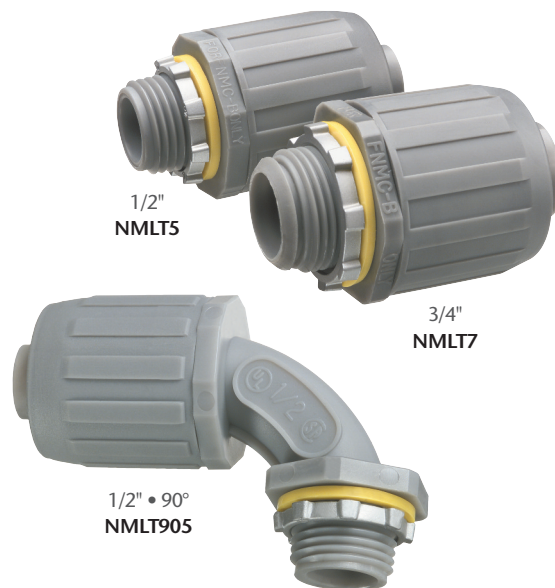

For Non-Metallic Liquid-Tight Conduit, Type B

ZINC

## Metallic (Zinc) Fittings

Catalog Number	UPC/DEI/NAED Mfg. #018997	Description/Size	Unit Pkg	Std Pkg
LT5	32502	1/2" zinc liquid-tight straight connector	25	100
LT905	32504	1/2" zinc liquid-tight 90° connector	10	50
LT7	32503	3/4" zinc liquid-tight straight connector	10	50
LT907	32505	3/4" zinc liquid-tight 90° connector	10	50
LT10	32102	1" zinc liquid-tight straight connector	5	25
LT9010	32104	1" zinc liquid-tight 90° connector	5	25

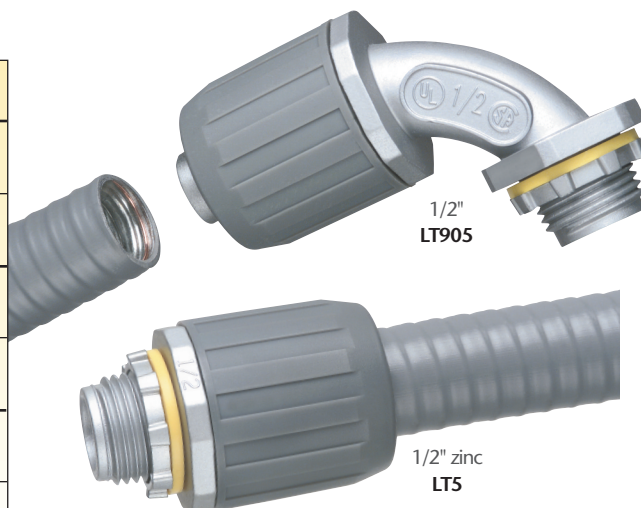

The metal body of our ZINC fittings bonds to the metal core of the metallic liquid-tight conduit; bonding it to the box or enclosure where it forms a secure, LIQUID-TIGHT seal.

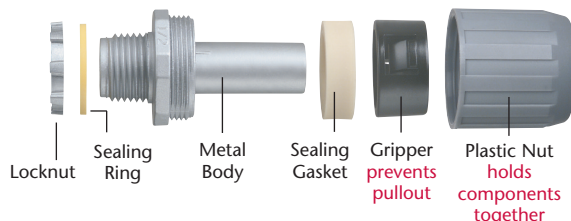

**Arlington**

1 Stauffer Industrial Park  
Scranton, PA 18517  
800/233.4717  
Fax 570/562.0646  
www.aifittings.com

Patented. Other patents pending.  
NMLT 1013/15M

Scan for details



Distributed by

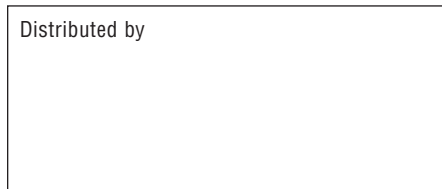



**NEW!**  
more on  
reverse

# SNAP<sup>2</sup>IT® Push-On Connectors

for Liquid-Tight Conduit

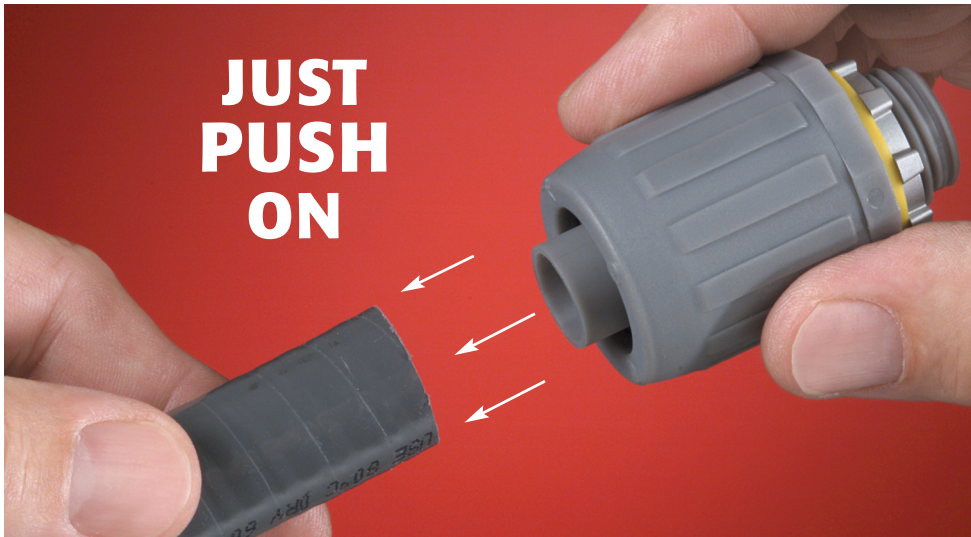

Save time and money with Arlington's **SNAP<sup>2</sup>It** Fittings! They offer the fastest, easiest installation on liquid-tight conduit.

**PUT YOUR TOOLS AWAY!**

To install these connectors, simply **PUSH ON** to conduit. That's it!

You'll get a super-secure, liquid-tight seal. Plus, they ship fully assembled – no disassembly required. Removable and reusable too!

Available in:

- Straight and 90°
- 1/2", 3/4", 1" trade sizes
- **Non-metallic** for non-metallic liquid-tight conduit, type B
- **Zinc** for metallic and non-metallic liquid-tight conduit, type B

**Competitively  
Priced**



**Arlington**

1 Stauffer Industrial Park  
Scranton, PA 18517

800/233.4717

Fax 570/562.0646

[www.aifittings.com](http://www.aifittings.com)

# SNAP<sup>2</sup>IT<sup>®</sup> Push-On Connectors

Plastic or Zinc • Push-On Installation • NO TOOLS!

PLASTIC

## Non-Metallic Fittings

Catalog Number	UPC/DEI/NAED Mfg. #018997	Description/Size	Unit Pkg	Std Pkg
NMLT5	54576	1/2" NM liquid-tight <b>straight</b> connector	25	100
NMLT905	54578	1/2" NM liquid-tight <b>90°</b> connector	10	50
NMLT7	54577	3/4" NM liquid-tight <b>straight</b> connector	10	50
NMLT907	54579	3/4" NM liquid-tight <b>90°</b> connector	10	50
NMLT10	54102	1" NM liquid-tight <b>straight</b> connector	5	25
NMLT9010	54104	1" NM liquid-tight <b>90°</b> connector	5	25

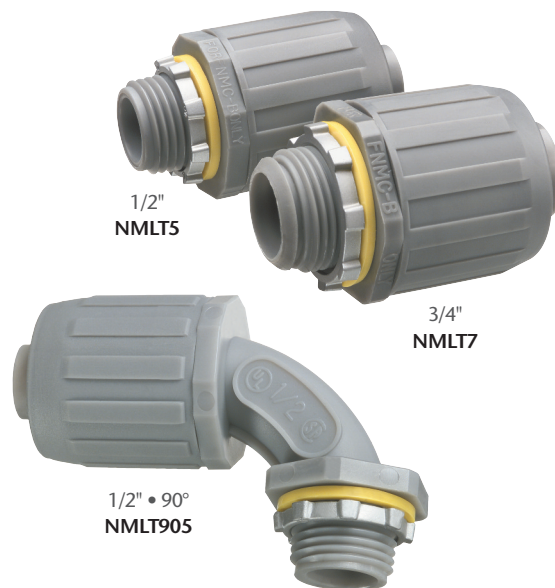

For Non-Metallic Liquid-Tight Conduit, Type B

ZINC

## Metallic (Zinc) Fittings

Catalog Number	UPC/DEI/NAED Mfg. #018997	Description/Size	Unit Pkg	Std Pkg
LT5	32502	1/2" zinc liquid-tight <b>straight</b> connector	25	100
LT905	32504	1/2" zinc liquid-tight <b>90°</b> connector	10	50
LT7	32503	3/4" zinc liquid-tight <b>straight</b> connector	10	50
LT907	32505	3/4" zinc liquid-tight <b>90°</b> connector	10	50
LT10	32102	1" zinc liquid-tight <b>straight</b> connector	5	25
LT9010	32104	1" zinc liquid-tight <b>90°</b> connector	5	25

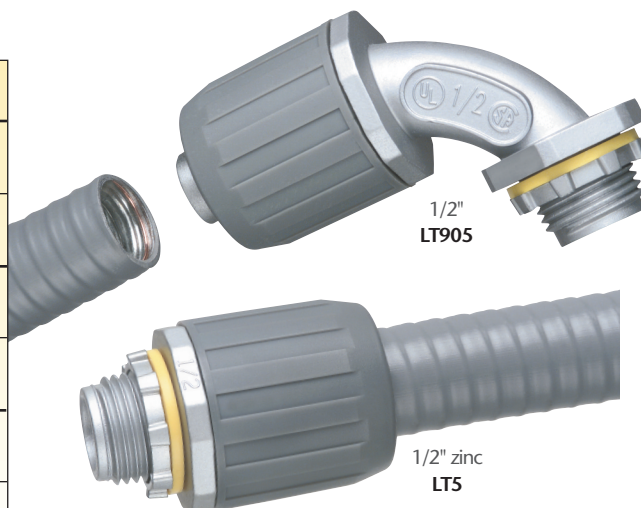

The metal body of our ZINC fittings bonds to the metal core of the metallic liquid-tight conduit; bonding it to the box or enclosure where it forms a secure, LIQUID-TIGHT seal.

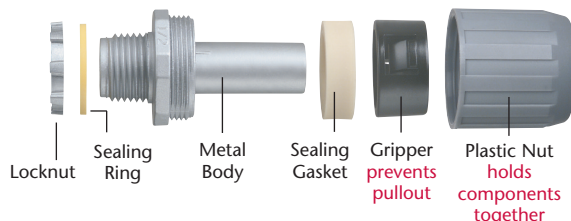

**Arlington**

1 Stauffer Industrial Park  
Scranton, PA 18517  
800/233.4717  
Fax 570/562.0646  
www.aifittings.com

Patented. Other patents pending.  
NMLT 1013/15M

Scan for details



Distributed by

