



# ELLIOTT ELECTRIC SUPPLY

We Deliver...Lower Cost, Quality Products, & Personal Service

3804 South Street  
75964-7263, TX Nacogdoches  
Phone: 936-569-7941  
Fax: 936-560-4685



## LAM2A250386Y 2BRL Alcu Lug *Panduit Corporation*

Catalog Number	LAM2A250386Y
Manufacturer	Panduit Corporation
Description	One-Hole, Aluminum, Two Barrel Lug, Dual Barrel, Type LAM2A, Nema Hole Sizes and Spacing, #6 Awg - 250 Kcmil, 3/8 (9.5MM) Stud Hole.
Weight per unit	N/A
Product Category	Large Terminals & Connectors

### Descriptions

Description	2BRL ALCU LUG
Long Description	One-hole, aluminum, two barrel lug, dual barrel, type LAM2A, NEMA hole sizes and spacing, #6 AWG - 250 kcmil, 3/8 (9.5mm) stud hole.
Product Type	Al Lug, 6AWG-250KCMIL, 3/8IN Stud, PK6

### Manufacturer Information

Brand	PANDUIT CORPORATION
Manufacturers Part Number	LAM2A250-38-6Y
sub brand	Type LAM

### Taxonomies, Classifications, and Categories

Category Description	SPLIT BOLTS
Type	Mechanical Connectors - Lugs

### Packaging

Carton	1
Weight Per each	0

NOTES:

1. MATERIAL:  
BODY - ALUMINUM, TIN PLATED  
SCREW - ALUMINUM, TIN PLATED
2. UL LISTED, CSA CERTIFIED, OR cULus FOR USE UP TO 600V & TEMPERATURE RATED 90°C (AL9CU)
3. DUAL RATED FOR USE WITH COPPER OR ALUMINUM STRANDED CODE CONDUCTOR
4. THESE PARTS ARE RoHS COMPLIANT
5. USE OF OXIDE INHIBITING JOINT COMPOUND LIKE PANDUIT CMP-100 RECOMMENDED FOR PAD TO PAD AND CONDUCTOR SURFACES
6. SEE PACKAGING LABEL FOR TIGHTENING TORQUE INFORMATION
7. PKG QTY:  
6 = 6

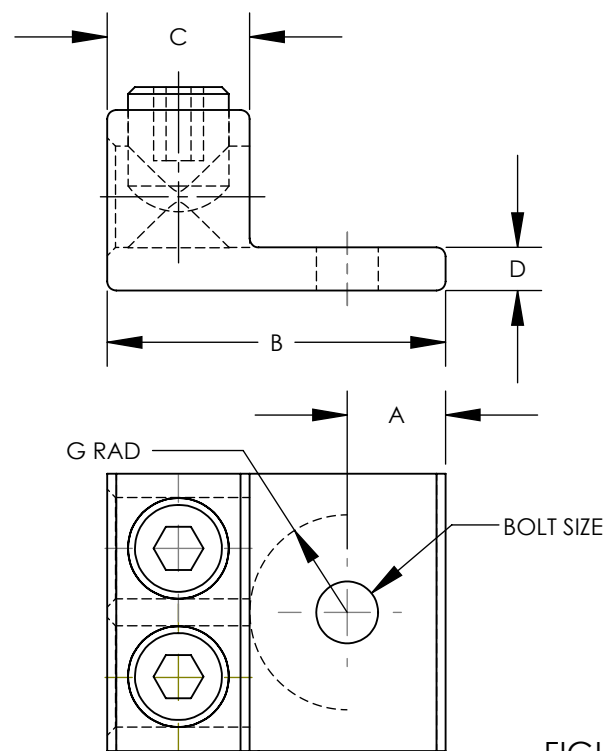
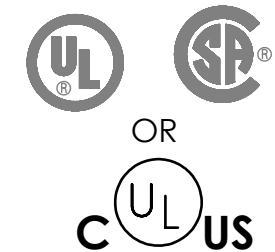

FIGURE 1

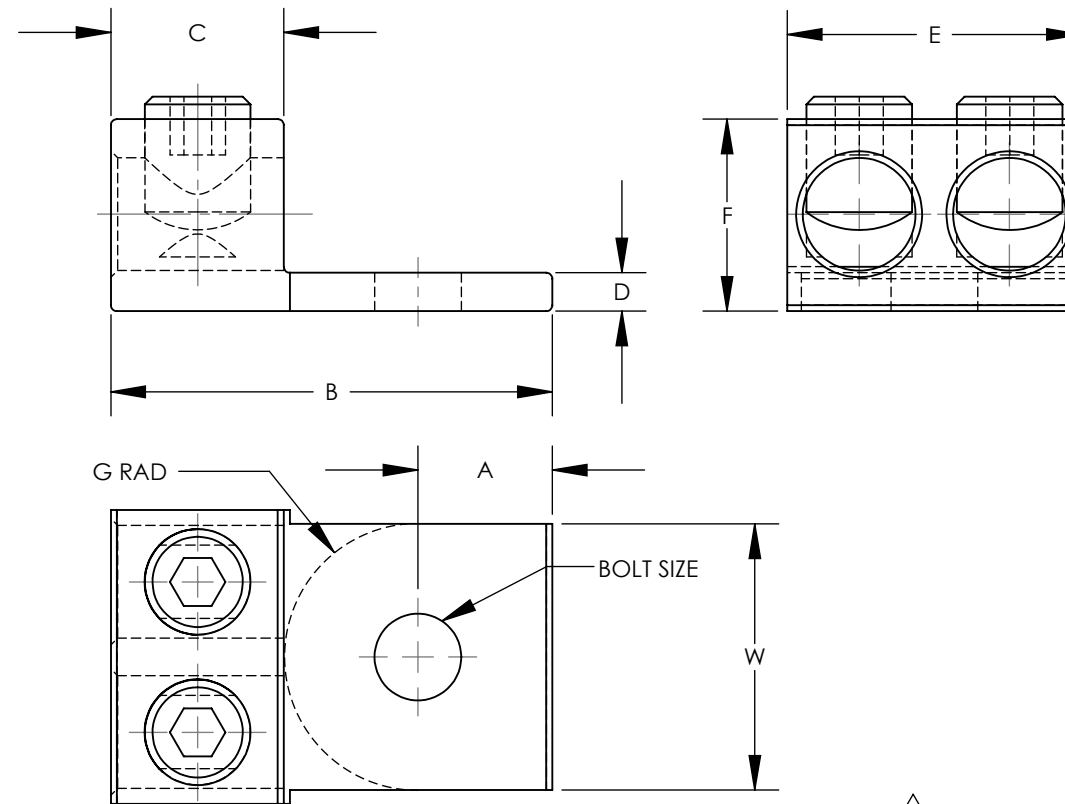

FIGURE 2

PART NUMBER	FIG.	WIRE RANGE COPPER/ALUMINUM	WIRE STRIP LENGTH IN [mm]	STUD SIZE IN	DIMENSIONS - IN [mm] ±.02 [.5]								HEX KEY*	AGENCY
					A	B	C	D	E	F	G	W		
LAM 2A10-14-6Y	1	14 AWG - 10 AWG	.62 [15.7]	1/4	0.43 [10.8]	1.47 [37.3]	0.62 [15.7]	0.19 [4.8]	1.13 [28.6]	0.78 [19.9]	0.42 [10.7]	N/A	SLOTTED	cULus
LAM 2A20-14-6Y	1	14 AWG - 2/0 AWG	.62 [15.7]	1/4	0.43 [10.8]	1.47 [37.3]	0.62 [15.7]	0.19 [4.8]	1.20 [30.6]	0.78 [19.9]	0.42 [10.7]	N/A	3/16	cULus
LAM 2A250-38-6Y	2	6 AWG - 250 kcmil	1.00 [25.4]	3/8	0.51 [13.0]	2.56 [65.1]	1.00 [25.4]	0.25 [6.4]	1.64 [41.7]	1.19 [30.2]	1.05 [26.7]	1.50 [38.0]	5/16	cULus
LAM 2A350-12-6Y	2	6 AWG - 350 kcmil	1.13 [28.6]	1/2	0.88 [22.2]	2.87 [73.0]	1.13 [28.6]	0.25 [6.4]	1.91 [48.6]	1.25 [31.8]	0.86 [21.8]	1.73 [44.0]	5/16	cULus
LAM 2A600-12-6Y	2	2 AWG - 600 kcmil	1.38 [34.9]	1/2	0.63 [16.0]	3.19 [81.0]	1.38 [34.9]	0.44 [11.2]	2.38 [60.5]	1.56 [39.6]	1.19 [30.2]	2.00 [50.8]	3/8	UL & CSA
LAM 2A1000-58-6Y	1	500 kcmil - 1000 kcmil	1.63 [41.4]	5/8	0.88 [22.2]	3.50 [88.9]	1.63 [41.4]	0.50 [12.7]	3.50 [88.9]	1.94 [49.3]	1.00 [25.4]	N/A	3/8	UL & CSA

\* HEX SIZE MAY DIFFER FROM CHART. DIFFERENCE IN SIZE WILL NOT AFFECT FIT, FORM, OR FUNCTION OF PART

REV	DATE	BY	CHK	APR	DESCRIPTION	ECN
08	2/13	JHNU	JHNU	RGB	REVISED TITLE BLOCK	10N006AT-NC

TITLE LAM2A SERIES ALUMINUM MECHANICAL LUGS CUSTOMER DRAWING			
ITEM REVISION NAME	10N006AT/08		
DATASET FILE NAME	10N006AT-NC/08.SLDDRW		
UNLESS OTHERWISE SPECIFIED, DIMENSIONAL TOLERANCES ARE: IN [mm]			
.X ±	.XXX ±		
.XX ±	ANGLES ±		
DRAWN BY JHNU		DATE 2/06	CHK JHNU
SCALE NONE		THIRD ANGLE PROJECTION	
DRAWING NUMBER 10N006AT-NC			SIZE B
SHEET 1 OF 1			



# ELLIOTT ELECTRIC SUPPLY

We Deliver...Lower Cost, Quality Products, & Personal Service

3804 South Street  
75964-7263, TX Nacogdoches  
Phone: 936-569-7941  
Fax: 936-560-4685



## LAM2A250386Y 2BRL Alcu Lug *Panduit Corporation*

Catalog Number	LAM2A250386Y
Manufacturer	Panduit Corporation
Description	One-Hole, Aluminum, Two Barrel Lug, Dual Barrel, Type LAM2A, Nema Hole Sizes and Spacing, #6 Awg - 250 Kcmil, 3/8 (9.5MM) Stud Hole.
Weight per unit	N/A
Product Category	Large Terminals & Connectors

### Descriptions

Description	2BRL ALCU LUG
Long Description	One-hole, aluminum, two barrel lug, dual barrel, type LAM2A, NEMA hole sizes and spacing, #6 AWG - 250 kcmil, 3/8 (9.5mm) stud hole.
Product Type	Al Lug, 6AWG-250KCMIL, 3/8IN Stud, PK6

### Manufacturer Information

Brand	PANDUIT CORPORATION
Manufacturers Part Number	LAM2A250-38-6Y
sub brand	Type LAM

### Taxonomies, Classifications, and Categories

Category Description	SPLIT BOLTS
Type	Mechanical Connectors - Lugs

### Packaging

Carton	1
Weight Per each	0

NOTES:

1. MATERIAL:  
BODY - ALUMINUM, TIN PLATED  
SCREW - ALUMINUM, TIN PLATED
2. UL LISTED, CSA CERTIFIED, OR cULus FOR USE UP TO 600V & TEMPERATURE RATED 90°C (AL9CU)
3. DUAL RATED FOR USE WITH COPPER OR ALUMINUM STRANDED CODE CONDUCTOR
4. THESE PARTS ARE RoHS COMPLIANT
5. USE OF OXIDE INHIBITING JOINT COMPOUND LIKE PANDUIT CMP-100 RECOMMENDED FOR PAD TO PAD AND CONDUCTOR SURFACES
6. SEE PACKAGING LABEL FOR TIGHTENING TORQUE INFORMATION
7. PKG QTY:  
6 = 6

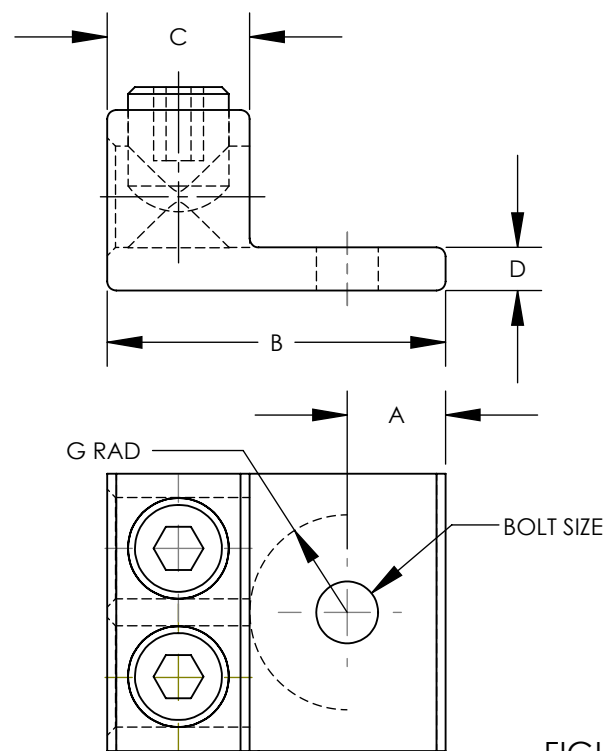
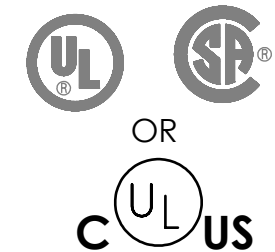

FIGURE 1

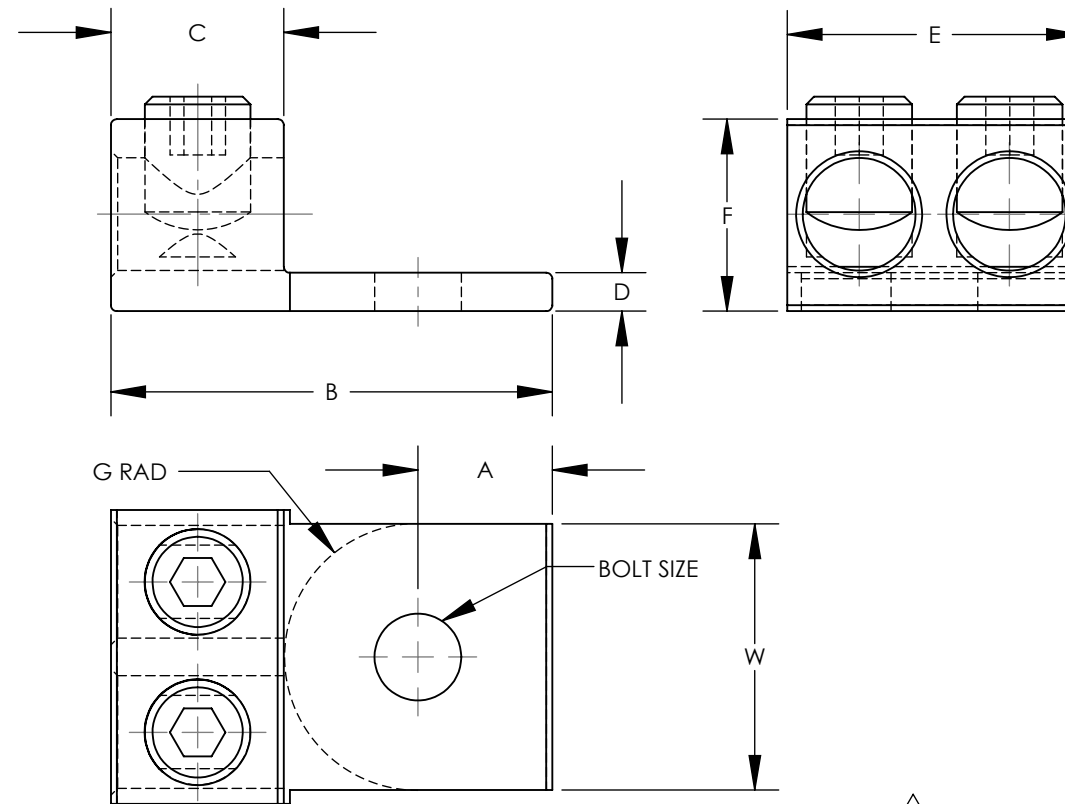

FIGURE 2

PART NUMBER	FIG.	WIRE RANGE COPPER/ALUMINUM	WIRE STRIP LENGTH IN [mm]	STUD SIZE IN	DIMENSIONS - IN [mm] ±.02 [.5]								HEX KEY*	AGENCY
					A	B	C	D	E	F	G	W		
LAM 2A10-14-6Y	1	14 AWG - 10 AWG	.62 [15.7]	1/4	0.43 [10.8]	1.47 [37.3]	0.62 [15.7]	0.19 [4.8]	1.13 [28.6]	0.78 [19.9]	0.42 [10.7]	N/A	SLOTTED	cULus
LAM 2A20-14-6Y	1	14 AWG - 2/0 AWG	.62 [15.7]	1/4	0.43 [10.8]	1.47 [37.3]	0.62 [15.7]	0.19 [4.8]	1.20 [30.6]	0.78 [19.9]	0.42 [10.7]	N/A	3/16	cULus
LAM 2A250-38-6Y	2	6 AWG - 250 kcmil	1.00 [25.4]	3/8	0.51 [13.0]	2.56 [65.1]	1.00 [25.4]	0.25 [6.4]	1.64 [41.7]	1.19 [30.2]	1.05 [26.7]	1.50 [38.0]	5/16	cULus
LAM 2A350-12-6Y	2	6 AWG - 350 kcmil	1.13 [28.6]	1/2	0.88 [22.2]	2.87 [73.0]	1.13 [28.6]	0.25 [6.4]	1.91 [48.6]	1.25 [31.8]	0.86 [21.8]	1.73 [44.0]	5/16	cULus
LAM 2A600-12-6Y	2	2 AWG - 600 kcmil	1.38 [34.9]	1/2	0.63 [16.0]	3.19 [81.0]	1.38 [34.9]	0.44 [11.2]	2.38 [60.5]	1.56 [39.6]	1.19 [30.2]	2.00 [50.8]	3/8	UL & CSA
LAM 2A1000-58-6Y	1	500 kcmil - 1000 kcmil	1.63 [41.4]	5/8	0.88 [22.2]	3.50 [88.9]	1.63 [41.4]	0.50 [12.7]	3.50 [88.9]	1.94 [49.3]	1.00 [25.4]	N/A	3/8	UL & CSA

\* HEX SIZE MAY DIFFER FROM CHART. DIFFERENCE IN SIZE WILL NOT AFFECT FIT, FORM, OR FUNCTION OF PART

REV	DATE	BY	CHK	APR	DESCRIPTION	ECN
08	2/13	JHNU	JHNU	RGB	REVISED TITLE BLOCK	10N006AT-NC

TITLE LAM2A SERIES ALUMINUM MECHANICAL LUGS CUSTOMER DRAWING			
ITEM REVISION NAME	10N006AT/08		
DATASET FILE NAME	10N006AT-NC/08.SLDDRW		
UNLESS OTHERWISE SPECIFIED, DIMENSIONAL TOLERANCES ARE: IN [mm]			
.X ±	.XXX ±		
.XX ±	ANGLES ±		
DRAWN BY JHNU		DATE 2/06	CHK JHNU
SCALE NONE		THIRD ANGLE PROJECTION	
DRAWING NUMBER 10N006AT-NC			SIZE B
SHEET 1 OF 1			