

NG/ND-Frames

320-1600A, 240-690V

Contents

Series G NG-Frame

Digitrip 310+ Electronic Trip Unit types NGS, NGH, NGC, NGU

Page

Catalog Number Selection	3
Long Delay Response and Short Delay with Flat Response and Override (LSI, LSIG, ALSI, ALSIG)	TC01210010E 4
Long Delay Response and Short Delay with I ² T Response Curve and Override (LS, LSG)	TC01210011E 5
Ground Fault Delay Response Curve (LSG, LSIG, ALSIG)	TC01210012E 6
Maintenance Mode / Instantaneous Setting (ALSI, ALSIG)	TC01210016E 7

Digitrip OPTIM 550 Trip Unit type NHH High Instantaneous

Long Delay I ² T and Short Delay Flat	TC01207016E 8
Long Delay I ⁴ T and Short Delay Flat	TC01207017E 9
Instantaneous and Override	TC01207018E 10

Digitrip 310 Electronic Trip Units

Eaton/Cutler-Hammer NG___T__W Electronic LD and SD with I ² T Response	TC01209003E 11
Eaton/Cutler-Hammer NG___T__W Electronic LD and SD with Flat Response	TC01209004E 12
Eaton/Cutler-Hammer NG___T__W Electronic LD and SD with Flat Response (1600A)	TC01209006E 13

Series C ND-Frame

Catalog Number Selection	14
--------------------------	----

NES Digitrip RMS 310 Electronic Trip Unit types ND, CND, HND, CHND, NDC, CNDC

I ² T Ramp Short Time Delay	SC-5375-92A 15
Adjustable Short Time Delay	SC-5376-92A 16
Ground Fault Protection	SC-5377-92A 17

Digitrip OPTIM 550 & 1050 Electronic Trip unit types ND, HND, NDC

Long Delay I ² T, Short Delay I ² T	SC-6331-96 18
Long Delay I ² T, Short Delay Flat	SC-6332-96 19
Long Delay I ⁴ T, Short Delay Flat	SC-6333-96 20
Instantaneous and Override	SC-6334-96 21
Ground Fault Protection	SC-6335-96 22

Note:

The following curves meet the requirements of UL, CSA, IEC, CCC and CE.
The following circuit breakers are derived from Eaton, Westinghouse, or Cutler-Hammer history.

Time Current Curves are engineering reference documents for application and coordination purposes only.

Catalog Number Selection

This information is presented only as an aid to understanding catalog numbers. It is not to be used to build catalog numbers for circuit breakers or trip units.

Table 1. Series G N-Frame (320-1600A)

Frame NG				Performance				Amperes				Trip Unit				Rating		Terminations[Ⓢ]				Feature																																																																				
				<table border="1"> <tr><th></th><th>600</th><th>480</th><th>415</th><th>240</th></tr> <tr><th>S</th><td>25</td><td>50</td><td>50</td><td>85</td></tr> <tr><th>H</th><td>35</td><td>65</td><td>70</td><td>100</td></tr> <tr><th>C</th><td>65</td><td>100</td><td>100</td><td>200</td></tr> <tr><th>U^①</th><td>65</td><td>150</td><td>150</td><td>200</td></tr> </table>					600	480	415	240	S	25	50	50	85	H	35	65	70	100	C	65	100	100	200	U ^①	65	150	150	200	<table border="1"> <tr><th>080</th><td>= 800</td></tr> <tr><th>120</th><td>= 120</td></tr> <tr><th>125</th><td>= 1250[Ⓢ]</td></tr> <tr><th>160</th><td>= 1600[Ⓢ]</td></tr> </table>				080	= 800	120	= 120	125	= 1250 [Ⓢ]	160	= 1600 [Ⓢ]	<table border="1"> <tr><th>33</th><td>= 310+ Electronic LS</td></tr> <tr><th>32</th><td>= 310+ Electronic LSI</td></tr> <tr><th>35</th><td>= 310+ Electronic LSG</td></tr> <tr><th>35B22</th><td>= 310+ Electronic LSI(A), GFA, no trip</td></tr> <tr><th>36</th><td>= 310+ Electronic LSIG</td></tr> <tr><th>36B22</th><td>= 310+ Electronic LSI(A), GFA, no trip</td></tr> <tr><th>38</th><td>= 310+ Electronic ALSI</td></tr> <tr><th>39</th><td>= 310+ Electronic ALSIG</td></tr> <tr><th>39B22</th><td>= 310+ Electronic ALSI(A) with Maintenance Mode and GFA, no trip</td></tr> </table>				33	= 310+ Electronic LS	32	= 310+ Electronic LSI	35	= 310+ Electronic LSG	35B22	= 310+ Electronic LSI(A), GFA, no trip	36	= 310+ Electronic LSIG	36B22	= 310+ Electronic LSI(A), GFA, no trip	38	= 310+ Electronic ALSI	39	= 310+ Electronic ALSIG	39B22	= 310+ Electronic ALSI(A) with Maintenance Mode and GFA, no trip	<table border="1"> <tr><th>Blank</th><td>= 80% rated</td></tr> <tr><th>C</th><td>= 100% rated</td></tr> </table>		Blank	= 80% rated	C	= 100% rated	<table border="1"> <tr><th>M</th><td>= Metric tapped line/load conductors</td></tr> <tr><th>E</th><td>= Imperial tapped line/load conductors</td></tr> </table>				M	= Metric tapped line/load conductors	E	= Imperial tapped line/load conductors	<table border="1"> <tr><th>Blank</th><td>= No feature</td></tr> <tr><th>B20</th><td>= High load alarm</td></tr> <tr><th>B21</th><td>= Ground fault</td></tr> <tr><th>ZG</th><td>= Zone selective interlocking</td></tr> </table>		Blank	= No feature	B20	= High load alarm	B21	= Ground fault	ZG	= Zone selective interlocking
	600	480	415	240																																																																																						
S	25	50	50	85																																																																																						
H	35	65	70	100																																																																																						
C	65	100	100	200																																																																																						
U ^①	65	150	150	200																																																																																						
080	= 800																																																																																									
120	= 120																																																																																									
125	= 1250 [Ⓢ]																																																																																									
160	= 1600 [Ⓢ]																																																																																									
33	= 310+ Electronic LS																																																																																									
32	= 310+ Electronic LSI																																																																																									
35	= 310+ Electronic LSG																																																																																									
35B22	= 310+ Electronic LSI(A), GFA, no trip																																																																																									
36	= 310+ Electronic LSIG																																																																																									
36B22	= 310+ Electronic LSI(A), GFA, no trip																																																																																									
38	= 310+ Electronic ALSI																																																																																									
39	= 310+ Electronic ALSIG																																																																																									
39B22	= 310+ Electronic ALSI(A) with Maintenance Mode and GFA, no trip																																																																																									
Blank	= 80% rated																																																																																									
C	= 100% rated																																																																																									
M	= Metric tapped line/load conductors																																																																																									
E	= Imperial tapped line/load conductors																																																																																									
Blank	= No feature																																																																																									
B20	= High load alarm																																																																																									
B21	= Ground fault																																																																																									
ZG	= Zone selective interlocking																																																																																									
Notes				Poles																																																																																						
<p>① 800A only. ② Neutral inn left pole on GN; right pole on NG. ③ Breakers do not ship with lugs. ④ IEC Only Trip units are factory installable only.</p>				<p>3 = Three 4 = Four; neutral[Ⓢ] 0% protected 7 = Four; neutral[Ⓢ] 100% protected 9 = Four; neutral[Ⓢ] 0/60/100% adjustable protection</p>																																																																																						

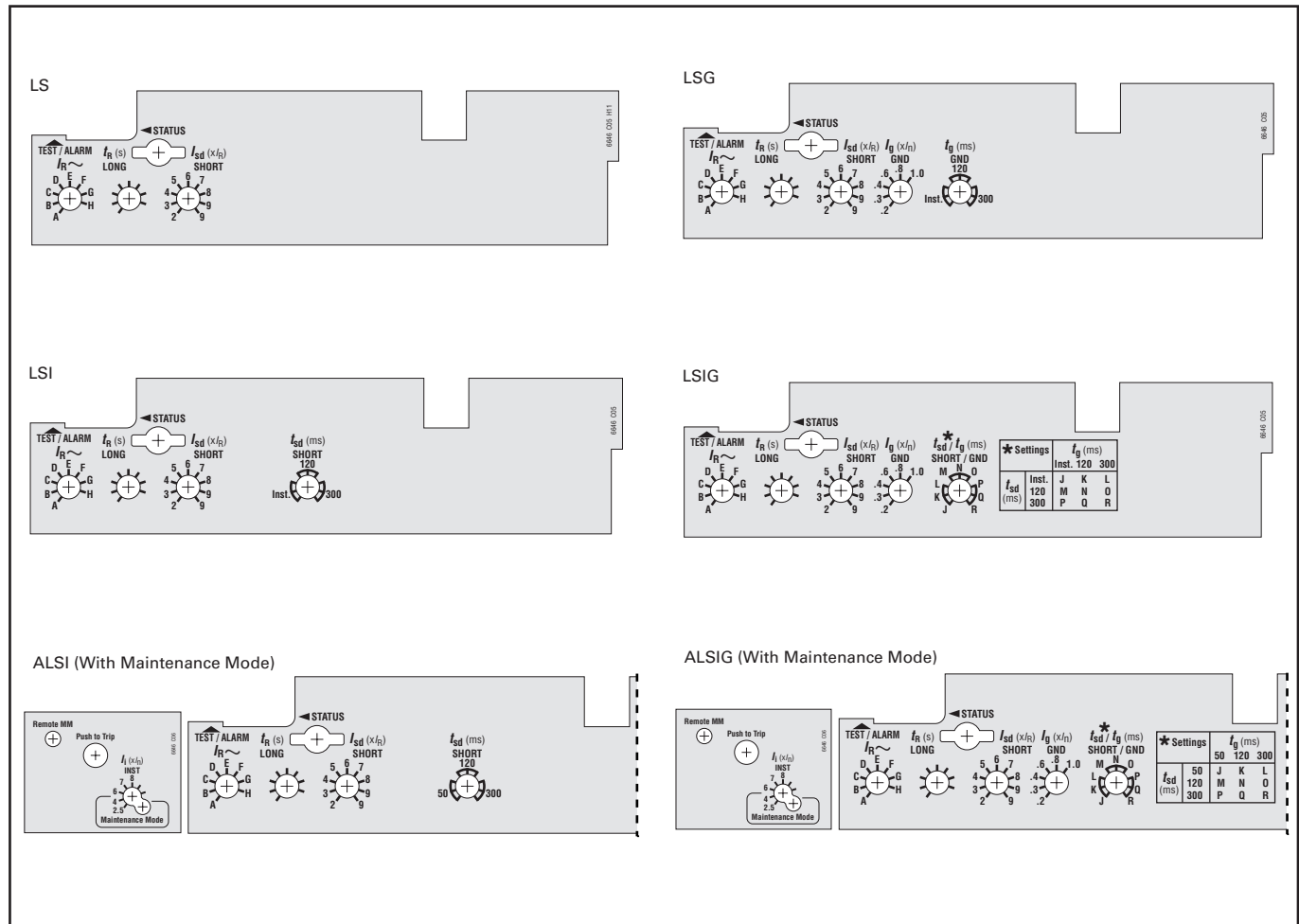

Figure 1. Digitrip 310+ Faceplates



Digitrip 310+ Circuit Breaker Time/Current Curves (Phase Current)

Series G N-Frame Circuit Breakers

Long Delay Response and Short Delay with Flat Response and Override

Catalog Types: NGS, NGH, NGC, NGU, GNS, GNH, GNC, and GNU circuit breakers, three- and four-pole

Trip Unit Type: 32 (LSI), 36 (LSIG), 38 (ALSI), 39 (ALSIG)

Available Sensors (I _f / I _n)	Rated Amperes			
	800A	1200A	1250A	1600A
A	320A	500A	500A	630A
B	400A	600A	630A	630A
C	450A	630A	700A	700A
D	500A	700A	800A	800A
E	600A	800A	900A	900A
F	630A	900A	1000A	1000A
G	700A	1000A	1200A	1250A
H	800A	1200A	1250A	1600A

Long Delay Time Settings +0% / -30% (seconds)							
800A	2	4	6	8	10	12	14
1200A	2	4	7	10	12	15	24
1250A	2	4	6	8	10	12	14
1600A	2	4	7	10	12	15	20

Notes:

- Curve accuracy applies from -20°C to +55°C ambient. For possible continuous ampere derating for ambient above 40°C, refer to Eaton. Temperatures above +85°C cause an over-temperature protection trip.
- Application frequency is 50/60 Hz.
- There is a memory effect that can act to shorten the Long Delay. If the breaker trips on a Long Delay overload and is quickly reset, the memory capacitor will still have charge and a subsequent overload will cause the breaker to trip in a shorter time than normal. The amount of time delay reduction is inverse to the amount of time that has elapsed since the previous overload. Approximately five minutes is required between overloads to completely reset memory.
- The right portion of the curve is determined by the interrupting rating of the circuit breaker.
- The left portion of the curve is shown as a multiple of the Long Delay Setting. (Long Delay Pickup = 115% of I_L). Range is 110-120%.
- Total clearing times shown include the response times of the trip unit, the breaker opening, and the interruption of the current.
- The Short Delay Pickup has nine settings/positions, 2-8; the last two switch positions are the same: 9X.
- For high fault current levels, an additional fixed instantaneous hardware override is provided to trip the breaker at 14400A. Instantaneous tolerance is +/- 20%. For the 1600A frame only, if I_f is set to the maximum (position H) and SDPU is set to the maximum (position 9), then the SDPU setting and the Instantaneous Override are set to the same value. The Instantaneous Override has precedence over SDPU. Therefore, the breaker will trip on Instantaneous Override.
- Maximum clearing time when using zone selective interlocking is 62ms.

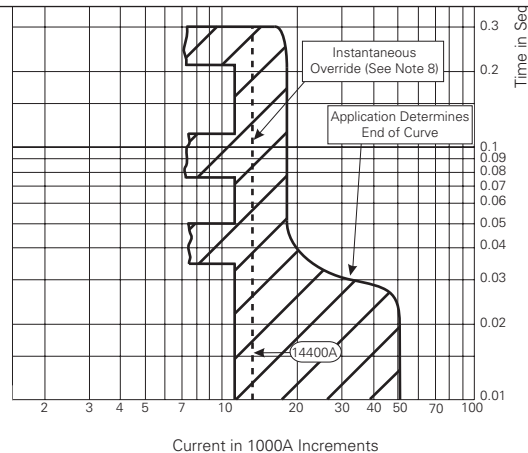
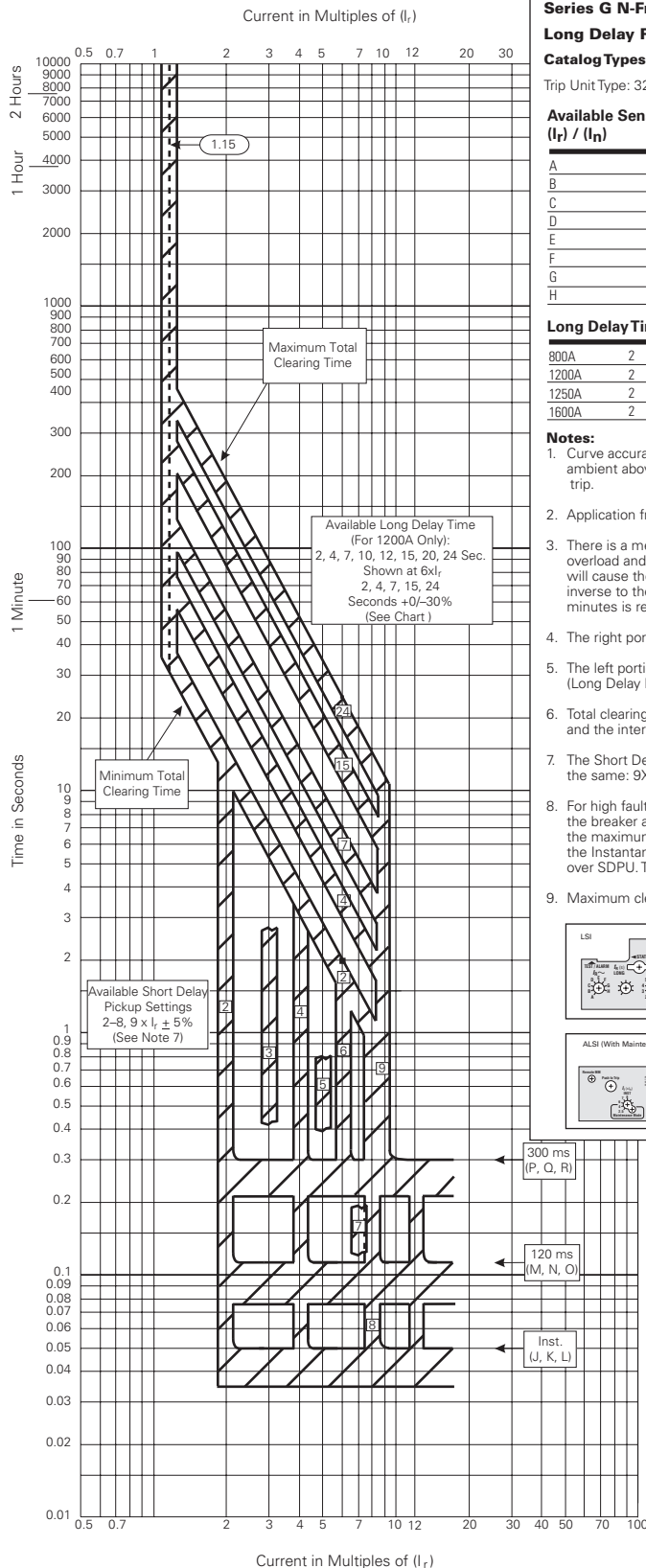
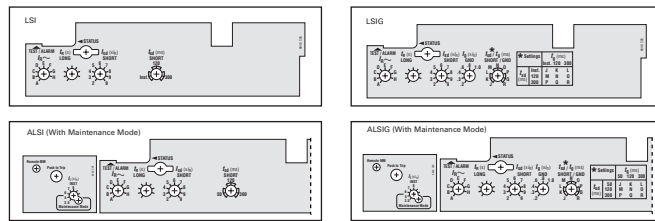

Adjustable Flat Trip Style (LSI, LSIG, ALSI, ALSIG)

Figure 2. Digitrip 310+ Long Delay Response and Short Delay with Flat Response and Override Curve (LSI, LSIG, ALSI, ALSIG) - Curve Number TC01210010E, March 2012

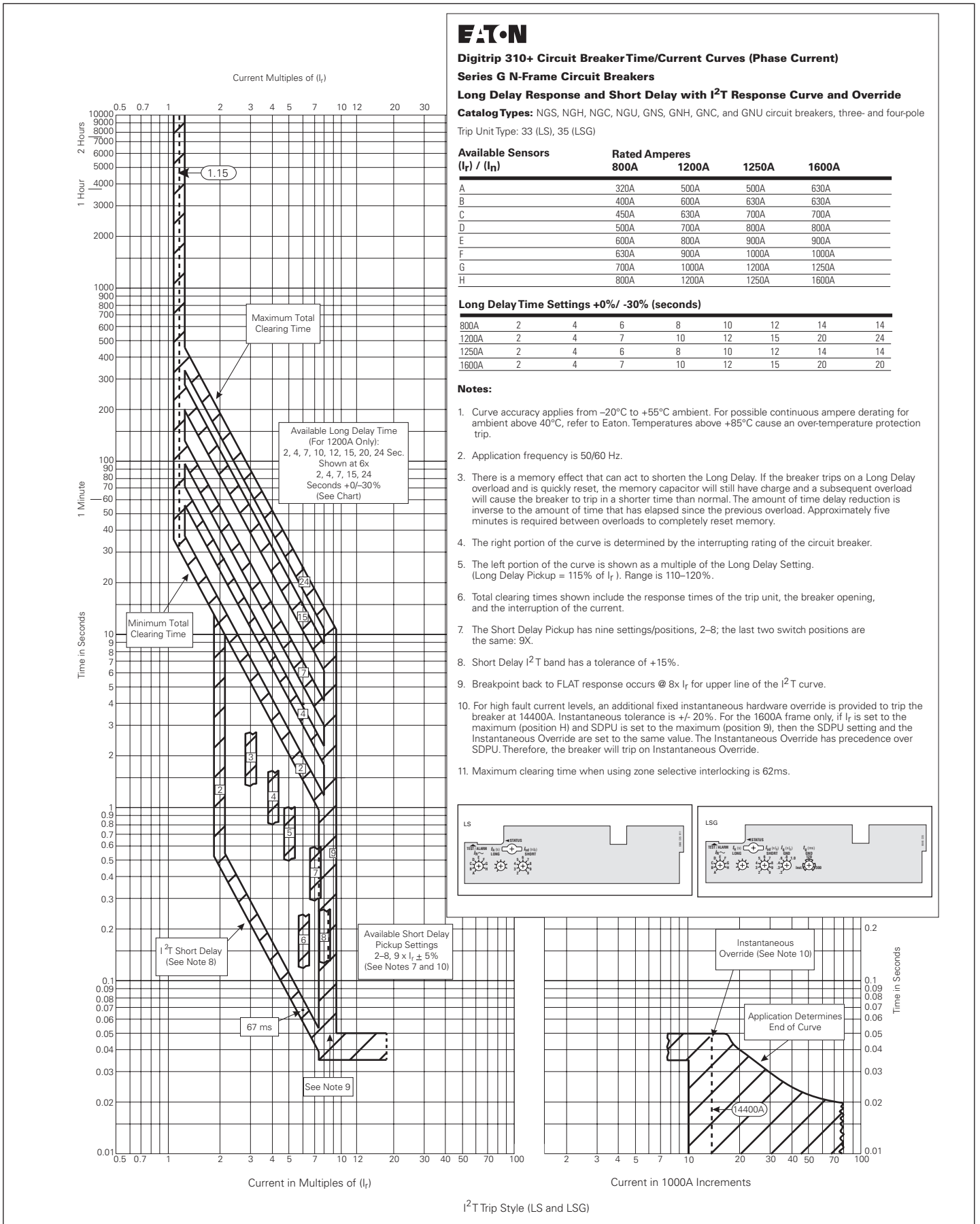
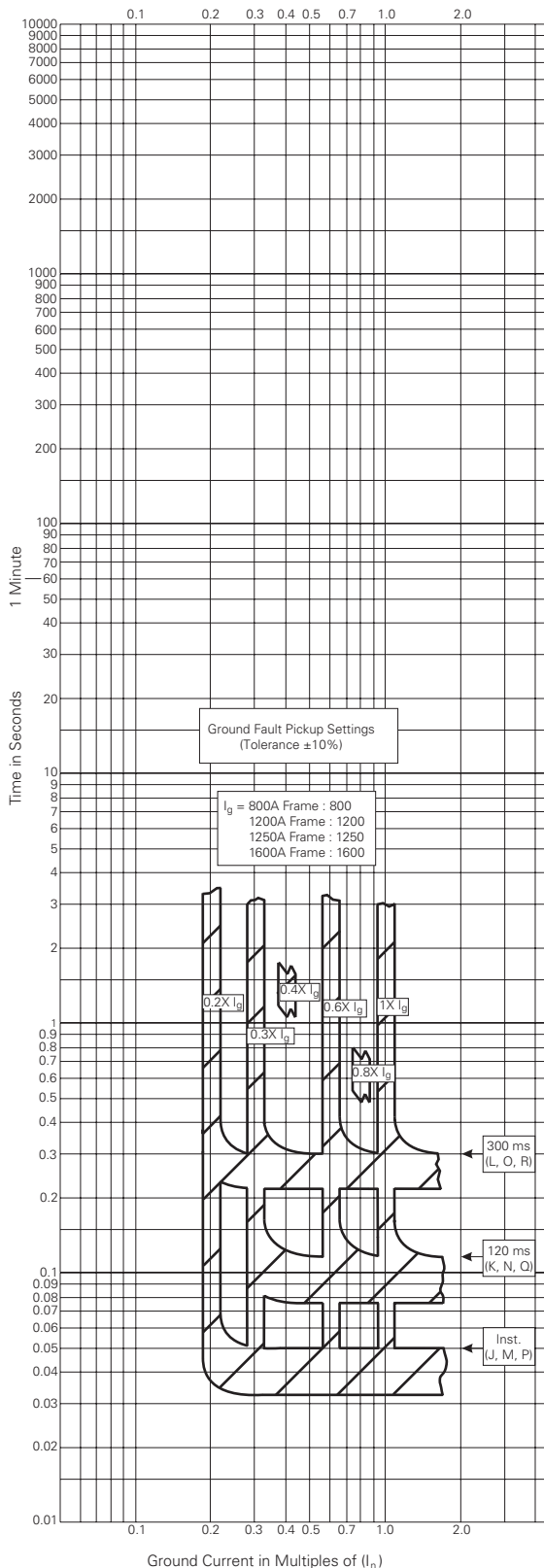
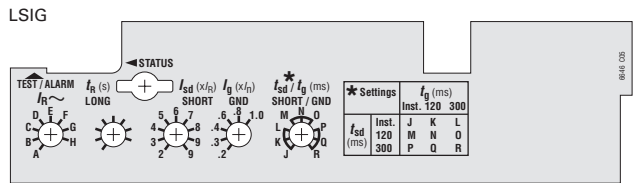
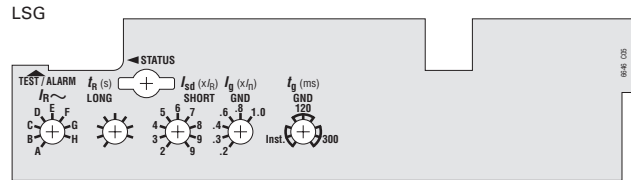

Figure 3. Digitrip 310+ Long Delay Response and Short delay with I²T Response Curve (LS, LSG) - Curve Number TC01210011E, March 2012



Digitrip 310+ Circuit Breaker Time/Current Curves (Ground Current)
Series G N-Frame Circuit Breakers
Ground Fault Delay Response Curve

Catalog Types: NGS, NGH, NGC, NGU, GNS, GNH, GNC, and GNU circuit breakers, three- and four-pole
Trip Unit Type: 35 (LSG), 36 (LSIG), 39 (ALSIG)



ALSIG (With Maintenance Mode)

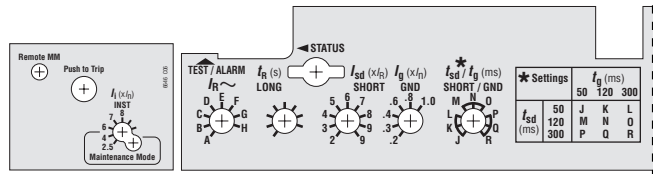

Note: Refer to table below for variations.

SD/ GF Delay Settings Table

* Settings	t_g (ms)			
	Inst.	120	300	
t_{sd} (ms)	Inst.	J	K	L
	120	M	N	O
	300	P	Q	R

Ground Fault Delay Response Notes:

1. Curve accuracy applies from -20°C to $+55^{\circ}\text{C}$ ambient. For possible continuous ampere derating for ambient above 40°C , refer to Eaton. Temperatures about $+85^{\circ}\text{C}$ cause an overtemperature protection trip.
2. Application frequency is 50/60 Hz.
3. Trip units are suitable for functional field testing with test kit style # 70C1056G52.
4. For LD response and SD with flat responses curve, see TC01210010E.
5. For LD responses and SD with I^2T response curve, see TC01210011E.
6. For testing information, please contact Eaton.

Figure 4. Ground Fault Delay Response Curve (LSG, LSIG, ALSIG) Curve Number TC01210012E, March 2012



Digitrip 310+ Circuit Breaker Time/Current Curves

Maintenance Mode/Instantaneous Setting

Series G N-Frame Trip Unit Nameplates

Trip Unit Type: 38 (ALSI), 39 (ALSIG)

ALSI (With Maintenance Mode)

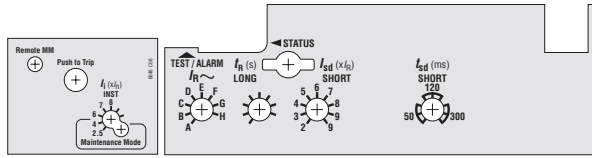

ALSIG (With Maintenance Mode)

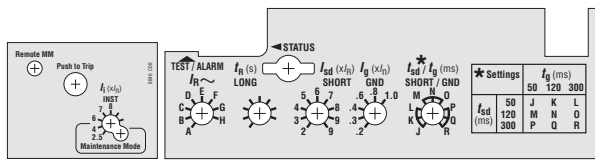

Notes:

1. The maintenance mode feature must be ENABLED for these curves to apply. The LED indicator is blue when in maintenance mode.
2. The end of the curve is determined by the interrupting rating of the circuit breaker.
3. Total clearing times shown include the response times of the trip unit, the breaker opening, and the interruption of the current.
4. Available pickup settings ($\times I_n$) (tolerance is $\pm 15\%$) 2.5, 4, 6, 7, 8, 10.
5. The Maintenance Mode consists of the two lowest settings of the INST switch: 2.5x and 4.0x.
6. The Remote Maintenance Mode is enabled by applying 24 VDC to the two wire cable that exists the left side of the breaker. The wires are color coded as follows: Yellow = +24 V and Black = common ground. A blue colored LED, on the left side of the breaker is the Maintenance Mode section of the trip unit, will light. The lighted blue LED indicates that the lowest setting of the Maintenance Mode is enabled. This setting corresponds to 2.5x of I_n . Turning the adjustable switch on the trip unit has no affect on either the Maintenance Mode or the INST Mode settings while the blue LED is lit. In addition to the blue colored LED, a relay contact (C, NO) is available. The wires for this contact exit the left hand side of the breaker and are color coded as follows: Blue = C, and Red = NO.
7. Contact Eaton for additional information.

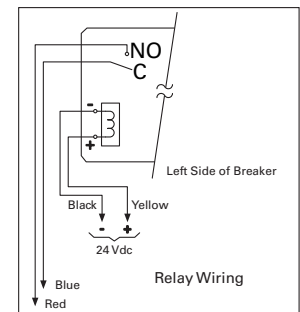

Maintenance Mode Trip

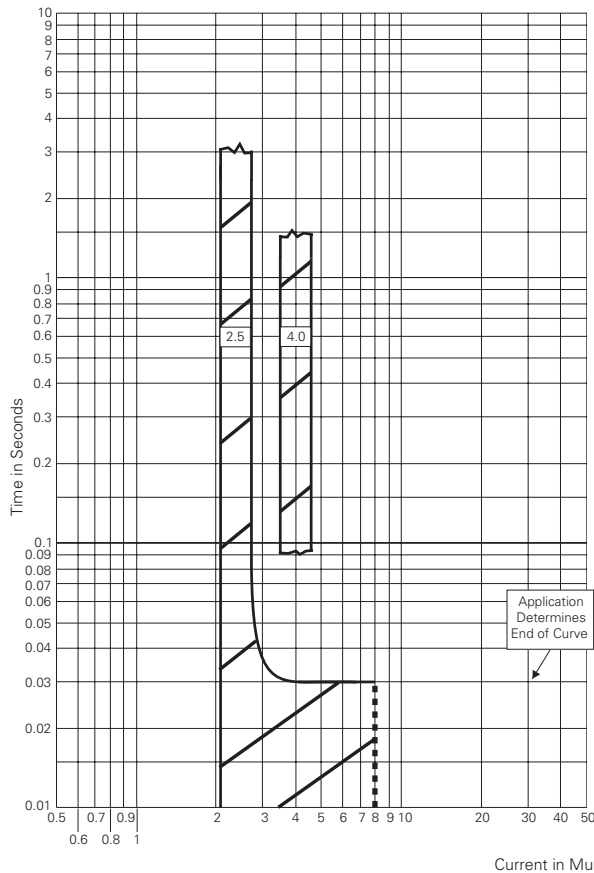

Instantaneous Mode Trip

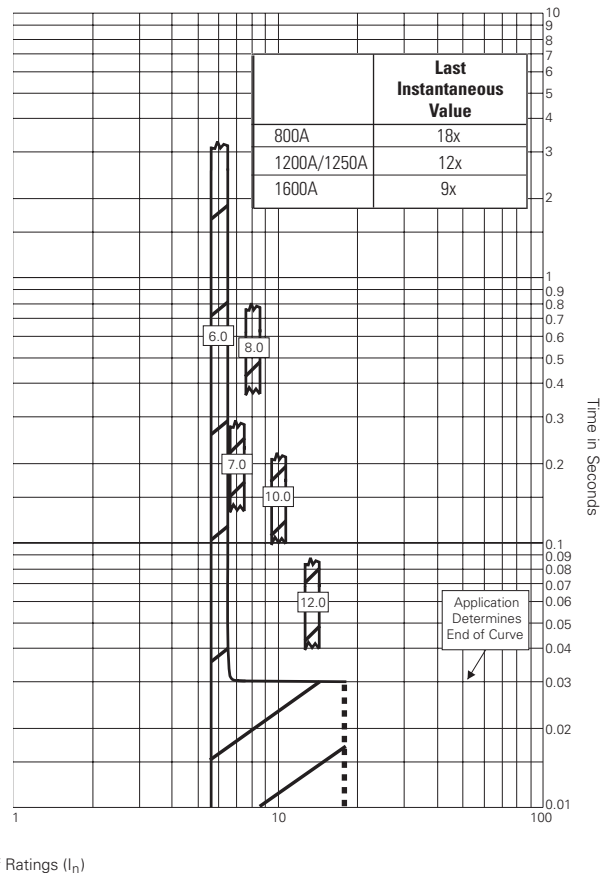

Figure 5. Maintenance Mode/Instantaneous Setting (ALSI, ALSIG) Curve Number TC01210016E ,TC01210017E, and TC 01210018E, March 2012

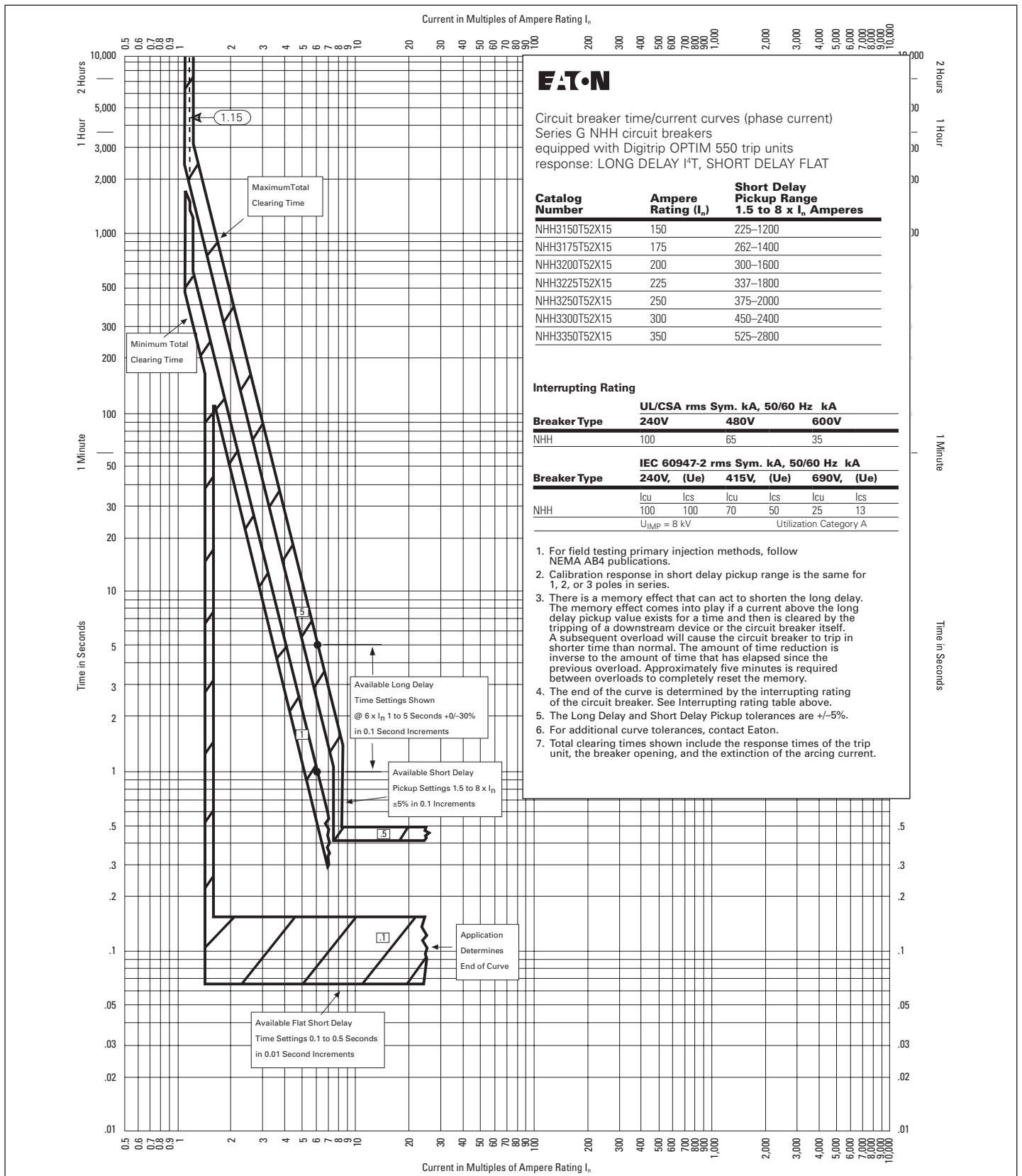

Figure 7. Digitrip OPTIM 550 NHH Long Delay I⁴T, Short Delay Flat NHH—Curve Number TC01207017E, September 2009

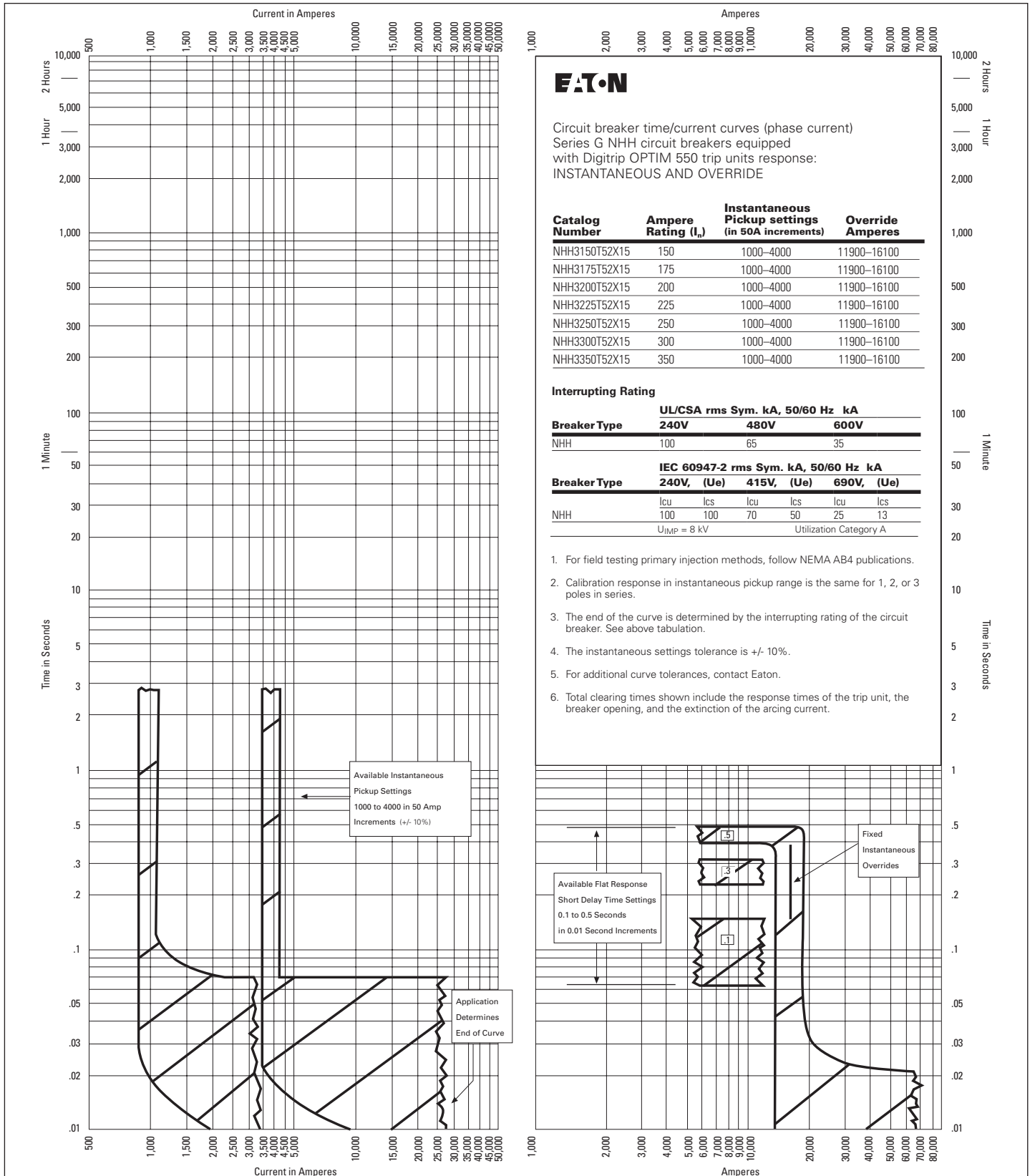

Figure 8. Digitrip OPTIM 550 NHH Instantaneous and Override NHH—Curve Number TC01207018E, September 2009

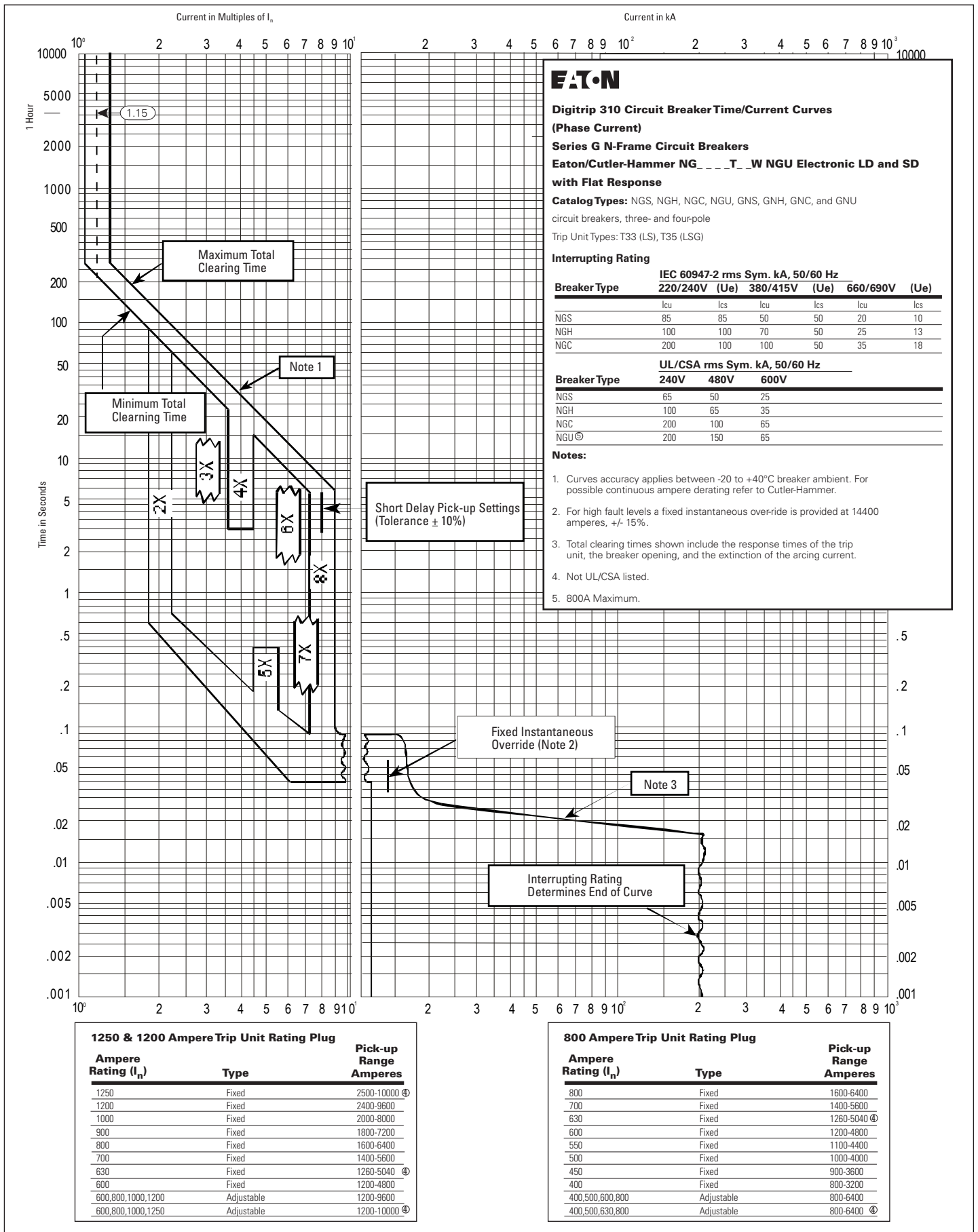

Figure 9. Digitrip 310 Long Delay and Short Delay with I2T Response (LS, LSG) - Curve Number TC01209003E

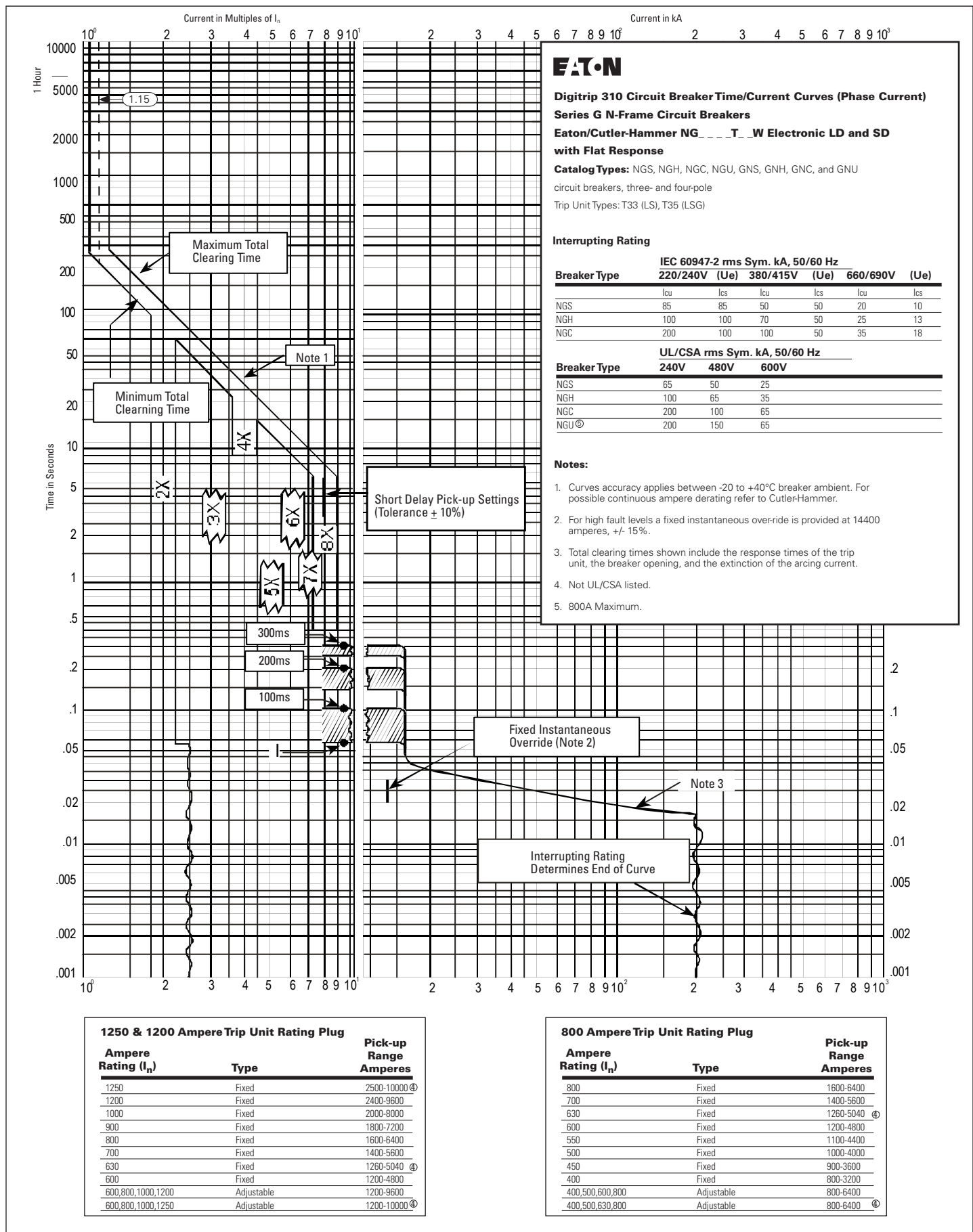

Figure 10. Digitrip 310 Long Delay and Short Delay with Flat Response (LSI, LSIG) - Curve Number TC01209004E

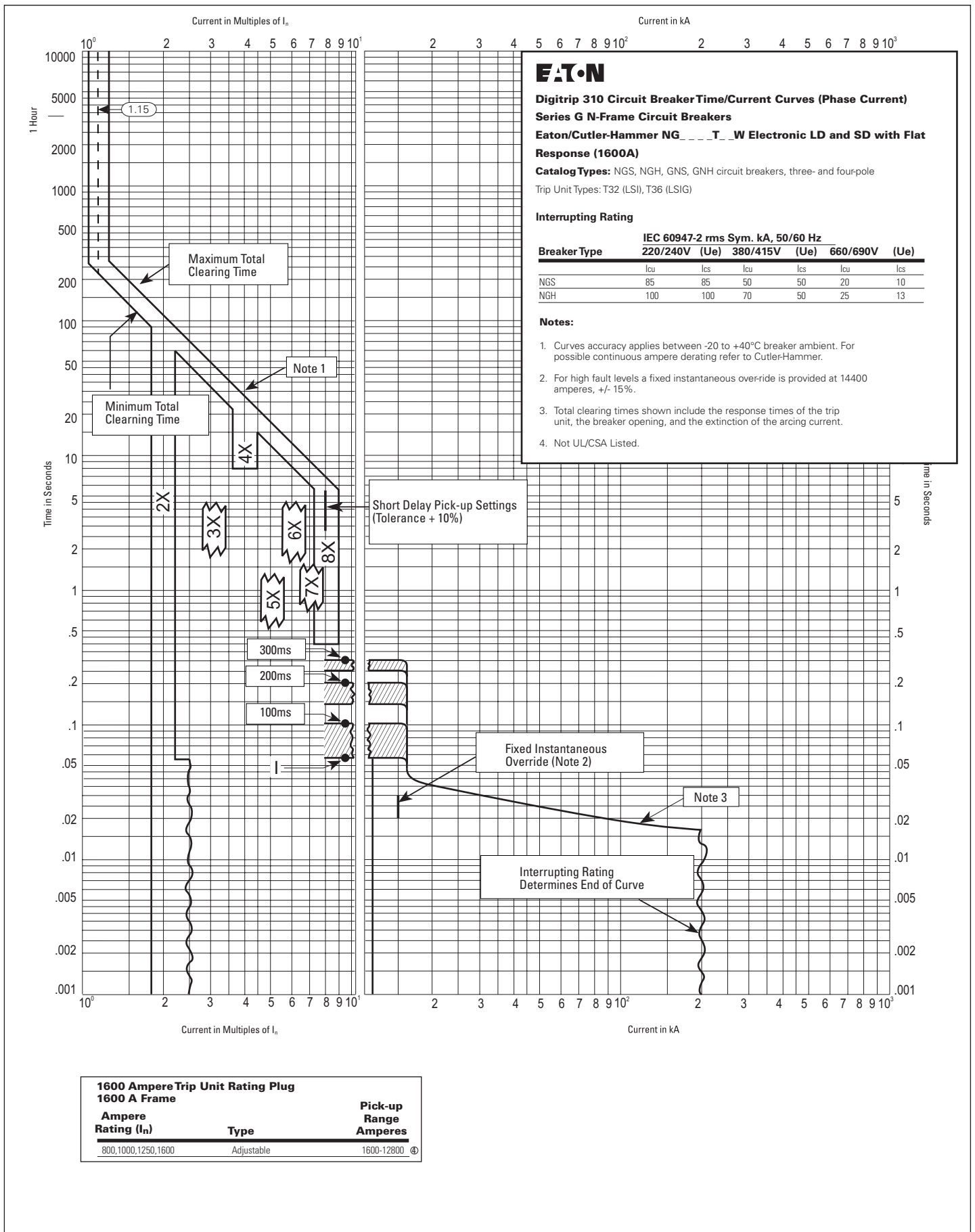
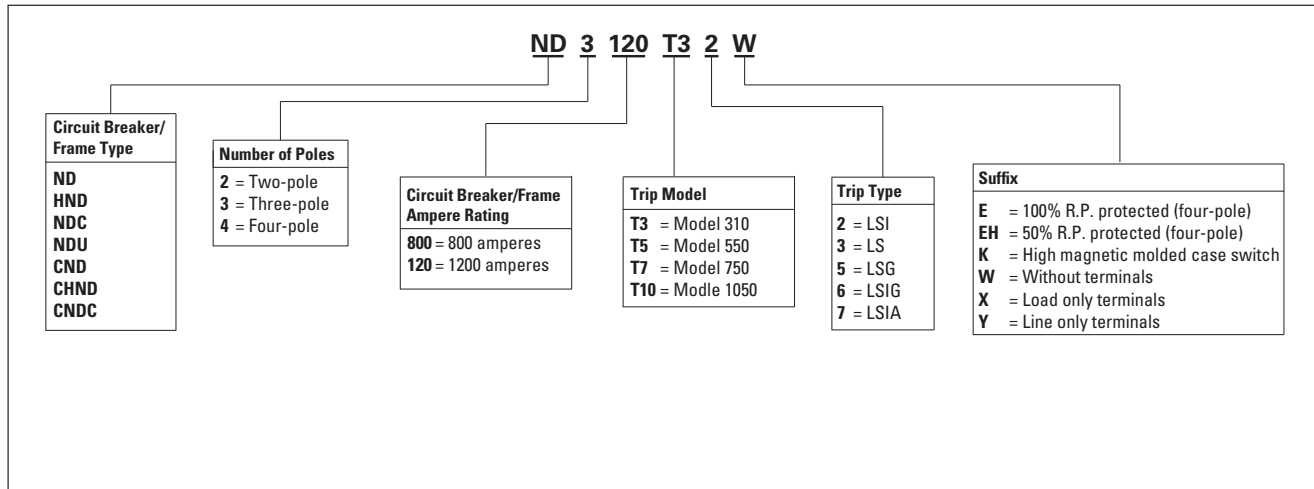

Figure 11. Digitrip 310 Long Delay and Short Delay with Flat Response (1600A) (LSI, LSIG) - Curve Number TC01209006E

Catalog Number Selection

This information is presented only as an aid to understanding catalog numbers. It is not to be used to build catalog numbers for circuit breakers or trip units.



Types ND, CND, HND, CHND, NDC, CNDC, NDU, NGU Equipped With Type NES Digitrip RMS 310 Trip Units With I²t Ramp Short Time Delay (Phase Protection)

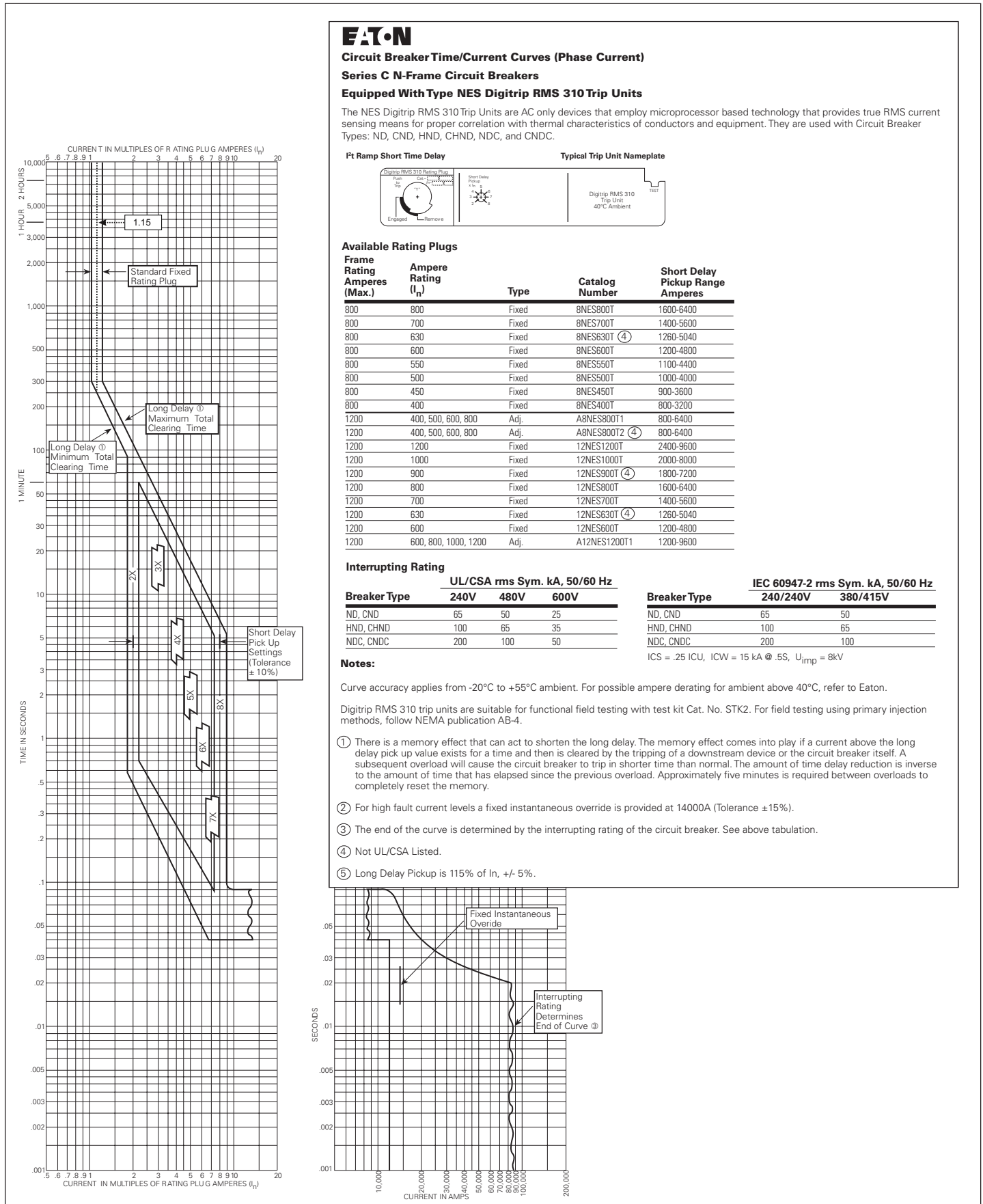

Figure 12. I²T Ramp Short Time Delay (Phase Protection) - Curve Number SC-5375-92A, October 2006

Types ND, CND, HND, CHND, NDC, CNDC, NDU, NGU Equipped With Type NES Digitrip RMS 310 Trip Units With Adjustable Short Time Delay (Phase Protection)



Circuit Breaker Time/Current Curves (Phase Current)

Series C N-Frame Circuit Breakers

Equipped With Type NES Digitrip RMS 310 Trip Units

The NES Digitrip RMS 310 Trip Units are AC only devices that employ microprocessor based technology that provides true RMS current sensing means for proper correlation with thermal characteristics of conductors and equipment. They are used with Circuit Breaker Types: ND, CND, HND, CHND, NDC, and CNDC.

Adjustable Short Time Delay

Typical Trip Unit Nameplate

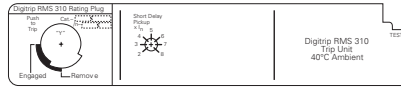

Available Rating Plugs

Frame Rating Amperes (Max.)	Ampere Rating (I_n)	Type	Catalog Number	Short Delay Pickup Range Amperes
800	800	Fixed	8NES800T	1600-6400
800	700	Fixed	8NES700T	1400-5600
800	630	Fixed	8NES630T (4)	1260-5040
800	600	Fixed	8NES600T	1200-4800
800	550	Fixed	8NES550T	1100-4400
800	500	Fixed	8NES500T	1000-4000
800	450	Fixed	8NES450T	900-3600
800	400	Fixed	8NES400T	800-3200
1200	400, 500, 600, 800	Adj.	A8NES800T1	800-6400
1200	400, 500, 600, 800	Adj.	A8NES800T2 (4)	800-6400
1200	1200	Fixed	12NES1200T	2400-9600
1200	1000	Fixed	12NES1000T	2000-8000
1200	900	Fixed	12NES900T (4)	1800-7200
1200	800	Fixed	12NES800T	1600-6400
1200	700	Fixed	12NES700T	1400-5600
1200	630	Fixed	12NES630T (4)	1260-5040
1200	600	Fixed	12NES600T	1200-4800
1200	600, 800, 1000, 1200	Adj.	A12NES1200T1	1200-9600

Interrupting Rating

Breaker Type	UL/CSA rms Sym. kA, 50/60 Hz		
	240V	480V	600V
ND, CND	65	50	25
HND, CHND	100	65	35
NDC, CNDC	200	100	50

Breaker Type	IEC 60947-2 rms Sym. kA, 50/60 Hz	
	240/240V	380/415V
ND, CND	65	50
HND, CHND	100	65
NDC, CNDC	200	100

Notes:

ICS = .25 ICU, ICW = 15 kA @ .5S, U_{imp} = 8kV

Curve accuracy applies from -20°C to +55°C ambient. For possible ampere derating for ambient above 40°C, refer to Eaton.

Digitrip RMS 310 trip units are suitable for functional field testing with test kit Cat. No. STK2. For field testing using primary injection methods, follow NEMA publication AB-4.

① There is a memory effect that can act to shorten the long delay. The memory effect comes into play if a current above the long delay pick up value exists for a time and then is cleared by the tripping of a downstream device or the circuit breaker itself. A subsequent overload will cause the circuit breaker to trip in shorter time than normal. The amount of time delay reduction is inverse to the amount of time that has elapsed since the previous overload. Approximately five minutes is required between overloads to completely reset the memory.

② For high fault current levels a fixed instantaneous override is provided at 14000A (Tolerance $\pm 15\%$).

③ The end of the curve is determined by the interrupting rating of the circuit breaker. See above tabulation.

④ Not UL/CSA Listed.

⑤ Long Delay Pickup is 115% of I_n , $\pm 5\%$.

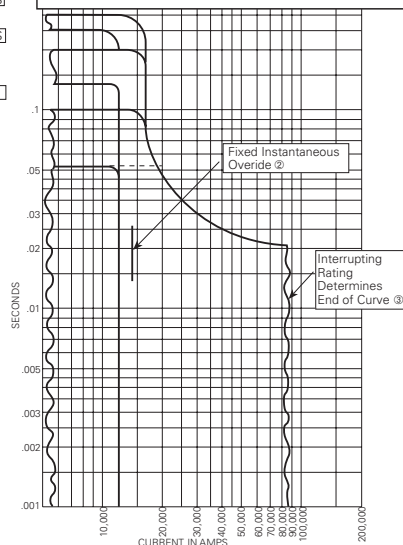
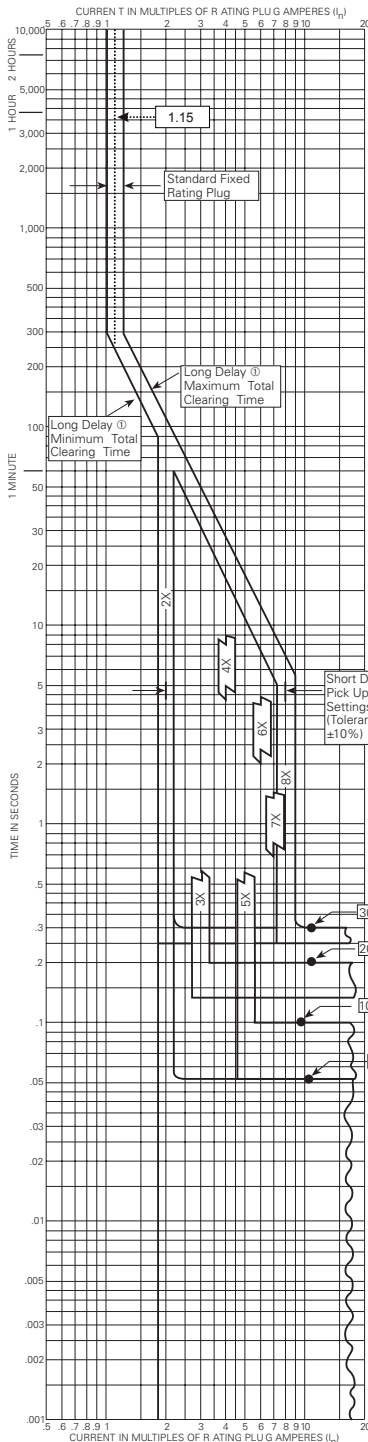

Figure 13. Adjustable Short Time Delay (Phase Protection) - Curve Number SC-5376-92A, October 2006

N-Frame Circuit Breakers Equipped with Digitrip OPTIM Trip Units; Long Delay I²t, Short Delay I²t

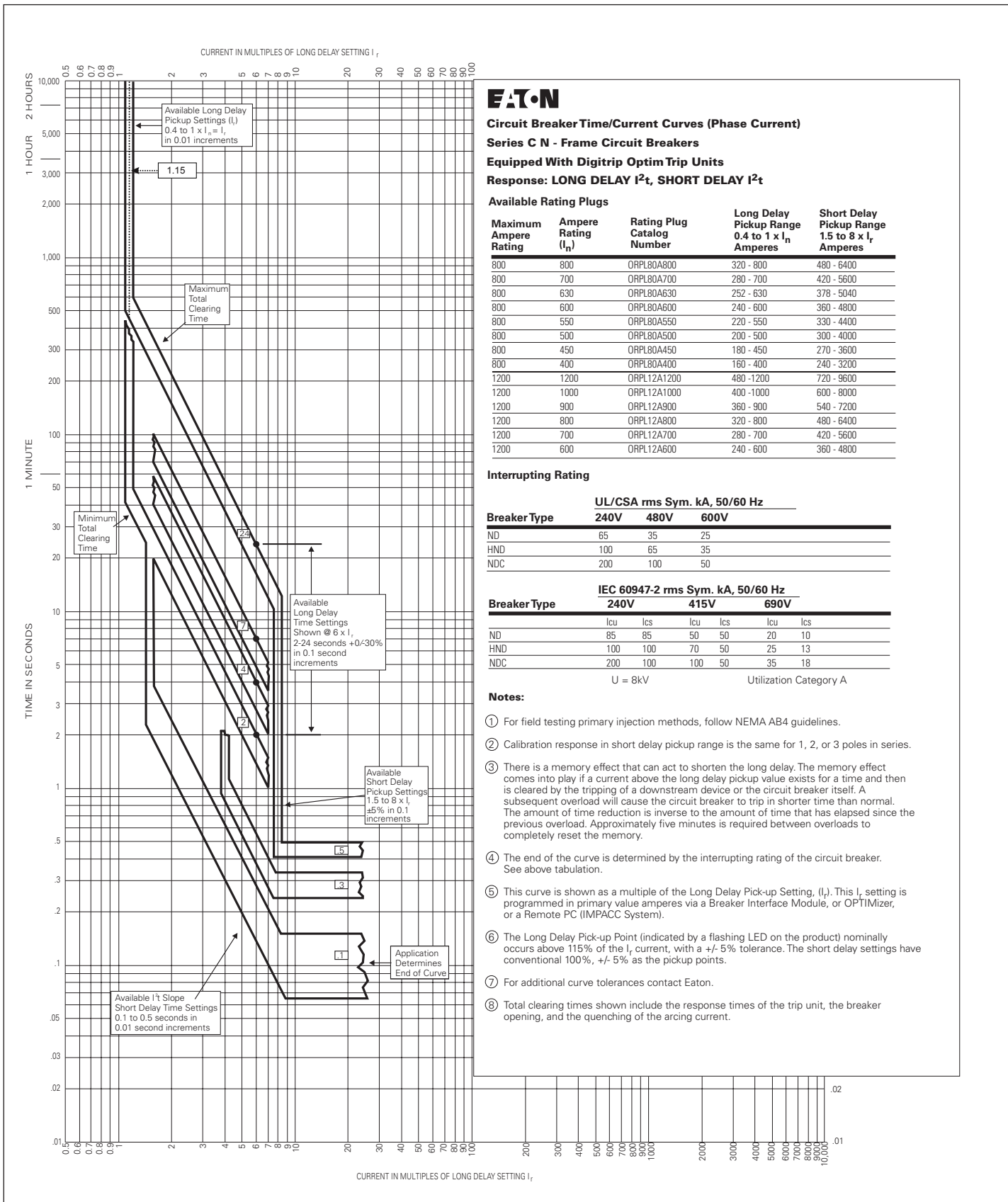

Figure 15. Long Delay I²T, Short Delay I²T - Curver Number SC-6331-96, October 2006

N-Frame Circuit Breakers Equipped with Digitrip OPTIM Trip Units; Long Delay I²t, Short Delay Flat

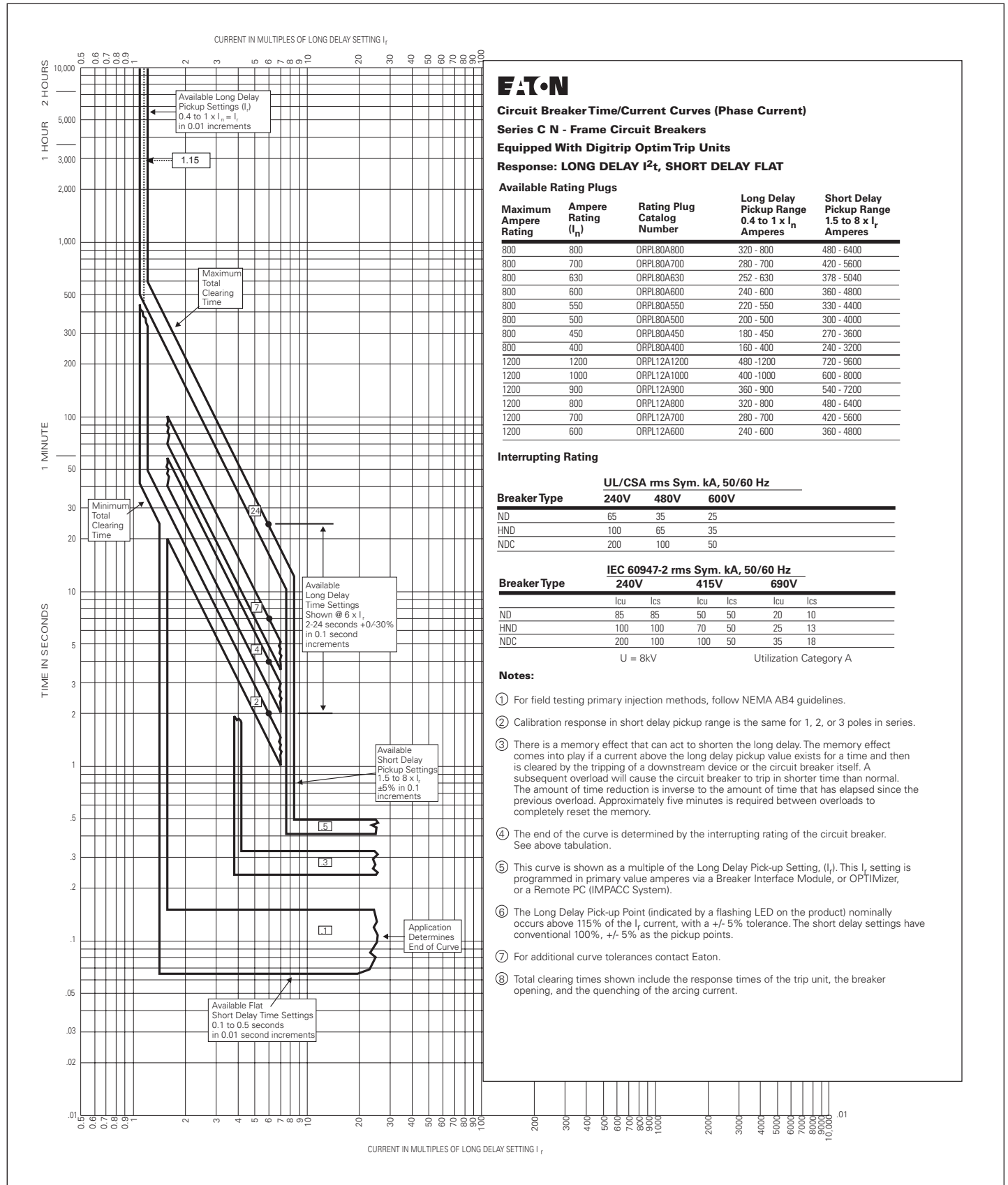

Figure 16. Long Delay I²T, Short Delay Flat - Curve Number SC-6332-96, October 2006

N-Frame Circuit Breakers Equipped with Digitrip OPTIM Trip Units; Long Delay I⁴t, Short Delay Flat

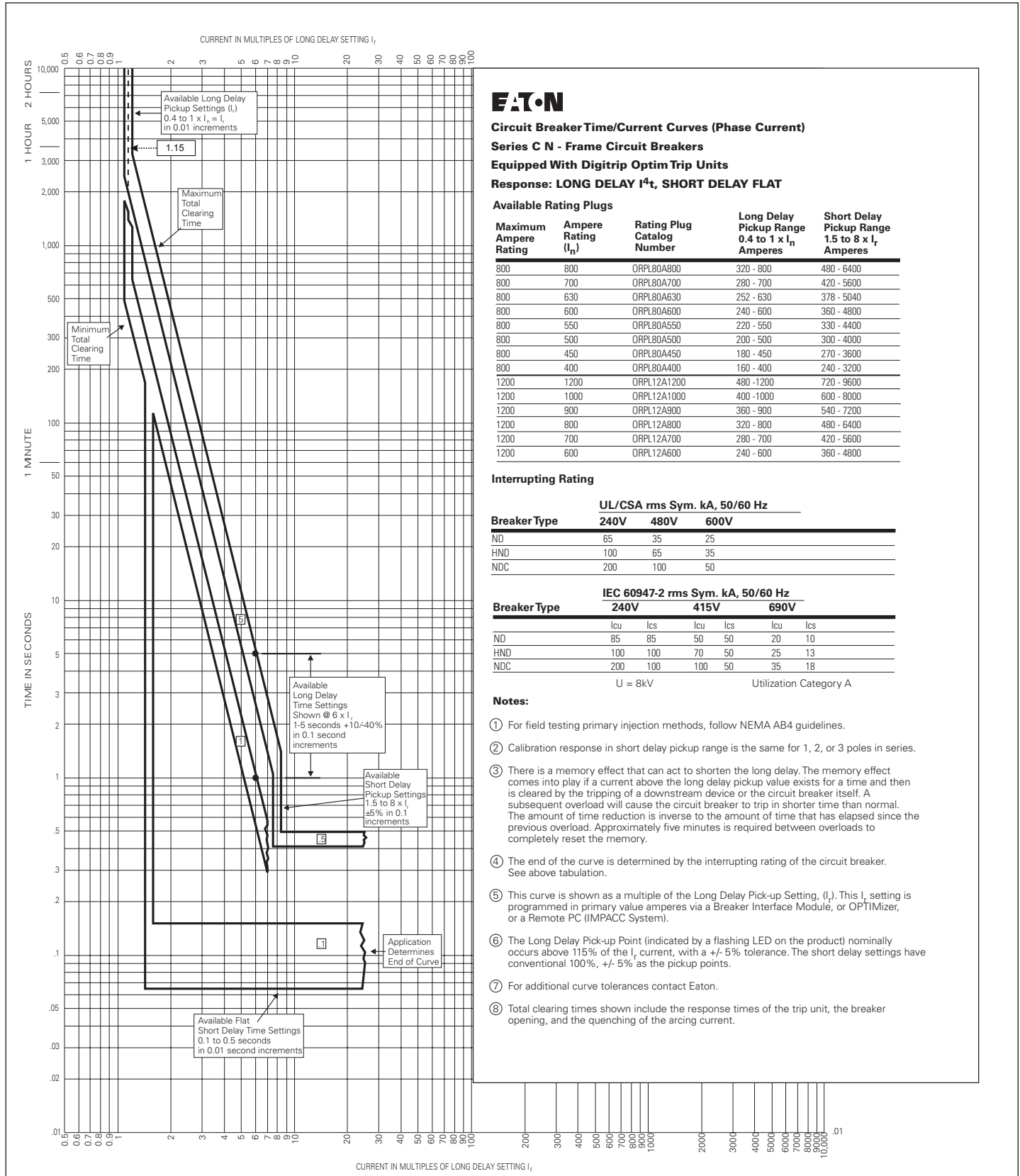
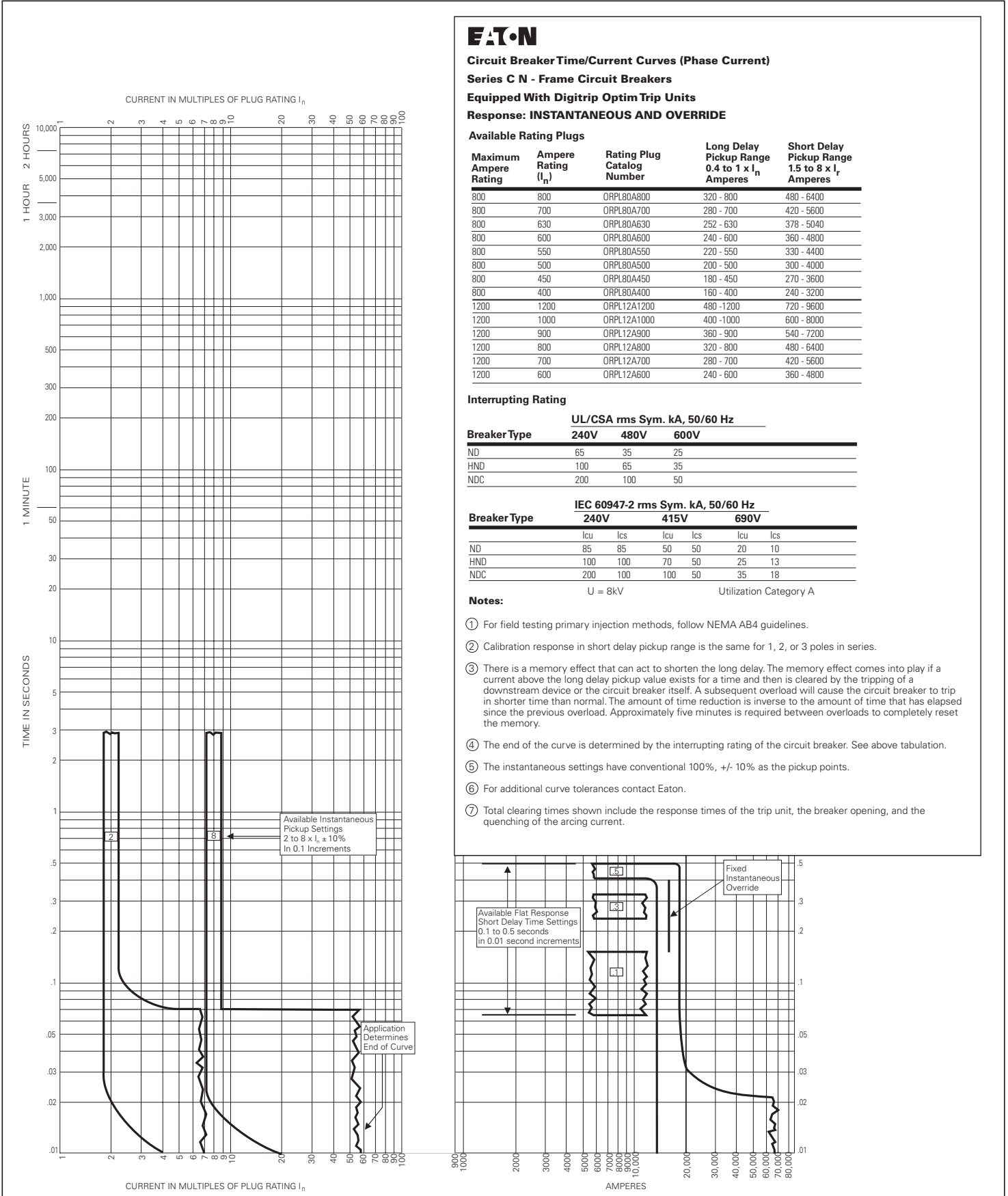

Figure 17. Long Delay I⁴t, Short Delay Flat - Curve Number SC-6333-96, October 2006

N-Frame Circuit Breakers Equipped with Digitrip OPTIM Trip Units; Instantaneous and Override



N-Frame Circuit Breakers Equipped with Digitrip OPTIM Trip Units; Ground Fault or Ground Fault Alarm Only



Circuit Breaker Time/Current Curves (Ground Current)

Series C N - Frame Circuit Breakers

Equipped With Digitrip Optim Trip Units

Response: GROUND FAULT TRIP OR GROUND FAULT ALARM ONLY

Available Rating Plugs

Maximum Ampere Rating	Ground Fault Pickup Range 0.2 to 1.0 x I _s Amperes
800	160-800
1200	240-1200

Interrupting Rating

Breaker Type	UL/CSA rms Sym. kA, 50/60 Hz		
	240V	480V	600V
ND	65	35	25
HND	100	65	35
NDC	200	100	50

Breaker Type	IEC 60947-2 rms Sym. kA, 50/60 Hz					
	240V		415V		690V	
	I _{cu}	I _{cs}	I _{cu}	I _{cs}	I _{cu}	I _{cs}
ND	85	85	50	50	20	10
HND	100	100	70	50	25	13
NDC	200	100	100	50	35	18

U = 8kV

Utilization Category A

Notes:

- For field testing primary injection methods, follow NEMA AB4 guidelines.
- Calibration response in short delay pickup range is the same for 1, 2, or 3 poles in series.
- There is a memory effect that can act to shorten the long delay. The memory effect comes into play if a current above the long delay pickup value exists for a time and then is cleared by the tripping of a downstream device or the circuit breaker itself. A subsequent overload will cause the circuit breaker to trip in shorter time than normal. The amount of time reduction is inverse to the amount of time that has elapsed since the previous overload. Approximately five minutes is required between overloads to completely reset the memory.
- The end of the curve is determined by the interrupting rating of the circuit breaker. See above tabulation.
- The ground fault settings have conventional 100%, +/- 10% as the pickup points.
- For additional curve tolerances contact Eaton.
- Total clearing times shown include the response times of the trip unit, the breaker opening, and the quenching of the arcing current.

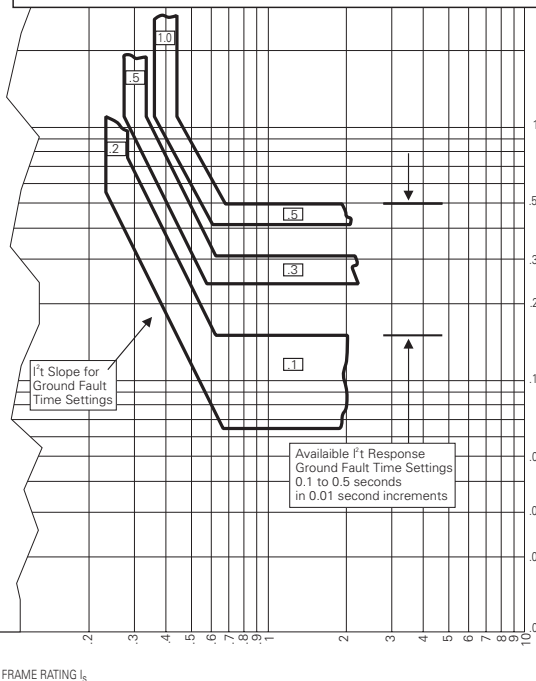
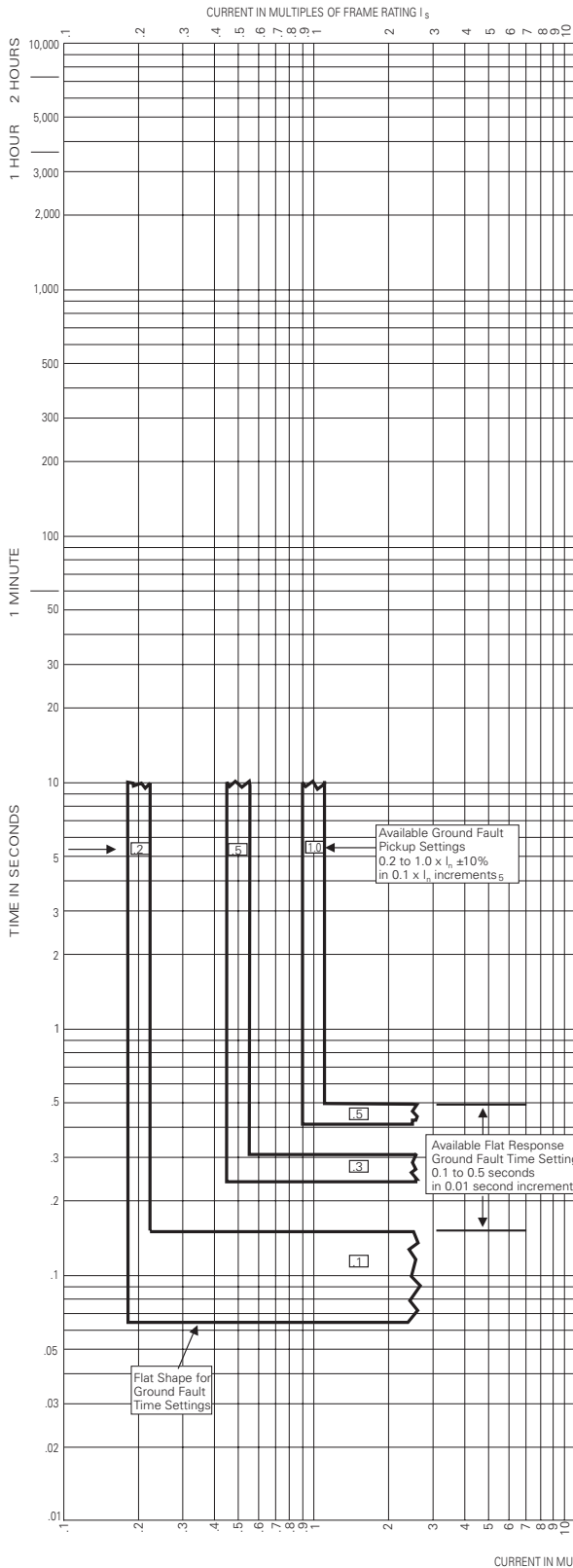

Figure 19. Ground Fault Protection - Cover Number SC-6335-96, October 2006

Eaton
1000 Eaton Boulevard
Cleveland, OH 44122
United States
Eaton.com

© 2014 Eaton
All Rights Reserved
Printed in USA
Publication No. TD012029EN / KDC
April 2014



Eaton is a registered trademark.
All other trademarks are property
of their respective owners.