

FEATURES & SPECIFICATIONS

INTENDED USE — Ideal one-for-one replacement of conventional HID and fluorescent high bay systems. Applications include warehousing, manufacturing, gymnasiums, and other large indoor spaces with mounting heights up to 60'. **Certain airborne contaminants can diminish the integrity of acrylic and/or polycarbonate.** [Click here for Acrylic-Polycarbonate Compatibility table for suitable uses.](#)

CONSTRUCTION — Structural elements such as the channel and end caps are fabricated from steel for maximum rigidity. Wireguard attachment points provided. For high ambient (HA) option, lightweight aluminum heat sink designed to perform in ambient temperatures up to 55 °C for maximum naturally convective cooling.

OPTICS — General, narrow, wide and focus distributions available to meet both horizontal and vertical light level requirements. Injection molded refractors for repeatable photometry. Diffuse lens standard to provide glare control and LED protection.

ELECTRICAL — L88 at 60,000 hours, L70>100,000 hours. Utilizes a 90°C case temperature driver for maximum life at high temperatures. 0.90 power factor and 3kA/6kV level of surge protection is standard. Optional 5kA/10kV surge protection available. Available as 120-277V or 347-480V input.

0-10V dimming standard for a dimming range of 100% to 10%.

WIRELESS NETWORKING — XPoint™ Wireless technology creates a mesh network to ensure communication between fixtures, sensors and wall stations facility-wide. This option provides superior lighting management capabilities including granular control, configuration and custom grouping for increased energy savings.

INSTALLATION — Suitable for suspension by chain, cable, surface-mounting bracket (THUN accessory), hook monopoint or single (pendant) monopoint. Surface mounting not recommended without optional surface mounting bracket. To maintain ambient listing, fixture should be mounted at a minimum plenum height of 18".

LISTINGS — CSA certified to US and Canadian safety standards. Damp location listed. Suitable for ambient temperatures from -40°F (-40°C) to 113°F (45°C) when suspended 18" from ceiling. High ambient option available (HA), suitable for ambient temperatures -40°F (-40°C) to 131°F (55°C) when suspended 18" from ceiling. IP5X rated.

DesignLights Consortium® (DLC) Premium qualified product and DLC qualified product. Not all versions of this product may be DLC Premium qualified or DLC qualified. Please check the DLC Qualified Products List at www.designlights.org/QPL to confirm which versions are qualified.

WARRANTY — 5-year limited warranty. Complete warranty terms located at: www.acuitybrands.com/CustomerResources/Terms_and_conditions.aspx

Note: Actual performance may differ as a result of end-user environment and application. All values are design or typical values, measured under laboratory conditions at 25 °C. Specifications subject to change without notice.

Stock configurations are offered for shorter lead times:

Standard Part Number	Stock Part Number
IBG 12000LM SEF AFL GND MVOLT OZ10 40K 80CRI DWH	IBG 12L MVOLT
IBG 15000LM SEF AFL GND MVOLT OZ10 40K 80CRI DWH	IBG 15L MVOLT
IBG 18000LM SEF AFL GND MVOLT OZ10 40K 80CRI DWH	IBG 18L MVOLT
IBG 24000LM SEF AFL GND MVOLT OZ10 40K 80CRI DWH	IBG 24L MVOLT
IBG 12000LM SEF AFL GND HVOLT OZ10 40K 80CRI DWH	IBG 12L HVOLT
IBG 15000LM SEF AFL GND HVOLT OZ10 40K 80CRI DWH	IBG 15L HVOLT
IBG 18000LM SEF AFL GND HVOLT OZ10 40K 80CRI DWH	IBG 18L HVOLT
IBG 24000LM SEF AFL GND HVOLT OZ10 40K 80CRI DWH	IBG 24L HVOLT
IBG 12000LM SEF AFL GND MVOLT OZ10 50K 80CRI DWH	IBG 12L MVOLT 5K
IBG 15000LM SEF AFL GND MVOLT OZ10 50K 80CRI DWH	IBG 15L MVOLT 5K
IBG 18000LM SEF AFL GND MVOLT OZ10 50K 80CRI DWH	IBG 18L MVOLT 5K
IBG 24000LM SEF AFL GND MVOLT OZ10 50K 80CRI DWH	IBG 24L MVOLT 5K
IBG 12000LM SEF AFL GND HVOLT OZ10 50K 80CRI DWH	IBG 12L HVOLT 5K
IBG 15000LM SEF AFL GND HVOLT OZ10 50K 80CRI DWH	IBG 15L HVOLT 5K
IBG 18000LM SEF AFL GND HVOLT OZ10 50K 80CRI DWH	IBG 18L HVOLT 5K
IBG 24000LM SEF AFL GND HVOLT OZ10 50K 80CRI DWH	IBG 24L HVOLT 5K

Catalog Number
Notes
Type

LED High Bay

IBG



A+ Capable Luminaire

This item is an A+ capable luminaire, which has been designed and tested to provide consistent color appearance and out-of-the-box control compatibility with simple commissioning.

- All configurations of this luminaire meet the Acuity Brands' specification for chromatic consistency
- This luminaire is part of an A+ Certified solution for nLight® or XPoint™ Wireless control networks marked by a **shaded background***

To learn more about A+, visit www.acuitybrands.com/aplus.

*See ordering tree for details

IBG LED High Bay



A+ Capable options indicated by this color background.

ORDERING INFORMATION

Lead times will vary depending on options selected. Consult with your sales representative.

Example: IBG 24000LM SEF AFL GND MVOLT OZ10 40K 80CRI DWH

IBG	Nominal lumens		Performance package		Lens		Distribution		Voltage		Driver		Color temperature		
IBG	8000LM	8,000 lumens	30000LM	30,000 lumens	SEF	Standard efficiency	AFL	Acrylic, frosted	WD	Wide	MVOLT	120-277V	OZ10	0-10V dimming	30K 3000 K
IBGN ¹	12000LM	12,000 lumens	36000LM	36,000 lumens	HEF	Premium efficiency	ACL	Clear acrylic	GND	General	HVOLT	347-480V ²			35K 3500 K
	15000LM	15,000 lumens	48000LM	48,000 lumens			PCL	Clear polycarbonate	ND	Narrow	120	120V			40K 4000 K
	18000LM	18,000 lumens	60000LM	60,000 lumens			PFL	Semi-diffuse polycarbonate	FD	Focus	208	208V			50K 5000 K
	24000LM	24,000 lumens					L/LENS	Less lens			240	240V			
											277	277V			
											347	347V ³			
											480	480V ^{3,4}			

Coloring rendering index	Options				Finish
70CRI 70 CRI	HA	High ambient ⁵			DNA Natural aluminum DWH Gloss white
80CRI 80 CRI	SPD	Surge protection device ⁶	<u>Cord sets:</u>	<u>Controls:</u> ¹⁵	
90CRI 90 CRI	BPK	Fixture backpack ⁷	CS1W	Straight plug, 120V ¹⁵	
	PS1050	Emergency battery pack ⁸	CS3W	Twist-lock, 120V ¹⁵	
	PS10250	Emergency battery pack ⁹	CS7W	Straight plug, 277V ¹⁵	
	PS30250	Emergency battery pack ¹⁰	CS11W	Twist-lock, 277V ¹⁵	
	BGTD	Generator transfer device ¹¹	CS25W	Twist-lock, 347V ¹⁵	
	SF	Single fuse ¹²	CS97W	Twist-lock, 480V ¹⁵	
	DF	Double fuse ¹³	CS93W	600 SO white cord, no plug (no voltage required)	
	OUTCTR	Wiring leads pulled through back center of fixture ¹⁴	CS93W5CD	600 SO 5-conductor white cord, no plug (no voltage required)	
	OCS	RELOC [®] OnePass [®] selectable cable 6' installed ^{15,16}			
	OCU	RELOC [®] OnePass [®] unselectable cable 6' installed (must specify tap position) ¹⁵			
	IMP	Integrated modular plug ¹⁷			
	RRL	RELOC [®] -Ready luminaire. See page 10 for ordering information			
	WGX	Standard wire guard, installed			
				LCOZU	High mount aisleway motion sensor, pre-wired
				LCHOSZU	High mount aisleway motion sensor with dimming, pre-wired
				LCPZU	High mount aisleway motion sensor with photocell, pre-wired
				LAOZU	360° high mount motion sensor, pre-wired
				LAHOSZU	360° high mount motion sensor with dimming, pre-wired
				LAPZU	360° high mount motion sensor with photocell, pre-wired
				LAMOSZU	360° high mount motion sensor, dimming & switching photocell, pre-wired
				LCMOSZU	High mount aisleway motion sensor, dimming & switching photocell, pre-wired
				C6D0SUEM	360° high mount motion sensor, dimming & switching photocell capable, pre-wired; UL924 listed ¹⁸
				C10D0SUEM	360° low mount motion sensor, dimming & switching photocell capable, pre-wired; UL924 listed ¹⁸
				nPP16D	nLight [®] dimming & switching module ¹⁹
				nPP16DER	nLight [®] dimming & switching module with emergency relay ¹⁹
				nMSI	nLight [®] high mount aisleway motion sensor, pre-wired ¹⁹
				nMSI360	nLight [®] 360° high mount motion sensor, pre-wired ¹⁹
				nMSID	nLight [®] high mount aisleway motion sensor with dimming, pre-wired ¹⁹
				nMSI360D	nLight [®] 360° high mount motion sensor with dimming, pre-wired ¹⁹
				MSI6XADL DSCXADL	XPoint™ Wireless 360° high mount motion sensor with photocell ²⁰
				XPW	XPoint™ Wireless 0-10V relay, external (utilizes XPA CMRBO) 55°C max ambient ²⁰
				XAD	XPoint™ Wireless 0-10V relay, internal, lower max ambient ^{20,21}

See Accessories and footnotes on next page

IBG LED High Bay

Accessories: Order as separate catalog number.		
Mounting:		Cord sets and sensors for IMP option:
IBAC120 M20	Aircraft cable 10' with hook (one pair)	CS1WIMP Straight plug, 120V
IBAC240 M20	Aircraft cable 20' with hook (one pair)	CS3WIMP Twist-lock, 120V
IBHMP	Hook monopoint	CS7WIMP Straight plug, 277V
HBBS36	Chain hanger with chain, 36" (one pair)	CS11WIMP Twist-lock, 277V
IBGACVH	Aircraft 10' V hanger (one pair)	CS25WIMP Twist-lock 347V
IBGPMPHB	Pendant monopoint splice box, includes side covers (3/4" hub) for use with OUTCTR option	CS93WIMP 600V SO white cord, no plug (no voltage required)
HC36	Chain hanger and jack chain (pair)	CS97WIMP Twist-lock 480V
THUN	Tong hanger bracket (order 2 per fixture) ²²	MSIIMP1BG Aisle sensor for use with IMP option
		MSI360IMP1BG 360° sensor for use with IMP option
		Wire guards:
		WGIBG22 Wire guard for IBG 2ft 2-module, gloss white
		WGIBG24 Wire guard for IBG 2ft 4-module, gloss white
		WGIBG26 Wire guard for IBG 2ft 6-module, gloss white
		WGIBG42 Wire guard for IBGN 4ft 2-module, gloss white
		WGIBG46 Wire guard for IBG 4ft 6-module, gloss white
		WGIBG22DNA Wire guard for IBG 2ft 2-module, natural aluminum
		WGIBG24DNA Wire guard for IBG 2ft 4-module, natural aluminum
		WGIBG26DNA Wire guard for IBG 2ft 6-module, natural aluminum
		WGIBG42DNA Wire guard for IBGN 4ft 2-module, natural aluminum
		WGIBG46DNA Wire guard for IBG 4ft 6-module, natural aluminum

Notes

- 1 Available with 18000LM, 24000LM, 30000LM and 36000LM only.
- 2 Not available with 8000LM. Not available with BTGD, nPP16D, nPP16DER, PS1050, PS10250, PS30250 or XAD.
- 3 When ordered with 8000LM voltage selected utilizes the fixture back pack.
- 4 Not available with nPP16D or nPP16DER.
- 5 55 C when suspended, 45 C when surface mounted. Not available with BGTD, PS1050, PS10250, PS30250, XAD, or XPW.
- 6 Standard with HVOLT, 347, or 480V - only specify for MVOLT, 120, 208, 240, or 277V. Standard with Motion sensors/controls, BGTD & Power Sentry battery options.
- 7 Required with PS1050, PS10250, PS30250, BGTD. Required with 8000LM when ordered with 347/480V. Required with Xpoint controls when order with 347/480V. Not available with nLight. Not for use with THUN mount (surface).
- 8 Requires BPK option. Available 120-277V only. Available with 8000LM only. For ambient temperatures of 32°F to 122°F (0°C to 50°C). Not available with IMP.
- 9 Requires BPK option. Available 120-277V only. Not available with 8000LM. For ambient temperatures of 50°F to 122°F (10°C to 50°C). Not available with IMP.
- 10 Requires BPK option. 120 or 277V only. Not available with 8000LM. For ambient temperatures of 32°F to 122°F (0°C to 50°C). Not available with IMP.
- 11 Requires BPK option. 120 or 277V only. Not available with PS1050, PS10250, PS30250. Not available with 347 or 480V when ordered in combination with XAD or XPW. For ambient temperatures up to 113°F (45°C).
- 12 Available on 120, 277, 347V. Not available with MVOLT or HVOLT.
- 13 Available on 208, 240, 480V. Not available with MVOLT or HVOLT.
- 14 Not available with BPK option. Requires IBGPMPHB accessory to mount fixture. Not available with Cord Set options.
- 15 Must specify voltage.
- 16 Cannot be used in dimming applications, must use RRLC125
- 17 Not available with BPK, nPP16D, nPP16DER, nMSI, nMSI360, PS1050, PS10250, or PS30250.
- 18 Daylight harvesting functionality not enabled by default. See page 9 for default sequence of operation.
- 19 Not available with 208V, 240V, or 480V.
- 20 Available 120-277V only.
- 21 Not available with HA option.
- 22 Maximum ambient temperature of standard fixture mounted with THUN is 95°F (35°C). With HA option 113°F (45°C).

POWER SENTRY EMERGENCY BATTERY PACKS

PS1050:	http://www.acuitybrands.com/products/detail/369448/Power-Sentry/PS1050/Reduced-Profile-LED-Emergency-Battery-Pack/-/media/products/Power_Sentry/369448/document/PS1050_pdf.pdf
PS10250:	http://www.acuitybrands.com/products/detail/604737/Power-Sentry/PS10250/Emergency-LED-Battery-Backup/-/media/products/Power_Sentry/604737/document/PS10250_pdf.pdf
PS30250:	http://www.acuitybrands.com/products/detail/604739/Power-Sentry/PS30250/Emergency-LED-Battery-Backup/-/media/products/Power_Sentry/604739/document/PS30250_pdf.pdf



IBG LED High Bay

DIMENSIONS

All dimensions are in inches (centimeters) unless otherwise indicated.
Dimensions may vary with options or accessories.

Weight: (may vary with options or accessories)
 8L: 7.75 lbs (3.515Kg)
 12L/15L: 10.5 lbs (4.762Kg)
 18L/24L/30L: 15.9 lbs (7.212Kg)
 18L/24L/30L/36L: 4' Narrow - 16.25 lbs (7.370Kg)
 36L/48L/60L: 4' - 6' Mod - 21.75 lbs (9.865Kg)

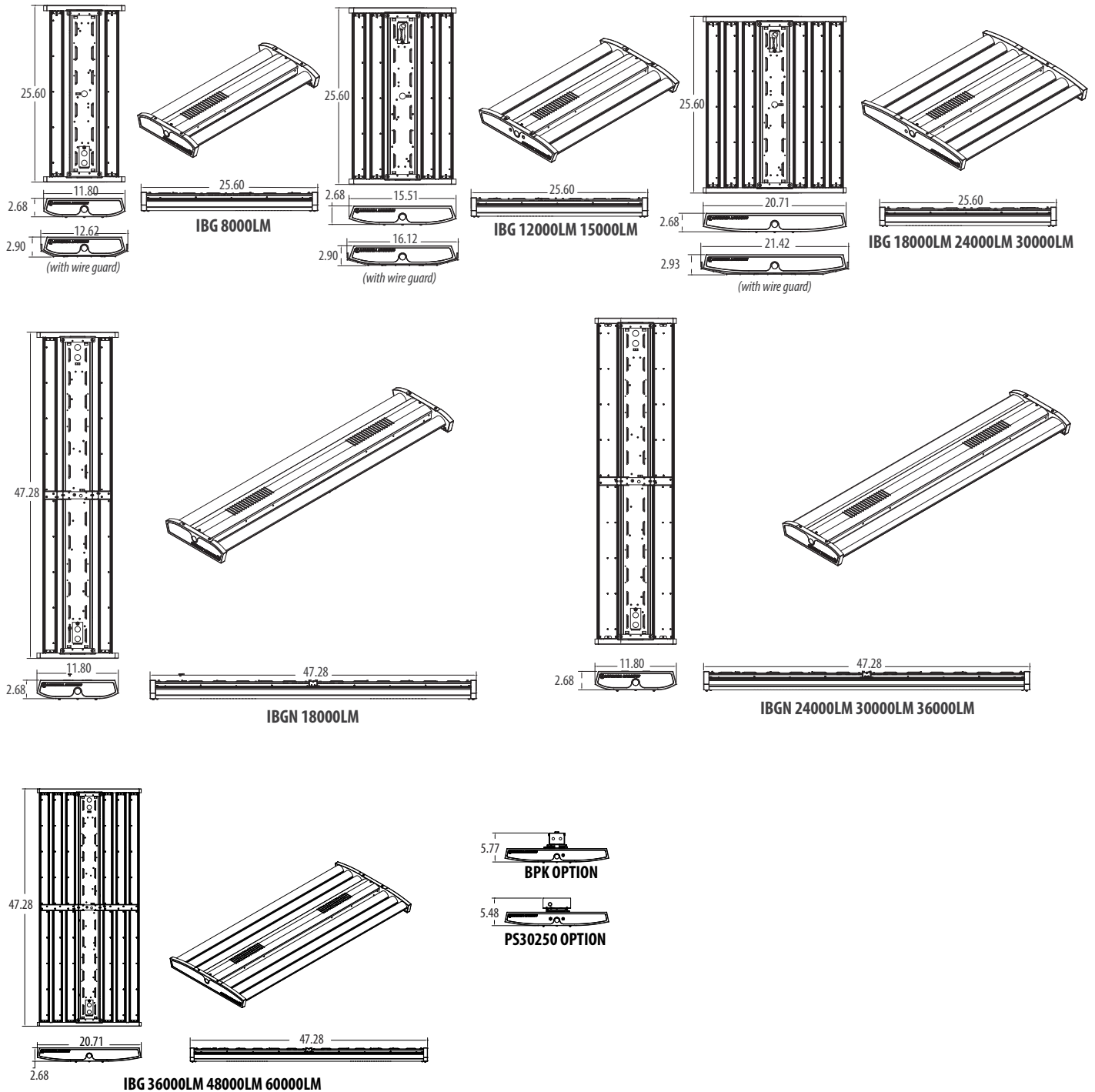

IBG LED High Bay

IBG OPERATIONAL DATA

	Lumen package	Efficiency level	Lens/distribution			
			Acrylic frosted/ general	Clear acrylic/narrow	Clear acrylic/wide	Clear acrylic/focus
Delivered lumens 4000K, 80CRI	8000LM	SEF	7594	7145	7384	7364
		HEF	7842	7378	7625	7604
	12000LM	SEF	11580	10895	11260	11228
		HEF	11746	11051	11421	11390
	15000LM	SEF	14458	13603	14059	14019
		HEF	14824	13947	14415	14374
	18000LM	SEF	17329	16303	16850	16803
		HEF	17752	16702	17262	17214
	24000LM	SEF	23000	21639	22365	22303
		HEF	23612	22215	22960	22896
	30000LM	SEF	27344	25727	26589	26515
		HEF	29577	27827	28760	28680
	36000LM	SEF	33203	31239	34547	32197
		HEF	35528	33426	34547	34450
	48000LM	SEF	45973	43253	44704	44579
		HEF	47254	44458	45949	45821
	60000LM	SEF	55453	52172	53922	53771
		HEF	57027	53653	55452	55298
Delivered lumens 5000K, 80CRI	8000LM	SEF	7873	7408	7656	7635
		HEF	8082	7604	7859	7837
	12000LM	SEF	12006	11296	11674	11642
		HEF	12106	11390	11771	11739
	15000LM	SEF	14990	14103	14576	14536
		HEF	15278	14374	14856	14815
	18000LM	SEF	17966	16904	17470	17422
		HEF	18296	17214	17791	17741
	24000LM	SEF	23847	22436	23188	23123
		HEF	24366	22896	23664	23598
	30000LM	SEF	28351	26674	27568	27491
		HEF	30483	28680	29641	29559
	36000LM	SEF	34221	32196	35605	33183
		HEF	36616	34450	35605	35506
	48000LM	SEF	47665	44845	46349	46220
		HEF	48702	45820	47357	47225
	60000LM	SEF	57494	54093	55906	55751
		HEF	58774	55297	57151	56992

PHOTOMETRICS

See www.lithonia.com.



IBG LED High Bay

IBG CHARACTERISTICS

Lumen package	Wattage								Length	Width	Depth	Comparable Light Source
	Standard efficiency				High efficiency							
	120V	277V	347V	480V	120V	277V	347V	480V	Dimensions are shown in inches (centimeters) unless otherwise noted.			
8000LM	55	54	58	61	50	49	51	54	25.6	11.75	2.75	100W MH, 4-lamp T8 NBF
12000LM	79	77	77	76	70	69	68	67	25.6	15.52	2.75	175W MH, 4-lamp T8 HBF, 2-lamp T5HO
15000LM	97	95	97	96	87	86	86	86	25.6	15.52	2.75	200W MH, 6-lamp T8 NBF
18000LM	114	112	114	115	102	100	102	103	25.6	20.65	2.75	250W MH, 6-lamp T8 HBF, 4-lamp T5HO
24000LM	154	150	150	150	136	133	135	135	25.6	20.65	2.75	400W MH, 6-lamp T5HO
30000LM	193	186	188	188	176	171	173	173	25.6	20.65	2.75	575W MH, 10-lamp T8 HBF
36000LM	225	221	227	229	200	197	203	206	47.29	20.65	2.75	750W MH, 8-lamp T5HO
48000LM	301	293	301	302	267	261	269	270	47.29	20.65	2.75	875W MH, 10-lamp T5HO
60000LM	385	374	378	377	332	323	330	330	47.29	20.65	2.75	1000W MH

IBGN OPERATIONAL DATA

	Lumen package	Efficiency level	Lens/distribution				
			Acrylic frosted/ general	Clear acrylic/narrow	Clear acrylic/wide	Clear acrylic/focus	
			Delivered lumens 4000K, 80CRI		18000LM	SEF	17036
HEF	17776	16724			17285	17237	
		24000LM	SEF	22727	21383	22100	22038
		HEF	24123	22696	23457	23392	
		30000LM	SEF	28642	26948	27851	27773
		HEF	29493	27748	28679	28599	
		36000LM	SEF	34336	32305	33388	33295
		HEF	34912	32846	33948	33853	
Delivered lumens 5000K, 80CRI		18000LM	SEF	17663	16618	17175	17128
		HEF	18320	17237	17814	17765	
		24000LM	SEF	23564	22170	22913	22849
		HEF	24862	23391	24176	24108	
		30000LM	SEF	29696	27940	28876	28796
		HEF	30397	28599	29558	29475	
		36000LM	SEF	35600	33494	34617	34520
		HEF	35982	33853	34988	34890	

IBGN CHARACTERISTICS

Lumen package	Wattage								Length	Width	Depth
	Standard efficiency				High efficiency						
	120V	277V	347V	480V	120V	277V	347V	480V	Dimensions are shown in inches (centimeters) unless otherwise noted.		
18000LM	117	114	115	114	104	102	101	101	47.29	11.75	2.75
24000LM	172	170	167	167	152	150	153	153	47.29	11.75	2.75
30000LM	209	205	208	207	183	180	179	178	47.29	11.75	2.75
36000LM	246	240	242	243	207	203	202	201	47.29	11.75	2.75

PROJECTED LUMEN MAINTENANCE

IBG 2ft & 4ft						
Operating hours	0	15,000	30,000	45,000	60,000	100,000
Lumen maintenance factor	1	0.97	0.95	0.93	0.91	0.86
IBGN						
Operating hours	0	15,000	30,000	45,000	60,000	100,000
Lumen maintenance factor	1	0.97	0.93	0.90	0.87	0.81

EMERGENCY LUMENS (5000K 70CRI)

Fixture	IBG			IBGN
Lumen package	8000LM (PS1050 only)	12000LM - 15000LM	18000LM - 60000LM	18000LM - 36000LM
PS1050/PS10250	1600	1300	1900	1200
PS30250	N/A	4000	2400	3800

LUMENS VS. AMBIENT TEMPERATURE

Ambient °C	Ambient °F	Lumen Multiplier
0	32	1.04
5	41	1.03
10	50	1.02
20	68	1.01
25	77	1.00
30	86	0.99
35	95	0.99
40	104	0.98
45	113	0.97
50	122	0.96
55	131	0.96

AMBIENT TEMPERATURE RATINGS

Mounting	Suspended	Surface
Standard temperature rating	113°F (45°C)	95°F (35°C)
HA option temperature rating	131°F (55°C)	113°F (45°C)

LSXR - Fixture Mount Occupancy Sensor (see www.AcuityControls.com for additional information)

- Three interchangeable lens options to satisfy multiple mounting heights and coverage pattern requirements.
- Integrated mounting bracket drops lens down 3" from chase nipple.
- Single or dual relay versions — designed with robust protection from the harsh switching requirements of T5 and LED loads.
- Photocell and 0-10VDC dimming options.
- No PIR field calibration or sensitivity adjustments required.
- Sensor ambient temperature rating of 14°F (-10°C) to 131°F (55°C).

LSXR configuration	Comparable CMRB sensor	Old style sensor nomenclature
For shortest lead times use one of the following LSXR configurations		
LCOZU	CMRB 50	MSI
LCHOSZU	CMRB 50 D	MSID
LCPZU	CMRB 50 P	MSIPED
LAOZU	CMRB 6	MSI360
LAHOSZU	CMRB 6 D	MSI360D
LAPZU	CMRB 6 P	MSI360PED

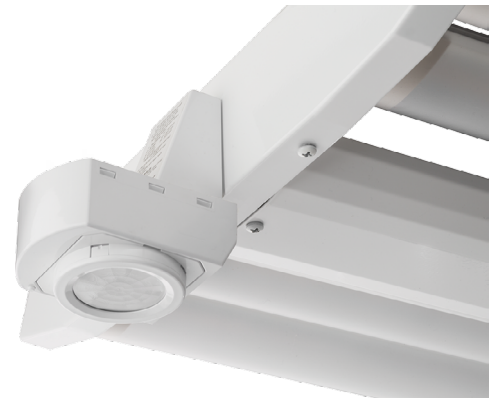

SELECTIONS BELOW WILL EXTEND ORDER LEAD TIME. CONSULT YOUR SALES REPRESENTATIVE FOR DETAILS.

SINGLE RELAY

ORDERING INFORMATION

Example: LAHOSZU

Series	Lens option	Dimming/Photocell	Max. dim level	Min. dim level	Temp/Humidity	Default occupancy time delay
L LSXR passive infrared indoor occupancy sensor	A High mount, 360°	O None ¹	0 10 VDC	S Minimum dim level of ballast	Z None	I 30 sec
		H High/low occupancy operation	9 9 VDC	1 1 VDC	T Low temperature ²	D 2.5 min
	B Low mount, 360°	P Switching photocell (on/off) ¹	8 8 VDC	2 2 VDC		X 5.0 min
		M Dimming and switching photocell	7 7 VDC	3 3 VDC		R 7.5 min
	C High mount aisleway	G Dimming and switching photocell with high/low occupancy operation		4 4 VDC		U 10.0 min (with minimum 15 minute on time)
				5 5 VDC		V 15.0 min
				6 6 VDC		W 20.0 min
					Y 30.0 min	

Notes

- 1 Max and min dim levels not applicable with this option.
- 2 Ambient temperature rating of -4°F (-20°C) to 131°F (55°C).

DUAL RELAY (Available with 120, 277, and 347V only)

ORDERING INFORMATION

Example: LA2KZU

Series	Lens option	Poles	Operating mode	Temp/Humidity	Default occupancy time delay
L LSXR passive infrared indoor occupancy sensor	A High mount, 360° B Low mount, 360° C High mount aisleway	2 Dual relay	J None	Z None	I 30 sec
			K Alternating off relays (promotes even lamp wear)	T Low temperature ¹	D 2.5 min
			O Alternating off relays w/photocell		X 5.0 min
			P Switching photocell(on/off)		R 7.5 min
			E Photocell on/off (pole 1 only)		U 10.0 min (with minimum 15 minute on time)
			F Photocell on/off - both poles (dual set-point)		V 15.0 min
					W 20.0 min
					Y 30.0 min

Notes

- 1 Ambient temperature rating of -4°F (-20°C) to 131°F (55°C).

Example: LENS 50 J100

Replacement lenses: Order as separate catalog number.		
Series	Lens type	Package quantity
LENS	6 High mount 360°	[blank] Single Lens
	10 Low mount 360°	J10 10-pack
	50 High mount aisleway	J100 100-pack

LSXR COVERAGE PATTERNS

HIGH MOUNT 360° LENS (#6)

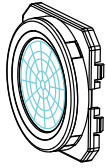

- Best choice for 15 to 45 ft (4.57 to 13.72 m) mounting heights
- 15 to 20 ft (4.57 to 6.10 m) radial coverage overlaps area lit by a typical high bay fixture
- Excellent detection of large motion (e.g. walking) up to a 35 ft (10.76 m) mounting height
- Excellent detection of extra large motion (e.g. forklifts) up to a 45 ft (13.72 m) mounting height

LOW VIEW

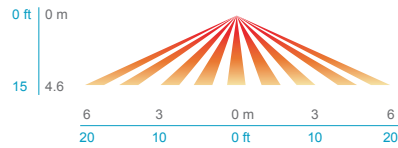

HIGH VIEW

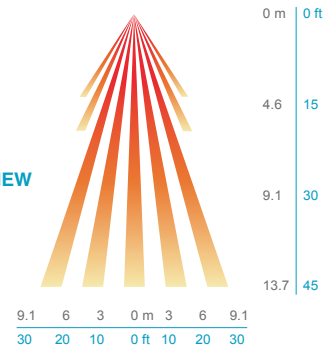

HIGH MOUNT AISLEWAY LENS (#50)

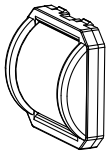

- Provides a bi-directional coverage pattern ideal for warehouse racking
- 1.2x mounting height equals approximate detection range in either direction
- Typical 40 ft (12.19 m) mounting detects 50 ft (15.24 m) in either direction
- Superior aisleway coverage compared to a masked 360° lens

SIDE VIEW

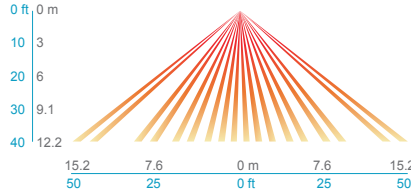

TOP VIEW

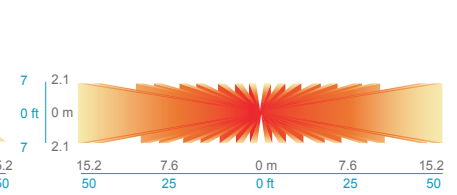

LOW MOUNT 360° LENS (#10)

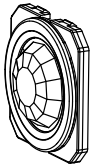

- Best choice for large motion detection (e.g. walking)
- 360° conical shaped pattern
- Provides ~24 ft (7.32 m) radial coverage (~2000 ft²) when mounted at 9 ft (2.74 m)
- 7 to 15 ft (2.13 to 4.57 m) mounting heights provide 16 to 36 ft (4.88 to 10.97 m) radial coverage
- Detection range improves when walking across beams compared to into beams

SIDE VIEW

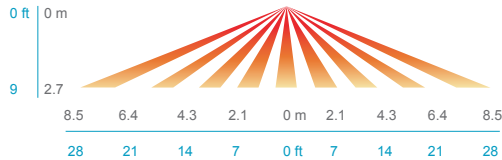

TOP VIEW

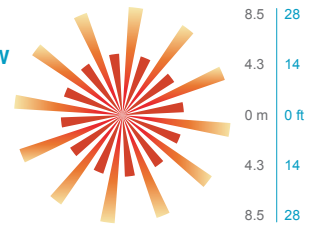

C6DOSUEM & C10DOSUEM - UL924 Listed Sensors

SENSOR DEFAULT SEQUENCE OF OPERATION

- The occupied light level is full output.
- The unoccupied light level is approximately 30%.
- The time delay following sensor vacancy is 5 minutes, with an additional 5 minute slow ramp from the occupied light level to the unoccupied light level.
- **The onboard daylight sensor is not enabled by default - sensor will not respond to changing daylight conditions.**

Daylight sensor settings can be enabled and programmed by a trained technician after installation.

EGRESS MODE SEQUENCE OF OPERATION

The UL924 C6DOSUEM & C10DOSUEM controls are designed to provide fully tuned light output for 90 minutes following power loss or interruption, ignoring automatic dimming/occupancy/daylight control signals during this time.

- Typical sequence upon power loss: Backup power source activates, transfer switch moves the emergency circuit powering the sensor onto the backup source, and sensor regains power. This sensor is programmed to detect any power interruption or transfer > 30 ms
- The sensor then ignores occupancy & daylight status and controls the luminaire to full light output for 90 minutes.
- The device resumes normal dimming & occupancy controls after 90 minutes.
- This sensor should not be used with online power backup systems or any transfer devices with < 30 ms transfer time.

IBG LED High Bay

IMP - Integrated Modular Plug

- The integrated modular plug (IMP) option allows the installer to plug and play a multitude of accessories.
- Cord sets connect quickly to any fixture with IMP option.
- IMP accessories include occupancy sensors, photocells, X-point relays.

IMP compatible cord sets ¹	
CS1WIMP	Straight plug, 120V
CS3WIMP	Twist-lock, 120V
CS7WIMP	Straight plug, 277V
CS11WIMP	Twist-lock, 277V
CS25WIMP	Twist-lock, 347V
CS93WIMP	600V SE00W white cord, no plug
CS97WIMP	Twist-lock, 480V

IMP compatible sensors	
MSIIMP	Aisle sensor
MSI360IMP	360° sensor

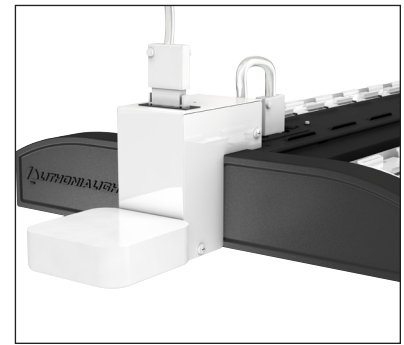

Notes

- 1 Cord set required for fixture operation. All cord sets are 18/3, 6' white.

RRL - RELOC®-Ready Luminaire

- RRL connectors can be used with Quick-Flex®, System 820 and OnePass® systems.
- Load side of connector factory installed to luminaire.
- 4-pole mating connector with push-in terminations allows for simple installation.
- Touch-safe design on both halves meets UL/CSA requirement.
- Wiping contact design allows safe disconnect under load.



ORDERING INFORMATION

Lead times will vary depending on options selected. Consult with your sales representative.

Example: RRLA

Series	Wiring instructions			
RRL RELOC®-ready luminaire	A	Hot conductor wired to position #1 (phase A); non-dimming	AE	Hot conductor wired to position #1 (phase A), hot conductor #2 wired to position #2 (phase B); non-dimming ²
	B	Hot conductor wired to position #2 (phase B); non-dimming	ABE	Hot conductor wired to position #1 (phase A), hot conductor #2 wired to position #2 (phase B), inverter conductor wired to position #3 (phase C); non-dimming ^{1,2}
	C	Hot conductor wired to position #3 (phase C); non-dimming ¹	C12S	Hot conductor in position #1 (phase A), low voltage conductor #1 in position #2, low voltage conductor #2 in position #3; dimming ^{1,3}
	AB	Outboard hot conductor wired to position #1 (phase A), inboard hot conductor wired to position #2 (phase B); non-dimming		

Compatible RELOC® Cables for Industrial Luminaires (ordered and shipped separately)

(click to view RELOC product page for more information)



Notes

- 1 C, ABE, and C12S options are not used with Quick-Flex QFC, QSFC, QPT, and QD.
- 2 AE and ABE commercial fixtures should disconnect the TSPL before unplugging the RRL so it does not go into discharge mode.
- 3 C12S option is used with the OnePass OD and 820 SSC, PT, and DC for 0-10V/DALI applications.

FEATURES & SPECIFICATIONS

INTENDED USE — Ideal one-for-one replacement of conventional HID and fluorescent high bay systems. Applications include warehousing, manufacturing, gymnasiums, and other large indoor spaces with mounting heights up to 60'. **Certain airborne contaminants can diminish the integrity of acrylic and/or polycarbonate.** [Click here for Acrylic-Polycarbonate Compatibility table for suitable uses.](#)

CONSTRUCTION — Structural elements such as the channel and end caps are fabricated from steel for maximum rigidity. Wireguard attachment points provided. For high ambient (HA) option, lightweight aluminum heat sink designed to perform in ambient temperatures up to 55 °C for maximum naturally convective cooling.

OPTICS — General, narrow, wide and focus distributions available to meet both horizontal and vertical light level requirements. Injection molded refractors for repeatable photometry. Diffuse lens standard to provide glare control and LED protection.

ELECTRICAL — L88 at 60,000 hours, L70>100,000 hours. Utilizes a 90°C case temperature driver for maximum life at high temperatures. 0.90 power factor and 3kA/6kV level of surge protection is standard. Optional 5kA/10kV surge protection available. Available as 120-277V or 347-480V input.

0-10V dimming standard for a dimming range of 100% to 10%.

WIRELESS NETWORKING — XPoint™ Wireless technology creates a mesh network to ensure communication between fixtures, sensors and wall stations facility-wide. This option provides superior lighting management capabilities including granular control, configuration and custom grouping for increased energy savings.

INSTALLATION — Suitable for suspension by chain, cable, surface-mounting bracket (THUN accessory), hook monopoint or single (pendant) monopoint. Surface mounting not recommended without optional surface mounting bracket. To maintain ambient listing, fixture should be mounted at a minimum plenum height of 18".

LISTINGS — CSA certified to US and Canadian safety standards. Damp location listed. Suitable for ambient temperatures from -40°F (-40°C) to 113°F (45°C) when suspended 18" from ceiling. High ambient option available (HA), suitable for ambient temperatures -40°F (-40°C) to 131°F (55°C) when suspended 18" from ceiling. IP5X rated.

DesignLights Consortium® (DLC) Premium qualified product and DLC qualified product. Not all versions of this product may be DLC Premium qualified or DLC qualified. Please check the DLC Qualified Products List at www.designlights.org/QPL to confirm which versions are qualified.

WARRANTY — 5-year limited warranty. Complete warranty terms located at: www.acuitybrands.com/CustomerResources/Terms_and_conditions.aspx

Note: Actual performance may differ as a result of end-user environment and application. All values are design or typical values, measured under laboratory conditions at 25 °C. Specifications subject to change without notice.

Stock configurations are offered for shorter lead times:

Standard Part Number	Stock Part Number
IBG 12000LM SEF AFL GND MVOLT OZ10 40K 80CRI DWH	IBG 12L MVOLT
IBG 15000LM SEF AFL GND MVOLT OZ10 40K 80CRI DWH	IBG 15L MVOLT
IBG 18000LM SEF AFL GND MVOLT OZ10 40K 80CRI DWH	IBG 18L MVOLT
IBG 24000LM SEF AFL GND MVOLT OZ10 40K 80CRI DWH	IBG 24L MVOLT
IBG 12000LM SEF AFL GND HVOLT OZ10 40K 80CRI DWH	IBG 12L HVOLT
IBG 15000LM SEF AFL GND HVOLT OZ10 40K 80CRI DWH	IBG 15L HVOLT
IBG 18000LM SEF AFL GND HVOLT OZ10 40K 80CRI DWH	IBG 18L HVOLT
IBG 24000LM SEF AFL GND HVOLT OZ10 40K 80CRI DWH	IBG 24L HVOLT
IBG 12000LM SEF AFL GND MVOLT OZ10 50K 80CRI DWH	IBG 12L MVOLT 5K
IBG 15000LM SEF AFL GND MVOLT OZ10 50K 80CRI DWH	IBG 15L MVOLT 5K
IBG 18000LM SEF AFL GND MVOLT OZ10 50K 80CRI DWH	IBG 18L MVOLT 5K
IBG 24000LM SEF AFL GND MVOLT OZ10 50K 80CRI DWH	IBG 24L MVOLT 5K
IBG 12000LM SEF AFL GND HVOLT OZ10 50K 80CRI DWH	IBG 12L HVOLT 5K
IBG 15000LM SEF AFL GND HVOLT OZ10 50K 80CRI DWH	IBG 15L HVOLT 5K
IBG 18000LM SEF AFL GND HVOLT OZ10 50K 80CRI DWH	IBG 18L HVOLT 5K
IBG 24000LM SEF AFL GND HVOLT OZ10 50K 80CRI DWH	IBG 24L HVOLT 5K

Catalog Number
Notes
Type

LED High Bay

IBG



A+ Capable Luminaire

This item is an A+ capable luminaire, which has been designed and tested to provide consistent color appearance and out-of-the-box control compatibility with simple commissioning.

- All configurations of this luminaire meet the Acuity Brands' specification for chromatic consistency
- This luminaire is part of an A+ Certified solution for nLight® or XPoint™ Wireless control networks marked by a **shaded background***

To learn more about A+, visit www.acuitybrands.com/aplus.

*See ordering tree for details

IBG LED High Bay



A+ Capable options indicated by this color background.

ORDERING INFORMATION

Lead times will vary depending on options selected. Consult with your sales representative.

Example: IBG 24000LM SEF AFL GND MVOLT OZ10 40K 80CRI DWH

IBG	Nominal lumens		Performance package		Lens		Distribution		Voltage		Driver		Color temperature		
IBG	8000LM	8,000 lumens	30000LM	30,000 lumens	SEF	Standard efficiency	AFL	Acrylic, frosted	WD	Wide	MVOLT	120-277V	OZ10	0-10V dimming	30K 3000 K
IBGN ¹	12000LM	12,000 lumens	36000LM	36,000 lumens	HEF	Premium efficiency	ACL	Clear acrylic	GND	General	HVOLT	347-480V ²			35K 3500 K
	15000LM	15,000 lumens	48000LM	48,000 lumens			PCL	Clear polycarbonate	ND	Narrow	120	120V			40K 4000 K
	18000LM	18,000 lumens	60000LM	60,000 lumens			PFL	Semi-diffuse polycarbonate	FD	Focus	208	208V			50K 5000 K
	24000LM	24,000 lumens					L/LENS	Less lens			240	240V			
											277	277V			
											347	347V ³			
											480	480V ^{3,4}			

Coloring rendering index	Options				Finish
70CRI 70 CRI	HA	High ambient ⁵			DNA Natural aluminum DWH Gloss white
80CRI 80 CRI	SPD	Surge protection device ⁶	<u>Cord sets:</u>	<u>Controls:</u> ¹⁵	
90CRI 90 CRI	BPK	Fixture backpack ⁷	CS1W	Straight plug, 120V ¹⁵	
	PS1050	Emergency battery pack ⁸	CS3W	Twist-lock, 120V ¹⁵	
	PS10250	Emergency battery pack ⁹	CS7W	Straight plug, 277V ¹⁵	
	PS30250	Emergency battery pack ¹⁰	CS11W	Twist-lock, 277V ¹⁵	
	BGTD	Generator transfer device ¹¹	CS25W	Twist-lock, 347V ¹⁵	
	SF	Single fuse ¹²	CS97W	Twist-lock, 480V ¹⁵	
	DF	Double fuse ¹³	CS93W	600 SO white cord, no plug (no voltage required)	
	OUTCTR	Wiring leads pulled through back center of fixture ¹⁴	CS93W5CD	600 SO 5-conductor white cord, no plug (no voltage required)	
	OCS	RELOC [®] OnePass [®] selectable cable 6' installed ^{15,16}			
	OCU	RELOC [®] OnePass [®] unselectable cable 6' installed (must specify tap position) ¹⁵			
	IMP	Integrated modular plug ¹⁷			
	RRL	RELOC [®] -Ready luminaire. See page 10 for ordering information			
	WGX	Standard wire guard, installed			
				LCOZU	High mount aisleway motion sensor, pre-wired
				LCHOSZU	High mount aisleway motion sensor with dimming, pre-wired
				LCPZU	High mount aisleway motion sensor with photocell, pre-wired
				LAOZU	360° high mount motion sensor, pre-wired
				LAHOSZU	360° high mount motion sensor with dimming, pre-wired
				LAPZU	360° high mount motion sensor with photocell, pre-wired
				LAMOSZU	360° high mount motion sensor, dimming & switching photocell, pre-wired
				LCMOSZU	High mount aisleway motion sensor, dimming & switching photocell, pre-wired
				C6D0SUEM	360° high mount motion sensor, dimming & switching photocell capable, pre-wired; UL924 listed ¹⁸
				C10D0SUEM	360° low mount motion sensor, dimming & switching photocell capable, pre-wired; UL924 listed ¹⁸
				nPP16D	nLight [®] dimming & switching module ¹⁹
				nPP16DER	nLight [®] dimming & switching module with emergency relay ¹⁹
				nMSI	nLight [®] high mount aisleway motion sensor, pre-wired ¹⁹
				nMSI360	nLight [®] 360° high mount motion sensor, pre-wired ¹⁹
				nMSID	nLight [®] high mount aisleway motion sensor with dimming, pre-wired ¹⁹
				nMSI360D	nLight [®] 360° high mount motion sensor with dimming, pre-wired ¹⁹
				MSI6XADL DSCXADL	XPoint [™] Wireless 360° high mount motion sensor with photocell ²⁰
				XPW	XPoint [™] Wireless 0-10V relay, external (utilizes XPA CMRBO) 55°C max ambient ²⁰
				XAD	XPoint [™] Wireless 0-10V relay, internal, lower max ambient ^{20,21}

See Accessories and footnotes on next page

IBG LED High Bay

Accessories: Order as separate catalog number.		
Mounting:		
IBAC120 M20	Aircraft cable 10' with hook (one pair)	
IBAC240 M20	Aircraft cable 20' with hook (one pair)	
IBHMP	Hook monopoint	
HBBS36	Chain hanger with chain, 36" (one pair)	
IBGACVH	Aircraft 10' V hanger (one pair)	
IBGPMPHB	Pendant monopoint splice box, includes side covers (3/4" hub) for use with OUTCTR option	
HC36	Chain hanger and jack chain (pair)	
THUN	Tong hanger bracket (order 2 per fixture) ²²	
	Cord sets and sensors for IMP option:	
	CS1WIMP	Straight plug, 120V
	CS3WIMP	Twist-lock, 120V
	CS7WIMP	Straight plug, 277V
	CS11WIMP	Twist-lock, 277V
	CS25WIMP	Twist-lock 347V
	CS93WIMP	600V SO white cord, no plug (no voltage required)
	CS97WIMP	Twist-lock 480V
	MSIIMP1BG	Aisle sensor for use with IMP option
	MSI360IMP1BG	360° sensor for use with IMP option
	Wire guards:	
	WGIBG22	Wire guard for IBG 2ft 2-module, gloss white
	WGIBG24	Wire guard for IBG 2ft 4-module, gloss white
	WGIBG26	Wire guard for IBG 2ft 6-module, gloss white
	WGIBG42	Wire guard for IBGN 4ft 2-module, gloss white
	WGIBG46	Wire guard for IBG 4ft 6-module, gloss white
	WGIBG22DNA	Wire guard for IBG 2ft 2-module, natural aluminum
	WGIBG24DNA	Wire guard for IBG 2ft 4-module, natural aluminum
	WGIBG26DNA	Wire guard for IBG 2ft 6-module, natural aluminum
	WGIBG42DNA	Wire guard for IBGN 4ft 2-module, natural aluminum
	WGIBG46DNA	Wire guard for IBG 4ft 6-module, natural aluminum

Notes

- 1 Available with 18000LM, 24000LM, 30000LM and 36000LM only.
- 2 Not available with 8000LM. Not available with BTGD, nPP16D, nPP16DER, PS1050, PS10250, PS30250 or XAD.
- 3 When ordered with 8000LM voltage selected utilizes the fixture back pack.
- 4 Not available with nPP16D or nPP16DER.
- 5 55 C when suspended, 45 C when surface mounted. Not available with BGTD, PS1050, PS10250, PS30250, XAD, or XPW.
- 6 Standard with HVOLT, 347, or 480V - only specify for MVOLT, 120, 208, 240, or 277V. Standard with Motion sensors/controls, BGTD & Power Sentry battery options.
- 7 Required with PS1050, PS10250, PS30250, BGTD. Required with 8000LM when ordered with 347/480V. Required with Xpoint controls when order with 347/480V. Not available with nLight. Not for use with THUN mount (surface).
- 8 Requires BPK option. Available 120-277V only. Available with 8000LM only. For ambient temperatures of 32°F to 122°F (0°C to 50°C). Not available with IMP.
- 9 Requires BPK option. Available 120-277V only. Not available with 8000LM. For ambient temperatures of 50°F to 122°F (10°C to 50°C). Not available with IMP.
- 10 Requires BPK option. 120 or 277V only. Not available with 8000LM. For ambient temperatures of 32°F to 122°F (0°C to 50°C). Not available with IMP.
- 11 Requires BPK option. 120 or 277V only. Not available with PS1050, PS10250, PS30250. Not available with 347 or 480V when ordered in combination with XAD or XPW. For ambient temperatures up to 113°F (45°C).
- 12 Available on 120, 277, 347V. Not available with MVOLT or HVOLT.
- 13 Available on 208, 240, 480V. Not available with MVOLT or HVOLT.
- 14 Not available with BPK option. Requires IBGPMPHB accessory to mount fixture. Not available with Cord Set options.
- 15 Must specify voltage.
- 16 Cannot be used in dimming applications, must use RRLC125
- 17 Not available with BPK, nPP16D, nPP16DER, nMSI, nMSI360, PS1050, PS10250, or PS30250.
- 18 Daylight harvesting functionality not enabled by default. See page 9 for default sequence of operation.
- 19 Not available with 208V, 240V, or 480V.
- 20 Available 120-277V only.
- 21 Not available with HA option.
- 22 Maximum ambient temperature of standard fixture mounted with THUN is 95°F (35°C). With HA option 113°F (45°C).

POWER SENTRY EMERGENCY BATTERY PACKS

PS1050:	http://www.acuitybrands.com/products/detail/369448/Power-Sentry/PS1050/Reduced-Profile-LED-Emergency-Battery-Pack/-/media/products/Power_Sentry/369448/document/PS1050_pdf.pdf
PS10250:	http://www.acuitybrands.com/products/detail/604737/Power-Sentry/PS10250/Emergency-LED-Battery-Backup/-/media/products/Power_Sentry/604737/document/PS10250_pdf.pdf
PS30250:	http://www.acuitybrands.com/products/detail/604739/Power-Sentry/PS30250/Emergency-LED-Battery-Backup/-/media/products/Power_Sentry/604739/document/PS30250_pdf.pdf



IBG LED High Bay

DIMENSIONS

All dimensions are in inches (centimeters) unless otherwise indicated.
Dimensions may vary with options or accessories.

Weight: (may vary with options or accessories)
 8L: 7.75 lbs (3.515Kg)
 12L/15L: 10.5 lbs (4.762Kg)
 18L/24L/30L: 15.9 lbs (7.212Kg)
 18L/24L/30L/36L: 4' Narrow - 16.25 lbs (7.370Kg)
 36L/48L/60L: 4' - 6' Mod - 21.75 lbs (9.865Kg)

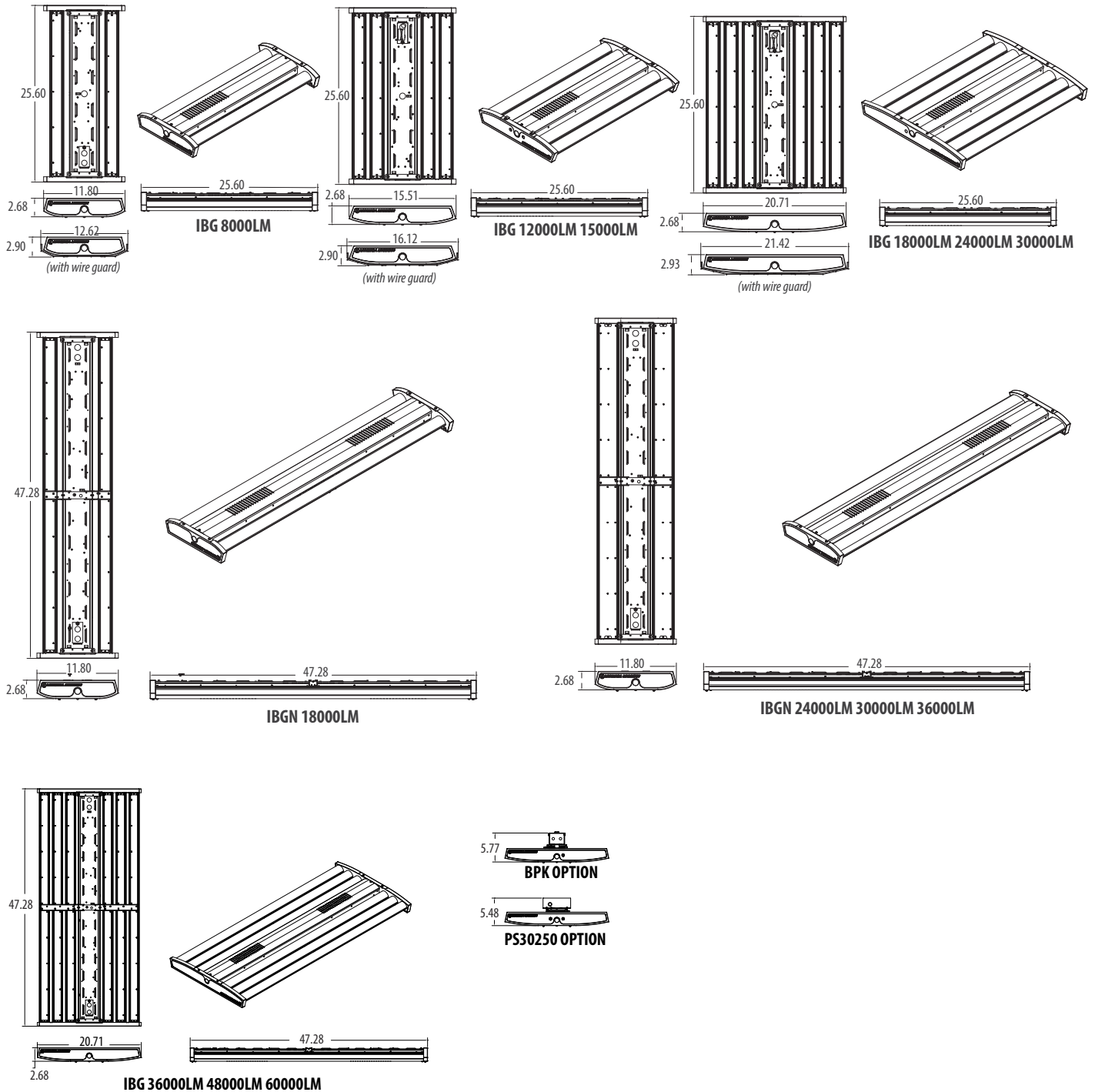

IBG LED High Bay

IBG OPERATIONAL DATA

	Lumen package	Efficiency level	Lens/distribution			
			Acrylic frosted/ general	Clear acrylic/narrow	Clear acrylic/wide	Clear acrylic/focus
Delivered lumens 4000K, 80CRI	8000LM	SEF	7594	7145	7384	7364
		HEF	7842	7378	7625	7604
	12000LM	SEF	11580	10895	11260	11228
		HEF	11746	11051	11421	11390
	15000LM	SEF	14458	13603	14059	14019
		HEF	14824	13947	14415	14374
	18000LM	SEF	17329	16303	16850	16803
		HEF	17752	16702	17262	17214
	24000LM	SEF	23000	21639	22365	22303
		HEF	23612	22215	22960	22896
	30000LM	SEF	27344	25727	26589	26515
		HEF	29577	27827	28760	28680
	36000LM	SEF	33203	31239	34547	32197
		HEF	35528	33426	34547	34450
	48000LM	SEF	45973	43253	44704	44579
		HEF	47254	44458	45949	45821
	60000LM	SEF	55453	52172	53922	53771
		HEF	57027	53653	55452	55298
Delivered lumens 5000K, 80CRI	8000LM	SEF	7873	7408	7656	7635
		HEF	8082	7604	7859	7837
	12000LM	SEF	12006	11296	11674	11642
		HEF	12106	11390	11771	11739
	15000LM	SEF	14990	14103	14576	14536
		HEF	15278	14374	14856	14815
	18000LM	SEF	17966	16904	17470	17422
		HEF	18296	17214	17791	17741
	24000LM	SEF	23847	22436	23188	23123
		HEF	24366	22896	23664	23598
	30000LM	SEF	28351	26674	27568	27491
		HEF	30483	28680	29641	29559
	36000LM	SEF	34221	32196	35605	33183
		HEF	36616	34450	35605	35506
	48000LM	SEF	47665	44845	46349	46220
		HEF	48702	45820	47357	47225
	60000LM	SEF	57494	54093	55906	55751
		HEF	58774	55297	57151	56992

PHOTOMETRICS

See www.lithonia.com.



IBG LED High Bay

IBG CHARACTERISTICS

Lumen package	Wattage								Length	Width	Depth	Comparable Light Source
	Standard efficiency				High efficiency							
	120V	277V	347V	480V	120V	277V	347V	480V				
8000LM	55	54	58	61	50	49	51	54	25.6	11.75	2.75	100W MH, 4-lamp T8 NBF
12000LM	79	77	77	76	70	69	68	67	25.6	15.52	2.75	175W MH, 4-lamp T8 HBF, 2-lamp T5HO
15000LM	97	95	97	96	87	86	86	86	25.6	15.52	2.75	200W MH, 6-lamp T8 NBF
18000LM	114	112	114	115	102	100	102	103	25.6	20.65	2.75	250W MH, 6-lamp T8 HBF, 4-lamp T5HO
24000LM	154	150	150	150	136	133	135	135	25.6	20.65	2.75	400W MH, 6-lamp T5HO
30000LM	193	186	188	188	176	171	173	173	25.6	20.65	2.75	575W MH, 10-lamp T8 HBF
36000LM	225	221	227	229	200	197	203	206	47.29	20.65	2.75	750W MH, 8-lamp T5HO
48000LM	301	293	301	302	267	261	269	270	47.29	20.65	2.75	875W MH, 10-lamp T5HO
60000LM	385	374	378	377	332	323	330	330	47.29	20.65	2.75	1000W MH

IBGN OPERATIONAL DATA

	Lumen package	Efficiency level	Lens/distribution			
			Acrylic frosted/ general	Clear acrylic/narrow	Clear acrylic/wide	Clear acrylic/focus
			Delivered lumens 4000K, 80CRI			
18000LM	SEF	17036	16028	16566	16520	
	HEF	17776	16724	17285	17237	
24000LM	SEF	22727	21383	22100	22038	
	HEF	24123	22696	23457	23392	
30000LM	SEF	28642	26948	27851	27773	
	HEF	29493	27748	28679	28599	
36000LM	SEF	34336	32305	33388	33295	
	HEF	34912	32846	33948	33853	
Delivered lumens 5000K, 80CRI						
18000LM	SEF	17663	16618	17175	17128	
	HEF	18320	17237	17814	17765	
24000LM	SEF	23564	22170	22913	22849	
	HEF	24862	23391	24176	24108	
30000LM	SEF	29696	27940	28876	28796	
	HEF	30397	28599	29558	29475	
36000LM	SEF	35600	33494	34617	34520	
	HEF	35982	33853	34988	34890	

IBGN CHARACTERISTICS

Lumen package	Wattage								Length	Width	Depth
	Standard efficiency				High efficiency						
	120V	277V	347V	480V	120V	277V	347V	480V			
18000LM	117	114	115	114	104	102	101	101	47.29	11.75	2.75
24000LM	172	170	167	167	152	150	153	153	47.29	11.75	2.75
30000LM	209	205	208	207	183	180	179	178	47.29	11.75	2.75
36000LM	246	240	242	243	207	203	202	201	47.29	11.75	2.75

PROJECTED LUMEN MAINTENANCE

IBG 2ft & 4ft						
Operating hours	0	15,000	30,000	45,000	60,000	100,000
Lumen maintenance factor	1	0.97	0.95	0.93	0.91	0.86
IBGN						
Operating hours	0	15,000	30,000	45,000	60,000	100,000
Lumen maintenance factor	1	0.97	0.93	0.90	0.87	0.81

EMERGENCY LUMENS (5000K 70CRI)

Fixture	IBG			IBGN
Lumen package	8000LM (PS1050 only)	12000LM - 15000LM	18000LM - 60000LM	18000LM - 36000LM
PS1050/PS10250	1600	1300	1900	1200
PS30250	N/A	4000	2400	3800

LUMENS VS. AMBIENT TEMPERATURE

Ambient °C	Ambient °F	Lumen Multiplier
0	32	1.04
5	41	1.03
10	50	1.02
20	68	1.01
25	77	1.00
30	86	0.99
35	95	0.99
40	104	0.98
45	113	0.97
50	122	0.96
55	131	0.96

AMBIENT TEMPERATURE RATINGS

Mounting	Suspended	Surface
Standard temperature rating	113°F (45°C)	95°F (35°C)
HA option temperature rating	131°F (55°C)	113°F (45°C)

LSXR - Fixture Mount Occupancy Sensor (see www.AcuityControls.com for additional information)

- Three interchangeable lens options to satisfy multiple mounting heights and coverage pattern requirements.
- Integrated mounting bracket drops lens down 3" from chase nipple.
- Single or dual relay versions — designed with robust protection from the harsh switching requirements of T5 and LED loads.
- Photocell and 0-10VDC dimming options.
- No PIR field calibration or sensitivity adjustments required.
- Sensor ambient temperature rating of 14°F (-10°C) to 131°F (55°C).

LSXR configuration	Comparable CMRB sensor	Old style sensor nomenclature
For shortest lead times use one of the following LSXR configurations		
LCOZU	CMRB 50	MSI
LCHOSZU	CMRB 50 D	MSID
LCPZU	CMRB 50 P	MSIPED
LAOZU	CMRB 6	MSI360
LAHOSZU	CMRB 6 D	MSI360D
LAPZU	CMRB 6 P	MSI360PED



SELECTIONS BELOW WILL EXTEND ORDER LEAD TIME. CONSULT YOUR SALES REPRESENTATIVE FOR DETAILS.

SINGLE RELAY

ORDERING INFORMATION

Example: LAHOSZU

Series	Lens option	Dimming/Photocell	Max. dim level	Min. dim level	Temp/Humidity	Default occupancy time delay
L LSXR passive infrared indoor occupancy sensor	A High mount, 360°	O None ¹	0 10 VDC	S Minimum dim level of ballast	Z None	I 30 sec
		H High/low occupancy operation	9 9 VDC	1 1 VDC	T Low temperature ²	D 2.5 min
	B Low mount, 360°	P Switching photocell (on/off) ¹	8 8 VDC	2 2 VDC		X 5.0 min
		M Dimming and switching photocell	7 7 VDC	3 3 VDC		R 7.5 min
	C High mount aisleway	G Dimming and switching photocell with high/low occupancy operation		4 4 VDC		U 10.0 min (with minimum 15 minute on time)
				5 5 VDC		V 15.0 min
				6 6 VDC		W 20.0 min
					Y 30.0 min	

Notes

- 1 Max and min dim levels not applicable with this option.
- 2 Ambient temperature rating of -4°F (-20°C) to 131°F (55°C).

DUAL RELAY (Available with 120, 277, and 347V only)

ORDERING INFORMATION

Example: LA2KZU

Series	Lens option	Poles	Operating mode	Temp/Humidity	Default occupancy time delay
L LSXR passive infrared indoor occupancy sensor	A High mount, 360° B Low mount, 360° C High mount aisleway	2 Dual relay	J None	Z None	I 30 sec
			K Alternating off relays (promotes even lamp wear)	T Low temperature ¹	D 2.5 min
			O Alternating off relays w/photocell		X 5.0 min
			P Switching photocell(on/off)		R 7.5 min
			E Photocell on/off (pole 1 only)		U 10.0 min (with minimum 15 minute on time)
			F Photocell on/off - both poles (dual set-point)		V 15.0 min
					W 20.0 min
					Y 30.0 min

Notes

- 1 Ambient temperature rating of -4°F (-20°C) to 131°F (55°C).

Example: LENS 50 J100

Replacement lenses: Order as separate catalog number.		
Series	Lens type	Package quantity
LENS	6 High mount 360°	[blank] Single Lens
	10 Low mount 360°	J10 10-pack
	50 High mount aisleway	J100 100-pack

LSXR COVERAGE PATTERNS

HIGH MOUNT 360° LENS (#6)

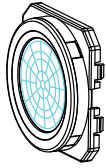

- Best choice for 15 to 45 ft (4.57 to 13.72 m) mounting heights
- 15 to 20 ft (4.57 to 6.10 m) radial coverage overlaps area lit by a typical high bay fixture
- Excellent detection of large motion (e.g. walking) up to a 35 ft (10.76 m) mounting height
- Excellent detection of extra large motion (e.g. forklifts) up to a 45 ft (13.72 m) mounting height

LOW VIEW

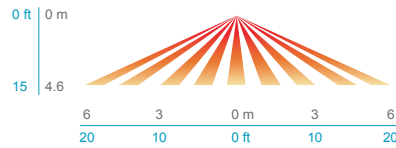

HIGH VIEW

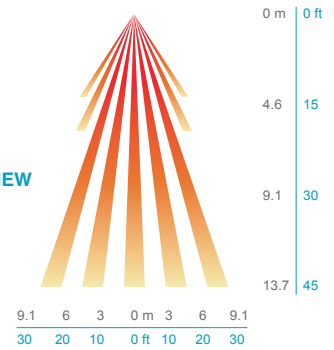

HIGH MOUNT AISLEWAY LENS (#50)

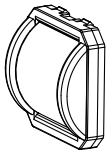

- Provides a bi-directional coverage pattern ideal for warehouse racking
- 1.2x mounting height equals approximate detection range in either direction
- Typical 40 ft (12.19 m) mounting detects 50 ft (15.24 m) in either direction
- Superior aisleway coverage compared to a masked 360° lens

SIDE VIEW

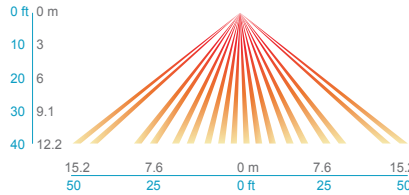

TOP VIEW

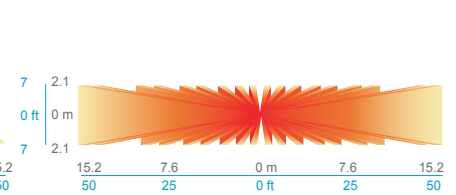

LOW MOUNT 360° LENS (#10)

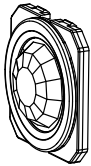

- Best choice for large motion detection (e.g. walking)
- 360° conical shaped pattern
- Provides ~24 ft (7.32 m) radial coverage (~2000 ft²) when mounted at 9 ft (2.74 m)
- 7 to 15 ft (2.13 to 4.57 m) mounting heights provide 16 to 36 ft (4.88 to 10.97 m) radial coverage
- Detection range improves when walking across beams compared to into beams

SIDE VIEW

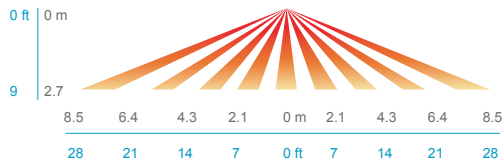

TOP VIEW

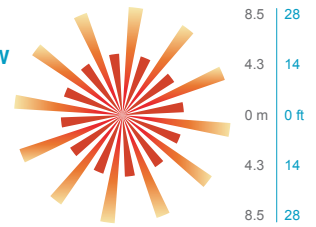

C6DOSUEM & C10DOSUEM - UL924 Listed Sensors

SENSOR DEFAULT SEQUENCE OF OPERATION

- The occupied light level is full output.
- The unoccupied light level is approximately 30%.
- The time delay following sensor vacancy is 5 minutes, with an additional 5 minute slow ramp from the occupied light level to the unoccupied light level.
- **The onboard daylight sensor is not enabled by default - sensor will not respond to changing daylight conditions.**

Daylight sensor settings can be enabled and programmed by a trained technician after installation.

EGRESS MODE SEQUENCE OF OPERATION

The UL924 C6DOSUEM & C10DOSUEM controls are designed to provide fully tuned light output for 90 minutes following power loss or interruption, ignoring automatic dimming/occupancy/daylight control signals during this time.

- Typical sequence upon power loss: Backup power source activates, transfer switch moves the emergency circuit powering the sensor onto the backup source, and sensor regains power. This sensor is programmed to detect any power interruption or transfer > 30 ms
- The sensor then ignores occupancy & daylight status and controls the luminaire to full light output for 90 minutes.
- The device resumes normal dimming & occupancy controls after 90 minutes.
- This sensor should not be used with online power backup systems or any transfer devices with < 30 ms transfer time.

IBG LED High Bay

IMP - Integrated Modular Plug

- The integrated modular plug (IMP) option allows the installer to plug and play a multitude of accessories.
- Cord sets connect quickly to any fixture with IMP option.
- IMP accessories include occupancy sensors, photocells, X-point relays.

IMP compatible cord sets ¹	
CS1WIMP	Straight plug, 120V
CS3WIMP	Twist-lock, 120V
CS7WIMP	Straight plug, 277V
CS11WIMP	Twist-lock, 277V
CS25WIMP	Twist-lock, 347V
CS93WIMP	600V SE00W white cord, no plug
CS97WIMP	Twist-lock, 480V

IMP compatible sensors	
MSIIMP	Aisle sensor
MSI360IMP	360° sensor

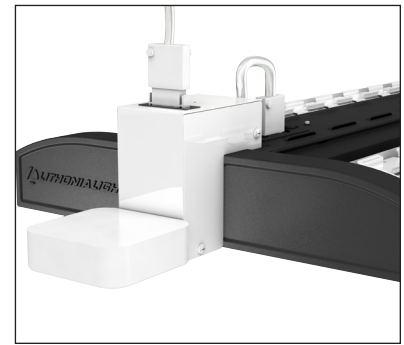

Notes

- 1 Cord set required for fixture operation. All cord sets are 18/3, 6' white.

RRL - RELOC®-Ready Luminaire

- RRL connectors can be used with Quick-Flex®, System 820 and OnePass® systems.
- Load side of connector factory installed to luminaire.
- 4-pole mating connector with push-in terminations allows for simple installation.
- Touch-safe design on both halves meets UL/CSA requirement.
- Wiping contact design allows safe disconnect under load.



ORDERING INFORMATION

Lead times will vary depending on options selected. Consult with your sales representative.

Example: RRLA

Series	Wiring instructions			
RRL RELOC®-ready luminaire	A	Hot conductor wired to position #1 (phase A); non-dimming	AE	Hot conductor wired to position #1 (phase A), hot conductor #2 wired to position #2 (phase B); non-dimming ²
	B	Hot conductor wired to position #2 (phase B); non-dimming	ABE	Hot conductor wired to position #1 (phase A), hot conductor #2 wired to position #2 (phase B), inverter conductor wired to position #3 (phase C); non-dimming ^{1,2}
	C	Hot conductor wired to position #3 (phase C); non-dimming ¹	C12S	Hot conductor in position #1 (phase A), low voltage conductor #1 in position #2, low voltage conductor #2 in position #3; dimming ^{1,3}
	AB	Outboard hot conductor wired to position #1 (phase A), inboard hot conductor wired to position #2 (phase B); non-dimming		

Compatible RELOC® Cables for Industrial Luminaires (ordered and shipped separately)

(click to view RELOC product page for more information)



Notes

- 1 C, ABE, and C12S options are not used with Quick-Flex QFC, QSFC, QPT, and QD.
- 2 AE and ABE commercial fixtures should disconnect the TSPL before unplugging the RRL so it does not go into discharge mode.
- 3 C12S option is used with the OnePass OD and 820 SSC, PT, and DC for 0-10V/DALI applications.