

Class H(K), J and R modular ferrule fuse blocks

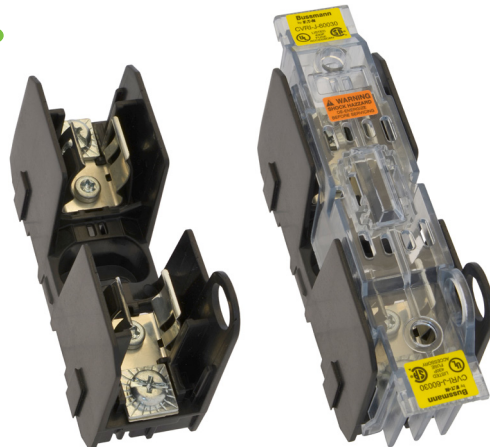

Product description:

HM Class H(K), JM Class J and RM Class R modular ferrule fuse blocks for fuses up to 60 amps.

The new Bussmann™ series fuse blocks contain multiple features that increase versatility, reduce labor and enhance safety for any panel or electrical system design.

Features and benefits:

- Available in 1-, 2-, and 3-pole configurations to meet stocking requirements.
- To reduce inventory, assembly time and labor, modular single-pole blocks snap-together for tool-less assembly of multiple poles at point of use.
- DIN-Rail and panel mount versatility allows one product to be used for multiple applications with lower inventory cost.
- Save panel space with the smallest width dimension on the market.
- Standard clip reinforcing springs improve temperature rise performance while maintaining reliable surface contact between the fuse ferrule and clip over the block's service life.
- Optional see-through, IP20 finger-safe covers enhance safety with lock-out/tag-out capability.
- Optional open fuse indication on covers speeds troubleshooting.
- Easy circuit identification with available universal marker labels for blocks and covers.

Specifications

Ratings:

- Volts Class H 250V, 600V
Class J 600V
Class R 250V, 600V
- Amps up to 60A
- Withstand Class J and R 200kA RMS Sym
Class H(K) 10kA RMS Sym

Agency information:

Blocks:

- UL® Listed E14853 - IZLT
- CSA® Certified 47235-6225-01
- CE
- RoHS Compliant
- Conflict mineral free
- REACH declaration available upon request

Covers:

- UL Listed E58836 - JDVS
- CSA Certified 47235-6225-01
- RoHS Compliant
- REACH declaration available upon request

Poles:

- 1-, 2-, 3-pole units factory assembled
- Single-pole units snap together to create desired number of poles

Flammability ratings:

- Blocks — UL 94V0, self-extinguishing
- Covers — UL 94HB, self-extinguishing

Operating and storage temperature range:

- Blocks -40°C to +120°C
- Non-Indicating covers -40°C to +120°C
- Indicating covers -20°C to +90°C*

* Indication requires minimum 90Vac/dc and closed circuit to illuminate.

Materials:

- Base — Thermoplastic
- Terminals — Tin-plated copper brass
- Covers — Thermoplastic

Table 1. Terminals, conductors and torque values

Terminal type	AWG type/range	Torque	
		AWG	Lb-in (N•m)
Box Lug ("CR" Option)	75°C Cu 2-14, AL 2-8	2-3;	50 (5.6)
		4-6;	45 (5.1)
		8;	40 (4.5)
		10-14;	35 (4.0)
All other terminals*	75/90°C Cu 10-18	10-18;	20 (2.3)

* 3/16" Quick Connect terminal maximum ampacity dependent on female spade connector and wire ratings.

Recommended Bussmann series fuses:

Class H(K)

- Basic protection general purpose 250V NON, data sheet No. 1030
- Basic protection general purpose 600V NOS, data sheet No. 1030

Class J

- Ultimate protection Low-Peak™ LPJ time-delay fuses, data sheet No. 1006
- Advanced protection Limitron™ JKS fast-acting fuses, data sheet No. 1026

Class R

- Ultimate protection Low-Peak LPN 250V time-delay, data sheet No. 1003
- Ultimate protection Low-Peak LPS 600V time-delay, data sheet No. 1001
- Advanced protection Limitron KTN-R 250V fast-acting, data sheet No. 1043
- Advanced protection Limitron KTS-R 600V fast-acting, data sheet No. 1044
- Advanced protection energy efficient Fusetron™ FRN 250V time-delay, data sheet No. 1019
- Advanced protection energy efficient Fusetron FRS, 600V time-delay, data sheet No. 1017

Recommended Bussmann series DIN-Rail end stops:

- Part No. BRKT-ND
- Part No. BRKT-NDSCREW2

Marker labels:

- Use Bussmann series part number TM26CB

Table 2. Class H fuse block catalog numbers

Box lug	Terminal type			Volts	Fuse amp range	Poles
	#10-32 Phil-slot screw	Screw with quick-connect*	Pressure plate			
HM25030-1CR	HM25030-1SR	HM25030-1QR	HM25030-1PR	250	1/2 to 30	1
HM25030-2CR	HM25030-2SR	HM25030-2QR	HM25030-2PR			2
HM25030-3CR	HM25030-3SR	HM25030-3QR	HM25030-3PR			3
HM25060-1CR	—	—	—	250	31 to 60	1
HM25060-2CR	—	—	—			2
HM25060-3CR	—	—	—			3
HM60030-1CR	HM60030-1SR	—	HM60030-1PR	600	1/2 to 30	1
HM60030-2CR	HM60030-2SR	—	HM60030-2PR			2
HM60030-3CR	HM60030-3SR	—	HM60030-3PR			3
HM60060-1CR	—	—	—	600	31 to 60	1
HM60060-2CR	—	—	—			2
HM60060-3CR	—	—	—			3

* 3/16" Quick Connect terminal maximum ampacity dependent on female spade connector and wire ratings.

Table 3. Class H block covers

Fuse block series	Volts	Amp range	Catalog numbers	
			Indicating	Non-indicating
HM25030-#XX	250	1/2 to 30	CVRI-RH-25030	CVR-RH-25030
HM25060-#XX		31 to 60	CVRI-RH-25060	CVR-RH-25060
HM60030-#XX	600	1/2 to 30	CVRI-RH-60030	CVR-RH-60030
HM60060-#XX		31 to 60	CVRI-RH-60060	CVR-RH-60060

= number of poles

XX = terminal type



Table 4. Class R fuse block catalog numbers

Box lug	Terminal type			Volts	Fuse amp range	Poles
	#10-32 Phil-slot screw	Screw with quick-connect	Pressure plate			
RM25030-1CR	RM25030-1SR	RM25030-1QR	RM25030-1PR	250	1/2 to 30	1
RM25030-2CR	RM25030-2SR	RM25030-2QR	RM25030-2PR			2
RM25030-3CR	RM25030-3SR	RM25030-3QR	RM25030-3PR			3
RM25060-1CR	—	—	—	250	31 to 60	1
RM25060-2CR	—	—	—			2
RM25060-3CR	—	—	—			3
RM60030-1CR	RM60030-1SR	—	RM60030-1PR	600	1/2 to 30	1
RM60030-2CR	RM60030-2SR	—	RM60030-2PR			2
RM60030-3CR	RM60030-3SR	—	RM60030-3PR			3
RM60060-1CR	—	—	—	600	31 to 60	1
RM60060-2CR	—	—	—			2
RM60060-3CR	—	—	—			3

* 3/16" Quick Connect terminal maximum ampacity dependent on female spade connector and wire ratings.

Table 5. Class R block covers

Fuse block series	Volts	Amp range	Catalog numbers	
			Indicating	Non-indicating
RM25030-#XX	250	1/2 to 30	CVRI-RH-25030	CVR-RH-25030
RM25060-#XX		31 to 60	CVRI-RH-25060	CVR-RH-25060
RM60030-#XX	600	1/2 to 30	CVRI-RH-60030	CVR-RH-60030
RM60060-#XX		31 to 60	CVRI-RH-60060	CVR-RH-60060

= number of poles

XX = terminal type



Dimensions - mm (in):

Class H(K) and R 250V - 30A block

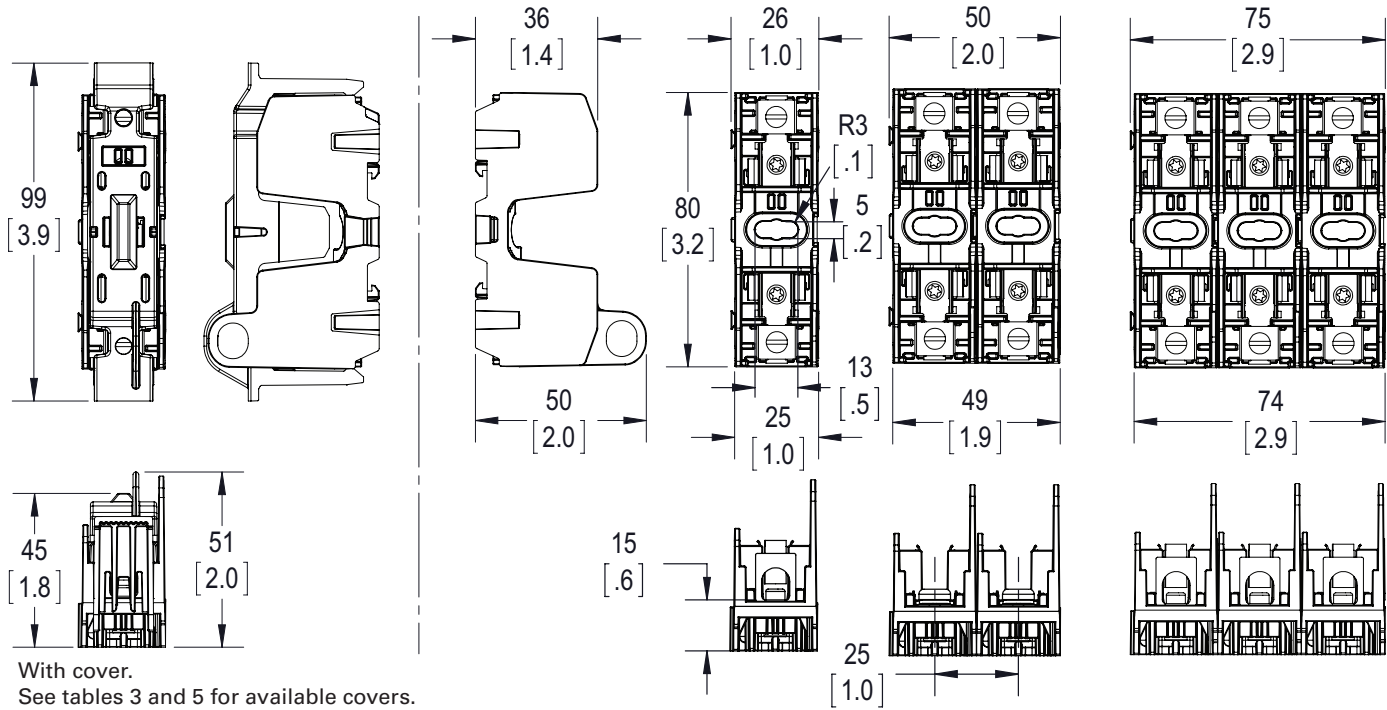

Class H(K) and R 250V - 60A block

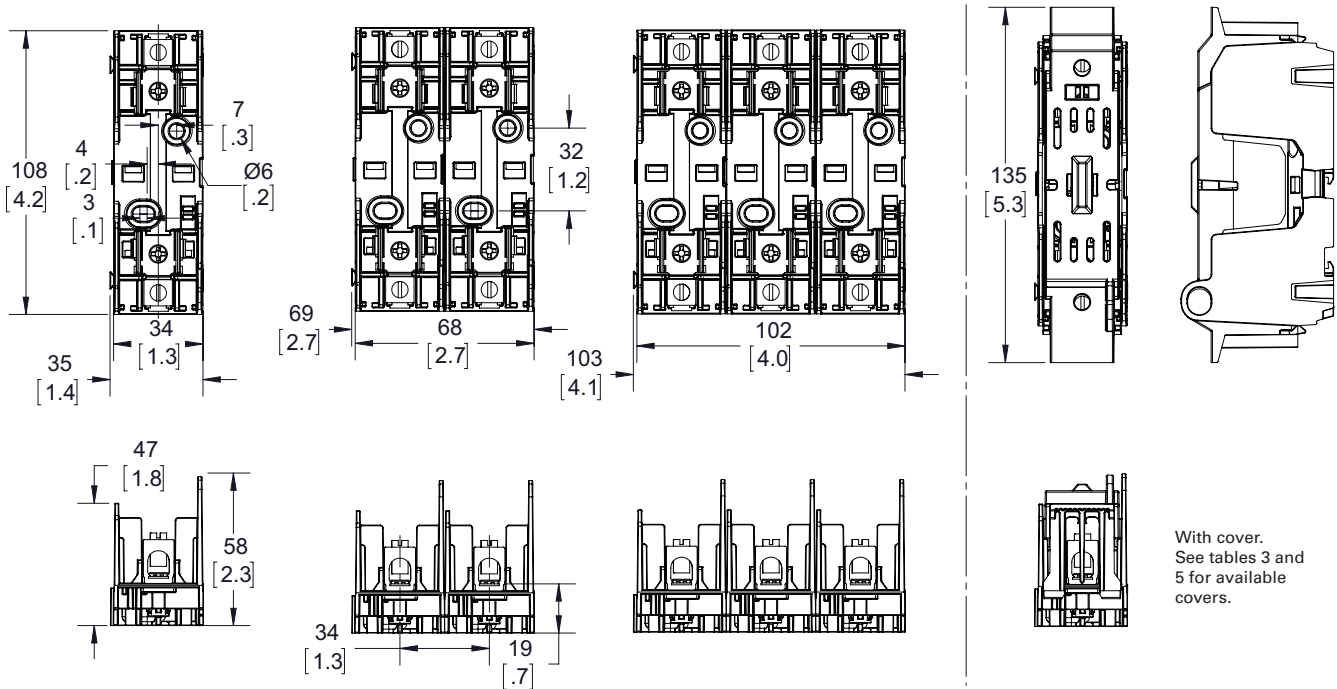

Dimensions - mm (in):

Class H(K) and R 600V - 30A block

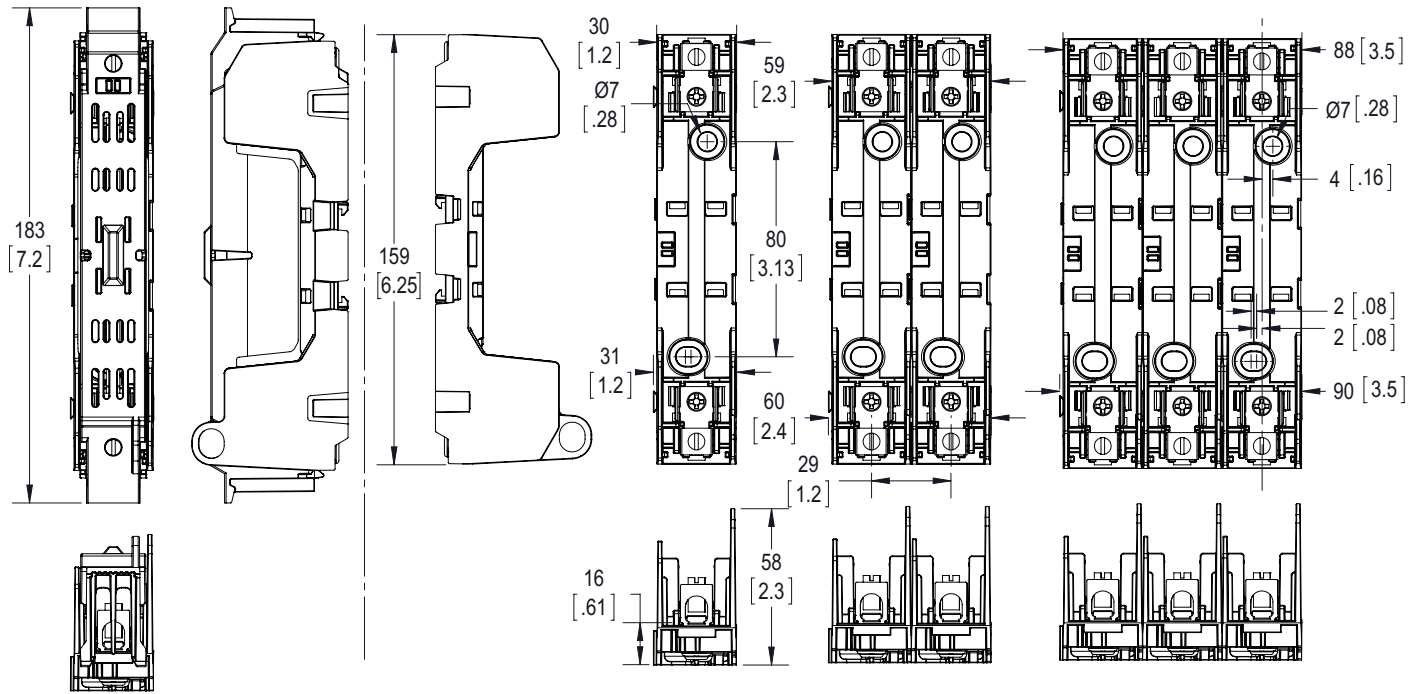

With cover.
See tables 3 and 5 for available covers.

Class H(K) and R 600V - 60A block

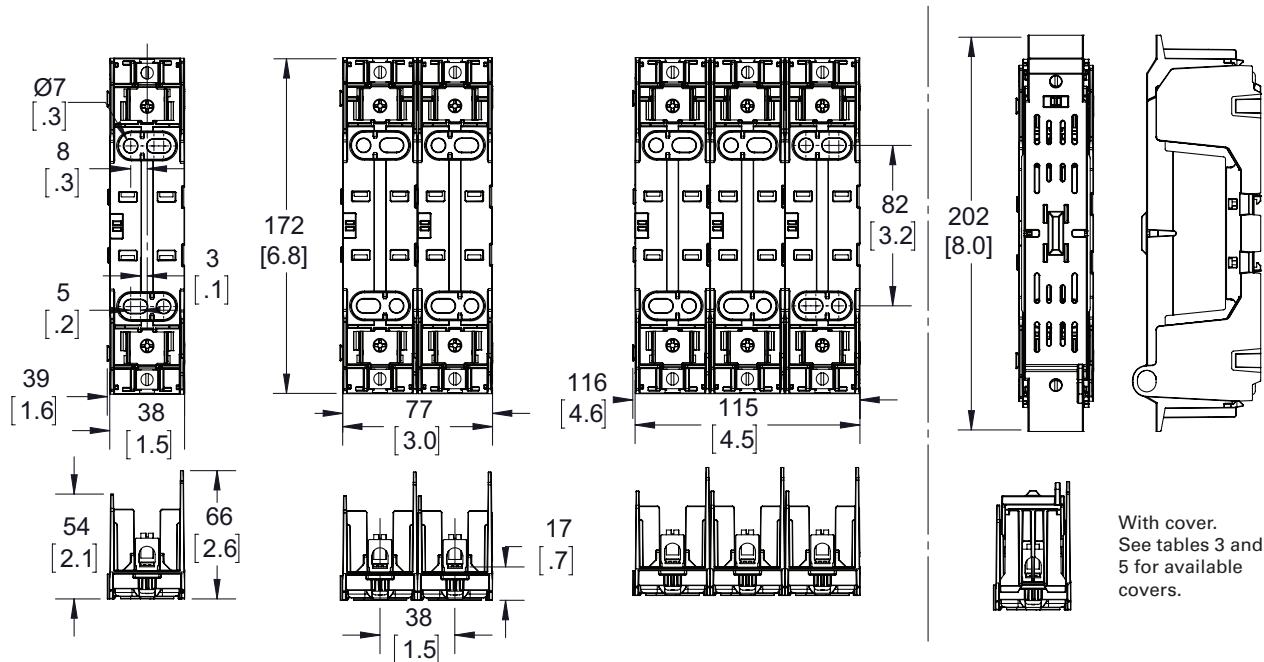

With cover.
See tables 3 and 5 for available covers.

Table 6. Class J fuse block catalog numbers

Box lug	Terminal type		Volts	Fuse amp range	Poles
	#10-32 Phil-slot screw	Pressure plate			
JM60030-1CR	JM60030-1SR	JM60030-1PR	600	1/2 to 30	1
JM60030-2CR	JM60030-2SR	JM60030-2PR			2
JM60030-3CR	JM60030-3SR	JM60030-3PR			3
JM60060-1CR	—	—	600	31 to 60	1
JM60060-2CR	—	—			2
JM60060-3CR	—	—			3

Table 7. Class J block covers

Fuse block series	Volts	Amp range	Catalog numbers	
			Indicating	Non-indicating
JM60030-#XX	600	1/2 to 30	CVRI-J-60030	CVR-J-60030
JM60060-#XX		31 to 60	CVRI-J-60060	CVR-J-60060

= number of poles
 XX = terminal type

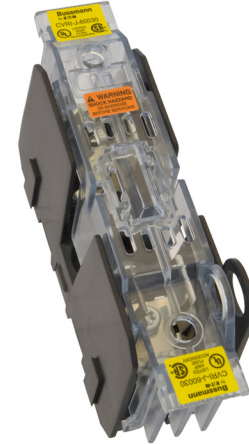

Dimensions - mm (in):

Class J - 30A block

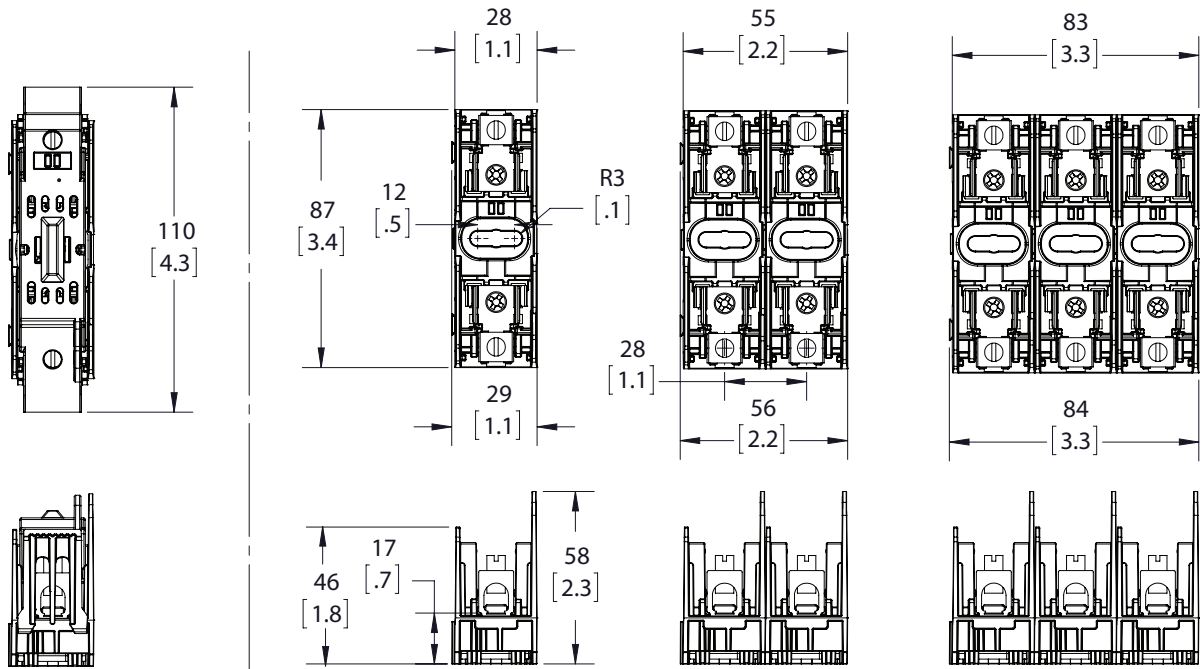

With cover.
See table 7 for available covers.

Class J - 60A block

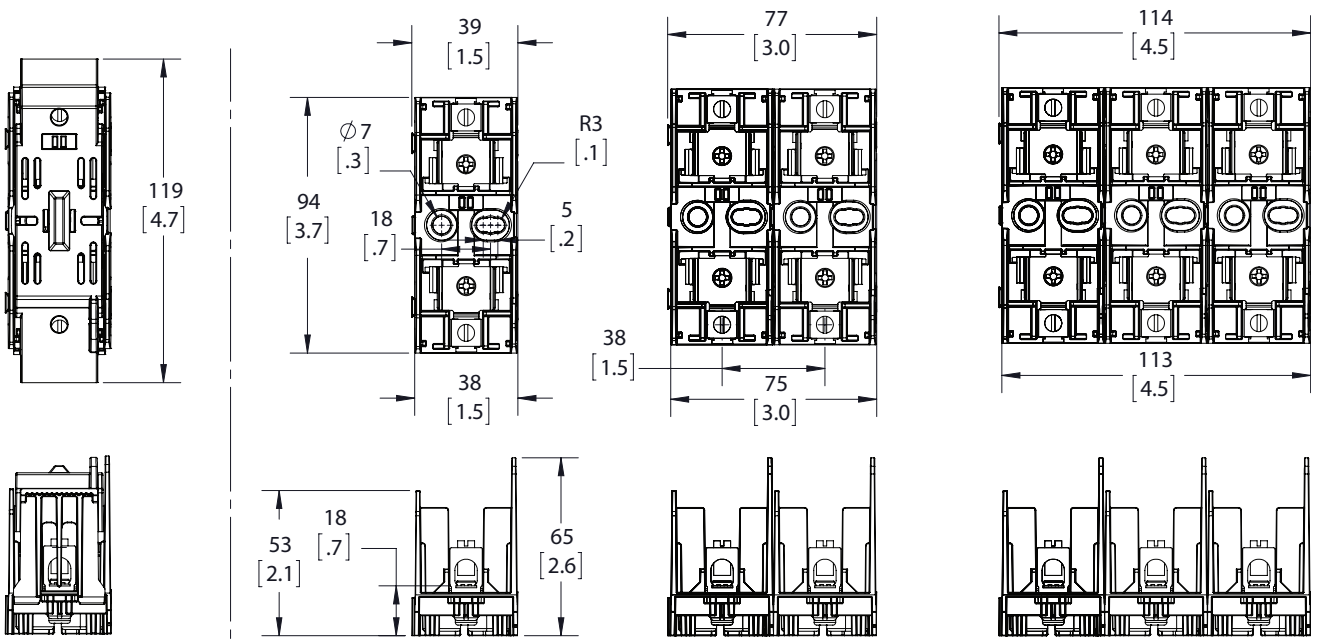

With cover.
See table 7 for available covers.

Installing/removing covers

Closing cover: Position cover over block and push straight down until it snaps/clicks into place.

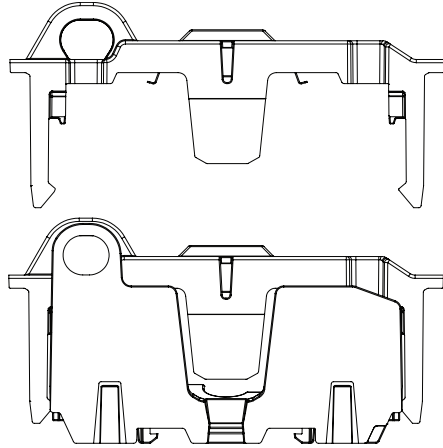

Opening cover: Using both outside handles, pull straight up.

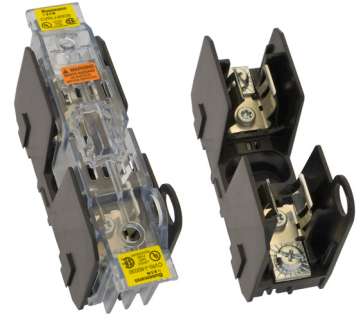

Installing blocks on DIN-Rail

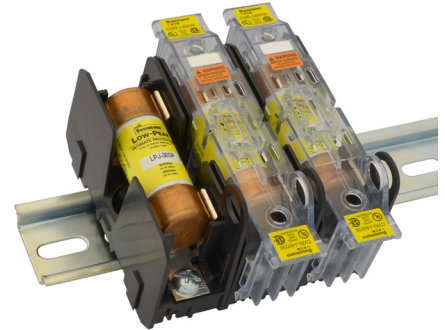
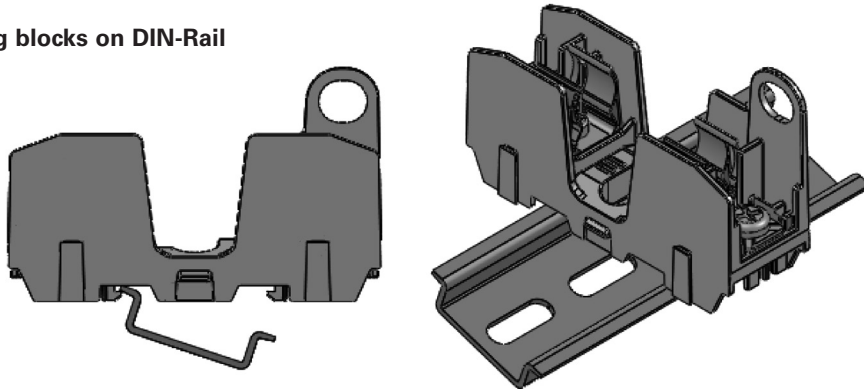

Place one edge of DIN-Rail in fuse block base, then rotate block down until it clicks into place.

The only controlled copy of this data sheet is the electronic read-only version located on the Eaton network drive. All other copies of this document are by definition uncontrolled. This bulletin is intended to clearly present comprehensive product data and provide technical information that will help the end user with design applications. Eaton reserves the right, without notice, to change design or construction of any products and to discontinue or limit distribution of any products. Eaton also reserves the right to change or update, without notice, any technical information contained in this bulletin. Once a product has been selected, it should be tested by the user in all possible applications.

Eaton
1000 Eaton Boulevard
Cleveland, OH 44122
United States
Eaton.com

Bussmann Division
114 Old State Road
Ellisville, MO 63021
United States
Eaton.com/bussmannseries

© 2017 Eaton
All Rights Reserved
Printed in USA
Publication No. 10289 - BU-SB14607
March 2017

Eato, Bussmann, Fusetron, Limitron and Low-Peak are valuable trademarks of Eaton in the US and other countries. You are not permitted to use the Eaton trademarks without prior written consent of Eaton.

CSA is a registered trademark of the Canadian Standards Group.
UL is a registered trademark of Underwriters Laboratories, Inc.

For Eaton's Bussmann series product information, call 1-855-287-7626 or visit: Eaton.com/bussmannseries

Class H(K), J and R modular ferrule fuse blocks

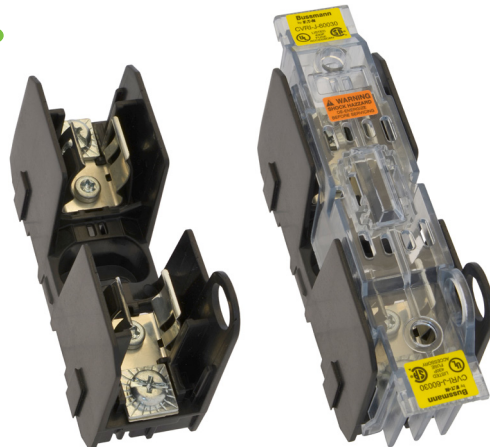

Product description:

HM Class H(K), JM Class J and RM Class R modular ferrule fuse blocks for fuses up to 60 amps.

The new Bussmann™ series fuse blocks contain multiple features that increase versatility, reduce labor and enhance safety for any panel or electrical system design.

Features and benefits:

- Available in 1-, 2-, and 3-pole configurations to meet stocking requirements.
- To reduce inventory, assembly time and labor, modular single-pole blocks snap-together for tool-less assembly of multiple poles at point of use.
- DIN-Rail and panel mount versatility allows one product to be used for multiple applications with lower inventory cost.
- Save panel space with the smallest width dimension on the market.
- Standard clip reinforcing springs improve temperature rise performance while maintaining reliable surface contact between the fuse ferrule and clip over the block's service life.
- Optional see-through, IP20 finger-safe covers enhance safety with lock-out/tag-out capability.
- Optional open fuse indication on covers speeds troubleshooting.
- Easy circuit identification with available universal marker labels for blocks and covers.

Specifications

Ratings:

- Volts Class H 250V, 600V
Class J 600V
Class R 250V, 600V
- Amps up to 60A
- Withstand Class J and R 200kA RMS Sym
Class H(K) 10kA RMS Sym

Agency information:

Blocks:

- UL® Listed E14853 - IZLT
- CSA® Certified 47235-6225-01
- CE
- RoHS Compliant
- Conflict mineral free
- REACH declaration available upon request

Covers:

- UL Listed E58836 - JDVS
- CSA Certified 47235-6225-01
- RoHS Compliant
- REACH declaration available upon request

Poles:

- 1-, 2-, 3-pole units factory assembled
- Single-pole units snap together to create desired number of poles

Flammability ratings:

- Blocks — UL 94V0, self-extinguishing
- Covers — UL 94HB, self-extinguishing

Operating and storage temperature range:

- Blocks -40°C to +120°C
- Non-Indicating covers -40°C to +120°C
- Indicating covers -20°C to +90°C*

* Indication requires minimum 90Vac/dc and closed circuit to illuminate.

Materials:

- Base — Thermoplastic
- Terminals — Tin-plated copper brass
- Covers — Thermoplastic

Table 1. Terminals, conductors and torque values

Terminal type	AWG type/range	Torque	
		AWG	Lb-in (N•m)
Box Lug ("CR" Option)	75°C Cu 2-14, AL 2-8	2-3;	50 (5.6)
		4-6;	45 (5.1)
		8;	40 (4.5)
		10-14;	35 (4.0)
All other terminals*	75/90°C Cu 10-18	10-18;	20 (2.3)

* 3/16" Quick Connect terminal maximum ampacity dependent on female spade connector and wire ratings.

Recommended Bussmann series fuses:

Class H(K)

- Basic protection general purpose 250V NON, data sheet No. 1030
- Basic protection general purpose 600V NOS, data sheet No. 1030

Class J

- Ultimate protection Low-Peak™ LPJ time-delay fuses, data sheet No. 1006
- Advanced protection Limitron™ JKS fast-acting fuses, data sheet No. 1026

Class R

- Ultimate protection Low-Peak LPN 250V time-delay, data sheet No. 1003
- Ultimate protection Low-Peak LPS 600V time-delay, data sheet No. 1001
- Advanced protection Limitron KTN-R 250V fast-acting, data sheet No. 1043
- Advanced protection Limitron KTS-R 600V fast-acting, data sheet No. 1044
- Advanced protection energy efficient Fusetron™ FRN 250V time-delay, data sheet No. 1019
- Advanced protection energy efficient Fusetron FRS, 600V time-delay, data sheet No. 1017

Recommended Bussmann series DIN-Rail end stops:

- Part No. BRKT-ND
- Part No. BRKT-NDSCREW2

Marker labels:

- Use Bussmann series part number TM26CB

Table 2. Class H fuse block catalog numbers

Box lug	Terminal type			Volts	Fuse amp range	Poles
	#10-32 Phil-slot screw	Screw with quick-connect*	Pressure plate			
HM25030-1CR	HM25030-1SR	HM25030-1QR	HM25030-1PR	250	1/2 to 30	1
HM25030-2CR	HM25030-2SR	HM25030-2QR	HM25030-2PR			2
HM25030-3CR	HM25030-3SR	HM25030-3QR	HM25030-3PR			3
HM25060-1CR	—	—	—	250	31 to 60	1
HM25060-2CR	—	—	—			2
HM25060-3CR	—	—	—			3
HM60030-1CR	HM60030-1SR	—	HM60030-1PR	600	1/2 to 30	1
HM60030-2CR	HM60030-2SR	—	HM60030-2PR			2
HM60030-3CR	HM60030-3SR	—	HM60030-3PR			3
HM60060-1CR	—	—	—	600	31 to 60	1
HM60060-2CR	—	—	—			2
HM60060-3CR	—	—	—			3

* 3/16" Quick Connect terminal maximum ampacity dependent on female spade connector and wire ratings.

Table 3. Class H block covers

Fuse block series	Volts	Amp range	Catalog numbers	
			Indicating	Non-indicating
HM25030-#XX	250	1/2 to 30	CVRI-RH-25030	CVR-RH-25030
HM25060-#XX		31 to 60	CVRI-RH-25060	CVR-RH-25060
HM60030-#XX	600	1/2 to 30	CVRI-RH-60030	CVR-RH-60030
HM60060-#XX		31 to 60	CVRI-RH-60060	CVR-RH-60060

= number of poles

XX = terminal type



Table 4. Class R fuse block catalog numbers

Box lug	Terminal type			Volts	Fuse amp range	Poles
	#10-32 Phil-slot screw	Screw with quick-connect	Pressure plate			
RM25030-1CR	RM25030-1SR	RM25030-1QR	RM25030-1PR	250	1/2 to 30	1
RM25030-2CR	RM25030-2SR	RM25030-2QR	RM25030-2PR			2
RM25030-3CR	RM25030-3SR	RM25030-3QR	RM25030-3PR			3
RM25060-1CR	—	—	—	250	31 to 60	1
RM25060-2CR	—	—	—			2
RM25060-3CR	—	—	—			3
RM60030-1CR	RM60030-1SR	—	RM60030-1PR	600	1/2 to 30	1
RM60030-2CR	RM60030-2SR	—	RM60030-2PR			2
RM60030-3CR	RM60030-3SR	—	RM60030-3PR			3
RM60060-1CR	—	—	—	600	31 to 60	1
RM60060-2CR	—	—	—			2
RM60060-3CR	—	—	—			3

* 3/16" Quick Connect terminal maximum ampacity dependent on female spade connector and wire ratings.

Table 5. Class R block covers

Fuse block series	Volts	Amp range	Catalog numbers	
			Indicating	Non-indicating
RM25030-#XX	250	1/2 to 30	CVRI-RH-25030	CVR-RH-25030
RM25060-#XX		31 to 60	CVRI-RH-25060	CVR-RH-25060
RM60030-#XX	600	1/2 to 30	CVRI-RH-60030	CVR-RH-60030
RM60060-#XX		31 to 60	CVRI-RH-60060	CVR-RH-60060

= number of poles

XX = terminal type



Dimensions - mm (in):

Class H(K) and R 600V - 30A block

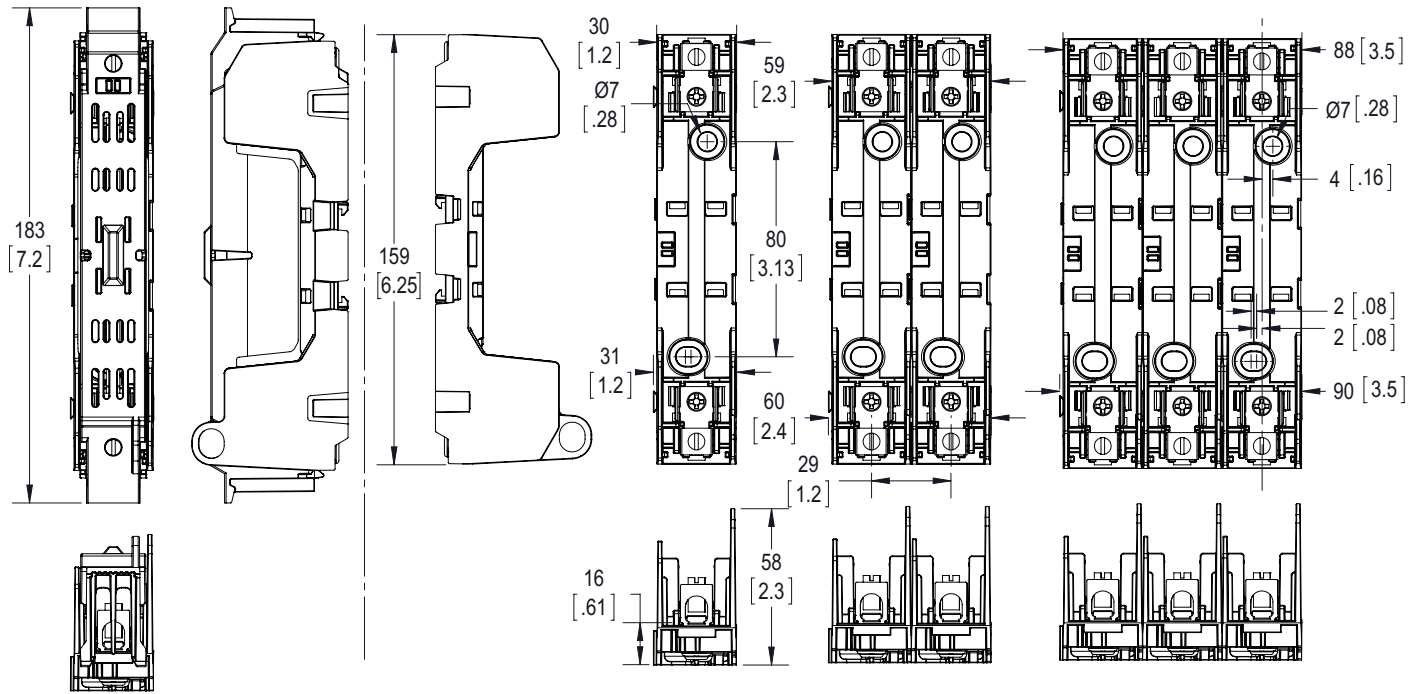

With cover.
See tables 3 and 5 for available covers.

Class H(K) and R 600V - 60A block

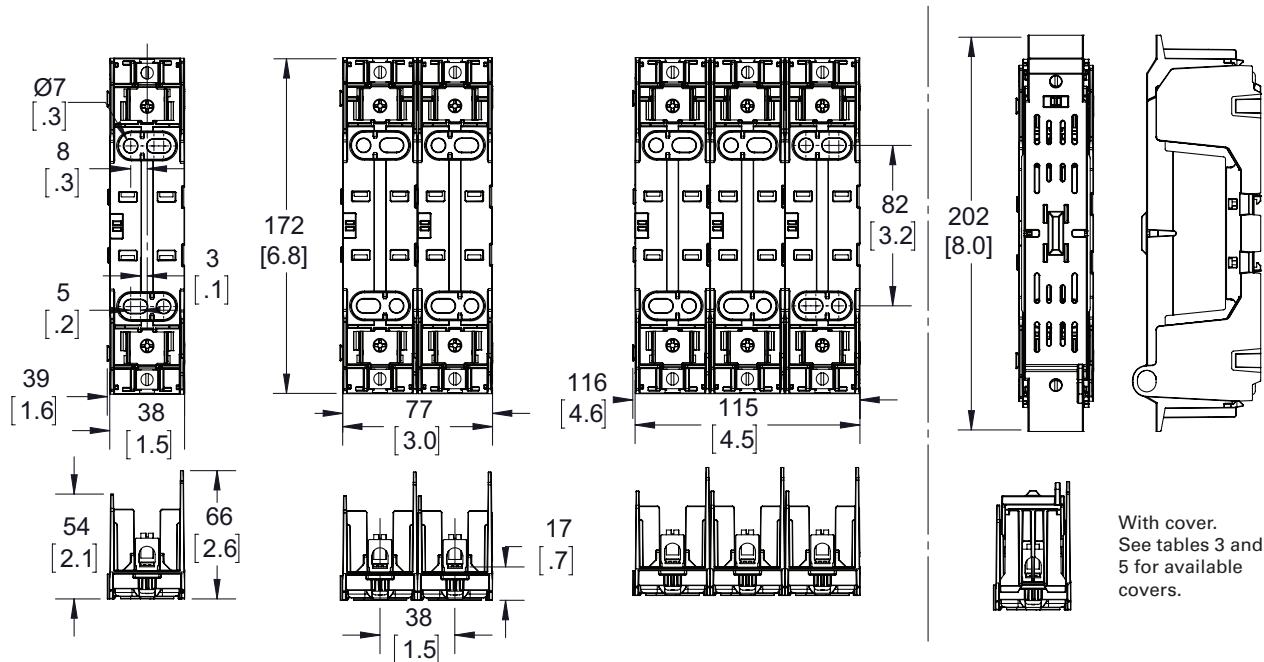

With cover.
See tables 3 and 5 for available covers.

Table 6. Class J fuse block catalog numbers

Box lug	Terminal type		Volts	Fuse amp range	Poles
	#10-32 Phil-slot screw	Pressure plate			
JM60030-1CR	JM60030-1SR	JM60030-1PR	600	1/2 to 30	1
JM60030-2CR	JM60030-2SR	JM60030-2PR			2
JM60030-3CR	JM60030-3SR	JM60030-3PR			3
JM60060-1CR	—	—	600	31 to 60	1
JM60060-2CR	—	—			2
JM60060-3CR	—	—			3

Table 7. Class J block covers

Fuse block series	Volts	Amp range	Catalog numbers	
			Indicating	Non-indicating
JM60030-#XX	600	1/2 to 30	CVRI-J-60030	CVR-J-60030
JM60060-#XX		31 to 60	CVRI-J-60060	CVR-J-60060

= number of poles
 XX = terminal type

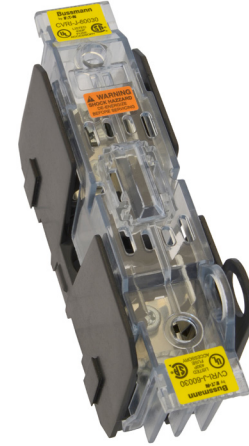

Dimensions - mm (in):

Class J - 30A block

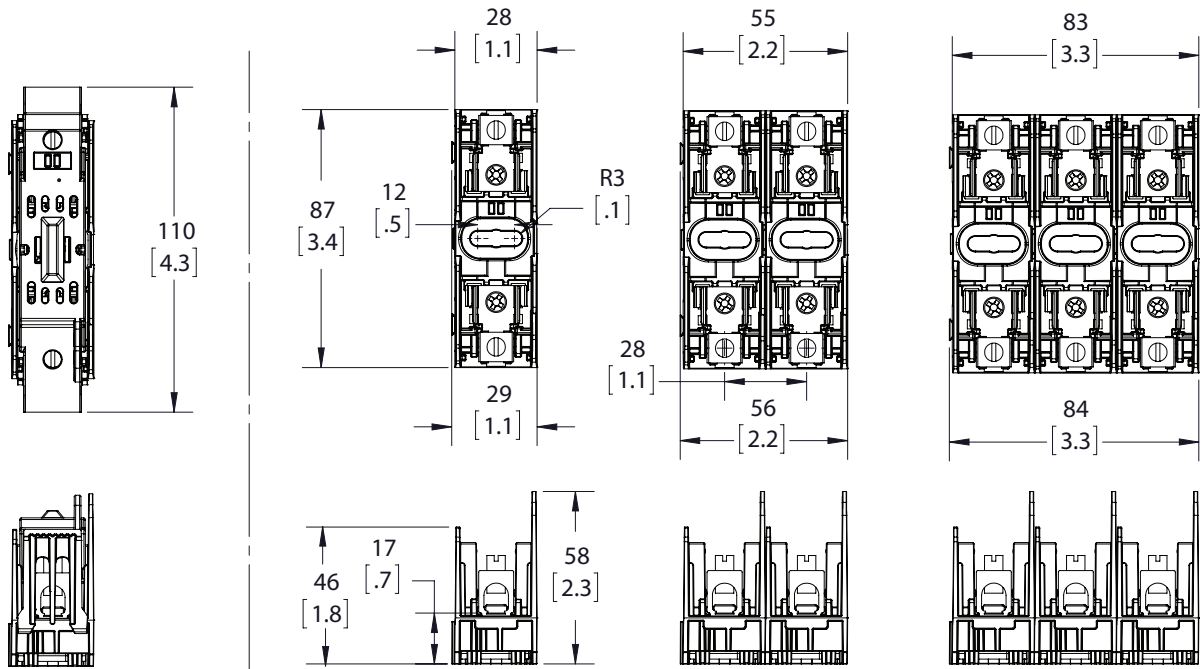

With cover.
See table 7 for available covers.

Class J - 60A block

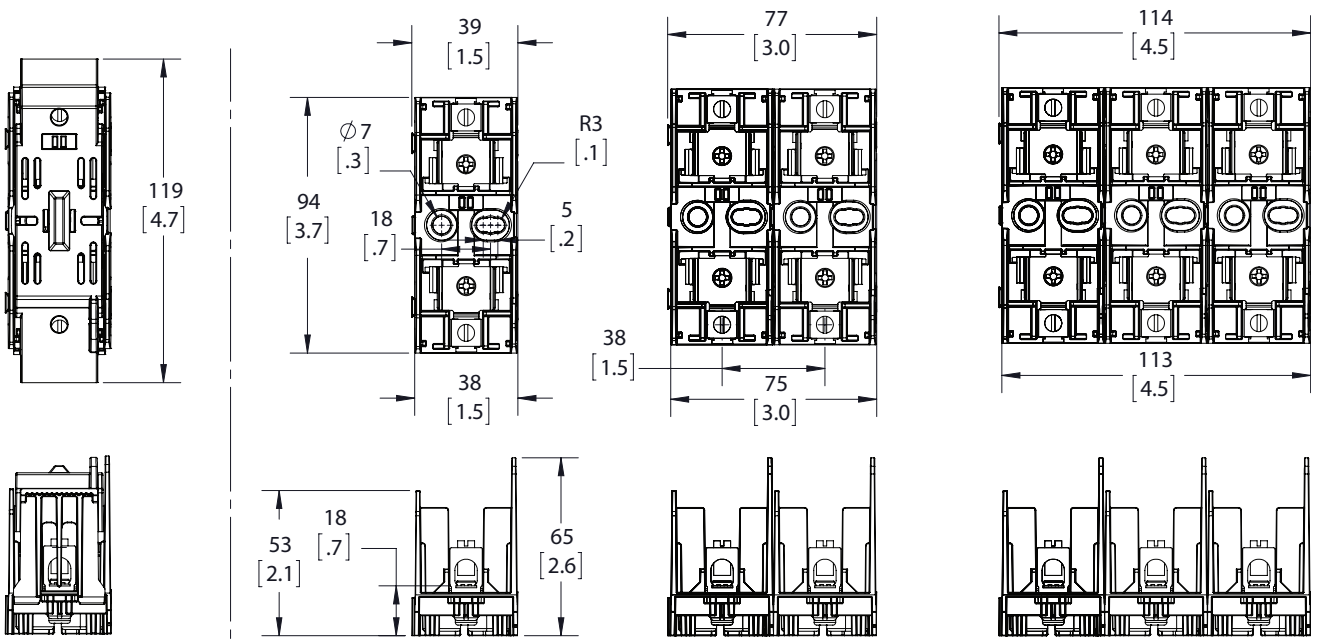

With cover.
See table 7 for available covers.

Installing/removing covers

Closing cover: Position cover over block and push straight down until it snaps/clicks into place.

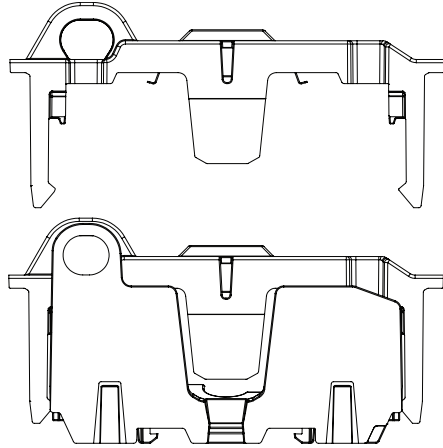

Opening cover: Using both outside handles, pull straight up.

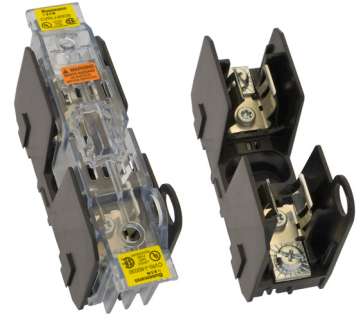

Installing blocks on DIN-Rail

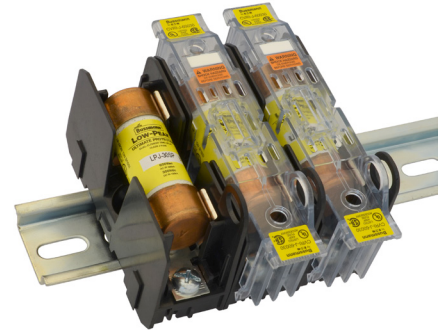
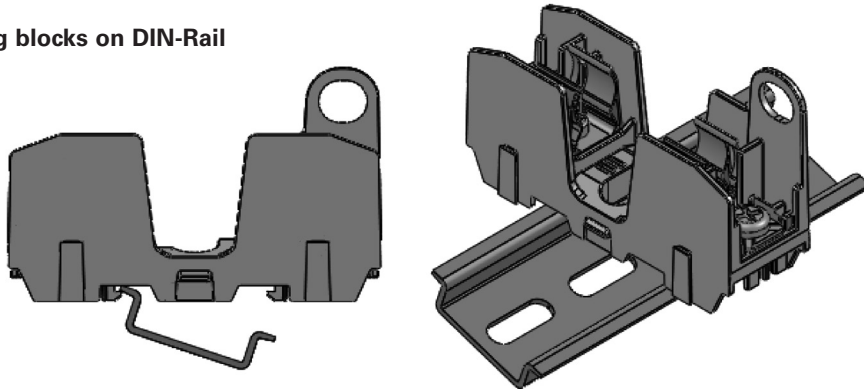

Place one edge of DIN-Rail in fuse block base, then rotate block down until it clicks into place.

The only controlled copy of this data sheet is the electronic read-only version located on the Eaton network drive. All other copies of this document are by definition uncontrolled. This bulletin is intended to clearly present comprehensive product data and provide technical information that will help the end user with design applications. Eaton reserves the right, without notice, to change design or construction of any products and to discontinue or limit distribution of any products. Eaton also reserves the right to change or update, without notice, any technical information contained in this bulletin. Once a product has been selected, it should be tested by the user in all possible applications.

Eaton
1000 Eaton Boulevard
Cleveland, OH 44122
United States
Eaton.com

Bussmann Division
114 Old State Road
Ellisville, MO 63021
United States
Eaton.com/bussmannseries

© 2017 Eaton
All Rights Reserved
Printed in USA
Publication No. 10289 - BU-SB14607
March 2017

Eato, Bussmann, Fusetron, Limitron and Low-Peak are valuable trademarks of Eaton in the US and other countries. You are not permitted to use the Eaton trademarks without prior written consent of Eaton.

CSA is a registered trademark of the Canadian Standards Group.
UL is a registered trademark of Underwriters Laboratories, Inc.

For Eaton's Bussmann series product information, call 1-855-287-7626 or visit: Eaton.com/bussmannseries