

Twist-Lock® Devices

30A, 125V AC, 2 Pole, 3 Wire Grounding

Single Flush Receptacle

HUBBELL

Features

- Wire restraint recess for both back and side wiring, greatly reduces the possibility of loosening the terminal connection
- Face color coding by voltage facilitates locating and mating of proper devices
- All-brass mounting and grounding system provides a lower resistance ground path and greater resistance to corrosion than steel mounting systems

Ordering Information

Description	Device Color	UPC	Catalog Number
Nylon face, back and	Black	783585235929	HBL2610

Listings

Listed to UL 498
Fed. Spec. W-C-596
Certified to CSA C22.2 No.42

Specifications

Face	Nylon
Base	Glass-Reinforced thermoplastic polyester (RTP)
Contacts	Brass
Terminal Screws	#10 - 32 Brass
Mounting Strap	Brass

Performance

Electrical

Current Interrupting Certified for current interrupting at full rated current
Dielectric Voltage Withstands 2,000V minimum

Mechanical

Terminal Accommodation #16 AWG - #8 AWG solid or stranded copper wire only.

Terminal Identification Terminals identified in accordance with UL 498

Environmental

Flammability V2 or better per UL94/CSA 22.2 No.0.17
Moisture Resistance IP20 Suitability
Operating Temperatures Maximum Continuous 75°C; Minimum -40°C (w/o impact)



30A 125V
NEMA L5-30R
UL/CSA
2 HP

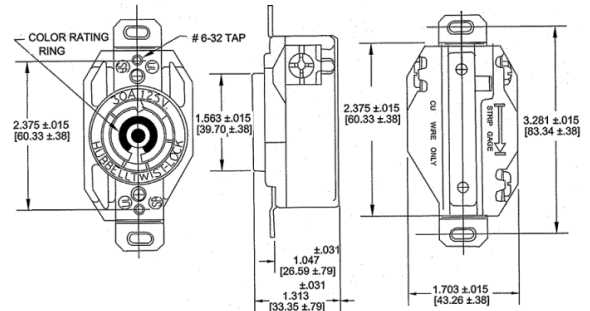

Online Resources

Customer Use Drawing
eCatalog
Installation Instructions

Accessories

Plug	HBL2611
Wallplate or Weatherproof Cover	1.60" Opening
Switched Enclosure	SETL3

Dimensions in Inches (mm)

Hubbell Wiring Device-Kellems • Hubbell Incorporated (Delaware) • 40 Waterview Drive • Shelton, CT 06484

Phone (800) 288-6000 • Fax (800) 255-1031 • Specifications subject to change without notice.

