

FLUORESCENT HIGH BAYS
FLUORESCENT LOW BAYS
COMPLEX ENVIRONMENT

Industrial Fluorescent Energy Solutions

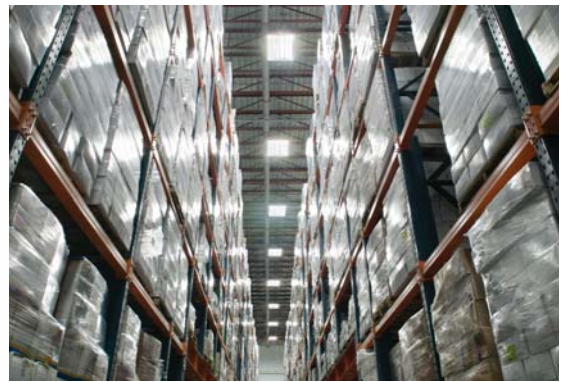

Our world is increasingly recognizing the importance of environmental sustainability and efficiency in building design. While cost containment and productivity gains are universal demands, increasing lighting efficiency requires an understanding of the role lighting plays in the business environment.

Cooper Lighting has always been at the forefront in adopting and adapting to the latest advancements in lighting technology. Over the years, businesses and communities have benefitted from partnering with Cooper Lighting to improve energy efficiency and reduce costs while protecting and enriching the environment.

To those of you considering a more efficient lighting upgrade, this brochure presents a variety of products and provides tips on how to make your retrofit project a success. A Cooper Lighting energy efficient lighting upgrade will reduce your utility bill; improve employee morale and productivity; and help protect and preserve the environment.



Table of Contents

The Fluorescent Advantage	pg. 3
Energy Savings	pg. 3
Lamp Life and Lumen Maintenance	pg. 3
Uniformity	pg. 3
Instant On/Off and Occupancy Sensors	pg. 4
T8 or T5HO?	pg. 4
Thermal Performance and Light Output	pg. 5
Visible Light and the Scotopic/Photopic (S/P) Ratio	pg. 6
Environmentally Friendly	pg. 6
Product Index	pgs. 7-8
HBI	pgs. 9-14
HBE	pgs. 15-20
I5/I8	pgs. 21-24
HBL	pgs. 25-30
MBF	pgs. 31-32
2HBG	pgs. 33-34
HBHD	pgs. 35-36
HBHT	pgs. 37-38
ARCTIC BAY - ABI	pgs. 39-40
VT4	pgs. 41-42
VT3	pgs. 43-44
VT1	pgs. 45-46
Lamp Options	pgs. 47
Emergency Options Matrix	pgs. 48
F-Bay Mounting Accessories Matrix	pgs. 48
Packaging Options Matrix	pgs. 48
Mounting Accessories	pgs. 49-50
Occupancy Sensors	pgs. 51
Power Connections	pgs. 52
I5/I8 Lens, Door Frames and Wireguards	pgs. 53
HBI, HBL and HBE Lens, Door Frames and Wireguards	pgs. 54



The Fluorescent Advantage

The most popular and productive lighting upgrades today involve replacing outdated fluorescent or HID (High Intensity Discharge) lighting systems. High Performance fluorescent lighting systems from Cooper Lighting utilize the latest technologies and design platforms to provide dramatic energy savings and superior performance.

Energy Savings

Cooper Lighting fluorescent high bays offer dramatic energy savings opportunities over HID Lighting systems and provide quick returns.

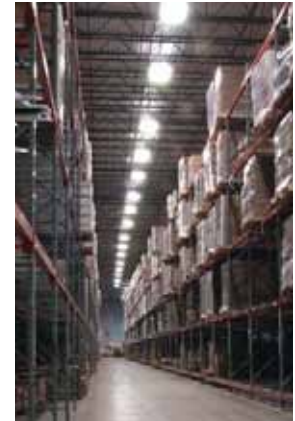
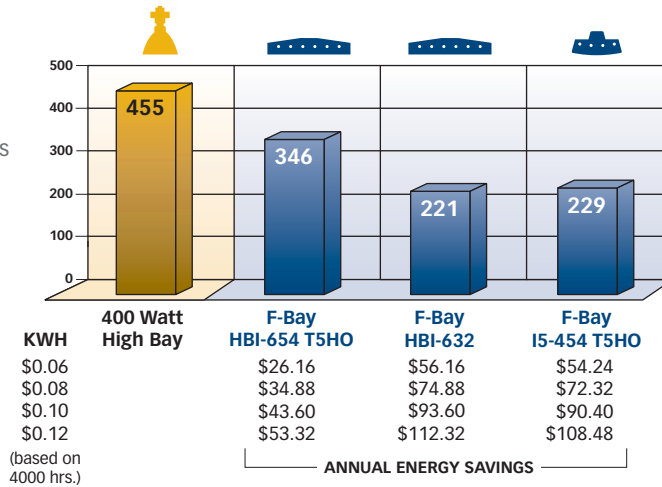

Lamp Life and Lumen Maintenance

T5 and T8 fluorescent systems provide better maintained light levels over magnetic HID lighting systems with twice the lamp life. Multiple lamped fluorescent luminaires reduce the need for immediate maintenance. With fluorescent systems, the other lamps will stay illuminated when individual lamps extinguish.

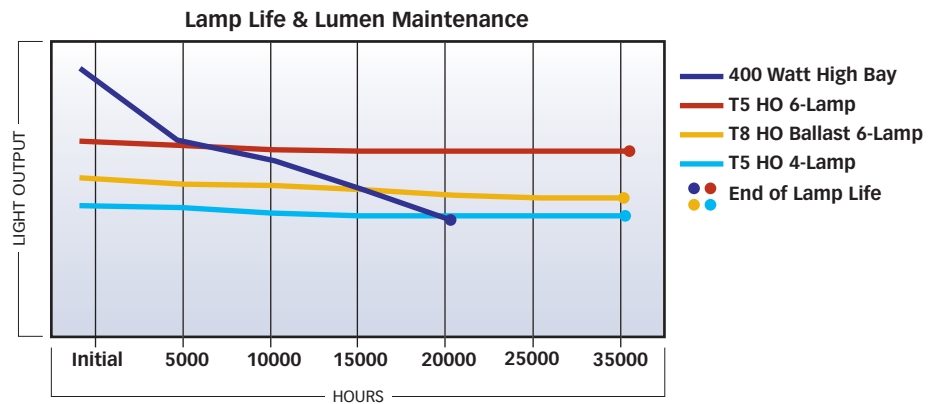

Uniformity

Linear fluorescent systems improve lighting uniformity compared with HID systems.

Dimensions 160' x 10'			
Fixture Type	400W MH High Bay	4-Lamp 54W T5HO I5 Series	6-Lamp 32W HBI Series
Number of Fixtures	13	13	13
Initial Lumens per Lamp	36000	4400	2850
Initial Lumens per Fixture	36000	17600	17100
Light Loss Factor	0.66	0.855	0.963
Input Wattage	455	229	221
Maintained Average FC	43	33	43
Max FC	47	38	48
Min FC	37	27	36
Average to Min	1.2	1.2	1.2
Max to Min	1.3	1.4	1.3
Vertical Average FC	22	15	20
Max FC	35	23	30
Min FC	12	9	11
Average to Min	2.9	1.7	2.7

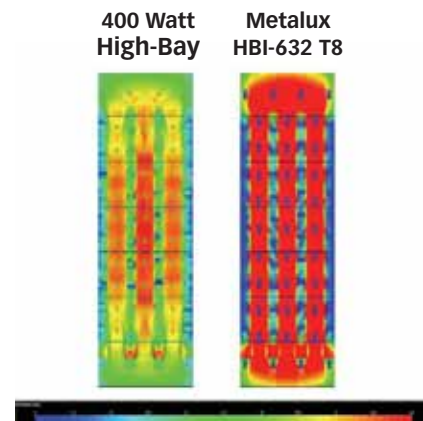

Instant On/Off and Occupancy Sensors

Fluorescent systems can be used with occupancy sensors to provide instant on/off capabilities to maximize energy savings.

When using T8 lamps and occupancy sensors, Cooper Lighting industrial fluorescent luminaires use only softer starting “program start” ballasts to minimize damage to the lamp. Under frequent on/off cycles, program start ballasts will dramatically extend lamp life over “instant start” ballasts. Cooper Lighting does not recommend or warranty instant start ballast and lamps used with motion sensors.



Metalux integral Occupancy Sensors are available in Aisle or 360° distributions.

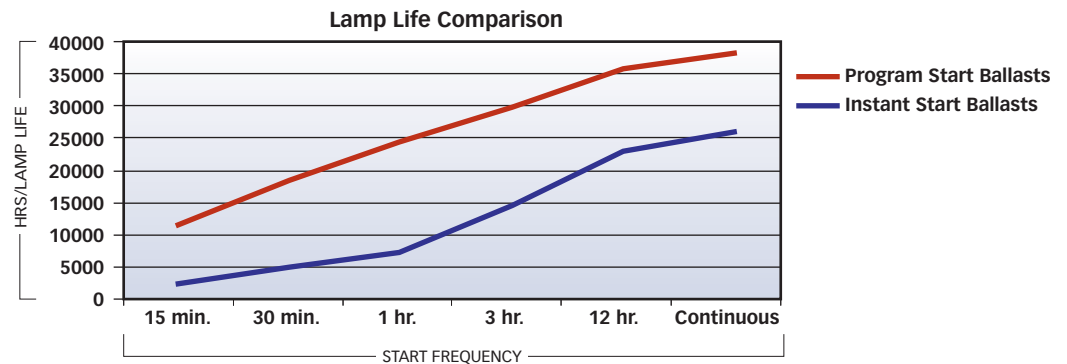

T8 or T5HO?

If your facility currently has T8 or T5HO lamps installed, the decision on lamp choice may be easy and allow for inventory consolidation. Both lamp types provide excellent performance but the attributes of each lamp type vary. Selection of lamp type is an important consideration. The following operating characteristics should be considered when making the selection:

Fluorescent High Bay System Comparison

	T8 Lighting Systems	T5HO Lighting Systems
First Costs	Similar within ranges to T5 systems with lower lamp costs offset by larger luminaire sizes.	Similar within ranges to T8 systems with higher lamp costs offset by smaller luminaire sizes.
Lamp Replacement Costs	Lower cost lamps offset with higher quantity for similar light output	Higher cost lamps offset with lower required quantity for similar light output
Lumens Per Watt	91	87
Application Heights	Suitable in wide ranges. Lower lumen output T8's are ideal for lower mounting heights below 15' while less ideal at mounting heights above 30'.	Suitable in wide ranges. Higher output T5HO lamps are ideal for higher mounting heights where higher lumen values allow for a reduced number of lamps.
Ambient Environments	Dependent on luminaire. T8 systems achieve maximum output in 78°F (25°C) ambient environments. Starting temperature ranges as low as 0°F (-18°C) dependent on manufacturer of lamp, ballast, age of lamps and luminaire design	Dependent on luminaire. T5HO systems achieve maximum output in 95°F (35°C) ambient environments. Starting temperature ranges as low as -20°F (-29°C) dependent on manufacturer of lamps, ballast, age of lamps and luminaire design
Frequency of Starts	Standard T8 systems with instant start ballasts and frequent on/off cycles can dramatically reduce lamp life. Program Start T8 ballasts should be specified when used with high occurrence of on/off cycles.	Standard Program Start ballast systems are ideal for frequent starts and use with occupancy sensors.
Ballasts Light Level Flexibility	Offered in multiple light output ranges from 71% to 115% of rated lamp life output, allowing for flexibility in application without changing lamp type.	Currently offered in fixed Light output ranges.
Luminaires in Comparison	Metalux HBI632 using (6) 80+CRI T8 lamps with High Output ballasts.	Metalux I5455 using (4) T5HO 80+CRI lamps.
	Net Lumens: 20,000 Wattage: 221	Net Lumens: 20,000 Wattage: 229

Thermal Performance and Light Output

Unlike HID lamps, T5 and T8 lamps reach optimal light output in specific temperature ranges. In partially or unconditioned spaces, temperatures from floor to ceiling can increase by over 20° in summer months.

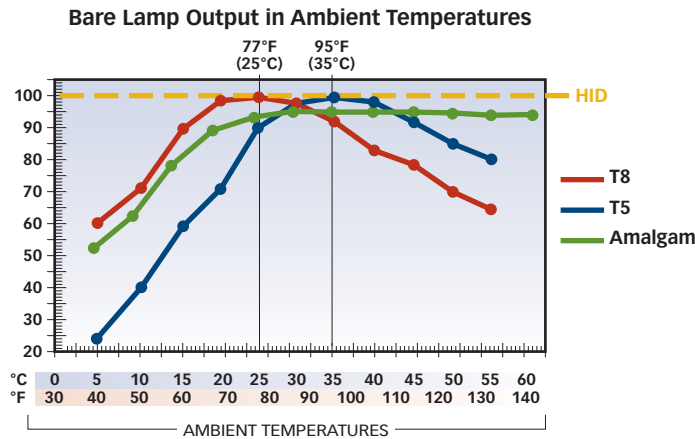
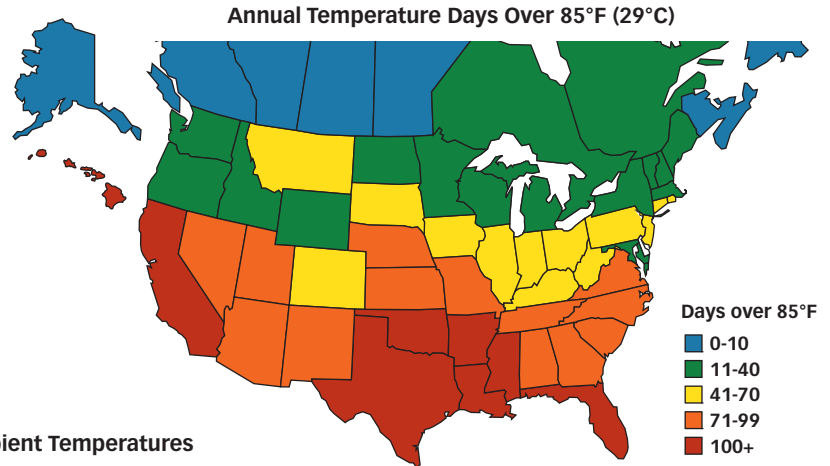
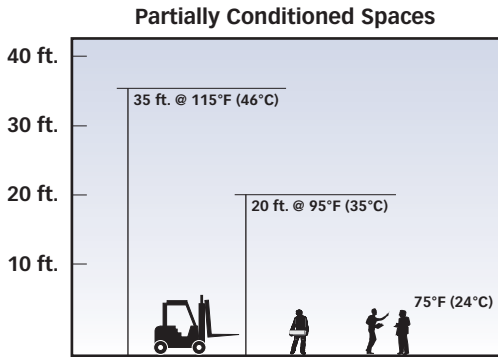

Thermally advanced Cooper Lighting industrial products optimize light output of T5HO and T8 lamps for their designed temperature ranges. Choose lamp types that optimize light output for your ambient environment and consider the use of T5HO Amalgam lamps for higher performance over wider temperature ranges.



The Metalux Arctic Bay retains and manages heat allowing it to provide over 70% of light output in freezer applications down to -20°F (-29°C).



Metalux's F-Bay series can be operated in environments up to 149°F (65°C) in open upright configurations.

Visible Light and the Scotopic/Photopic (S/P) Ratio

Scotopic/photopic ratios have been developed that attempt to replicate a measurement system more akin to how our eyes perceive brightness. Even though our eyes use both rods and cones to see light, the rods are more sensitive to blue light (scotopic vision) and cones to yellow light (photopic vision). A traditional light meter measures only photopic lumens, which are the stated lumens referenced in lamp catalogs.

The S/P Ratio acts as an adjustment to the existing photopic measurement by multiplying the standard lumens of a source with the S/P ratio or a factor thereof. As a result, an environment illuminated with warmer light sources, such as High Pressure Sodium, may appear darker than an environment illuminated with cooler light sources, like high CCT fluorescent lamps.

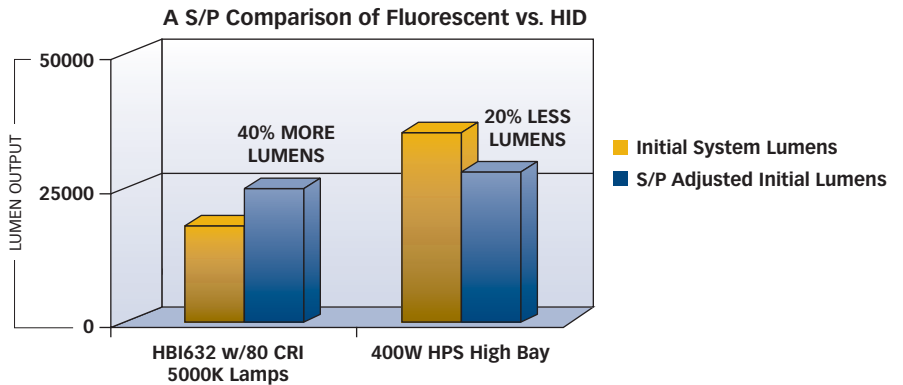

While an increasing number of lighting designers are endorsing the use of S/P ratios, this has not yet been endorsed by the Illuminating Engineering Society (IES). Cooper Lighting provides S/P adjusted lumen values throughout the product specification sections as reference information only and maintains no formal position on its application. Always test proposed products in application to validate results to your expectations

HPS vs. 5000K fluorescent – **a visible difference!**

Environmentally Friendly

Cooper Lighting fluorescent luminaires are environmentally friendly. Housings and reflector assemblies are manufactured of recyclable steel and aluminum substrates, while corrugated packaging is both recyclable and optimized in design to reduce waste on the job site.

The use of low mercury fluorescent lamps also offers an attractive alternative to HID systems. A low mercury T5HO fluorescent lamp can contain as little 1.4 Mg. of mercury compared with up to 70 Mg. for a 400 watt Metal Halide lamp.



Index

pgs. 9-14



pgs. 15-20



pgs. 21-24



pgs. 25-30



pgs. 31-32



pgs. 33-34



	HBI	HBE	I5/I8	HBL	MBF	HBG
Description	Industry-leading fluorescent high bay, HBI series features specification grade full body housing with three optical distributions - narrow, medium and wide - providing structural integrity and optimal performance in conventional HID applications.	Full body construction in an open body high bay. Standard side rails provide a strong, clean finished frame while still offering energy efficiency and performance in a compact body. Features include lens door or wireguard option.	Narrow 11" specification grade body with two optics for medium and wide distribution, and shielding options for industrial and aesthetic upgrades for retail and commercial applications.	Open body linear high bay, the HBL series offers energy efficiency and performance in a compact body. Features include three optical distributions, and wireguard.	High performance in a narrow package with three optical distributions – Focus, Task, Normal – providing lower lighting power densities than HID and T12 sources at higher mounting heights. Continuous row installations provide unmatched uniform performance.	Energy-efficient alternative for recessed grid/lay-in concealed T, and slot grid ceilings and flange trim applications. HBG is available with optional shielding options for a seamless ceiling line.
Lamping	HBI: 4, 5, 6 lamp – T5, T5HO, T8	HBE: 4, 6, 8, 10 lamp – T5HO, T8	4': 2, 3, 4 lamp – T5, T5HO, T8 8': 4, 6, 8 lamp – T5, T5HO, T8	HBL: 4, 6, 8, 10 lamp – T5HO, T8	4': 1, 2 lamp – T5HO, T8 8': 2, 4 lamp – T5HO, T8	2HBG: 4, 6 lamp – T5, T5HO, T8
Replaces	150-400 Watt HPS 175-400 Watt MH HO, VHO T12 Fluorescent	150-1000 Watt HPS 175-1000 Watt MH HO, VHO T12 Fluorescent	150-400 Watt HPS 150-1000 Watt MH Slimline, HO, VHO T12 Fluorescent	150-1000 Watt HPS 175-1000 Watt MH HO, VHO T12 Fluorescent	150-400 Watt HPS 175-400 Watt MH HO, VHO T12 Fluorescent	150-400 Watt HPS 175-400 Watt MH HO, VHO T12 Fluorescent
Listings & Certification	UL/cUL Listed Damp Location Modular power receptacle meets UL2459 and NEC 410.73 (G) for make and break under load from outside to the luminaire to speed maintenance Thermally optimized for environments up to 149°F (65°C) when used with high temperature ballasts in open uplight and downlight configurations T5 systems are warranted for ambient environments up to 149°F (65°C) in open uplight configurations T8 Systems are warranted for environments up to 122°F (50°C) in open uplight configurations	UL/cUL Listed Damp Location Modular power receptacle meets UL2459 and NEC 410.73 (G) for make and break under load from outside to the luminaire to speed maintenance Thermally optimized for environments up to 149°F (65°C) when used with high temperature ballasts in open uplight and downlight configurations T5 systems are warranted for ambient environments up to 149°F (65°C) in open uplight configurations T8 Systems are warranted for environments up to 131°F (55°C) in open uplight configurations	UL/cUL Listed Damp Location Modular power receptacle meets UL2459 and NEC 410.73 (G) for make and break under load from outside to the luminaire to speed maintenance Thermally optimized for environments up to 149°F (65°C) when used with high temperature ballasts in open uplight and downlight configurations T5 systems are warranted for ambient environments up to 149°F (65°C) in open uplight configurations T8 Systems are warranted for environments up to 122°F (50°C) in open uplight configurations	UL/cUL Listed Damp Location Modular power receptacle meets UL2459 and NEC 410.73 (G) for make and break under load from outside to the luminaire to speed maintenance Thermally optimized for environments up to 149°F (65°C) when used with high temperature ballasts in open uplight and downlight configurations T5 systems are warranted for ambient environments up to 149°F (65°C) in open uplight configurations T8 Systems are warranted for environments up to 131°F (55°C) in open uplight configurations	UL/cUL Listed Damp Location	UL/cUL Listed Damp Location
Mounting	HBAYC Chain, Single Point Mount, Y-Toggle, Stem Sets	HBAYC Chain, Single Point Mount, Loop, Y-Toggle	AYC Chain, Top Connector Box, Loop, Single-Toggle	HBAYC Chain, Single Point Mount, Loop, Y-Toggle	AYC Chain, Y & Single Toggle	Recessed Grid or Flange



HBHD	HBHT	Arctic Bay	VT4	VT3	VT1	
<p>Designed for use in high mounting height applications where periodic cleaning with high pressure is required. The HBHD is a surface mounted luminaire with a hole-free design, enclosed and gasketed to provide 800 psi hose down protection.</p>	<p>Pendant mount hose down fixture with articulated top for water run-off. Perfect for cleanroom and food processing areas where periodic cleaning is required.</p>	<p>The Arctic Bay's enclosed full body housing and sealed and gasketed door frame provide optimal lamp operation - 70% rated light output down to -15°F (-26°C).</p>	<p>Vaportite high bay featuring T8, T8VHO and T5HO configurations up to six lamps. Rugged and durable, the VT4 has the certifications to meet your energy requirements in the dirtiest environments.</p>	<p>Energy efficient Vaportite fixture featuring T8 and T5HO lamp configurations with two optical distributions. The VT3 features a rugged and durable fiberglass housing and high impact diffuser.</p>	<p>Slim profile Vaportite fixture features T8 and T5 one lamp configurations enclosed in a rugged and durable weatherproof housing and diffuser assembly.</p>	Description
<p>2HBHD: 4, 6 lamp – T5, T5HO, T8</p>	<p>HBHT: 4, 6 lamp – T5, T5HO, T8</p>	<p>ABI: 4, 5, 6 lamp – T5HO</p>	<p>VT4: 4, 6 lamp – T5HO, T8, T8VHO</p>	<p>VT3 4': 1, 2, 3 lamp – T8 and T5HO 8': 1, 2, 3 lamp – T8 and T5HO</p>	<p>VT1: 1 lamp – T5, T5HO, and T8</p>	Lamping
<p>150-400 Watt HPS 175-400 Watt MH HO, VHO T12 Fluorescent</p>	<p>150-400 Watt HPS 175-400 Watt MH HO, VHO T12 Fluorescent</p>	<p>150-400 Watt HPS 175-400 Watt MH HO, VHO T12 Fluorescent</p>	<p>150-400 Watt HPS 175-400 Watt MH HO, VHO T12 Fluorescent</p>	<p>50-150 Watt HPS 50-250 Watt MH Slimline HO, VHO T12 Fluorescent</p>	<p>50-100 Watt HPS 50-100 Watt MH</p>	Replaces
<p>UL/cUL Listed Damp Location IP65 Compliant 800 PSI</p>	<p>UL Listed Wet Location IP65 Compliant 800 PSI NSF</p>	<p>UL/cUL Listed Damp Location Thermally optimized for environments down to -20°F (-29°C)</p>	<p>UL/cUL Listed Wet Location IP65 and IP67 Compliant NSF NEMA 4X</p>	<p>UL/cUL Listed Wet Location IP65 Compliant NSF</p>	<p>UL/cUL Listed Wet Location IP65 Compliant NSF</p>	Listings & Certification
<p>Surface Mount</p>	<p>Chain or Cable Mount, Y-Snap Hook, 3/4" Stem</p>	<p>HBAYC Chain, Single Point Mount, Y-Toggle, Stem Sets</p>	<p>Mounting Bail, Y-Toggle, Surface Mount Bracket</p>	<p>Mounting Bracket Included, VT2 Chain/Set-U, Snap on Bracket (BKS)</p>	<p>Mounting Bracket Included or VT2 Chain/Set-U</p>	Mounting



Full bodied housing utilizes captive fasteners to protect optical assembly and assure structural integrity.

Optional uplight apertures (approximately 8% uplight).

Access plate located in the center of housing for easy access to wiring.



Includes V Hangers for rapid installation!

Housing is "Post" painted with a high performance polyester powder coat finish to protect against contaminants and oxidation.

Factory installed code compliant disconnect for safe and convenient means of disconnecting power.

LINEAR DISCONNECT

Thermally optimized F-Bay is suitable for environments up to 149°F (65°C) when used with high temperature environment ballasts. T5 and T8 systems are warranted for ambient environments up to 149°F (65°C) for three years and 131°F (55°C) for five years in open uplight and downlight configurations.



Cooper Lighting's modular power receptacle meets UL2459 and NEC 410.73 and is UL/cUL rated for make and break under load from outside the luminaire to speed maintenance.



Die formed reflectors are faceted for 4, 5, and 6 lamp configurations with three optical distributions narrow, medium, and wide. Narrow beam optical modules utilize 95% specular aluminum, the Medium beam utilizes a 95% micro matte aluminum, and the Wide beam uses a high performance 92% reflective polyester powder coated finish.

Integral occupancy sensor available and provides from 600 sq. ft. up to 1250 sq. ft. of coverage in a maximum mounting height of 40'.



Modular F-Bay Power Supply

Cooper Lighting's F-Bay Modular Power Supply allows external fixture access for safe and easy servicing. There is no need to remove lamps or reflectors to disconnect fixture power with F-Bay Modular Power Supply. Access to the individual fixture's power supply allows servicing without turning off all the fixtures disrupting occupants. F-Bay Modular Power Supply is a time saver in installation – **simply plug & power.**



1. Modular Power Supply Receptacle supplied mounted into fixture Access Plate



2. Modular Power Cord & Plugs in 120, 277, 347, & 480V configurations for easy plug & power into existing supply

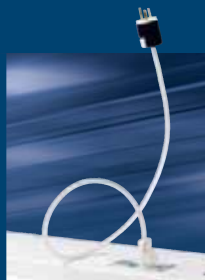

No internal fixture access required for installation or disconnecting power



Modular Motion Sensor Option supplied with Mounting Box and Modular Power Supply Receptacle

Code Compliance

- UL/cUL Certified for Make/Break under load (UL2549)
- Meets NEC requirements for ballast disconnect (NEC 410.73G)
- Allows for addition of Occupancy Sensor without hard connections
- Receptacles complete with insulating/dust cap

Shielding Options



Prismatic or clear acrylic lens & steel door frame. Optional gasketed door available.

Optional slotted doorframe option (SDF) available with prismatic or clear acrylic lens provides increased efficiency.

Wireguard w/acrylic lens and steel door frame.

Heavy duty stock wireguard (Ideal for gymnasium applications).

Mounting Accessories



HB-SPM=Single Monopoint Hanger w/Hub (Galvanized)

FH-1=Fixture Hook 2-1/2" (must be used with HB-SPM)

FL-1=Fixture Loop 2-1/2" (must be used with HB-SPM)

RH-1=Retrofit Hanger (must be used with HB-SPM)

HBAYC=Standard V-hook Hanger included (ideal for gymnasium applications)

Y=Mounting Toggle and 10' or 25' cable

Thermal Optimization

To optimize luminaire performance, HBI series offers a variety of lamp and shielding options. Use the Thermal Optimization chart to determine the options that are appropriate for the ambient environments in which they will be installed.

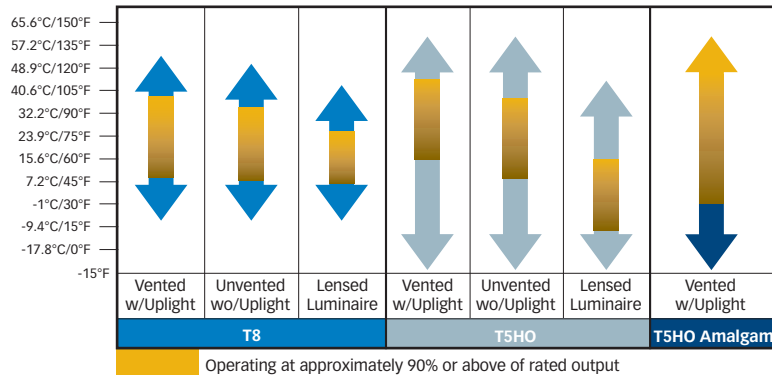

System Performance

HBI

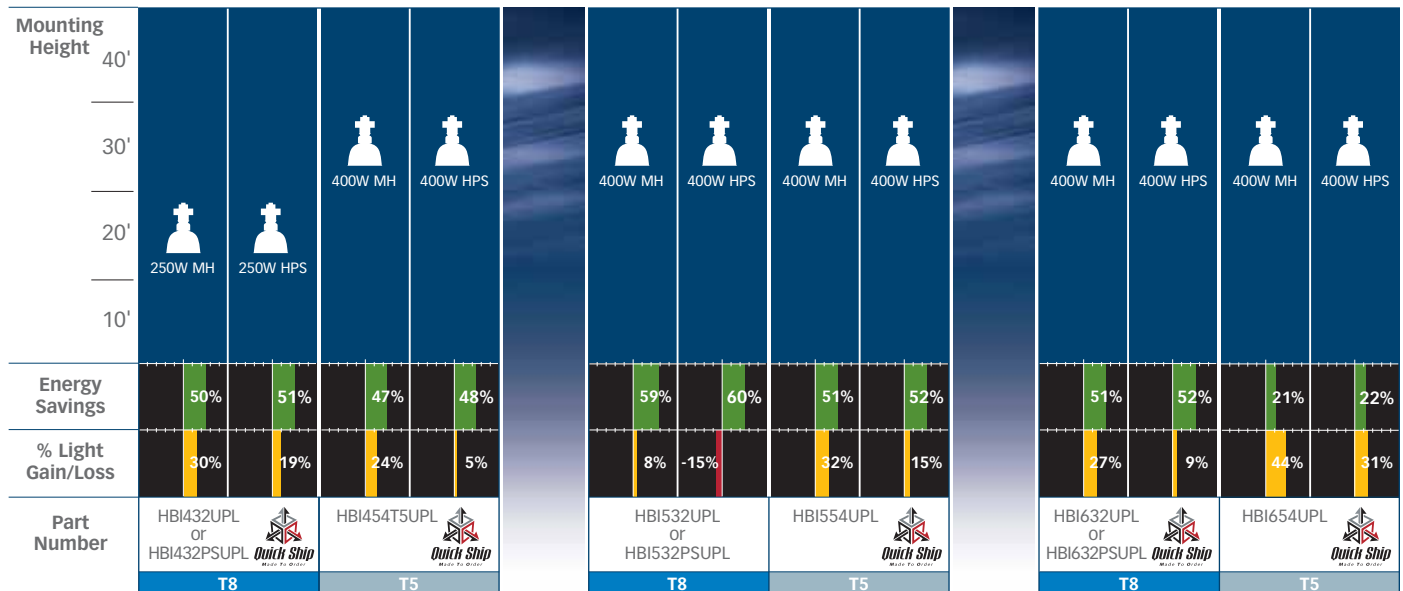

% light gain/light loss utilize S/P adjusted lumens.



HBI T8 HIGH-BAY INDUSTRIAL LUMINAIRE

Ordering Information Sample Number: HBI-632-N-UNV-EB82/PLUS-MP-UPL-U

Includes V Hangers for rapid installation⁽⁶⁾

<p>Series HBI=High Bay Industrial</p>	<p>Voltage⁽²⁾ UNV=Universal 120/277 Volt UNC=Universal 347/480 Volt⁽⁵⁾ 120V=120 Volt 277V=277 Volt 347V=347 Volt 480V=480 Volt</p>	<p>Ballast Type EB8 =T8 Electronic Instant Start.⁽³⁾ Total Harmonic Distortion < 10% No. of Ballast 2 or 3 EB8 /PLUS= T8 Electronic Instant Start.⁽³⁾ High Ballast Factor >1.15. Total Harmonic Distortion < 10% No. of Ballast 1, 2 or 3 ER8 =T8 Electronic Program Rapid Start.⁽³⁾ Total Harmonic Distortion < 10% No. of Ballast 2 or 3 ER8 /PLUS= T8 Electronic Program Start.⁽³⁾ High Ballast Factor >1.15. Total Harmonic Distortion < 10% No. of Ballast 2 or 3 DIM=Consult Factory⁽⁷⁾</p>	<p>Options Lamps Installed L8830=T8 Lamp, 85CRI 3000K L8835=T8 Lamp, 85CRI 3500K L8841=T8 Lamp, 85CRI 4100K L8850=T8 Lamp, 85CRI 5000K HL=Add HL at end of lamp for high lumen lamps, T8 only GL=Single Element Fuse GM=Double Element Fuse EL=Emergency Installed⁽²⁾</p>	<p>Options MP=Modular Power Receptacle (Used for all Cord or Cord and Plug options)⁽¹⁾ NUA=No upright apertures in housing. (Cannot be combined w/UPL) UPL=Uplight Apertures MWS=Modular Wiring System MS=360° or 180° Motion Sensor, 120 through 347, or 480V⁽⁴⁾ G2=Gasketed Door (Requires Selection of Lensed Doorframe) SDF=Slotted Doorframe (Requires Selection of Lensed Doorframe)</p>	<p>Packaging U=Unit Pack PALC=Palletized In Carton PAL=Job Pack Out of Carton</p>
<p>No. of Lamps 4=4 Lamps 5=5 Lamps 6=6 Lamps</p>	<p>Lamp Type 32=32W T8 Lamps (48")</p>	<p>Distribution N=Narrow Beam (Standard) M=Medium Beam W=Wide Beam</p>	<p>Shielding Blank=None A=Prismatic Acrylic Lens & Doorframe WG=Wireguard & Doorframe A/WG=Acrylic Lens, Wireguard & Doorframe CL=Clear Acrylic Lens & Doorframe CL/WG=Clear Lens, Wireguard & Doorframe</p>	<p>Accessories (order separately) HB-SPM=Single Monopoint Hanger w/Hub RH-1=Retrofit Hanger FH-1=Fixture Hook FL-1=Fixture Loop Y-TOGGLE-=Y Mounting Toggle, #2 Cable⁽⁸⁾ (Specify 10' or 30', requires 2 per fixture) HBAYC-CHAIN/SET/U=(2) V-Hook Hangers, 36" Chain Sets w/S-Hooks MC3=3' Modular Power Cord MPC3=3' Modular Power Cord & Plug (Specify Voltage) MC6=6' Modular Power Cord MPC6=6' Modular Power Cord & Plug (Specify Voltage) MMS=360° or 180° Aisle Motion Sensor with Modular Power Receptacle (120-277V)⁽¹¹⁾ SWG=Heavy Duty Wireguard for Field Installation</p>	

NOTES: ⁽¹⁾Requires use of MC_ or MPC_cord accessories, specify voltage for plugs. ⁽²⁾Voltage must be specified when ordered with plugs or emergency ballasts. ⁽³⁾ER8 and EB8 ballast systems suitable for operation in ambient environments up to 122°F (50°C) in open upright configuration. ⁽⁴⁾When ordering MS option, specify UNV (for 120 or 277V), 347 or 480V. ⁽⁵⁾2/3 lamp ballast configurations in EB8/PLUS only for T8 UNC versions. ⁽⁶⁾Can be used in high abuse applications such as gymnasiums. ⁽⁷⁾Dimming ballast must be specified at time of order. ⁽⁸⁾Two required.



Quick Ship Ordering Information Sample Number: HBI632-MP-UPL-L5

Quick Ship orders ship in 5 days in order quantities not to exceed 200 pieces.

Includes V Hangers for rapid installation⁽⁶⁾

NOTE: Orders received after noon are entered on the following day.

<p>Family HBI</p>	<p>Distribution Blank=Narrow Beam W=Wide Beam</p>	<p>Ballast Type 4L T8 Systems Blank=(1) 120/277V 4 Lamp T8 Instant Start Electronic, 1.15 BF PS=(1) 120/277V 4 Lamp T8 Electronic Program Rapid Start, 1.15 BF⁽⁹⁾ 6L T8 Systems Blank=(1) 120/277V 6 Lamp High Ballast Factor > 1.15 T8 Instant Start Electronic PS=(2) 120/277V 4L and 2L High Ballast Factor > 1.15 T8 Electronic Program Rapid Start⁽⁹⁾</p>	<p>Power Receptacle Blank=Standard Wiring to Access Plate MP=Modular Power Receptacle⁽¹⁰⁾</p>	<p>Uplight Blank=No Uplight UPL=Uplight</p>	<p>Lamping Blank=No Lamps L4=Lamps Installed 85+CRI 4100K⁽¹¹⁾ L5=Lamps Installed 85+CRI 5000K L5HL=Lamps Installed 85+CRI 5000K, High Lumen</p>
------------------------------	--	---	---	--	---

NOTES: ⁽⁹⁾Recommended when utilizing Motion Sensor option. ⁽¹⁰⁾Requires use of Modular cord and plug accessories. ⁽¹¹⁾High lumen (3100 initial) lamps supplied for 4100K.

Dimensions

HBI T8 Lamp Configurations

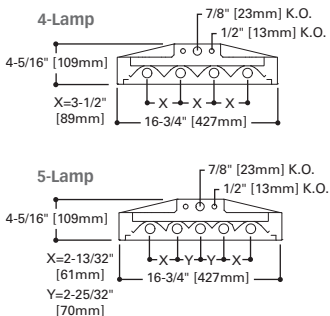

Dimensions for Top View

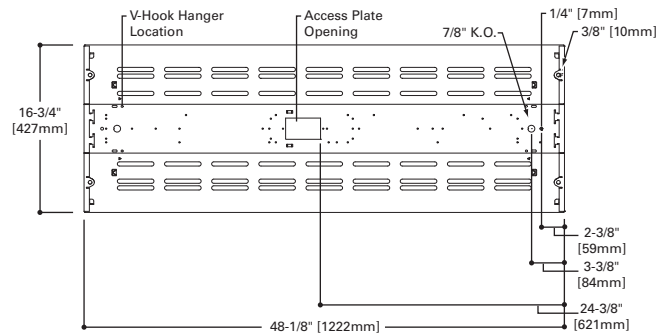

Photometrics

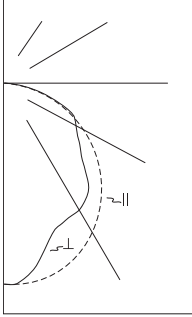

HBI-632-N-UNV-EB82
Electronic Ballasts
(6) 32W T8 lamps 2850 lumens
Spacing criterion: (H) 1.3 x mounting height
Efficiency 91.3%
Test Report: HBI632.IES

Coefficients of Utilization

rc	Effective floor cavity reflectance 20%						
	80%		50%		30%		
rw	70	50	30	10	50	30	10
RCR							
0	109	109	109	109	101	101	97
1	99	94	90	87	89	85	83
2	90	82	76	70	77	72	68
3	82	72	64	58	68	62	57
4	75	64	55	49	60	53	48
5	69	57	49	42	54	47	42
6	64	51	43	37	49	42	36
7	59	46	38	33	44	37	32
8	55	42	35	29	41	34	29
9	51	39	31	26	37	31	26
10	48	36	29	24	35	28	24

Zonal Lumen Summary

Zone	Lumens	%Lamp	%Fixture
0-30	4244	24.8	27.2
0-40	6874	40.2	44.0
0-60	12002	70.2	76.9
0-90	15606	91.3	100.0
0-180	15606	91.3	100.0

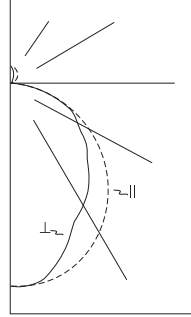

HBI-632-N-UNV-EB82-UPL
Electronic Ballasts
(6) 32W T8 lamps 2850 lumens
Spacing criterion: (H) 1.3 x mounting height, (L) 1.1 x mounting height
Efficiency 94.5%
Test Report: HBI632-UPL.IES

Coefficients of Utilization

rc	Effective floor cavity reflectance 20%						
	80%		50%		30%		
rw	70	50	30	10	50	30	10
RCR							
0	112	112	112	112	103	103	98
1	102	98	94	90	90	87	85
2	93	85	79	73	79	74	70
3	85	75	67	61	70	64	59
4	78	66	58	52	62	55	50
5	71	59	51	45	56	49	44
6	66	54	45	39	50	43	38
7	61	49	40	35	46	36	34
8	57	44	37	31	42	35	30
9	53	41	33	28	39	32	28
10	50	38	30	25	36	30	25

Zonal Lumen Summary

Zone	Lumens	%Lamp	%Fixture
0-30	4812	26.4	27.9
0-40	7183	42.0	44.5
0-60	12252	71.7	75.8
0-90	15556	91.0	96.3
0-180	16155	94.5	100.0

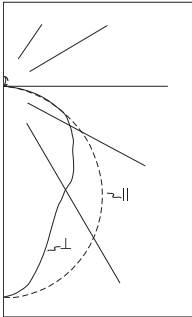

HBI-532-N-UNV-EB82/PLUS-UPL
Electronic Ballasts
(5) 32W T8 lamps 3100 lumens
Spacing criterion: (H) 1.3 x mounting height, (L) 0.8 x mounting height
Efficiency 90.4%
Test Report: HBI532-UPL.IES

Coefficients of Utilization

rc	Effective floor cavity reflectance 20%						
	80%		50%		30%		
rw	70	50	30	10	50	30	10
RCR							
0	107	107	107	107	99	99	94
1	98	93	90	86	87	84	81
2	89	81	75	70	76	71	67
3	81	72	64	58	67	61	56
4	74	63	56	50	60	53	48
5	68	57	49	43	54	47	42
6	63	51	43	38	48	42	37
7	59	47	39	33	44	38	33
8	55	43	35	30	41	34	29
9	51	39	32	27	37	31	27
10	48	36	29	25	35	29	24

Zonal Lumen Summary

Zone	Lumens	%Lamp	%Fixture
0-30	3999	25.8	28.5
0-40	6258	40.4	44.6
0-60	10620	68.5	75.8
0-90	13640	88.0	97.3
0-180	14017	90.4	100.0

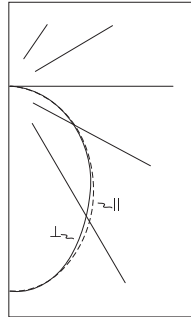

HBI-632-N-A-UNV-EB82-SDF
Electronic Ballasts
(6) 32W T8 lamps 2850 lumens
Spacing criterion: (H) 1.2 x mounting height, (L) 1.1 x mounting height
Efficiency 82.1%
Test Report: HBI632A-SDF.IES

Coefficients of Utilization

rc	Effective floor cavity reflectance 20%						
	80%		50%		30%		
rw	70	50	30	10	50	30	10
RCR							
0	97	97	97	97	90	90	86
1	89	85	81	78	79	77	74
2	81	74	69	64	70	65	62
3	74	65	59	54	62	56	52
4	68	58	51	46	55	49	45
5	62	52	45	39	49	43	39
6	58	47	40	35	45	39	34
7	54	43	36	31	41	35	30
8	50	39	32	28	37	31	27
9	47	36	29	25	34	29	25
10	44	33	27	23	32	26	22

Zonal Lumen Summary

Zone	Lumens	%Lamp	%Fixture
0-30	4135	24.2	29.8
0-40	6565	38.4	47.3
0-60	11119	65.0	80.0
0-90	13891	81.2	100.0
0-180	13891	81.2	100.0

Illuminance Estimator

Illuminance Levels (FC) & Watts Per Sq. Ft. (LPD)

Based on 100 ft. x 100 ft. Open Room

HBI632UPL

Mounting Height	Spacing on Center	15 ft			20 ft			25 ft			30 ft		
		Qty	FC	LPD	Qty	FC	LPD	Qty	FC	LPD	Qty	FC	LPD
20 ft	20 ft	49	69.0	1.08	25	35.3	0.55	16	22.6	0.35	12	16.9	0.26
	25 ft	49	64.0	1.08	25	32.6	0.55	16	20.9	0.35	12	15.7	0.26
	30 ft	49	59.0	1.08	25	30.3	0.55	16	19.4	0.35	12	14.5	0.26

Choose the spacing and mounting height to determine the average footcandle and watts per square foot values. All the calculations are based on the published IESNA Zonal Cavity Method and associated algorithms. Results are calculated from manufacturer photometric files.

System Performance Table

HBI System Comparison	No. of Lamps	Lamp Lumens	Lumen Maintenance ¹	Fixture Efficiency	Ballast Factor	Design System Lumens ²	S/P Ratio ³	Brightness Perception	S/P Adjusted Lumens ⁴	Wattage	Cost of 1000 S/P Adj Lumens - 4000 hrs @ 0.08 kWh	LER ⁵
HBI-432-N-UNV-EB81/PLUS-UPL-U	4	3100	94%	90%	1.18	12337	1.95	1.40	17228	148	\$2.60	116
HBI-532-N-UNV-EB82/PLUS-UPL-U	5	3100	94%	90%	1.18	15473	1.95	1.40	21607	185	\$2.58	117
HBI-632-N-UNV-EB82/PLUS-UPL-U	6	3100	94%	95%	1.18	19496	1.95	1.40	27225	222	\$2.34	123
Comparison System												
400W Metal Halide High Bay	1	36000	75%	78%	1	21087	1.50	1.22	25826	455	\$7.22	44
400W High Pressure Sodium High Bay	1	50000	81%	78%	1	31631	0.62	0.79	24906	464	\$7.63	42

FOOTNOTES: ¹ Lumen maintenance is based on lamp manufacturer's stated data combined with estimated dirt depreciation. ² Design System Lumens is the fixture lumens at 40% of rated lamp life and is calculated as Quantity of Lamps x Lamp Lumens x Lumen Maintenance x Fixture Efficiency x Ballast Factor. ³ S/P Ratio is the lamp manufacturers stated Scotopic/Photopic Ratio; accepted by some lighting designers to adjust for the relative strengths of scotopic and photopic vision, not yet adopted by IESNA. ⁴ S/P Adjusted Lumens calculates the brightness perception scotopic/photopic ratio as Design System Lumens x (S/P)^{0.5} based on 5000K lamps. ⁵ LER (Luminaire Efficiency Ratio) is an accepted method of comparing fixture performance.



HBI T5 HIGH-BAY INDUSTRIAL LUMINAIRE

Ordering Information Sample Number: HBI-554T5-N-UNV-EHT2-MP-UPL-U

Includes V Hangers for rapid installation⁽⁶⁾

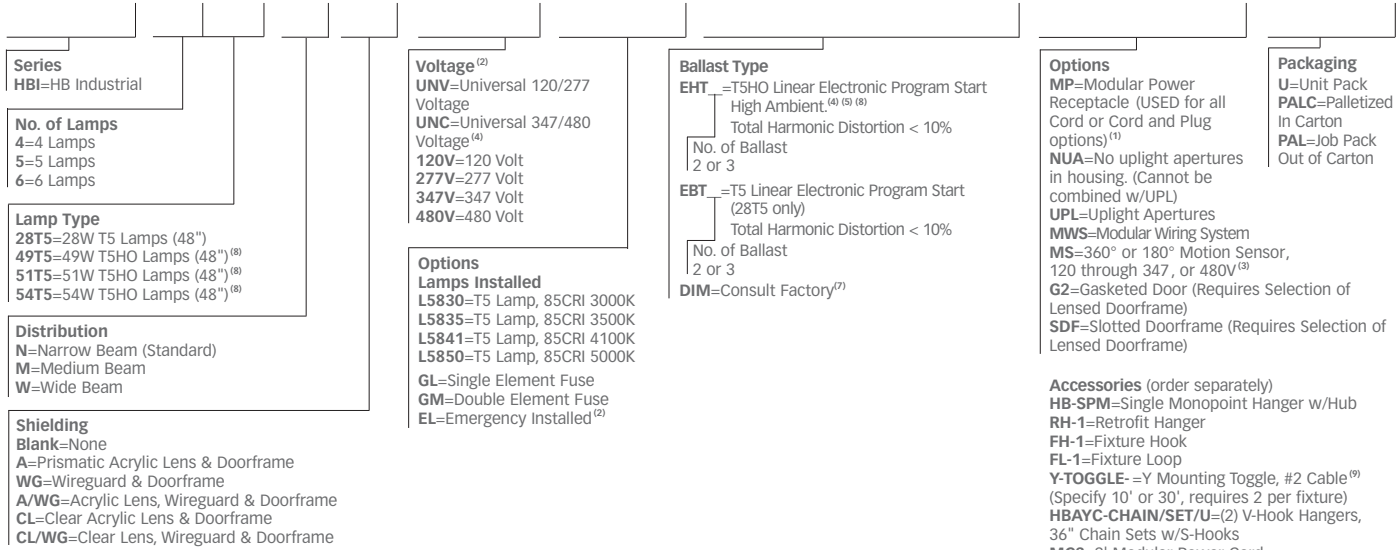

NOTES: ⁽¹⁾Requires use of MC... or MPC...cord accessories, specify voltage for plugs. ⁽²⁾Voltage must be specified when ordered with plugs or emergency ballasts. ⁽³⁾When ordering MS option, specify voltage as UNV (for 120 or 277V), 347 or 480V. ⁽⁴⁾2 lamp ballast configurations only for T5 UNC versions. ⁽⁵⁾EHT/HT5/HCT5 ballast systems suitable for ambient environments not to exceed 149°F (65°C) in open upright configurations and less lens option. ⁽⁶⁾Can be used in high abuse applications such as gymnasiums. ⁽⁷⁾Dimming ballast must be specified at time of order. ⁽⁸⁾EHT standard with T5HO lamps. ⁽⁹⁾Two required.



Quick Ship Ordering Information Sample Number: HBI454HCT5-MP-UPL-L5

Quick Ship orders ship in 5 days in order quantities not to exceed 200 pieces.

Includes V Hangers for rapid installation⁽⁶⁾

NOTE: Orders received after noon are entered on the following day.

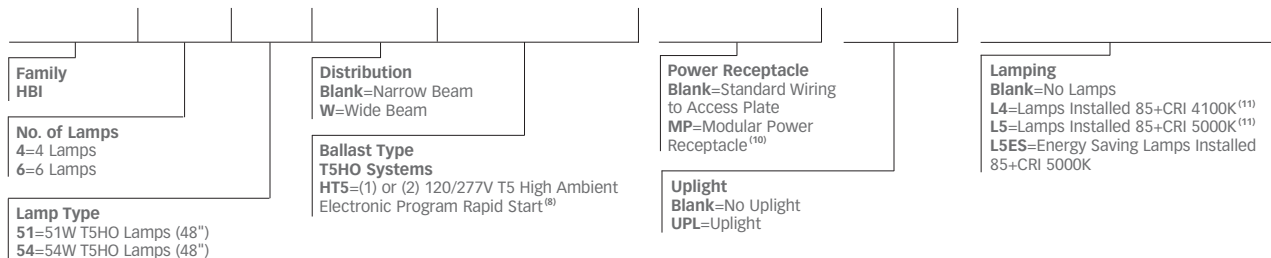

NOTES: ⁽¹⁰⁾Requires use of Modular cord and plug accessories. ⁽¹¹⁾For Quick Ship, lamping option only available w/54W lamp type.

Dimensions

HBI T5 Lamp Configurations

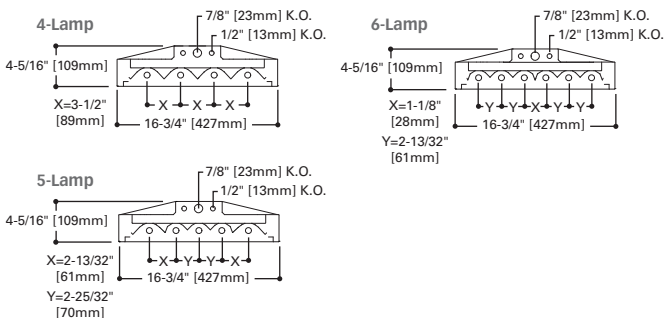

Dimensions for Top View

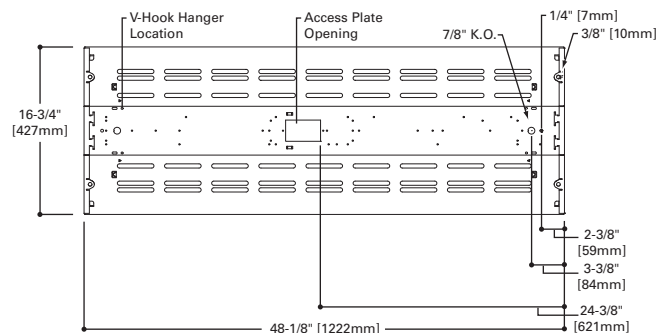

Photometrics

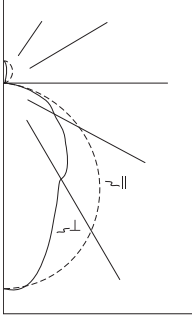

Coefficients of Utilization

rc	Effective floor cavity reflectance									
	80%			50%			30%			
	70	50	30	10	50	30	10	50	30	10
RCR										
0	110	110	110	110	101	101	101	96	96	96
1	101	97	93	90	90	87	84	85	83	81
2	92	85	79	74	79	74	70	75	72	68
3	85	75	68	62	70	64	60	67	62	58
4	78	67	59	53	63	56	51	60	55	50
5	72	60	52	46	56	50	45	54	48	44
6	66	54	46	41	51	45	40	49	43	39
7	62	50	42	36	47	40	35	45	39	35
8	58	45	38	33	43	37	32	42	36	31
9	54	42	34	29	40	33	29	39	33	29
10	51	39	32	27	37	31	26	36	30	26

HBI-654T5-N-UNV-EHT2-UPL
Electronic Ballasts
(2) F54T5 54W lamps 4400 lumens
Spacing criterion: (H) 1.2 x mounting height, (L) 0.9 x mounting height
Efficiency 93.3%
Test Report: HBI654T5UPL.IES

Zonal Lumen Summary

Zone	Lumens	%Lamp	%Fixture
0-30	4783	28.5	30.5
0-40	7391	44.0	47.1
0-60	12178	72.5	77.7
0-90	14984	89.2	95.6
0-180	15682	93.3	100.0

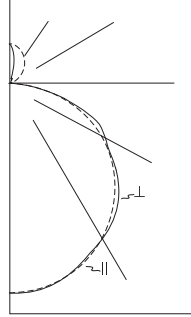

Coefficients of Utilization

rc	Effective floor cavity reflectance									
	80%			50%			30%			
	70	50	30	10	50	30	10	50	30	10
RCR										
0	109	109	109	109	100	100	100	95	95	95
1	99	94	90	87	87	84	81	82	80	78
2	90	82	75	70	75	70	66	72	67	64
3	81	71	64	57	66	60	55	63	57	53
4	74	63	54	48	58	52	46	55	50	45
5	68	56	47	41	52	45	40	50	44	39
6	63	50	42	36	47	40	35	45	39	34
7	58	45	37	31	42	35	30	41	34	30
8	54	41	33	28	39	32	27	37	31	27
9	50	38	30	25	36	29	24	34	28	24
10	47	35	27	22	33	26	22	32	26	22

HBI-654T5-W-UNV-EHT2-UPL
Electronic Ballasts
(6) F54T5 54W lamps 4400 lumens
Spacing criterion: (H) 1.3 x mounting height, (L) 1.3 x mounting height
Efficiency 92.6%
Test Report: HBI654T5WUPL.IES

Zonal Lumen Summary

Zone	Lumens	%Lamp	%Fixture
0-30	5773	21.9	23.6
0-40	9557	36.2	39.1
0-60	17462	66.1	71.4
0-90	23082	87.4	94.4
0-180	24447	92.6	100.0

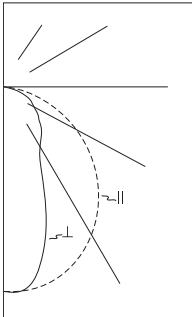

Coefficients of Utilization

rc	Effective floor cavity reflectance									
	80%			50%			30%			
	70	50	30	10	50	30	10	50	30	10
RCR										
0	109	109	109	109	102	102	102	98	98	98
1	101	98	94	91	92	89	87	88	86	84
2	93	87	81	77	82	78	74	79	75	72
3	86	77	71	65	73	68	64	71	66	63
4	80	70	62	57	66	60	56	64	59	55
5	74	63	56	50	60	54	49	59	53	49
6	69	58	50	45	55	49	44	54	48	44
7	64	53	46	40	51	45	40	50	44	40
8	60	49	42	37	47	41	36	46	40	36
9	57	45	38	34	44	38	33	43	37	33
10	53	42	35	31	41	35	31	40	35	31

HBI-454T5-N-UNV-EHT1
Electronic Ballasts
(4) F54T5HO 54W lamps 4400 lumens
Spacing criterion: (H) 1.3 x mounting height, (L) 0.7 x mounting height
Efficiency 91.8%
Test Report: HB454T5.IES

Zonal Lumen Summary

Zone	Lumens	%Lamp	%Fixture
0-30	6296	35.8	39.0
0-40	9157	52.0	56.7
0-60	13793	78.4	85.3
0-90	16163	91.8	94.2
0-180	16163	91.8	100.0

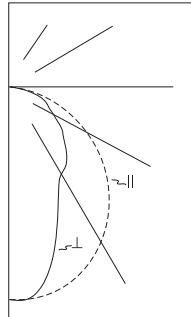

Coefficients of Utilization

rc	Effective floor cavity reflectance									
	80%			50%			30%			
	70	50	30	10	50	30	10	50	30	10
RCR										
0	113	113	113	113	105	105	105	101	101	101
1	104	100	96	93	94	91	88	90	88	85
2	95	88	82	77	83	78	74	80	76	72
3	87	78	70	65	74	68	63	71	66	62
4	80	70	62	56	66	60	54	64	58	54
5	74	63	55	49	60	53	48	58	52	47
6	69	57	49	43	54	48	42	53	47	42
7	64	52	44	38	50	43	38	48	42	38
8	60	48	40	35	46	39	34	45	39	34
9	56	44	37	32	42	36	31	41	36	31
10	53	41	34	29	40	33	29	39	33	29

HBI-554T5-N-UNV-EHT2
Electronic Ballasts
(5) F54T5HO 54W lamps 4400 lumens
Spacing criterion: (H) 1.3 x mounting height, (L) 0.8 x mounting height
Efficiency 94.8%
Test Report: HB554T5.IES

Zonal Lumen Summary

Zone	Lumens	%Lamp	%Fixture
0-30	7063	32.1	33.9
0-40	10703	48.6	51.3
0-60	17136	77.9	82.2
0-90	20859	94.8	100.0
0-180	20859	94.8	100.0

Illuminance Estimator

Illuminance Levels (FC) & Watts Per Sq. Ft. (LPD)

Based on 100 ft. x 100 ft. Open Room

HBI654T5UPL

Mounting Height	Spacing on Center	15 ft			20 ft			25 ft			30 ft		
		Qty	FC	LPD	Qty	FC	LPD	Qty	FC	LPD	Qty	FC	LPD
		20 ft	49	83.0	1.76	25	42.4	0.90	16	27.2	0.57	12	20.4
25 ft	49	77.0	1.76	25	39.4	0.90	16	25.2	0.57	12	18.9	0.43	
30 ft	49	72.0	1.76	25	36.7	0.90	16	23.5	0.57	12	17.6	0.43	

Choose the spacing and mounting height to determine the average footcandle and watts per square foot values. All the calculations are based on the published IESNA Zonal Cavity Method and associated algorithms. Results are calculated from manufacturer photometric files.

System Performance Table

HBI System Comparison	No. of Lamps	Lamp Lumens	Lumen Maintenance ¹	Fixture Efficiency	Ballast Factor	Design System Lumens ²	S/P Ratio ³	Brightness Perception	S/P Adjusted Lumens ⁴	Wattage	Cost of 1000 S/P Adj Lumens - 4000 hrs @ 0.08 kWh	LER ⁵
HBI-454T5-N-UNV-EHT1-U	4	5000	94%	92%	1.00	17258	1.90	1.38	23789	240	\$3.52	99
HBI-554T5-N-UNV-EHT1-U	5	5000	93%	92%	1.00	21344	1.90	1.38	29420	302	\$2.62	97
HBI-654T5-N-UNV-EHT2-UPL-U	6	5000	93%	93%	1.00	26059	1.90	1.38	35919	360	\$3.43	100
Comparison System												
250W Metal Halide High Bay	1	23000	75%	78%	1.00	15000	1.50	1.22	18371	295	\$6.59	49
250W High Pressure Sodium High Bay	1	30000	81%	78%	1.00	18978	0.62	0.79	14944	300	\$8.23	39
400W Metal Halide High Bay	1	36000	75%	78%	1.00	21087	1.50	1.22	25826	455	\$7.22	44
400W High Pressure Sodium High Bay	1	50000	81%	78%	1.00	31631	0.62	0.79	24906	464	\$7.63	42

FOOTNOTES: ¹ Lumen maintenance is based on lamp manufacturer's stated data combined with estimated dirt depreciation. ² Design System Lumens is the fixture lumens at 40% of rated lamp life and is calculated as Quantity of Lamps x Lamp Lumens x Lumen Maintenance x Fixture Efficiency x Ballast Factor. ³ S/P Ratio is the lamp manufacturers stated Scotopic/Photopic Ratio; accepted by some lighting designers to adjust for the relative strengths of scotopic and photopic vision, not yet adopted by IESNA. ⁴ S/P Adjusted Lumens calculates the brightness perception scotopic/photopic ratio as Design System Lumens x (S/P)^{0.5} based on 5000K lamps. ⁵ LER (Luminaire Efficiency Ratio) is an accepted method of comparing fixture performance.

HBE HIGH-BAY EFFICIENCY LUMINAIRE



Electrostatically applied baked white enamel finish is preceded by a multistage cleaning cycle, iron phosphate coating with rust inhibitor.

Optional uplight apertures (approximately 7% uplight)

Includes V Hangers for rapid installation!

Standard side rails and stiffening brackets provide increased structural rigidity.

Factory installed code compliant disconnect for safe and convenient means of disconnecting power.

LINEAR DISCONNECT

Cooper Lighting's modular power receptacle meets UL2459 and NEC 410.73 and is UL/cUL rated for make and break under load from outside the luminaire to speed maintenance.



Thermally optimized F-Bay is suitable for environments up to 149°F (66°C) when used with high temperature environment ballasts. T5 or T8 systems are warranted for ambient environments up to 149°F (65°C) for three years and 131°F (55°C) for five years in open uplight configurations.



Modular F-Bay Power Supply

Cooper Lighting's F-Bay Modular Power Supply allows external fixture access for safe and easy servicing. There is no need to remove lamps or reflectors to disconnect fixture power with F-Bay Modular Power Supply. Access to the individual fixture's power supply allows servicing without turning off all the fixtures disrupting occupants. F-Bay Modular Power Supply is a time saver in installation – **simply plug & power.**



1. Modular Power Supply Receptacle supplied mounted into fixture Access Plate

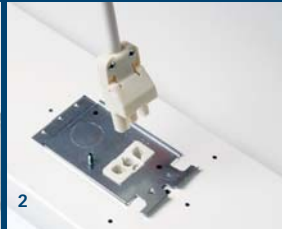

2. Modular Power Cord & Plugs in 120, 277, 347, & 480V configurations for easy plug & power into existing supply



No internal fixture access required for installation or disconnecting power



Modular Motion Sensor Option supplied with Mounting Box and Modular Power Supply Receptacle

Code Compliance

- UL/cUL Certified for Make/Break under load (UL2549)
- Meets NEC requirements for ballast disconnect (NEC 410.73G)
- Allows for addition of Occupancy Sensor without hard connections
- Receptacles complete with insulating/dust cap

Shielding Options



Mounting Accessories



Thermal Optimization

To optimize luminaire performance, HBE series offers a variety of lamp and shielding options. Use the Thermal Optimization chart to determine the options that are appropriate for the ambient environments in which they will be installed.

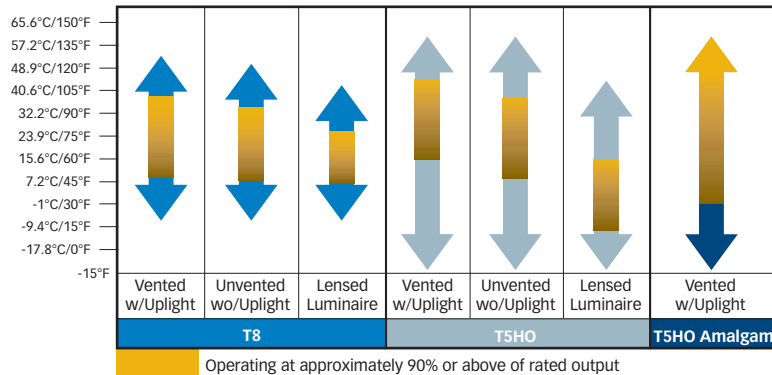

System Performance

HBE

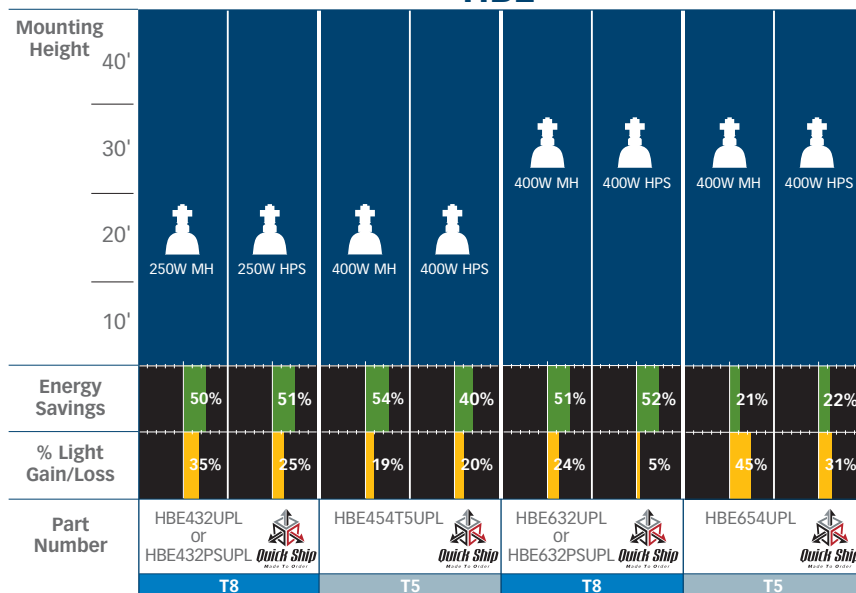

% light gain/light loss utilize S/P adjusted lumens.



HBE T8 HIGH-BAY EFFICIENCY LUMINAIRE

Ordering Information Sample Number: HBE-632-N-UNV-L8850-EB82/PLUS-U

Includes V Hangers for rapid installation ⁽⁵⁾

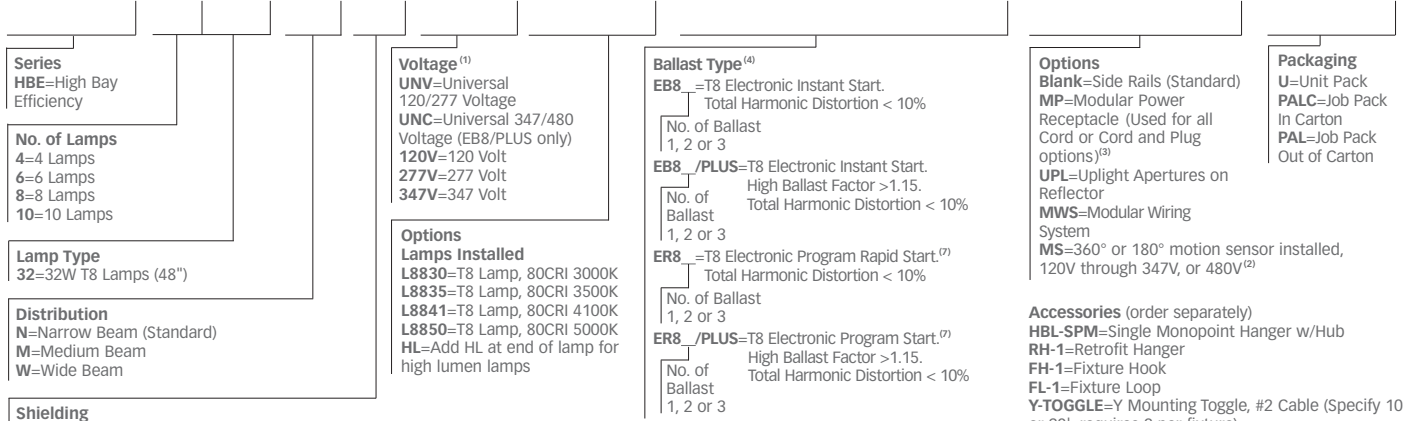

NOTES: ⁽¹⁾Voltage must be specified when ordered with plugs, motion sensor or emergency ballasts. ⁽²⁾When ordering MS option, specify as UNV (for 120 or 277V), 347 or 480V. ⁽³⁾Requires use of MC_ or MPC_ cord accessories, specify voltage for plugs. ⁽⁴⁾T8 ballast systems suitable for operation in ambient environments up to 131°F (55°C) in open upright configuration. ⁽⁵⁾Can be used in high abuse applications such as gymnasiums.

Accessories (order separately)
HBL-SPM=Single Monopoint Hanger w/Hub
RH-1=Retrofit Hanger
FH-1=Fixture Hook
FL-1=Fixture Loop
Y-TOGGLE=Y Mounting Toggle, #2 Cable (Specify 10' or 30', requires 2 per fixture)
HBAYC-CHAIN/SET/U=(2) V-Hook Hangers, 36" Chain Sets w/S-Hooks
MC3=3' Modular Power Cord
MPC3=3' Modular Power Cord & Plug (Specify Voltage)
MC6=6' Modular Power Cord
MPC6=6' Modular Power Cord & Plug (Specify Voltage)
MMS=360° or 180° Aisle Motion Sensor with Modular Power Receptacle (120-277V)⁽³⁾
WG/HBL6-4FT-B=4/6 Lamp Wireguard w/Clips
WG/HBL8-4FT-B=8 Lamp Wireguard w/Clips



Quick Ship Ordering Information Sample Number: HBE632-UPL-L5

Quick Ship orders ship in 5 days in order quantities not to exceed 200 pieces.

NOTE: Orders received after noon are entered on the following day.

Includes V Hangers for rapid installation ⁽⁵⁾

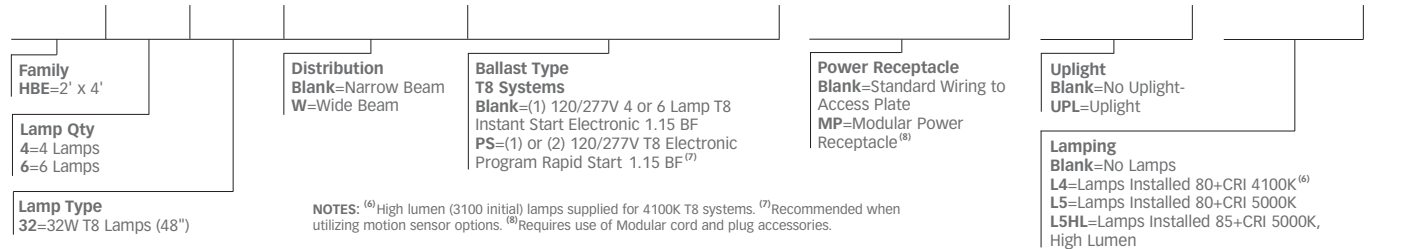

NOTES: ⁽⁶⁾High lumen (3100 initial) lamps supplied for 4100K T8 systems. ⁽⁷⁾Recommended when utilizing motion sensor options. ⁽⁸⁾Requires use of Modular cord and plug accessories.

Dimensions

HBE T8 Lamp Configurations

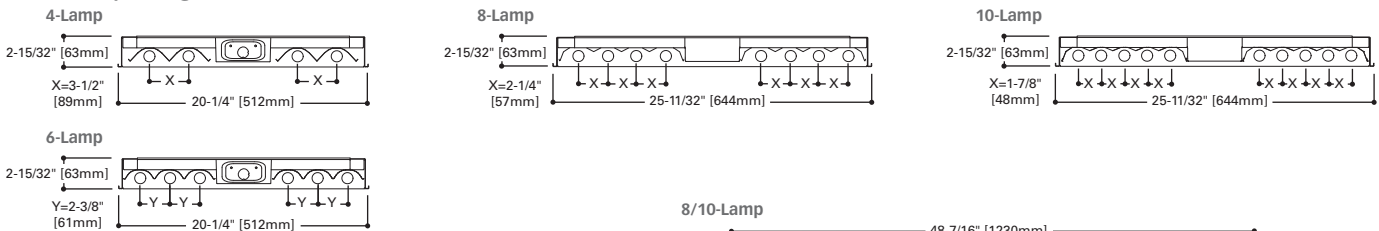

Dimensions for Top View

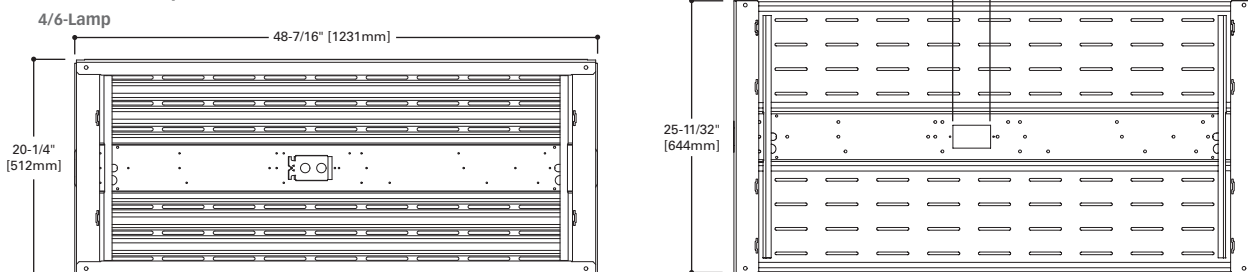

Photometrics

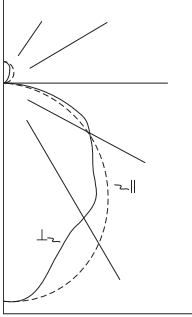

HBE-632-N-UNV-EB82-UPL
Electronic Ballasts
(6) 32W T8 lamps 3100 lumens
Spacing criterion: (H) 1.3 x mounting height, (L) 1.1 x mounting height
Efficiency 97.4%
Test Report: HBE632-UPL.IES

Coefficients of Utilization

rc	Effective floor cavity reflectance						20%					
	80%			50%			30%					
	70	50	30	10	50	30	10	50	30	10		
RCR												
0	115	115	115	115	105	105	105	99	99	99		
1	104	99	95	91	91	88	85	86	84	81		
2	94	86	79	73	79	74	69	75	71	67		
3	86	75	67	60	69	63	58	66	60	56		
4	78	66	58	51	61	54	49	58	52	48		
5	72	59	50	44	55	48	42	52	46	41		
6	66	53	44	38	50	42	37	47	41	36		
7	62	48	40	34	45	38	33	43	37	32		
8	57	44	36	30	41	34	29	40	33	29		
9	54	40	32	27	38	31	26	37	30	26		
10	50	37	30	24	35	29	24	34	28	24		

Zonal Lumen Summary

Zone	Lumens	%Lamp	%Fixture
0-30	4530	24.4	25.0
0-40	7287	39.2	40.2
0-60	12794	68.8	70.6
0-90	17016	91.5	93.9
0-180	18116	97.4	100.0

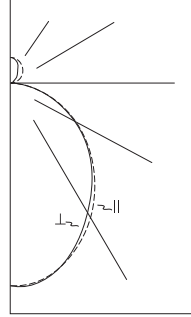

HBE-632-N-A-UNV-EB82
Electronic Ballasts
(6) 32W T8 lamps 3100 lumens
Spacing criterion: (H) 1.2 x mounting height, (L) 1.1 x mounting height
Efficiency 76.7%
Test Report: HBE632-A.IES

Coefficients of Utilization

rc	Effective floor cavity reflectance						20%				
	80%			50%			30%				
	70	50	30	10	50	30	10	50	30	10	
RCR											
0	90	90	90	90	81	81	81	76	76	76	
1	82	79	75	73	72	69	67	67	66	64	
2	75	69	64	59	63	59	56	59	56	54	
3	68	61	55	50	56	51	47	53	49	45	
4	63	54	47	42	50	44	40	47	43	39	
5	58	48	41	37	44	39	35	42	38	34	
6	53	43	37	32	40	35	31	38	34	30	
7	49	39	33	28	37	31	27	35	30	27	
8	46	36	30	25	34	28	24	32	27	24	
9	43	33	27	23	31	26	22	30	25	22	
10	40	31	25	21	29	24	20	28	23	20	

Zonal Lumen Summary

Zone	Lumens	%Lamp	%Fixture
0-30	3859	20.7	27.1
0-40	6144	33.0	43.1
0-60	10444	56.2	73.2
0-90	12958	69.7	90.8
0-180	14263	76.7	100.0

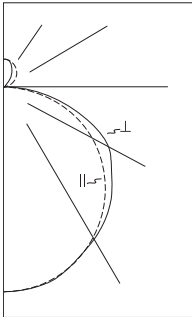

HBE-432-W-UPL
Electronic Ballast
(4) 32W T8 lamps 2850 lumens
Spacing criterion: (H) 1.3 x mounting height, (L) 1.3 x mounting height
Efficiency 90.7%
Test Report: HBE432W-UPL.IES

Coefficients of Utilization

rc	Effective floor cavity reflectance						20%				
	80%			50%			30%				
	70	50	30	10	50	30	10	50	30	10	
RCR											
0	107	107	107	107	97	97	97	92	92	92	
1	96	92	88	84	84	81	78	80	77	75	
2	87	79	73	67	73	68	64	69	65	61	
3	79	69	61	55	64	58	53	60	55	51	
4	72	61	53	46	56	50	44	53	48	43	
5	66	54	46	40	50	43	38	48	42	37	
6	61	49	40	34	45	38	33	43	37	32	
7	56	44	36	30	41	34	29	39	33	28	
8	52	40	32	27	37	31	26	36	30	25	
9	49	37	29	24	34	28	23	33	27	23	
10	46	34	26	22	32	25	21	30	25	21	

Zonal Lumen Summary

Zone	Lumens	%Lamp	%Fixture
0-30	2360	20.7	22.8
0-40	3902	34.2	37.8
0-60	7150	62.7	69.2
0-90	9629	84.5	93.2
0-180	10337	90.7	100.0

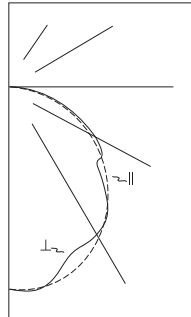

HBE-1032-N-UNV-EB83-U
Electronic Ballasts
(10) 32W T8 lamps 3100 lumens
Spacing criterion: (H) 1.3 x mounting height, (L) 1.3 x mounting height
Efficiency 91.2%
Test Report: HBE1032.IES

Coefficients of Utilization

rc	Effective floor cavity reflectance						20%				
	80%			50%			30%				
	70	50	30	10	50	30	10	50	30	10	
RCR											
0	109	109	109	109	101	101	101	97	97	97	
1	99	94	90	87	88	85	83	85	82	80	
2	90	82	75	70	77	72	68	74	70	66	
3	82	72	64	58	68	61	56	65	60	55	
4	75	63	55	49	60	53	48	58	52	47	
5	69	57	48	42	54	47	41	52	46	41	
6	63	51	43	37	48	41	36	47	41	36	
7	59	46	38	32	44	37	32	43	36	32	
8	55	42	34	29	40	33	29	39	33	28	
9	51	39	31	26	37	30	26	36	30	26	
10	48	36	28	23	34	28	23	33	27	23	

Zonal Lumen Summary

Zone	Lumens	%Lamp	%Fixture
0-30	7505	24.2	26.5
0-40	12316	39.7	43.5
0-60	21774	70.2	77.0
0-90	28283	91.2	100.0
0-180	28283	91.2	100.0

Illuminance Estimator

Illuminance Levels (FC) & Watts Per Sq. Ft. (LPD)

HBE632NUPL

Based on 100 ft. x 100 ft. Open Room

Mounting Height	Spacing on Center	15 ft			20 ft			25 ft			30 ft		
		Qty	FC	LPD	Qty	FC	LPD	Qty	FC	LPD	Qty	FC	LPD
	20 ft	49	69.0	1.08	25	35.1	0.55	16	22.5	0.35	12	16.8	0.26
25 ft	49	63.0	1.08	25	32.3	0.55	16	20.7	0.35	12	15.5	0.26	
30 ft	49	59.0	1.08	25	29.9	0.55	16	19.1	0.35	12	14.3	0.26	

Choose the spacing and mounting height to determine the average footcandle and watts per square foot values. All the calculations are based on the published IESNA Zonal Cavity Method and associated algorithms. Results are calculated from manufacturer photometric files.

System Performance Table

HBE System Comparison	No. of Lamps	Lamp Lumens	Lumen Maintenance ¹	Fixture Efficiency	Ballast Factor	Design System Lumens ²	S/P Ratio ³	Brightness Perception	S/P Adjusted Lumens ⁴	Wattage	Cost of 1000 S/P Adj Lumens - 4000 hrs @ 0.08 kWh	LER ⁵
HBE-632-N-UNV-EB82/PLUS-UPL-U	6	3100	94%	97%	1.18	20095	1.72	1.31	26354	222	\$3.35	119
HBE-832-N-UNV-EB82-UPL-U	8	3100	94%	90%	1.18	24730	1.90	1.38	34088	370	\$3.27	92
Comparison System												
400W Metal Halide High Bay	1	36000	75%	78%	1	21087	1.50	1.22	25826	455	\$7.22	44
400W High Pressure Sodium High Bay	1	50000	81%	78%	1	31631	0.62	0.79	24906	464	\$7.63	42

FOOTNOTES: ¹ Lumen maintenance is based on lamp manufacturer's stated data combined with estimated dirt depreciation. ² Design System Lumens is the fixture lumens at 40% of rated lamp life and is calculated as Quantity of Lamps x Lamp Lumens x Lumen Maintenance x Fixture Efficiency x Ballast Factor. ³ S/P Ratio is the lamp manufacturers stated Scotopic/Photopic Ratio; accepted by some lighting designers to adjust for the relative strengths of scotopic and photopic vision, not yet adopted by IESNA. ⁴ S/P Adjusted Lumens calculates the brightness perception scotopic/photopic ratio as Design System Lumens x (S/P)^{0.5} based on 5000K lamps. ⁵ LER (Luminaire Efficiency Ratio) is an accepted method of comparing fixture performance.



HBE T5 HIGH-BAY EFFICIENCY LUMINAIRE

Ordering Information Sample Number: HBE-654T5-N-UNV-L5850-EBT2-U

Includes V Hangers for rapid installation⁽⁴⁾

<p>Series HBE=High Bay Efficiency</p>	<p>Voltage⁽¹⁾ UNV=Universal 120/277 Voltage UNC=Universal 347/480 Voltage 120V=120 Volt 277V=277 Volt 347V=347 Volt</p>	<p>Ballast Type EBT =T5HO Linear Electronic Program Start Total Harmonic Distortion < 10% No. of Ballast 1, 2 or 3 EHT =T5HO Linear Electronic Program Start High Ambient. Total Harmonic Distortion < 10% No. of Ballast 1, 2 or 3</p>	<p>Options Blank=Side Rails (Standard) MP=Modular Power Receptacle (Used for all Cord or Cord and Plug options)⁽³⁾ UPL=Uplight Apertures on Reflector MWS=Modular Wiring System MS=360° or 180° motion sensor installed, 120V through 347V, or 480V⁽²⁾</p>	<p>Packaging U=Unit Pack PALC=Job Pack In Carton PAL=Job Pack Out of Carton</p>
<p>No. of Lamps 4=4 Lamps 6=6 Lamps 8=8 Lamps⁽⁶⁾ 10=10 Lamps⁽⁶⁾</p>	<p>Lamp Type 49T5=49W T5HO Lamps (48") 51T5=51W T5HO Lamps (48") 54T5=54W T5HO Lamps (48")</p>	<p>Options Lamps Installed L5830=T5 Lamp, 80CRI 3000K L5835=T5 Lamp, 80CRI 3500K L5841=T5 Lamp, 80CRI 4100K L5850=T5 Lamp, 80CRI 5000K</p>	<p>Accessories (order separately) HBL-SPM=Single Monopoint Hanger w/Hub RH-1=Retrofit Hanger FH-1=Fixture Hook FL-1=Fixture Loop Y-TOGGLE=Y Mounting Toggle, #2 Cable (Specify 10' or 30', requires 2 per fixture) HBAY-CHAIN/SET/U=(2) V-Hook Hangers, 36" Chain Sets w/S-Hooks MC3=3' Modular Power Cord MPC3=3' Modular Power Cord & Plug (Specify Voltage) MC6=6' Modular Power Cord MPC6=6' Modular Power Cord & Plug (Specify Voltage) MMS=360° or 180° Aisle Motion Sensor with Modular Power Receptacle (120-277V)⁽²⁾ WG/HBL4-4FT-B=4/6 Lamp Wireguard w/Clips WG/HBL8-4FT-B=8 Lamp Wireguard w/Clips</p>	
<p>Distribution N=Narrow Beam (Standard) M=Medium Beam W=Wide Beam</p>	<p>Shielding⁽⁶⁾ Blank=None A=Prismatic Acrylic Lens & Doorframe WG=Wireguard & Doorframe CL=Clear Acrylic Lens & Doorframe A/WG=Acrylic Lens, Wireguard & Doorframe CL/WG=Clear Lens, Wireguard & Doorframe</p>	<p>NOTES: ⁽¹⁾Voltage must be specified when ordered with plugs or emergency ballasts. ⁽²⁾When ordering MS option, specify as UNV (for 120 or 277V), 347 or 480V. ⁽³⁾Requires use of MC_ or MPC_ cord accessories, specify voltage for plugs. ⁽⁴⁾Can be used in high abuse applications such as gymnasiums. ⁽⁵⁾EHT/HT5/HCT5 ballast systems suitable for ambient environments not to exceed 149°F (65°C) in open upright configurations and less lens option. ⁽⁶⁾EHT ballast recommended when using lens option on 8 or 10 lamp configurations.</p>		



Quick Ship Ordering Information Sample Number: HBE654T5-UPL-L5

Quick Ship orders ship in 5 days in order quantities not to exceed 200 pieces.

Includes V Hangers for rapid installation⁽⁴⁾

NOTE: Orders received after noon are entered on the following day.

<p>Family HBE</p>	<p>Lamp Type 51=51W T5HO Lamps (48") 54=54W T5HO Lamps (48")</p>	<p>Ballast Type T5HO Systems HT5=(1) or (2) 120/277V T5HO High Ambient Electronic Program Rapid Start</p>	<p>Power Receptacle Blank=Standard Wiring to Access Plate MP=Modular Power Receptacle⁽⁷⁾</p>	<p>Lamping Blank=No Lamps L4=Lamps Installed 80+CRI 4100K⁽⁸⁾ L5=Lamps Installed 80+CRI 5000K⁽⁸⁾ L5ES=Energy Savings Lamps Installed 80+CRI 5000K</p>
<p>Lamp Qty 4=4 Lamps 6=6 Lamps</p>	<p>Distribution Blank=Narrow Beam W=Wide Beam</p>		<p>Uplight Blank=No Uplight UPL=Uplight</p>	

NOTES: ⁽⁷⁾Requires use of Modular cord and plug accessories. ⁽⁸⁾For Quick Ship, lamping option only available w/54W lamp type.

Dimensions

HBE T5 Lamp Configurations

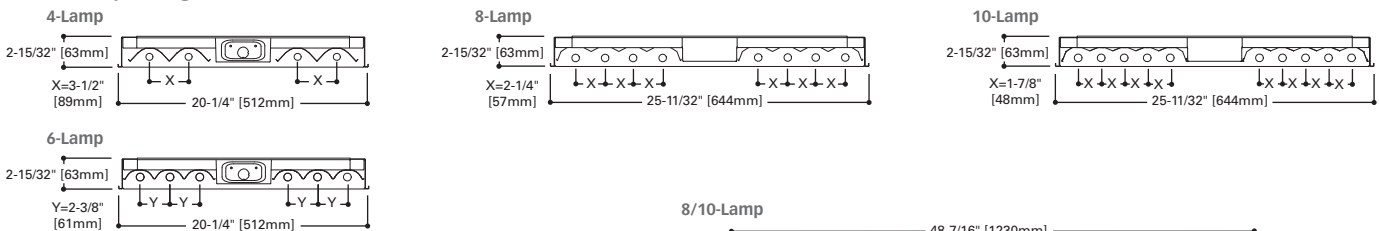

Dimensions for Top View

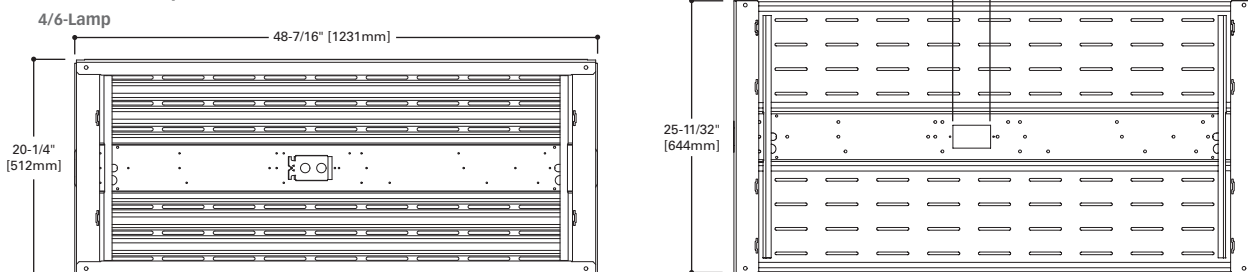

Photometrics

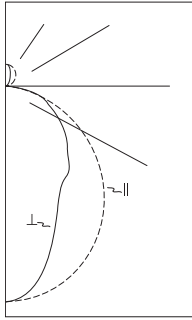

HBE-654-N-UPL
Electronic Ballasts
(6) F54T5 54W lamps 4400 lumens
Spacing criterion: (II) 1.2 x mounting height, (L) 0.8 x mounting height
Efficiency 94.5%
Test Report: HBE654-UPL.IES

Coefficients of Utilization

rc	Effective floor cavity reflectance 20%									
	80%		50%		30%					
rw	70	50	30	10	50	30	10			
RCR										
0	111	111	111	111	102	102	102	96	96	96
1	102	98	94	90	90	87	84	85	83	81
2	93	86	79	74	79	74	70	75	71	68
3	85	76	68	62	70	64	60	67	62	58
4	78	67	59	53	63	56	51	60	54	50
5	72	60	52	46	56	50	45	54	48	44
6	67	55	47	41	51	45	40	49	43	39
7	62	50	42	36	47	40	35	45	39	35
8	58	46	38	33	43	37	32	42	36	31
9	54	42	35	30	40	33	29	38	33	29
10	51	39	32	27	37	31	26	36	30	26

Zonal Lumen Summary

Zone	Lumens	%Lamp	%Fixture
0-30	7486	28.4	30.0
0-40	11514	43.6	46.2
0-60	18847	71.4	75.6
0-90	23419	88.7	93.9
0-180	24939	94.5	100.0

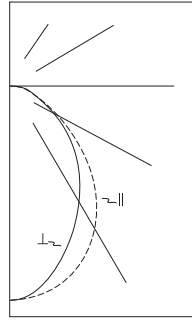

HBE-654-N-A
Electronic Ballasts
(6) F54T5 54W lamps 4400 lumens
Spacing criterion: (II) 1.2 x mounting height, (L) 1.0 x mounting height
Efficiency 67.7%
Test Report: HBE654-A.IES

Coefficients of Utilization

rc	Effective floor cavity reflectance 20%									
	80%		50%		30%					
rw	70	50	30	10	50	30	10			
RCR										
0	81	81	81	81	76	76	76	72	72	72
1	74	72	69	67	67	65	63	65	63	62
2	69	64	59	56	60	57	54	58	55	53
3	63	57	52	48	54	50	47	52	49	46
4	58	51	46	41	48	44	41	47	43	40
5	54	46	40	36	44	39	36	43	39	35
6	50	42	36	32	40	35	32	39	35	32
7	47	38	33	29	37	32	29	36	32	28
8	44	35	30	26	34	29	26	33	29	26
9	41	33	27	24	31	27	24	31	27	24
10	39	30	25	22	29	25	22	29	24	22

Zonal Lumen Summary

Zone	Lumens	%Lamp	%Fixture
0-30	6405	24.3	35.8
0-40	9927	37.6	55.5
0-60	15395	58.3	86.1
0-90	17869	67.7	100.0
0-180	17872	67.7	100.0

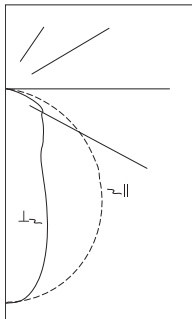

HBE-454-N
Electronic Ballasts
(4) F54T5 54W lamps 4400 lumens
Spacing criterion: (II) 1.2 x mounting height, (L) 0.7 x mounting height
Efficiency 96.0%
Test Report: HBE454.IES

Coefficients of Utilization

rc	Effective floor cavity reflectance 20%									
	80%		50%		30%					
rw	70	50	30	10	50	30	10			
RCR										
0	114	114	114	114	107	107	107	102	102	102
1	106	102	98	95	96	93	91	92	90	88
2	97	90	85	80	85	81	77	82	78	75
3	90	81	74	68	76	71	66	74	69	65
4	83	73	65	59	69	63	58	67	61	57
5	77	66	58	52	63	56	51	61	55	51
6	72	60	52	46	57	51	46	56	50	45
7	67	55	47	42	53	46	41	52	46	41
8	63	51	43	38	49	42	38	48	42	37
9	59	47	40	35	45	39	35	44	39	34
10	56	44	37	32	42	36	32	42	36	32

Zonal Lumen Summary

Zone	Lumens	%Lamp	%Fixture
0-30	6494	36.9	38.4
0-40	9416	53.5	55.7
0-60	14260	81.0	84.4
0-90	16891	96.0	100.0
0-180	16891	96.0	100.0

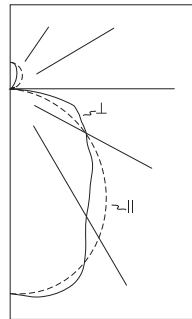

HBE-854T5N-UNV-UPL
Electronic Ballasts
(8) F54T5 54W lamps 4400 lumens
Spacing criterion: (II) 1.3 x mounting height, (L) 1.1 x mounting height
Efficiency 94.0%
Test Report: HBE854-UPL.IES

Coefficients of Utilization

rc	Effective floor cavity reflectance 20%									
	80%		50%		30%					
rw	70	50	30	10	50	30	10			
RCR										
0	110	110	110	110	101	101	101	95	95	95
1	100	95	91	87	87	84	82	83	80	78
2	91	83	76	71	76	71	67	72	68	64
3	83	73	65	59	67	61	56	64	59	54
4	76	65	56	50	60	53	48	57	51	46
5	70	58	49	43	54	47	41	51	45	40
6	65	52	44	38	48	42	36	46	40	36
7	60	47	39	33	44	37	32	42	36	32
8	56	43	35	30	41	34	29	39	33	28
9	52	40	32	27	37	31	26	36	30	26
10	49	37	29	24	35	28	24	33	27	23

Zonal Lumen Summary

Zone	Lumens	%Lamp	%Fixture
0-30	8780	24.9	26.5
0-40	13886	39.4	42.0
0-60	23440	66.6	70.8
0-90	30822	87.6	93.1
0-180	33096	94.0	100.0

Illuminance Estimator

Illuminance Levels (FC) & Watts Per Sq. Ft. (LPD)

Based on 100 ft. x 100 ft. Open Room

HBE654NUPL

Mounting Height	Spacing on Center	15 ft			20 ft			25 ft			30 ft		
		Qty	FC	LPD	Qty	FC	LPD	Qty	FC	LPD	Qty	FC	LPD
20 ft	20 ft	49	82.0	1.76	25	41.9	0.90	16	26.8	0.57	12	20.1	0.43
	25 ft	49	76.0	1.76	25	38.9	0.90	16	24.9	0.57	12	18.7	0.43
	30 ft	49	71.0	1.76	25	36.2	0.90	16	23.2	0.57	12	17.4	0.43

Choose the spacing and mounting height to determine the average footcandle and watts per square foot values. All the calculations are based on the published IESNA Zonal Cavity Method and associated algorithms. Results are calculated from manufacturer photometric files.

System Performance Table

HBE System Comparison	No. of Lamps	Lamp Lumens	Lumen Maintenance ¹	Fixture Efficiency	Ballast Factor	Design System Lumens ²	S/P Ratio ³	Brightness Perception	S/P Adjusted Lumens ⁴	Wattage	Cost of 1000 S/P Adj Lumens - 4000 hrs @ 0.08 kWh	LER ⁵
HBE-454T5-N-UNV-EBT1-U	4	5000	93%	96%	1.00	17856	1.95	1.40	24935	240	\$3.21	104
HBE-654T5-N-UNV-EBT2-UPL-U	6	5000	93%	95%	1.00	26366	1.90	1.38	36342	360	\$3.35	101
Comparison System												
250W Metal Halide High Bay	1	23000	75%	78%	1.00	15000	1.50	1.22	18371	295	\$6.59	49
250W High Pressure Sodium High Bay	1	30000	81%	78%	1.00	18978	0.62	0.79	14944	300	\$8.23	39
400W Metal Halide High Bay	1	36000	75%	78%	1.00	21087	1.50	1.22	25826	455	\$7.22	44
400W High Pressure Sodium High Bay	1	50000	81%	78%	1.00	31631	0.62	0.79	24906	464	\$7.63	42

FOOTNOTES: ¹ Lumen maintenance is based on lamp manufacturer's stated data combined with estimated dirt depreciation. ² Design System Lumens is the fixture lumens at 40% of rated lamp life and is calculated as Quantity of Lamps x Lamp Lumens x Lumen Maintenance x Fixture Efficiency x Ballast Factor. ³ S/P Ratio is the lamp manufacturer's stated Scotopic/Photopic Ratio; accepted by some lighting designers to adjust for the relative strengths of scotopic and photopic vision, not yet adopted by IESNA. ⁴ S/P Adjusted Lumens calculates the brightness perception scotopic/photopic ratio as Design System Lumens x (S/P)^{0.5} based on 5000K lamps. ⁵ LER (Luminaire Efficiency Ratio) is an accepted method of comparing fixture performance.

15/18 HIGH-BAY INDUSTRIAL LUMINAIRE



Specification grade full body housing, end plates and socket tracks are die formed 20 gauge cold rolled steel in 4' or 8' lengths.

Surface or suspension mounting (cable, chain, pendant mount or top connector box).

Optional uplight apertures (approximately 8% uplight).

Latched retention of optics (safety leader restraints) allows for easy access.

Factory installed code compliant disconnect for safe and convenient means of disconnecting power.

LINEAR DISCONNECT

Thermally optimized F-Bay is suitable for environments up to 149°F (65°C) when used with high temperature environment ballasts. T5 systems are warranted for ambient environments up to 149°F (65°C) for three years and 131°F (55°C) for five years in open uplight configurations. T8 systems are warranted for environments up to 122°F (50°C) for five years.



Optical modules are fully enclosed inside housing to protect against damage.

Narrow 11" wide housing allows mounting within 12" horizontally from the nearest edge of the sprinkler detector.

Die formed reflectors are faceted for 2, 3, 4, 6 and 8 lamp tandem configurations with two optical distributions – medium and wide. Medium beam optical modules utilize 95% specular aluminum while the wide distribution utilizes a high performance 92% reflective polyester powder coated finish.

Modular power receptacle meets UL2459 and NEC 410.73 and is UL/cUL rated for make and break under load from outside the luminaire to speed maintenance.

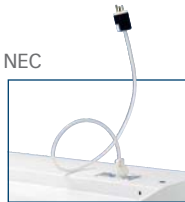

Integral occupancy sensor available and provides from 600 sq. ft. up to 1250 sq. ft. (MSO) of coverage at a maximum mounting height of 40'.



Modular F-Bay Power Supply

Cooper Lighting's F-Bay Modular Power Supply allows external fixture access for safe and easy servicing. There is no need to remove lamps or reflectors to disconnect fixture power with F-Bay Modular Power Supply. Access to the individual fixture's power supply allows servicing without turning off all the fixtures disrupting occupants. F-Bay Modular Power Supply is a time saver in installation – **simply plug & power.**



1. Modular Power Supply Receptacle supplied mounted into fixture Access Plate



2. Modular Power Cord & Plugs in 120, 277, 347, & 480V configurations for easy plug & power into existing supply



No internal fixture access required for installation or disconnecting power



Modular Motion Sensor Option supplied with Mounting Box and Modular Power Supply Receptacle

Code Compliance

- UL/cUL Certified for Make/Break under load (UL2549)
- Meets NEC requirements for ballast disconnect (NEC 410.73G)
- Allows for addition of Occupancy Sensor without hard connections
- Receptacles complete with insulating/dust cap

Shielding Options

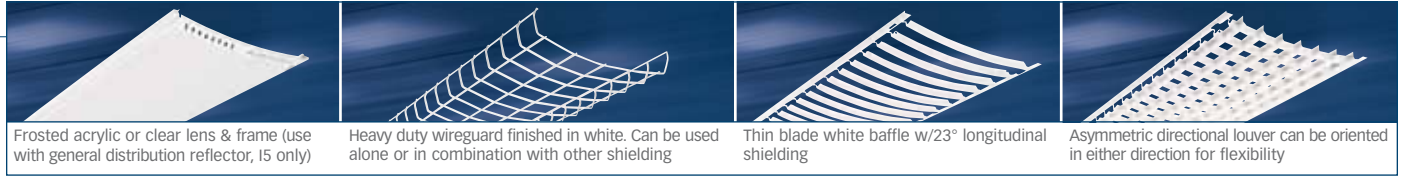

Frosted acrylic or clear lens & frame (use with general distribution reflector, I5 only) Heavy duty wireguard finished in white. Can be used alone or in combination with other shielding Thin blade white baffle w/23° longitudinal shielding Asymmetric directional louvers can be oriented in either direction for flexibility

Mounting Accessories



I5/I8 TCB=Top Connector Box (I5/I8 only) FH-1=Fixture Hook 2-1/2" (must be used with TCB) FL-1=Fixture Loop 2-1/2" (must be used with TCB) RH-1=Retrofit Hanger (must be used with TCB) AYC=Mounting Chain Set LOOP=Loop Hanger, #2 Cable TOGGLE=Single Toggle, #2 Cable

Row Mount



End plates provided with the "Quick-Tab" joining system for ease of row mounting. Blank end plates provided for row ends.

Dimensions

I5/I8 Lamp Configurations

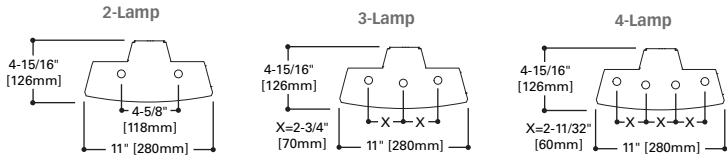

Dimensions for Top View

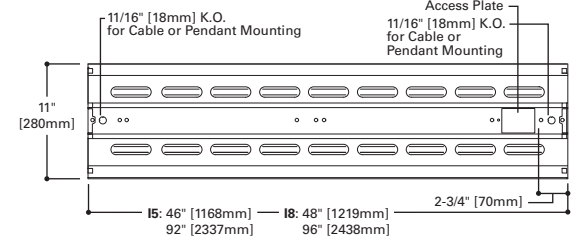

System Performance

	I5		8TI5				I8		8TI8					
Mounting Height														
40'														
30'														
20'														
10'														
Energy Savings	38%	39%	50%	52%	24%	25%	58%	58%	66%	78%	51%	51%	58%	58%
% Light Gain/Loss	36%	17%	16%	-4%	45%	31%	9%	26%	13%	-13%	15%	-14%	9%	26%
Part Number	I5355		I5455		8TI5-354T5-EBT2		8TI5-454T5-EBT3		I8-332-EB81/PLUS		I8-432-EB81/PLUS		8TI8-432-EB83/PLUS	
	T5		T5		T5		T5		T8		T8		T8	

% light gain/light loss utilize S/P adjusted lumens.

Ordering Information Sample Number: 8T15-254T5-TBW-120V-EBT1-UPL-U

<p>Length Blank=4' Length 8T=8' Length</p> <p>Series I5=T5 Industrial I8=T8 Industrial</p> <p>Mounting Arrangement Blank=Stand Alone R=Continuous Row Mount</p> <p>No. of Lamps 2=2 Lamps 3=3 Lamps 4=4 Lamps</p> <p>Lamp Type 28T5=28W T5 Std (4') Lamps 32=32W T8 (4') Lamps 49T5=49W T5HO (4') Lamps 51T5=51W T5HO (4') Lamps 54T5=54W T5HO (4') Lamps</p> <p>Distribution Optic Blank=Medium (Specular Aluminum) G=Wide (High Reflectance White)</p> <p>Shielding Options Blank=Open TBW=Thin White Baffle FL=Frosted Acrylic Lens & Frame⁽²⁾ CL=Clear Acrylic Lens & Door Frame ASY= Asymmetric Directional Louver⁽²⁾ WG=Heavy Duty Wireguard</p>	<p>Voltage⁽³⁾ UNV=Universal 120/277 Voltage UNC=Universal 347/480 Voltage⁽⁸⁾ 120V=120 Volt 277V=277 Volt 347V=347 Volt 480V=480 Volt</p> <p>Options I5 Lamps Installed L5830=T5 Lamp, 85CRI 3000K L5835=T5 Lamp, 85CRI 3500K L5841=T5 Lamp, 85CRI 4100K L5850=T5 Lamp, 85CRI 5000K I8 Lamps Installed L8830=T8 Lamp, 85CRI 3000K L8835=T8 Lamp, 85CRI 3500K L8841=T8 Lamp, 85CRI 4100K L8850=T8 Lamp, 85CRI 5000K GL=Single Element Fuse GM=Double Element Fuse EL=Emergency Installed⁽³⁾ (see table on pg. 48)</p>	<p>Ballast Type T5 Systems EBT =T5 or T5HO Linear Electronic Program Rapid Start. Total Harmonic Distortion < 10%⁽⁴⁾ No. of Ballast 1, 2 or 3 EHT =T5HO Linear Electronic Start High Ambient. Total Harmonic Distortion < 10%^{(6),(9)} No. of Ballast 1, 2 or 3 T8 Systems EB8 =T8 Electronic Instant Start.⁽⁵⁾ Total Harmonic Distortion < 10% No. of Ballast 1, 2 or 3 EB8 /PLUS= T8 Electronic Instant Start.^{(5),(8)} High Ballast Factor >1.15. Total Harmonic Distortion < 10% No. of Ballast 1, 2 or 3 ER8 =T8 Electronic Program Rapid Start.⁽⁵⁾ Total Harmonic Distortion < 10% No. of Ballast 1, 2 or 3 ER8 /PLUS=T8 Electronic Program Start. High Ballast Factor >1.15. Total Harmonic Distortion < 10% No. of Ballast 1, 2 or 3 DIM=Dimming (ballast must be specified)</p>	<p>Options NUA=No Uplight Apertures in Housing (Cannot be combined w/UPL) UPL=Uplight Apertures PI/CPI=Plug-In (1, 2 or 3). See pg. 52 TILW=Tandem Inline Wiring MWS=Modular Wiring System MS=360° or 180° Motion Sensor, 120 through 347, or 480V⁽¹²⁾ MP=Modular Power Receptacle (Used for all Cord or Cord and Plug options)⁽¹⁾ TAP=Top Access Plate⁽¹⁰⁾ TCBP=Top Connector Box Plate⁽⁷⁾</p> <p>Accessories (order separately) I5/I8-TCB-KIT-NO-PLATE-U=Top Connector Box (I5/I8 only) RH-1=Retrofit Hanger FH-1=Fixture Hook FL-1=Fixture Loop SHK=Hook w/ Safety Screw AYC-CHAIN/SET/U=(2) Hooks, 36" Chain Sets w/S-Hooks⁽¹¹⁾ TOGGLE =Single Toggle, #2 Cable (Specify 10' or 30') LOOP =Loop Hanger, #2 Cable (Specify 10' or 30') MC6=6' Modular Power Cord MPC6=6' Modular Power Cord & Plug (Specify Voltage) MMS=360° or 180° Aisle Motion Sensor with Modular Power Receptacle (120-277V)⁽¹⁾</p> <p>Door Frames (for Field Installation) I5-FRM/LENS=Frosted Acrylic Lens & Frame (I5) I8-FRM/LENS PK=Frosted Acrylic Lens & Frame (I8) I5-FRM/CL PK=Clear Acrylic Lens & Frame (I5) I8-FRM/CL PK=Clear Acrylic Lens & Frame (I8) WG/I5-4FT-B=Heavy Duty Wireguard (I5) WG/I8-4FT-B=Heavy Duty Wireguard (I8) 90800PPK=Thin White Blade Baffle (I5) BAFFLE 4FT I8=Thin White Blade Baffle (I8) 90801PPK=Asymmetrical Directional Louver (I5)</p>	<p>Packaging U=Unit Pack PAL=Palletized Out of Carton PALC=Palletized In Carton</p>
---	--	---	---	--

NOTES: ⁽¹⁾Requires use of MC_ or MPC_cord accessories, specify voltage for plugs. ⁽²⁾Use with wide distribution optic only. ⁽³⁾Voltage must be specified when ordered with plugs, motion sensor or emergency ballasts. ⁽⁴⁾EBT ballast systems suitable for operation in ambient environments up to 104°F (40°C). ⁽⁵⁾ER8 and EB8 ballast systems, suitable for operation in ambient environments up to 122°F (50°C) in open upright configurations. ⁽⁶⁾Requires use of MC_ or MPC_cord accessories, specify voltage for plugs. ⁽⁷⁾For use with Top Connector Box options. See accessories. ⁽⁸⁾2 lamp ballast configurations only in T5 UNC versions. ⁽⁹⁾3 lamp ballast configurations in EB/PLUS only for T8 UNC. ⁽¹⁰⁾EHT ballast systems suitable for ambient environments not to exceed 149°F (65°C) in open upright configurations and less lens option. ⁽¹¹⁾TAP option available with a maximum of two ballasts, including EM battery pack. ⁽¹²⁾Not for use in gymnasiums or similar recreational facilities. ⁽¹²⁾When ordering MS option, specify UNV (for 120 or 277V), 347 or 480V.

System Performance Tables

I5 System Comparison	No. of Lamps	Lamp Lumens	Lumen Maintenance ¹	Fixture Efficiency	Ballast Factor	Design System Lumens ²	S/P Ratio ³	Brightness Perception	S/P Adjusted Lumens ⁴	Wattage	Cost of 1000 S/P Adj Lmns - 4000 hrs \$0.08 kWh	LER ⁵
I5355	3	5000	93%	94%	1.00	13113	1.90	1.38	18075	182	\$3.43	99
I5455	4	5000	93%	93%	1.00	17298	1.90	1.38	23844	240	\$3.30	99
8T15355	6	5000	93%	94%	1.00	26282	1.90	1.38	36227	360	\$3.24	101
Comparison System												
250W Metal Halide High Bay	1	23000	75%	78%	1.00	15000	1.50	1.22	18371	295	\$6.59	49
250W High Pressure Sodium High Bay	1	30000	81%	78%	1.00	18978	0.62	0.79	14944	300	\$8.23	39
400W Metal Halide High Bay	1	36000	75%	78%	1.00	21087	1.50	1.22	25826	455	\$7.22	44
400W High Pressure Sodium High Bay	1	50000	81%	78%	1.00	31631	0.62	0.79	24906	464	\$7.63	42
8T15 Comparison System												
8T15-454T5	8	5000	93%	94%	1.00	35042	1.90	1.38	48303	480	\$3.22	101
Comparison System												
1000W Metal Halide High Bay	1	110000	45%	70%	1.00	36083	1.50	1.22	44192	1085	\$5.70	56

I8 System Comparison	No. of Lamps	Lamp Lumens	Lumen Maintenance ¹	Fixture Efficiency	Ballast Factor	Design System Lumens ²	S/P Ratio ³	Brightness Perception	S/P Adjusted Lumens ⁴	Wattage	Cost of 1000 S/P Adj Lmns - 4000 hrs \$0.08 kWh	LER ⁵
I8-332-EB8/PLUS	3	3100	94%	94%	1.15	9450	1.95	1.40	13196	101	\$2.27	131
I8-432-EB8/PLUS	4	3100	94%	94%	1.15	12600	1.95	1.40	17595	147	\$2.47	120
Comparison System												
250W Metal Halide High Bay	1	23000	75%	78%	1.00	15000	1.50	1.22	18371	295	\$6.59	49
250W High Pressure Sodium High Bay	1	30000	81%	78%	1.00	18978	0.62	0.79	14944	300	\$8.23	39
400W Metal Halide High Bay	1	36000	75%	78%	1.00	21087	1.50	1.22	25826	455	\$7.22	44
400W High Pressure Sodium High Bay	1	50000	81%	78%	1.00	31631	0.62	0.79	24906	464	\$7.63	42
8T18 System Comparison												
8T18-432-EB8/PLUS	8	3100	94%	94%	1.15	25200	1.95	1.40	35190	302	\$2.54	117
Comparison System												
1000W Metal Halide High Bay	1	110000	45%	70%	1.00	36083	1.50	1.22	44192	1085	\$5.70	56

FOOTNOTES: 1 Lumen maintenance is based on lamp manufacturer's stated data combined with estimated dirt depreciation. 2 Design System Lumens is the fixture lumens at 40% of rated lamp life and is calculated as Quantity of Lamps x Lamp Lumens x Lumen Maintenance x Fixture Efficiency x Ballast Factor. 3 S/P Ratio is the lamp manufacturers stated Scotopic/Photopic Ratio; accepted by some lighting designers to adjust for the relative strengths of scotopic and photopic vision, not yet adopted by IESNA. 4 S/P Adjusted Lumens calculates the brightness perception scotopic/photopic ratio as Design System Lumens x (S/P)^.0.5 5 LER (Luminaire Efficiency Ratio) is an accepted method of comparing fixture performance.

Photometrics

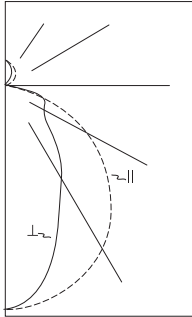

IS-454T5-UNV-EBT2-UPL
 (2) Electronic Ballasts
 (4) 54W T5 lamps 4400 lumens
 Spacing criterion: (II) 1.2 x mounting height, (L) 0.8 x mounting height
 Efficiency 92.8%
 Test Report: IS-454T5-UNV-EBT2-UPL.IES

Coefficients of Utilization

rc	Effective floor cavity reflectance											
	80%				50%				20%			
	70	50	30	10	50	30	10	50	30	10		
0	109	109	109	109	100	100	100	94	94	94		
1	101	97	94	91	90	87	85	85	83	81		
2	93	87	81	77	80	76	73	76	73	70		
3	86	78	71	66	72	67	63	69	65	61		
4	80	70	63	57	65	60	55	63	58	54		
5	73	63	55	50	59	53	48	56	51	47		
6	68	57	49	44	54	47	43	51	46	42		
7	63	52	44	39	49	43	38	47	41	37		
8	59	47	40	34	44	38	34	43	37	33		
9	54	43	35	30	40	34	30	39	33	29		
10	51	39	32	27	37	31	27	36	30	26		

Zonal Lumen Summary

Zone	Lumens	%Lamp	%Fixture
0-30	5508	31.3	33.7
0-40	8329	47.3	51.0
0-60	12731	72.3	78.0
0-90	15217	86.5	93.2
0-180	16330	92.8	100.0

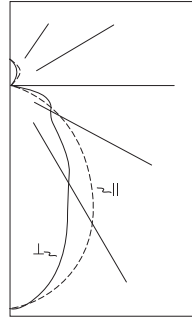

IS-454T5-TBW-UNV-EBT2-UPL
 (2) Electronic Ballasts
 (4) 54W T5 4400 lumens
 Spacing criterion: (II) 1.1 x mounting height, (L) 0.9 x mounting height
 Efficiency 81.2%
 Test Report: IS-454T5-TBW-UNV-EBT2-UPL.IES

Coefficients of Utilization

rc	Effective floor cavity reflectance											
	80%				50%				20%			
	70	50	30	10	50	30	10	50	30	10		
0	95	95	95	95	87	87	87	82	82	82		
1	88	85	82	80	78	76	74	74	72	71		
2	82	76	71	67	70	67	63	66	64	61		
3	75	68	63	58	63	59	55	60	57	54		
4	70	61	55	50	57	52	48	55	51	47		
5	64	55	49	44	52	46	42	49	45	41		
6	60	50	44	39	47	42	38	45	40	37		
7	56	46	39	35	43	38	34	41	37	33		
8	52	41	35	31	39	34	30	38	33	29		
9	48	38	31	27	36	30	26	34	29	26		
10	45	35	28	24	33	27	24	32	27	23		

Zonal Lumen Summary

Zone	Lumens	%Lamp	%Fixture
0-30	4945	28.1	34.6
0-40	7390	42.0	51.7
0-60	11071	62.9	77.5
0-90	13159	74.8	92.1
0-180	14293	81.2	100.0

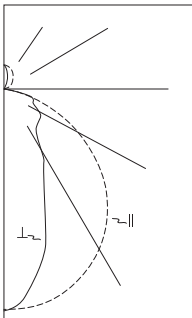

IS-354T5-UNV-EBT2-UPL
 (2) Electronic Ballasts
 (3) F54T5/HO/830K lamps 4400 lumens
 Spacing criterion: (II) 1.2 x mounting height, (L) 0.7 x mounting height
 Efficiency 98.2%
 Test Report: IS-354T5-UNV-EBT2-UPL.IES

Coefficients of Utilization

rc	Effective floor cavity reflectance											
	80%				50%				20%			
	70	50	30	10	50	30	10	50	30	10		
0	115	115	115	115	105	105	105	99	99	99		
1	107	103	100	97	95	92	90	90	88	86		
2	99	92	86	81	85	81	77	81	77	74		
3	91	83	76	70	77	71	67	73	69	65		
4	85	74	67	61	69	63	59	66	61	57		
5	78	67	59	53	63	56	51	60	55	50		
6	73	61	53	47	57	51	46	55	49	45		
7	68	55	48	42	52	46	41	50	45	40		
8	63	50	43	37	48	41	37	46	40	36		
9	58	46	38	33	44	37	33	42	36	32		
10	54	42	35	30	40	34	29	39	33	29		

Zonal Lumen Summary

Zone	Lumens	%Lamp	%Fixture
0-30	4637	35.1	35.8
0-40	6733	51.0	51.9
0-60	10058	76.2	77.6
0-90	12070	91.4	93.1
0-180	12966	98.2	100.0

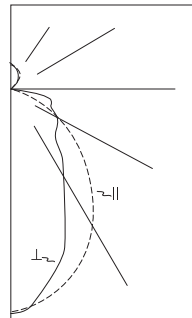

IS-354T5-TBW-UNV-EBT2-UPL
 (2) Electronic Ballasts
 (3) F54T5/HO lamps 4400 lumens
 Spacing criterion: (II) 1.0 x mounting height, (L) 0.7 x mounting height
 Efficiency 94.2%
 Test Report: IS-354T5-TBW-UNV-EBT2-UPL.IES

Coefficients of Utilization

rc	Effective floor cavity reflectance											
	80%				50%				20%			
	70	50	30	10	50	30	10	50	30	10		
0	110	110	110	110	100	100	100	94	94	94		
1	102	99	95	92	90	88	86	85	83	82		
2	95	88	83	78	81	77	74	77	74	71		
3	88	79	73	68	73	68	64	70	66	62		
4	81	71	64	59	66	61	57	63	59	55		
5	75	64	57	51	60	54	50	58	52	48		
6	70	59	51	46	55	49	44	53	47	43		
7	65	54	46	41	50	44	40	48	43	39		
8	60	49	42	37	46	40	36	44	39	35		
9	56	45	37	33	42	36	32	41	35	31		
10	53	41	34	29	39	33	29	37	32	28		

Zonal Lumen Summary

Zone	Lumens	%Lamp	%Fixture
0-30	4535	34.4	36.5
0-40	6495	49.2	52.3
0-60	9563	72.4	76.9
0-90	11373	86.2	91.5
0-180	12428	94.2	100.0

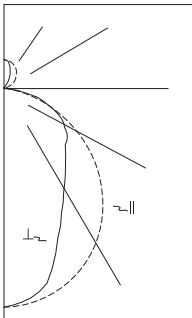

I8-332-UNV-EB81-UPL
 Electronic Ballast
 F32T8/TL835 Lamps 3000 lumens
 Spacing criterion: (II) 1.2 x mounting height, (L) 1.1 x mounting height
 Efficiency 94.1%
 Test Report: I8-332-UNV-EB81-UPL.IES

Coefficients of Utilization

rc	Effective floor cavity reflectance											
	80%				50%				20%			
	70	50	30	10	50	30	10	50	30	10		
0	110	110	110	110	100	100	100	95	95	95		
1	101	97	93	90	89	86	83	84	82	80		
2	92	85	79	74	78	74	70	74	70	67		
3	85	75	68	62	69	64	59	66	61	57		
4	78	67	59	53	62	56	51	59	54	49		
5	72	60	52	46	56	49	44	53	48	43		
6	66	54	46	41	51	44	39	48	43	38		
7	62	50	42	36	46	40	35	44	39	34		
8	58	45	38	32	43	36	32	42	35	31		
9	54	42	34	29	39	33	29	38	32	28		
10	51	39	32	27	37	30	26	35	30	26		

Zonal Lumen Summary

Zone	Lumens	%Lamp	%Fixture
0-30	2530	28.1	29.9
0-40	3885	43.2	45.9
0-60	6299	70.0	74.4
0-90	7803	86.7	92.1
0-180	8468	94.1	100.0

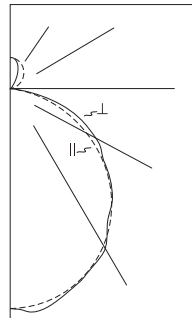

I8-432-UNV-EB81-UPL
 Electronic Ballast
 F32T8-TL835 lamps 3000 lumens
 Spacing criterion: (II) 1.2 x mounting height, (L) 1.3 x mounting height
 Efficiency 91.2%
 Test Report: I8-432-UNV-EB81-UPL.IES

Coefficients of Utilization

rc	Effective floor cavity reflectance											
	80%				50%				20%			
	70	50	30	10	50	30	10	50	30	10		
0	107	107	107	107	98	98	98	92	92	92		
1	98	94	90	87	86	83	81	81	79	77		
2	89	82	76	71	75	71	67	71	68	64		
3	81	72	65	59	66	61	56	63	58	54		
4	74	64	56	50	59	53	48	56	51	46		
5	68	57	49	43	53	46	41	50	45	40		
6	63	51	43	37	48	41	36	46	40	35		
7	59	46	39	33	43	37	32	42	36	31		
8	54	42	35	29	40	33	29	38	32	28		
9	51	39	31	26	37	30	26	35	29	25		
10	48	36	29	24	34	28	23	33	27	23		

Zonal Lumen Summary

Zone	Lumens	%Lamp	%Fixture
0-30	2861	23.8	26.1
0-40	4657	38.8	42.6
0-60	8121	67.7	74.2
0-90	10169	84.7	92.9
0-180	10943	91.2	100.0

Illuminance Estimator

Illuminance Levels (FC) & Watts Per Sq. Ft. (LPD)
 Based on 100 ft. x 100 ft. Open Room

I8432GUPL

Mounting Height	Spacing on Center	Illuminance Levels (FC) & Watts Per Sq. Ft. (LPD)											
		15 ft			20 ft			25 ft			30 ft		
		Qty	FC	LPD	Qty	FC	LPD	Qty	FC	LPD	Qty	FC	LPD
20 ft	20 ft	49	31.0	0.53	25	15.7	0.27	16	10.1	0.17	12	7.5	0.13
	25 ft	49	28.0	0.53	25	14.5	0.27	16	9.3	0.17	12	6.9	0.13
	30 ft	49	26.0	0.53	25	13.4	0.27	16	8.5	0.17	12	6.4	0.13

I5454

Illuminance Levels (FC) & Watts Per Sq. Ft. (LPD)
 Based on 100 ft. x 100 ft. Open Room

Mounting Height	Spacing on Center	Illuminance Levels (FC) & Watts Per Sq. Ft. (LPD)											
		15 ft			20 ft			25 ft			30 ft		
		Qty	FC	LPD	Qty	FC	LPD	Qty	FC	LPD	Qty	FC	LPD
20 ft	20 ft	49	51.0	1.17	25	26.2	0.60	16	16.8	0.38	12	12.6	0.28
	25 ft	49	48.0	1.17	25	24.2	0.60	16	15.6	0.38	12	11.7	0.28
	30 ft	49	45.0	1.17	25	22.8	0						

Stiffening brackets add additional strength and rigidity to channel and reflector.

Die formed reflectors are faceted for 4, 6, 8 and 10 lamp configurations with three optical distributions – narrow, medium and wide.

Optional uplight apertures (approximately 7% uplight).

Electrostatically applied baked white enamel finish is preceded by a multi-stage cleaning cycle, iron phosphate coating with rust inhibitor.

Factory installed code compliant disconnect for safe and convenient means of disconnecting power.

LINEAR DISCONNECT

Thermally optimized F-Bay is suitable for environments up to 149°F (65°C) when used with high temperature environment ballasts. T5 or T8 systems are warranted for ambient environments up to 149°F (65°C) for three years and 131°F (55°C) for five years in open uplight and downlight configurations.



Cooper Lighting's modular power receptacle meets UL2459 and NEC 410.73 and is UL/cUL rated for make and break under load from outside the luminaire to speed maintenance.



Integral occupancy sensor available and provides from 600 sq. ft. up to 1250 sq. ft. of coverage in a maximum mounting height of 40'.

Modular F-Bay Power Supply

Cooper Lighting's F-Bay Modular Power Supply allows external fixture access for safe and easy servicing. There is no need to remove lamps or reflectors to disconnect fixture power with F-Bay Modular Power Supply. Access to the individual fixture's power supply allows servicing without turning off all the fixtures disrupting occupants. F-Bay Modular Power Supply is a time saver in installation – **simply plug & power.**



1. Modular Power Supply Receptacle supplied mounted into fixture Access Plate



2. Modular Power Cord & Plugs in 120, 277, 347, & 480V configurations for easy plug & power into existing supply

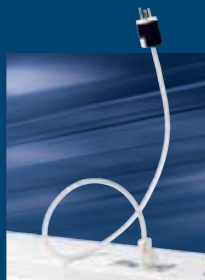

No internal fixture access required for installation or disconnecting power



Modular Motion Sensor Option supplied with Mounting Box and Modular Power Supply Receptacle

Code Compliance

- UL/cUL Certified for Make/Break under load (UL2549)
- Meets NEC requirements for ballast disconnect (NEC 410.73G)
- Allows for addition of Occupancy Sensor without hard connections
- Receptacles complete with insulating/dust cap

Mounting Accessories

HBL-SPM=Single Monopoint Hanger w/Hub (Galvanized)	FH-1=Fixture Hook 2-1/2" (must be used with HBL-SPM)	FL-1=Fixture Loop 2-1/2" (must be used with HBL-SPM)	RH-1=Retrofit Hanger (must be used with HBL-SPM)	HBAYC=New Mounting Chain Set w/V-Hook Hangers (ideal for gymnasium applications)	Y=Mounting Toggle and 10' or 25' cable

Shielding Options

Heavy duty stock wireguard (Ideal for gymnasium applications).	Wireguard swings open for easy lamp maintenance.

Thermal Optimization

To optimize luminaire performance, HBL series offers a variety of lamp and shielding options. Use the Thermal Optimization chart to determine the options that are appropriate for the ambient environments in which they will be installed.

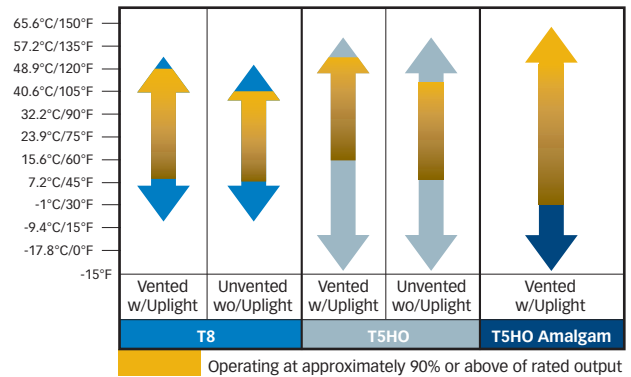

System Performance

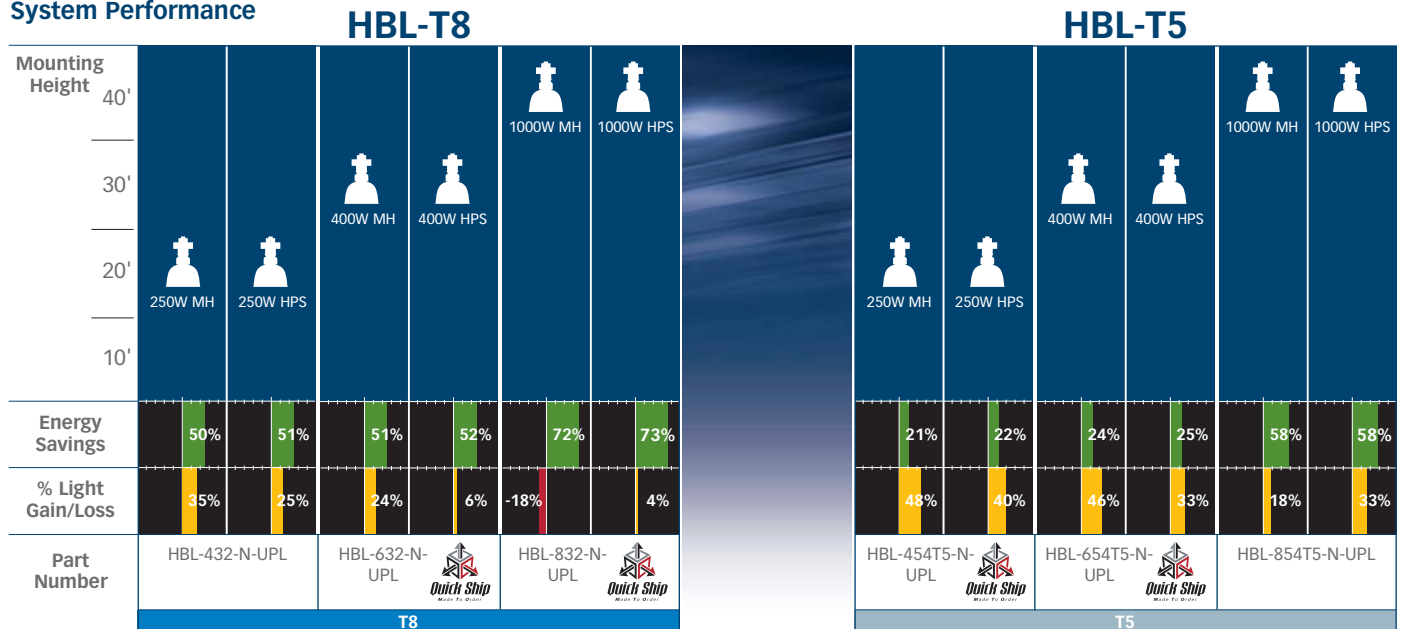

% light gain/light loss utilize S/P adjusted lumens.

HBL T8 HIGH-BAY INDUSTRIAL LUMINAIRE

Ordering Information Sample Number: HBL-632-N-UNV-EB82-UPL-U

Includes V Hangers for rapid installation⁽⁶⁾

Width Blank=20" wide 4 & 6 Lamp (nominal) 26" wide 8 & 10 Lamp (nominal)	Voltage⁽¹⁾ UNV=Universal 120/277 Voltage UNC=Universal 347/480 Voltage (EB8/PLUS only) 120V=120 Volt 277V=277 Volt 347V=347 Volt	Ballast Type⁽⁴⁾ T8 Systems EB8 =T8 Electronic Instant Start. Total Harmonic Distortion < 10% No. of Ballast 1, 2 or 3 EB8 /PLUS =T8 Electronic Instant Start. High Ballast Factor >1.15. Total Harmonic Distortion < 10% No. of Ballast 1, 2 or 3 ER8 =T8 Electronic Program Rapid Start. ⁽⁵⁾ Total Harmonic Distortion < 10% No. of Ballast 1, 2 or 3 ER8 /PLUS =T8 Electronic Program Start. ⁽⁵⁾ High Ballast Factor >1.15. Total Harmonic Distortion < 10% No. of Ballast 1, 2 or 3	Options UPL=Uplight Apertures on Reflector MP=Modular Power Receptacle (Used for all Cord or Cord and Plug options) ⁽²⁾ MWS=Modular Wiring System ⁽³⁾ MS=360° or 180° Motion Sensor installed (120V through 347V, or 480V) ⁽³⁾	Packaging U=Unit Pack PALC=Palletized In Carton
Series HBL=Linear High Bay	Options Lamps Installed L8835=T8 Lamp, 85CRI 3500K L8841=T8 Lamp, 85CRI 4100K L8850=T8 Lamp, 85CRI 5000K HL=Add HL at end of lamp for high lumen lamps, T8 only GL=Single Element Fuse GM=Double Element Fuse EL=Emergency Installed		Accessories (order separately) HBL-SPM=Single Monopoint Hanger w/Hub RH-1=Retrofit Hanger FH-1=Fixture Hook FL-1=Fixture Loop Y-TOGGLE=Y Mounting Toggle, #2 Cable (Specify 10' or 30') HBAYC-CHAIN/SET/U=(2) V-Hook Hanger, 36" Chain Sets w/S-Hooks MC3=3' Modular Power Cord MPC3=3' Modular Power Cord & Plug (Specify Voltage) MC6=6' Modular Power Cord MPC6=6' Modular Power Cord & Plug (Specify Voltage) MMS=360° or 180° Aisle Motion Sensor with Modular Power Receptacle (120-277V) ⁽²⁾ WG/HBL6-4FT-B=4/6 Lamp Wireguard w/Clips WG/HBL8-4FT-B=8 Lamp Wireguard w/Clips	
No. of Lamps 4=4 Lamps 6=6 Lamps 8=8 Lamps 10=10 Lamps				
Lamp Type 32=32W T8 Lamp (48" Long)				
Distribution N=Narrow Beam (Standard) M=Medium Beam W=Wide Beam				

NOTES: ⁽¹⁾Voltage must be specified when ordered with plugs or emergency ballasts. For MS option, indicate UNV (for 120V or 277V), 347V or 480V. ⁽²⁾Requires use of MC_ or MPC_ cord accessories, specify voltage for plugs. ⁽³⁾Cannot be combined with Modular Power Receptacle (MP). For MWS with MP, choose MP in fixture logic and then choose MWS. ⁽⁴⁾T8 ballast systems suitable for operation in ambient environments up to 131°F (55°C) in upright configuration. ⁽⁵⁾Recommended when using motion sensor options. ⁽⁶⁾Can be used in high abuse applications such as gymnasiums.



Quick Ship Ordering Information Sample Number: HBL432-MP-UPL-L5

Quick Ship orders ship in 5 days in order quantities not to exceed 200 pieces.

Includes V Hangers for rapid installation⁽⁶⁾

NOTE: Orders received after noon are entered on the following day.

Family HBL	Lamp Type 32=32W T8 Lamps (48")	Ballast Type T8 Systems⁽⁴⁾ Blank=(1) or (2) 120/277V T8 Instant Start Electronic, 1.15 BF PS=(1) or (2) 120/277V T8 Electronic Program Rapid Start, 1.15 BF ⁽⁷⁾	Power Receptacle MP=Modular Power Receptacle ⁽⁸⁾	Uplight Blank=No Uplight UPL=Uplight	Lamping Blank=No Lamps L4=Lamps Installed 85+CRI 4100K L5=Lamps Installed 85+CRI 5000K L5HL=Lamps Installed 85+CRI 5000K, High Lumen ⁽⁹⁾
No. of Lamps 4=4 Lamps 6=6 Lamps	Distribution Blank=Narrow Beam W=Wide Beam				

NOTES: ⁽⁷⁾Recommended when using motion sensor options. ⁽⁸⁾Requires use of Modular cord and plug accessories. ⁽⁹⁾L5HL (3000 initial) 5000K T8 lamps installed.

Dimensions

HBL Lamp Configurations

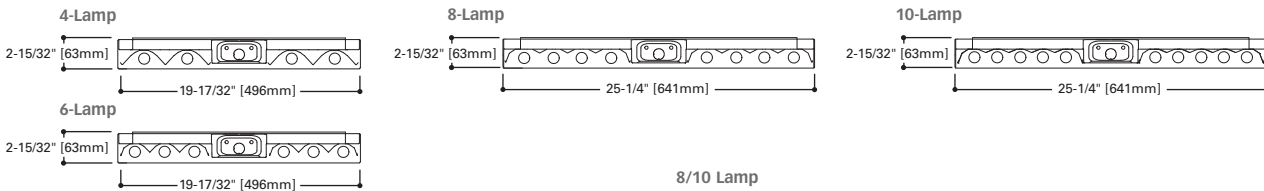

Dimensions for Top View

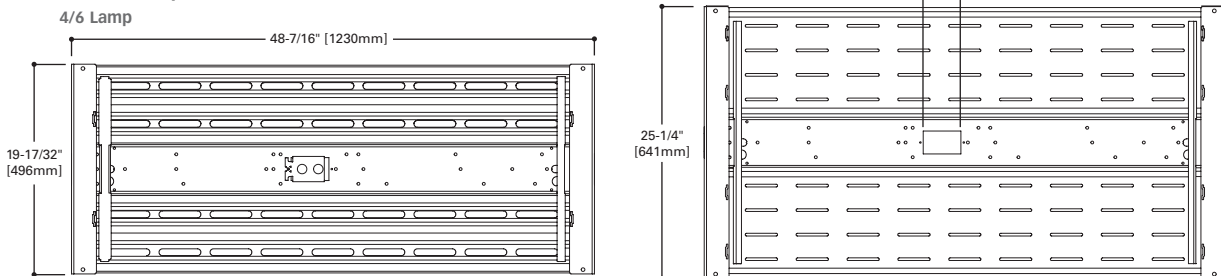

Photometrics

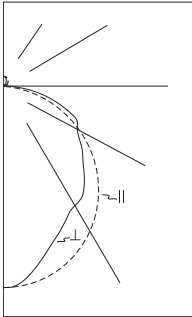

HBL-632-N-UPL
Narrow Distribution
 (2) Electronic Plus Ballasts
 (6) F32T8 32W T8 lamps 3100 lumens
 Spacing criterion: (H) 1.3 x mounting height, (L) 1.0 x mounting height
 Efficiency 95.9%
 Test Report: HBL632NUPL

Coefficients of Utilization

rc	Effective floor cavity reflectance						20%						
	80%			50%			30%			20%			
	70	50	30	10	50	30	10	50	30	10	50	30	10
RCR													
0	113	113	113	113	104	104	104	99	99	99			
1	103	98	93	89	90	87	84	86	83	81			
2	93	85	78	72	78	73	69	75	70	66			
3	85	74	66	60	69	62	57	66	60	56			
4	77	66	57	50	61	54	49	58	52	47			
5	71	58	50	43	55	47	42	52	46	41			
6	66	53	44	38	49	42	37	47	41	36			
7	61	48	39	33	45	38	33	43	37	32			
8	57	44	35	30	41	34	29	40	33	29			
9	53	40	32	27	38	31	26	37	30	26			
10	50	37	29	24	35	28	24	34	28	24			

Zonal Lumen Summary

Zone	Lumens	%Lamp	%Fixture
0-30	4562	24.5	25.6
0-40	7330	39.4	41.1
0-60	12827	69.0	71.9
0-90	17094	91.9	95.8
0-180	17837	95.9	100.0

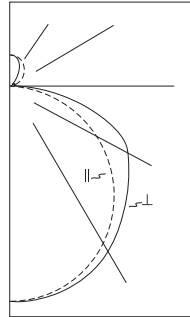

HBL-632-W-UPL
Wide Distribution
 (2) Electronic Plus Ballasts
 (6) F32T8 32W lamps 3100 lumens
 Spacing criterion: (H) 1.3 x mounting height, (L) 1.3 x mounting height
 Efficiency 90.5%
 Test Report: HBL632WUPL.IES

Coefficients of Utilization

rc	Effective floor cavity reflectance						20%						
	80%			50%			30%			20%			
	70	50	30	10	50	30	10	50	30	10	50	30	10
RCR													
0	106	106	106	106	97	97	97	91	91	91			
1	96	91	87	83	83	80	77	78	76	73			
2	86	78	72	66	72	67	62	68	63	60			
3	78	68	60	54	62	56	51	59	54	50			
4	71	60	52	45	55	49	43	52	47	42			
5	65	53	45	39	49	42	37	47	41	36			
6	60	48	40	34	44	37	32	42	36	31			
7	56	43	35	29	40	33	28	38	32	28			
8	52	39	31	26	37	30	25	35	29	25			
9	48	36	28	23	34	27	23	32	26	22			
10	45	33	26	21	31	25	20	30	24	20			

Zonal Lumen Summary

Zone	Lumens	%Lamp	%Fixture
0-30	3714	20.0	22.1
0-40	6154	33.1	36.6
0-60	11290	60.7	67.1
0-90	15508	83.4	92.1
0-180	16834	90.5	100.0

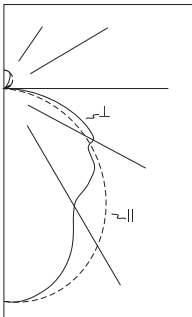

HBL-832-N-UPL
Narrow Distribution
 (2) Electronic Ballasts
 (8) F32T8 32W lamps 3100 lumens
 Spacing criterion: (H) 1.3 x mounting height, (L) 1.0 x mounting height
 Efficiency 95.0%
 Test Report: HBL832NUPL.IES

Coefficients of Utilization

rc	Effective floor cavity reflectance						20%						
	80%			50%			30%			20%			
	70	50	30	10	50	30	10	50	30	10	50	30	10
RCR													
0	112	112	112	112	102	102	102	97	97	97			
1	101	96	92	88	88	85	82	84	81	79			
2	92	83	77	71	77	71	67	73	68	65			
3	83	73	65	59	67	61	56	64	59	54			
4	76	65	56	50	60	53	48	57	51	46			
5	70	58	49	43	54	46	41	51	45	40			
6	65	52	43	37	48	41	36	46	40	35			
7	60	47	39	33	44	37	32	42	36	31			
8	56	43	35	29	40	33	29	39	33	28			
9	52	40	32	26	37	30	26	36	30	25			
10	49	37	29	24	34	28	23	33	27	23			

Zonal Lumen Summary

Zone	Lumens	%Lamp	%Fixture
0-30	6045	24.4	25.7
0-40	9501	38.3	40.4
0-60	16429	66.2	69.7
0-90	22053	88.9	93.6
0-180	23561	95.0	100.0

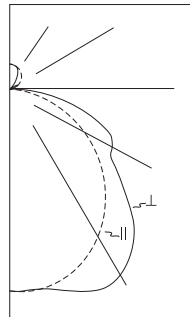

HBL-832-M-UPL
Medium Distribution
 (2) Electronic Ballasts
 (8) F32T8 32W lamps 3100 lumens
 Spacing criterion: (H) 1.3 x mounting height, (L) 1.5 x mounting height
 Efficiency 96.5%
 Test Report: HBL832MUPL.IES

Coefficients of Utilization

rc	Effective floor cavity reflectance						20%						
	80%			50%			30%			20%			
	70	50	30	10	50	30	10	50	30	10	50	30	10
RCR													
0	113	113	113	113	104	104	104	98	98	98			
1	103	98	93	89	89	86	83	84	82	79			
2	93	84	77	71	77	72	67	73	69	65			
3	84	73	65	59	68	61	56	64	59	54			
4	77	65	56	49	60	53	47	57	51	46			
5	70	58	49	42	53	46	40	51	44	39			
6	65	52	43	36	48	41	35	46	39	34			
7	60	47	38	32	43	36	31	41	35	30			
8	56	42	34	28	40	32	27	38	31	27			
9	52	39	31	25	36	29	25	35	29	24			
10	49	36	28	23	33	27	22	32	26	22			

Zonal Lumen Summary

Zone	Lumens	%Lamp	%Fixture
0-30	5330	21.5	22.3
0-40	9071	36.6	37.9
0-60	16597	66.9	69.3
0-90	22265	89.9	93.0
0-180	23941	96.5	100.0

Illuminance Estimator

Illuminance Levels (FC) & Watts Per Sq. Ft. (LPD)

Based on 100 ft. x 100 ft. Open Room

HBL632NUPL

Spacing on Center	Qty	15 ft			20 ft			25 ft			30 ft		
		FC	LPD		Qty	FC	LPD	Qty	FC	LPD	Qty	FC	LPD
20 ft	49	68.0	1.08		25	34.8	0.55	16	22.3	0.35	12	16.7	0.26
25 ft	49	63.0	1.08		25	32.1	0.55	16	20.5	0.35	12	15.4	0.26
30 ft	49	58.0	1.08		25	29.7	0.55	16	19.0	0.35	12	14.2	0.26

Choose the spacing and mounting height to determine the average footcandle and watts per square foot values. All the calculations are based on the published IESNA Zonal Cavity Method and associated algorithms. Results are calculated from manufacturer photometric files.

System Performance Table

HBL T8 System Comparison	No. of Lamps	Lamp Lumens	Lumen Maintenance ¹	Fixture Efficiency	Ballast Factor	Design System Lumens ²	S/P Ratio ³	Brightness Perception	S/P Adjusted Lumens ⁴	Wattage	Cost of 1000 S/P Adj Lumens - 4000 hrs @ 0.08 kWh	LER ⁵
HBL-432-W-UPL	4	3100	94%	90%	1.15	12064	1.72	1.53	18416	147	\$2.47	125
HBL-632-N-UPL	6	3100	94%	96%	1.15	18900	1.95	1.40	26393	221	\$2.79	119
HBL-832-N-UPL	8	3100	94%	95%	1.15	24128	1.95	1.40	33693	302	\$3.02	111
Comparison System												
250W Metal Halide High Bay	1	23000	75%	78%	1.00	15000	1.50	1.22	18371	295	\$6.59	49
250W High Pressure Sodium High Bay	1	30000	81%	78%	1.00	18978	0.67	0.73	13887	300	\$8.85	36
400W Metal Halide High Bay	1	36000	75%	78%	1.00	21087	1.50	1.22	25826	455	\$7.22	44
400W High Pressure Sodium High Bay	1	50000	81%	78%	1.00	31631	0.62	0.79	24906	464	\$7.63	42
1000W Metal Halide High Bay	1	110000	45%	70%	1.00	36083	1.50	1.22	44192	1085	\$5.70	56
1000W High Pressure Sodium High Bay	1	130000	45%	70%	1.00	40950	0.62	0.79	32244	1100	\$1560	21

FOOTNOTES: ¹ Lumen maintenance is based on lamp manufacturer's stated data combined with estimated dirt depreciation. ² Design System Lumens is the fixture lumens at 40% of rated lamp life and is calculated as Quantity of Lamps x Lamp Lumens x Lumen Maintenance x Fixture Efficiency x Ballast Factor. ³ S/P Ratio is the lamp manufacturer's stated Scotopic/Photopic Ratio; accepted by some lighting designers to adjust for the relative strengths of scotopic and photopic vision, not yet adopted by IESNA. ⁴ S/P Adjusted Lumens calculates the brightness perception scotopic/photopic ratio as Design System Lumens x (S/P)^{0.5}. ⁵ LER (Luminaire Efficiency Ratio) is an accepted method of comparing fixture performance.

HBL T5 HIGH-BAY INDUSTRIAL LUMINAIRE

Ordering Information Sample Number: HBL-654T5-N-UNV-EBT2-UPL-U

Width Blank=20" wide 4 & 6 Lamp (nominal) 26" wide 8 & 10 Lamp (nominal)	Voltage ⁽¹⁾ UNV=Universal 120/277 Voltage 347/480 Voltage UNC=Universal 120V=120 Volt 277V=277 Volt 347V=347 Volt
Series HBL=Linear High Bay	Options Lamps Installed L8535=T5HO Lamp, 85CRI 3500K L8541=T5HO Lamp, 85CRI 4100K L8550=T5HO Lamp, 85CRI 5000K GL=Single Element Fuse GM=Double Element Fuse EL=Emergency Installed
No. of Lamps 4=4 Lamps 6=6 Lamps 8=8 Lamps 10=10 Lamps	Notes: ⁽¹⁾ Voltage must be specified when ordered with plugs or emergency ballasts. For MS option, indicate UNV (for 120V or 277V), 347V or 480V. ⁽²⁾ EBT ballast systems suitable for operation in ambient environments up to 104°F (40°C) in upright configuration. ⁽³⁾ EHT/HT5/HCT5 ballast systems are suitable for ambient environments not to exceed 149°F (65°C) in upright configurations. ⁽⁴⁾ Requires use of MC_ or MPC_ cord accessories, specify voltage for plugs. ⁽⁵⁾ Cannot be combined with Modular Power Receptacle (MP). For MWS with MP, choose MP in fixture logic and then choose MWS. ⁽⁶⁾ Recommended when using motion sensor options or accessories. ⁽⁷⁾ Can be used in high abuse applications such as gymnasiums.
Lamp Type 49T5=49W T5HO (4') Lamps 51T5=51W T5HO (4') Lamps 54T5=54W T5HO Lamp (48" Long)	
Distribution N=Narrow Beam (Standard) M=Medium Beam W=Wide Beam	

Includes V Hangers for rapid installation⁽⁷⁾

Ballast Type ^{(3), (6)} T5 Systems EBT_ =T5 Linear Electronic Program Rapid Start. ⁽²⁾ Total Harmonic Distortion < 10% No. of Ballast 1, 2 or 3 EHT_ =T5 Linear Electronic Program Start High Ambient. ^{(2), (3)} Total Harmonic Distortion < 10% No. of Ballast 1, 2 or 3	Options UPL=Uplight Apertures on Reflector MP=Modular Power Receptacle (Used for all Cord or Cord and Plug options) ⁽⁴⁾ MWS=Modular Wiring System ⁽⁵⁾ MS=360° or 180° Motion Sensor installed (120V through 347V or 480V) ⁽¹⁾	Packaging U=Unit Pack PALC=Palletized In Carton
Accessories (order separately) HBL-SPM=Single Monopoint Hanger w/Hub RH-1=Retrofit Hanger FH-1=Fixture Hook FL-1=Fixture Loop Y-TOGGLE=Y Mounting Toggle, #2 Cable (Specify 10' or 30') HBAYC-CHAIN/SET/U=(2) V-Hook Hanger, 36" Chain Sets w/S-Hooks MC3=3' Modular Power Cord MPC3=3' Modular Power Cord & Plug (Specify Voltage) MC6=6' Modular Power Cord MPC6=6' Modular Power Cord & Plug (Specify Voltage) MMS=360° or 180° Aisle Motion Sensor with Modular Power Receptacle (120-277V) ⁽⁴⁾ WG/HBL6-4FT-B=4/6 Lamp Wireguard w/Clips WG/HBL8-4FT-B=8 Lamp Wireguard w/Clips		



Quick Ship Ordering Information Sample Number: HBL454T5-MP-UPL-L5

Quick Ship orders ship in 5 days in order quantities not to exceed 200 pieces.
 NOTE: Orders received after noon are entered on the following day.

Includes V Hangers for rapid installation⁽⁷⁾

Family HBL	Lamp Type 51=51W T5HO Lamps (48") 54=54W T5HO Lamps (48")	Ballast Type T5HO Systems T5=(2) 120/277V 4/2 Lamp T5 Electronic Program Rapid Start ⁽⁸⁾ HT5=(2) 120/277V 4/2 Lamp T5 High Ambient Electronic Program Rapid Start ⁽⁹⁾	Power Receptacle MP=Modular Power Receptacle ⁽¹⁰⁾	Uplight Blank=No Uplight UPL=Uplight	Lamping Blank=No Lamps L4=Lamps Installed 85+CRI 4100K ⁽¹¹⁾ L5=Lamps Installed 85+CRI 5000K ⁽¹¹⁾ L5ES=Energy Savings Lamps Installed 85+CRI 5000K
No. of Lamps 4=4 Lamps 6=6 Lamps	Distribution Blank=Narrow Beam W=Wide Beam	Notes: ⁽⁸⁾ T5 ballast systems suitable for operation in ambient environments up to 104°F (40°C) in upright configuration. ⁽⁹⁾ EHT/HT5/HCT5 ballast systems are suitable for ambient environments not to exceed 149°F (65°C) in upright configurations. ⁽¹⁰⁾ Requires use of MC_ or MPC_ cord accessories, specify voltage for plugs. ⁽¹¹⁾ For Quick Ship, lamping option only available w/54W lamp type.			

Dimensions

HBL Lamp Configurations

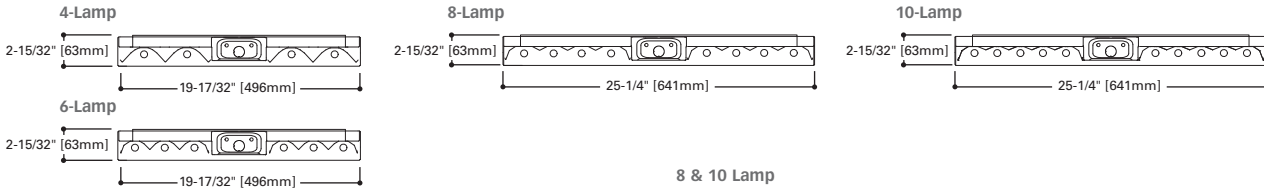

Dimensions for Top View

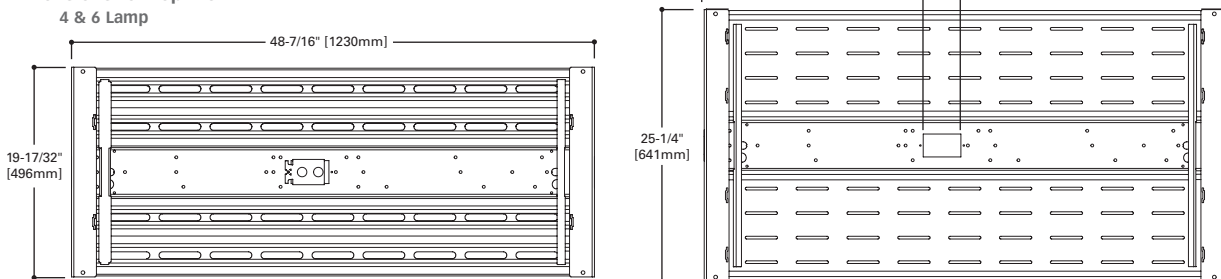

Photometrics

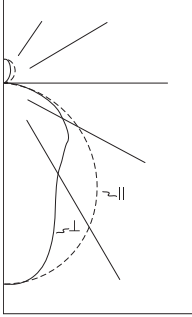

HBL-654T5-N-UPL
Narrow Distribution
 (2) Electronic Ballasts
 (6) F54T5 54W lamps 4400 lumens
 Spacing criterion: (H) 1.2 x mounting height, (L) 0.9 x mounting height
 Efficiency 97.0%
 Test Report: HBL654NUPL.IES

Coefficients of Utilization

rc	Effective floor cavity reflectance 20%					
	80%		50%		30%	
	70	50	30	10	50	30
RCR	70	50	30	10	50	30
0	114	114	114	114	103	103
1	104	99	95	92	86	83
2	95	87	80	75	75	71
3	86	77	69	63	67	62
4	79	68	60	54	60	54
5	73	61	53	46	57	50
6	68	55	47	41	49	43
7	63	50	42	36	45	39
8	59	46	38	33	41	35
9	55	42	35	29	38	32
10	52	39	32	27	36	30

Zonal Lumen Summary

Zone	Lumens	%Lamp	%Fixture
0-30	7354	27.9	28.7
0-40	11251	42.6	43.9
0-60	18573	70.4	72.5
0-90	23479	88.9	91.6
0-180	25621	97.0	100.0

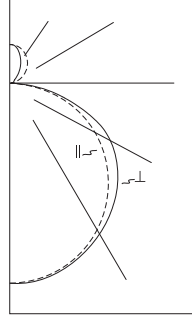

HBL-654T5-W-UPL
Wide Distribution
 (2) Electronic Ballasts
 (6) F54T5 54W lamps 4400 lumens
 Spacing criterion: (H) 1.3 x mounting height, (L) 1.3 x mounting height
 Efficiency 93.3%
 Test Report: HBL654WUPL.IES

Coefficients of Utilization

rc	Effective floor cavity reflectance 20%					
	80%		50%		30%	
	70	50	30	10	50	30
RCR	70 <td>50 <td>30 <td>10 <td>50 <td>30</td> </td></td></td></td>	50 <td>30 <td>10 <td>50 <td>30</td> </td></td></td>	30 <td>10 <td>50 <td>30</td> </td></td>	10 <td>50 <td>30</td> </td>	50 <td>30</td>	30
0	109	109	109	109	98	98
1	99	94	90	86	85	82
2	89	81	74	69	74	69
3	81	71	63	57	64	58
4	74	62	54	47	57	50
5	68	55	47	40	51	44
6	62	50	41	35	46	39
7	58	45	37	31	41	34
8	54	41	33	27	38	31
9	50	37	30	24	35	28
10	47	34	27	22	32	26

Zonal Lumen Summary

Zone	Lumens	%Lamp	%Fixture
0-30	5401	20.5	21.9
0-40	8947	33.9	36.3
0-60	16453	62.3	66.8
0-90	22065	83.6	89.6
0-180	24626	93.3	100.0

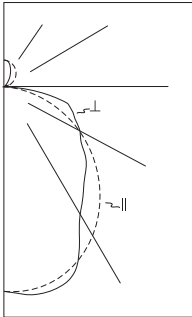

HBL-854T5-N-UPL
Narrow Distribution
 (2) Electronic Ballasts
 (8) F54T5 54W lamps 4400 lumens
 Spacing criterion: (H) 1.3 x mounting height, (L) 1.2 x mounting height
 Efficiency 94.0%
 Test Report: HBL854NUPL.IES

Coefficients of Utilization

rc	Effective floor cavity reflectance 20%					
	80%		50%		30%	
	70	50	30	10	50	30
RCR	70 <td>50 <td>30 <td>10 <td>50 <td>30</td> </td></td></td></td>	50 <td>30 <td>10 <td>50 <td>30</td> </td></td></td>	30 <td>10 <td>50 <td>30</td> </td></td>	10 <td>50 <td>30</td> </td>	50 <td>30</td>	30
0	110	110	110	110	101	101
1	100	95	91	87	87	84
2	91	83	76	71	76	71
3	83	73	65	59	67	61
4	76	65	56	50	60	53
5	70	58	49	43	54	47
6	65	52	44	38	48	42
7	60	47	39	33	44	37
8	56	43	35	30	41	34
9	52	40	32	27	37	31
10	49	37	29	24	35	28

Zonal Lumen Summary

Zone	Lumens	%Lamp	%Fixture
0-30	8780	24.9	26.5
0-40	13886	39.4	42.0
0-60	23440	66.6	70.8
0-90	30822	87.6	93.1
0-180	33096	94.0	100.0

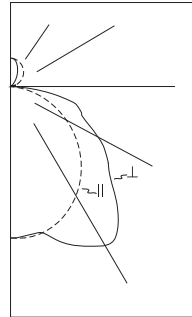

HBL-854T5-M-UPL
Medium Distribution
 (2) Electronic Ballasts
 (8) F54T5 54W lamps 4400 lumens
 Spacing criterion: (H) 1.3 x mounting height, (L) 1.7 x mounting height
 Efficiency 94.1%
 Test Report: HBL854MUPL.IES

Coefficients of Utilization

rc	Effective floor cavity reflectance 20%					
	80%		50%		30%	
	70	50	30	10	50	30
RCR	70 <td>50 <td>30 <td>10 <td>50 <td>30</td> </td></td></td></td>	50 <td>30 <td>10 <td>50 <td>30</td> </td></td></td>	30 <td>10 <td>50 <td>30</td> </td></td>	10 <td>50 <td>30</td> </td>	50 <td>30</td>	30
0	110	110	110	110	101	101
1	100	95	91	87	87	83
2	90	82	75	69	75	70
3	82	71	63	57	65	59
4	74	63	54	47	57	51
5	68	56	47	40	51	44
6	63	50	41	35	46	39
7	58	45	36	30	42	34
8	54	41	32	27	38	31
9	50	37	29	24	35	28
10	47	34	26	21	32	25

Zonal Lumen Summary

Zone	Lumens	%Lamp	%Fixture
0-30	6859	19.5	20.7
0-40	12020	34.1	36.3
0-60	22731	64.6	68.6
0-90	30614	87.0	92.4
0-180	33127	94.1	100.0

Illuminance Estimator

Illuminance Levels (FC) & Watts Per Sq. Ft. (LPD)

HBL654NUPL

Based on 100 ft. x 100 ft. Open Room

Mounting Height	Spacing on Center	15 ft			20 ft			25 ft			30 ft		
		Qty	FC	LPD	Qty	FC	LPD	Qty	FC	LPD	Qty	FC	LPD
20 ft	20 ft	49	83.0	1.76	25	42.2	0.90	16	27.0	0.57	12	20.2	0.43
	25 ft	49	77.0	1.76	25	39.1	0.90	16	25.0	0.57	12	18.8	0.43
	30 ft	49	71.0	1.76	25	36.3	0.90	16	23.2	0.57	12	17.4	0.43

Choose the spacing and mounting height to determine the average footcandle and watts per square foot values. All the calculations are based on the published IESNA Zonal Cavity Method and associated algorithms. Results are calculated from manufacturer photometric files.

System Performance Table

HBL T8 System Comparison	No. of Lamps	Lamp Lumens	Lumen Maintenance ¹	Fixture Efficiency	Ballast Factor	Design System Lumens ²	S/P Ratio ³	Brightness Perception	S/P Adjusted Lumens ⁴	Wattage	Cost of 1000 S/P Adj Lumens 4000 hrs @ 0.08 kWh	LER ⁵
HBL-454T5-N-UPL	4	5000	93%	95%	1.00	17670	1.72	1.31	23174	240	\$3.39	96
HBL-654T5-N-UPL	6	5000	93%	97%	1.00	27063	1.90	1.38	37304	360	\$3.06	103
HBL-854T5-N-UPL	8	5000	93%	94%	1.00	34968	1.90	1.38	48200	480	\$3.23	100
Comparison System												
250W Metal Halide High Bay	1	23000	75%	78%	1.00	15000	1.50	1.22	18371	295	\$6.59	49
250W High Pressure Sodium High Bay	1	30000	81%	78%	1.00	18978	0.67	0.73	13887	300	\$8.85	36
400W Metal Halide High Bay	1	36000	75%	78%	1.00	21087	1.50	1.22	25826	455	\$7.22	44
400W High Pressure Sodium High Bay	1	50000	81%	78%	1.00	31631	0.62	0.79	24906	464	\$7.63	42
1000W Metal Halide High Bay	1	110000	45%	70%	1.00	36083	1.50	1.22	44192	1085	\$5.70	56
1000W High Pressure Sodium High Bay	1	130000	45%	70%	1.00	40950	0.62	0.79	32244	1100	\$15.60	21

FOOTNOTES: ¹ Lumen maintenance is based on lamp manufacturer's stated data combined with estimated dirt depreciation. ² Design System Lumens is the fixture lumens at 40% of rated lamp life and is calculated as Quantity of Lamps x Lamp Lumens x Lumen Maintenance x Fixture Efficiency x Ballast Factor. ³ S/P Ratio is the lamp manufacturers stated Scotopic/Photopic Ratio; accepted by some lighting designers to adjust for the relative strengths of scotopic and photopic vision, not yet adopted by IESNA. ⁴ S/P Adjusted Lumens calculates the brightness perception scotopic/photopic ratio as Design System Lumens x (S/P)^{0.5}. ⁵ LER (Luminaire Efficiency Ratio) is an accepted method of comparing fixture performance.

MBF MICRO-BAY LUMINAIRE

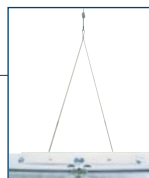
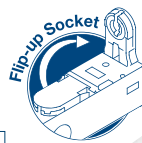

Cable Mounting Kit

Suspension is convenient and flexible in continuous row mounted fixtures with the SS Aircraft Cable "Y" Toggle Mounting Kits. Adjustment for luminaire mounting height is provided at luminaire rather than structure.

Specular reflectors for precise light control minimum 95% total reflectivity. Three optical distribution patterns are available:

- Focus - $SC < .5$
- Task - $.5 < SC \leq .9$
- Normal - $.9 < SC \leq 1.2$

Optional pre-wired factory installed multiple circuit plug-in connectors.



Plug-In Connectors

Integral occupancy sensor available and provides from 600 sq. ft. up to 1250 sq. ft. of coverage in a max. mounting height of 40'.

Factory installed code compliant means of disconnect for safe and convenient means of disconnecting power.

LINEAR DISCONNECT

Rigid exterior connector/ coupling with pre-punched holes facilitates easy installation of sections up to 32' long. (order separately)



Rigid Exterior Connector

Dimensions for Top View

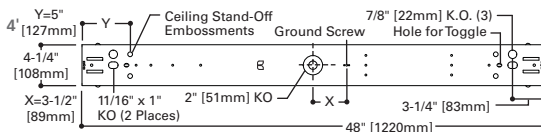

Dimensions

T5 Lamp Configurations

Focus Beam, 1 T5 Lamp

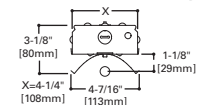

Task Beam, 1 T5 Lamp

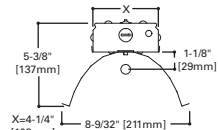

Normal Beam, 1 T5 Lamp

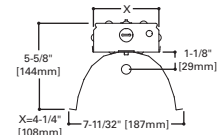

Focus Beam, 2 T5 Lamps

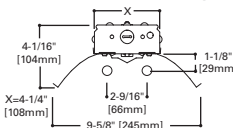

Normal Beam, 2 T5 Lamps

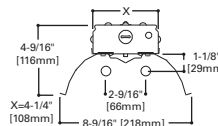

T8 Lamp Configurations

Focus Beam, 1 T8 Lamp

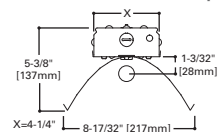

Task Beam, 1 T8 Lamp

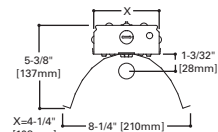

Normal Beam, 1 T8 Lamp

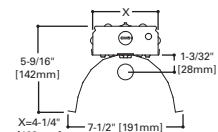

Focus Beam, 2 T8 Lamps

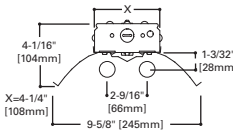

Normal Beam, 2 T8 Lamps

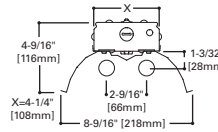

MBF Ordering Information

Sample Number (T5): MBF-154T5-FB-UNV-EBT1-U (T8): MBF-132-NB-UNV-EB81-U

<p>Tandem Blank= 4' Length 8T= 8' Length</p> <p>Series MBF=Micro-Bay</p> <p>Number of Lamps (Not included) 1=1 Lamp 2=2 Lamps</p> <p>Lamp Types 32=32W T8 (48") 49T5=49W T5HO (48") 51T5=51W T5HO (48") 54T5=54W T5HO (48")</p> <p>Reflector FB=Focus Beam TB=Task Beam (Medium -1 lamp only) NB=Normal Beam</p> <p>Voltage UNV=Universal 120-277 Voltage UNC=Universal 347/480 Voltage</p> <p>Options GL=Single Element Fuse GM=Double Element Fuse EL=Emergency Installed (see table on pg. 48)⁽²⁾</p>	<p>Ballast Type⁽¹⁾ T5 Systems EBT =T5 Linear Electronic Program Rapid Start. Total Harmonic Distortion < 10% No. of Ballast 1 or 2 EHT =T5 Linear Electronic Program Rapid Start High Ambient. Total Harmonic Distortion < 10%⁽⁴⁾ No. of Ballast 1 or 2 T8 Systems EB8 =T8 Electronic Instant Start.⁽⁵⁾ Total Harmonic Distortion < 10% No. of Ballast 1 or 2 EB8 /PLUS=T8 Electronic Instant Start.⁽⁵⁾ High Ballast Factor >1.15. Total Harmonic Distortion < 10% No. of Ballast 1 or 2 ER8 =T8 Electronic Program Rapid Start.⁽⁵⁾ Total Harmonic Distortion < 10% No. of Ballast 1 or 2 ER8 /PLUS=T8 Electronic Program Start.⁽⁵⁾ High Ballast Factor >1.15. Total Harmonic Distortion < 10% No. of Ballast 1 or 2 DIM=Dimming (ballast must be specified)</p>	<p>Options PI/CPI=Plug-In (1, 2 or 3) See pg. 52 C3=3' Power Cord C6=6' Power Cord PC3=3' Power Cord & Plug (Specify Voltage)⁽³⁾ PC6=6' Power Cord & Plug (Specify Voltage)⁽³⁾</p> <p>Accessories (order separately) AYC-CHAIN/SET/U=(2) Hooks, 36" Chain Sets w/S-Hooks Y-TOGGLE=Y Mounting Toggle, #2 Cable (Specify 10' or 30')⁽⁷⁾ TOGGLE=Single Toggle, #2 Cable (Specify 10' or 30') SSF-EXT-LONG-CONN-KIT-U=Rigid Connector Support for Continuous Channel Installation MB-SENSOR-KIT-CTR/MT-U=Aisle Coverage Motion Sensor, Center Mount Hardware, 120/277V^{(3), (6)} MB-SENSOR-KIT-END/MT-U=Aisle Coverage Motion Sensor, End Mount Hardware, 120/277V^{(3), (6)} MB-SENSOR-KIT-CTR/480V-U=Aisle Coverage Motion Sensor, Center Mount Hardware, 480V MB-SENSOR-KIT-END/480V-U=Aisle Coverage Motion Sensor, End Mount Hardware, 480V ATG-SSF-4-U=Tong Hanger</p>	<p>Packaging U=Unit Pack</p>
--	--	--	---

NOTES: ⁽¹⁾Products also available in non-US voltages and frequencies for international markets. ⁽²⁾Voltage to be specified with emergency ballast option. ⁽³⁾Voltage must be specified when ordered with plugs, motion sensor or emergency ballasts. ⁽⁴⁾2 lamp ballast configurations only in UNC versions. ⁽⁵⁾ER8 and EB8 ballast systems suitable for operation in ambient environments up to 50°C. ⁽⁶⁾Must ship separately. ⁽⁷⁾Use with continuous row mount at fixture joint only.

Photometrics

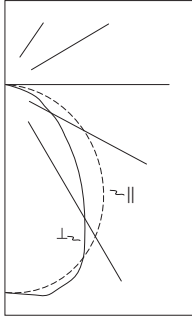

Coefficients of Utilization

rc	Effective floor cavity reflectance						
	80%		50%		20%		
rw	70	50	30	10	50	30	10
RCR							
0	117	117	117	117	109	109	109
1	108	104	101	97	98	95	93
2	100	92	86	81	87	82	78
3	91	82	75	69	78	72	67
4	84	73	65	59	70	63	58
5	78	66	58	52	63	56	51
6	72	60	51	46	57	55	45
7	67	54	46	41	52	45	40
8	63	50	42	36	48	41	36
9	59	46	38	33	44	38	33
10	55	43	35	30	41	35	30

MBF-232-NB-UNV-EB81-U

Electronic Ballast
 (2) 32W T8 lamps 3100 lumens
 Spacing criterion: (II) 1.3 x mounting height, (L) 1.1 x mounting height
 Efficiency 98.4%
 Test Report: MBF-232NB.IES

Zonal Lumen Summary

Zone	Lumens	%Lamp	%Fixture
0-30	2057	33.2	33.7
0-40	3252	52.4	53.3
0-60	5224	84.3	85.6
0-90	6100	98.4	100.0
0-180	6100	98.4	100.0

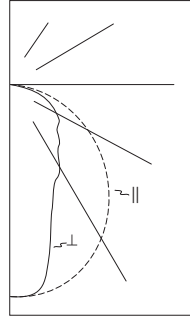

Coefficients of Utilization

rc	Effective floor cavity reflectance						
	80%		50%		20%		
rw	70	50	30	10	50	30	10
RCR							
0	119	119	119	119	111	111	111
1	109	105	101	97	99	96	93
2	100	92	86	81	87	82	78
3	92	82	74	68	77	71	66
4	85	73	65	59	70	63	57
5	78	66	58	51	63	56	50
6	73	60	52	45	57	50	45
7	68	55	47	41	53	45	40
8	63	51	42	37	49	42	36
9	60	47	39	34	45	38	33
10	56	43	36	31	42	35	30

MBF-232-FB-UNV-EB81-U

Electronic Ballast
 (2) 32W T8 lamps 3100 lumens
 Spacing criterion: (II) 1.3 x mounting height, (L) 0.7 x mounting height
 Efficiency 99.9%
 Test Report: MBF-232FB.IES

Zonal Lumen Summary

Zone	Lumens	%Lamp	%Fixture
0-30	2140	34.5	34.5
0-40	3197	51.6	51.6
0-60	5048	81.4	81.5
0-90	6194	99.9	100.0
0-180	6194	99.9	100.0

System Performance

MBF

8TMBF

	2 LAMP T12	1 LAMP T12 HO	2 LAMP T12	1 LAMP T12 HO	2 LAMP T12	1 LAMP T12 HO
Energy Savings	56%	61%	48%	55%	56%	61%
% Light Gain/Loss	38%	37%	23%	22%	38%	37%
Part Number	MBF-232-FB-EB81	MBF-154T5-FB-EBT1	8TMBF-232-FB-EB81			
	T8	T5	T8			

% light gain/light loss utilize S/P adjusted lumens.

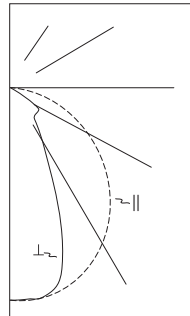

MBF-154T5-TB-UNV-EBT1-U

Electronic Ballast
 (1) 54W T5HO Lamp 4400 lumens
 Spacing criterion: (II) 1.3 x mounting height, (L) 0.8 x mounting height
 Efficiency 99.9%
 Test Report: MBF-154T5TB.IES

Coefficients of Utilization

rc	Effective floor cavity reflectance						
	80%		50%		20%		
rw	70	50	30	10	50	30	10
RCR							
0	119	119	119	119	111	111	111
1	111	108	104	101	101	99	97
2	103	97	91	87	92	88	84
3	96	88	81	76	83	78	74
4	89	80	72	67	76	70	65
5	83	73	65	60	70	63	59
6	78	67	59	54	64	58	53
7	73	61	54	49	59	53	48
8	69	57	50	44	55	49	44
9	65	53	46	41	51	45	41
10	61	49	42	38	48	42	38

Zonal Lumen Summary

Zone	Lumens	%Lamp	%Fixture
0-30	2004	44.5	45.6
0-40	2847	64.7	64.8
0-60	4032	91.6	91.8
0-90	4394	99.9	100.0
0-180	4394	99.9	100.0

Illuminance Estimator

Illuminance Levels (FC) & Watts Per Sq. Ft. (LPD)

Micro-Bay

Based on 120 ft. x 10 ft. Aisle

Catalog Number	20 ft			25 ft			30 ft		
	Qty	FC	LPD	Qty	FC	LPD	Qty	FC	LPD
MBF-132-FB	20	15.7	0.58	23	15.2	0.67	27	15.3	0.78
MBF-154-FB	13	16.0	0.66	15	15.5	0.76	17	15.1	0.86
MBF-232-FB	22	30.5	1.00	27	30.8	1.23	32	31.0	1.46
MBF-254-FB	14	32.0	1.40	16	30.4	1.60	19	30.8	1.90

Choose the spacing and mounting height to determine the average footcandle and watts per square foot values. All the calculations are based on the published IESNA Zonal Cavity Method and associated algorithms. Results are calculated from manufacturer photometric files.

System Performance Table

MBF System Comparison	No. of Lamps	Lamp Lumens	Lumen Maintenance ¹	Fixture Efficiency	Ballast Factor	Design System Lumens ²	S/P Ratio ³	Brightness Perception	S/P Adjusted Lumens ⁴	Wattage	Cost of 1000 S/P Adj Lumens - 4000 hrs @ 0.08 kWh	LER ⁵
MBF-232-FB-EB81	2	3100	94%	99%	1.00	5770	1.95	1.40	8057	56	\$2.25	143
MBF-154-FB-UNV-EBT1	1	5000	93%	98%	1.00	4543	1.90	1.38	6262	46	\$3.40	136
8TMBF-232-FB-EB81	2	3100	94%	99%	1.00	11540	1.95	1.40	16114	148	\$2.25	109
Comparison System												
(2) 34W T12 Strip	2	2750	88%	90%	0.90	3920	1.50	1.22	4801	126	\$10.37	31
(1) 96" T12HO Strip	1	8630	58%	90%	0.88	3964	1.50	1.22	4855	145	\$12.07	27

FOOTNOTES: ¹ Lumen maintenance is based on lamp manufacturer's stated data combined with estimated dirt depreciation. ² Design System Lumens is the fixture lumens at 40% of rated lamp life and is calculated as Quantity of Lamps x Lamp Lumens x Lumen Maintenance x Fixture Efficiency x Ballast Factor. ³ S/P Ratio is the lamp manufacturer's stated Scotopic/Photopic Ratio; accepted by some lighting designers to adjust for the relative strengths of scotopic and photopic vision, not yet adopted by IESNA. ⁴ S/P Adjusted Lumens calculates the brightness perception scotopic/photopic ratio as Design System Lumens x (S/P)^{0.5}. ⁵ LER (Luminaire Efficiency Ratio) is an accepted method of comparing fixture performance.

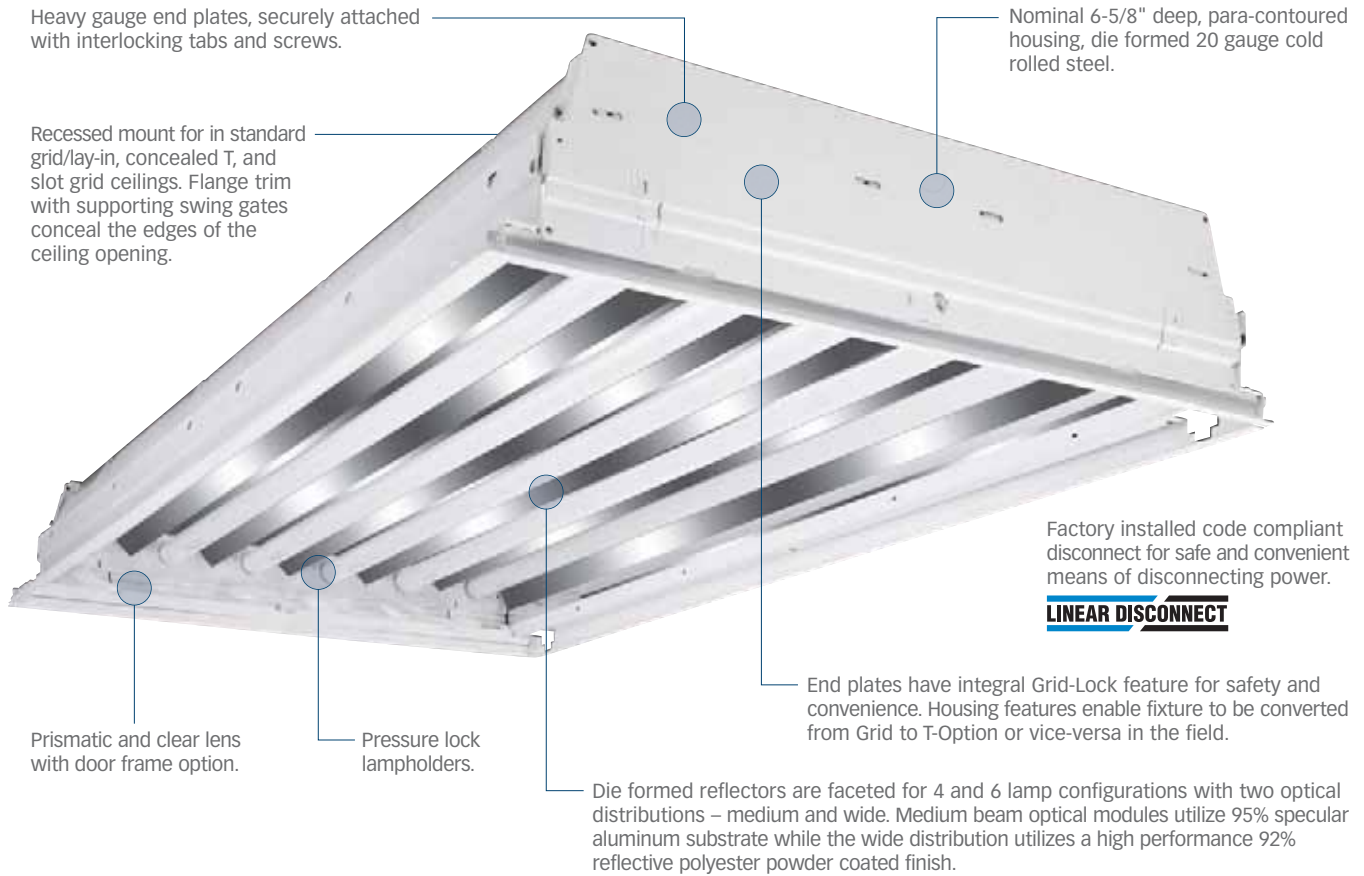

Heavy gauge end plates, securely attached with interlocking tabs and screws.

Recessed mount for in standard grid/lay-in, concealed T, and slot grid ceilings. Flange trim with supporting swing gates conceal the edges of the ceiling opening.

Nominal 6-5/8" deep, para-contoured housing, die formed 20 gauge cold rolled steel.

Factory installed code compliant disconnect for safe and convenient means of disconnecting power.

LINEAR DISCONNECT

End plates have integral Grid-Lock feature for safety and convenience. Housing features enable fixture to be converted from Grid to T-Option or vice-versa in the field.

Prismatic and clear lens with door frame option.

Pressure lock lampholders.

Die formed reflectors are faceted for 4 and 6 lamp configurations with two optical distributions – medium and wide. Medium beam optical modules utilize 95% specular aluminum substrate while the wide distribution utilizes a high performance 92% reflective polyester powder coated finish.

Ordering Information Sample Number: 2HBG-654T5-A-UNV-EBT2-U

<p>Width 2=24"</p> <p>Series HB=High Bay</p> <p>Trim Type G=Grid/Lay-in (Standard) F=Flange Trim</p> <p>No. of Lamps 4=4 Lamps 6=6 Lamps</p> <p>Lamp Type 32=32W T8 Lamps (48") 28T5=28W T5 Lamps (48") 49T5=49W T5HO (48") 51T5=51W T5HO (48") 54T5=54W T5HO Lamps (48")</p> <p>Distribution Optic Blank=Medium (Specular Aluminum) G=Wide (White Painted)</p> <p>Shielding Blank=Open A=Prismatic Acrylic Lens & Steel Door Frame CL=Clear Acrylic Lens & Steel Door Frame</p>	<p>Voltage⁽¹⁾ UNV=Universal 120/277 Voltage UNC=Universal 347/480 Voltage (T5 linear only) 120V=120 Volt 277V=277 Volt 347V=347 Volt</p> <p>Options Lamps Installed L8830=T8 Lamp, 85CRI 3000K L8835=T8 Lamp, 85CRI 3500K L8841=T8 Lamp, 85CRI 4100K L8850=T8 Lamp, 85CRI 5000K L5830=T5 Lamp, 85CRI 3000K L5835=T5 Lamp, 85CRI 3500K L5841=T5 Lamp, 85CRI 4100K L5850=T5 Lamp, 85CRI 5000K GL=Single Element Fuse GM=Double Element Fuse EL=Emergency Installed⁽¹⁾ (see table on pg. 48)</p>	<p>Ballast Type T8 Systems EB8 =T8 Electronic Instant Start.⁽²⁾ Total Harmonic Distortion < 10% No. of Ballast 1 or 2 EB8 /PLUS=T8 Electronic Instant Start.⁽²⁾ High Ballast Factor >1.15. Total Harmonic Distortion < 10% No. of Ballast 1 or 2 ER8 =T8 Electronic Program Rapid Start. Total Harmonic Distortion < 10%⁽²⁾ No. of Ballast 1 or 2 ER8 /PLUS=T8 Electronic Program Start. High Ballast Factor >1.15.⁽²⁾ Total Harmonic Distortion < 10% No. of Ballast 1 or 2 T5 Systems EBT =T5 or T5HO Linear Electronic Program Rapid Start. Total Harmonic Distortion < 10% No. of Ballast 1 or 2</p>	<p>Packaging U=Unit Pack PAL=Job Pack, out of carton PALC=Job Pack, in carton</p> <p>Accessories (order separately) MWS=Modular Wiring System, (Refer to MWS Catalog Online)</p>
---	--	--	--

NOTES: ⁽¹⁾Voltage must be specified when ordered with emergency ballasts. ⁽²⁾ER8 and EB8 ballast systems suitable for operation in ambient environments up to 122°F (50°C) without lens option.

Ceiling Compatibility

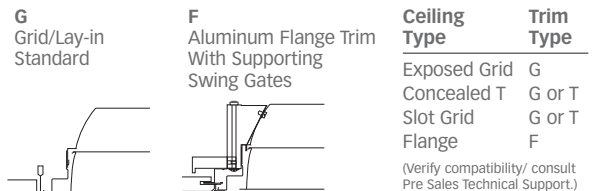

Photometrics

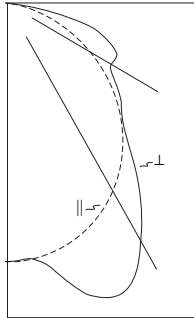

Coefficients of Utilization

rc	Effective floor cavity reflectance									
	80%		50%		20%		30%			
rw	70	50	30	10	50	30	10	50	30	10
RCR										
0	99	99	99	99	93	93	93	89	89	89
1	91	87	83	80	81	79	76	78	76	74
2	82	76	70	65	71	67	63	68	65	61
3	75	66	59	54	62	57	53	60	56	52
4	69	59	51	46	56	50	45	54	48	44
5	63	53	45	39	50	44	39	48	43	38
6	58	47	40	34	45	39	34	44	38	34
7	54	43	36	30	41	35	30	40	34	30
8	50	39	32	27	37	31	27	36	31	27
9	47	36	29	24	34	28	24	34	28	24
10	44	33	26	22	32	26	22	31	26	22

2HBG-632-UNV-EB82
 (2) Electronic Ballasts
 (6) F32T8/TL835 lamps 3000 lumens
 Spacing criterion: (II) 1.2 x mounting height, (L) 1.4 x mounting height
 Efficiency 83.4%
 Test Report: 2HBG632.IES

Zonal Lumen Summary

Zone	Lumens	%Lamp	%Fixture
0-30	4174	23.2	27.8
0-40	6937	38.5	46.2
0-60	11814	65.6	78.7
0-90	15014	83.4	91.5
0-180	15014	83.4	100.0

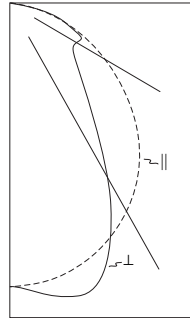

Coefficients of Utilization

rc	Effective floor cavity reflectance									
	80%		50%		20%		30%			
rw	70	50	30	10	50	30	10	50	30	10
RCR										
0	88	88	88	88	82	82	82	78	78	78
1	81	78	75	72	73	71	69	70	68	67
2	74	68	64	60	65	61	58	62	59	57
3	68	61	55	51	58	53	50	56	52	49
4	63	55	48	44	52	47	43	50	46	42
5	58	49	43	38	47	42	38	45	41	37
6	54	45	38	34	43	37	34	41	37	33
7	50	41	35	30	39	34	30	38	33	30
8	47	37	32	27	36	31	27	35	30	27
9	44	35	29	25	33	28	25	33	28	25
10	41	32	27	23	31	26	23	30	26	23

2HBG-654T5-UNV-EBT2
 (3) Electronic Ballasts
 (6) F54T5HO/841 lamps 4400 lumens
 Spacing criterion: (II) 1.2 x mounting height, (L) 1.1 x mounting height
 Efficiency 73.5%
 Test Report: 2HBG654T5.IES

Zonal Lumen Summary

Zone	Lumens	%Lamp	%Fixture
0-30	6821	25.8	35.1
0-40	10503	39.8	54.1
0-60	16195	61.3	83.4
0-90	19412	73.5	100.0
0-180	19412	73.5	100.0

System Performance

2HBG

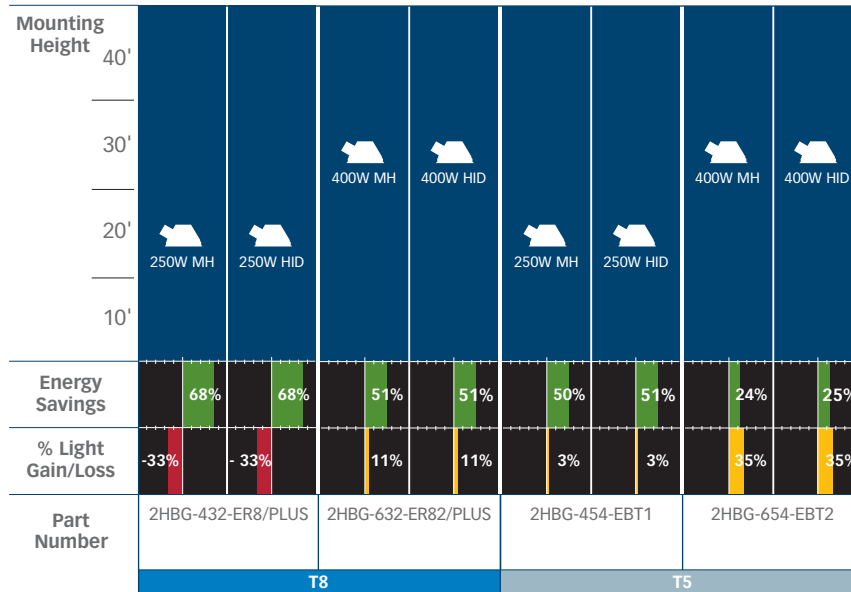

% light gain/light loss utilize S/P adjusted lumens.

Dimensions

2HBG Lamp Configurations

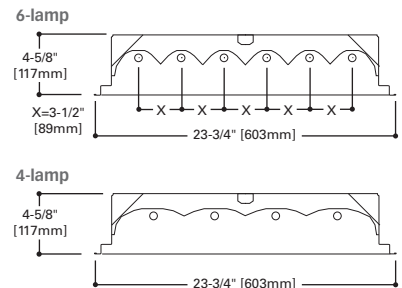

Dimensions for Top View

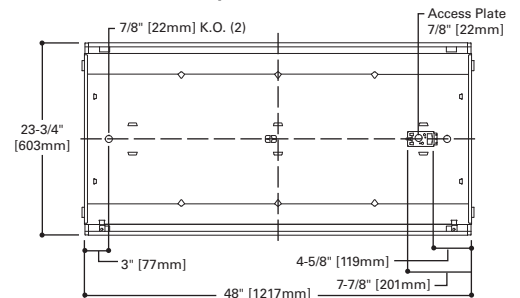

System Performance Table

2HBG System Comparison	No. of Lamps	Lamp Lumens	Lumen Maintenance ¹	Fixture Efficiency	Ballast Factor	Design System Lumens ²	S/P Ratio ³	Brightness Perception	S/P Adjusted Lumens ⁴	Wattage	Cost of 1000 S/P Adj Lumens - 4000 hrs @ 0.08 kWh	LER ⁵
2HBG-432-ER81/PLUS	4	3100	94%	80%	1.15	10724	1.95	1.40	14975	147	\$3.41	94
2HBG-632-EB82/PLUS	6	3100	94%	80%	1.15	16085	1.95	1.40	22462	221	\$3.42	94
2HBG-454T5-EBT1	4	5000	93%	80%	1.00	14880	1.90	1.38	20511	240	\$4.47	85
2HBG-654T5-EBT2	6	5000	93%	80%	1.00	22320	1.90	1.38	30766	360	\$4.50	85
Comparison System												
250W Metal Halide High Bay	1	23000	75%	78%	1.00	15000	1.50	1.22	18371	295	\$6.59	49
250W High Pressure Sodium High Bay	1	30000	81%	78%	1.00	18978	0.62	0.79	14944	300	\$8.23	39
400W Metal Halide High Bay	1	36000	75%	78%	1.00	21087	1.50	1.22	25826	455	\$7.22	44
400W High Pressure Sodium High Bay	1	50000	81%	78%	1.00	31631	0.62	0.79	24906	464	\$7.63	42

FOOTNOTES: ¹ Lumen maintenance is based on lamp manufacturer's stated data combined with estimated dirt depreciation. ² Design System Lumens is the fixture lumens at 40% of rated lamp life and is calculated as Quantity of Lamps x Lamp Lumens x Lumen Maintenance x Fixture Efficiency x Ballast Factor. ³ S/P Ratio is the lamp manufacturers stated Scotopic/Photopic Ratio; accepted by some lighting designers to adjust for the relative strengths of scotopic and photopic vision, not yet adopted by IESNA. ⁴ S/P Adjusted Lumens calculates the brightness perception scotopic/photopic ratio as Design System Lumens x (S/P)^{0.5} based on 4100K lamps. ⁵ LER (Luminaire Efficiency Ratio) is an accepted method of comparing fixture performance.

HBHD HOSEDOWN HIGH-BAY INDUSTRIAL LUMINAIRE

High performance white enamel finish improves efficiency and protects against elements. Optional brushed stainless steel finish for corrosive chemical environments.

White, closed cell, Flexiseal™ gasketing surrounds perimeter of lens to seal lens to door frame and around perimeter of door to seal door to housing. Another layer seals fixture to ceiling system after installation.

Product can be surface or suspension mounted.

UL/cUL and CSA listed for wet locations. Manufactured in compliance with USDA, FDA, NSF and Federal Standard 209E in surface mount applications.

Sealed housing is enclosed and gasketed to provide 800 psi hose down protection.

Factory installed code compliant disconnect for safe and convenient means of disconnecting power.

LINEAR DISCONNECT

One piece, heavy gauge extruded lens in prismatic clear acrylic.

Captive, flush mounted stainless steel fasteners secure one piece door to housing.

Die formed reflectors are faceted for 4 and 6 lamp configurations with two optical distributions – medium and wide. Medium beam optical modules utilize 95% specular aluminum while the wide distribution utilizes a high performance 95% reflective polyester powder coated finish.

Ordering Information Sample Number: 2HBHD-654T5-A-UNV-EBT2-U

<p>Width 2=24"</p>	<p>Shielding A=Prismatic Acrylic Lens & Door Frame CL=Clear Acrylic Lens & Door Frame</p>	<p>Ballast Type⁽¹⁾ T8 Systems EB8 =T8 Electronic Instant Start. Total Harmonic Distortion < 10%</p>	<p>Options C3=3' Power Cord C6=6' Power Cord PC3=3' Power Cord & Plug (Specify Voltage)⁽¹⁾ PC6=6' Power Cord & Plug (Specify Voltage)⁽¹⁾ SSN=Stainless Steel Door/Brushed 304 Finish SHN=Stainless Steel Housing Brushed 304 Finish</p>	<p>Packaging U=Unit Pack PAL=Pallet Pack PALC=Job Pack In Carton</p>
<p>Series HBHD=High Bay Hose Down</p>	<p>Voltage⁽¹⁾ UNV=Universal 120/277 Voltage UNC=Universal 347/480 Voltage (T5 linear only)⁽²⁾ 120V=120 Volt 277V=277 Volt 347V=347 Volt 480V=480 Volt</p>	<p>No. of Ballast 1 or 2</p> <p>EB8_/PLUS=T8 Electronic Instant Start. High Ballast Factor >1.15. Total Harmonic Distortion < 10%</p>		
<p>No. of Lamps 4=4 Lamps 6=6 Lamps</p>	<p>Options Lamps Installed L8830=T8 Lamp, 85CRI 3000K L8835=T8 Lamp, 85CRI 3500K L8841=T8 Lamp, 85CRI 4100K L8850=T8 Lamp, 85CRI 5000K L5830=T5 Lamp, 85CRI 3000K L5835=T5 Lamp, 85CRI 3500K L5841=T5 Lamp, 85CRI 4100K L5850=T5 Lamp, 85CRI 5000K HL=Add HL at end of lamp for high lumen lamps, T8 only GL=Single Element Fuse GM=Double Element Fuse EL=Emergency Installed⁽¹⁾ (see table on pg. 48)</p>	<p>ER8 =T8 Electronic Program Rapid Start. Total Harmonic Distortion < 10%</p> <p>No. of Ballast 1 or 2</p> <p>ER8_/PLUS=T8 Electronic Program Start. High Ballast Factor >1.15. Total Harmonic Distortion < 10%</p>		
<p>Lamp Type 32=32W T8 Lamps (48") 28T5=28W T5 Lamps (48") 49T5=49W T5HO (48") 51T5=51W T5HO (48") 54T5=54W T5HO Lamps (48")</p>		<p>T5 Systems EBT =T5 or T5HO Linear Electronic Program Rapid Start. Total Harmonic Distortion < 10%</p> <p>No. of Ballast 1, 2 or 3</p> <p>EHT =T5HO Linear Electronic Start High Ambient.⁽²⁾ Total Harmonic Distortion < 10%</p> <p>No. of Ballast 1, 2 or 3</p> <p>DIM=Dimming (ballast must be specified)</p>		
<p>Distribution Blank=Medium (Specular Aluminum) G=Wide (High Reflectance White)</p>				

NOTES: ⁽¹⁾Voltage must be specified when ordered with plugs or emergency ballasts. ⁽²⁾2 lamp ballast configurations only in UNC versions.

Photometrics

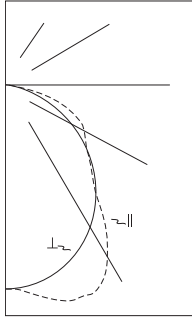

Coefficients of Utilization

rc	Effective floor cavity reflectance									
	80%				50%					
rw	70	50	30	10	50	30	10	50	30	10
RCR										
0	81	81	81	81	76	76	76	72	72	72
1	75	72	69	66	67	65	63	65	63	61
2	68	63	58	55	59	56	53	57	54	52
3	62	56	50	46	52	48	45	51	47	44
4	57	49	44	39	47	42	38	45	41	38
5	53	44	38	34	42	37	34	41	37	33
6	49	40	34	30	38	33	30	37	33	29
7	45	36	31	27	35	30	26	34	29	26
8	42	33	28	24	32	27	24	31	27	23
9	40	31	25	21	29	25	21	29	24	21
10	37	28	23	19	27	23	19	27	22	19

2HBHD-632-CL-UNV-EB82

(2) Electronic Ballasts
 (6) F32T8/TL835 lamps 3000 lumens
 Spacing criterion: (II) 1.2 x mounting height, (L) 1.2 x mounting height
 Efficiency 68.1%
 Test Report: 2HBHD632CLIES

Zonal Lumen Summary

Zone	Lumens	%Lamp	%Fixture
0-30	3768	20.9	30.7
0-40	6124	34.0	50.0
0-60	10121	56.2	82.6
0-90	12258	68.1	91.5
0-180	12258	68.1	100.0

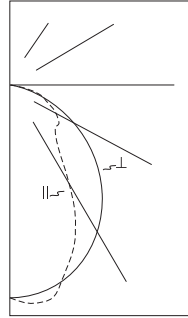

Coefficients of Utilization

rc	Effective floor cavity reflectance									
	80%				50%					
rw	70	50	30	10	50	30	10	50	30	10
RCR										
0	70	70	70	70	66	66	66	63	63	63
1	65	63	61	59	59	57	56	57	55	54
2	60	56	52	49	53	50	47	51	48	46
3	55	50	45	42	47	44	41	46	43	40
4	51	45	40	36	42	39	36	41	38	35
5	47	40	36	32	39	35	31	37	34	31
6	44	37	32	28	35	31	28	34	31	28
7	41	34	29	26	32	28	25	32	28	25
8	38	31	26	23	30	26	23	29	26	23
9	36	29	24	21	28	24	21	27	23	21
10	34	27	22	19	26	22	19	25	22	19

2HBHD-654T5-CL-UNV-EBT2

(2) Electronic Ballasts
 (6) F54T5HO/841 54W lamps 4400 lumens
 Spacing criterion: (II) 1.0 x mounting height, (L) 1.2 x mounting height
 Efficiency 52.9%
 Test Report: 2HBHD654T5CLIES

Zonal Lumen Summary

Zone	Lumens	%Lamp	%Fixture
0-30	5876	22.3	37.6
0-40	8802	33.3	56.3
0-60	13385	50.7	85.7
0-90	15627	59.2	75.3
0-180	15627	59.2	100.0

System Performance

2HBHD

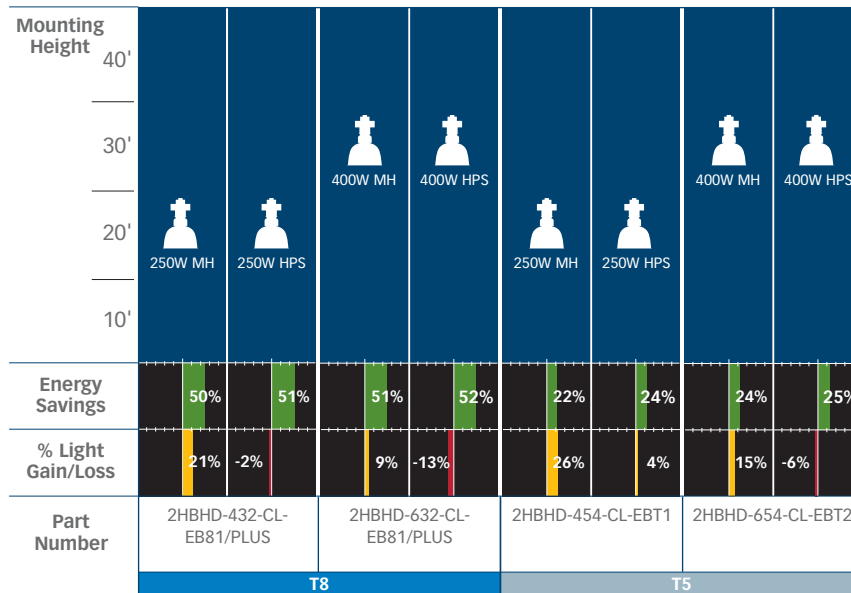

% light gain/light loss utilize S/P adjusted lumens.

Dimensions

HBHD Lamp Configurations

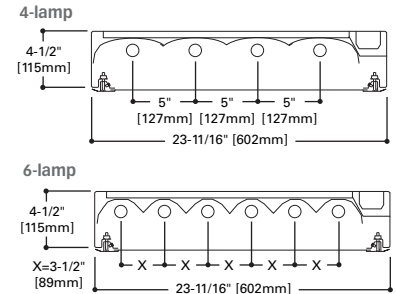

Dimensions for Top View

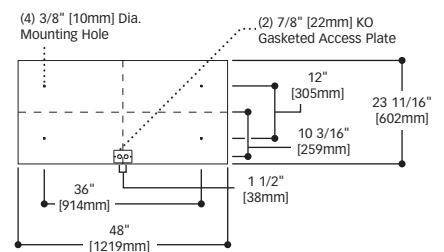

System Performance Table

2HBHD System Comparison	No. of Lamps	Lamp Lumens	Lumen Maintenance ¹	Fixture Efficiency	Ballast Factor	Design System Lumens ²	S/P Ratio ³	Brightness Perception	S/P Adjusted Lumens ⁴	Wattage	Cost of 1000 S/P Adj. Lmns - 4000 hrs @ 0.08 kWh	LER ⁵
2HBHD-432-CL-EB81/PLUS	4	3100	94%	68%	1.15	9128	1.95	1.40	12747	147	\$4.71	68
2HBHD-632-CL-EB82/PLUS	6	3100	94%	68%	1.15	13693	1.95	1.40	19121	221	\$4.72	68
2HBHD-454T5-CL-EBT1	4	5000	93%	53%	1.00	9839	1.90	1.38	13563	240	\$10.21	56
2HBHD-654T5-CL-EBT2	6	5000	93%	53%	1.00	14759	1.90	1.38	20344	360	\$10.29	56
Comparison System												
250W Metal Halide Encl. & Gasketed High Bay	1	20800	58%	68%	1.00	8179	1.50	1.22	10018	295	\$13.90	23
250W High Pressure Sodium Encl. & Gasketed High Bay	1	30000	81%	68%	1.00	16475	0.62	0.79	12973	300	\$10.91	29
400W Metal Halide Encl. & Gasketed High Bay	1	36000	58%	68%	1.00	14157	1.50	1.22	17338	455	\$12.39	26
400W High Pressure Sodium Encl. & Gasketed High Bay	1	50000	81%	68%	1.00	27459	0.62	0.79	21621	464	\$10.13	32

FOOTNOTES: ¹ Lumen maintenance is based on lamp manufacturer's stated data combined with estimated dirt depreciation. ² Design System Lumens is the fixture lumens at 40% of rated lamp life and is calculated as Quantity of Lamps x Lamp Lumens x Lumen Maintenance x Fixture Efficiency x Ballast Factor. ³ S/P Ratio is the lamp manufacturers stated Scotopic/Photopic Ratio; accepted by some lighting designers to adjust for the relative strengths of scotopic and photopic vision, not yet adopted by IESNA. ⁴ S/P Adjusted Lumens calculates the brightness perception scotopic/photopic ratio as Design System Lumens x (S/P)^{0.5} based on 5000K lamps. ⁵ LER (Luminaire Efficiency Ratio) is an accepted method of comparing fixture performance.

HBHT HOSEDOWN HIGH-BAY INDUSTRIAL LUMINAIRE

High performance white enamel finish improves efficiency and protects against elements. Optional brushed stainless steel finish for corrosive chemical environments.

White, closed cell, Flexiseal™ gasketing surrounds perimeter of lens to seal lens to door frame and door to housing.

Sealed housing is enclosed and gasketed to provide 800 psi hose down protection and IP65 rating.

Die formed reflectors are faceted for 4 and 6 lamp configurations with two optical distributions – medium and wide. Medium beam optical modules utilize 95% specular aluminum while the wide distribution utilizes a high performance 95% reflective polyester powder coated finish.

Product can be chain, cable or stem mounted.

Sloped top allows for water runoff during cleaning of fixture. This feature enables this suspension mounted fixture to be installed in cleanroom, food processing and recreational facilities.

Factory installed code compliant disconnect for safe and convenient means of disconnecting power.

LINEAR DISCONNECT

One piece, heavy gauge extruded lens in prismatic clear acrylic.

Captive, flush mounted stainless steel fasteners secure one piece door to housing.

UL/CUL and CSA listed for wet locations. IP65 certified.

Ordering Information Sample Number: 2HBHT-654T5-A-UNV-EBT2

<p>Width 2=24"</p>					<p>Packaging U=Unit Pack PAL=Pallet Pack PALC=Job Pack In Carton</p>
<p>Series HBHT=High Bay Hose Down w/Tented Top</p>		<p>Shielding A=Prismatic Acrylic Lens & Steel Door Frame CL=Clear Acrylic Lens & Steel Door Frame 93=Prismatic Tempered Glass & Steel Door Frame 94=Clear Tempered Glass & Steel Door Frame</p>	<p>Ballast Type⁽¹⁾ T8 Systems EB8 =T8 Electronic Instant Start. Total Harmonic Distortion < 10% No. of Ballast 1 or 2 EB8 /PLUS=T8 Electronic Instant Start. High Ballast Factor >1.15. Total Harmonic Distortion < 10% No. of Ballast 1 or 2 ER8 =T8 Electronic Program Rapid Start. Total Harmonic Distortion < 10% No. of Ballast 1 or 2 ER8 /PLUS=T8 Electronic Program Start. High Ballast Factor >1.15. Total Harmonic Distortion < 10% No. of Ballast 1 or 2 T5 Systems EHT =T5 Linear Electronic Start High Ambient.⁽²⁾ Total Harmonic Distortion < 10% No. of Ballast 1, 2 or 3</p>	<p>Options PM=Pendant Mount Stem⁽⁴⁾ C3=3' Power Cord⁽⁵⁾ C6=6' Power Cord⁽⁵⁾ PC3=3' Power Cord & Plug (Specify Voltage)^{(1) (2)(5)} PC6=6' Power Cord & Plug (Specify Voltage)^{(1) (5)} SSN=Brushed Stainless Steel Door Finish SHN=Brushed Stainless Steel Housing Finish</p>	
<p>No. of Lamps 4=4 Lamps 6=6 Lamps</p>		<p>Voltage⁽¹⁾ UNV=Universal 120/277 Voltage UNC=Universal 347/480 Voltage (T5 linear only)⁽²⁾ 120V=120 Volt 277V=277 Volt 347V=347 Volt</p>		<p>Accessories (order separately) Y-Hook=(2) Snap Hooks, #2 Cable (Specify 10' or 30'), order 2 per fixture HBHT-Chain/Set=(2) 6ft. Stainless Steel Chains, (4) large S-Hooks</p>	
<p>Lamp Type 28T5=28W T5 Lamps (48") 32=32W T8 Lamps (48") 49T5=49W T5HO Lamps (48") 51T5=51W T5HO Lamps (48") 54T5=54W T5HO Lamps (48")</p>		<p>Options Lamps Installed L8830=T8 Lamp, 85CRI 3000K L8835=T8 Lamp, 85CRI 3500K L8841=T8 Lamp, 85CRI 4100K L8850=T8 Lamp, 85CRI 5000K L5830=T5 Lamp, 85CRI 3000K L5835=T5 Lamp, 85CRI 3500K L5841=T5 Lamp, 85CRI 4100K L5850=T5 Lamp, 85CRI 5000K HL=Add HL at end of lamp for high lumen lamps, T8 only GL=Single Element Fuse GM=Double Element Fuse EL=Emergency Installed⁽¹⁾ (see table on pg. 48)</p>			
<p>Distribution Blank=Medium (Specular Aluminum) G=Wide (High Reflectance White)</p>					

NOTES: ⁽¹⁾Voltage must be specified when ordered with plugs, motion sensors or emergency ballasts. ⁽²⁾2 lamp ballast configurations only in UNC versions. ⁽³⁾3/4" stem only, supplied by others. Power supply fed through stem during installation. ⁽⁴⁾Always supplied with a 6 ft. 3-wire cord as standard through pendant stem hub. ⁽⁵⁾Available for chain or cable mount options only.

Photometrics

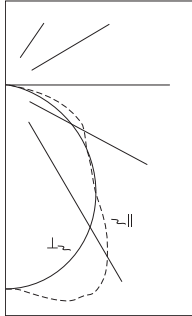

Coefficients of Utilization

rc	Effective floor cavity reflectance												
	80%				50%				20%				
rw	70	50	30	10	50	30	10	50	30	10	50	30	10
RCR													
0	81	81	81	81	76	76	76	72	72	72			
1	75	72	69	66	67	65	63	65	63	61			
2	68	63	58	55	59	56	53	57	54	52			
3	62	56	50	46	52	48	45	51	47	44			
4	57	49	44	39	47	42	38	45	41	38			
5	53	44	38	34	42	37	34	41	37	33			
6	49	40	34	30	38	33	30	37	33	29			
7	45	36	31	27	35	30	26	34	29	26			
8	42	33	28	24	32	27	24	31	27	23			
9	40	31	25	21	29	25	21	29	24	21			
10	37	28	23	19	27	23	19	27	22	19			

2HBHT-632-CL-UNV-EB82

(2) Electronic Ballasts
 (6) F32T8/TL835 lamps 3000 lumens
 Spacing criterion: (II) 1.2 x mounting height, (L) 1.2 x mounting height
 Efficiency 68.1%
 Test Report: 2HBHT632CL.IES

Zonal Lumen Summary

Zone	Lumens	%Lamp	%Fixture
0-30	3768	20.9	30.7
0-40	6124	34.0	50.0
0-60	10121	56.2	82.6
0-90	12258	68.1	91.5
0-180	12258	68.1	100.0

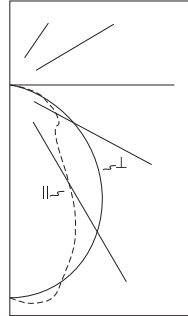

Coefficients of Utilization

rc	Effective floor cavity reflectance												
	80%				50%				20%				
rw	70	50	30	10	50	30	10	50	30	10	50	30	10
RCR													
0	70	70	70	70	66	66	66	63	63	63			
1	65	63	61	59	59	57	56	57	55	54			
2	60	56	52	49	53	50	47	51	48	46			
3	55	50	45	42	47	44	41	46	43	40			
4	51	45	40	36	42	39	36	41	38	35			
5	47	40	36	32	39	35	31	37	34	31			
6	44	37	32	28	35	31	28	34	31	28			
7	41	34	29	26	32	28	25	32	28	25			
8	38	31	26	23	30	26	23	29	26	23			
9	36	29	24	21	28	24	21	27	23	21			
10	34	27	22	19	26	22	19	25	22	19			

2HBHT-654T5-CL-UNV-EBT2

(2) Electronic Ballasts
 (6) F54T5HO/841 54W lamps 4400 lumens
 Spacing criterion: (II) 1.0 x mounting height, (L) 1.2 x mounting height
 Efficiency 52.9%
 Test Report: 2HBHT654T5CL.IES

Zonal Lumen Summary

Zone	Lumens	%Lamp	%Fixture
0-30	5876	22.3	37.6
0-40	8802	33.3	56.3
0-60	13385	50.7	85.7
0-90	15627	59.2	75.3
0-180	15627	59.2	100.0

System Performance

2HBHT

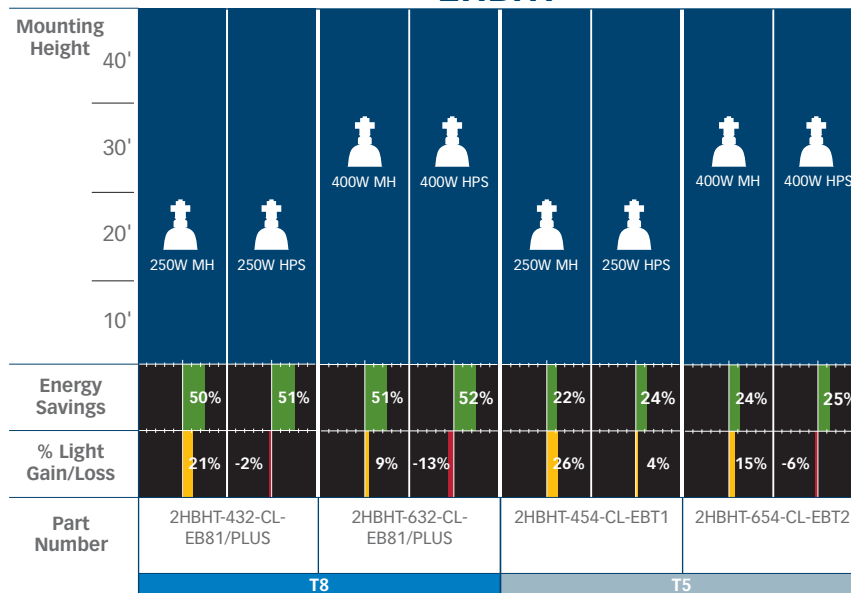

% light gain/light loss utilize S/P adjusted lumens.

Dimensions

HBHT Lamp Configurations

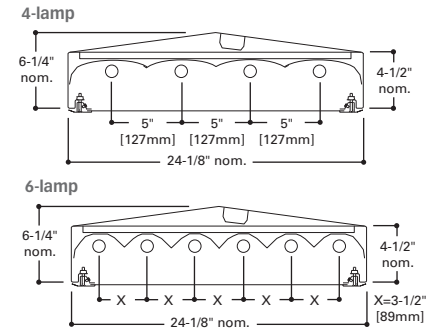

Dimensions for Top View

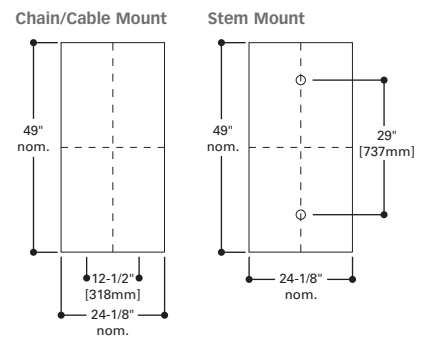

System Performance Table

2HBHD System Comparison	No. of Lamps	Lamp Lumens	Lumen Maintenance ¹	Fixture Efficiency	Ballast Factor	Design System Lumens ²	S/P Ratio ³	Brightness Perception	S/P Adjusted Lumens ⁴	Wattage	Cost of 1000 S/P Adj. Lmns - 4000 hrs @ 0.08 kWh	LER ⁵
2HBHT-432-CL-EB81/PLUS	4	3100	94%	68%	1.15	9128	1.95	1.40	12747	147	\$4.71	68
2HBHT-632-CL-EB82/PLUS	6	3100	94%	68%	1.15	13693	1.95	1.40	19121	221	\$4.72	68
2HBHT-454T5-CL-EBT1	4	5000	93%	53%	1.00	9839	1.90	1.38	13563	240	\$10.21	56
2HBHT-654T5-CL-EBT2	6	5000	93%	53%	1.00	14759	1.90	1.38	20344	360	\$10.29	56
Comparison System												
250W Metal Halide Encl. & Gasketed High Bay	1	20800	58%	68%	1.00	8179	1.50	1.22	10018	295	\$13.90	23
250W High Pressure Sodium Encl. & Gasketed High Bay	1	30000	81%	68%	1.00	16475	0.62	0.79	12973	300	\$10.91	29
400W Metal Halide Encl. & Gasketed High Bay	1	36000	58%	68%	1.00	14157	1.50	1.22	17338	455	\$12.39	26
400W High Pressure Sodium Encl. & Gasketed High Bay	1	50000	81%	68%	1.00	27459	0.62	0.79	21621	464	\$10.13	32

FOOTNOTES: ¹ Lumen maintenance is based on lamp manufacturer's stated data combined with estimated dirt depreciation. ² Design System Lumens is the fixture lumens at 40% of rated lamp life and is calculated as Quantity of Lamps x Lamp Lumens x Lumen Maintenance x Fixture Efficiency x Ballast Factor. ³ S/P Ratio is the lamp manufacturers stated Scotopic/Photopic Ratio; accepted by some lighting designers to adjust for the relative strengths of scotopic and photopic vision, not yet adopted by IESNA. ⁴ S/P Adjusted Lumens calculates the brightness perception scotopic/photopic ratio as Design System Lumens x (S/P)^{0.5} based on 5000K lamps. ⁵ LER (Luminaire Efficiency Ratio) is an accepted method of comparing fixture performance.

Enclosed, full bodied housing utilizes captive fasteners to protect optical assembly and assure structural integrity of housing while retaining heat for optimal system performance. Thermally optimized Arctic Bay is suitable for environments down to -20°F (-29°C).

Housing is "post" painted with a high performance polyester powder coat finish to protect against contaminants and oxidation.

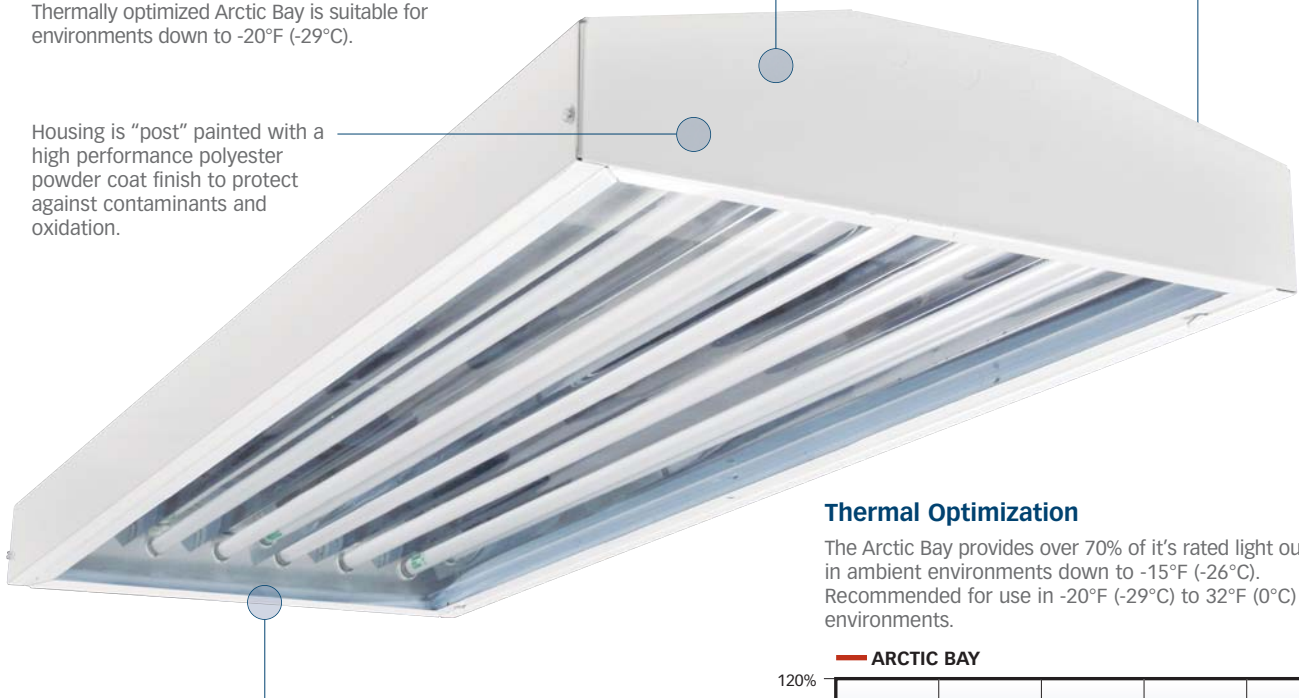

Sealed and gasketed door frame provides a thermal environment for optimal lamp operation. Optional clear or prismatic shielding available.

Factory installed code compliant disconnect for safe and convenient means of disconnecting power.

LINEAR DISCONNECT

Thermal Optimization

The Arctic Bay provides over 70% of it's rated light output in ambient environments down to -15°F (-26°C). Recommended for use in -20°F (-29°C) to 32°F (0°C) environments.

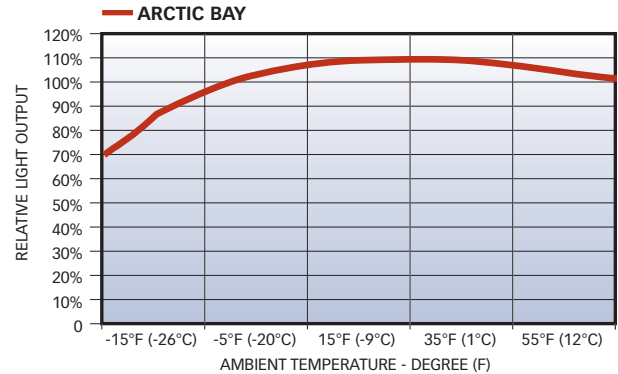

Ordering Information Sample Number: ABI-654T5-UNV-EBT2 Includes V Hangers for rapid installation⁽⁴⁾

<p>Series ABI=Arctic Bay</p> <p>No. of Lamps 4=4 Lamps 6=6 Lamps</p> <p>Lamp Type 49T5=49W T5HO Lamps (48") 51T5=51W T5HO Lamps (48") 54T5=54W T5HO Lamps (48")</p> <p>Distribution N=Narrow Beam (Standard) M=Medium Beam W=Wide Beam</p>	<p>Shielding Blank=Prismatic Acrylic Lens w/Gasketed Door Frame CL=Clear Acrylic Lens w/Gasketed Door Frame</p> <p>Voltage⁽²⁾ UNV=Universal 120/277 Voltage UNC=Universal 347/480 Voltage 120V=120 Volt 277V=277 Volt 347V=347 Volt 480V=480 Volt</p> <p>Options Lamps Installed L5830=T5 Lamp, 85CRI 3000K L5835=T5 Lamp, 85CRI 3500K L5841=T5 Lamp, 85CRI 4100K L5850=T5 Lamp, 85CRI 5000K GL=Single Element Fuse GM=Double Element Fuse EL=Emergency installed (see table on pg. 48)⁽²⁾</p>	<p>Ballast Type EBTL=T5 Linear Electronic Program Rapid Start. Total Harmonic Distortion < 10% Minimum Start Temp. -20°F (-29°C)</p> <p>No. of Ballast 1, 2 or 3</p> <p>Options C3=3' White Cord Fixture Attached C6=6' White Cord Fixture Attached MS/OB=360° or 180° Motion Sensor Installed, Inner Two Lamps Constant On⁽³⁾ MS/IB=360° or 180° Motion Sensor Installed, Outside Lamps Constant On⁽³⁾ PC3-Voltage=3' Cord/Plug Fixture Attached⁽²⁾ PC6-Voltage=6' Cord/Plug Fixture Attached⁽²⁾</p>	<p>Packaging U=Unit Pack PAL=Palletized Out of Carton PALC=Job Pack In Carton</p> <p>Accessories (order separately) HBAYC-CHAIN/SET/U=(2) V-Hook Hanger, 36" Chain Sets w/S-Hooks HB-SPM=Single Monopoint Hanger w/Hub RH-1=Retrofit Hanger FH-1=Fixture Hook FL-1=Fixture Loop Y-TOGGLE=Y Mounting Toggle, #2 Cable (Specify 10' or 30') SCA-48=Stem Set Adjustable 48" length SCF=Stem Set Fixed (specify length) SCS=Stem Set 45° Swivel (specify length)</p>
--	--	--	--

NOTES: ⁽¹⁾Requires use of voltage specific modular cord assembly. See accessories. ⁽²⁾Voltage must be specified when ordered with plugs, motion sensors or emergency ballasts. ⁽³⁾Specify voltage of ballast as UNV (120V or 277V), 347V or 480V. ⁽⁴⁾Can be used in high abuse applications such as gymnasiums.

Mounting Accessories



HB-SPM=Single Monopoint Hanger w/Hub (Galvanized)

FH-1=Fixture Hook 2-1/2" (must be used with HB-SPM)

FL-1=Fixture Loop 2-1/2" (must be used with HB-SPM)

RH-1=Retrofit Hanger (must be used with HB-SPM)

HBAYC=New Mounting Chain Set w/V-Hook Hangers (ideal for gymnasium applications)

Y=Mounting Toggle and 10' or 25' cable

Temperature Control Capability

Cooper Lighting recommends the following lamp operation when implementing a control system in colder ambient environments.

Arctic Bay (ABI) Series				
-20°F (-29°C) – 0°F (-18°C)			Motion Sensor Options (# of Lamps Controlled)	
Fixture	# Lamps	Lamp Type	Routine Use	Occasional Use ⁽³⁾
ABI-454T5	4 Lamp	T5HO	Not Recommended	2
ABI-554T5	5 Lamp	T5HO	Not Recommended	2
ABI-654T5	6 Lamp	T5HO	Not Recommended	2
0°F (-18°C) – 32°F (0°C)			Motion Sensor Options (# of Lamps Controlled)	
Fixture	# Lamps	Lamp Type	Routine Use ⁽¹⁾	Occasional Use ⁽²⁾
ABI-454T5	4 Lamp	T5HO	2	ALL
ABI-554T5	5 Lamp	T5HO	2	2
ABI-654T5	6 Lamp	T5HO	2	4
32°F (0°C) – 50°F (10°C)			Motion Sensor Options (# of Lamps Controlled)	
Fixture	# Lamps	Lamp Type	Routine Use ⁽¹⁾	Occasional Use ⁽²⁾
ABI-454T5	4 Lamp	T5HO	2	ALL
ABI-554T5	5 Lamp	T5HO	2	3
ABI-654T5	6 Lamp	T5HO	2	4

NOTES: ⁽¹⁾Luminaire achieves 40% or greater of relative light output at the indicated temperature in under 60 seconds. ⁽²⁾Luminaire achieves 40% to 80% of relative light output at the indicated temperature in under 7 minutes. ⁽³⁾Greater than 20 min. lamp options.

Photometrics

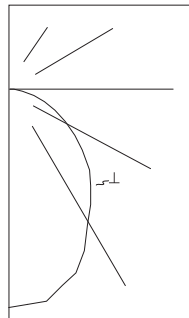

ABI-654T5-UNV-EBT2-U
Electronic Ballasts
(6) F54W T5HO lamps 5000 lumens
Spacing criterion: (II) 1.1 x mounting height
(L) 1.2 x mounting height
Efficiency 65.1%
Test Report:

Coefficients of Utilization

rc	Effective floor cavity reflectance											
	80%				50%				20%			
	70	50	30	10	50	30	10	50	30	10		
rw	70	50	30	10	50	30	10	50	30	10		
RCR	0	1	2	3	4	5	6	7	8	9	10	
	78	78	78	78	72	72	72	69	69	69		
	71	69	66	64	64	63	61	62	60	59		
	66	61	57	53	57	54	51	55	52	50		
	60	54	49	45	51	47	44	49	46	43		
	56	48	43	39	46	42	38	44	41	38		
	51	44	38	34	42	37	34	40	36	33		
	48	40	34	30	38	33	30	37	33	30		
	45	36	31	27	35	30	27	34	30	27		
	42	33	28	24	32	27	24	31	27	24		
	39	31	26	22	30	25	22	29	25	22		
	37	29	24	20	28	23	20	27	23	20		

Zonal Lumen Summary

Zone	Lumens	%Lamp	%Fixture
0-30	6856	22.9	35.1
0-40	10426	34.8	53.4
0-60	16414	54.7	84.0
0-90	19532	65.1	100.0
0-180	19532	65.1	100.0

System Performance ABI

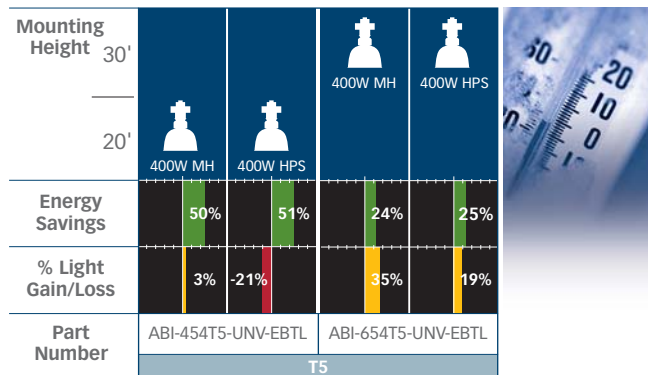

% light gain/light loss utilize S/P adjusted lumens.

System Performance Table

Arctic Bay System Comparison	No. of Lamps	Lamp Lumens	Lumen Maintenance ¹	Fixture Efficiency	Ballast Factor	Design System Lumens ²	S/P Ratio ³	Brightness Perception	S/P Adjusted Lumens ⁴	Wattage	Cost of 1000 S/P Adj Lumens - 4000 hrs \$0.06 kWh	LER ⁵
ABI-454T5-N-CL-UNV-EBTL1	4	5000	93%	73%	1.00	13578	1.90	1.38	18716	229	\$5.36	81
ABI-654T5-N-CL-UNV-EBTL2	6	5000	93%	73%	1.00	20367	1.90	1.38	28074	346	\$5.40	81
Comparison System												
400W Metal Halide High Bay	1	36000	75%	78%	1.00	21087	1.50	1.22	25826	455	\$7.22	44
400W High Pressure Sodium High Bay	1	50000	81%	71%	1.00	28755	0.62	0.79	22642	464	\$9.24	35

FOOTNOTES: ¹ Lumen maintenance is based on lamp manufacturer's stated data combined with estimated dirt depreciation. ² Design System Lumens is the fixture lumens at 40% of rated lamp life and is calculated as Quantity of Lamps x Lamp Lumens x Lumen Maintenance x Fixture Efficiency x Ballast Factor. ³ S/P Ratio is the lamp manufacturers stated Scotopic/Photopic Ratio; accepted by some lighting designers to adjust for the relative strengths of scotopic and photopic vision, not yet adopted by IESNA. ⁴ S/P Adjusted Lumens calculates the brightness perception scotopic/photopic ratio as Design System Lumens x (S/P)^{0.5} based on 5000K lamps. ⁵ LER (Luminaire Efficiency Ratio) is an accepted method of comparing fixture performance.

Dimensions

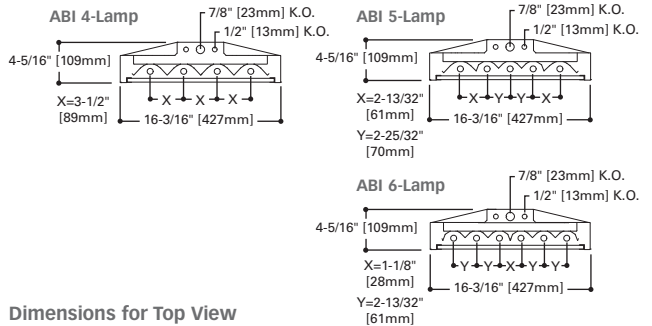

Dimensions for Top View

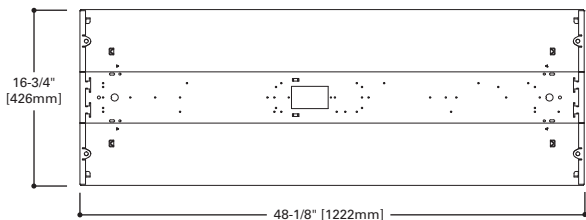

Fiberglass housing is reinforced polyester and self-extinguishing (ASTM-D635-74) plastic of a permanent pearl gray color.

Polyurethane gasketing is formed in the housing providing a continuous seamless seal for the diffuser.

High impact acrylic or 100% polycarbonate, clear, UV stabilized diffuser.

UL Listed for wet locations (standard). UL/cUL Listed, NEMA 4X, NSF Listed, IP65 and IP67 Certified.

Optional high performance 95% Specular aluminum reflector.

No holes required for chain/cable mount from supplied mounting bail. (chain/cable is supplied by others, V-hangers included with fixture)



Factory installed code compliant disconnect for safe and convenient means of disconnecting power.

LINEAR DISCONNECT

A watertite hub for 1/2" conduit entry is provided at each end of housing (standard) for continuous feed.



Sturdy stainless steel cam latches clamp diffuser tightly for a positive seal between housing, gasketing and diffuser.

Tethered gear tray for toolless access to ballast compartment and hands-free maintenance.

Ordering Information Sample Number: VT4-432-M-DR-UNV-EB81-WL-U

<p>Series VT4=Vaportite 4/6 Lamp</p>	<p>Number of Lamps 4=4 Lamps (Not Included) 6=6 Lamps (Not Included)</p>	<p>Wattage (Length) 32=32W T8 (48") 49T5=49W T5HO Lamps (48") 51T5=51W T5HO Lamps (48") 54T5=54W T5HO (48")⁽³⁾ 84VHO=84W T8VHO (48")⁽⁶⁾</p>	<p>Distribution M=Medium Beam W=Wide Beam (White)</p>	<p>Lens DR=Clear Acrylic High Impact (Standard) PC=Polycarbonate, Clear</p>	<p>Voltage⁽¹⁾ 120V=120 Volt (32W & 54W only) 277V=277 Volt 347V=347 Volt UNV=Universal Voltage 120/277^{(1), (2)} (32W & 54W only) UNC=Universal Voltage 347/480⁽²⁾</p>	<p>GL=Single Element Fuse GM=Double Element Fuse EL=Emergency Installed⁽³⁾</p>	<p>Ballast Type⁽⁴⁾ T8 Ballasts EB8 =T8 Electronic Instant Start. Total Harmonic Distortion < 10% No. of Ballast 1 or 2 EB8_/PLUS=T8 Electronic Instant Start. High Ballast Factor >1.13. Total Harmonic Distortion < 10% No. of Ballast 1 or 2 ER8 =T8 Electronic Program Rapid Start. Total Harmonic Distortion < 10% No. of Ballast 1 or 2 ER8_/PLUS=T8 Electronic Program Start. High Ballast Factor >1.15. Total Harmonic Distortion < 10% No. of Ballast 1 or 2 T5 Ballasts EHT = T5 Linear Electronic Start High Ambient. Total Harmonic Distortion < 10% No. of Ballast 1, 2 or 3 T8VHO Ballasts EV8 = T8VHO 277-480V Electronic 90°C Rated Instant Start Ballast, 10% THD No. of Ballast 2</p>	<p>WL=Wet Label</p> <p>Packaging U=Unit Pack</p> <p>Options Blank=(2) End Watertite Hubs (all Watertite Hubs have 1/2" Conduit Entry) C3=3' Power Cord C6=6' Power Cord PC3=3' Power Cord & Plug (Specify Voltage)⁽⁴⁾ PC6=6' Power Cord & Plug (Specify Voltage)⁽⁴⁾ VRS=Vandal Resistant Screws for Latches</p> <p>Accessories (order separately) Y-TOGGLE=Y Mounting Toggle, #2 Cable (Specify 10' or 30') VT4-SS-SM=(2) Stainless Steel Surface Mounting Bracket</p>
---	---	--	--	--	--	--	--	--

NOTES: ⁽¹⁾ Products also available in non-US voltages and frequencies for international markets. ⁽²⁾ Not available when specifying emergencies, voltage must be specific. Exception: EL4 ok with UNV. ⁽³⁾ Emergency ballast not available for T8VHO lamps. ⁽⁴⁾ Voltage must be specified when ordered with plugs, motion or emergency ballasts. ⁽⁵⁾ For ambients greater than 40°C (102°F), for 654T5 configuration, EHT3 is recommended. ⁽⁶⁾ Maximum 4 lamps when using T8VHO option.

Photometrics

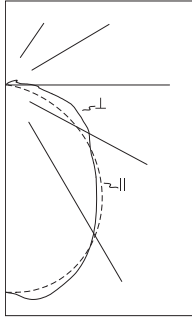

Coefficients of Utilization

rc	Effective floor cavity reflectance												
	80%				50%				20%				
rw	70	50	30	10	50	30	10	50	30	10	50	30	10
RCR													
0	100	100	100	100	92	92	92	87	87	87			
1	90	86	82	79	79	76	74	75	73	71			
2	82	75	69	64	69	65	61	66	62	59			
3	75	66	59	53	61	55	51	58	53	49			
4	69	58	51	45	54	48	43	52	47	42			
5	63	52	44	39	49	42	38	46	41	37			
6	58	47	39	34	44	38	33	42	37	32			
7	54	43	35	30	40	34	29	38	33	29			
8	50	39	32	27	37	31	26	35	30	26			
9	47	36	29	24	34	28	24	33	27	23			
10	44	33	26	22	31	25	21	30	25	21			

VT4-654T5-M-DR-UNV-EHT2-WL-U
 (2) Electronic Ballast
 (6) 54W T5HO Lamps 4400 Lumens
 Spacing criterion: (II) 1.3 x mounting height, (L) 1.2 x mounting height
 Efficiency 84.7%
 Test Report: VT4654T5M.IES

Zonal Lumen Summary

Zone	Lumens	%Lamp	%Fixture
0-30	5896	22.3	26.4
0-40	9507	36.0	42.5
0-60	16197	61.4	72.4
0-90	21214	80.4	94.9
0-180	22363	84.7	100.0

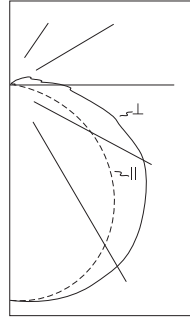

Coefficients of Utilization

rc	Effective floor cavity reflectance												
	80%				50%				20%				
rw	70	50	30	10	50	30	10	50	30	10	50	30	10
RCR													
0	99	99	99	99	91	91	91	86	86	86			
1	89	84	80	76	77	74	71	73	70	68			
2	80	73	66	61	66	61	57	60	59	55			
3	73	63	56	50	58	52	47	55	50	46			
4	66	56	48	42	51	45	40	48	43	38			
5	61	49	41	35	45	39	34	43	37	33			
6	56	44	36	31	41	34	29	39	33	29			
7	52	40	32	27	37	31	26	35	30	25			
8	48	36	29	24	34	27	23	32	27	22			
9	45	33	26	21	31	25	21	30	24	20			
10	42	31	24	19	29	23	19	27	22	18			

VT4-654T5-W-DR-UNV-EHT2-WL-U
 (2) Electronic Ballast
 (6) 54W T5 Lamps 4400 Lumens
 Spacing criterion: (II) 1.2 x mounting height, (L) 1.5 x mounting height
 Efficiency 84.7%
 Test Report: VT4654T5W.IES

Zonal Lumen Summary

Zone	Lumens	%Lamp	%Fixture
0-30	4729	17.9	21.1
0-40	7935	30.1	35.5
0-60	14805	56.1	66.2
0-90	20797	78.8	93.0
0-180	22369	84.7	100.0

Dimensions

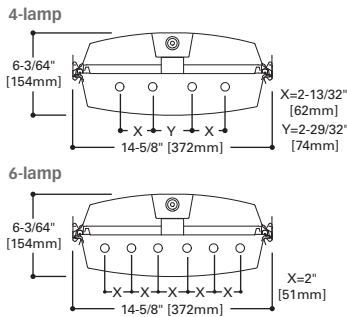

Dimensions for Top View

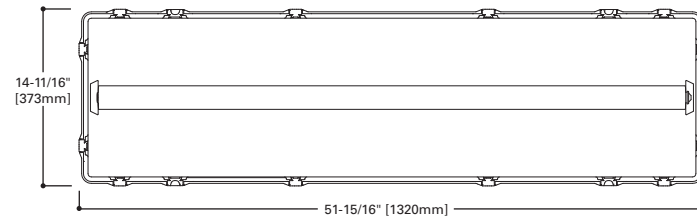

System Performance

VT4

Lamp Type	400W MH		400W HPS	
	Energy Savings	51%	52%	
% Light Gain/Loss	1%	-23%	39%	24%
Part Number	VT4-632-M		VT4-654-M	
	T8		T5	

% light gain/light loss utilize S/P adjusted lumens.

System Performance Table

VT4 System Comparison	No. of Lamps	Lamp Lumens	Lumen Maintenance ¹	Fixture Efficiency	Ballast Factor	Design System Lumens ²	S/P Ratio ³	Brightness Perception	S/P Adjusted Lumens ⁴	Wattage	Cost of 1000 S/P Adj Lumens - 4000 hrs @ 0.06 kWh	LER ⁵
VT4-632-M	6	3100	94%	69%	1.20	14477	1.95	1.40	20267	221	\$5.06	91
VT4-654-M	6	5000	93%	85%	1.00	23715	1.90	1.38	32689	346	\$3.98	94
Comparison System												
400W Metal Halide High Bay	1	36000	75%	78%	1.00	21087	1.50	1.22	25826	455	\$7.22	44
400W High Pressure Sodium High Bay	1	50000	81%	78%	1.00	31631	0.62	0.79	24906	464	\$7.63	42

FOOTNOTES: ¹ Lumen maintenance is based on lamp manufacturer's stated data combined with estimated dirt depreciation. ² Design System Lumens is the fixture lumens at 40% of rated lamp life and is calculated as Quantity of Lamps x Lamp Lumens x Lumen Maintenance x Fixture Efficiency x Ballast Factor. ³ S/P Ratio is the lamp manufacturer's stated Scotopic/Photopic Ratio; accepted by some lighting designers to adjust for the relative strengths of scotopic and photopic vision, not yet adopted by IESNA. ⁴ S/P Adjusted Lumens calculates the brightness perception scotopic/photopic ratio as Design System Lumens x (S/P)^{0.5} based on 5000K lamps. ⁵ LER (Luminaire Efficiency Ratio) is an accepted method of comparing fixture performance.

Sealed and gasketed enclosure utilizes internal heat for optimal performance in ambient environments down to -20°F (-29°C).

Durable fiberglass housing is reinforced polyester and self-extinguishing (ASTM-D635-74) plastic of a permanent pearl gray color.

Polyurethane gasketing is formed in the housing providing a continuous seamless seal for the diffuser.

High impact lens options to withstand the most demanding environments.

UL Listed for wet locations (standard).
UL/CUL Listed. IP65 rated.
Optional IP67 rating with 8 latches. NSF listed.

Applications include holding freezers, refrigerated storage, walk-in freezers, food processing and outdoor locations.

Surface or chain mount from supplied mounting bracket. (chain supplied by others)



A watertite hub for 1/2" conduit entry is provided at each end of housing (standard) for continuous feed.

Sturdy cam latches clamp diffuser tightly for a positive seal between housing, gasketing and diffuser.

Tethered gear tray for tool-less access to ballast compartment and hands-free maintenance.

Optional die formed high reflective polyester powder coat or high performance 95% specular reflector.



Factory installed code compliant disconnect for safe and convenient means of disconnecting power.

LINEAR DISCONNECT

Ordering Information Sample Number: 8TVT3-254T5DR-UNV-EB82-M4-U

<p>Width Blank=4' Length 8T=8' Length</p>	<p>Voltage⁽¹⁾ 120V=120 Volt 277V=277 Volt 347V=347 Volt 480V=480 Volt UNV=Universal Voltage 120/277V UNC=Universal Voltage 347/480V⁽⁶⁾</p>	<p>Ballast Type⁽¹⁾ T8 Systems EB8 =T8 Electronic Instant Start.⁽⁴⁾ Total Harmonic Distortion < 10% No. of Ballast 1 or 2 EB8 /PLUS=T8 Electronic Instant Start.^{(4), (6)} High Ballast Factor >1.15. Total Harmonic Distortion < 10% No. of Ballast 1 or 2 ER8 =T8 Electronic Program Rapid Start.⁽⁴⁾ Total Harmonic Distortion < 10% No. of Ballast 1 or 2 ER8 /PLUS=T8 Electronic Program Start.⁽⁴⁾ High Ballast Factor >1.15. Total Harmonic Distortion < 10% No. of Ballast 1 or 2 T5 Systems EBT =T5 Linear Electronic Program Rapid Start. Total Harmonic Distortion < 10% No. of Ballast 1 or 2 EHT =T5HO Linear Electronic Program Rapid Start High Ambient. Total Harmonic Distortion < 10% No. of Ballast^{(5), (7)} 1 or 2</p>	<p>WL=Wet Location Label</p>	<p>Options 8L=8 Latches (IP67 Rating), (4' only) RIF1=Radio Interference Suppressor TH=(2) Top Watertite Hubs⁽⁵⁾ TEH=(2) Top & (2) End Watertite Hubs (all Watertite Hubs have 1/2" Conduit Entry)⁽⁵⁾ BKS=(2) Snap-on Brackets for Stem or Surface Mount M4=Specular Reflector SSL=Stainless Steel Latches VRS=Vandal Resistant Screws for Latches</p>	<p>Packaging U=Unit Pack PALC=Job Pack in Carton</p>
<p>Series VT3=Vaportite (Gasketed Enclosure)</p>	<p>Options GL=Single Element Fuse GM=Double Element Fuse EL=Emergency Installed^{(3), (4)} (see table on pg. 48)</p>	<p>Accessories (order separately) VT2 Stem Bushing=1/2" - 3/8" (Required when using Stem/Sets, Requires (1) per (Stem/Set) VT2-Chain/Set-U=Chain Hanging Set Includes 6 ft. of chain, 4 large S-Hooks and 4 small S-Hooks. Order Two (2) Kits for each 4' or 8' Fixture VT2-SS-MBK=Stainless Steel Mounting Bracket VT3-BKS2-PK=(2) Snap-on Brackets for Stem, Surface or Chain Mount. Adjustable along length of fixture.</p>	<p>Accessories (order separately) VT2 Stem Bushing=1/2" - 3/8" (Required when using Stem/Sets, Requires (1) per (Stem/Set) VT2-Chain/Set-U=Chain Hanging Set Includes 6 ft. of chain, 4 large S-Hooks and 4 small S-Hooks. Order Two (2) Kits for each 4' or 8' Fixture VT2-SS-MBK=Stainless Steel Mounting Bracket VT3-BKS2-PK=(2) Snap-on Brackets for Stem, Surface or Chain Mount. Adjustable along length of fixture.</p>	<p>Accessories (order separately) VT2 Stem Bushing=1/2" - 3/8" (Required when using Stem/Sets, Requires (1) per (Stem/Set) VT2-Chain/Set-U=Chain Hanging Set Includes 6 ft. of chain, 4 large S-Hooks and 4 small S-Hooks. Order Two (2) Kits for each 4' or 8' Fixture VT2-SS-MBK=Stainless Steel Mounting Bracket VT3-BKS2-PK=(2) Snap-on Brackets for Stem, Surface or Chain Mount. Adjustable along length of fixture.</p>	
<p>Number of Lamps⁽³⁾ 1=1 Lamp 2=2 Lamps 3=3 Lamps (Lamps not included)</p>	<p>Lamp Type 32=32W T8 Lamp 28T5=28W T5 Lamp 54T5=54W T5HO Lamp⁽³⁾</p>	<p>Notes: (1)Ballast type used only if ballast & voltage is chosen. (2)Not available when specifying emergency ballasts, voltage must be specific. (3) EHT2 ballasts are recommended for ambient temperatures above 102°F (40°C) 3 Lamp 54W T5HO configurations. (4)Emergency option in 3 lamp version must use remote mount test switch. (5)Top Hub required when stem mounting. (6)2/3 lamp ballast configurations in EB8/PLUS only for T8 UNC version. (7)Use EHT1 ballast in ambient temperatures below 0°F (-18°C) on 3 Lamp 54W T5HO configurations.</p>	<p>Accessories (order separately) VT2 Stem Bushing=1/2" - 3/8" (Required when using Stem/Sets, Requires (1) per (Stem/Set) VT2-Chain/Set-U=Chain Hanging Set Includes 6 ft. of chain, 4 large S-Hooks and 4 small S-Hooks. Order Two (2) Kits for each 4' or 8' Fixture VT2-SS-MBK=Stainless Steel Mounting Bracket VT3-BKS2-PK=(2) Snap-on Brackets for Stem, Surface or Chain Mount. Adjustable along length of fixture.</p>	<p>Accessories (order separately) VT2 Stem Bushing=1/2" - 3/8" (Required when using Stem/Sets, Requires (1) per (Stem/Set) VT2-Chain/Set-U=Chain Hanging Set Includes 6 ft. of chain, 4 large S-Hooks and 4 small S-Hooks. Order Two (2) Kits for each 4' or 8' Fixture VT2-SS-MBK=Stainless Steel Mounting Bracket VT3-BKS2-PK=(2) Snap-on Brackets for Stem, Surface or Chain Mount. Adjustable along length of fixture.</p>	
<p>Lens DR=Internal Prismatic Lens/15% DR High Impact Additive (Standard) DR-50=50% High Impact Additive DR-100%=100% High Impact Additive (Extreme)</p>	<p>Lens DR=Internal Prismatic Lens/15% DR High Impact Additive (Standard) DR-50=50% High Impact Additive DR-100%=100% High Impact Additive (Extreme)</p>	<p>Notes: (1)Ballast type used only if ballast & voltage is chosen. (2)Not available when specifying emergency ballasts, voltage must be specific. (3) EHT2 ballasts are recommended for ambient temperatures above 102°F (40°C) 3 Lamp 54W T5HO configurations. (4)Emergency option in 3 lamp version must use remote mount test switch. (5)Top Hub required when stem mounting. (6)2/3 lamp ballast configurations in EB8/PLUS only for T8 UNC version. (7)Use EHT1 ballast in ambient temperatures below 0°F (-18°C) on 3 Lamp 54W T5HO configurations.</p>	<p>Notes: (1)Ballast type used only if ballast & voltage is chosen. (2)Not available when specifying emergency ballasts, voltage must be specific. (3) EHT2 ballasts are recommended for ambient temperatures above 102°F (40°C) 3 Lamp 54W T5HO configurations. (4)Emergency option in 3 lamp version must use remote mount test switch. (5)Top Hub required when stem mounting. (6)2/3 lamp ballast configurations in EB8/PLUS only for T8 UNC version. (7)Use EHT1 ballast in ambient temperatures below 0°F (-18°C) on 3 Lamp 54W T5HO configurations.</p>	<p>Notes: (1)Ballast type used only if ballast & voltage is chosen. (2)Not available when specifying emergency ballasts, voltage must be specific. (3) EHT2 ballasts are recommended for ambient temperatures above 102°F (40°C) 3 Lamp 54W T5HO configurations. (4)Emergency option in 3 lamp version must use remote mount test switch. (5)Top Hub required when stem mounting. (6)2/3 lamp ballast configurations in EB8/PLUS only for T8 UNC version. (7)Use EHT1 ballast in ambient temperatures below 0°F (-18°C) on 3 Lamp 54W T5HO configurations.</p>	
<p>Notes: (1)Ballast type used only if ballast & voltage is chosen. (2)Not available when specifying emergency ballasts, voltage must be specific. (3) EHT2 ballasts are recommended for ambient temperatures above 102°F (40°C) 3 Lamp 54W T5HO configurations. (4)Emergency option in 3 lamp version must use remote mount test switch. (5)Top Hub required when stem mounting. (6)2/3 lamp ballast configurations in EB8/PLUS only for T8 UNC version. (7)Use EHT1 ballast in ambient temperatures below 0°F (-18°C) on 3 Lamp 54W T5HO configurations.</p>	<p>Notes: (1)Ballast type used only if ballast & voltage is chosen. (2)Not available when specifying emergency ballasts, voltage must be specific. (3) EHT2 ballasts are recommended for ambient temperatures above 102°F (40°C) 3 Lamp 54W T5HO configurations. (4)Emergency option in 3 lamp version must use remote mount test switch. (5)Top Hub required when stem mounting. (6)2/3 lamp ballast configurations in EB8/PLUS only for T8 UNC version. (7)Use EHT1 ballast in ambient temperatures below 0°F (-18°C) on 3 Lamp 54W T5HO configurations.</p>	<p>Notes: (1)Ballast type used only if ballast & voltage is chosen. (2)Not available when specifying emergency ballasts, voltage must be specific. (3) EHT2 ballasts are recommended for ambient temperatures above 102°F (40°C) 3 Lamp 54W T5HO configurations. (4)Emergency option in 3 lamp version must use remote mount test switch. (5)Top Hub required when stem mounting. (6)2/3 lamp ballast configurations in EB8/PLUS only for T8 UNC version. (7)Use EHT1 ballast in ambient temperatures below 0°F (-18°C) on 3 Lamp 54W T5HO configurations.</p>	<p>Notes: (1)Ballast type used only if ballast & voltage is chosen. (2)Not available when specifying emergency ballasts, voltage must be specific. (3) EHT2 ballasts are recommended for ambient temperatures above 102°F (40°C) 3 Lamp 54W T5HO configurations. (4)Emergency option in 3 lamp version must use remote mount test switch. (5)Top Hub required when stem mounting. (6)2/3 lamp ballast configurations in EB8/PLUS only for T8 UNC version. (7)Use EHT1 ballast in ambient temperatures below 0°F (-18°C) on 3 Lamp 54W T5HO configurations.</p>	<p>Notes: (1)Ballast type used only if ballast & voltage is chosen. (2)Not available when specifying emergency ballasts, voltage must be specific. (3) EHT2 ballasts are recommended for ambient temperatures above 102°F (40°C) 3 Lamp 54W T5HO configurations. (4)Emergency option in 3 lamp version must use remote mount test switch. (5)Top Hub required when stem mounting. (6)2/3 lamp ballast configurations in EB8/PLUS only for T8 UNC version. (7)Use EHT1 ballast in ambient temperatures below 0°F (-18°C) on 3 Lamp 54W T5HO configurations.</p>	



Photometrics

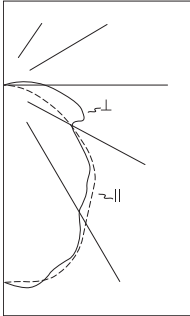

Coefficients of Utilization

rc	Effective floor cavity reflectance												
	80%				50%				20%				
rw	70	50	30	10	50	30	10	50	30	10	50	30	10
RCR													
0	85	85	85	85	78	78	78	75	75	75	75	75	75
1	77	74	70	67	68	66	63	65	63	61	65	63	61
2	70	64	59	55	60	56	53	57	54	51	57	54	51
3	65	57	51	46	53	49	45	51	47	44	51	47	44
4	59	51	44	40	47	42	38	45	41	38	45	41	38
5	54	45	39	34	42	37	33	40	36	32	40	36	32
6	50	41	34	30	38	33	29	37	32	28	37	32	28
7	46	37	30	26	34	29	25	33	28	25	33	28	25
8	43	33	27	23	31	26	22	30	25	22	30	25	22
9	39	30	24	20	28	23	19	27	22	19	27	22	19
10	37	27	21	17	26	21	17	25	20	17	25	20	17

VT3-254T5DR-UNV-EB81-WL-M4-U

Electronic Ballast
 (2) 54WT5HO/835 lamps 4400 lumens
 Spacing criterion: (H) 1.2 x mounting height,
 (L) 1.1 x mounting height
 Efficiency 72%
 Test Report: VT3-254T5DR-M4.IES

Zonal Lumen Summary

Zone	Lumens	%Lamp	%Fixture
0-30	1711	19.4	27.0
0-40	2691	30.6	42.5
0-60	4531	51.5	71.5
0-90	6093	69.2	96.1
0-180	6338	72.1	100.0

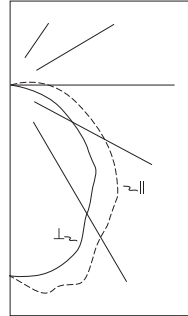

Coefficients of Utilization

rc	Effective floor cavity reflectance												
	80%				50%				20%				
rw	70	50	30	10	50	30	10	50	30	10	50	30	10
RCR													
0	91	91	91	91	84	84	84	80	80	80	80	80	80
1	83	79	76	73	73	71	68	70	68	66	70	68	66
2	76	69	64	59	64	60	56	61	58	55	61	58	55
3	69	61	55	50	57	52	48	54	50	47	54	50	47
4	63	54	47	42	51	45	41	48	44	40	48	44	40
5	58	48	41	35	45	39	34	43	38	34	43	38	34
6	53	43	36	31	40	34	30	38	33	29	38	33	29
7	49	38	31	26	36	30	26	35	29	25	35	29	25
8	45	34	27	23	32	26	22	31	26	22	31	26	22
9	41	31	24	20	29	23	19	28	23	19	28	23	19
10	38	28	22	17	26	21	17	25	20	17	25	20	17

VT3-332DR-UNV-EB81-WL-M4-U

Electronic Ballasts
 (3) F32T8/835/RS lamps 2950 lumens
 Spacing criterion: (H) 1.4 x mounting height,
 (L) 1.4 x mounting height
 Efficiency 75%
 Test Report: VT3-332DR-M4.IES

Zonal Lumen Summary

Zone	Lumens	%Lamp	%Fixture
0-30	1677	18.9	24.5
0-40	2729	30.8	39.8
0-60	4910	55.5	71.7
0-90	6602	74.6	96.4

Dimensions

VT3 Lamp Configurations

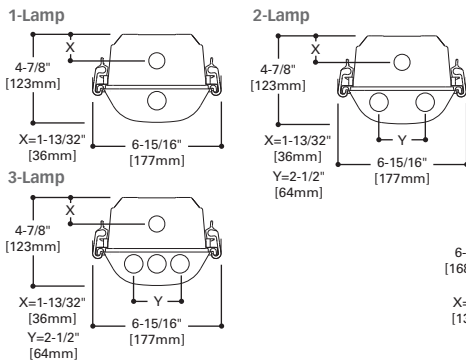

Dimensions – Top View

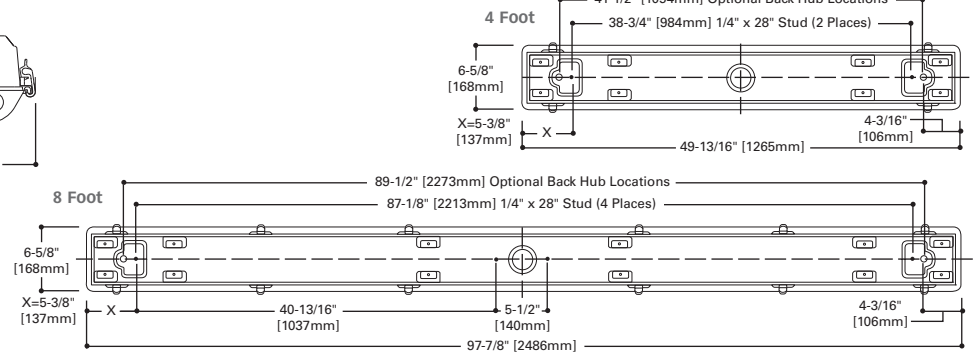

System Performance

VT3

Lamp Type	175 MH	150W HPS	175 MH	150W HPS	100 MH	100W HPS
Energy Savings	54%	48%	69%	65%	57%	57%
% Light Gain/Loss	32%	41%	18%	29%	9%	23%
Part Number	VT3-254T5-UNV-EBT1-M4 T5		VT3-232-EBT1/PLUS-M4 T8		VT3-232DR-EB81-M4 T8	

% light gain/light loss utilize S/P adjusted lumens.

System Performance Table

VT4 System Comparison	No. of Lamps	Lamp Lumens	Lumen Maintenance ¹	Fixture Efficiency	Ballast Factor	Design System Lumens ²	S/P Ratio ³	Brightness Perception	S/P Adjusted Lumens ⁴	Wattage	Cost of 1000 S/P Adj Lumens - 4000 hrs @ 0.08 kWh	LER ⁵
VT3-254T5-UNV-EBT2-M4	2	5000	93%	72%	1.00	6294	1.90	1.38	8686	97	\$4.96	89
VT3-232-EB81/PLUS-M4	2	3100	94%	77%	1.15	5136	1.95	1.40	7172	65	\$3.77	110
VT3-332-EB81/PLUS-M4	3	3100	94%	75%	1.15	7350	1.95	1.40	10263	101	\$4.20	101
Comparison System												
175W Metal Halide Garage Light	1	13600	58%	70%	1.00	5474	1.50	1.22	6705	213	\$14.52	22
150W High Pressure Sodium Garage Light	1	12900	81%	70%	1.00	7335	0.62	0.79	5776	188	\$14.88	22

FOOTNOTES: ¹ Lumen maintenance is based on lamp manufacturer's stated data combined with estimated dirt depreciation. ² Design System Lumens is the fixture lumens at 40% of rated lamp life and is calculated as Quantity of Lamps x Lamp Lumens x Lumen Maintenance x Fixture Efficiency x Ballast Factor. ³ S/P Ratio is the lamp manufacturers stated Scotopic/Photopic Ratio; accepted by some lighting designers to adjust for the relative strengths of scotopic and photopic vision, not yet adopted by IESNA. ⁴ S/P Adjusted Lumens calculates the brightness perception scotopic/photopic ratio as Design System Lumens x (S/P)^{0.5} based on 5000K lamps. ⁵ LER (Luminaire Efficiency Ratio) is an accepted method of comparing fixture performance.

Two stainless steel brackets and chain mount bail included. Adjustable along length of fixture for variable mounting centers. No holes required. (chain or cable provided by others).



A watertite hub for 1/2" conduit entry is provided at each end of housing (standard) for continuous feed.



Fiberglass housing is reinforced polyester and self-extinguishing (ASTM-D635-74) plastic of a permanent pearl gray color.

Polyurethane gasketing is formed in the housing providing a continuous seamless seal for the diffuser.

Factory installed code compliant disconnect for safe and convenient means of disconnecting power.

LINEAR DISCONNECT

Sturdy cam latches clamp diffuser tightly for a positive seal between housing, gasketing and diffuser.

Unit has full metal gear tray secured by internal fasteners and tethers providing maximum protection and rigidity.

High impact lens to withstand the most demanding environments

UL Listed for wet locations (standard). UL/cUL Listed. NSF listed, IP65 certified.

Ordering Information Sample Number: VT1-154T5-PCR-UNV-EB81-WL-U

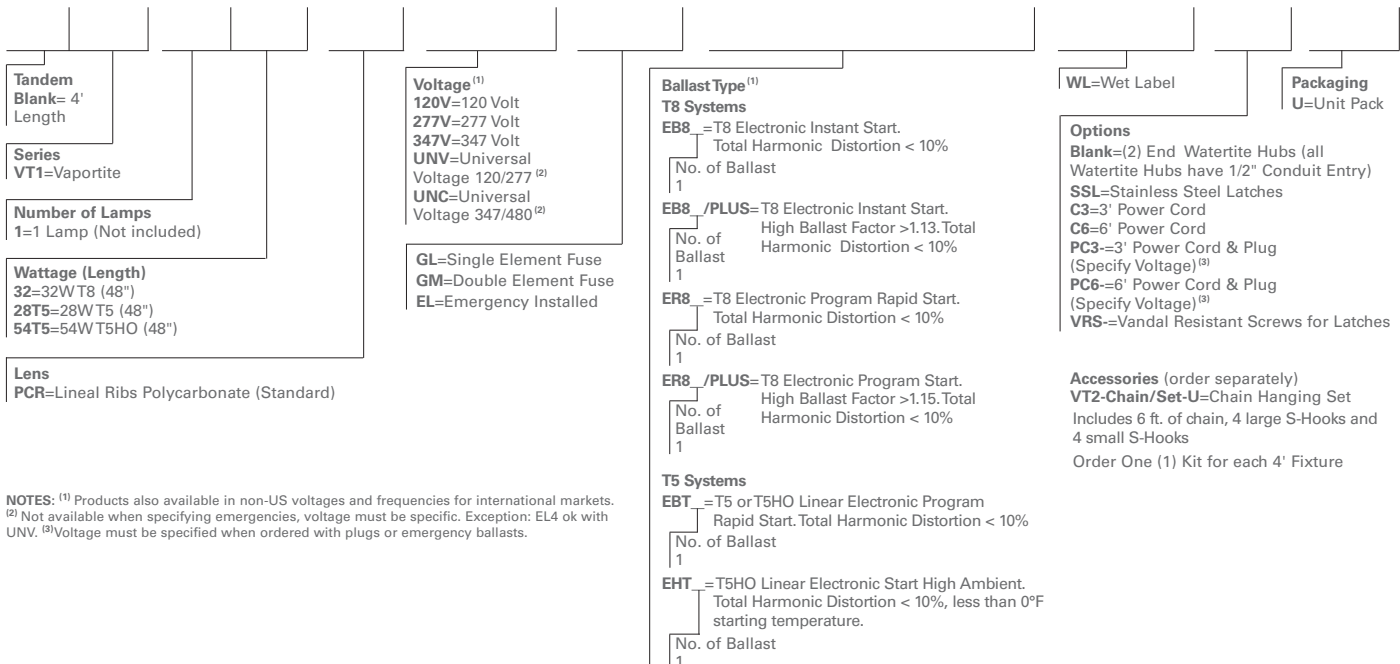

NOTES: ⁽¹⁾ Products also available in non-US voltages and frequencies for international markets. ⁽²⁾ Not available when specifying emergencies, voltage must be specific. Exception: EL4 ok with UNV. ⁽³⁾ Voltage must be specified when ordered with plugs or emergency ballasts.

Photometrics

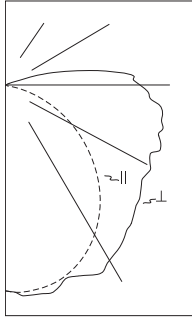

Coefficients of Utilization

rc	Effective floor cavity reflectance												
	80%				50%				20%				
rw	70	50	30	10	50	30	10	50	30	10	50	30	10
RCR													
0	90	90	90	90	82	82	82	76	76	76			
1	79	74	70	65	66	63	60	62	59	57			
2	71	63	56	51	57	52	47	53	49	45			
3	64	54	47	41	49	43	38	46	41	37			
4	58	48	40	34	43	37	32	40	35	31			
5	53	42	35	29	38	32	27	36	31	26			
6	49	38	30	25	34	28	24	32	27	23			
7	45	34	27	22	31	25	21	29	24	20			
8	42	31	24	19	29	23	18	27	22	18			
9	39	29	22	17	26	20	17	25	20	16			
10	37	26	20	16	24	19	15	23	18	14			

VT1-154T5-PCR-UNV-EBT1-WL-U
 Electronic Ballast
 (1) 54W T5HO Lamp 4400 Lumens
 Spacing criterion: (II) 1.3 x mounting height, (L) 1.5 x mounting height
 Efficiency 77.6%
 Test Report: VT154T5PCR.IES

Zonal Lumen Summary

Zone	Lumens	%Lamp	%Fixture
0-30	609	13.8	17.8
0-40	1019	23.2	29.9
0-60	1901	43.2	55.7
0-90	3047	69.2	89.3
0-180	3413	77.6	100.0

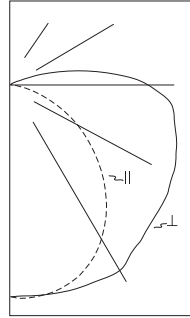

Coefficients of Utilization

rc	Effective floor cavity reflectance												
	80%				50%				30%				
rw	70	50	30	10	50	30	10	50	30	10	50	30	10
RCR													
0	87	87	87	87	79	79	79	74	74	74			
1	76	71	67	63	64	61	58	60	57	55			
2	68	60	54	49	54	50	45	51	47	43			
3	61	52	45	39	47	41	37	44	39	35			
4	56	46	38	33	41	35	31	39	34	30			
5	51	41	33	28	37	31	26	34	29	25			
6	47	36	29	24	33	27	23	31	26	22			
7	44	33	26	21	30	24	20	28	23	19			
8	40	30	23	18	27	22	18	26	21	17			
9	38	27	21	16	25	20	16	24	19	15			
10	35	25	19	15	23	18	14	22	17	14			

VT1-132-PCR-UNV-EB81-WL-U
 Electronic Ballast
 (1) 32W T8 Lamp 2850 Lumens
 Spacing criterion: (II) 1.3 x mounting height, (L) 1.5 x mounting height
 Efficiency 74.4%
 Test Report: VT132PCR.IES

Zonal Lumen Summary

Zone	Lumens	%Lamp	%Fixture
0-30	372	13.0	17.5
0-40	625	21.9	29.5
0-60	1186	41.4	56.0
0-90	1912	67.1	90.2
0-180	2120	74.4	100.0

Dimensions

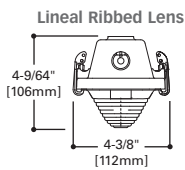

Dimensions for Top View

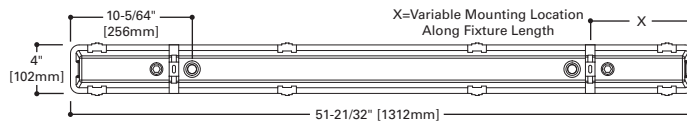

System Performance

VT1

Lamp Type	70 MH		100W MH	
	Energy Savings	60%	72%	40%
% Light Gain/Loss	15%	-22%	40%	14%
Part Number	VT1-132 T8		VT1-154 T5	

% light gain/light loss utilize S/P adjusted lumens.

System Performance Table

VT1 System Comparison	No. of Lamps	Lamp Lumens	Lumen Maintenance ¹	Fixture Efficiency	Ballast Factor	Design System Lumens ²	S/P Ratio ³	Brightness Perception	S/P Adjusted Lumens ⁴	Wattage	Cost of 1000 S/P Adj Lumens - 4000 hrs 50.00 kWh	LER ⁵
VT1-132	1	3100	94%	74%	1.15	2840	1.95	1.40	3463	36	\$4.50	96
VT1-154	1	5000	93%	77%	1.00	3581	1.90	1.38	4935	54	\$4.55	91
Comparison System												
70W Metal Halide Canopy	1	5300	58%	78%	1.00	2398	1.50	1.22	2937	90	\$12.57	25
100W Metal Halide Canopy	1	8500	81%	78%	1.00	5370	0.62	0.79	4229	129	\$12.52	26

FOOTNOTES: ¹ Lumen maintenance is based on lamp manufacturer's stated data combined with estimated dirt depreciation. ² Design System Lumens is the fixture lumens at 40% of rated lamp life and is calculated as Quantity of Lamps x Lamp Lumens x Lumen Maintenance x Fixture Efficiency x Ballast Factor. ³ S/P Ratio is the lamp manufacturers stated Scotopic/Photopic Ratio; accepted by some lighting designers to adjust for the relative strengths of scotopic and photopic vision, not yet adopted by IESNA. ⁴ S/P Adjusted Lumens calculates the brightness perception scotopic/photopic ratio as Design System Lumens x (S/P)^{0.5} based on 5000K lamps. ⁵ LER (Luminaire Efficiency Ratio) is an accepted method of comparing fixture performance.

Options & Accessories

Lamp Options

Brand	Lamp	HBI	HBE	I5	I8	MBF ⁽¹⁾	HBL	HBG	HBHD	HBHT	ABI	VT4 ⁽¹⁾	VT3 ⁽¹⁾	VT1 ⁽¹⁾	
Generic	L8730 or L8830	X	X		X	X	X	X	X	X		X	X	X	
	L8735 or L8835	X	X		X	X	X	X	X	X		X	X	X	
	L8741 or L8841	X	X		X	X	X	X	X	X		X	X	X	
	L5830	X	X	X		X	X	X	X	X	X	X	X	X	
	L5835	X	X	X		X	X	X	X	X	X	X	X	X	
	L5841	X	X	X		X	X	X	X	X	X	X	X	X	
GE	LGSP30M/OC8 (GE)	X	X		X	X	X	X	X	X		X	X	X	
	LGSP35M/OC8 (GE)	X	X		X	X	X	X	X	X		X	X	X	
	LGSP41M/OC8 (GE)	X	X		X	X	X	X	X	X		X	X	X	
	LGSPX30M/OC8 (GE)	X	X		X	X	X	X	X	X		X	X	X	
	LGSPX35M/OC8 (GE)	X	X		X	X	X	X	X	X		X	X	X	
	LGSPX41M/OC8 (GE)	X	X		X	X	X	X	X	X		X	X	X	
	LGF28T5M/830 (GE)	X		X				X	X	X			X	X	
	LGF28T5M/835 (GE)	X		X				X	X	X			X	X	
	LGF28T5M/841 (GE)	X		X				X	X	X			X	X	
	LGF51T5WM/830	X	X	X		X	X	X	X	X	X	X	X	X	X
	LGF51T5WM/835	X	X	X		X	X	X	X	X	X	X	X	X	X
	LGF51T5WM/841	X	X	X		X	X	X	X	X	X	X	X	X	X
	LGF54T5M/830 (GE)	X	X	X		X	X	X	X	X	X	X	X	X	X
	LGF54T5M/835 (GE)	X	X	X		X	X	X	X	X	X	X	X	X	X
	LGF54T5M/841 (GE)	X	X	X		X	X	X	X	X	X	X	X	X	X
	Philips	LWF32T8M/TL730 (Philips)	X				X		X	X	X		X	X	X
LWF32T8M/TL735 (Philips)		X				X		X	X	X		X	X	X	
LWF32T8M/TL741 (Philips)		X				X		X	X	X	X				
LWF32T8M/TL830 (Philips)		X			X	X		X	X	X		X	X	X	
LWF32T8M/TL835 (Philips)		X			X	X		X	X	X		X	X	X	
LWF32T8M/TL841 (Philips)		X			X	X		X	X	X		X	X	X	
LWF28T5M/830 (Philips)		X		X				X	X	X			X	X	
LWF28T5M/835 (Philips)		X		X				X	X	X			X	X	
LWF28T5M/841 (Philips)		X		X				X	X	X			X	X	
LWF49T5M/830 (Philips)		X	X	X		X	X	X	X	X	X	X	X	X	X
LWF49T5M/835 (Philips)		X	X	X		X	X	X	X	X	X	X	X	X	X
LWF49T5M/841 (Philips)		X	X	X		X	X	X	X	X	X	X	X	X	X
LWF54T5M/830 (Philips)		X	X	X		X	X	X	X	X	X	X	X	X	X
LWF54T5M/835 (Philips)		X	X	X		X	X	X	X	X	X	X	X	X	X
LWF54T5M/841 (Philips)	X	X	X		X	X	X	X	X	X	X	X	X	X	
Sylvania	LSFO32M/730K (OSI)	X	X		X	X	X	X	X	X		X	X	X	
	LSFO32M/735K (OSI)	X	X		X	X	X	X	X	X		X	X	X	
	LSFO32M/741K (OSI)	X	X		X	X	X	X	X	X		X	X	X	
	LSFO32M/830K (OSI)	X	X		X	X	X	X	X	X		X	X	X	
	LSFO32M/835K (OSI)	X	X		X	X	X	X	X	X		X	X	X	
	LSFO32M/841K (OSI)	X	X		X	X	X	X	X	X		X	X	X	
	LSF28T5M/835 (OSI)	X		X				X	X	X			X	X	
	LSF28T5M/841 (OSI)	X		X				X	X	X			X	X	
	LSF51T5M/830 (OSI)	X	X	X		X	X	X	X	X	X	X	X	X	X
	LSF51T5M/835 (OSI)	X	X	X		X	X	X	X	X	X	X	X	X	X
	LSF51T5M/841 (OSI)	X	X	X		X	X	X	X	X	X	X	X	X	X
	LSF54T5M/830 (OSI)	X	X	X		X	X	X	X	X	X	X	X	X	X
	LSF54T5M/835 (OSI)	X	X	X		X	X	X	X	X	X	X	X	X	X
	LSF54T5M/841 (OSI)	X	X	X		X	X	X	X	X	X	X	X	X	X

NOTES: ⁽¹⁾Lamps supplied, not installed.

Emergency Options

Nomenclature	Description	HBI	HBE	I5	I8	MBF	HBL	HBG	HBHD	HBHT	VT4	VT3	ABI
Generic	EL4 (350-450 lm)	X	X	X	X	X	X	X	X	X	X	X	
	EL8 (600-700 lm)	X	X	X	X	X	X	X	X	X	X	X	
Sure-Lites	EL-FBP140X (350-450 lm)	X	X		X	X	X	X	X	X	X	X	
	EL-FBP240U (600-700 lm)	X	X		X	X	X	X	X	X	X	X	
	EL-FBP240M (600-700 lm)	X	X		X	X	X	X	X	X	X	X	
	EL-FBP240H (1100-1400 lm)	X	X		X	X	X	X	X	X	X	X	
Bodine	EL-B100 (350-450 lm)	X	X		X	X	X	X	X	X	X	X	
	EL-B90 (500-600 lm)	X	X		X	X	X	X	X	X	X	X	
	EL-B70A (600-700 lm)	X	X		X	X	X	X	X	X	X	X	
	EL-B60 (600-700 lm)	X	X		X	X	X	X	X	X	X	X	
	EL-B60U (600-700 lm)	X	X		X	X	X	X	X	X	X	X	
	EL-B50 (1100-1400 lm) ⁽¹⁾	X	X		X	X	X	X	X	X	X	X	
	EL-B50U (1100-1400 lm) ⁽¹⁾	X	X		X	X	X	X	X	X	X	X	
	EL-B50ST (1100-1400 lm) ⁽¹⁾	X	X		X	X	X	X	X	X	X	X	
	EL-B50RCT (1100-1400 lm) ⁽¹⁾	X	X		X	X	X	X	X	X	X	X	
Iota	EL-I32 (up to 550 lm)	X	X	X	X	X	X	X	X	X	X	X	
	EL-I40 (up to 700 lm)	X	X		X	X	X	X	X	X	X	X	
	EL-I48 (up to 700 lm)	X	X		X	X	X	X	X	X	X	X	
	EL-I320 (1300 lm) ⁽¹⁾	X	X	X	X	X	X	X	X	X	X	X	
	EL-I880 (2000 lm) ⁽¹⁾	X	X	X	X	X	X	X	X	X	X	X	
	EL-I232 (2 @ 1400 lm)	X	X	X	X	X	X	X	X	X	X	X	
	EL-ISD80 (1300 lm) ^{(1) (2)}	X	X	X	X	X	X	X	X	X	X	X	
	EL-I40DL (up to 700 lm) ⁽²⁾	X	X	X	X	X	X	X	X	X	X	X	
	EL-I48DL (up to 700 lm) ⁽²⁾	X	X	X	X	X	X	X	X	X	X	X	
	EL-I80DL (1300 lm) ⁽²⁾	X	X	X	X	X	X	X	X	X	X	X	
EL-I232DL (2 @ 1400 lm) ⁽²⁾	X	X	X	X	X	X	X	X	X	X	X		

NOTES: ⁽¹⁾For battery wired to two lamps, specify "/2L" after battery description. ⁽²⁾Approved for wet location listing

F-Bay Mounting Accessories

Fixture Series	AYC	HB/AYC	TCB/RH-1 FH-1 FL-1	SPM/RH-1 FH-1 FL-1	Single Toggle	"Y" Toggle	Loop Hanger
HBI		X		X		X	
HBE		X		X		X	
HBL		X		X		X	
I5	X		X		X		X
I8	X		X		X		X
ABI		X		X		X	
MBF	X				X	X ⁽³⁾	
VT1							X
VT4						X	

NOTES: ⁽³⁾Continuous row mount only between fixtures.

Packaging Options

Nomenclature	Description	HBI	HBE	I5	I8	MBF	HBL	HBG	HBHD	HBHT	ABI	VT4	VT3	VT1
U	Unit Pack	X	X	X	X	X	X	X	X	X	X	X	X	X
PAL	Palletized out of carton on a 25" x 48" pallet, shrink wrapped	X	X	X	X		X	X	X	X	X			
PALC	Palletized in carton on a 25" x 48" pallet, shrink wrapped	X	X	X	X		X	X	X	X	X	X	X	X

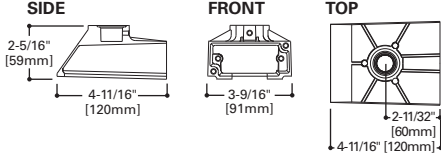

Options & Accessories

Mounting

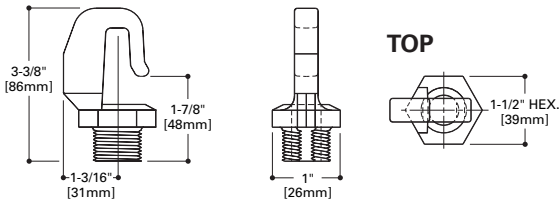

MOUNTING ACCESSORIES	DESIGNATION	DESCRIPTION
	15/18-TCB-KIT-NO PLATE =Top Connector Box only (no TCBP plate) 15/18-TCB-KIT =Top Connector Box Kit w/TCBP	Suitable for conduit mounting or for use with fixture hook, loop or safety hook. (Recommended for use with chain or cable set to prevent cantilevering and rotation from a central mounting point). Ideal for Retrofit opportunities that use our 15/18 luminaires!
		

MOUNTING ACCESSORIES	DESIGNATION	DESCRIPTION
	HB-SPM = Galvanized Single Monopoint Hanging Kit w/Hub (HBI only, supplied separately) HBL-SPM = Galvanized Single Monopoint Hanging Kit w/Hub (HBE and HBL only, supplied separately)	Suitable for conduit mounting or for use with fixture hook, loop or safety hook. Use chain or cable set to meet NEC requirements for single point mounting, as well as to prevent cantilevering and rotation of fixture from one central location.

MOUNTING METHODS	DESIGNATION	DESCRIPTION
	FH-1 = Fixture Hook	Fixture Hook 2-1/2" (must be used with TCB, HB-SPM or HBL-SPM)
		

MOUNTING METHODS	DESIGNATION	DESCRIPTION	DESIGNATION	DESCRIPTION
	FL-1 = Fixture Loop	Fixture Loop 2-1/2" (must be used with TCB, HB-SPM or HBL-SPM)		RH-1 = Retrofit Hanger Cast Aluminum Hanger w/Toggle Nut & Carriage Bolt for quick installation (must be used with TCB, HB-SPM or HBL-SPM)

Mounting

MOUNTING METHODS	DESIGNATION	DESCRIPTION
AYC Chain Sets		
	AYC-Chain/Set-U =Mounting hanger and chain set for I5, I8 and MBF ⁽³⁾	(2) sturdy Wire Hooks and 36" Chain Sets w/S-hooks
	HBAYC-Chain/Set-U =Hook style mounting chain set for HBI, HBE, HBL and ABI	(2) Hook style V-hangers, 36" Chain Sets w/S-hooks
NOTE: Not for use in high abuse areas such as gymnasiums or similar recreational facilities.		

MOUNTING METHODS	DESIGNATION	DESCRIPTION
"Y" Toggle		
	Y-Toggle-10 =Mounting Toggle and 10' Cable	10', Y Toggle #2 Cable
	Y-Toggle-25 =Mounting Toggle and 25' Cable	25', Y Toggle #2 Cable

MOUNTING METHODS	DESIGNATION	DESCRIPTION
Loop Hanger/Single Toggle		
 Loop Hanger		Loop-10
 Single Toggle		Loop-30
		Toggle-10
		Toggle-30
		10' Loop Hanger #2 Cable
		30' Loop Hanger #2 Cable
		10' Single Toggle #2 Cable
		30' Single Toggle #2 Cable

Options & Accessories

Occupancy Sensors

OCCUPANCY SENSORS	DESIGNATION	DESCRIPTION
-------------------	-------------	-------------

Aisle & 360° General Coverage (Modular)



MMS= Motion Sensor for Modular Power Supply (120-277V)⁽¹⁾

Supplied with Mounting Box, Modular Power Supply Receptacle, Motion Sensor w/360° Lens Installed, and (3) Cover Limiting Hoods (Aisle, End of Aisle, and Full Coverage).

NOTES: ⁽¹⁾One Motion Sensor per fixture required. ⁽²⁾When ordering a Modular Motion Sensor, the fixture must have a Modular Receptacle (MP) and a Modular Cord or Cord and plug accessory.

OCCUPANCY SENSORS	DESIGNATION	DESCRIPTION
-------------------	-------------	-------------

Aisle & 360° General Coverage (Installed)



MS= 360° or 180° Occupancy Sensor (120V-347V or 480V)

Passive Infra-red Sensor with 360° Lens Installed, 180° Lens Included w/Snap-on feature for in-field install.

360° Top View

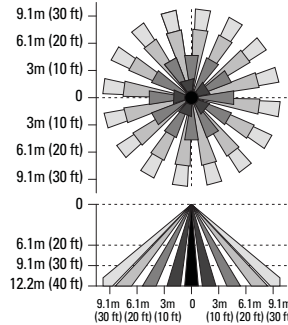

SideView

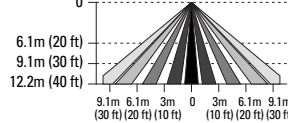

Aisle Top View

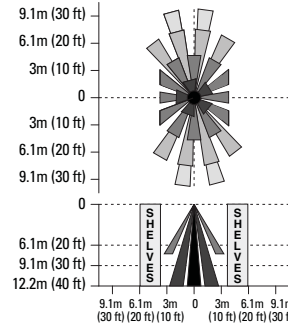

SideView

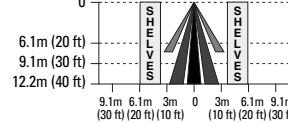

Power Connections

POWER CONNECTIONS	DESIGNATION	DESCRIPTION
-------------------	-------------	-------------

Modular Cord & Plug

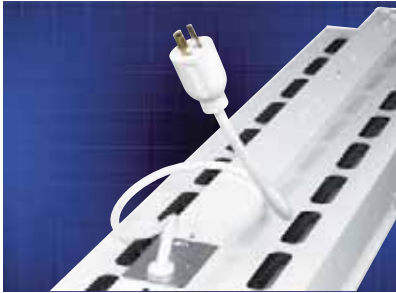

- MPC3**=3' Modular Power Cord & Plug (specify voltage for plug)
- MPC6**=6' Modular Power Cord & Plug (specify voltage for plug)
- MPC9**=9' Modular Power Cord & Plug (specify voltage for plug)
- MPC12**=12' Modular Power Cord & Plug (specify voltage for plug)
- MPC15**=15' Modular Power Cord & Plug (specify voltage for plug)

Connect directly to F-Bay or Modular Motion Sensor with a 3', 6', 9', 12' or 15' long modular cord & plug set w/NEMA 15 amp twist lock plug.

Modular Cord



- MC3**=3' Cord
- MC6**=6' Cord
- MC9**=9' Cord
- MC12**=12' Cord
- MC15**=15' Cord

Connect directly to F-Bay or Modular Motion Sensor with a 3', 6', 9', 12' or 15' long 3/16" standard Modular Power Cord.

POWER CONNECTIONS	DESIGNATION	DESCRIPTION
-------------------	-------------	-------------

MWS



MWS= Modular Wiring System

MWS is a simple and cost effective modular wiring system consisting of factory assembled components ready to be snapped together into a complete branch circuit wiring system.

With MWS, branch circuit wiring can be installed in minutes instead of hours reducing labor by 80%.

MDS6= 6' Modular Power Cord with MWS 27DS18/2G06MP.

Connect directly to F-Bay or Modular Motion Sensor with a 6' long Cord and MWS Connector.

PI OPTION ORDERING INFORMATION

Catalog Number Suffix	Number of Circuits	Circuit Wired To Ballast
PI 1 BLK	1	Black
PI 2 BLU	2	Blue
PI 2 BLK	2	Black
PI 3 RED	3	Red
PI 3 BLU	3	Blue
PI 3 BLK	3	Black

Catalog Numbering System

The PI System is available in sections up to 8' in length for continuous row wiring by simply plugging the sections together. Each PI section is factory wired to the ballast leads. Color coding of wires is as follows:

- PI-1** = One Circuit - 2 Wires: one black, one white
- PI-2** = Two Circuits - 3 Wires: one black, one blue, one white
- PI-3** = Three Circuits - 4 wires: one black, one blue, one red, one white

When ordering the PI2/PI3 System it is necessary to specify the number of fixtures required for each circuit. All wiring to external feeds, using cord or cord & plug, are responsibility of installing licensed contractor. Cord and cord & plug sets must be ordered separately if PI option is chosen.

PI1 - Single Circuit Plug-In

SAMPLE NUMBER: P11BLK-WG

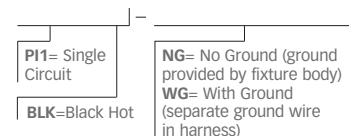

PI2 - Two Circuit Plug-In

SAMPLE NUMBER: P12BLK-WG

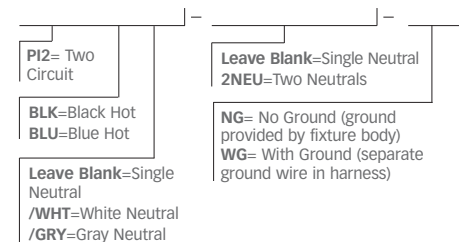

PI3 - Three Circuit Plug-In

SAMPLE NUMBER: P13BLK-WG

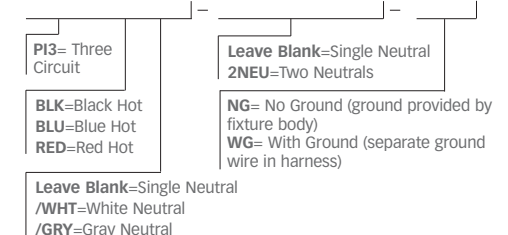

For complete product data, reference the Fluorescent Specification binder. Specifications & dimensions subject to change without notice. Consult your Cooper Lighting Representative for availability and ordering information.

Options & Accessories

15/18 Lens, Door Frames and Wireguards

15/18 LENS	DESIGNATION	DESCRIPTION
FROSTED ACRYLIC LENS		
	15-FRM/LENS = Frosted Acrylic Lens & Frame (use with general distribution reflector, 15 only)	In white door frame w/"Herringbone" patterned end rail
	18-FRM/LENS = Frosted Acrylic Lens & Frame (use with general distribution reflector, 18 only)	
	15-FRM/CL PK = Clear Acrylic Lens & Frame (use with general distribution reflector, 15 only)	
	18-FRM/CL PK = Clear Acrylic Lens & Frame (use with general distribution reflector, 18 only)	

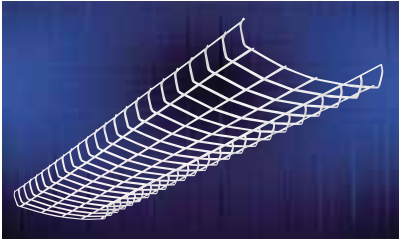
15/18 WIREGUARD	DESIGNATION	DESCRIPTION
HEAVY DUTY WIREGUARD		
	WG/15-4FT-B = 4' Heavy Duty Wireguard (for 15)	Finished in white. Can be used alone or in combination with other shielding
	WG/18-4FT-B = 4' Heavy Duty Wireguard (for 18)	

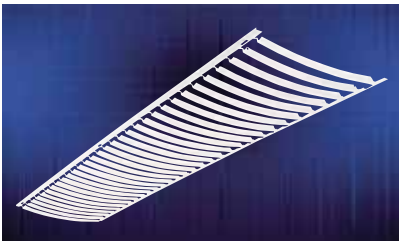
15/18 BAFFLE	DESIGNATION	DESCRIPTION
TBW		
	90800PPK BAFFLE 4FT 15 W/HDW (WHITE) = 4' Thin Blade White Baffle (for 15)	Thin Blade White Baffle w/23° longitudinal shielding
	BAFFLE 4FT 18 (WHITE) 11571919 = 4' Thin Blade White Blade Baffle (for 18)	

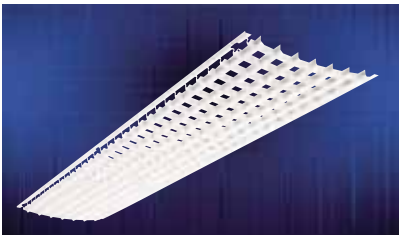
15/18 LOUVER	DESIGNATION	DESCRIPTION
ASYMMETRIC LOUVER		
	90801PPK = Asymmetric Directional Louver (use with general distribution reflector)	Can be oriented in either direction for flexibility

HBI, HBL & HBE Lens, Door Frames and Wireguards

HBI LENS & WIREGUARD

DESIGNATION

PRISMATIC & CLEAR ACRYLIC LENS



HBI-FRM/LENS PK= Prismatic Acrylic Lens & Door Frame for HBI

HBI-FRM/CL PK= Clear Acrylic Lens & Door Frame for HBI

WIREGUARD



HBI-FRM/WG PK= Frame and Wireguard for HBI

HBI-FRM/LENS/WG PK= Frame and Prismatic Acrylic Lens with Wireguard for HBI

HBI-FRM/CL/WG PK= Frame and Clear Lens with Wireguard for HBI

DROP WIREGUARD



HBI-FRM/DROPWG PK= Frame and Drop Wireguard for HBI

HBI-FRM/CL/DROPWG PK= Drop Wireguard, Clear Acrylic Lens and Door Frame for HBI

HEAVY DUTY STOCK WIREGUARD



SWG/HBI-4FT-B= Heavy Duty Wireguard for field installation

HBL WIREGUARD

DESIGNATION

WIREGUARD



WG-HBL6-4FT-B= Field Installable, Wireguard for HBL 4 and 6 Lamp

WG-HBL8-4FT-B= Field Installable, Wireguard for HBL 8 Lamp

HBE DOOR FRAME

DESIGNATION

HBE DOOR FRAME



HBE-__-FRM/LENS PK= Prismatic Acrylic Lens & Extruded Aluminum Door Frame⁽¹⁾

HBE-__-FRM/CL PK= Clear Acrylic Lens & Extruded Aluminum Door Frame⁽¹⁾

HBE-__-FRM/LENS/WG PK= Frame & Prismatic Lens with Wireguard⁽¹⁾

HBE-__-FRM/CL/WG PK= Frame & Clear Acrylic Lens with Wireguard⁽¹⁾

NOTES: ⁽¹⁾Specify "4/6LT" or "8/10LT" when ordering HBE Door Frame accessories.

Cooper Lighting, LLC.

Customer First Center
1121 Highway 74 South
Peachtree City, GA 30269

P: 770-486-4800

F: 770-486-4801

www.cooperlighting.com

International Sales, USA

Cooper Lighting, LLC.
1121 Highway 74 South
Peachtree City, GA 30269

P: 770-486-4800

F: 770-486-4801

Canada

Cooper Lighting, LLC.
5925 McLaughlin Road
Mississauga, Ontario L5R 1B8

P: 905-507-4000

F: 905-568-7049

The Cooper Lighting Family

Halo
Metalux
Lumark
Sure-Lites
Neo-Ray
Corelite
Portfolio
Iris
Shaper
io
Lumière
Invue
McGraw-Edison
Streetworks
Fail-Safe
PDS
MWS
RSA
Ametrix

Domestic Facilities

Cranbury, New Jersey
Elk Grove Village, Illinois
Irving, Texas
Ontario, California
Peachtree City, Georgia

Canadian Facility

Calgary, Alberta T2E 7V9
Mississauga, Ontario L5R 1B8

Cooper Lighting, Metalux and Fail-Safe are valuable trademarks of Cooper Industries in the United States and other countries.
You are not permitted to use the Cooper Trademarks without the prior written consent of Cooper Industries.

Cooper Industries plc
600 Travis, Ste. 5600
Houston, TX 77002-1001
P: 713-209-8400
www.cooperindustries.com