

DESCRIPTION

The H7 family of recessed housings are the standard in the industry for both commercial and residential applications. The wide variety of trims available allows a number of different lighting effects to be created with one basic housing. The H7RICAT housing is designed for installation where it will be in direct contact with insulation. The H7RICAT also meets restricted air flow requirements.

Catalog #	Type
Project	
Comments	
Prepared by	Date

DESIGN FEATURES

A...Housing

- Aluminum housing for greater heat dissipation.
- Housing will slip through 5-1/2" ceiling opening. Integral flange secures fixture against ceiling.
- Halo name embossed on housing.

B...Socket Plate

Rigid socket plate adjusts and locks without tools for various lamp sizes.

C...Junction Box

U.L. listed for through branch circuit wiring. Seven conduit knockouts are uniform 1/2" size with true pryout slots. Four Romex pryouts included.

D... "Quick Connect" Connectors

Three "Quick Connect" connectors eliminate need for separate wire nuts - simply strip supply wires and push in.

E...Remodel Springs

Four remodel clips secure housing and accommodate 1/2" and 5/8" ceiling material.

F...Socket

Porcelain socket with nickel plated brass screw shell.

G...Thermal Protector

Self resetting thermal protector deactivates fixture if overheating occurs due to improper lamping.

Labels

- U.L. listed for direct contact with insulation and combustible material
 - UL listed for Feed Through
 - UL Listed for Damp Location
 - CSA Certified
- Meets following requirements:
- State of California Title 24
 - Washington State Energy Code
 - International Energy Conservation Code (IECC)
 - New York State Energy Conservation Code
 - Certified Under ASTM-E283



H7RICAT

6" Insulated Ceiling Remodel Housing

6" TRIMS

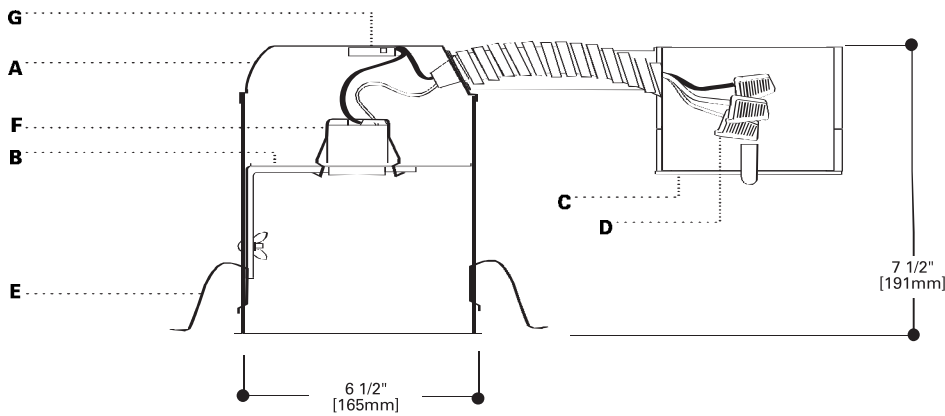

Ceiling Opening must be cut to match template supplied with housing

Top View

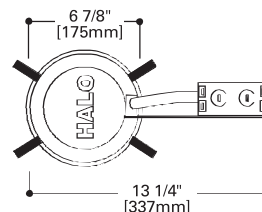

FOR USE IN INSULATED CEILINGS

FOR DIRECT CONTACT WITH INSULATION

FOR USE IN EXISTING CEILINGS

air **title**™
GLITE

With all trims listed

UPGRADE FEATURES:

- QUICK CONNECT CONNECTORS
- HALO ID ON HOUSING

Ordering Information on reverse.

ADV042489

Supersedes ADV031582, ADV023107 & ADV000301

9/04

















TAB: Recessed Incandescent Sheet 20

TRIMS

ORDERING INFORMATION

SAMPLE NUMBER: H7RICAT-426RG

Order housing, trim and accessories separately.

Housing	Trims	Accessories
<p>H7RICAT=AIR-TITE Insulated Ceiling Remodel Housing</p>	<p>REFLECTORS</p>	<p>Metal Trim Rings Compatible with 310 and 312 TRM6P=White Metal TRM6PB=Polished Brass TRM6C=Chrome TRM6MB=Black Metal TRM6SL=Silver TRP7MB=Black Plastic</p> <p>Oversize Trim Rings For use when ceiling opening is cut too large. Compatible with 310 and 312 trims OT400P=9 1/4" White Metal OT403P= 8" White Plastic</p>
	 <p>30</p>	<p>Coilex Regressed Eyeball 50W PAR30L, 60W BR30 420P=Black Baffle, White Eyeball 420PB=Black Baffle, Polished Brass Eyeball 420W=White Baffle, White Eyeball OD: 7 1/4" (184mm)</p>
	 <p>30</p>	<p>DIFFUSERS</p>  <p>170</p>
	 <p>404</p>	<p>Glass Albalite Lens 60W A19 170P=White Trim Ring 170PS=White Trim Ring, Shower Light OD: 8" (203mm)</p>
	 <p>426</p>	<p>Plastic Drop Opal 40W A19 171P=White Trim Ring 171PS=White Trim Ring, Shower Light OD: 8" (203mm)</p>
	 <p>429</p>	<p>Glass Fresnel Lens 40W A19 173P=White Trim Ring 173PS=White Trim Ring, Shower Light OD: 8" (203mm)</p>
	 <p>4041</p>	<p>Shower Light 60W A19, 50W PAR30 172PS=White Trim Ring, Shower Light OD: 7 3/4" (197mm)</p>
	 <p>4261</p>	<p>171</p>
	<p>BAFFLES</p>	<p>173</p>
	 <p>30</p>	<p>172</p>
	 <p>310</p>	<p>OPEN</p>
	 <p>310</p>	<p>300</p>
	 <p>310</p>	<p>327</p>
	<p>ADJUSTABLES</p>	<p>328</p>
	 <p>74</p>	<p>WALL WASH</p>
	 <p>77</p>	
	 <p>78</p>	<p>Baffle Wall Wash 40W A19 430P=Black Baffle, White Scoop, White Trim Ring 430W=White Baffle, White Scoop, White Trim Ring OD: 7 1/4" (184mm)</p>
		<p>AIR-TITE Super Trim 60W A19, 75W PAR30, 75W R30, 65W BR30, 75W PAR30L, 60W PAR38 30CAT=Specular Clear, Air-Tite 30RGAT=Residential Gold, Air-Tite 30HAT=Haze, Air-Tite OD: 7 1/4" (184mm)</p>
		<p>AIR-TITE Super Trim 40W A19, 50W PAR30, 75W PAR30L 30SBAT=Specular Black, Air-Tite OD: 7 1/4" (184mm)</p>
		<p>Specular Reflector 60W A19 404C=Specular Clear 404RG=Residential Gold OD: 7 1/4" (184mm)</p>
		<p>Specular Reflector Cone 50W PAR30, 75W R30, 65W BR30, 75W PAR30L 426=Specular Clear 426H=Haze Reflector 426RG=Residential Gold 426CG=Champagne Gold 426SB=Specular Black OD: 7 1/4" (184mm)</p>
		<p>Dayform Cone 50W PAR30, 75W R30, 65W BR30, 75W PAR30L 429=White OD: 7 1/4" (184mm)</p>
		<p>Self Flanged Reflector 60W A19 4041=White OD: 7 1/4" (184mm)</p>
		<p>Self Flanged Reflector Cone 50W PAR30, 75W R30, 65W BR30, 75W PAR30L 4261=White OD: 7 1/4" (184mm)</p>
		<p>AIR-TITE Super Trim 40W A19, 75W R30, 65W BR30, 60W PAR38, 75W PAR30, 75W PAR30L 30PAT=Black Baffle 30WAT=White Baffle OD: 7 1/4" (184mm)</p>
		<p>Baffle 75W R30, 65W BR30, 75W PAR30L, 50W PAR30 310P=Black Baffle 310W=White Baffle OD: 7 1/4" (184mm)</p>
		<p>Baffle 50W PAR30, 65W BR30, 75W PAR30L, 75W R30, 65W BR30 312P=Black Baffle 312W=White Baffle OD: 7 1/4" (184mm)</p>
		<p>Eyeball 75W PAR30 74P=White Eyeball OD: 8" (203mm)</p>
		<p>Eyeball 50W R20 77P=White Eyeball OD: 8" (203mm)</p>
		<p>Eyeball 75W R30 78P=White Eyeball 78B=Brass Eyeball 78SL=Silver 78PB=Polished Brass Eyeball 78PAT=Polished Brass Eyeball (converts H7ICT and H7RICT to AIR-TITE Construction) OD: 8" (203mm)</p>

Note: Specifications and Dimensions subject to change without notice.

Visit our web site at www.cooperlighting.com



DESCRIPTION

The H7 family of recessed housings are the standard in the industry for both commercial and residential applications. The wide variety of trims available allows a number of different lighting effects to be created with one basic housing. The H7RICAT housing is designed for installation where it will be in direct contact with insulation. The H7RICAT also meets restricted air flow requirements.

Catalog #	Type
Project	
Comments	
Prepared by	Date

DESIGN FEATURES

A...Housing

- Aluminum housing for greater heat dissipation.
- Housing will slip through 5-1/2" ceiling opening. Integral flange secures fixture against ceiling.
- Halo name embossed on housing.

B...Socket Plate

Rigid socket plate adjusts and locks without tools for various lamp sizes.

C...Junction Box

U.L. listed for through branch circuit wiring. Seven conduit knockouts are uniform 1/2" size with true pryout slots. Four Romex pryouts included.

D... "Quick Connect" Connectors

Three "Quick Connect" connectors eliminate need for separate wire nuts - simply strip supply wires and push in.

E...Remodel Springs

Four remodel clips secure housing and accommodate 1/2" and 5/8" ceiling material.

F...Socket

Porcelain socket with nickel plated brass screw shell.

G...Thermal Protector

Self resetting thermal protector deactivates fixture if overheating occurs due to improper lamping.

Labels

- U.L. listed for direct contact with insulation and combustible material
 - UL listed for Feed Through
 - UL Listed for Damp Location
 - CSA Certified
- Meets following requirements:
- State of California Title 24
 - Washington State Energy Code
 - International Energy Conservation Code (IECC)
 - New York State Energy Conservation Code
 - Certified Under ASTM-E283



H7RICAT

6" Insulated Ceiling Remodel Housing

6" TRIMS

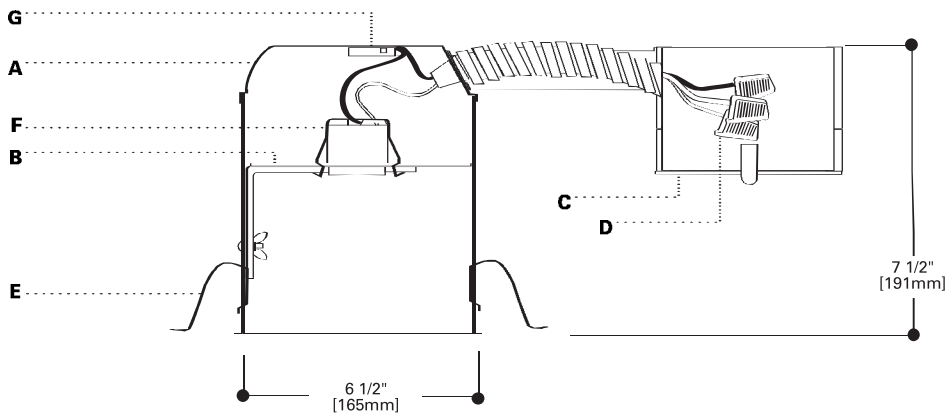

Ceiling Opening must be cut to match template supplied with housing

Top View

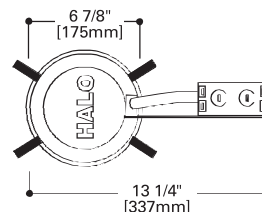

FOR USE IN
INSULATED
CEILING

FOR DIRECT CONTACT
WITH INSULATION

FOR USE IN
EXISTING CEILING

air **title**™
GLITE

With all trims listed

UPGRADE FEATURES:

- QUICK CONNECT CONNECTORS
- HALO ID ON HOUSING































Ordering Information on reverse.

TRIMS

ORDERING INFORMATION

SAMPLE NUMBER: H7RICAT-426RG

Order housing, trim and accessories separately.

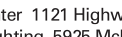
Housing	Trims	Accessories
<p>H7RICAT=AIR-TITE Insulated Ceiling Remodel Housing</p>	<p>REFLECTORS</p>	<p>Metal Trim Rings Compatible with 310 and 312 TRM6P=White Metal TRM6PB=Polished Brass TRM6C=Chrome TRM6MB=Black Metal TRM6SL=Silver TRP7MB=Black Plastic</p> <p>Oversize Trim Rings For use when ceiling opening is cut too large. Compatible with 310 and 312 trims OT400P=9 1/4" White Metal OT403P= 8" White Plastic</p>
	 <p>30</p>	<p>Coilex Regressed Eyeball 50W PAR30L, 60W BR30 420P=Black Baffle, White Eyeball 420PB=Black Baffle, Polished Brass Eyeball 420W=White Baffle, White Eyeball OD: 7 1/4" (184mm)</p>
	 <p>30</p>	<p>DIFFUSERS</p>
	 <p>404</p>	 <p>170</p>
	 <p>426</p>	 <p>171</p>
	 <p>429</p>	 <p>173</p>
	 <p>4041</p>	 <p>172</p>
	 <p>4261</p>	 <p>300</p>
	<p>BAFFLES</p>	 <p>327</p>
	 <p>30</p>	 <p>328</p>
	 <p>310</p>	 <p>328</p>
	 <p>310</p>	 <p>328</p>
	<p>ADJUSTABLES</p>	 <p>328</p>
	 <p>74</p>	 <p>328</p>
	 <p>77</p>	 <p>328</p>
	 <p>78</p>	 <p>328</p>
		 <p>328</p>
		 <p>328</p>
		 <p>328</p>
		 <p>328</p>
		 <p>328</p>

Note: Specifications and Dimensions subject to change without notice.

Visit our web site at www.cooperlighting.com

