

Kellems® Wire Management Products
Metallic Liquidtight Conduit Fittings
Conduit Fitting

HUBBELL

Features

- Hexagonal nut compresses gland-ring onto conduit
- Nylon gasket provides liquidtight seal at hub
- Non-integral steel ferrule seals conduit

Ordering Information

Description	Trade Size	UPC	Catalog Number
90° Conduit Fitting, Non-Insulated	3/4" (21)	783585034232	H0759



Listings

UL Listed
CSA Certified

Specifications

Fitting	Zinc plated steel
Compression Nut	Zinc plated steel
Ferrule	Zinc plated steel
Split Seal Ring	Nylon
Washer	Nylon
Locknut	Zinc plated steel

Performance

Environmental	
Operating Temperature	-60°F to +1000°F (-51°C to +538°C)

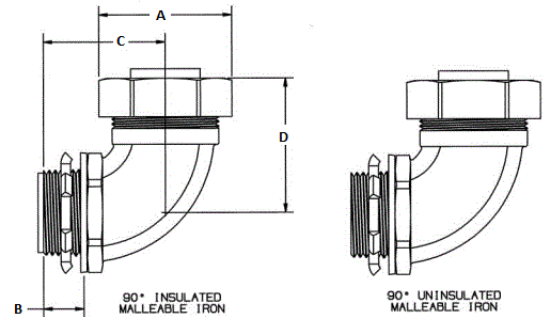

Online Resources

Customer Use Drawing
eCatalog
Installation Instructions

Dimensions in Inches (mm)

Hubbell Wiring Device-Kellems • Hubbell Incorporated (Delaware) • 40 Waterview Drive • Shelton, CT 06484

Phone (800) 288-6000 • Fax (800) 255-1031 • Specifications subject to change without notice.

