

FML LED DECORATIVE FLOOD

Cat.#

Job

Type



HUBBELL
Outdoor Lighting

Approvals

SPECIFICATIONS

Intended Use:

Compact LED flood with a variety of NEMA distribution for lighting applications such as safety/security, accent, flag pole, columns, or signs

Construction:

- Corrosion resistant, rugged die-cast aluminum housing with powder coat paint finish
- High impact UV stabilized acrylic outer lens protects LEDs and allows for cleaning and debris removal
- Vented housing isolates LED module from driver, maximizing product life and performance
- Visor and vandal lens available

LED:

- 20 high powered LED's
- Ambient operating temperature -35°C to 40°C
- Stock Versions: 4000K and 5000K CCT
- MTO Versions: 3000K nominal with 80 CRI, 4000K and 5000K CCT nominal with 70 CRI

Optical/Electrical

- Variety of NEMA distributions: - N (3x3), M (4x4), RM (5x4) and W (6x6) - for wide range of lighting applications; Stock version Wide (6x6) only
- 120-277V operation, 50/60Hz
- Driver IP66 and RoHS compliant driver
- 10KV surge protector comes standard

Optical/Electrical (Cont.)

- 0-10V dimming driver standard, continuous dimming option to have leads pulled out for easy connection

Installation:

- Traditional 1/2" x 14 NPS threaded adjustable knuckle mounting
- Easy maintenance access to electrical components with removal of 4 screws from back of fixture housing.

Listings:

- IP65
- EPA is .54 sq/ft.
- Listed to UL1598 for use in wet locations
- DLC Qualified (4000K and 5000K models only); Consult DLC website for more details: <http://www.designlights.org/QPL>
- This product qualifies as a "designated country construction material" per FAR 52.225-11 Buy American-Construction Materials under Trade Agreements effective 04/23/2020. See [Buy American Solutions](#)

Warranty:

5 year limited warranty, for more information visit: <http://www.hubbellighting.com/resources/warranty/>

PRODUCT IMAGE(S)



DIMENSIONS

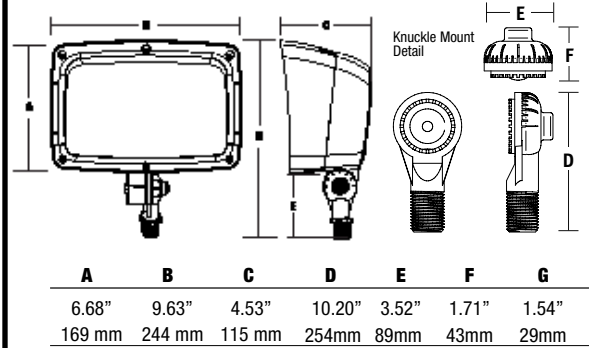

CERTIFICATIONS/LISTINGS



IP65

SHIPPING INFORMATION

| Catalog Number | G.W(kg)/CTN | Carton Dimensions | | |
|------------------------------------|----------------|-------------------|-----------------|------------------|
| | | Length Inch (cm) | Width Inch (cm) | Height Inch (cm) |
| FML-52 or 20 (Single carton 1 pc.) | 3.81 lbs (1.7) | 11.81" (30) | 9.45" (24) | 7.48" (19) |
| FML-52 (Master carton 2 pcs.) | 7.61 lbs (3.5) | 19.69" (50) | 12.40" (32) | 8.46" (21.5) |

Carton dimensions for shipping purposes only

ORDERING INFORMATION - STOCK VERSION

| Catalog Number | Mount | Max Candle Power | Beam Pattern | Wattage | Drive Current | Voltage | Color Temperature | Lumens | LPW | Weight lbs. (kg) | Finish |
|----------------|-------------|------------------|--------------|---------|---------------|----------|-------------------|--------|-----|------------------|----------------------------|
| FML-52 | 1/2" thread | 3291 | Wide | 52 | 700mA | 120-277V | 5000K | 4957 | 96 | 8.5 (3.8) | Dark Bronze Matte Textured |
| FML-52-PCU | 1/2" thread | 3291 | Wide | 52 | 700mA | 120-277V | 5000K | 4957 | 96 | 8.5 (3.8) | |
| FML-52-4K | 1/2" thread | 3150 | Wide | 52 | 700mA | 120-277V | 4000K | 4552 | 94 | 8.5 (3.8) | |
| FML-52-4K-PCU | 1/2" thread | 3150 | Wide | 52 | 700mA | 120-277V | 4000K | 4552 | 94 | 8.5 (3.8) | |

ORDERING INFORMATION - MADE TO ORDER

FML - 20L - 52 - [] - [] - [] - [] - K - [] - [] - []

| FAMILY | # LEDS | WATTS | CCT | CRI | VOLTAGE | MOUNTING | FINISH | CONTROL OPTION | OPTIONS |
|-------------------------|------------|--------|----------------------------------|-----------------------------------|---|-----------|--|---|--|
| FML FACTOR Flood Medium | 20L 20 LED | 52 52W | 3K 3000K 4K 4000K 5K 5000K | 7 70 CRI 8 ² 80 CRI | U 120V-277V 1 120V 2 208V 3 240V 4 277V | K Knuckle | BLT Black Matte Textured BLS Black Gloss Smooth DBT Dark Bronze Matte Textured DBS Dark Bronze Gloss Smooth GTT Graphite Matte Textured LGS Light Grey Gloss Smooth PSS Platinum Silver Smooth WHT White Matte Textured WHS White Gloss Smooth VGT Verde Green Smooth | PC ¹ Photocontrol (voltage specified and determined by voltage field) CD Continuous dimming | F ¹ Fusing 120 or 277V only (determined by voltage field) SP Surge Protector, 20KA Surge Protector |

¹ - PC - photocell and F - Fusing options cannot be combined, only available as separate options
² - 80 CRI only available on 3K configurations



Hubbell Outdoor Lighting • 701 Millennium Boulevard • Greenville, SC 29607 • Phone: 864-678-1000

Due to our continued efforts to improve our products, product specifications are subject to change without notice.

© 2020 HUBBELL OUTDOOR LIGHTING. All Rights Reserved • For more information visit our website: www.hubbelloutdoor.com • Printed in USA FML14-SPEC August 14, 2020 10:24 AM

ACCESSORIES/REPLACEMENT PARTS - Order Separately

| Catalog Number | Description |
|---------------------------|--|
| FML-SPC | Vandal resistant polycarbonate lens (Replaces existing acrylic outer frame) |
| FML-VISOR-XX ¹ | Top/Bottom visor (Tap holes in lens frame for field installation) |
| 93047961AC | Acrylic lens w/ gasket |
| 93047971 | FML14, 50w, 120-277V Dimming driver 1050mA |
| 93043808 | FML20, 50w, 120-277V Dimming driver 700mA |
| 20750110264 | Knuckle mount Dark Bronze finish. Contact factory for additional finishes |
| S-302 | Slipfits 1 1/2" or 2" pipe (1.9" OD or 2 3/8" OD) with 1/2" N.P.S.M. hub; Gray |
| S-302-M51 | Slipfits 1 1/2" or 2" pipe (1.9" OD or 2 3/8" OD) with 1/2" N.P.S.M. hub; Bronze |
| S-302-M52 | Slipfits 1 1/2" or 2" pipe (1.9" OD or 2 3/8" OD) with 1/2" N.P.S.M. hub; White |
| TRN-XX ¹ | Trunnion adaptor for 1/2" threaded knuckle mount |

¹ Specify finish color to match fixture, e.g. DB - Bronze.



FML-SPC



FML-VISOR - 3/4 View

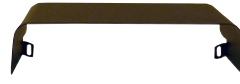

Front View

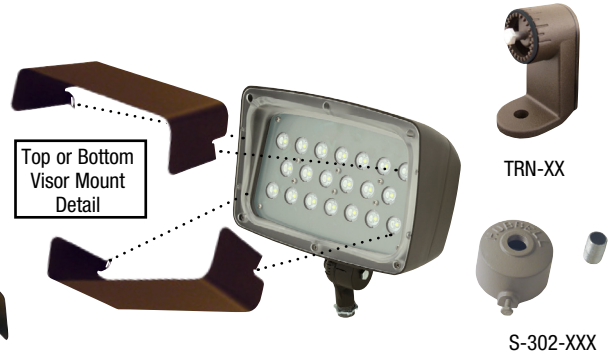

TRN-XX

S-302-XXX

PERFORMANCE DATA

| # OF LEDS | DRIVE CURRENT | SYSTEM WATTS | DIST. TYPE | NEMA | FIELD ANGLE H° X V° | 5K (5000K nominal, 70 CRI) | | | 4K (4000K nominal, 70 CRI) | | | 3K (3000K nominal, 80 CRI) | | |
|-----------|---------------|--------------|------------|-------|---------------------|----------------------------|------------------|----------------------|----------------------------|------------------|----------------------|----------------------------|------------------|----------------------|
| | | | | | | LUMENS | LPW ¹ | MAX BEAM CANDLEPOWER | LUMENS | LPW ¹ | MAX BEAM CANDLEPOWER | LUMENS | LPW ¹ | MAX BEAM CANDLEPOWER |
| 20 | 700mA | 52w | N | 3 x 3 | 32 x 32 | 5185 | 103 | 41534 | 4675 | 98 | 38703 | 3618 | 75 | 31214 |
| | | | M | 4 x 4 | 54 x 54 | 5083 | 99 | 15056 | 4712 | 98 | 13606 | 3618 | 74 | 10399 |
| | | | RM | 5 x 4 | 83 x 66 | 4338 | 84 | 7273 | 4017 | 83 | 6543 | 3132 | 63 | 5527 |
| | | | W | 6 x 6 | 107 x 107 | 4957 | 96 | 3291 | 4552 | 94 | 3150 | 3466 | 69 | 2548 |

¹ - Lumen values are from photometric tests performed in accordance with IESNA LM-79-08. Data is considered to be representative of the configurations shown. Actual performance may differ as a result of end-user environment and application.

PROJECTED LUMEN MAINTENANCE

| AMBIENT TEMP. | OPERATING HOURS | | | | | Calculated L70 (HOURS) |
|---------------|-----------------|--------|--------|-----------------|---------|------------------------|
| | 0 | 25,000 | 50,000 | TM-21-11 60,000 | 100,000 | |
| 25°C / 77°F | 1.00 | 0.98 | 0.96 | 0.96 | 0.94 | >696,000 |
| 40°C / 104°F | 0.99 | 0.96 | 0.95 | 0.94 | 0.92 | >565,000 |

LUMINAIRE AMBIENT TEMPERATURE FACTOR (LATF)

| AMBIENT TEMPERATURE | LUMEN MULTIPLIER |
|---------------------|------------------|
| 0°C | 1.02 |
| 10°C | 1.01 |
| 20°C | 1.00 |
| 25°C | 1.00 |
| 30°C | 1.00 |
| 40°C | 0.99 |
| 50°C | 0.98 |

Use these factors to determine relative lumen output for average ambient temperatures from 0-50°C (32-122°F).

ELECTRICAL DATA

| # OF LEDS | NUMBER OF DRIVERS | DRIVE CURRENT (mA) | INPUT VOLTAGE (V) | CURRENT (Amps) | SYSTEM POWER (W) |
|-----------|-------------------|--------------------|-------------------|----------------|------------------|
| 20 | 2 | 700mA | 120 | 0.56 | 52 |
| | | | 277 | 0.26 | 52 |

PHOTOMETRICS For additional photometric information and IES downloads, visit our web site at www.hubbelloutdoor.com

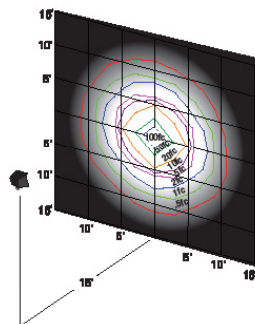

FML20
3x3 Narrow

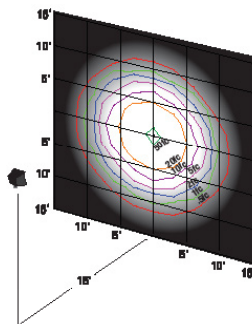

FML20
4x4 Medium

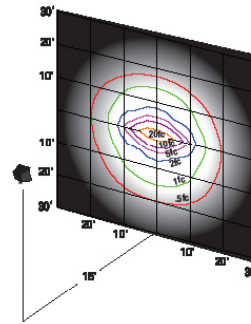

FML20
5x4 Rectangular
Medium

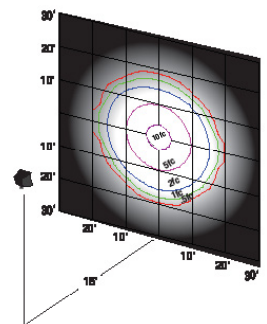

FML20
6x6 Wide



HUBBELL
Outdoor Lighting

Hubbell Outdoor Lighting • 701 Millennium Boulevard • Greenville, SC 29607 • Phone: 864-678-1000

Due to our continued efforts to improve our products, product specifications are subject to change without notice.

© 2020 HUBBELL OUTDOOR LIGHTING, All Rights Reserved • For more information visit our website: www.hubbelloutdoor.com • Printed in USA **FML14-SPEC August 14, 2020 10:24 AM**