

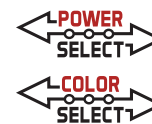

XFIT



KT-FLED290PS-R2X-UNV-8CSB-VDIM

HIGH POWER FLOODLIGHT

DESCRIPTION

High Power Floodlight | Power Select | Color Select
| 120-277V | 80 CRI | Bronze Housing

APPLICATION

Ground, pole, or building mount applications (parking lots, auto dealerships, building facades, signs, recreational venues, general area lighting)



5 YEAR
WARRANTY

PRODUCT FEATURES

- Keystone Power Select technology (290/210W)
- Keystone Color Select technology (3000/4000/5000K)
- High power floodlight with innovative design based on established floodlight principles
- Die cast aluminum housing, with optional glare shield accessory (sold separately)
- Heavy duty, interchangeable slipfitter and trunnion mount options included
- Suitable for ground, pole, or building mount applications
- 3 pin twist lock photocell and shorting cap included with NEMA/ANSI C136.10 3 pin twist lock receptacle
- Precision-crafted optics lens with NEMA 7H x 6V, 6H x 6V, and 5H x 5V options available. See below chart for details.
- Keystone 0-10V dimming driver with 12V AUX power tap and 6kV surge protection
- Ambient operating temperature: -40°C/-40°F - 50°C/122°F
- UL and DLC listed, IP65 rated
- Power factor: > 0.95
- THD: < 20%
- LED chip lifetime: L70 > 100,000 hrs @ 25°C/77°F ambient fixture temperature
- Meets FCC Part 15, Part B, Class A standards for conducted and radiated emissions

PRODUCT SPECIFICATIONS

Catalog Number	Selectable Wattage	Selectable CCT	Lumen Output	Efficacy	Input Voltage	CRI	Dimming	Mounting	Dist Pattern	Photocell	Rated Life	Legacy Equivalent
KT-FLED290PS-R2B-UNV-8CSB-VDIM	290W	3000K	34800	120 lm/W	120 - 277V	>80	0-10V	Universal: 2 3/8" Slip Fitter or Trunnion	7H x 6V	Included	50,000 Hours	1000W MH
KT-FLED290PS-R2C-UNV-8CSB-VDIM		4000K	40600	140 lm/W					6H x 6V			
KT-FLED290PS-R2D-UNV-8CSB-VDIM	210W	5000K	37700	130 lm/W								
		3000K	27300	130 lm/W					5H x 5V			
		4000K	29400	140 lm/W								
		5000K	28350	135 lm/W								

*Note: fixtures with 6H x 6V or 5H x 5V optics are assembled to order. Lead times may apply.

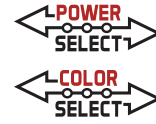

KT-FLED290PS-R2X-UNV-8CSB-VDIM

HIGH POWER FLOODLIGHT

WIRING DIAGRAM

GENERAL WIRING DIAGRAM

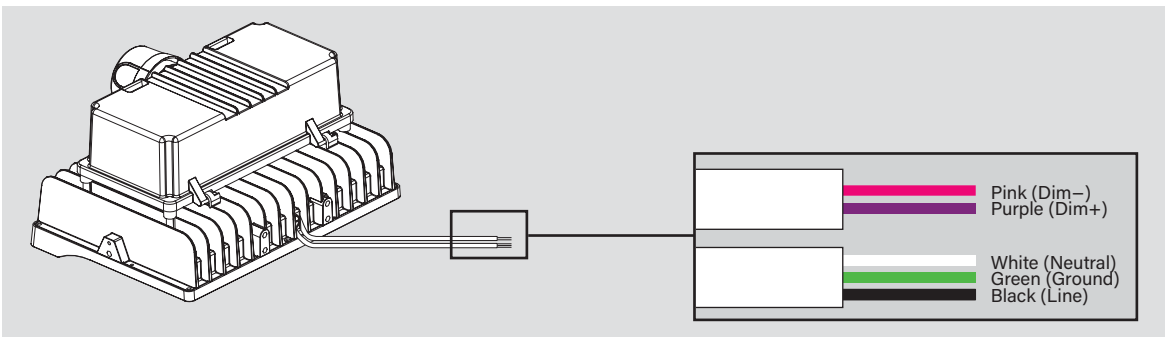
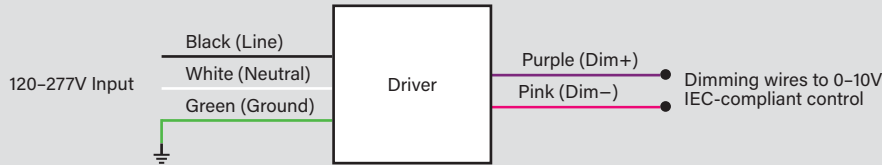

POWER AND COLOR SELECT INSTRUCTIONS

This fixture is equipped with field-adjustable selectable wattage and selectable CCT technology.

1. Ensure power is off to the fixture.
2. Unscrew the gasketed caps from the back of the fixture as shown in the images below.
3. Adjust dip switches to desired settings.
4. Screw on gasketed caps.
5. Restore power to fixture.

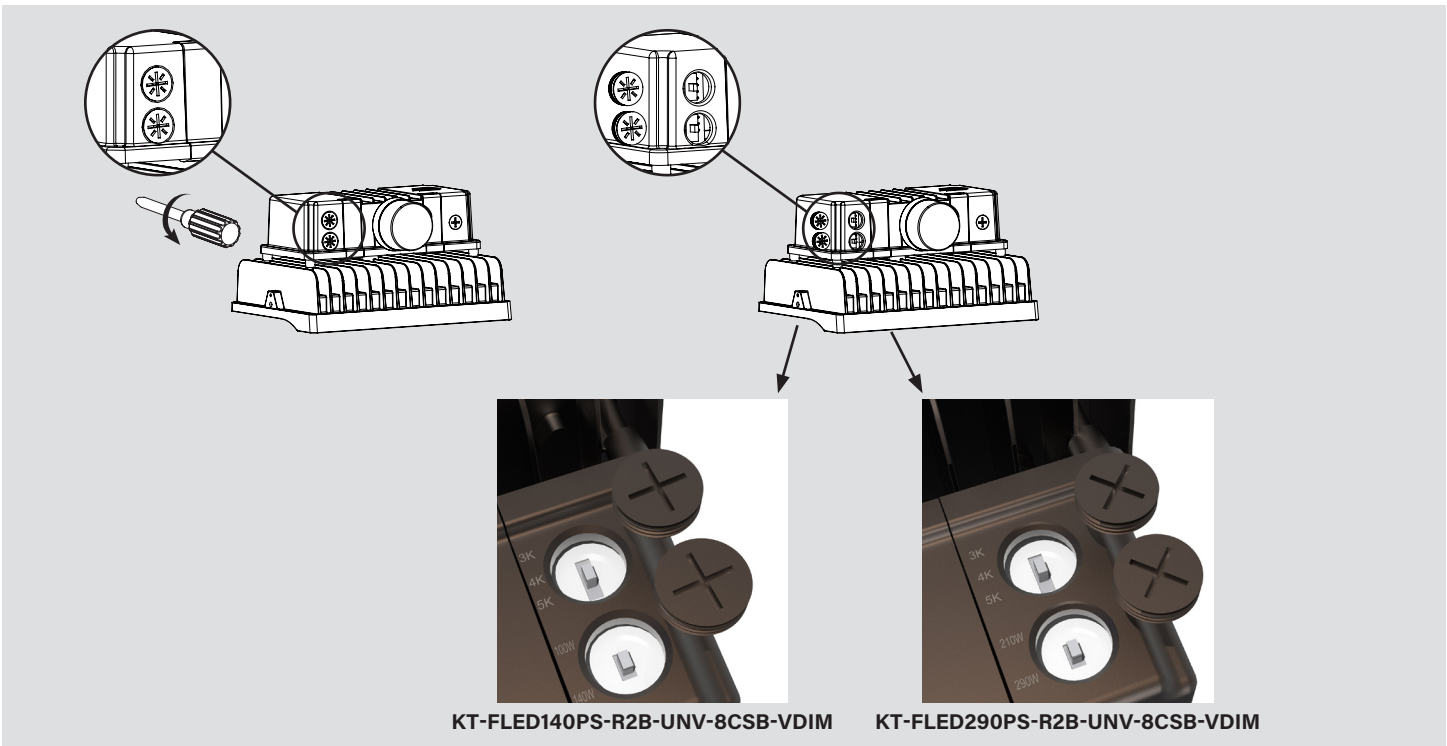



KT-FLED290PS-R2X-UNV-8CSB-VDIM

HIGH POWER FLOODLIGHT

PHOTOMETRICS

290W 5000K Building Mount: Building exterior mounted at 35', 30 degrees below horizon

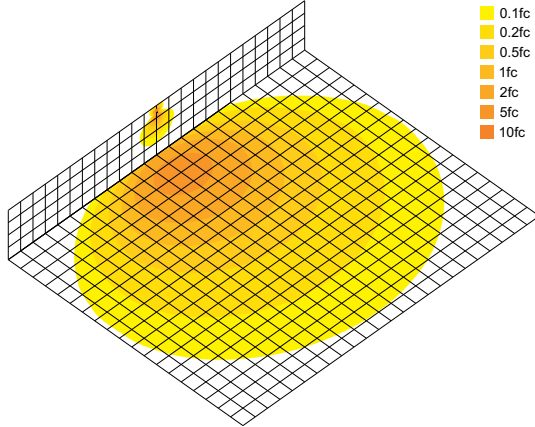

290W 5000K Ground Mount: 6' above ground, 10 degrees above horizontal. Shining towards building exterior wall @ 40' away

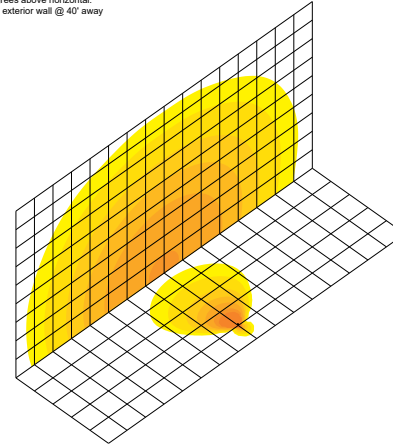

Luminous Intensity Distribution Curve

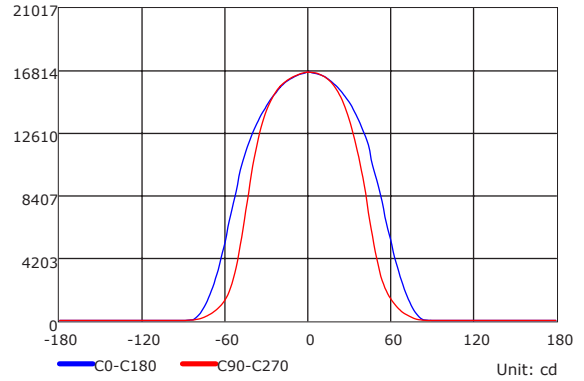
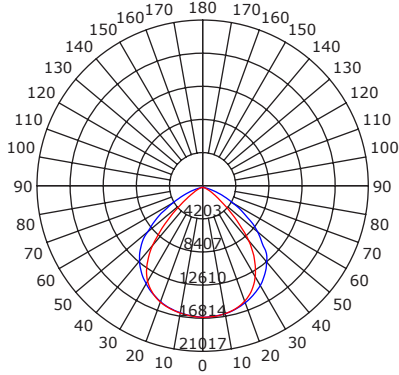

Illuminance at a Distance

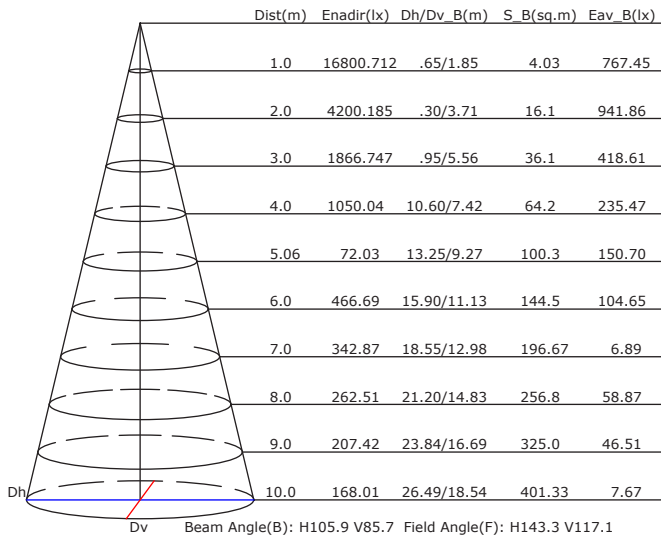

Isocandela (Rectangle)

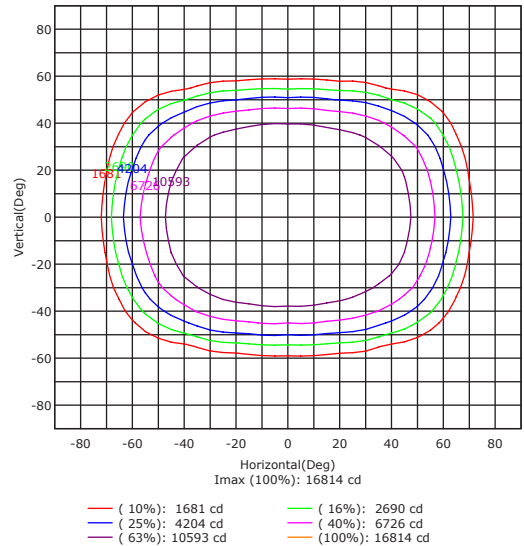

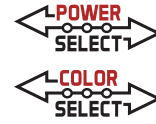

KT-FLED290PS-R2X-UNV-8CSB-VDIM





HIGH POWER FLOODLIGHT

EPA SPECIFICATIONS

Small-Size Fixture Housing

- Conditions: Horizontal winds only for calculations. Worst case total projected area used for calculations.
- All drag coefficients are set as worst case 1.2.
- For details on exact EPA calculations and assumptions, please contact productsupport@keystonetech.com

EPA Calcs (1.2*ft^2 | View)

Mounting Application	Fixture Position	Housing Size	Single Fixture	2 Fixtures at 90°	2 Fixtures at 180°
					
Slip Fitter Mount 	45°	L (290W)	1.139 sq. ft.	1.831 sq. ft.	1.384 sq. ft.

PHYSICAL SPECIFICATIONS

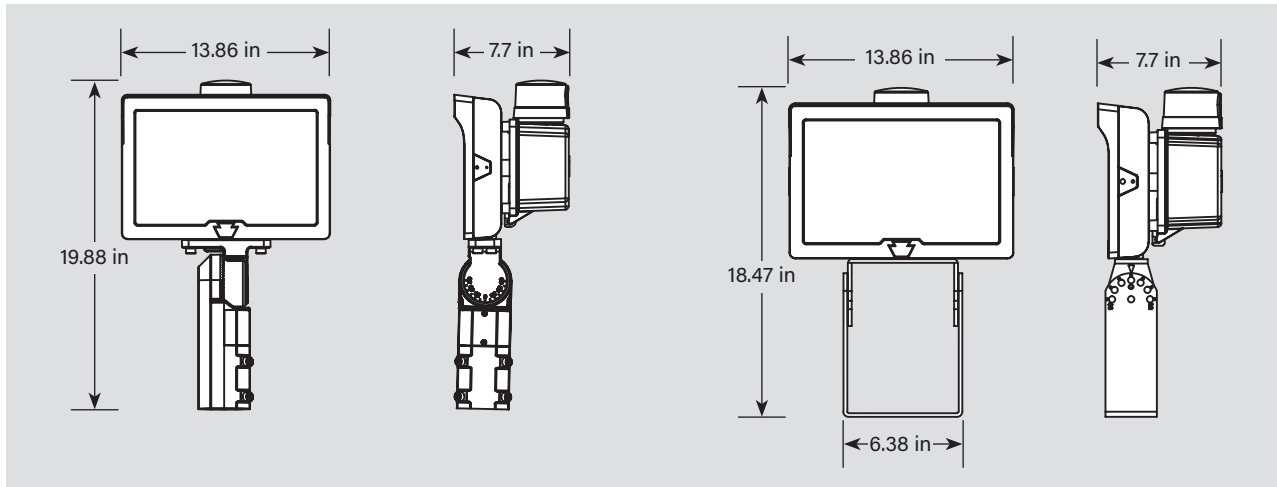

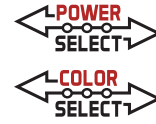

KT-FLED290PS-R2X-UNV-8CSB-VDIM

HIGH POWER FLOODLIGHT

ACCESSORIES

SENSORS

Field-Installable (Included)

✓	SUFFIX	CATALOG NUMBER	DESCRIPTION	UPC	EASY CODE
	-	KT-TLP-UV-3PN	NEMA-Type 3-Pin Photocell; 120-277V; 1800VA Max	841654131825	NQT-46



CORD SETS

Factory-Installable OR Field-Installable (field-installable purchased separately)

✓	SUFFIX*	CATALOG NUMBER	DESCRIPTION	UPC	EASY CODE
	/515P6	KT-CS-515P-6-18/3	Cord set; 125V NEMA 5-15P; straight blade plug; 6' SJTOW cable; 18/3 wire	843654140124	UKH-26

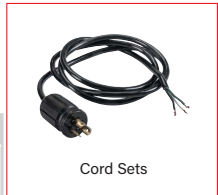

*For factory installation of accessory, add suffix to fixture part number (see ordering examples and instructions on last page of spec sheet).
 Note: For cord sets not listed here, please contact your Keystone sales rep.

MOUNTS AND BRACKETS

Field-Installable / Field-Use ONLY (purchased separately)

✓	SUFFIX	CATALOG NUMBER	DESCRIPTION	UPC	EASY CODE
	/515P6	KT-FLED-GS-R2-2-KIT	Glare shield for 290W Fixture	843654138695	VCZ-14



ORDERING INFORMATION

Catalog Number	UPC	Easy Code	DLC PRODUCT ID
KT-FLED290PS-R2B-UNV-8CSB-VDIM	843654138657	PFX-43	S-YOLFHFA
KT-FLED290PS-R2C-UNV-8CSB-VDIM	843654145631	DJP-06	S-KZMCQ8
KT-FLED290PS-R2D-UNV-8CSB-VDIM	843654145662	SUV-63	S-5X14QJ

CATALOG NUMBER BREAKDOWN

KT-FLED290PS-R2X-UNV-8CSB-VDIM

1	2	3	4	5	6	7	8	9	10	11	12
1 Keystone Technologies				5 Shape			8 Mounting				
2 Floodlight LED			R	Rectangular			UNV	Universal			
3 Max Wattage					6 Style					11 Color Select Designation	
4 Power Select					2	Series 2				B	3000/4000/5000K
5 Shape							7 Distribution				
6 Style					B	NEMA 7H x 6V Beam Spread					
7 Distribution					C	NEMA 6H x 6V Beam Spread					
8 Mounting					D	NEMA 5H x 5V Beam Spread					
9 80 CRI											
10 Color Select											
11 Color Select Designation											
12 0-10V Dimming											

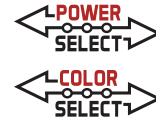

KT-FLED290PS-R2X-UNV-8CSB-VDIM

HIGH POWER FLOODLIGHT

ORDERING EXAMPLES

FIXTURE WITH SINGLE FACTORY-INSTALLED ACCESSORY
KT-FLED290PS-R2X-UNV-8CSB-VDIM /515P6

FIXTURE WITH NO FACTORY-INSTALLED ACCESSORIES
KT-FLED290PS-R2X-UNV-8CSB-VDIM

* When ordering more than one factory-installed accessory, use multiple suffixes as shown in the ordering examples above.
Note: All accessories can also be ordered separately for field installation using just their regular Catalog Number, UPC, or Easy Code.

KEYSTONE FIXTURE		
CATALOG NUMBER		
KT-FLED290PS-R2X-UNV-8CSB-VDIM		
SENSORS		
	SUFFIX	CATALOG NUMBER
✓	/3PN	KT-TLP-UV-3PN
CORD SETS		
	SUFFIX	CATALOG NUMBER
✓	/515P6	KT-CS-515P-6-18/3