



FAN & FIXTURE BOXES

FOR A VARIETY OF USES



Choose the Fan or Fixture Box that's right for you...

...in Steel or Plastic – or a Combination!

No matter what your needs – or installation preferences, Arlington has a fan/fixture box to fit.

We manufacture a variety of steel and non-metallic boxes in many depths and cubic inch capacities that install directly to the joist(s) for an extra-secure installation.

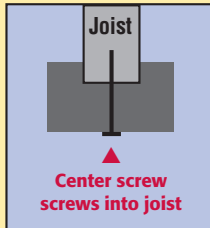

Our boxes that mount to the bottom of a joist deliver a safe, secure installation because both the box and the bracket install directly to the joist!

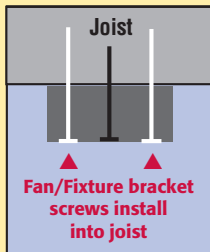

Plus, we have a box for every ceiling condition!

Joist Mount

page **4**

FBS405, FBS405T
6.0 cubic inches
FBS407, FBS407T
8.0 cubic inches

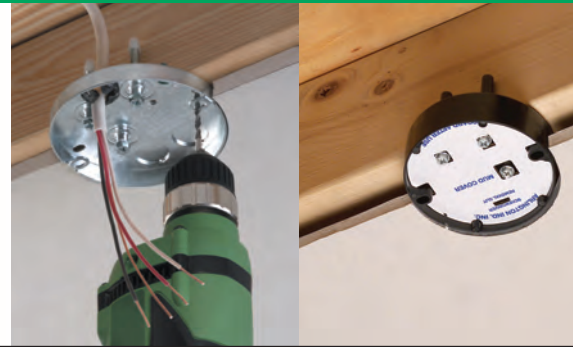
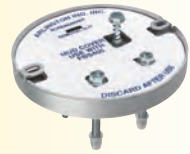

for **NEW CONSTRUCTION**

Under-Joist Mount

page **5**

FBS415
1-1/2" depth
14.6 cubic inches
FBS420
2" depth
20.0 cubic inches



For **NEW CONSTRUCTION**

Side Mount

page **5**

FBS415S
1-1/2" depth
14.6 cubic inches
FBS420S
2" depth
20.0 cubic inches



For **NEW CONSTRUCTION**

page **14**

FBS1423
23.0 cubic inches

For **NEW and Existing CONSTRUCTION**

Mounts Between Joists Adjustable Brackets

pages **6-7**

For **NEW CONSTRUCTION**

FBRS415
15.6 cubic inches

FBRS407R
8.0 cubic inches

For **RETROFIT**

FBRS420R
2" depth
20.0 cubic inches



Steel & Plastic

Side Mount Plastic Box with Steel Bracket

page **13**

FB417S
20.0 cubic inches
Low profile
FB417SLP
20.0 cubic inches



Most of Arlington's fan boxes ship with an installed NM cable connector, mud cover in place and captive installation screws for both the box and the fan/fixture mounting bracket.

For Any Suspended Ceiling Frame

page **8**

FBRS420SC, FS420SCL
2" depth
20.0 cubic inches

Steel



MB8
6.1 cubic inches



8" Mounting Block

page **14**

Arlington's fan/fixture boxes are patented (or other patents pending).

Each of our boxes is UL Listed to hold fans and fixtures of a specific weight; generally from 35 to 200 lbs., depending on the box. In addition, our non-metallic boxes offer a 2-hour fire rating.



For ceilings up to 1-1/2" thick.

Applications include:

- 1/2" or 5/8" drywall
- Double drywall
- Drywall mounted to hat channel, or furring strips, then to the joist
- Single or double joists



FBS405
for 1/2" and 5/8" drywall
FBS407
for 5/8" drywall

Designed for 1/2" or 5/8" drywall ceilings, our cost-effective, plated steel FBS405 and FBS407 pan boxes mount directly to a ceiling joist for a super-secure installation.

- For **NEW CONSTRUCTION**
- **UL Rated for 70 lb. fans; 200 lb. fixtures**
- **CSA Rated for 50 lb. fan or fixture**

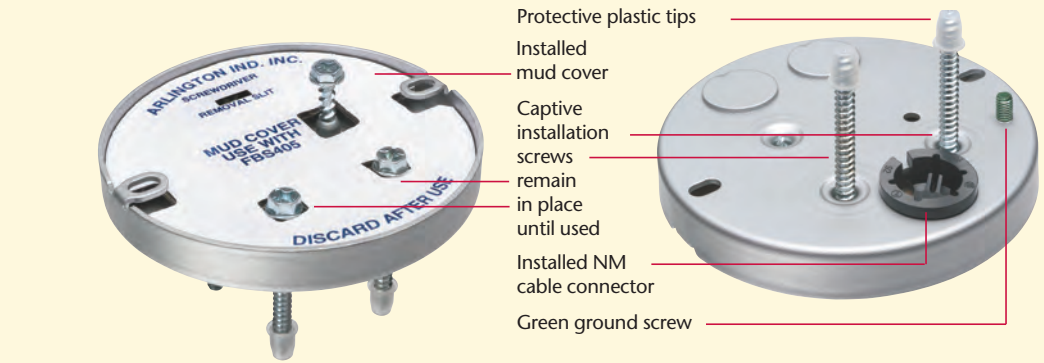

Item #	UPC/DCI/NAED MFG #01 899	Cubic Inches	Ceiling Thickness	Unit/Std Pkg
FBS405	76185	6.0	1/2", 5/8"	25
FBS407	76187	8.0	5/8"	25
*FBS405T	40500	6.0	1/2", 5/8"	25
*FBS407T	40700	8.0	5/8"	25

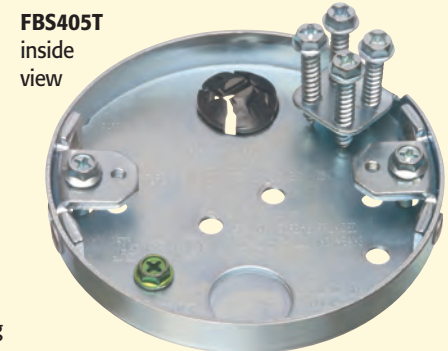

* with threaded openings and #10 screws (supplied) for mounting fan/fixture bracket.



- 1** Secure installation! Box mounts directly to joist with captive screw near center.
- 2** Convenient. Drill (2) 1/8" dia. holes into joist through elongated openings on each side of box. Remove the (2) screws noted above. Use to mount the bracket...
- 3** Easy. Mount bracket into the holes with the (2) long screws removed previously. Mount fan/fixture per manufacturer's instructions.

Most of Arlington's Fan/Fixture boxes ship with an installed NM cable connector and mud cover – As well as captive installation screws for the box and bracket.

No parts to lose or misplace... they ship ready to use!



Mount Under Joist

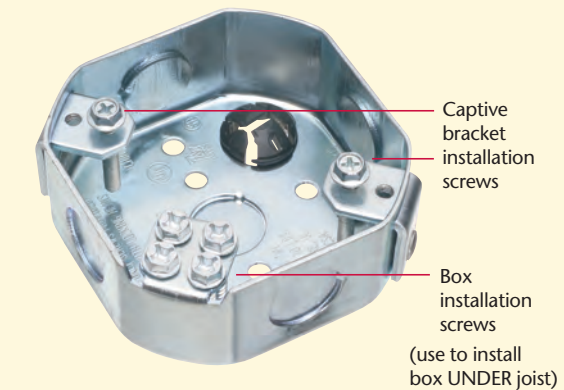

- 1** Install FBS415/FBS420 box under the joist using the captive screws from the break-off tab.

NO LOOSE PARTS! Box and bracket installation screws ship captive, and stay in place until you're ready to use them.

Item #	UPC/DCI/NAED MFG #01 899	Cubic Inches	Under Joist Box Depth	Unit/Std Pkg
FBS415	75204	14.6	1-1/2"	25
FBS420	75200	20.0	2"	25

Side Mount

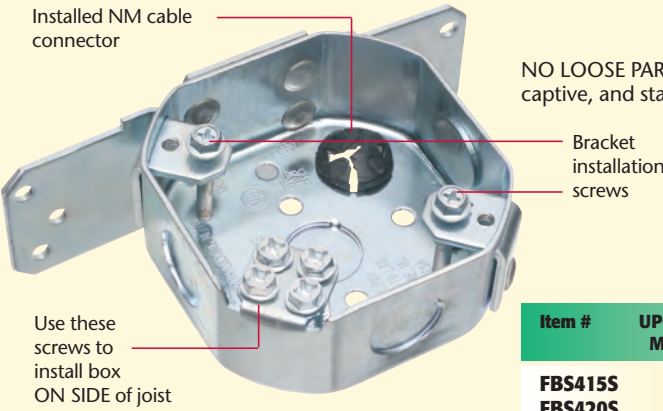

NO LOOSE PARTS! Box and bracket installation screws ship captive, and stay in place until you're ready to use them.

Item #	UPC/DCI/NAED MFG #01 899	Cubic Inches	Side Mount Box Depth	Unit/Std Pkg
FBS415S	75206	14.6	1-1/2"	25
FBS420S	75202	20.0	2"	25

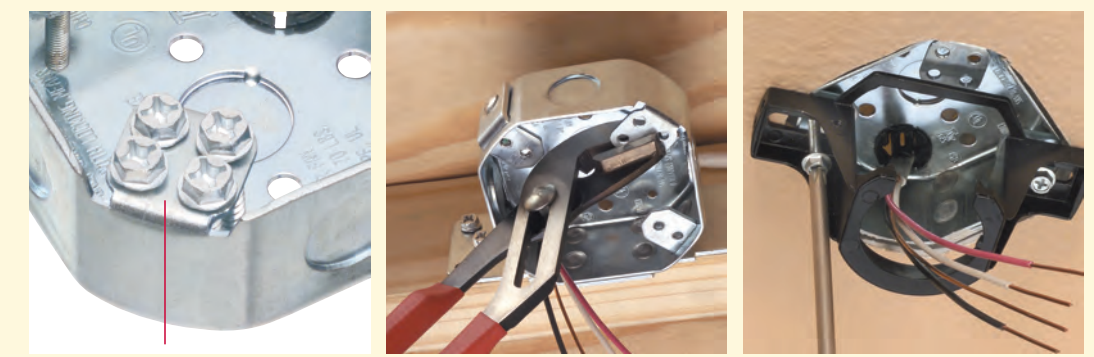

- 1** Install FBS415S/FBS420S box on the side of the joist using the (4) captive screws removed from the break-off tab.
- 2** OPTION: Remove break-off tab with pliers.
- 3** Remove the bracket installation screws noted above. Use them to mount fan/fixture bracket to the box.

FBS415
1-1/2" deep steel box
FBS420
2" deep steel box

Arlington's octagonal steel boxes mount directly to a joist for a strong, safe fan or fixture installation. Available in two depths (1-1/2" and 2"), and two styles.

Combination hex/Phillips head screws provide easy installation with power screwdrivers.

FBS415 and FBS420 mount securely UNDER the joist.

- **UL Rated for fans/fixtures up to 70 lbs.**
- **CSA Rated for 50 lb. fan or fixture**

FBS415S
1-1/2" deep steel box
FBS420S
2" deep steel box

FBS415S and FBS420S mount on the SIDE of the joist.

Below installer removes captive screws in preparation for installing box to side of joist.

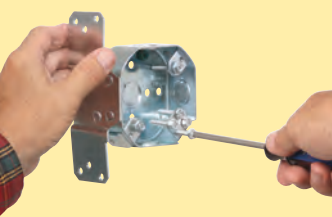

- **UL Rated for fans/fixtures up to 70 lbs.**
- **CSA Rated for 50 lb. fan or fixture**

Plated Steel Boxes with fully adjustable mounting brackets

FBRS415

for New Construction

Arlington's super heavy-duty, plated steel fan/fixture boxes, with fully adjustable mounting brackets, are the innovative alternative to existing bar hanger brackets. Their heavy-duty construction eliminates fan wobble.

Plus, FBRS415 for new construction and FBRS420R, FBRS407R for retrofit, ship ready to use, with all mounting hardware secured in the assembly. There are no bagged parts or pieces to lose.

■ For ceilings up to 1-1/4" thick

■ Mounts easily, securely between joists 16" to 24" on-center (o.c.)

■ Versatile 16" to 24" o.c. positioning between joists

■ 15.6 cubic inch

■ UL Rated:
Fans/fixtures:
up to 70 lbs. at 24" o.c.
up to 110 lbs. at 16" o.c.

■ CSA: Fans/fixtures
up to 50 lbs.

■ Competitively priced!

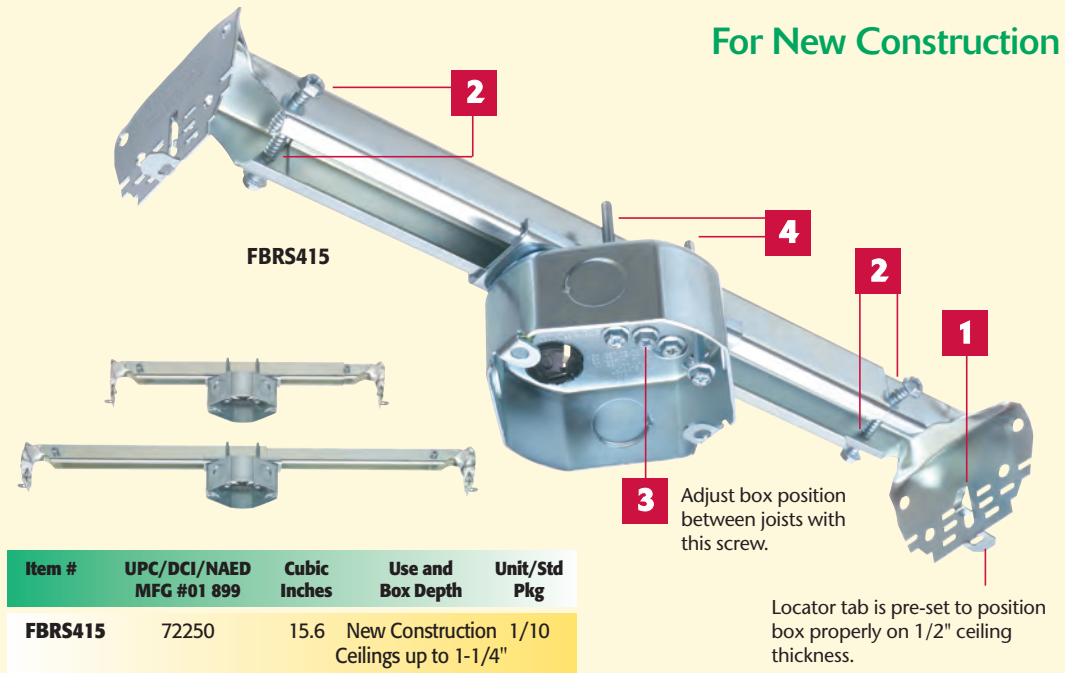

Item #	UPC/DCI/NAED MFG #01 899	Cubic Inches	Use and Box Depth	Unit/Std Pkg
FBRS415	72250	15.6	New Construction Ceilings up to 1-1/4"	1/10

3 Adjust box position between joists with this screw.
Locator tab is pre-set to position box properly on 1/2" ceiling thickness.



1 "Tooth" holds bracket temporarily in place.



2 Remove screws from both ends of bracket. Use them to attach bracket to joists.



3 Adjust box position from 16" to 24" o.c. between joists.

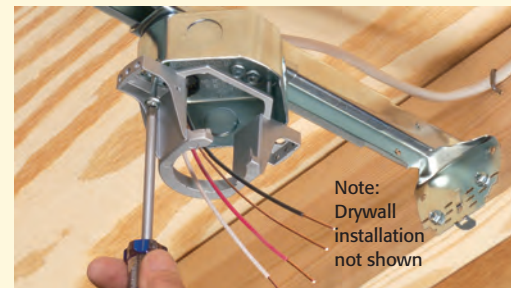

4 Install fan mounting bracket.
Note: Drywall installation not shown

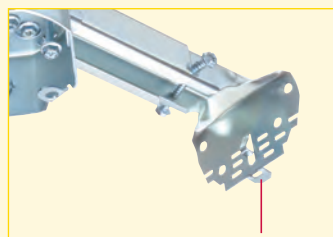

CONVENIENT. Tab positions box flush on 1/2" ceiling. Fits ceilings up to 1-1/4" thick. Bracket is scored for ease of installation.



FLEXIBLE. For flush ceiling installations on ceilings over 1/2" thick, bend the bracket along the scoreline that matches the ceiling depth.



A GREAT FINISH. FBRS415 flush ceiling installation.

For New Construction

Plated Steel Boxes with fully adjustable mounting brackets

For Existing Construction

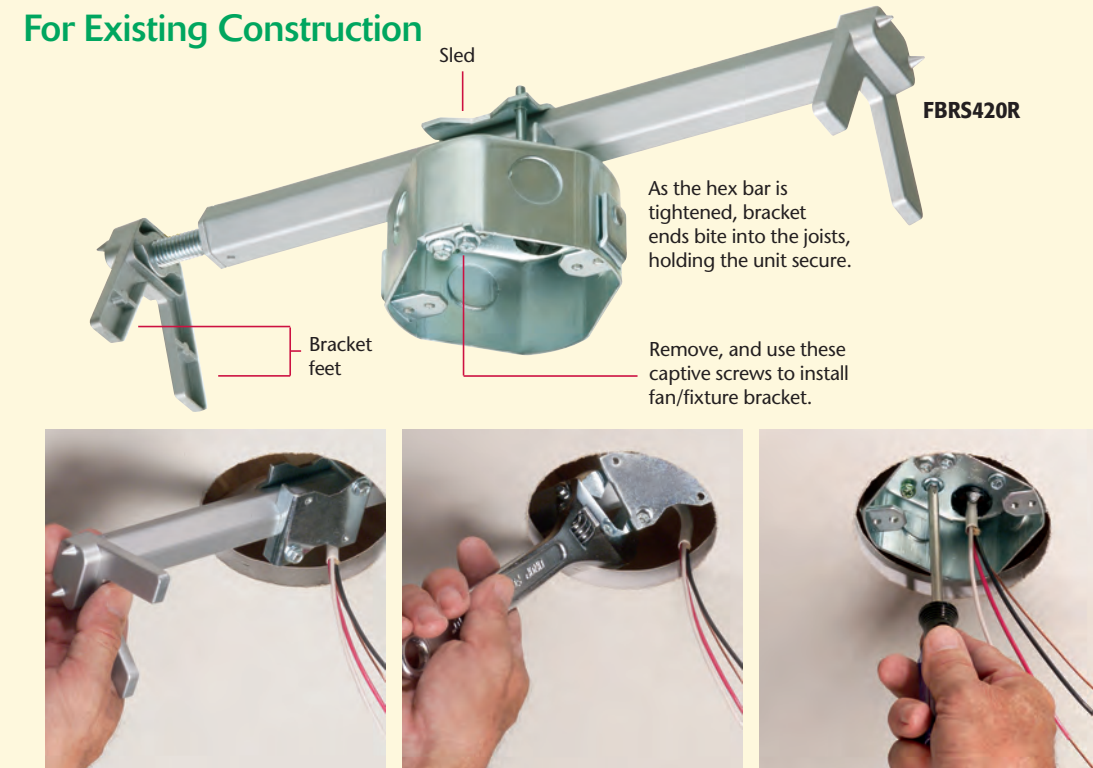

1 Cut hole in ceiling. Remove box from sled and fit mounting bracket into hole. Position bracket between joists, with bracket feet resting on the ceiling.

2 Tighten the hex bar with a wrench to secure bracket between joists.

3 Reattach box, and center it in hole. Attach bracket with screws supplied. Install fan/fixture per manufacturer's instructions.

For Wood I-Beams in Existing Construction

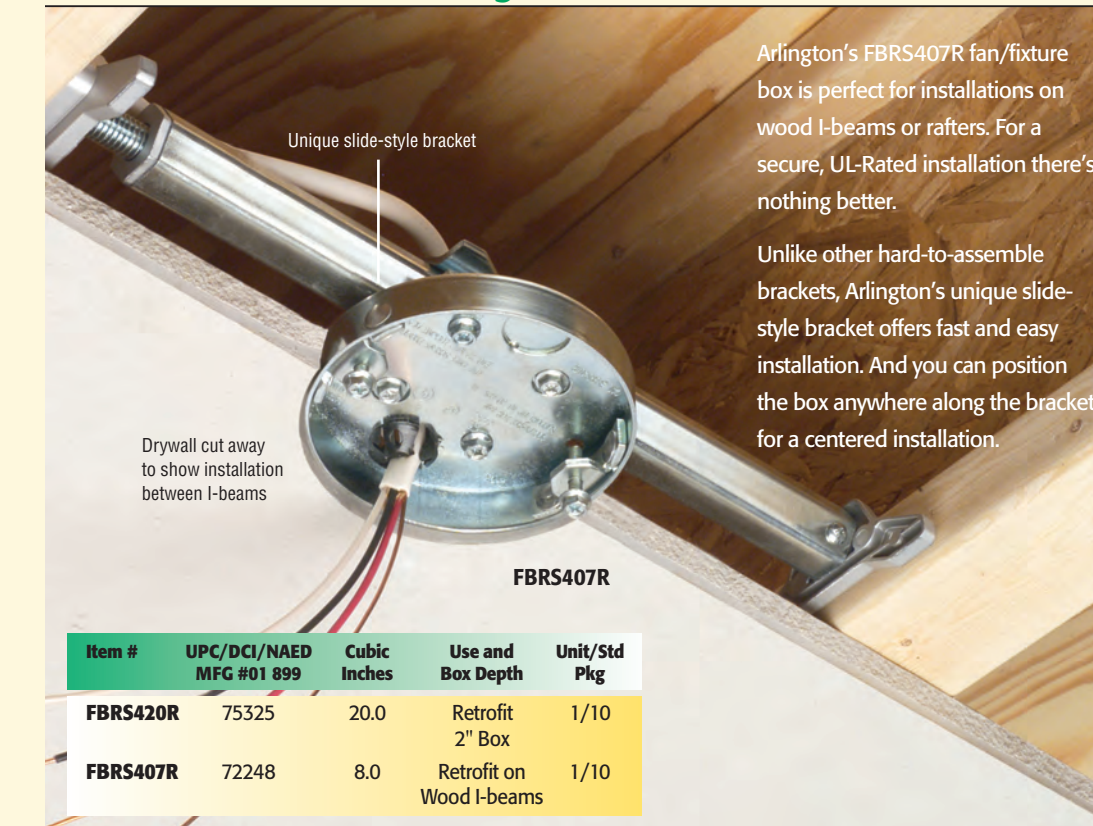

Item #	UPC/DCI/NAED MFG #01 899	Cubic Inches	Use and Box Depth	Unit/Std Pkg
FBRS420R	75325	20.0	Retrofit 2" Box	1/10
FBRS407R	72248	8.0	Retrofit on Wood I-beams	1/10

Arlington's FBRS407R fan/fixture box is perfect for installations on wood I-beams or rafters. For a secure, UL-Rated installation there's nothing better.

Unlike other hard-to-assemble brackets, Arlington's unique slide-style bracket offers fast and easy installation. And you can position the box anywhere along the bracket for a centered installation.

FBRS420R

for Existing Construction

■ Mounts between joists or rafters 16" to 24" o.c.

■ 20.0 cubic inch

■ UL Rated:
35 lb. fans,
50 lb. fixtures

■ CSA: Fans/fixtures
up to 50 lbs.

FBRS407R

for Wood I-Beams in Existing Construction

■ Box installs flush with ceiling drywall

■ For 1/2" and 5/8" thick ceilings

■ No parts to lose – ships with captive box adjustment screws, fan bracket installation screws and an installed NM cable connector

■ 8.0 cubic inch box

■ For existing construction on wood I-beams or rafters set 16 to 24 inches on-center

■ Listed to new UL standards

■ UL rating
35 lb. fan • 50 lb. fixture



Arlington

Fan/Fixture Box Kit for Suspended Ceilings

Designed just for mounting a fan or fixture on a suspended ceiling grid, Arlington's FBRS420SC fan/fixture box kit saves money! And 30 minutes of installation time.

The box/bracket assembly ships with the box mounted securely on-center, ready to install on a 24" grid. For a centered installation, there's no need to adjust the box or bracket, but you can position the box where you want it.

There are no parts to lose! FBRS420SC ships fully assembled. Installation and adjustment screws ship parked in place. There's an installed NM cable connector too.

- Fully adjustable mounting bracket
- 2" deep, 20.0 cubic inch box
- Meets new UL standards
- UL Rating: 70 lb fan or fixture
CSA: Acceptable for fan support
- Usable for Environmental Air Handling spaces



1 Cut a 4-1/16" diameter hole in a 24" ceiling tile.



2 Place box over hole. Place ends of support bar over the ceiling grid (tees).



3 Use the "S" hooks provided to attach chain to turnbuckle, and chain to the overhead support. Use turnbuckle to apply tension to the chain, so it supports the weight of fan.



4 Remove captive screws (shown above). Use them to install the fan or fixture per manufacturer's specifications, NEC and all local electrical codes.

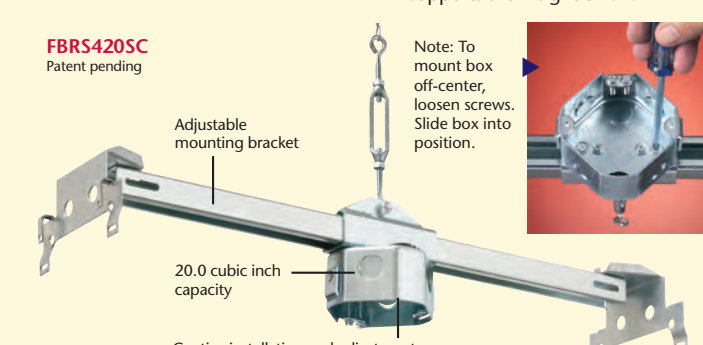

Kit includes box/bracket assembly with turnbuckle, 12' heavy-duty chain, and (2) "S" hooks.

Item #	UPC/DCI/NAED MFG #01 899	Box	Description	Unit/Std Pkg
FBRS420SC	75300	2" deep 20.0 cu. in.	Fan/Fixture box kit for suspended ceilings	1/5



Fixture Box for Suspended Ceilings

UL Listed for fixtures up to 50 lbs.

Costs less than the 70 lb. rated FBRS420SC.

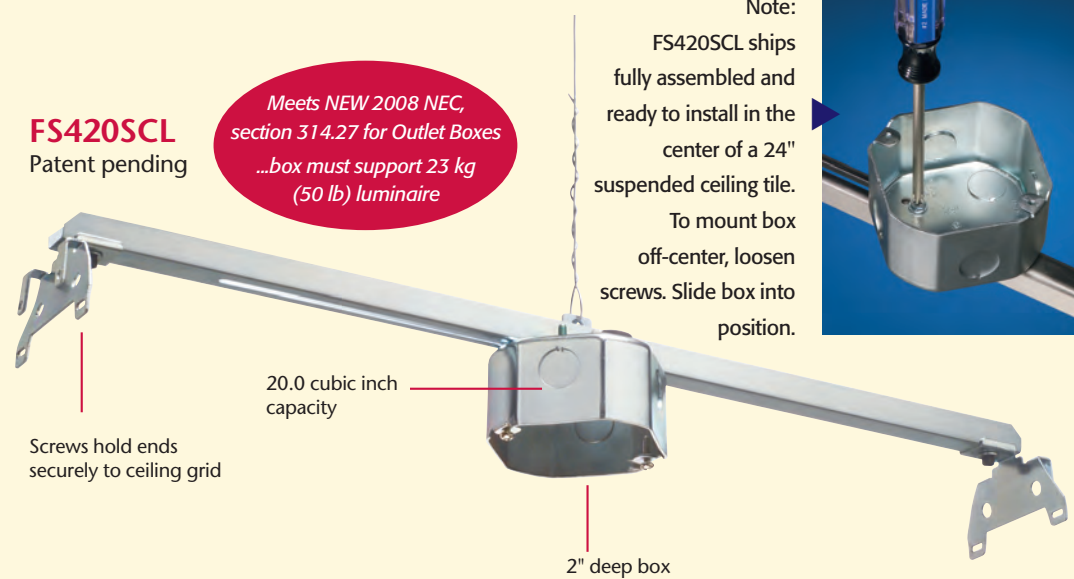

1 Cut a 4-1/16" diameter hole in a 24" ceiling tile.

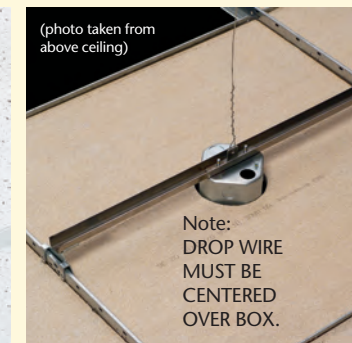

2 Place box over hole.



3 Snap ends of support bar over the ceiling grid (tees).



4 Cable pulled through cable connector (not supplied).



5 Use FS420SCL to install fixtures, security cameras, etc. Not fan rated.



Arlington's new all-metal box, just for fixtures, is a one-piece assembly that ships ready to install on a 24" suspended ceiling grid – No assembly required.

It's tested and rated to support exit lights, security cameras – and other light fixtures up to 50 lbs.

No more guesswork. Installers who previously attached a metal box to a bracket in the field, then added a chain or wire for support, now have an assembly that is fully tested to hold up to 50 lbs!

If the box is not perfectly positioned, loosen the appropriate screws, slide the box along the bracket and retighten the screws.

- Easy, secure mounting to ceiling grid
- Costs less than field-assembled components (box, bracket, wire)
- Saves installation time
- Usable for Environmental Air Handling spaces



For FBRS420SC and FS420SCL
OPTION: If required by local code, use sheet metal screws (not supplied) to hold bracket ends on ceiling grid.

Item #	UPC/DCI/NAED MFG #01 899	Box	Description	Unit/Std Pkg
FS420SCL	12526	2" deep 20.0 cu. in.	Box for suspended ceilings, for fixtures up to 50 lbs.	1/10

One-piece, rated unit includes box, bracket and drop wire

- FB405**
for 1/2" and 5/8" drywall
- FB407**
for 5/8" drywall
- FB412**
for 1/2" or 5/8" drywall with hat channel or furring strips, or double drywall

FB405, FB407, and FB412 offer the flexible, economical solution to 1/2" and 5/8" drywall ceiling, with or without hat channel or furring strips. FB405 and FB407 are perfect for double joists or wood I-beams.

- **Fast, easy installation**
- **Secure attachment to joist or rafter**
- **No parts to lose**
- **2-hour fire rating**
- **UL Rated: 70 lb. fans, fixtures up to 200 lbs.**
- **CSA: Fans/fixtures up to 50 lbs.**

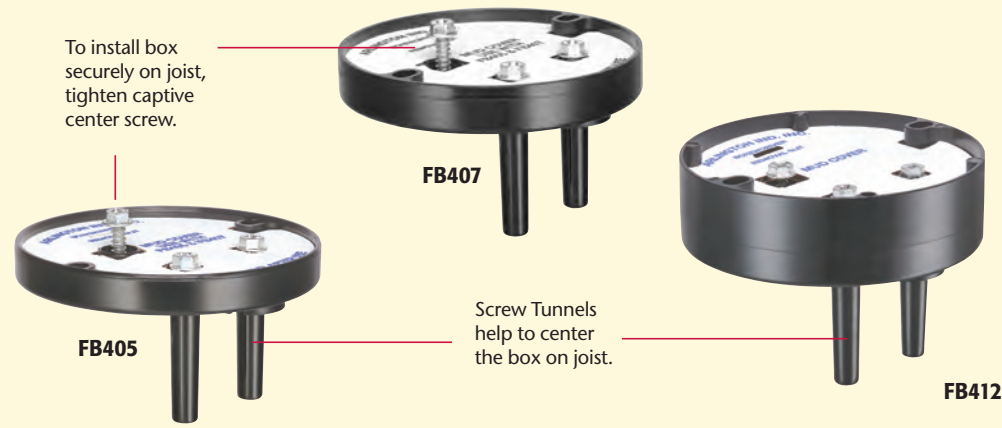

Box Installation



1 The FB412 fan/fixture box is perfect for 1/2" or 5/8" drywall with 3/4" furring strips or hat channel with a single layer of drywall...



2 ...or double drywall (shown as cutaway).

Item #	UPC/DCI/NAED MFG #01 899	Cubic Inches	Drywall Thickness	Unit/Std Pkg
FB405	72185	6.0	1/2" or 5/8"	25
FB407	72177	8.0	5/8"	25
FB412	72189	14.5	1/2" or 5/8" *	25

* w/ furring strips or hat channel with a single layer of drywall or with a double layer of drywall

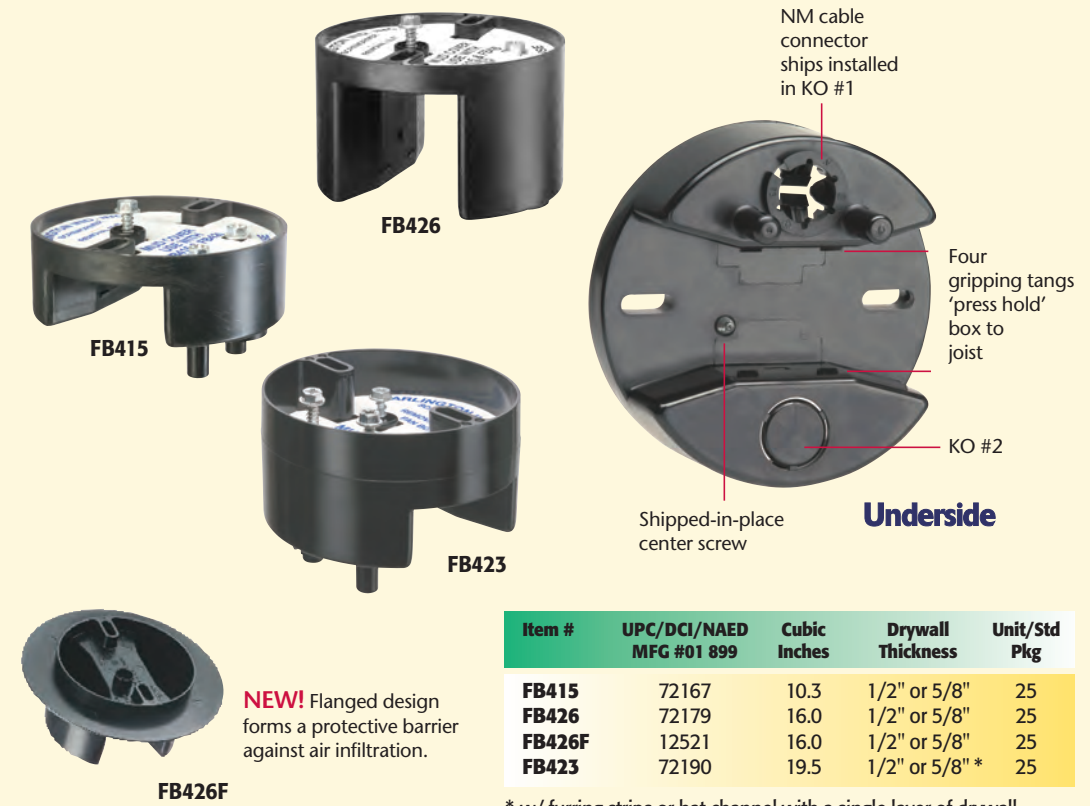

Item #	UPC/DCI/NAED MFG #01 899	Cubic Inches	Drywall Thickness	Unit/Std Pkg
FB415	72167	10.3	1/2" or 5/8"	25
FB426	72179	16.0	1/2" or 5/8"	25
FB426F	12521	16.0	1/2" or 5/8"	25
FB423	72190	19.5	1/2" or 5/8" *	25

* w/ furring strips or hat channel with a single layer of drywall or with a double layer of drywall



1 Convenient. Gripping tangs hold box in place temporarily, until the center screw is tightened.

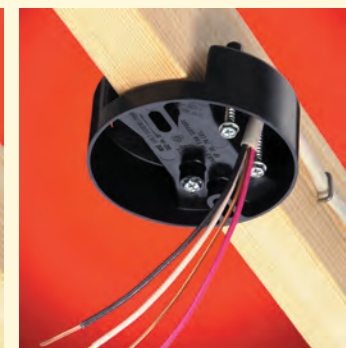

2 Push NM sheathed cable through the center connector.

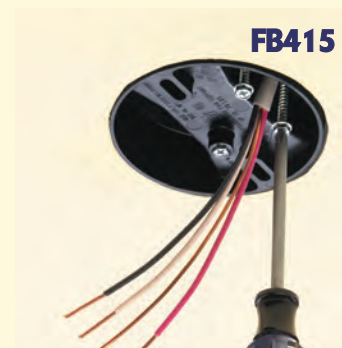

3 Remove (2) long parked screws. Use them to install bracket.



4 The fan/fixture bracket installs directly onto the joist through the oval slots in the box.

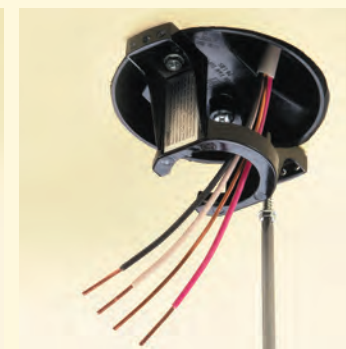

5 Cable pulled through installed NM cable connector.

All of Arlington's Fan/Fixture boxes ship with an installed NM cable connector and mud cover – as well as captive installation screws for the box and bracket.

No parts to lose or misplace...ready to use!

- FB415**
for 1/2" and 5/8" drywall
- FB426**
for 1/2" and 5/8" drywall
- FB423**
for 1/2" or 5/8" drywall with hat channel or furring strips with a single layer of drywall, or double drywall

FB415 and FB426 come with the screws you need to install the box and bracket, held captive until you're ready to use them.

Press Hold...Speed, Convenience, Safety

These boxes have gripping tangs that press-hold the box to the joist while you reach for your screwdriver. Tightening the center screw affixes the box onto the joist for a super-secure installation.

- **2-hour fire rating**
- **UL Rated: 70 lb. fans, fixtures up to 200 lbs.**
- **CSA: Fans/fixtures up to 50 lbs.**



Plastic Boxes

FB444

Our largest capacity L-shaped box

FB442

FB443

Lowest cost L-shaped boxes

FB444 is the largest capacity box we make! Its 25.6 cubic inch capacity provides plenty of room for wires – easy access too!

The slightly smaller FB443 and FB442 offer the same great features and benefits at a lower cost.

- Boxes mount to single or double joists or rafters with a shipped-in-place center screw

- Locator posts assure correct positioning of bracket

- UL Rated: 70 lb. fans, fixtures up to 200 lbs.

- CSA: Fans/fixtures up to 50 lbs.

- 2-hour fire rating

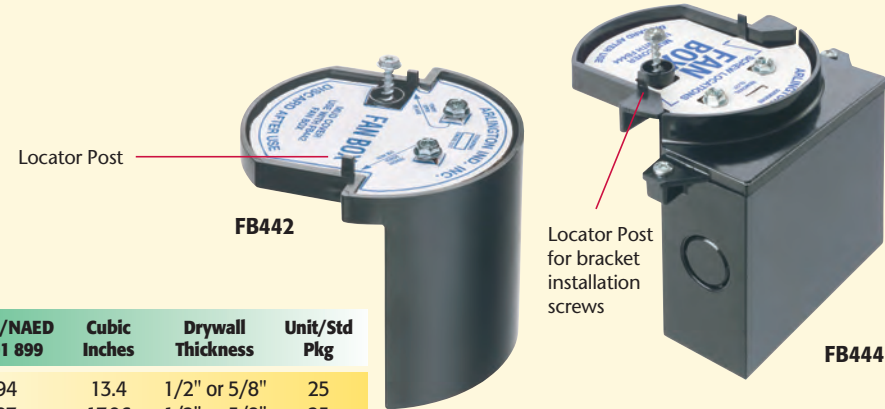

Item #	UPC/DCI/NAED MFG #01 899	Cubic Inches	Drywall Thickness	Unit/Std Pkg
FB442	72194	13.4	1/2" or 5/8"	25
FB443	72197	17.96	1/2" or 5/8"	25
FB444	72187	25.6	1/2" or 5/8"	25

FB442 Installation



- Secure!** Side mount the box to the joist using the shipped-in-place center screw.
- Pull wires.** (Drywall installation omitted) After ceiling is installed, remove captive installation screws – use them to install bracket.
- Done!** Install fan or fixture per manufacturer's instructions.

FB444 Installation



- Fast and easy installation** on single or double joists!
- Accurate!** Locator posts on these L-shaped boxes assure proper positioning of the installation bracket.



- Easy.** Bracket installation on FB444. (Drywall installation not shown)
- Easy access.** FB444 OPTION: To restuff wires, open bottom of the box – before drywall installation.



Plastic Boxes with Steel Bracket

Nail On Attachment to Single or Double Joists



Fast. Simply nail the box to the joist. Indicator lines on FB417S assure proper positioning on the joist for the ceiling thickness.



FB417S and FB417SLP side mount to single or double joists for a super-secure installation.

Item #	UPC/DCI/NAED MFG #01 899	Cubic Inches	Ceiling Thickness	Unit/Std Pkg
FB417S	72177	20.0	up to 1-1/2"	25
FB417SLP*	72199	20.0	1/2" or 5/8"	25

* Also works on manufactured I-beams

Most of Arlington's Fan/Fixture boxes ship with an installed NM cable connector and mud cover – As well as captive installation screws for the box and bracket.

No parts to lose or misplace... ready to use!

FB417S

for ceilings up to 1-1/2" thick, including single-sheeted drywall mounted to furring strips or hat channel – or double drywall

FB417SLP

Low profile for 1/2" or 5/8" ceilings

FB417S saves time! Nail on installation, and indicator marks for 1/2", 5/8", and 3/4" ceiling thicknesses make it the logical choice for speedy attachment to single or double joists.

For added convenience, use the low profile FB417SLP for 1/2" or 5/8" ceilings. Also works for manufactured I-beams.

Both ship ready to use, with the nail in place and captive bracket installation screws.

- No loose parts – totally self-contained

- Combination hex/Phillips head screws for easy installation with power screwdrivers

- Nail on installation

- 20.0 cubic inch

- 2-hour fire rating

- UL Rated: Fans/fixtures up to 70 lbs.

- CSA: Fans/fixtures up to 50 lbs.

8" Mounting Block with built-in box for fan and fixture installations

Fan/Fixture Boxes

MB8

6.1 Cubic inches

- Ceiling medallion and electrical box combined
- Supports flood lights, smoke detectors, fans, light fixtures – any fixture needing a safe, strong installation.
- UV rated plastic
- For interior or exterior use
- Mounts directly to soffit or ceiling joist without the need to cut ceiling drywall
- Paintable
- UL Rated: 70 lb. fan, 200 lb. fixture; CSA rated: 50 lb. fan/fixture

Canadian orders ship with grounding lug required by CSA for use with fixtures.



MB8 includes...

Two #10 x 3" wood screws, one #8 x 1-1/2" wood screw, two KOs, and one NM94 non-metallic cable connector.

Item #	UPC/DCI/NAED MFG #01 899	Cubic Inches	Use and Box Depth	Unit/Std Pkg
MB8	42330	6.1	Flat Mount	1/10

MB8 Installation

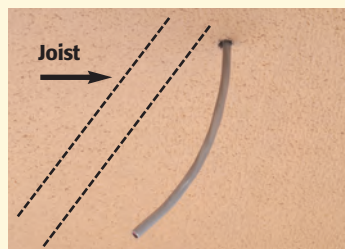

1 Locate the ceiling joist using a stud finder or similar device. Drill a hole approximately 1/2" in diameter, in the ceiling next to the joist. Remove desired knockout. Insert the cable connector into the opening. Pull the NM cable through the connector.



2 Using the #8 x 1-1/2" wood screws provided, mount the MB8 to the joist (through the ceiling).



3 Install the fixture or fan mounting bar (provided with the fixture or fan) directly to the joist with the (2) #10 x 3" wood screws and lock washers provided. Wire the fixture or fan following the instructions included with the product.

Steel Box – Side Mounts to Joist NEW!

FBS1423

23.0 Cubic inches

Designed for new construction or retrofit, this deep steel box side mounts to a joist for a super secure, fan-rated installation.

- UL Rated for fans/fixtures up to 70 lbs.
- CSA: Fans/fixtures up to 50 lbs.

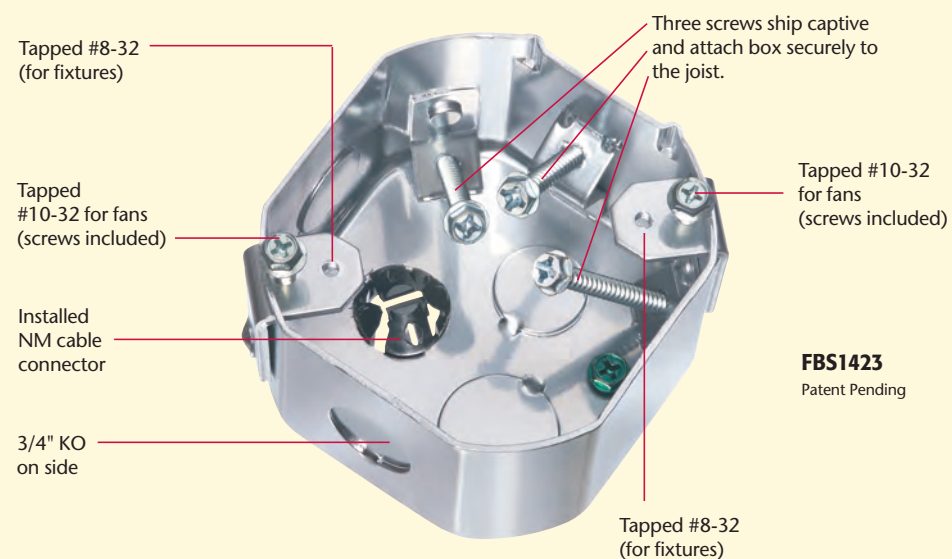

Place box at proper depth; attach to joist with three captive screws in the box.

Item #	UPC/DCI/NAED MFG #01 899	Cubic Inches	Side Mount Box Depth	Unit/Std Pkg
FBS1423	76190	23.0	2.375"	10

Fan/Fixture Box Rating and # of Single Conductors

Catalog Number	Category	Cubic Inches (Lbs.)	UL Fan Load Rating (Lbs.)	CSA Fan Load Rating (Lbs.)	UL Fixture Static Rating (Lbs.)	CSA Fixture Static Rating	# Of Single Conductors		
							#14	or #12	or #10
FB405	PLASTIC	6.0	70	50	200	50	3	—	—
FB4050	PLASTIC	6.0	70	50	200	50	3	—	—
FB407	PLASTIC	8.0	70	50	200	50	4	3	3
FB4070	PLASTIC	8.0	70	50	200	50	4	3	3
FB412	PLASTIC	14.4	70	50	200	50	7	6	5
FB415	PLASTIC	10.3	70	50	200	50	5	4	4
FB4150	PLASTIC	10.3	70	50	200	50	5	4	4
FB417S	PLASTIC & STEEL	20.0	70	50	70	50	10	8	8
FB417SLP	PLASTIC & STEEL	20.0	70	50	70	50	10	8	8
FB423	PLASTIC	19.5	70	50	200	50	9	8	7
FB426	PLASTIC	16.0	70	50	200	50	8	7	6
FB426F	PLASTIC	16.0	70	50	200	50	8	7	6
FB442	PLASTIC	13.4	70	50	200	50	6	4	4
FB443	PLASTIC	17.96	70	50	200	50	8	7	7
FB444	PLASTIC	25.6	70	50	200	50	13	11	10
FB450	PLASTIC	14.5	70	50	200	50	7	6	5
FB900	PLASTIC	14.5	70	50	200	50	7	6	5
FBRS407R	STEEL	8.0	35	50	50	50	4	3	3
FBRS415	STEEL	15.6	70 @ 24" o.c. 110 @ 16" o.c.	50	70 @ 24" o.c. 110 @ 16" o.c.	50	7	6	6
FBRS420R	STEEL	20.0	35	50	50	50	10	8	8
FBRS420SC	STEEL	20.0	35	50	50	50	10	8	8
FBS1423	STEEL	23.0	70	50	70	50	11	10	9
FBS405	STEEL	6.0	70	50	200	50	3	—	—
FBS405T	STEEL	6.0	70	50	200	50	3	—	—
FBS407	STEEL	8.0	70	50	200	50	4	3	3
FBS407T	STEEL	8.0	70	50	200	50	4	3	3
FBS415	STEEL	14.6	70	50	200	50	7	6	6
FBS415S	STEEL	14.6	70	50	70	50	7	6	6
FBS420	STEEL	20.0	70	50	200	50	10	8	8
FBS420S	STEEL	20.0	70	50	70	50	10	8	8
FBX900	PLASTIC & STEEL	14.5	70	50	70	50	7	6	5
FS420SCL	STEEL	20.0	—	—	25	25	10	8	8
MB8	PLASTIC	6.1	70	50	200	50	3	—	—

Most of of Arlington's Fan/Fixture boxes ship with an installed NM cable connector and mud cover – As well as captive installation screws for the box and bracket.

No parts to lose or misplace...ready to use!

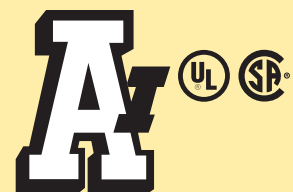

Arlington



Arlington

SAVE MONEY!

FAN/FIXTURE BOX just for SUSPENDED CEILINGS



pg 8

Save 30 minutes of assembly time with Arlington's new fan/fixture box. It ships with the box and bracket assembly mounted on center, ready to install on a 24" suspended ceiling grid.

- No parts to lose
- Installation and adjustment screws ship captive
- 2" deep, 20.0 cu. inch box

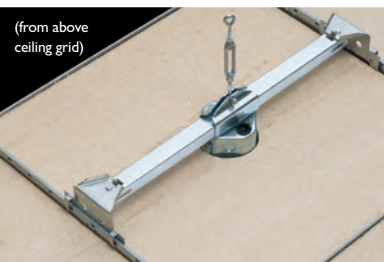

FLUSH WITH CEILING

FAN/FIXTURE BOX with ADJUSTABLE BRACKET

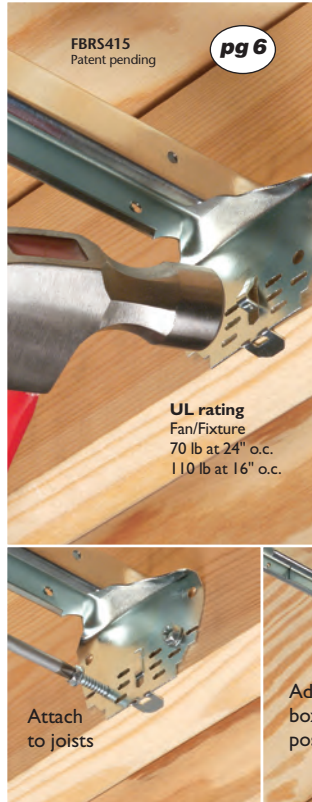

pg 6

Arlington's heavy-duty, plated steel fan/fixture box has an adjustable bracket that fits 16" to 24" o.c.

Flush ceiling installations!
FBR5415 is designed for ceilings up to 1-1/4" thick. For 1/2" ceilings, use the pre-bent positioning tab.

For other ceiling thicknesses, bend along the appropriate score line.

- 15.6 cu. inch box
- Ships with captive screws, mud cover, installed NM cable connector

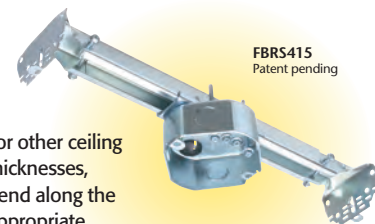

FIXTURE BOX TESTED WEIGHT RATING LISTED AS 1-PIECE UNIT

for SUSPENDED CEILINGS

pg 9



Mounts fixtures securely to the ceiling grid



Arlington's new all-metal, one-piece fixture box ships ready to install on a 24" suspended ceiling grid. There's no assembly required!

It's tested and rated to support exit lights, security cameras and other light fixtures up to 50 lbs.

No more guesswork. Installers who attached a metal box to a bracket in the field, then added a chain or wire for support, now have an assembly that's *fully tested* to hold up to 50 lbs!

FS420SCL is UL/CSA Listed as a complete unit: box, bracket, drop wire.

- Box can be positioned anywhere along bracket
- Costs less than field-assembled components (box, bracket, wire)
- Usable for Environmental Air Handling spaces

Distributed by



Arlington

1 Stauffer Industrial Park
Scranton, PA 18517
800/233.4717
Fax 570/562.0646
www.aifittings.com

©2008 Arlington Industries, Inc.

Arlington's fan/fixture boxes are patented (or other patents pending).



FAN & FIXTURE BOXES

FOR A VARIETY OF USES



Choose the Fan or Fixture Box that's right for you...

...in Steel or Plastic – or a Combination!

No matter what your needs – or installation preferences, Arlington has a fan/fixture box to fit.

We manufacture a variety of steel and non-metallic boxes in many depths and cubic inch capacities that install directly to the joist(s) for an extra-secure installation.

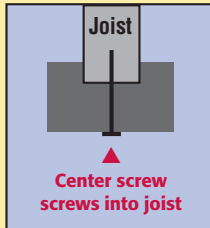

Our boxes that mount to the bottom of a joist deliver a safe, secure installation because both the box and the bracket install directly to the joist!

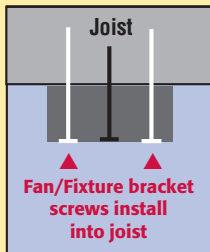

Plus, we have a box for every ceiling condition!

Joist Mount

page **4**

FBS405, FBS405T
6.0 cubic inches
FBS407, FBS407T
8.0 cubic inches

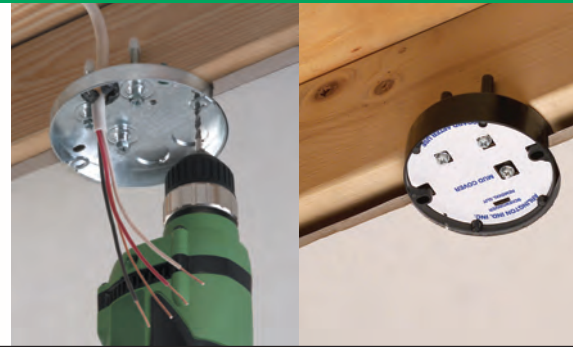
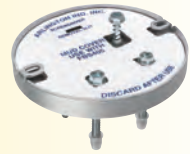

FB405
6.0 cubic inches
FB407
8.0 cubic inches
FB412
14.4 cubic inches



Joist Mount

page **10**

Under-Joist Mount

page **5**

FBS415
1-1/2" depth
14.6 cubic inches
FBS420
2" depth
20.0 cubic inches



FB415
10.3 cubic inches
FB423
19.5 cubic inches
FB426
16.0 cubic inches



Press Hold Joist Mount

page **11**

Side Mount

page **5**

FBS415S
1-1/2" depth
14.6 cubic inches
FBS420S
2" depth
20.0 cubic inches

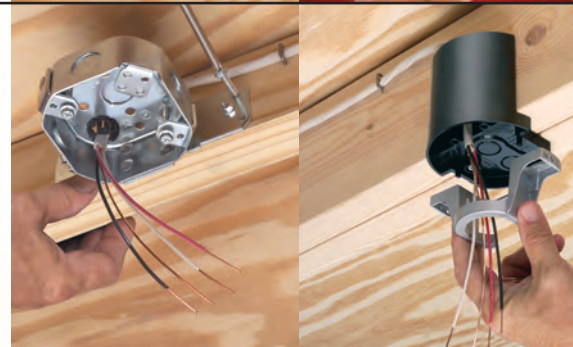

FB442
13.4 cubic inches
FB443
17.96 cubic inches
FB444
25.6 cubic inches



Side Mount

page **12**

page **14**

FBS1423
23.0 cubic inches

For NEW and Existing CONSTRUCTION

Mounts Between Joists Adjustable Brackets

pages **6-7**

For NEW CONSTRUCTION

FBRS415
15.6 cubic inches

FBRS407R
8.0 cubic inches

For RETROFIT

FBRS420R
2" depth
20.0 cubic inches

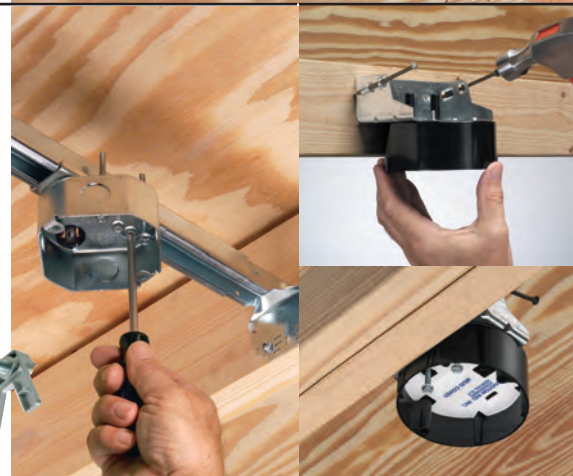

Steel & Plastic

FB417S
20.0 cubic inches
Low profile
FB417SLP
20.0 cubic inches



Side Mount Plastic Box with Steel Bracket

page **13**

For Any Suspended Ceiling Frame

page **8**

FBRS420SC, FS420SCL
2" depth
20.0 cubic inches

Steel



MB8
6.1 cubic inches



8" Mounting Block

page **14**

Each of our boxes is UL Listed to hold fans and fixtures of a specific weight; generally from 35 to 200 lbs., depending on the box. In addition, our non-metallic boxes offer a 2-hour fire rating.



For ceilings up to 1-1/2" thick.

Applications include:

- 1/2" or 5/8" drywall
- Double drywall
- Drywall mounted to hat channel, or furring strips, then to the joist
- Single or double joists

Most of Arlington's fan boxes ship with an installed NM cable connector, mud cover in place and captive installation screws for both the box and the fan/fixture mounting bracket.



Arlington's fan/fixture boxes are patented (or other patents pending).



FBS405
for 1/2" and 5/8" drywall
FBS407
for 5/8" drywall

Designed for 1/2" or 5/8" drywall ceilings, our cost-effective, plated steel FBS405 and FBS407 pan boxes mount directly to a ceiling joist for a super-secure installation.

- For NEW CONSTRUCTION
- UL Rated for 70 lb. fans; 200 lb. fixtures
- CSA Rated for 50 lb. fan or fixture

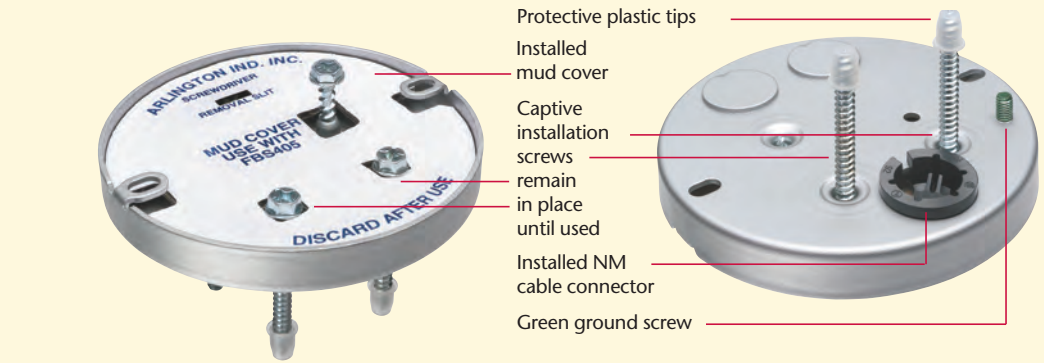

Item #	UPC/DCI/NAED MFG #01 899	Cubic Inches	Ceiling Thickness	Unit/Std Pkg
FBS405	76185	6.0	1/2", 5/8"	25
FBS407	76187	8.0	5/8"	25
*FBS405T	40500	6.0	1/2", 5/8"	25
*FBS407T	40700	8.0	5/8"	25

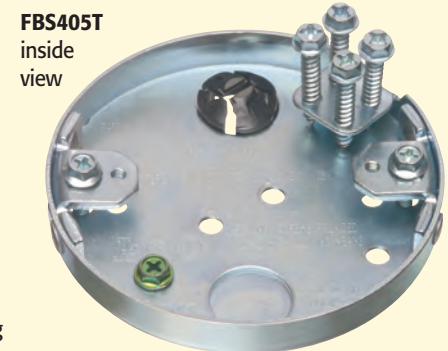

* with threaded openings and #10 screws (supplied) for mounting fan/fixture bracket.

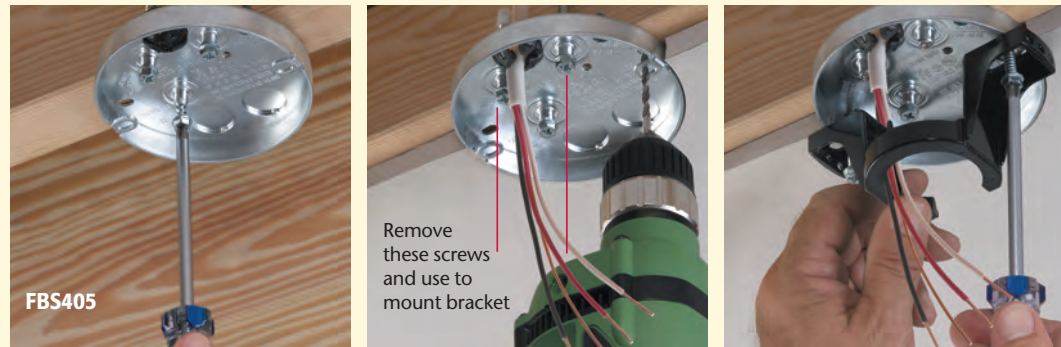

- 1 Secure installation! Box mounts directly to joist with captive screw near center.
- 2 Convenient. Drill (2) 1/8" dia. holes into joist through elongated openings on each side of box. Remove the (2) screws noted above. Use to mount the bracket...
- 3 Easy. Mount bracket into the holes with the (2) long screws removed previously. Mount fan/fixture per manufacturer's instructions.

Most of Arlington's Fan/Fixture boxes ship with an installed NM cable connector and mud cover – As well as captive installation screws for the box and bracket.

No parts to lose or misplace... they ship ready to use!

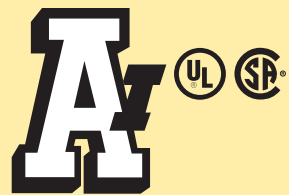

Arlington

Mount Under Joist

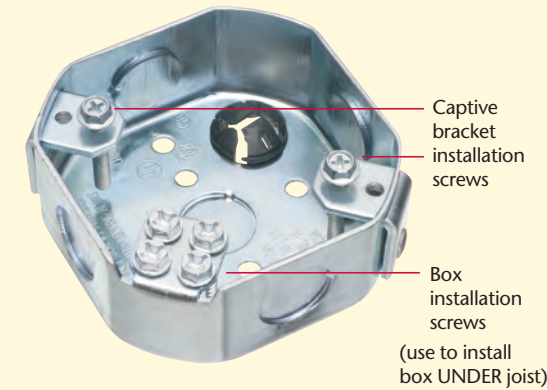

1 Install FBS415/FBS420 box under the joist using the captive screws from the break-off tab.

NO LOOSE PARTS! Box and bracket installation screws ship captive, and stay in place until you're ready to use them.

Item #	UPC/DCI/NAED MFG #01 899	Cubic Inches	Under Joist Box Depth	Unit/Std Pkg
FBS415	75204	14.6	1-1/2"	25
FBS420	75200	20.0	2"	25

Side Mount

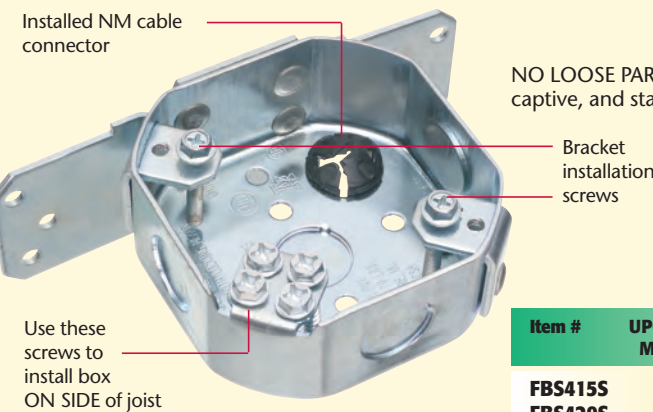

NO LOOSE PARTS! Box and bracket installation screws ship captive, and stay in place until you're ready to use them.

Item #	UPC/DCI/NAED MFG #01 899	Cubic Inches	Side Mount Box Depth	Unit/Std Pkg
FBS415S	75206	14.6	1-1/2"	25
FBS420S	75202	20.0	2"	25

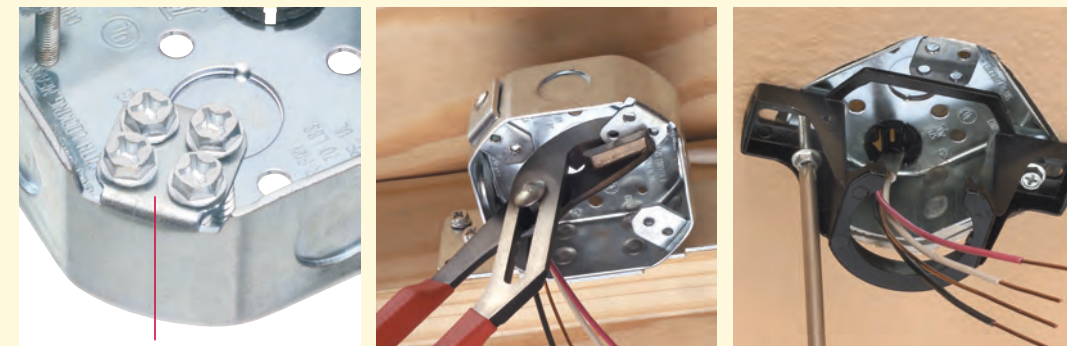

- 1 Install FBS415S/FBS420S box on the side of the joist using the (4) captive screws removed from the break-off tab.
- 2 OPTION: Remove break-off tab with pliers.
- 3 Remove the bracket installation screws noted above. Use them to mount fan/fixture bracket to the box.

FBS415
1-1/2" deep steel box
FBS420
2" deep steel box

Arlington's octagonal steel boxes mount directly to a joist for a strong, safe fan or fixture installation. Available in two depths (1-1/2" and 2"), and two styles.

Combination hex/Phillips head screws provide easy installation with power screwdrivers.

FBS415 and FBS420 mount securely UNDER the joist.

- UL Rated for fans/fixtures up to 70 lbs.
- CSA Rated for 50 lb. fan or fixture

FBS415S
1-1/2" deep steel box
FBS420S
2" deep steel box

FBS415S and FBS420S mount on the SIDE of the joist.

Below installer removes captive screws in preparation for installing box to side of joist.

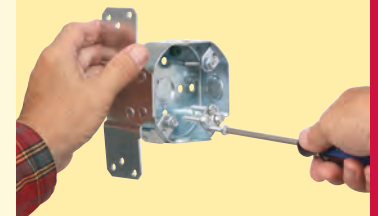

- UL Rated for fans/fixtures up to 70 lbs.
- CSA Rated for 50 lb. fan or fixture

Plated Steel Boxes with fully adjustable mounting brackets

FBRS415

for New Construction

Arlington's super heavy-duty, plated steel fan/fixture boxes, with fully adjustable mounting brackets, are the innovative alternative to existing bar hanger brackets. Their heavy-duty construction eliminates fan wobble.

Plus, FBRS415 for new construction and FBRS420R, FBRS407R for retrofit, ship ready to use, with all mounting hardware secured in the assembly. There are no bagged parts or pieces to lose.

■ For ceilings up to 1-1/4" thick

■ Mounts easily, securely between joists 16" to 24" on-center (o.c.)

■ Versatile 16" to 24" o.c. positioning between joists

■ 15.6 cubic inch

■ UL Rated:
Fans/fixtures:
up to 70 lbs. at 24" o.c.
up to 110 lbs. at 16" o.c.

■ CSA: Fans/fixtures
up to 50 lbs.

■ Competitively priced!

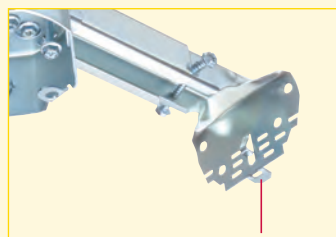
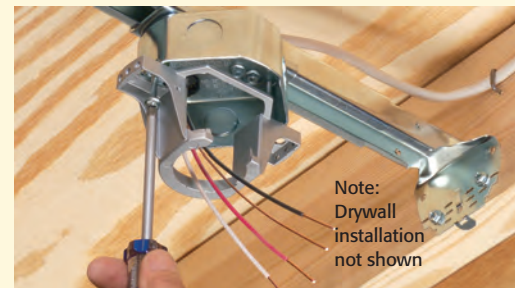
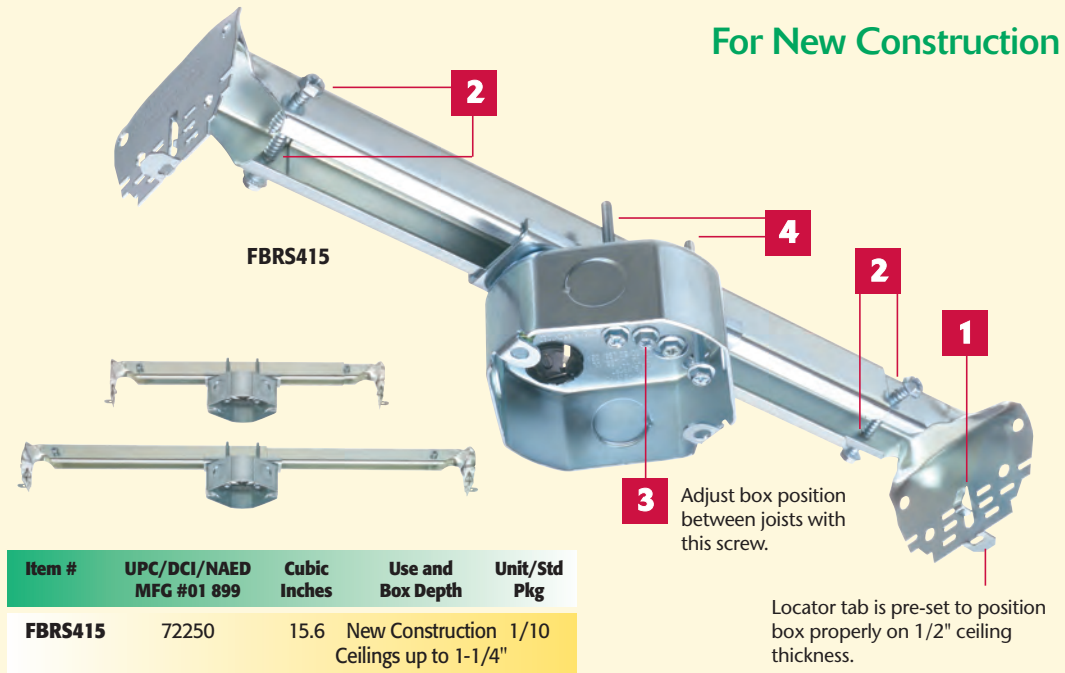

Plated Steel Boxes with fully adjustable mounting brackets

FBRS420R

for Existing Construction

■ Mounts between joists or rafters 16" to 24" o.c.

■ 20.0 cubic inch

■ UL Rated:
35 lb. fans,
50 lb. fixtures

■ CSA: Fans/fixtures
up to 50 lbs.

For Existing Construction

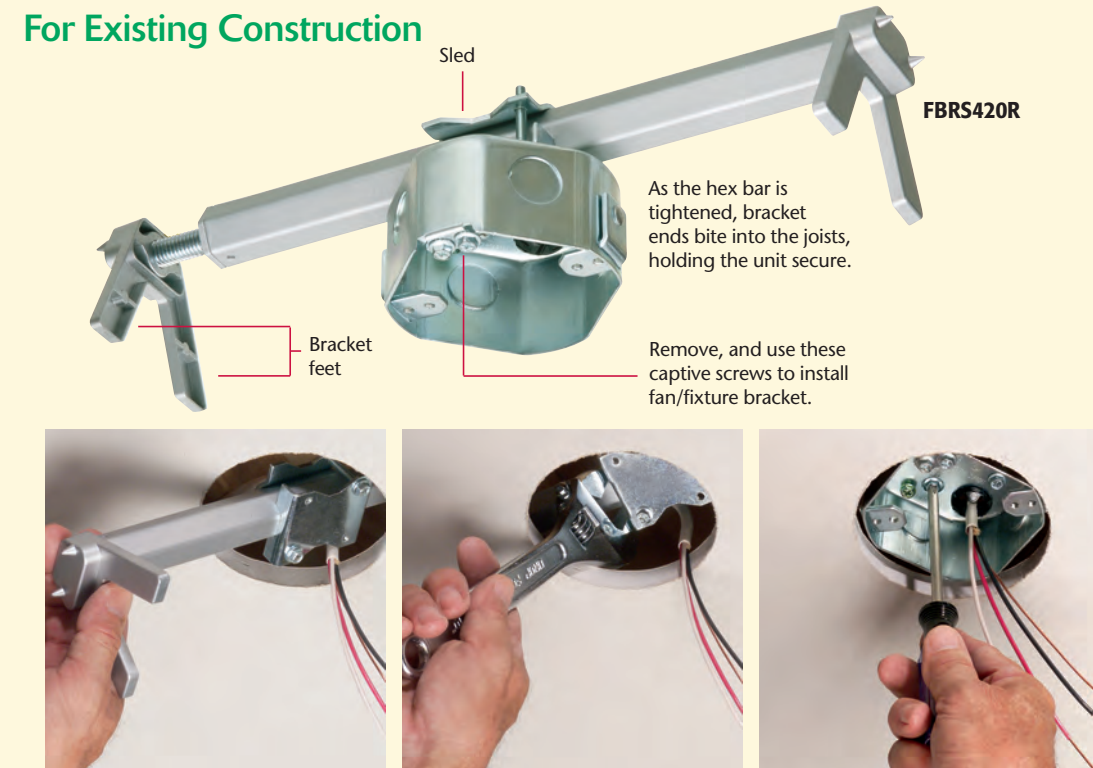

1 Cut hole in ceiling. Remove box from sled and fit mounting bracket into hole. Position bracket between joists, with bracket feet resting on the ceiling.

2 Tighten the hex bar with a wrench to secure bracket between joists.

3 Reattach box, and center it in hole. Attach bracket with screws supplied. Install fan/fixture per manufacturer's instructions.

For Wood I-Beams in Existing Construction

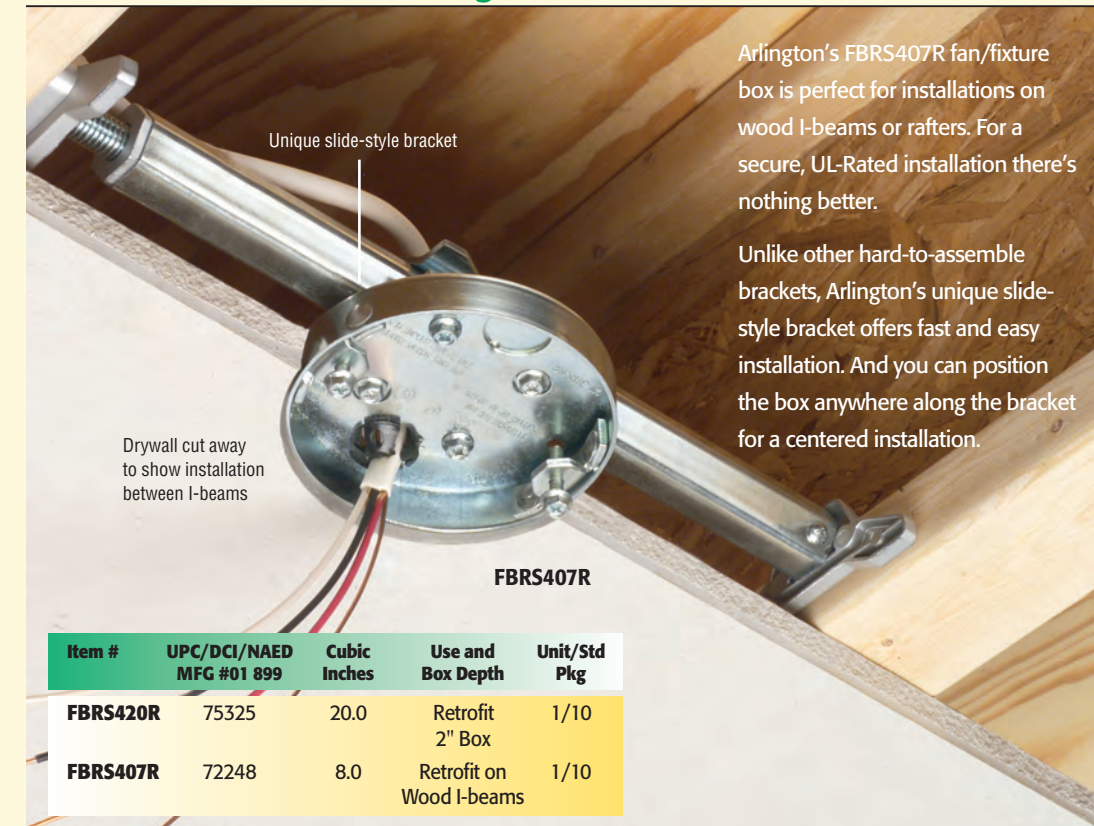

FBRS407R

for Wood I-Beams in Existing Construction

■ Box installs flush with ceiling drywall

■ For 1/2" and 5/8" thick ceilings

■ No parts to lose – ships with captive box adjustment screws, fan bracket installation screws and an installed NM cable connector

■ 8.0 cubic inch box

■ For existing construction on wood I-beams or rafters set 16 to 24 inches on-center

■ Listed to new UL standards

■ UL rating
35 lb. fan • 50 lb. fixture



Arlington

Fan/Fixture Box Kit for Suspended Ceilings

Designed just for mounting a fan or fixture on a suspended ceiling grid, Arlington's FBRS420SC fan/fixture box kit saves money! And 30 minutes of installation time.

The box/bracket assembly ships with the box mounted securely on-center, ready to install on a 24" grid. For a centered installation, there's no need to adjust the box or bracket, but you can position the box where you want it.

There are no parts to lose! FBRS420SC ships fully assembled. Installation and adjustment screws ship parked in place. There's an installed NM cable connector too.

- Fully adjustable mounting bracket
- 2" deep, 20.0 cubic inch box
- Meets new UL standards
- UL Rating: 70 lb fan or fixture
CSA: Acceptable for fan support
- Usable for Environmental Air Handling spaces



1 Cut a 4-1/16" diameter hole in a 24" ceiling tile.



2 Place box over hole. Place ends of support bar over the ceiling grid (tees).



3 Use the "S" hooks provided to attach chain to turnbuckle, and chain to the overhead support. Use turnbuckle to apply tension to the chain, so it supports the weight of fan.



4 Remove captive screws (shown above). Use them to install the fan or fixture per manufacturer's specifications, NEC and all local electrical codes.

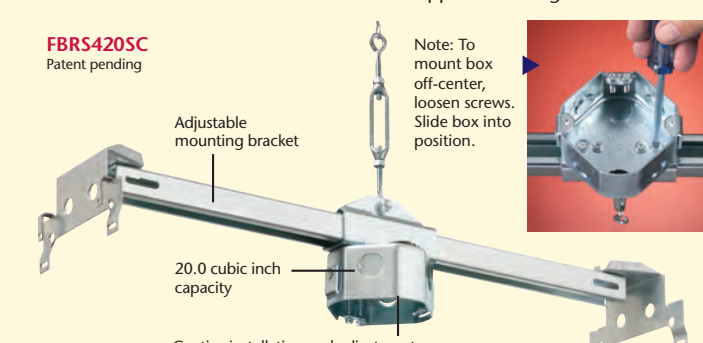

Kit includes box/bracket assembly with turnbuckle, 12' heavy-duty chain, and (2) "S" hooks.

Item #	UPC/DCI/NAED MFG #01 899	Box	Description	Unit/Std Pkg
FBRS420SC	75300	2" deep 20.0 cu. in.	Fan/Fixture box kit for suspended ceilings	1/5



Fixture Box for Suspended Ceilings

UL Listed for fixtures up to 50 lbs.

Costs less than the 70 lb. rated FBRS420SC.

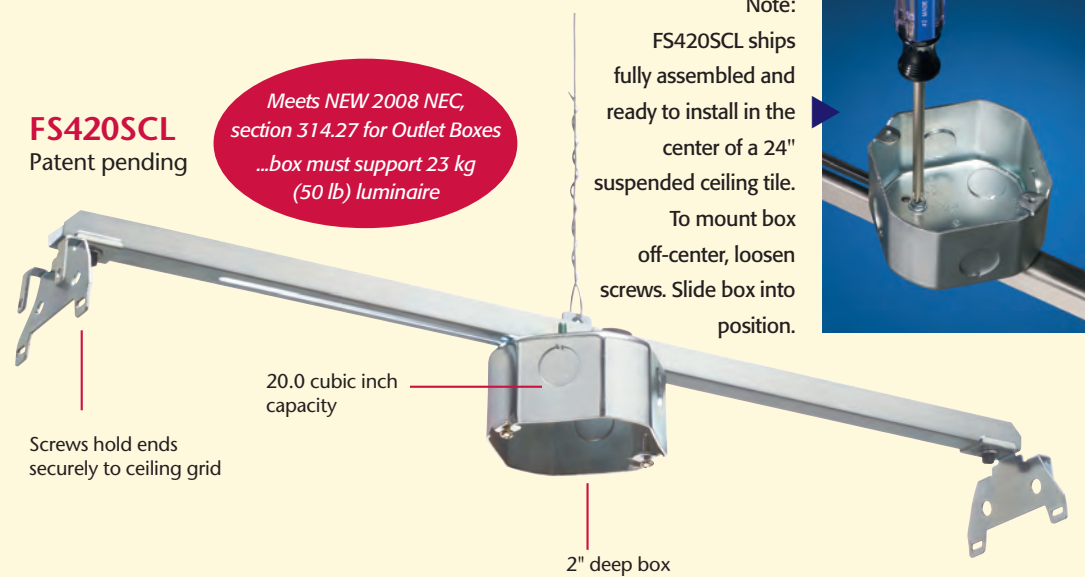

1 Cut a 4-1/16" diameter hole in a 24" ceiling tile.

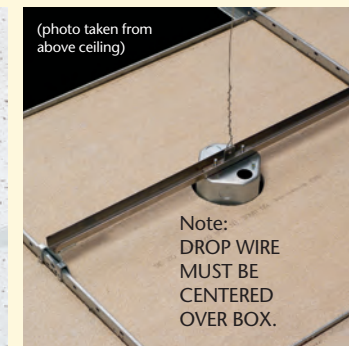

2 Place box over hole.



3 Snap ends of support bar over the ceiling grid (tees).

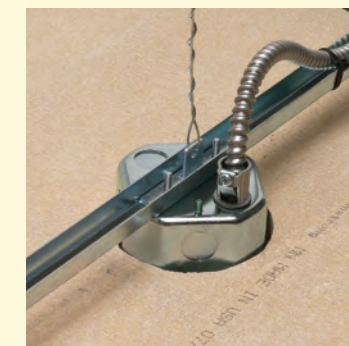

4 Cable pulled through cable connector (not supplied).



5 Use FS420SCL to install fixtures, security cameras, etc. Not fan rated.



Arlington's new all-metal box, just for fixtures, is a one-piece assembly that ships ready to install on a 24" suspended ceiling grid – No assembly required.

It's tested and rated to support exit lights, security cameras – and other light fixtures up to 50 lbs.

No more guesswork. Installers who previously attached a metal box to a bracket in the field, then added a chain or wire for support, now have an assembly that is fully tested to hold up to 50 lbs!

If the box is not perfectly positioned, loosen the appropriate screws, slide the box along the bracket and retighten the screws.

- Easy, secure mounting to ceiling grid
- Costs less than field-assembled components (box, bracket, wire)
- Saves installation time
- Usable for Environmental Air Handling spaces



For FBRS420SC and FS420SCL
OPTION: If required by local code, use sheet metal screws (not supplied) to hold bracket ends on ceiling grid.

Item #	UPC/DCI/NAED MFG #01 899	Box	Description	Unit/Std Pkg
FS420SCL	12526	2" deep 20.0 cu. in.	Box for suspended ceilings, for fixtures up to 50 lbs.	1/10

One-piece, rated unit includes box, bracket and drop wire

- FB405**
for 1/2" and 5/8" drywall
- FB407**
for 5/8" drywall
- FB412**
for 1/2" or 5/8" drywall with hat channel or furring strips, or double drywall

FB405, FB407, and FB412 offer the flexible, economical solution to 1/2" and 5/8" drywall ceiling, with or without hat channel or furring strips. FB405 and FB407 are perfect for double joists or wood I-beams.

- **Fast, easy installation**
- **Secure attachment to joist or rafter**
- **No parts to lose**
- **2-hour fire rating**
- **UL Rated: 70 lb. fans, fixtures up to 200 lbs.**
- **CSA: Fans/fixtures up to 50 lbs.**

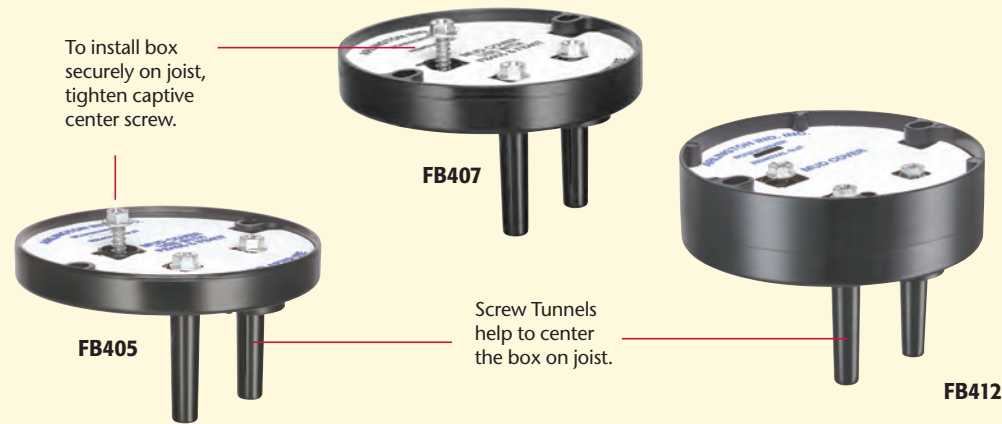

Box Installation



1 The FB412 fan/fixture box is perfect for 1/2" or 5/8" drywall with 3/4" furring strips or hat channel with a single layer of drywall...



2 ...or double drywall (shown as cutaway).

Item #	UPC/DCI/NAED MFG #01 899	Cubic Inches	Drywall Thickness	Unit/Std Pkg
FB405	72185	6.0	1/2" or 5/8"	25
FB407	72177	8.0	5/8"	25
FB412	72189	14.5	1/2" or 5/8" *	25

* w/ furring strips or hat channel with a single layer of drywall or with a double layer of drywall

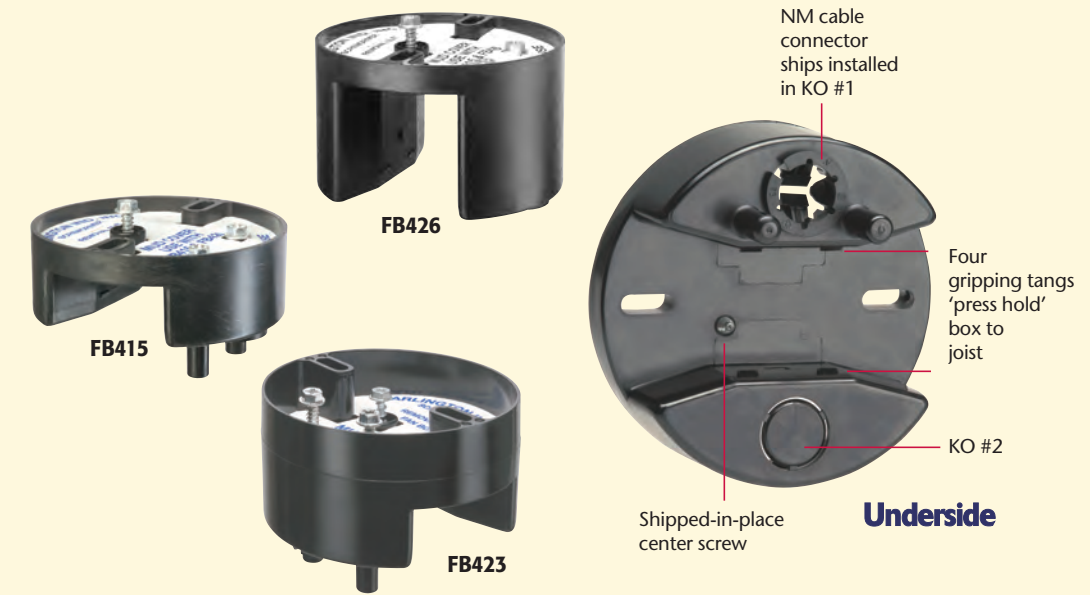

NEW! Flanged design forms a protective barrier against air infiltration.

Item #	UPC/DCI/NAED MFG #01 899	Cubic Inches	Drywall Thickness	Unit/Std Pkg
FB415	72167	10.3	1/2" or 5/8"	25
FB426	72179	16.0	1/2" or 5/8"	25
FB426F	12521	16.0	1/2" or 5/8"	25
FB423	72190	19.5	1/2" or 5/8" *	25

* w/ furring strips or hat channel with a single layer of drywall or with a double layer of drywall

- FB415**
for 1/2" and 5/8" drywall
- FB426**
for 1/2" and 5/8" drywall
- FB423**
for 1/2" or 5/8" drywall with hat channel or furring strips with a single layer of drywall, or double drywall

FB415 and FB426 come with the screws you need to install the box and bracket, held captive until you're ready to use them.

Press Hold...Speed, Convenience, Safety

These boxes have gripping tangs that press-hold the box to the joist while you reach for your screwdriver. Tightening the center screw affixes the box onto the joist for a super-secure installation.

- **2-hour fire rating**
- **UL Rated: 70 lb. fans, fixtures up to 200 lbs.**
- **CSA: Fans/fixtures up to 50 lbs.**



1 Convenient. Gripping tangs hold box in place temporarily, until the center screw is tightened.

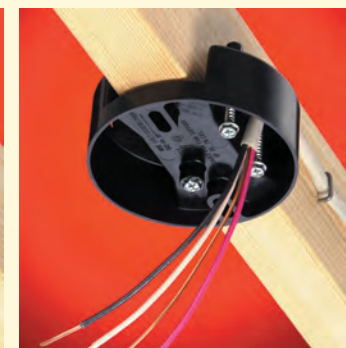

2 Push NM sheathed cable through the center screw.

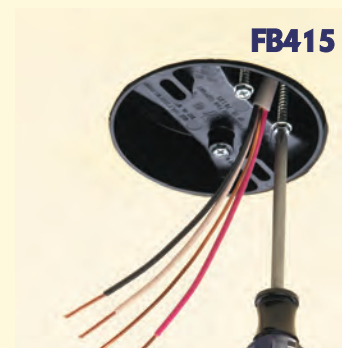

3 Remove (2) long parked screws. Use them to install bracket.



4 The fan/fixture bracket installs directly onto the joist through the oval slots in the box.

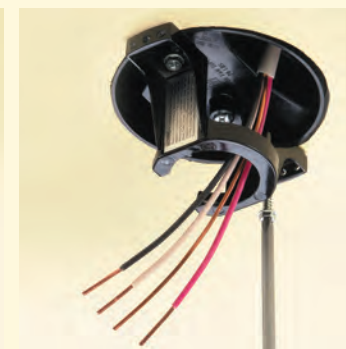

5 Cable pulled through installed NM cable connector.

All of Arlington's Fan/Fixture boxes ship with an installed NM cable connector and mud cover - as well as captive installation screws for the box and bracket.

No parts to lose or misplace...ready to use!



Plastic Boxes

FB444

Our largest capacity L-shaped box

FB442

FB443

Lowest cost L-shaped boxes

FB444 is the largest capacity box we make! Its 25.6 cubic inch capacity provides plenty of room for wires – easy access too!

The slightly smaller FB443 and FB442 offer the same great features and benefits at a lower cost.

- Boxes mount to single or double joists or rafters with a shipped-in-place center screw

- Locator posts assure correct positioning of bracket

- UL Rated: 70 lb. fans, fixtures up to 200 lbs.

- CSA: Fans/fixtures up to 50 lbs.

- 2-hour fire rating

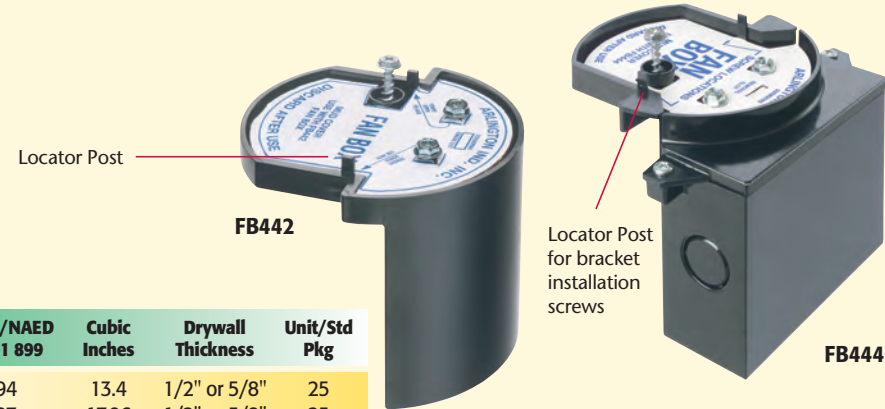

Item #	UPC/DCI/NAED MFG #01 899	Cubic Inches	Drywall Thickness	Unit/Std Pkg
FB442	72194	13.4	1/2" or 5/8"	25
FB443	72197	17.96	1/2" or 5/8"	25
FB444	72187	25.6	1/2" or 5/8"	25

FB442 Installation



- Secure!** Side mount the box to the joist using the shipped-in-place center screw.
- Pull wires.** (Drywall installation omitted) After ceiling is installed, remove captive installation screws – use them to install bracket.
- Done!** Install fan or fixture per manufacturer's instructions.

FB444 Installation



- Fast and easy installation** on single or double joists!
- Accurate!** Locator posts on these L-shaped boxes assure proper positioning of the installation bracket.



- Easy.** Bracket installation on FB444. (Drywall installation not shown)
- Easy access.** FB444 OPTION: To restuff wires, open bottom of the box – before drywall installation.



Plastic Boxes with Steel Bracket

Nail On Attachment to Single or Double Joists

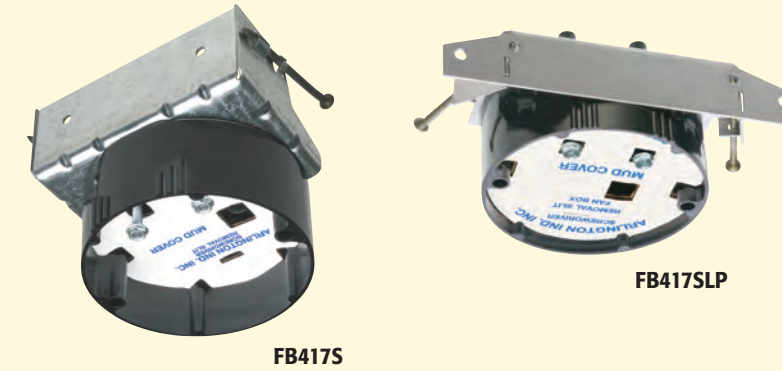

Fast. Simply nail the box to the joist. Indicator lines on FB417S assure proper positioning on the joist for the ceiling thickness.



FB417S and FB417SLP side mount to single or double joists for a super-secure installation.

Item #	UPC/DCI/NAED MFG #01 899	Cubic Inches	Ceiling Thickness	Unit/Std Pkg
FB417S	72177	20.0	up to 1-1/2"	25
FB417SLP*	72199	20.0	1/2" or 5/8"	25

* Also works on manufactured I-beams

Most of Arlington's Fan/Fixture boxes ship with an installed NM cable connector and mud cover – As well as captive installation screws for the box and bracket.

No parts to lose or misplace... ready to use!

FB417S

for ceilings up to 1-1/2" thick, including single-sheeted drywall mounted to furring strips or hat channel – or double drywall

FB417SLP

Low profile for 1/2" or 5/8" ceilings

FB417S saves time! Nail on installation, and indicator marks for 1/2", 5/8", and 3/4" ceiling thicknesses make it the logical choice for speedy attachment to single or double joists.

For added convenience, use the low profile FB417SLP for 1/2" or 5/8" ceilings. Also works for manufactured I-beams.

Both ship ready to use, with the nail in place and captive bracket installation screws.

- No loose parts – totally self-contained

- Combination hex/Phillips head screws for easy installation with power screwdrivers

- Nail on installation

- 20.0 cubic inch

- 2-hour fire rating

- UL Rated: Fans/fixtures up to 70 lbs.

- CSA: Fans/fixtures up to 50 lbs.

8" Mounting Block with built-in box for fan and fixture installations

Fan/Fixture Boxes

MB8

6.1 Cubic inches

- Ceiling medallion and electrical box combined
- Supports flood lights, smoke detectors, fans, light fixtures – any fixture needing a safe, strong installation.
- UV rated plastic
- For interior or exterior use
- Mounts directly to soffit or ceiling joist without the need to cut ceiling drywall
- Paintable
- UL Rated: 70 lb. fan, 200 lb. fixture; CSA rated: 50 lb. fan/fixture

Canadian orders ship with grounding lug required by CSA for use with fixtures.



MB8 includes...

Two #10 x 3" wood screws, one #8 x 1-1/2" wood screw, two KOs, and one NM94 non-metallic cable connector.

Item #	UPC/DCI/NAED MFG #01 899	Cubic Inches	Use and Box Depth	Unit/Std Pkg
MB8	42330	6.1	Flat Mount	1/10

MB8 Installation

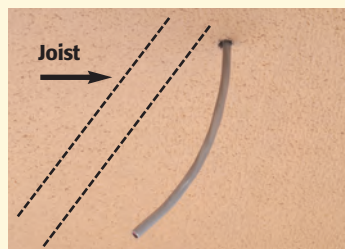

1 Locate the ceiling joist using a stud finder or similar device. Drill a hole approximately 1/2" in diameter, in the ceiling next to the joist. Remove desired knockout. Insert the cable connector into the opening. Pull the NM cable through the connector.



2 Using the #8 x 1-1/2" wood screws provided, mount the MB8 to the joist (through the ceiling).



3 Install the fixture or fan mounting bar (provided with the fixture or fan) directly to the joist with the (2) #10 x 3" wood screws and lock washers provided. Wire the fixture or fan following the instructions included with the product.

Steel Box – Side Mounts to Joist NEW!

FBS1423

23.0 Cubic inches

Designed for new construction or retrofit, this deep steel box side mounts to a joist for a super secure, fan-rated installation.

- UL Rated for fans/fixtures up to 70 lbs.
- CSA: Fans/fixtures up to 50 lbs.

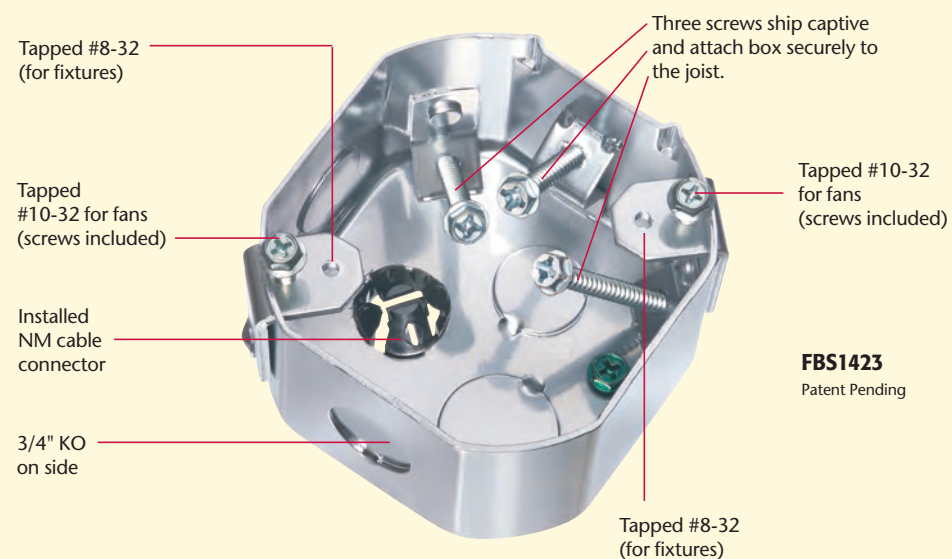

Place box at proper depth; attach to joist with three captive screws in the box.

Item #	UPC/DCI/NAED MFG #01 899	Cubic Inches	Side Mount Box Depth	Unit/Std Pkg
FBS1423	76190	23.0	2.375"	10

Fan/Fixture Box Rating and # of Single Conductors

Catalog Number	Category	Cubic Inches (Lbs.)	UL Fan Load Rating (Lbs.)	CSA Fan Load Rating (Lbs.)	UL Fixture Static Rating (Lbs.)	CSA Fixture Static Rating	# Of Single Conductors		
							#14 or	#12 or	#10
FB405	PLASTIC	6.0	70	50	200	50	3	—	—
FB4050	PLASTIC	6.0	70	50	200	50	3	—	—
FB407	PLASTIC	8.0	70	50	200	50	4	3	3
FB4070	PLASTIC	8.0	70	50	200	50	4	3	3
FB412	PLASTIC	14.4	70	50	200	50	7	6	5
FB415	PLASTIC	10.3	70	50	200	50	5	4	4
FB4150	PLASTIC	10.3	70	50	200	50	5	4	4
FB417S	PLASTIC & STEEL	20.0	70	50	70	50	10	8	8
FB417SLP	PLASTIC & STEEL	20.0	70	50	70	50	10	8	8
FB423	PLASTIC	19.5	70	50	200	50	9	8	7
FB426	PLASTIC	16.0	70	50	200	50	8	7	6
FB426F	PLASTIC	16.0	70	50	200	50	8	7	6
FB442	PLASTIC	13.4	70	50	200	50	6	4	4
FB443	PLASTIC	17.96	70	50	200	50	8	7	7
FB444	PLASTIC	25.6	70	50	200	50	13	11	10
FB450	PLASTIC	14.5	70	50	200	50	7	6	5
FB900	PLASTIC	14.5	70	50	200	50	7	6	5
FBRS407R	STEEL	8.0	35	50	50	50	4	3	3
FBRS415	STEEL	15.6	70 @ 24" o.c. 110 @ 16" o.c.	50	70 @ 24" o.c. 110 @ 16" o.c.	50	7	6	6
FBRS420R	STEEL	20.0	35	50	50	50	10	8	8
FBRS420SC	STEEL	20.0	35	50	50	50	10	8	8
FBS1423	STEEL	23.0	70	50	70	50	11	10	9
FBS405	STEEL	6.0	70	50	200	50	3	—	—
FBS405T	STEEL	6.0	70	50	200	50	3	—	—
FBS407	STEEL	8.0	70	50	200	50	4	3	3
FBS407T	STEEL	8.0	70	50	200	50	4	3	3
FBS415	STEEL	14.6	70	50	200	50	7	6	6
FBS415S	STEEL	14.6	70	50	70	50	7	6	6
FBS420	STEEL	20.0	70	50	200	50	10	8	8
FBS420S	STEEL	20.0	70	50	70	50	10	8	8
FBX900	PLASTIC & STEEL	14.5	70	50	70	50	7	6	5
FS420SCL	STEEL	20.0	—	—	25	25	10	8	8
MB8	PLASTIC	6.1	70	50	200	50	3	—	—

Most of of Arlington's Fan/Fixture boxes ship with an installed NM cable connector and mud cover – As well as captive installation screws for the box and bracket.

No parts to lose or misplace...ready to use!



Arlington



Arlington

SAVE MONEY!

FAN/FIXTURE BOX just for SUSPENDED CEILINGS



pg 8

Save 30 minutes of assembly time with Arlington's new fan/fixture box. It ships with the box and bracket assembly mounted on center, ready to install on a 24" suspended ceiling grid.

- No parts to lose
- Installation and adjustment screws ship captive
- 2" deep, 20.0 cu. inch box

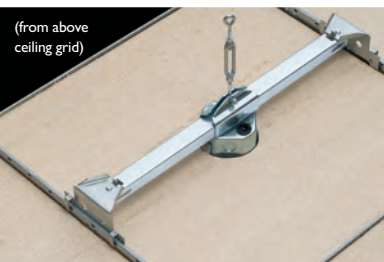

UL rating
70 lb fan
or fixture

FLUSH WITH CEILING

FAN/FIXTURE BOX with ADJUSTABLE BRACKET

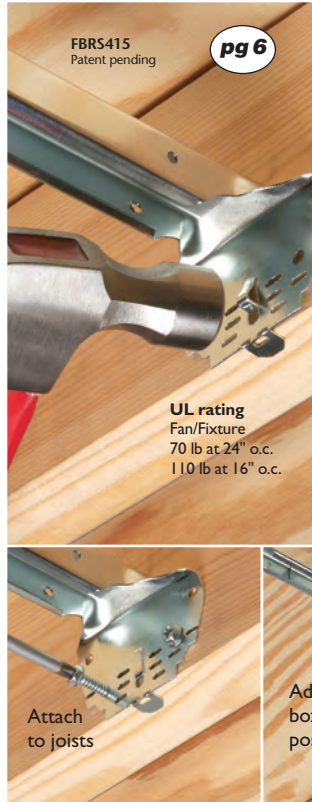

pg 6

Arlington's heavy-duty, plated steel fan/fixture box has an adjustable bracket that fits 16" to 24" o.c.

Flush ceiling installations!
FBR5415 is designed for ceilings up to 1-1/4" thick. For 1/2" ceilings, use the pre-bent positioning tab.

For other ceiling thicknesses, bend along the appropriate score line.

- 15.6 cu. inch box
- Ships with captive screws, mud cover, installed NM cable connector

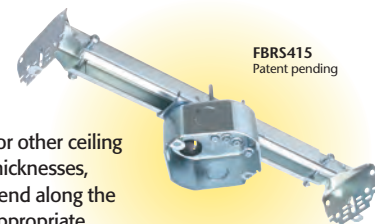

UL rating
Fan/Fixture
70 lb at 24" o.c.
110 lb at 16" o.c.



FIXTURE BOX

TESTED WEIGHT RATING LISTED AS 1-PIECE UNIT

for SUSPENDED CEILINGS



Mounts fixtures securely to the ceiling grid



pg 9



Arlington's new all-metal, one-piece fixture box ships ready to install on a 24" suspended ceiling grid. There's no assembly required!

It's tested and rated to support exit lights, security cameras and other light fixtures up to 50 lbs.

No more guesswork. Installers who attached a metal box to a bracket in the field, then added a chain or wire for support, now have an assembly that's *fully tested* to hold up to 50 lbs!

FS420SCL is UL/CSA Listed as a complete unit: box, bracket, drop wire.

- Box can be positioned anywhere along bracket
- Costs less than field-assembled components (box, bracket, wire)
- Usable for Environmental Air Handling spaces

Distributed by



Arlington

1 Stauffer Industrial Park
Scranton, PA 18517
800/233.4717
Fax 570/562.0646
www.aifittings.com

©2008 Arlington Industries, Inc.

Arlington's fan/fixture boxes are patented (or other patents pending).