

DIGITAL NAVIGATION

[Ordering Tree](#) [nLight Platform](#) [Photometrics](#) [Performance Data](#) [Drawings](#)

FEATURES & SPECIFICATIONS

INTENDED USE — The EPANL Series LED Edge-Lit Flat Panel provides a fully luminous appearance across the face of the lens. This provides a soft, glare-free solution that is visually comfortable within the space. Suitable for many lighting applications including schools, offices and other commercial spaces, retail, convenience stores, hospitals and healthcare facilities. **Certain airborne contaminants can diminish the integrity of acrylic and/or polycarbonate.** [Click here for Acrylic-Polycarbonate Compatibility table for suitable uses.](#)

CONSTRUCTION — This edgelit platform was built to last with an aluminum frame for strength and durability, the seamless frame prevents light leak in the corners. The PMMA light guide plate and lens resists yellowing and transmits light with superior efficacy. The satin white lens provides excellent shielding and fully luminous appearance. EPANL's low-profile design provides increased installation flexibility especially in restricted plenum spaces. The back plate includes integral T-bar clips for installation into 15/16" or 9/16" T-grid ceilings. Fixture may be recessed, suspended, surface box mounted or mounted in a hard-ceiling see accessories section for more information.

Integrated Sensor (nLight Wired Networking): This sensor is nLight-enabled, meaning it has the ability to communicate over an nLight network. When wired, using CAT-5 cabling, with other nLight-enabled sensors, power packs, or WallPods, an nLight control zone is created. Once linked to a Gateway, directly or via a Bridge, the zone becomes capable of remote status monitoring and control via SensorView software.

Integrated Smart Sensor (nLight Air Wireless Platform): The RES7 sensor is nLight AIR enabled, meaning it has the ability to communicate over the wireless nLight control platform. It is available with an automatic dimming photocell, and either a digital PIR or a microphonics (PDT) dual technology occupancy sensor. It pairs to other luminaires and wall switches through our mobile app, CLAIRITY+, which allows for simple sensor adjustment.

ELECTRICAL — Long-life LEDs, coupled with a high-efficiency driver, provide superior illumination for extended service life. See page 3 for detailed lumen maintenance information. 0-10V dimming driver, dims to 1% or 10% and contains non-isolated dimming leads.

LISTINGS — CSA Certified to meet US and Canadian standards. Tested to meet UL1598. Intended for indoor use only. Product is not to be stored in non-climate controlled spaces.

DesignLights Consortium® (DLC) qualified product. Not all versions of this product may be DLC qualified. Please check the DLC Qualified Products List at www.designlights.org/QPL to confirm which versions are qualified.

Damp location listed. IC rated. IP5X rated. Long nomenclature, configurable product is rated for NSF/ANSI Standard 2 - Light Fixture for Splash Zone and Non Food Zone. Tested in accordance with ISO 14644-1; suitable for ISO Class 5-9 positive and negative pressure clean rooms. Suitable for ambient temperatures from 32°F (0°C) to 77°F (25°C).

WARRANTY — 5-year limited warranty. This is the only warranty provided and no other statements in this specification sheet create any warranty of any kind. All other express and implied warranties are disclaimed. Complete warranty terms located at: www.acuitybrands.com/support/warranty/terms-and-conditions

Note: Actual performance may differ as a result of end-user environment and application. All values are design or typical values, measured under laboratory conditions at 25 °C. Specifications subject to change without notice.

Dimensions

	1x4	2x2	2x4
Length	47.72"	23.70"	47.72"
Width	11.85"	23.70"	23.70"
Depth	2.19"	2.19"	2.19"
Weight	13.9 lbs	7.4 lbs	15.1 lbs

* Base configurations; options may add weight

Catalog Number
Notes
Type

EPANL LED

1'x4', 2'x2', and 2'x4'



Embed nLight controls today. Prepare for tomorrow.

Now	Tomorrow
User-friendly install	Scalability
Enhanced energy savings	Space configuration
Code compliance	Future-ready

A+ Capable Luminaire

This item is an A+ capable luminaire, which has been designed and tested to provide consistent color appearance and out-of-the-box control compatibility with simple commissioning.

- All configurations of this luminaire meet the Acuity Brands' specification for chromatic consistency
- This luminaire is part of an A+ Certified solution for nLight® control networks when ordered with drivers marked by a **shaded background***
- This luminaire is part of an A+ Certified solution for nLight control networks, providing advanced control functionality at the luminaire level, when selection includes driver and control options marked by a **shaded background***

To learn more about A+, visit www.acuitybrands.com/aplus.

*See ordering tree for details

EPANL LED Flat Panel



A+ Capable options indicated by this color background.

ORDERING INFORMATION

Example: EPANL 2X4 4000LM 80CRI 35K MIN1 MVOLT E10WCP NLTAIR2 RIO

Series	Width and Length	Lumens	CRI	Color Temperature	Minimum Dimming Level ‡	
EPANL LED Flat Panel	1x4 1'x4'	<u>Standard Lumens:</u>		80CRI 80 CRI	35K 3500K 40K 4000K	MIN10 Dims to 10% ‡ MIN1 Dims to 1%
		1500LM 1500 Lumens				
		3000LM 3000 Lumens				
		4000LM 4000 Lumens				
	2x2 2'x2'	4800LM 4800 Lumens				
		2000LM 2000 Lumens				
		3400LM 3400 Lumens				
	2x4 2'x4'	4000LM 4000 Lumens				
		4800LM 4800 Lumens				
3000LM 3000 Lumens						
4000LM 4000 Lumens						
4800LM 4800 Lumens						
		5400LM 5400 Lumens				
		6000LM 6000 Lumens				

Dimming ‡	Voltage	Step Level Dimming	Emergency Option
ZT Generic 0-10V Dimming	MVOLT 120-277V	(Blank) None	E10WCP EM Self-Diagnostic battery pack, 10W Constant Power, Certified in CA Title 20 MAEDBS ‡
EZT eldoLED 0-10V Dimming	120 120V		GTD Generator Transfer Device ‡
	277 277V		EMG for use with NLIGHT or NLTAIR2 on generator supply EM power ‡
	347 347V ‡		

Control Options	
Control Input <u>nLight Wired:</u> NLIGHT nLight enabled, no constant lumen management CL80 NLIGHT nLight enabled, constant lumen output 80%	Control <u>nLight Wired: ‡</u> (blank) no control
<u>nLight Wireless:</u> NLTAIR2 nLight AIR Generation 2 enabled ‡	<u>nLight Wireless:</u> RIO nLight AIR Radio module without sensor ‡ RES7 nLight AIR control with PIR integral occupancy sensor and automatic dimming photocell ‡ RES7PDT nLight AIR control with PDT dual technology integral occupancy sensor and automatic dimming photocell ‡

Options	
GLR Fast-blowing fuse ‡	PWS1856LV 6' pre-wire, 3/8" diameter, 18 gauge, 1 circuit w/low voltage wires ‡
GMF Slow-blowing fuse ‡	CP Chicago plenum ‡
PWS1836 6' pre-wire, 3/8" diameter, 18 gauge, 1 circuit	NPLT Narrow Pallet
PWS1846 6' pre-wire, 3/8" diameter, 18 gauge, 2 circuit	BDP Factory Installed Ballast Disconnect Plug
PWS1846 PWSLV Two cables: one 6' pre-wire, 3/8" diameter, 18 gauge, 2 circuits; one 6' pre-wire, 3/8" diameter, 18 gauge ‡	RRL_ RELOC®-ready luminaire ‡

NOTE: ‡ indicates option value has ordering restrictions. Please reference the Option Value Ordering Restrictions chart on the next page. Options are sorted alphanumerically.

EPANL LED Flat Panel

‡ Option Value Ordering Restrictions	
Option Value	Restriction
347	Not available with E10WCP, or GTD options.
Dimming	If NLIGHT or NLTAIR2 is specified, leave this section blank.
CP	Not available with nLight wired (NLIGHT), nLight wireless (NLTAIR2). Not available with PWS1836, PWS1846, PWS1856LV, or PWS1846 PWSLV.
E10WCP	Refer to Emergency Battery Estimated Lumen section for lumen estimation. Test Switch must be remote mounted or installed in an adjacent ceiling tile. When using pre-wire option, use PWS1846 or PWS1846 PWSLV.
EMG	Requires a connection to existing NLIGHT or NLTAIR2 network. Power is provided from separate nLight enabled fixture. When EMG is combined with NLTAIR2 see UL924 Sequence of Operation Chart on page 4.
GLR, GMF	Must specify voltage. 120 or 277, with GLR and GMF fusing.
GTD	Not available with sensor options or emergency battery options. Must specify voltage. Requires BSE labeling (see BSE Options chart below), voltage specific. Example: GTD BSE10. When using a pre-wire option, use PWS1846 or PWS1846 PWSLV.
MIN10	Not available with EZT, NLIGHT.
NLTAIR2	Only available with MIN1 minimum dimming level option.
PWS1846 PWSLV	Not available with GTD, nLight wired, nLight wireless, NLIGHT or NLTAIR2.
PWS1856LV	Not available with nLight wired, nLight wireless, NLIGHT, or NLTAIR2.
RES7, RES7PDT, RIO	See UL924 Sequence of Operation chart on page 4. Can be used as a normal power sensing device for nLight Air devices and luminaries with EM options.
RRL_	For ordering logic consult RRL_2013 .

Lumen Maintenance:

EPANL	Reported Lumen Maintenance	Forecasted Lumen Maintenance
SE LEDs	L90 @ 41k Hrs / L80 @ >54k Hrs / L70 @ >54k Hrs	L90 @ 41k Hrs / L80 @ 84k Hrs / L70 @ 134k Hrs

BSE Labeling Options	
BSE10	Drivers load transfer relay installed per manufacturer's instructions. Voltage, BGTD and BSE10 called out.
BSE14	One voltage fixture with driver load control relay supplied with one prewire (PWS option). Prewire wired for normal circuit, the control relay for emergency circuit left unconnected. Voltage, BGTD, BSE14 and prewire called out, in the description.

*For configurations with Reloc or two voltages an RFA modification is required.

ACCESSORIES

Accessories: Order as separate catalog number.

DGA14	Drywall grid adapter for 1x4 recessed fixture.
DGA22	Drywall grid adapter for 2x2 recessed fixture.
DGA24	Drywall grid adapter for 2x4 recessed fixture.
PANLEM E10WCP BKT CVR	Field installable kit includes 10 watt battery, bracket and cover ¹
PANLEM BKT CVR	Field installable kit bracket and cover only, 10W battery NOT included ¹
2X2SMKSH	2'x2' Surface Mount Troffer Kit
2X4SMKSH	2'x4' Surface Mount Troffer Kit
1X4SMKSH	1'x4' Surface Mount Troffer Kit
BDP U	Field Installable Ballast Disconnect Plug
PAC 2DNF 36	Panel Air Craft Kit, 2 cables with Y splitter, No Power Feed, 36 inches. Recommended for 1X4 or 2X2 Panel Fixtures only. ²
PAC 2DF 36	Panel Air Craft Kit, 2 cables with Y splitter, with Power Feed, 36 inches. Recommended for 1X4 or 2X2 Panel Fixtures only. ^{2,3}
PAC 4DNF 36	Panel Air Craft Kit, 4 cables, No Power Feed, 36 inches. Recommended for 2X4, 1X4 or 2X2 Panel Fixtures. ²
PAC 4DF 36	Panel Air Craft Kit, 4 cables, with Power Feed, 36 inches. Recommended for 2X4, 1X4 or 2X2 Panel Fixtures. ^{2,3}
PAC 2DNF 72	Panel Air Craft Kit, 2 cables with Y splitter, No Power Feed 72 inches. Recommended for 1X4 or 2X2 Panel Fixtures only. ²
PAC 2DF 72	Panel Air Craft Kit, 2 cables with Y splitter, with Power Feed, 72 inches. Recommended for 1X4 or 2X2 Panel Fixtures only. ^{2,3}
PAC 4DNF 72	Panel Air Craft Kit, 4 cables, No Power Feed, 72 inches. Recommended for 2X4, 1X4 or 2X2 Panel Fixtures. ²
PAC 4DF 72	Panel Air Craft Kit, 4 cables, with Power Feed, 72 inches. Recommended for 2X4, 1X4 or 2X2 Panel Fixtures. ^{2,3}

Emergency Battery Estimated Lumens

Use the formula below to estimate the delivered lumens in emergency mode

Estimated Lumens = 1.25 x P x LPW

P = Output power of emergency driver (10W for PS1055CP)

LPW = Lumen per watt rating of the luminaire.

SMKSH Accessory



Notes:

1. Test switch must be remote mounted or installed in an adjacent ceiling tile.
2. See Suspension Kits section below for additional detail.
3. For MVOLT only, not available with 347V

Emergency Battery Pack Options – Field Installable

Battery Model Number	Wattage	Runtime (Minutes)	Lumen Output* @ 120 Lumens/Watt	Other
ILB CP07 2H A	7W	120	840	Storm Shelter / 2 Hour Runtime
ILB CP10 A	10W	90	1200	
ILB CP10 HE AELR A	10W	90	1200	Title 20; Enabled with Self Testing, Automated Reporting (STAR)
ILBLP CP10 HE SD A	10W	90	1200	Title 20, Self Diagnostic
ILBLP CP15 HE SD A	15W	90	1800	Title 20, Self Diagnostic
ILB CP20 HE A	20W	90	2400	Title 20
ILB CP20 HE SD A	20W	90	2400	Title 20, Self Diagnostic

UL 924 Response – nLight AIR Devices with EM Option

The below information applies to all nLight AIR devices with an EM option.

- EM devices will remain at their high-end trim and ignore wireless lighting control commands, unless a normal-power-sensed (NPS) broadcast is received at least every 8 seconds.
- Using the CLAIRITY+ mobile app, EM devices must be associated with a group that includes a normal power sensing device to receive NPS broadcasts.
- Only non-emergency rPP20, rLSXR, rSBOR, rSDGR, and nLight AIR luminaires with version 3.4 or later firmware can provide normal power sensing for EM devices. See specification sheets for control devices and luminaires for more information on options that support normal power sensing.

All the above are UL Listed products that are certified for field install external/remote to the fixture.

*Minimum delivered lumen output to assist in product selection for increased fixture mounting height.

The CP10 delivered emergency illumination outperforms legacy 1400 lumen fluorescent emergency ballast.

Please contact us at techsupport@iotaengineering.com for any Emergency Battery related questions.

Enabled with STAR

Emergency Lighting with Self-Testing Automated Reporting (STAR), enables self-testing and automated reporting to aid in life safety code compliance. Build your solution and choose your preferred deployment from Mobile STAR, where test data is logged in each individual unit and broadcast to the CLAIRITY+ app, or Connected STAR, where test data is logged in the STAR Gateway by IOTA® and emailed directly. **Leave the ladders, disruptions and written records behind with emergency lighting solutions with STAR!**

Life Safety Code NFPA 101 testing and reporting requirements for emergency lighting include:

- Testing for 30 seconds every 30 days
- Testing for 90 minutes once a year
- Record keeping and to report to the authority having local jurisdiction

MOBILE STAR

For small scale applications

CONNECTED STAR

For large scale applications

Suspension Kits

2 drops (1x4)



2 drops (2x2)

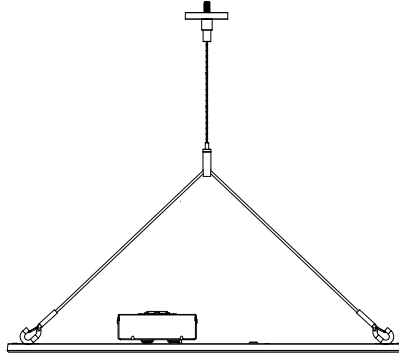

4 drops (2x4)

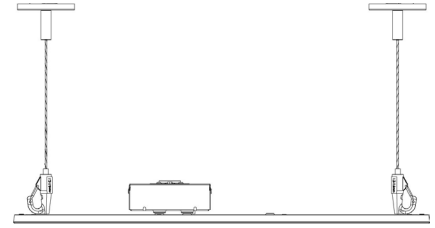

EPANL LED Flat Panel

nLight Platform

nLight embedded fixtures offer:	Customers get:
Manual Dimming	Convenience and visual comfort for occupants
Motion Sensing and/or Daylight Harvesting	Energy savings and code compliance
Fixture or Group Level Control	Ability to configure lighting to the space requirements
Flexibility	Ease of fixture moves, adds and changes
Wireless Wall Switch (nLight AIR Only)	Ease and flexibility of placement
Astronomical and Time of Day Scheduling	Energy savings and building security
Scalable Solution	nLight controls to grow with your business
Future-Ready	nLight platform to set foundation for future upgrades and capabilities

nLight Air Wireless

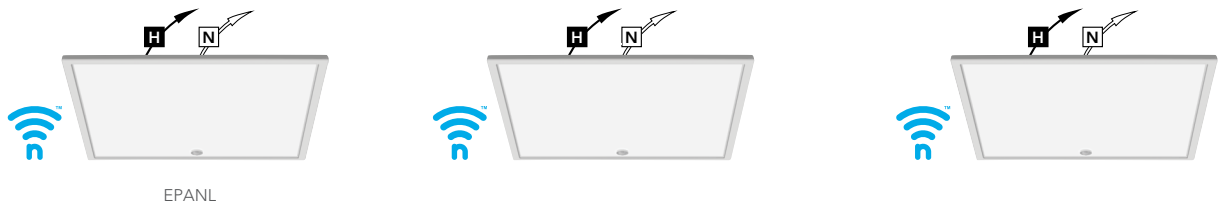

Simple as 1,2,3

1. Install the nLight® AIR fixtures with embedded smart sensor
2. Install the wireless battery-powered wall switch
3. With the CLAIRITY+ Pro app, pair the fixtures with the wall switch and if desired, customize the sensor settings for the desired outcome



nLight Wired Networking

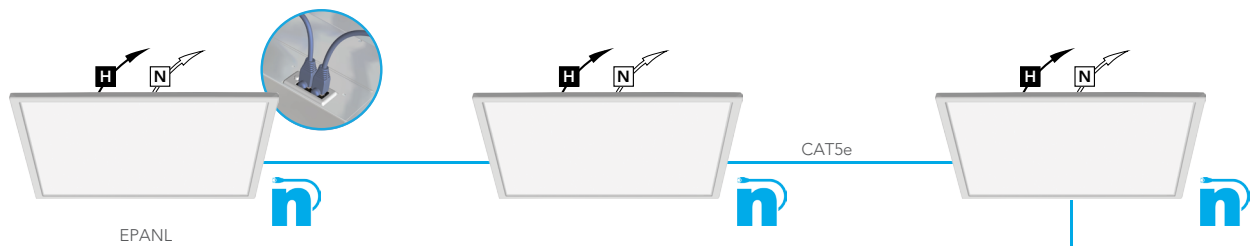

Simple as 1,2,3

1. Install the nLight® Wired fixtures with nIO control
2. Install the nLight Wired wall switch
3. Connect the fixtures using standard CAT5e cables and the devices will automatically discover each other and work (plug and play)



EPANL LED Flat Panel

Controls Accessories

nLight® Wired Control Accessories: <i>Order as separate catalog number. Visit www.acuitybrands.com/products/controls/nlight.</i>			
WallPod stations	Model number	Occupancy sensors	Model number
On/Off	nPODMA [Color]	Small motion 360°, ceiling (PIR / dual tech)	nCM 9 RJB / nCM PDT 9 RJB
On/Off & raise/lower	nPODMA DX [Color]	Large motion 360°, ceiling (PIR / dual tech)	nCM10 RJB / nCM PDT 10 RJB
Graphic touchscreen	nPOD TOUCH [Color]	Wall switch with raise/lower	nWSX PDT LV DX [color]
Photocell controls	Model number	Cat-5 cable (plenum rated)	Model number
Full range dimming	nCM ADCX RJB	10' cable	CATS 10FT J1
		30' cable	CATS 30FT J1

nLight® AIR Control Accessories: <i>Order as separate catalog number. Visit www.acuitybrands.com/products/controls/nlightair.</i>	
Wall switches	Model number
On/Off single pole	rPODBA [color] G2
On/Off two pole	rPODB A2P [color] G2
On/Off & raise/lower single pole	rPODBA DX [color] G2
On/Off & raise/lower two pole	rPODBA 2P DX [color] G2

EPANL fixtures with integrated rIO devices complement any small office space. Pair them with an rCMS occupancy sensor and the space now has wireless occupancy sensing and dimming capability. For additional configuration options please consult with Tech Support.

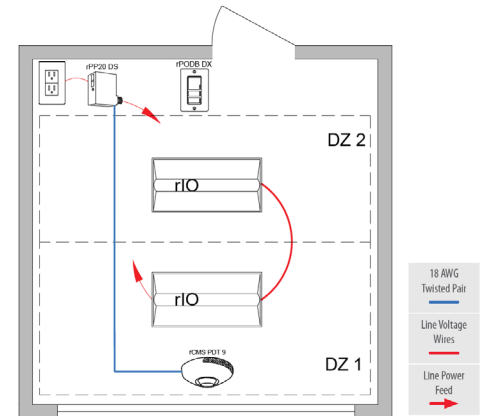

rCMS ¹		Example: RCMS PDT 10 AR G2					
Series / Detection	Power Supply ¹	Occupancy Detection	Lens (Required)	Operating Mode	Generation		
RCMS nLight AIR occupancy and daylight sensor	[blank] Power Supply ordered separately PS 150 Standard 150 mA Power Supply	[blank] PIR Detection PDT Dual Tech PIR/Microphonics	10 Large Motion/ Extended Range 360° 9 Small Motion/ Extended Range 360° 6 High Bay 360° Lens	[BLANK] None AR Auxiliary Relay	G2	Generation 2 compatibility	

Notes

1 RCMS requires low voltage power from either RPP20 DS 24V G2 or PS150.



Sensor Coverage Pattern Mini 360° Lens

- Recommended for walking motion detection from mounting heights between 8 ft (2.44 m) and 20 ft (6.10 m)
- Initial detection of walking motion along sensor axes at distances of 2x the mounting height up to 15 ft (4.57 m) and
- 1.75x up to 20 ft (6.10 m).
- Provides 12 ft (3.66 m) radial detection of small motion when mounted at 9 ft (2.74 m)
- Initial detection will occur earlier when walking across sensor's field of view than when walking directly at sensor

9 FT Mounting

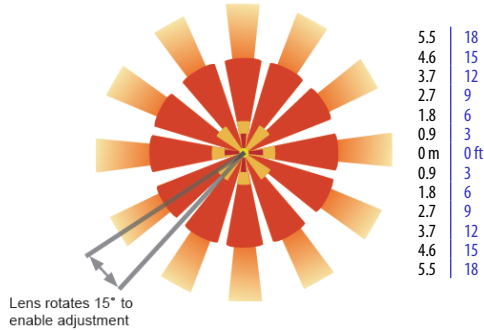

nLight AIR Wireless

nLight AIR is the ideal solution for retrofit or new construction spaces where adding additional wiring can be labor intensive and nLight AIR is available with or without an integral sensor. The integrated rES7 or rES7PDT smart sensors are part of each luminaire in the nLight AIR network, which can be grouped to control multiple luminaires. The granularity of control with the digital PIR occupancy detection and daylight sensing makes a great solution for any application.

Sequence of Operation (nES7 and Sensor)

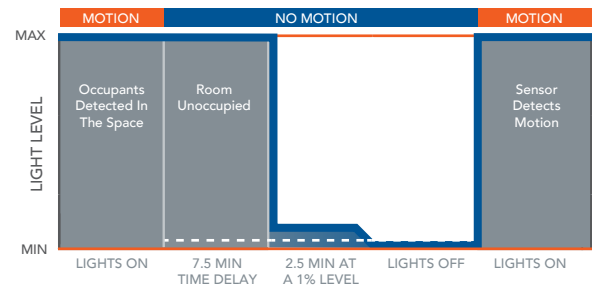

*The presetting on the automatic dimming photocell is 10fc (RES7).

EPANL LED Flat Panel

Performance Data					
Model Number	DLC Classification	Lumens	Watts	LPW	DLC Product ID
EPANL 1X4 1500LM 80CRI 35K [MIN1, MIN10] [BLANK, ZT, EZT, NLIGHT] [MVOLT, 120, 277] [ALL OPTIONS]	Standard	1574	14	113	PII6VKUP
EPANL 1X4 1500LM 80CRI 40K [MIN1, MIN10] [BLANK, ZT, EZT, NLIGHT] [MVOLT, 120, 277] [ALL OPTIONS]	Standard	1637	14	117	P7MFGP4R
EPANL 1X4 3000LM 80CRI 35K [MIN1, MIN10] [BLANK, ZT, EZT, NLIGHT] [MVOLT, 120, 277] [ALL OPTIONS]	Standard	2960	27	110	P5L7HREA
EPANL 1X4 3000LM 80CRI 40K [MIN1, MIN10] [BLANK, ZT, EZT, NLIGHT] [MVOLT, 120, 277] [ALL OPTIONS]	Standard	3078	27	114	PICJQWDG
EPANL 1X4 4000LM 80CRI 35K [MIN1, MIN10] [BLANK, ZT, EZT, NLIGHT] [MVOLT, 120, 277] [ALL OPTIONS]	Not Listed	3811	37	104	
EPANL 1X4 4000LM 80CRI 40K [MIN1, MIN10] [BLANK, ZT, EZT, NLIGHT] [MVOLT, 120, 277] [ALL OPTIONS]	Standard	3963	37	107	P4SKVRJP
EPANL 1X4 4800LM 80CRI 40K [MIN1, MIN10] [BLANK, ZT, EZT, NLIGHT] [MVOLT, 120, 277] [ALL OPTIONS]	Standard	4923	45	110	PR3K6SHH
EPANL 2X2 2000LM 80CRI 35K [MIN1, MIN10] [BLANK, ZT, EZT, NLIGHT] [MVOLT, 120, 277] [ALL OPTIONS]	Standard	2071	19	110	P7I6D3WI
EPANL 2X2 2000LM 80CRI 40K [MIN1, MIN10] [BLANK, ZT, EZT, NLIGHT] [MVOLT, 120, 277] [ALL OPTIONS]	Standard	2154	19	115	PPTL71HY
EPANL 2X2 3400LM 80CRI 35K [MIN1, MIN10] [BLANK, ZT, EZT, NLIGHT] [MVOLT, 120, 277] [ALL OPTIONS]	Standard	3428	30	113	PQAFPPJ6
EPANL 2X2 3400LM 80CRI 35K [MIN1, MIN10] [BLANK, ZT, EZT, NLIGHT] 347 [ALL OPTIONS]	Not Listed	3428	30	113	
EPANL 2X2 3400LM 80CRI 40K [MIN1, MIN10] [BLANK, ZT, EZT, NLIGHT] [MVOLT, 120, 277] [ALL OPTIONS]	Standard	3566	30	118	PY8MM627
EPANL 2X2 3400LM 80CRI 40K [MIN1, MIN10] [BLANK, ZT, EZT, NLIGHT] 347 [ALL OPTIONS]	Standard	3566	30	118	PMKTPCS2
EPANL 2X2 4000LM 80CRI 35K [MIN1, MIN10] [BLANK, ZT, EZT, NLIGHT] [MVOLT, 120, 277] [ALL OPTIONS]	Not Listed	3963	37	108	
EPANL 2X2 4000LM 80CRI 40K [MIN1, MIN10] [BLANK, ZT, EZT, NLIGHT] [MVOLT, 120, 277] [ALL OPTIONS]	Standard	4121	37	110	PW0040LR
EPANL 2X2 4800LM 80CRI 35K [MIN1, MIN10] [BLANK, ZT, EZT, NLIGHT] [MVOLT, 120, 277] [ALL OPTIONS]	Not Listed	4729	45	106	
EPANL 2X2 4800LM 80CRI 40K [MIN1, MIN10] [BLANK, ZT, EZT, NLIGHT] [MVOLT, 120, 277] [ALL OPTIONS]	Standard	4843	45	109	PS2AC19A
EPANL 2X4 3000LM 80CRI 35K [MIN1, MIN10] [BLANK, ZT, EZT, NLIGHT] [MVOLT, 120, 277] [ALL OPTIONS]	Standard	3141	29	110	P4PIGUFW
EPANL 2X4 3000LM 80CRI 40K [MIN1, MIN10] [BLANK, ZT, EZT, NLIGHT] [MVOLT, 120, 277] [ALL OPTIONS]	Standard	3266	29	115	PSPB7FBG
EPANL 2X4 4000LM 80CRI 35K [MIN1, MIN10] [BLANK, ZT, EZT, NLIGHT] [MVOLT, 120, 277] [ALL OPTIONS]	Standard	4077	38	108	PG2MHOZE
EPANL 2X4 4000LM 80CRI 40K [MIN1, MIN10] [BLANK, ZT, EZT, NLIGHT] [MVOLT, 120, 277] [ALL OPTIONS]	Standard	4240	38	113	PNKUCIIA
EPANL 2X4 4000LM 80CRI 40K [MIN1, MIN10] [BLANK, ZT, EZT, NLIGHT] 347 [ALL OPTIONS]	Not Listed	4240	38	113	
EPANL 2X4 4800LM 80CRI 35K [MIN1, MIN10] [BLANK, ZT, EZT, NLIGHT] [MVOLT, 120, 277] [ALL OPTIONS]	Standard	4998	45	111	P8FFEBQH
EPANL 2X4 4800LM 80CRI 35K [MIN1, MIN10] [BLANK, ZT, EZT, NLIGHT] 347 [ALL OPTIONS]	Not Listed	4998	45	111	
EPANL 2X4 4800LM 80CRI 40K [MIN1, MIN10] [BLANK, ZT, EZT, NLIGHT] [MVOLT, 120, 277] [ALL OPTIONS]	Standard	5119	45	113	PL3AU798
EPANL 2X4 4800LM 80CRI 40K [MIN1, MIN10] [BLANK, ZT, EZT, NLIGHT] 347 [ALL OPTIONS]	Not Listed	5119	45	113	
EPANL 2X4 5400LM 80CRI 35K [MIN1, MIN10] [BLANK, ZT, EZT, NLIGHT] [MVOLT, 120, 277] [ALL OPTIONS]	Standard	5546	49	113	PVKKX9GJ
EPANL 2X4 5400LM 80CRI 40K [MIN1, MIN10] [BLANK, ZT, EZT, NLIGHT] [MVOLT, 120, 277] [ALL OPTIONS]	Standard	5679	49	116	P31GEZNP
EPANL 2X4 6000LM 80CRI 35K [MIN1, MIN10] [BLANK, ZT, EZT, NLIGHT] [MVOLT, 120, 277] [ALL OPTIONS]	Standard	6364	50	127	PMHI2SAT
EPANL 2X4 6000LM 80CRI 35K [MIN1, MIN10] [BLANK, ZT, EZT, NLIGHT] 347 [ALL OPTIONS]	Standard	6364	55	115	PD2QM1LA
EPANL 2X4 6000LM 80CRI 40K [MIN1, MIN10] [BLANK, ZT, EZT, NLIGHT] [MVOLT, 120, 277] [ALL OPTIONS]	Standard	6548	50	131	P4H3UGFQ

EPANL LED Flat Panel

PHOTOMETRICS

Full Photometric data is available on Lithonia.acuitybrands.com

EPANL 2x2 4000LM 80CRI 40K, 4121 delivered lumens.

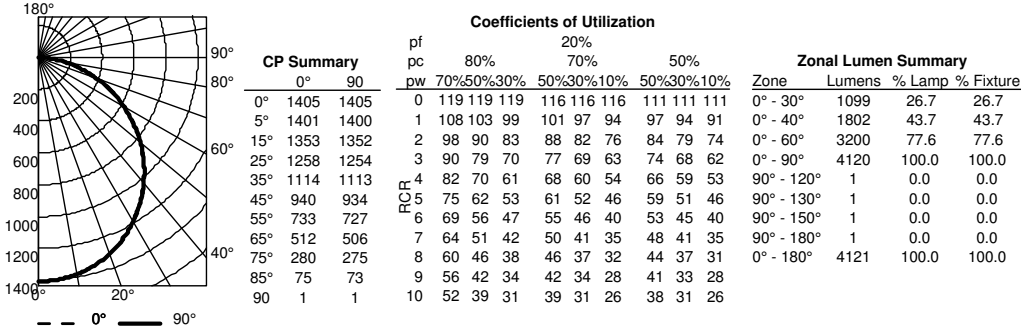

EPANL 2x4 4800LM 80CRI 40K, 5119 delivered lumens.

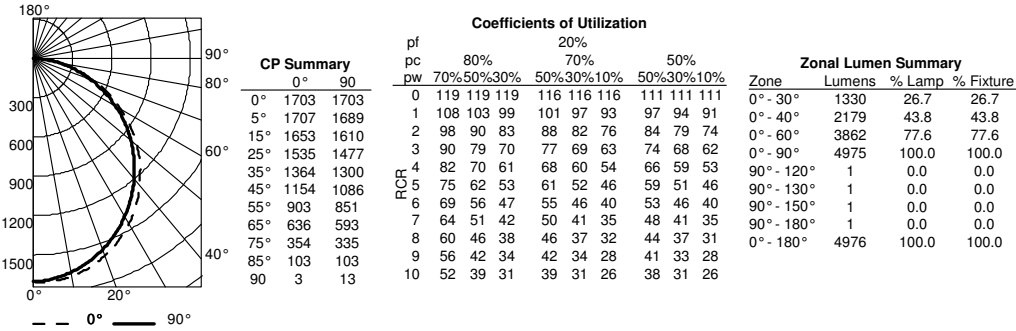

DIMENSIONS

1X4 Configurations

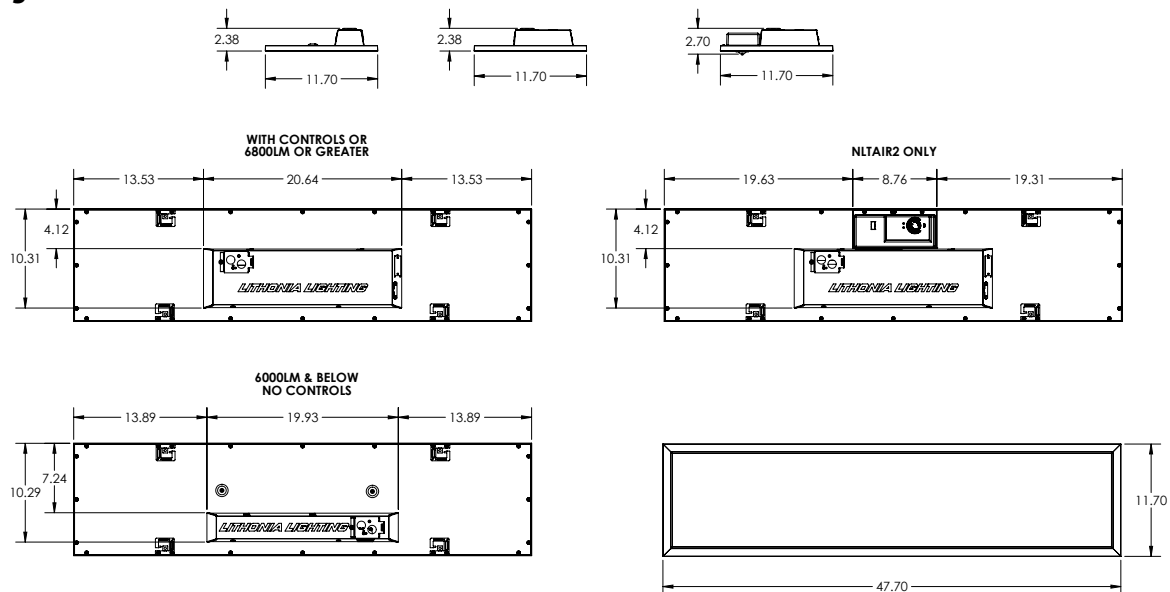

2X2 Configurations

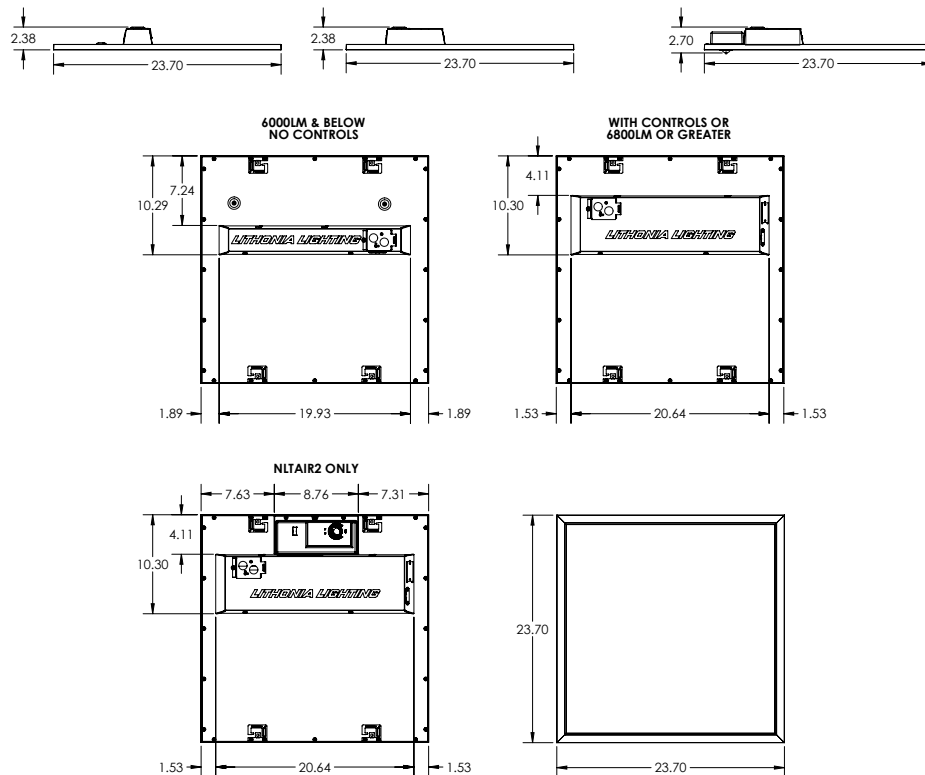

DIMENSIONS (continued)

2X4 Configurations

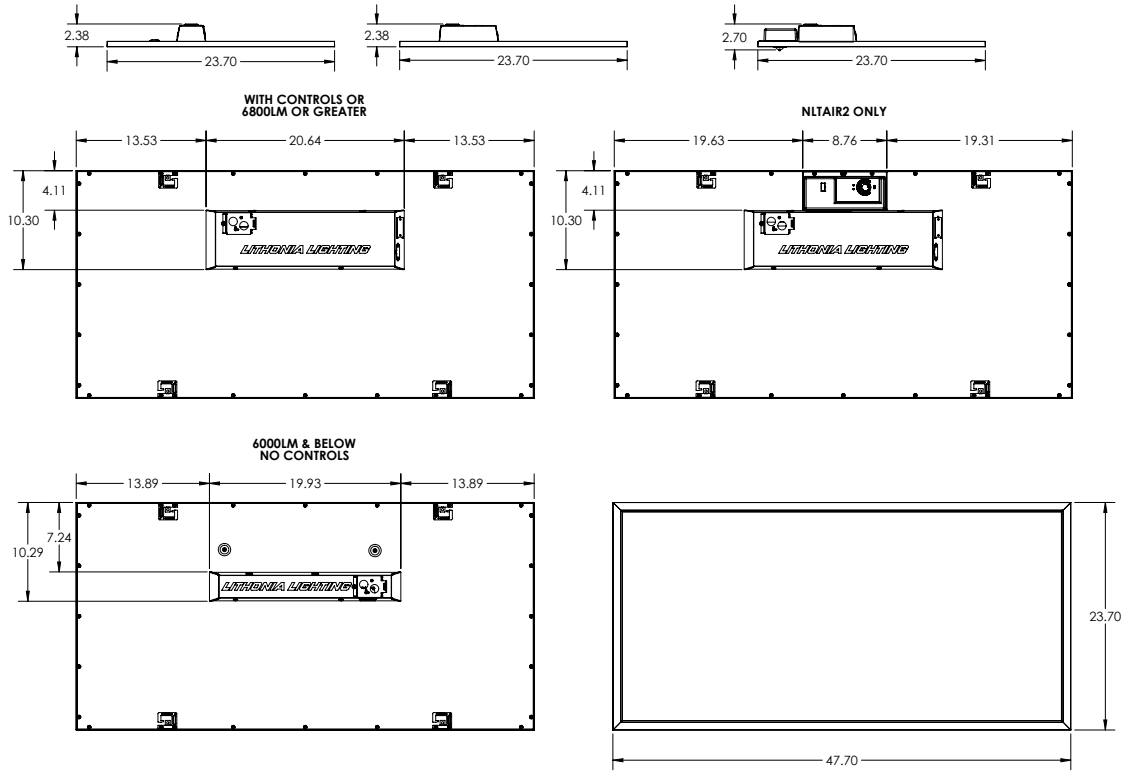

DIGITAL NAVIGATION

[Ordering Tree](#) [nLight Platform](#) [Photometrics](#) [Performance Data](#) [Drawings](#)

FEATURES & SPECIFICATIONS

INTENDED USE — The EPANL Series LED Edge-Lit Flat Panel provides a fully luminous appearance across the face of the lens. This provides a soft, glare-free solution that is visually comfortable within the space. Suitable for many lighting applications including schools, offices and other commercial spaces, retail, convenience stores, hospitals and healthcare facilities. **Certain airborne contaminants can diminish the integrity of acrylic and/or polycarbonate.** [Click here for Acrylic-Polycarbonate Compatibility table for suitable uses.](#)

CONSTRUCTION — This edgelit platform was built to last with an aluminum frame for strength and durability, the seamless frame prevents light leak in the corners. The PMMA light guide plate and lens resists yellowing and transmits light with superior efficacy. The satin white lens provides excellent shielding and fully luminous appearance. EPANL's low-profile design provides increased installation flexibility especially in restricted plenum spaces. The back plate includes integral T-bar clips for installation into 15/16" or 9/16" T-grid ceilings. Fixture may be recessed, suspended, surface box mounted or mounted in a hard-ceiling see accessories section for more information.

Integrated Sensor (nLight Wired Networking): This sensor is nLight-enabled, meaning it has the ability to communicate over an nLight network. When wired, using CAT-5 cabling, with other nLight-enabled sensors, power packs, or WallPods, an nLight control zone is created. Once linked to a Gateway, directly or via a Bridge, the zone becomes capable of remote status monitoring and control via SensorView software.

Integrated Smart Sensor (nLight Air Wireless Platform): The RES7 sensor is nLight AIR enabled, meaning it has the ability to communicate over the wireless nLight control platform. It is available with an automatic dimming photocell, and either a digital PIR or a microphonics (PDT) dual technology occupancy sensor. It pairs to other luminaires and wall switches through our mobile app, CLAIRITY+, which allows for simple sensor adjustment.

ELECTRICAL — Long-life LEDs, coupled with a high-efficiency driver, provide superior illumination for extended service life. See page 3 for detailed lumen maintenance information. 0-10V dimming driver, dims to 1% or 10% and contains non-isolated dimming leads.

LISTINGS — CSA Certified to meet US and Canadian standards. Tested to meet UL1598. Intended for indoor use only. Product is not to be stored in non-climate controlled spaces.

DesignLights Consortium® (DLC) qualified product. Not all versions of this product may be DLC qualified. Please check the DLC Qualified Products List at www.designlights.org/QPL to confirm which versions are qualified.

Damp location listed. IC rated. IP5X rated. Long nomenclature, configurable product is rated for NSF/ANSI Standard 2 - Light Fixture for Splash Zone and Non Food Zone. Tested in accordance with ISO 14644-1; suitable for ISO Class 5-9 positive and negative pressure clean rooms. Suitable for ambient temperatures from 32°F (0°C) to 77°F (25°C).

WARRANTY — 5-year limited warranty. This is the only warranty provided and no other statements in this specification sheet create any warranty of any kind. All other express and implied warranties are disclaimed. Complete warranty terms located at: www.acuitybrands.com/support/warranty/terms-and-conditions

Note: Actual performance may differ as a result of end-user environment and application. All values are design or typical values, measured under laboratory conditions at 25 °C. Specifications subject to change without notice.

Dimensions

	1x4	2x2	2x4
Length	47.72"	23.70"	47.72"
Width	11.85"	23.70"	23.70"
Depth	2.19"	2.19"	2.19"
Weight	13.9 lbs	7.4 lbs	15.1 lbs

* Base configurations; options may add weight

Catalog Number
Notes
Type

EPANL LED

1'x4', 2'x2', and 2'x4'



Embed nLight controls today. Prepare for tomorrow.

Now	Tomorrow
User-friendly install	Scalability
Enhanced energy savings	Space configuration
Code compliance	Future-ready

A+ Capable Luminaire

This item is an A+ capable luminaire, which has been designed and tested to provide consistent color appearance and out-of-the-box control compatibility with simple commissioning.

- All configurations of this luminaire meet the Acuity Brands' specification for chromatic consistency
- This luminaire is part of an A+ Certified solution for nLight® control networks when ordered with drivers marked by a **shaded background***
- This luminaire is part of an A+ Certified solution for nLight control networks, providing advanced control functionality at the luminaire level, when selection includes driver and control options marked by a **shaded background***

To learn more about A+, visit www.acuitybrands.com/aplus.

*See ordering tree for details

EPANL LED Flat Panel



A+ Capable options indicated by this color background.

ORDERING INFORMATION

Example: EPANL 2X4 4000LM 80CRI 35K MIN1 MVOLT E10WCP NLTAIR2 RIO

Series	Width and Length	Lumens	CRI	Color Temperature	Minimum Dimming Level ‡	
EPANL LED Flat Panel	1x4 1'x4'	<u>Standard Lumens:</u>		80CRI 80 CRI	35K 3500K 40K 4000K	MIN10 Dims to 10% ‡ MIN1 Dims to 1%
		1500LM 1500 Lumens				
		3000LM 3000 Lumens				
		4000LM 4000 Lumens				
	2x2 2'x2'	4800LM 4800 Lumens				
		2000LM 2000 Lumens				
		3400LM 3400 Lumens				
	2x4 2'x4'	4000LM 4000 Lumens				
		4800LM 4800 Lumens				
3000LM 3000 Lumens						
4000LM 4000 Lumens						
4800LM 4800 Lumens						

Dimming ‡	Voltage	Step Level Dimming	Emergency Option
ZT Generic 0-10V Dimming	MVOLT 120-277V	(Blank) None	E10WCP EM Self-Diagnostic battery pack, 10W Constant Power, Certified in CA Title 20 MAEDBS ‡
EZT eldoLED 0-10V Dimming	120 120V		GTD Generator Transfer Device ‡
	277 277V		EMG for use with NLIGHT or NLTAIR2 on generator supply EM power ‡
	347 347V ‡		

Control Options	
Control Input <u>nLight Wired:</u> NLIGHT nLight enabled, no constant lumen management CL80 NLIGHT nLight enabled, constant lumen output 80%	Control <u>nLight Wired: ‡</u> (blank) no control
<u>nLight Wireless:</u> NLTAIR2 nLight AIR Generation 2 enabled ‡	<u>nLight Wireless:</u> RIO nLight AIR Radio module without sensor ‡ RES7 nLight AIR control with PIR integral occupancy sensor and automatic dimming photocell ‡ RES7PDT nLight AIR control with PDT dual technology integral occupancy sensor and automatic dimming photocell ‡

Options	
GLR Fast-blowing fuse ‡	PWS1856LV 6' pre-wire, 3/8" diameter, 18 gauge, 1 circuit w/low voltage wires ‡
GMF Slow-blowing fuse ‡	CP Chicago plenum ‡
PWS1836 6' pre-wire, 3/8" diameter, 18 gauge, 1 circuit	NPLT Narrow Pallet
PWS1846 6' pre-wire, 3/8" diameter, 18 gauge, 2 circuit	BDP Factory Installed Ballast Disconnect Plug
PWS1846 PWSLV Two cables: one 6' pre-wire, 3/8" diameter, 18 gauge, 2 circuits; one 6' pre-wire, 3/8" diameter, 18 gauge ‡	RRL_ RELOC®-ready luminaire ‡

NOTE: ‡ indicates option value has ordering restrictions. Please reference the Option Value Ordering Restrictions chart on the next page. Options are sorted alphanumerically.

EPANL LED Flat Panel

‡ Option Value Ordering Restrictions	
Option Value	Restriction
347	Not available with E10WCP, or GTD options.
Dimming	If NLIGHT or NLTAIR2 is specified, leave this section blank.
CP	Not available with nLight wired (NLIGHT), nLight wireless (NLTAIR2). Not available with PWS1836, PWS1846, PWS1856LV, or PWS1846 PWSLV.
E10WCP	Refer to Emergency Battery Estimated Lumen section for lumen estimation. Test Switch must be remote mounted or installed in an adjacent ceiling tile. When using pre-wire option, use PWS1846 or PWS1846 PWSLV.
EMG	Requires a connection to existing NLIGHT or NLTAIR2 network. Power is provided from separate nLight enabled fixture. When EMG is combined with NLTAIR2 see UL924 Sequence of Operation Chart on page 4.
GLR, GMF	Must specify voltage. 120 or 277, with GLR and GMF fusing.
GTD	Not available with sensor options or emergency battery options. Must specify voltage. Requires BSE labeling (see BSE Options chart below), voltage specific. Example: GTD BSE10. When using a pre-wire option, use PWS1846 or PWS1846 PWSLV.
MIN10	Not available with EZT, NLIGHT.
NLTAIR2	Only available with MIN1 minimum dimming level option.
PWS1846 PWSLV	Not available with GTD, nLight wired, nLight wireless, NLIGHT or NLTAIR2.
PWS1856LV	Not available with nLight wired, nLight wireless, NLIGHT, or NLTAIR2.
RES7, RES7PDT, RIO	See UL924 Sequence of Operation chart on page 4. Can be used as a normal power sensing device for nLight Air devices and luminaries with EM options.
RRL_	For ordering logic consult RRL_2013 .

Lumen Maintenance:

EPANL	Reported Lumen Maintenance	Forecasted Lumen Maintenance
SE LEDs	L90 @ 41k Hrs / L80 @ >54k Hrs / L70 @ >54k Hrs	L90 @ 41k Hrs / L80 @ 84k Hrs / L70 @ 134k Hrs

BSE Labeling Options	
BSE10	Drivers load transfer relay installed per manufacturer's instructions. Voltage, BGTD and BSE10 called out.
BSE14	One voltage fixture with driver load control relay supplied with one prewire (PWS option). Prewire wired for normal circuit, the control relay for emergency circuit left unconnected. Voltage, BGTD, BSE14 and prewire called out, in the description.

*For configurations with Reloc or two voltages an RFA modification is required.

ACCESSORIES

Accessories: Order as separate catalog number.

DGA14	Drywall grid adapter for 1x4 recessed fixture.
DGA22	Drywall grid adapter for 2x2 recessed fixture.
DGA24	Drywall grid adapter for 2x4 recessed fixture.
PANLEM E10WCP BKT CVR	Field installable kit includes 10 watt battery, bracket and cover ¹
PANLEM BKT CVR	Field installable kit bracket and cover only, 10W battery NOT included ¹
2X2SMKSH	2'x2' Surface Mount Troffer Kit
2X4SMKSH	2'x4' Surface Mount Troffer Kit
1X4SMKSH	1'x4' Surface Mount Troffer Kit
BDP U	Field Installable Ballast Disconnect Plug
PAC 2DNF 36	Panel Air Craft Kit, 2 cables with Y splitter, No Power Feed, 36 inches. Recommended for 1X4 or 2X2 Panel Fixtures only. ²
PAC 2DF 36	Panel Air Craft Kit, 2 cables with Y splitter, with Power Feed, 36 inches. Recommended for 1X4 or 2X2 Panel Fixtures only. ^{2,3}
PAC 4DNF 36	Panel Air Craft Kit, 4 cables, No Power Feed, 36 inches. Recommended for 2X4, 1X4 or 2X2 Panel Fixtures. ²
PAC 4DF 36	Panel Air Craft Kit, 4 cables, with Power Feed, 36 inches. Recommended for 2X4, 1X4 or 2X2 Panel Fixtures. ^{2,3}
PAC 2DNF 72	Panel Air Craft Kit, 2 cables with Y splitter, No Power Feed 72 inches. Recommended for 1X4 or 2X2 Panel Fixtures only. ²
PAC 2DF 72	Panel Air Craft Kit, 2 cables with Y splitter, with Power Feed, 72 inches. Recommended for 1X4 or 2X2 Panel Fixtures only. ^{2,3}
PAC 4DNF 72	Panel Air Craft Kit, 4 cables, No Power Feed, 72 inches. Recommended for 2X4, 1X4 or 2X2 Panel Fixtures. ²
PAC 4DF 72	Panel Air Craft Kit, 4 cables, with Power Feed, 72 inches. Recommended for 2X4, 1X4 or 2X2 Panel Fixtures. ^{2,3}

Emergency Battery Estimated Lumens

Use the formula below to estimate the delivered lumens in emergency mode

Estimated Lumens = 1.25 x P x LPW

P = Output power of emergency driver (10W for PS1055CP)

LPW = Lumen per watt rating of the luminaire.

SMKSH Accessory



Notes:

1. Test switch must be remote mounted or installed in an adjacent ceiling tile.
2. See Suspension Kits section below for additional detail.
3. For MVOLT only, not available with 347V

Emergency Battery Pack Options – Field Installable

Battery Model Number	Wattage	Runtime (Minutes)	Lumen Output* @ 120 Lumens/Watt	Other
ILB CP07 2H A	7W	120	840	Storm Shelter / 2 Hour Runtime
ILB CP10 A	10W	90	1200	
ILB CP10 HE AELR A	10W	90	1200	Title 20; Enabled with Self Testing, Automated Reporting (STAR)
ILBLP CP10 HE SD A	10W	90	1200	Title 20, Self Diagnostic
ILBLP CP15 HE SD A	15W	90	1800	Title 20, Self Diagnostic
ILB CP20 HE A	20W	90	2400	Title 20
ILB CP20 HE SD A	20W	90	2400	Title 20, Self Diagnostic

UL 924 Response – nLight AIR Devices with EM Option

The below information applies to all nLight AIR devices with an EM option.

- EM devices will remain at their high-end trim and ignore wireless lighting control commands, unless a normal-power-sensed (NPS) broadcast is received at least every 8 seconds.
- Using the CLAIRITY+ mobile app, EM devices must be associated with a group that includes a normal power sensing device to receive NPS broadcasts.
- Only non-emergency rPP20, rLSXR, rSBOR, rSDGR, and nLight AIR luminaires with version 3.4 or later firmware can provide normal power sensing for EM devices. See specification sheets for control devices and luminaires for more information on options that support normal power sensing.

All the above are UL Listed products that are certified for field install external/remote to the fixture.

*Minimum delivered lumen output to assist in product selection for increased fixture mounting height.

The CP10 delivered emergency illumination outperforms legacy 1400 lumen fluorescent emergency ballast.

Please contact us at techsupport@iotaengineering.com for any Emergency Battery related questions.

Enabled with STAR

Emergency Lighting with Self-Testing Automated Reporting (STAR), enables self-testing and automated reporting to aid in life safety code compliance. Build your solution and choose your preferred deployment from Mobile STAR, where test data is logged in each individual unit and broadcast to the CLAIRITY+ app, or Connected STAR, where test data is logged in the STAR Gateway by IOTA® and emailed directly. **Leave the ladders, disruptions and written records behind with emergency lighting solutions with STAR!**

Life Safety Code NFPA 101 testing and reporting requirements for emergency lighting include:

- Testing for 30 seconds every 30 days
- Testing for 90 minutes once a year
- Record keeping and to report to the authority having local jurisdiction

MOBILE STAR

For small scale applications

CONNECTED STAR

For large scale applications

Suspension Kits

2 drops (1x4)

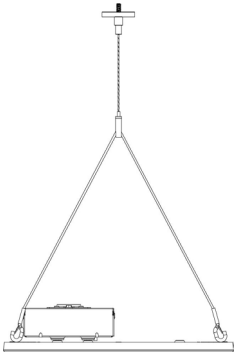

2 drops (2x2)

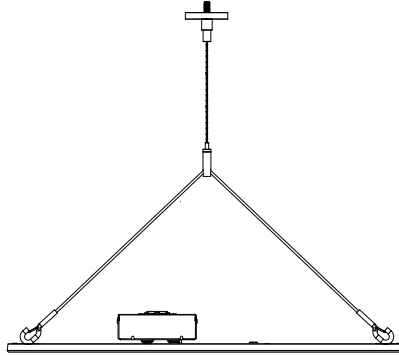

4 drops (2x4)

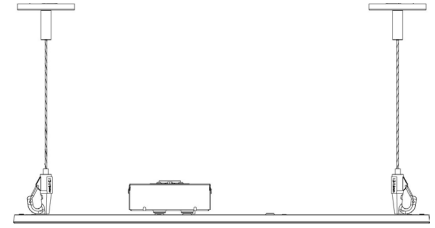

EPANL LED Flat Panel

nLight Platform

nLight embedded fixtures offer:	Customers get:
Manual Dimming	Convenience and visual comfort for occupants
Motion Sensing and/or Daylight Harvesting	Energy savings and code compliance
Fixture or Group Level Control	Ability to configure lighting to the space requirements
Flexibility	Ease of fixture moves, adds and changes
Wireless Wall Switch (nLight AIR Only)	Ease and flexibility of placement
Astronomical and Time of Day Scheduling	Energy savings and building security
Scalable Solution	nLight controls to grow with your business
Future-Ready	nLight platform to set foundation for future upgrades and capabilities

nLight Air Wireless

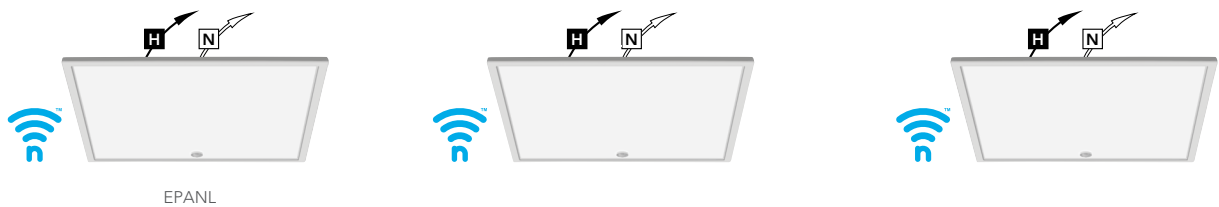

Simple as 1,2,3

1. Install the nLight® AIR fixtures with embedded smart sensor
2. Install the wireless battery-powered wall switch
3. With the CLAIRITY+ Pro app, pair the fixtures with the wall switch and if desired, customize the sensor settings for the desired outcome



nLight Wired Networking

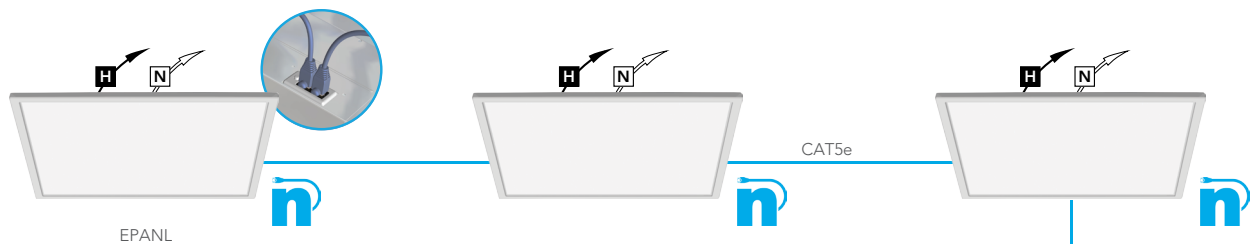

Simple as 1,2,3

1. Install the nLight® Wired fixtures with nIO control
2. Install the nLight Wired wall switch
3. Connect the fixtures using standard CAT5e cables and the devices will automatically discover each other and work (plug and play)



EPANL LED Flat Panel

Controls Accessories

nLight® Wired Control Accessories: <i>Order as separate catalog number. Visit www.acuitybrands.com/products/controls/nlight.</i>			
WallPod stations	Model number	Occupancy sensors	Model number
On/Off	nPODMA [Color]	Small motion 360°, ceiling (PIR / dual tech)	nCM 9 RJB / nCM PDT 9 RJB
On/Off & raise/lower	nPODMA DX [Color]	Large motion 360°, ceiling (PIR / dual tech)	nCM10 RJB / nCM PDT 10 RJB
Graphic touchscreen	nPOD TOUCH [Color]	Wall switch with raise/lower	nWSX PDT LV DX [color]
Photocell controls	Model number	Cat-5 cable (plenum rated)	Model number
Full range dimming	nCM ADCX RJB	10' cable	CATS 10FT J1
		30' cable	CATS 30FT J1

nLight® AIR Control Accessories: <i>Order as separate catalog number. Visit www.acuitybrands.com/products/controls/nlightair.</i>	
Wall switches	Model number
On/Off single pole	rPODBA [color] G2
On/Off two pole	rPODB A2P [color] G2
On/Off & raise/lower single pole	rPODBA DX [color] G2
On/Off & raise/lower two pole	rPODBA 2P DX [color] G2

EPANL fixtures with integrated rIO devices complement any small office space. Pair them with an rCMS occupancy sensor and the space now has wireless occupancy sensing and dimming capability. For additional configuration options please consult with Tech Support.

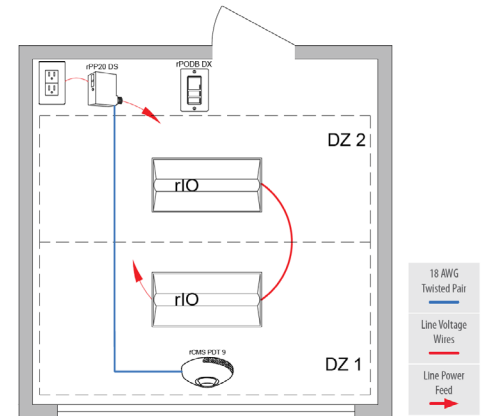
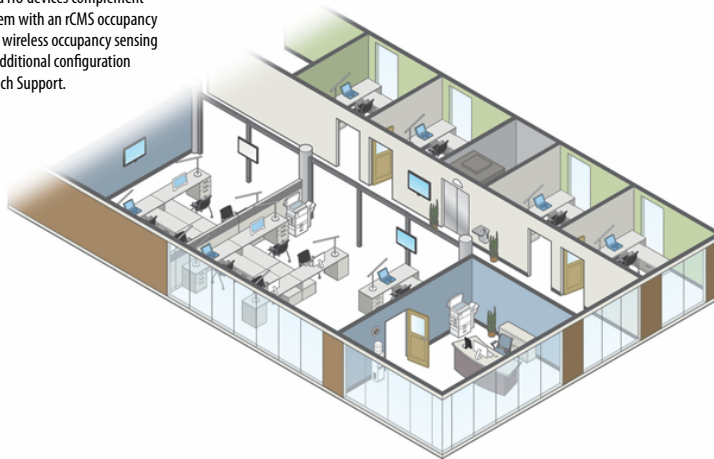

rCMS ¹		Example: RCMS PDT 10 AR G2					
Series / Detection	Power Supply ¹	Occupancy Detection	Lens (Required)	Operating Mode	Generation		
RCMS nLight AIR occupancy and daylight sensor	[blank] Power Supply ordered separately PS 150 Standard 150 mA Power Supply	[blank] PIR Detection PDT Dual Tech PIR/Microphonics	10 Large Motion/ Extended Range 360° 9 Small Motion/ Extended Range 360° 6 High Bay 360° Lens	[BLANK] None AR Auxiliary Relay	G2	Generation 2 compatibility	

Notes

1 RCMS requires low voltage power from either RPP20 DS 24V G2 or PS150.



Sensor Coverage Pattern Mini 360° Lens

- Recommended for walking motion detection from mounting heights between 8 ft (2.44 m) and 20 ft (6.10 m)
- Initial detection of walking motion along sensor axes at distances of 2x the mounting height up to 15 ft (4.57 m) and
- 1.75x up to 20 ft (6.10 m).
- Provides 12 ft (3.66 m) radial detection of small motion when mounted at 9 ft (2.74 m)
- Initial detection will occur earlier when walking across sensor's field of view than when walking directly at sensor

9 FT Mounting

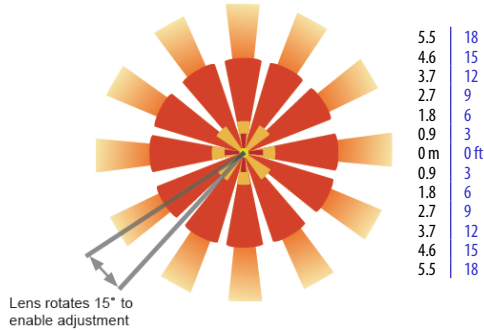

nLight AIR Wireless

nLight AIR is the ideal solution for retrofit or new construction spaces where adding additional wiring can be labor intensive and nLight AIR is available with or without an integral sensor. The integrated rES7 or rES7PDT smart sensors are part of each luminaire in the nLight AIR network, which can be grouped to control multiple luminaires. The granularity of control with the digital PIR occupancy detection and daylight sensing makes a great solution for any application.

Sequence of Operation (nES7 and Sensor)

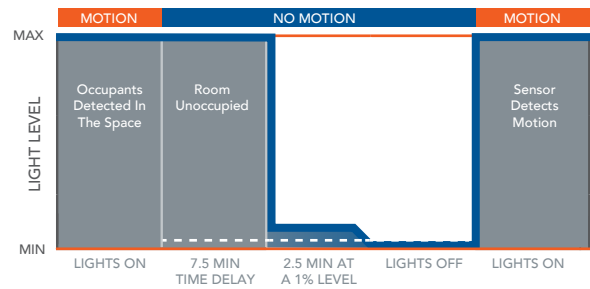

*The presetting on the automatic dimming photocell is 10fc (RES7).

EPANL LED Flat Panel

Performance Data					
Model Number	DLC Classification	Lumens	Watts	LPW	DLC Product ID
EPANL 1X4 1500LM 80CRI 35K [MIN1, MIN10] [BLANK, ZT, EZT, NLIGHT] [MVOLT, 120, 277] [ALL OPTIONS]	Standard	1574	14	113	PII6VKUP
EPANL 1X4 1500LM 80CRI 40K [MIN1, MIN10] [BLANK, ZT, EZT, NLIGHT] [MVOLT, 120, 277] [ALL OPTIONS]	Standard	1637	14	117	P7MFGP4R
EPANL 1X4 3000LM 80CRI 35K [MIN1, MIN10] [BLANK, ZT, EZT, NLIGHT] [MVOLT, 120, 277] [ALL OPTIONS]	Standard	2960	27	110	P5L7HREA
EPANL 1X4 3000LM 80CRI 40K [MIN1, MIN10] [BLANK, ZT, EZT, NLIGHT] [MVOLT, 120, 277] [ALL OPTIONS]	Standard	3078	27	114	PICJQWDG
EPANL 1X4 4000LM 80CRI 35K [MIN1, MIN10] [BLANK, ZT, EZT, NLIGHT] [MVOLT, 120, 277] [ALL OPTIONS]	Not Listed	3811	37	104	
EPANL 1X4 4000LM 80CRI 40K [MIN1, MIN10] [BLANK, ZT, EZT, NLIGHT] [MVOLT, 120, 277] [ALL OPTIONS]	Standard	3963	37	107	P4SKVRJP
EPANL 1X4 4800LM 80CRI 40K [MIN1, MIN10] [BLANK, ZT, EZT, NLIGHT] [MVOLT, 120, 277] [ALL OPTIONS]	Standard	4923	45	110	PR3K6SHH
EPANL 2X2 2000LM 80CRI 35K [MIN1, MIN10] [BLANK, ZT, EZT, NLIGHT] [MVOLT, 120, 277] [ALL OPTIONS]	Standard	2071	19	110	P7I6D3WI
EPANL 2X2 2000LM 80CRI 40K [MIN1, MIN10] [BLANK, ZT, EZT, NLIGHT] [MVOLT, 120, 277] [ALL OPTIONS]	Standard	2154	19	115	PPTL71HY
EPANL 2X2 3400LM 80CRI 35K [MIN1, MIN10] [BLANK, ZT, EZT, NLIGHT] [MVOLT, 120, 277] [ALL OPTIONS]	Standard	3428	30	113	PQAFPPJ6
EPANL 2X2 3400LM 80CRI 35K [MIN1, MIN10] [BLANK, ZT, EZT, NLIGHT] 347 [ALL OPTIONS]	Not Listed	3428	30	113	
EPANL 2X2 3400LM 80CRI 40K [MIN1, MIN10] [BLANK, ZT, EZT, NLIGHT] [MVOLT, 120, 277] [ALL OPTIONS]	Standard	3566	30	118	PY8MM627
EPANL 2X2 3400LM 80CRI 40K [MIN1, MIN10] [BLANK, ZT, EZT, NLIGHT] 347 [ALL OPTIONS]	Standard	3566	30	118	PMKTPCS2
EPANL 2X2 4000LM 80CRI 35K [MIN1, MIN10] [BLANK, ZT, EZT, NLIGHT] [MVOLT, 120, 277] [ALL OPTIONS]	Not Listed	3963	37	108	
EPANL 2X2 4000LM 80CRI 40K [MIN1, MIN10] [BLANK, ZT, EZT, NLIGHT] [MVOLT, 120, 277] [ALL OPTIONS]	Standard	4121	37	110	PW0040LR
EPANL 2X2 4800LM 80CRI 35K [MIN1, MIN10] [BLANK, ZT, EZT, NLIGHT] [MVOLT, 120, 277] [ALL OPTIONS]	Not Listed	4729	45	106	
EPANL 2X2 4800LM 80CRI 40K [MIN1, MIN10] [BLANK, ZT, EZT, NLIGHT] [MVOLT, 120, 277] [ALL OPTIONS]	Standard	4843	45	109	PS2AC19A
EPANL 2X4 3000LM 80CRI 35K [MIN1, MIN10] [BLANK, ZT, EZT, NLIGHT] [MVOLT, 120, 277] [ALL OPTIONS]	Standard	3141	29	110	P4PIGUFW
EPANL 2X4 3000LM 80CRI 40K [MIN1, MIN10] [BLANK, ZT, EZT, NLIGHT] [MVOLT, 120, 277] [ALL OPTIONS]	Standard	3266	29	115	PSPB7FBG
EPANL 2X4 4000LM 80CRI 35K [MIN1, MIN10] [BLANK, ZT, EZT, NLIGHT] [MVOLT, 120, 277] [ALL OPTIONS]	Standard	4077	38	108	PG2MHOZE
EPANL 2X4 4000LM 80CRI 40K [MIN1, MIN10] [BLANK, ZT, EZT, NLIGHT] [MVOLT, 120, 277] [ALL OPTIONS]	Standard	4240	38	113	PNKUCIIA
EPANL 2X4 4000LM 80CRI 40K [MIN1, MIN10] [BLANK, ZT, EZT, NLIGHT] 347 [ALL OPTIONS]	Not Listed	4240	38	113	
EPANL 2X4 4800LM 80CRI 35K [MIN1, MIN10] [BLANK, ZT, EZT, NLIGHT] [MVOLT, 120, 277] [ALL OPTIONS]	Standard	4998	45	111	P8FFEBQH
EPANL 2X4 4800LM 80CRI 35K [MIN1, MIN10] [BLANK, ZT, EZT, NLIGHT] 347 [ALL OPTIONS]	Not Listed	4998	45	111	
EPANL 2X4 4800LM 80CRI 40K [MIN1, MIN10] [BLANK, ZT, EZT, NLIGHT] [MVOLT, 120, 277] [ALL OPTIONS]	Standard	5119	45	113	PL3AU798
EPANL 2X4 4800LM 80CRI 40K [MIN1, MIN10] [BLANK, ZT, EZT, NLIGHT] 347 [ALL OPTIONS]	Not Listed	5119	45	113	
EPANL 2X4 5400LM 80CRI 35K [MIN1, MIN10] [BLANK, ZT, EZT, NLIGHT] [MVOLT, 120, 277] [ALL OPTIONS]	Standard	5546	49	113	PVKKX9GJ
EPANL 2X4 5400LM 80CRI 40K [MIN1, MIN10] [BLANK, ZT, EZT, NLIGHT] [MVOLT, 120, 277] [ALL OPTIONS]	Standard	5679	49	116	P31GEZNP
EPANL 2X4 6000LM 80CRI 35K [MIN1, MIN10] [BLANK, ZT, EZT, NLIGHT] [MVOLT, 120, 277] [ALL OPTIONS]	Standard	6364	50	127	PMHI2SAT
EPANL 2X4 6000LM 80CRI 35K [MIN1, MIN10] [BLANK, ZT, EZT, NLIGHT] 347 [ALL OPTIONS]	Standard	6364	55	115	PD2QM1LA
EPANL 2X4 6000LM 80CRI 40K [MIN1, MIN10] [BLANK, ZT, EZT, NLIGHT] [MVOLT, 120, 277] [ALL OPTIONS]	Standard	6548	50	131	P4H3UGFQ

EPANL LED Flat Panel

PHOTOMETRICS

Full Photometric data is available on Lithonia.acuitybrands.com

EPANL 2x2 4000LM 80CRI 40K, 4121 delivered lumens.

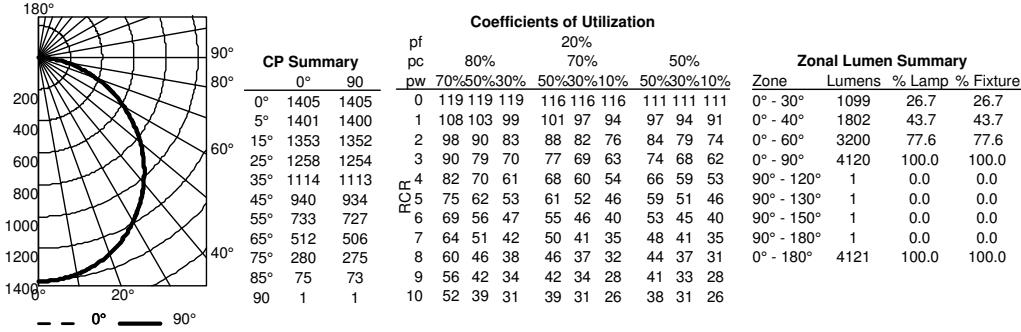

EPANL 2x4 4800LM 80CRI 40K, 5119 delivered lumens.

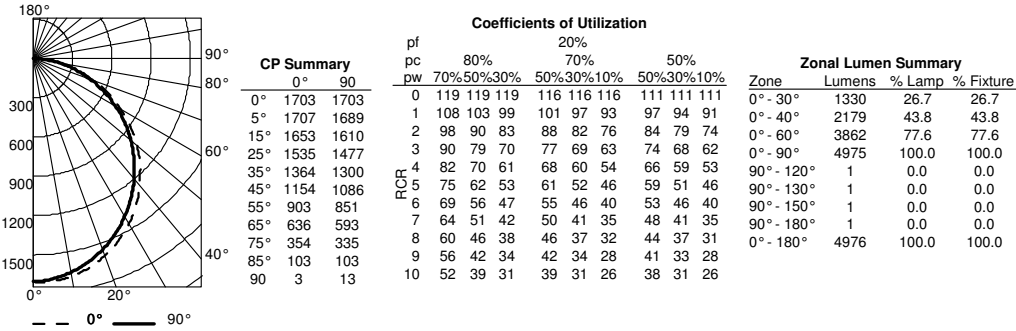

DIMENSIONS

1X4 Configurations

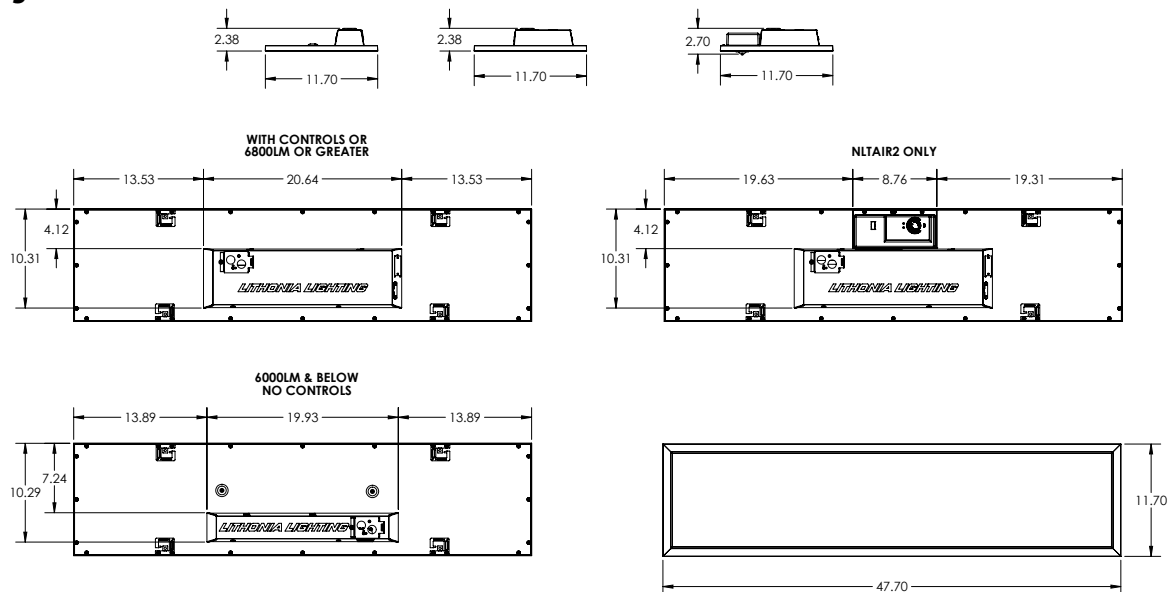

2X2 Configurations

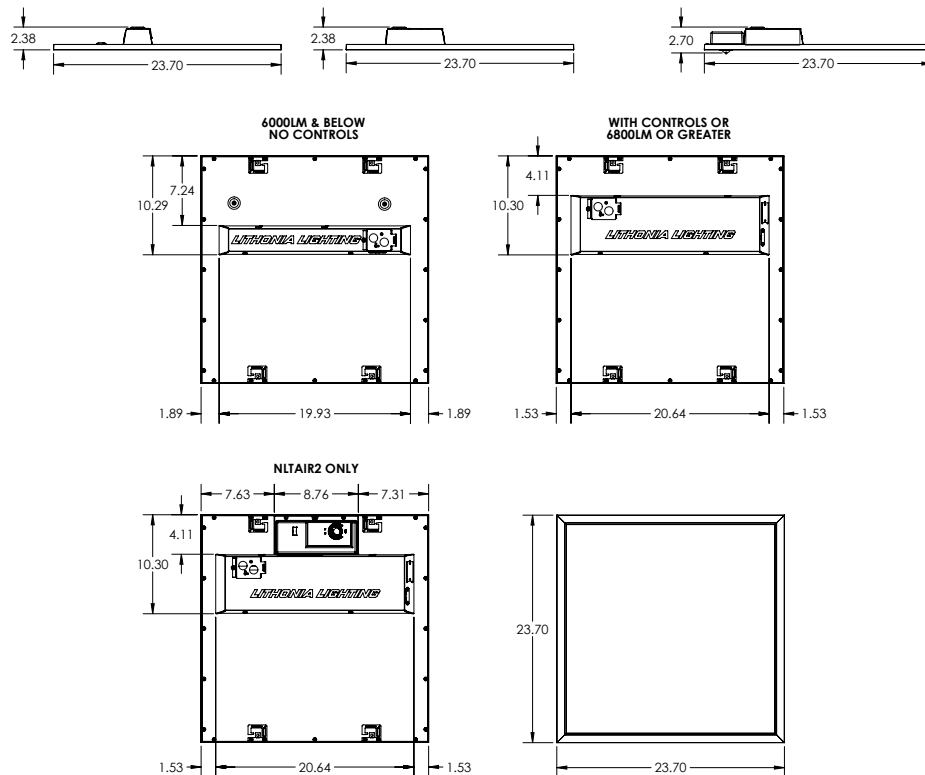

DIMENSIONS (continued)

2X4 Configurations

