

GROUNDING BUSBAR - ELECTRICAL BUSBAR

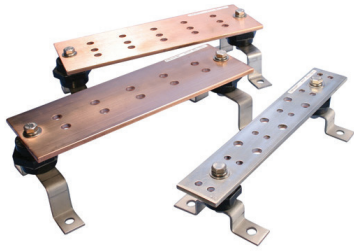

FEATURED HIGHLIGHTS

- Provides a convenient, single-point grounding and bonding location
- Conductors are welded to the bar using a Cadweld exothermic connection or are mechanically fastened by using lugs
- Custom bars can be designed and manufactured to customer specifications

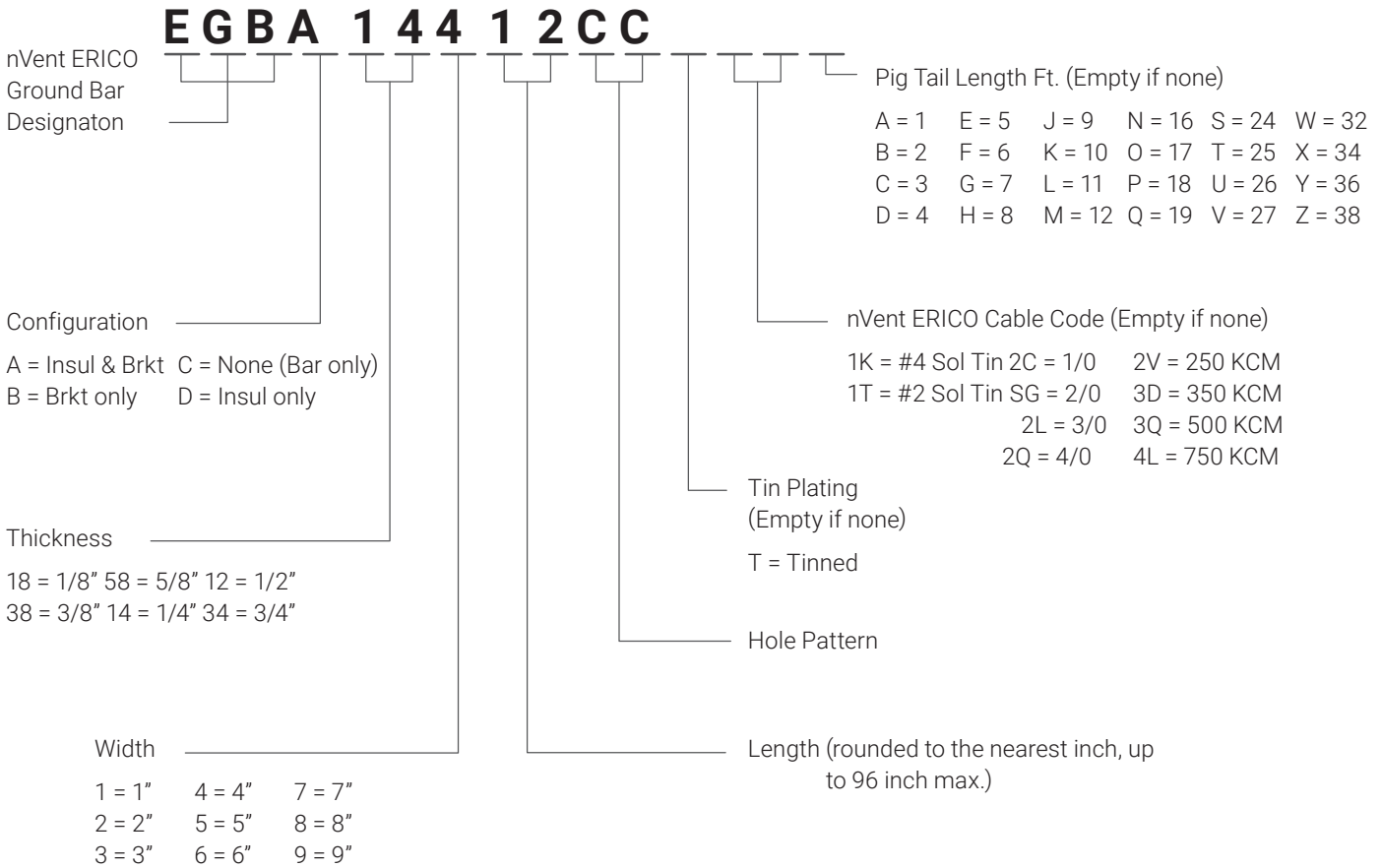

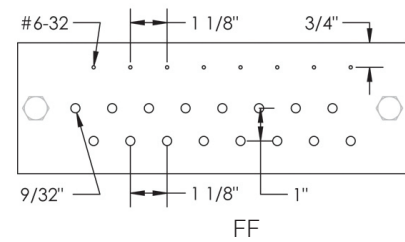
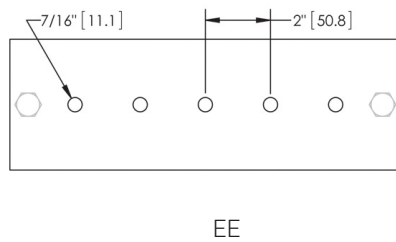
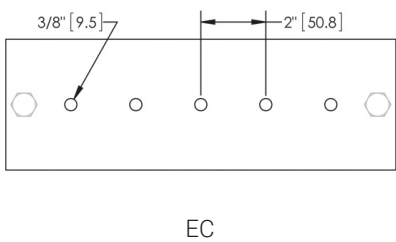
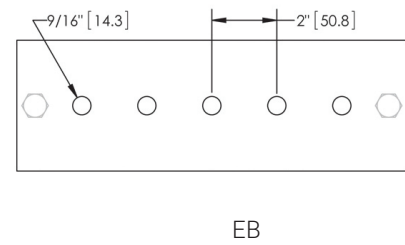
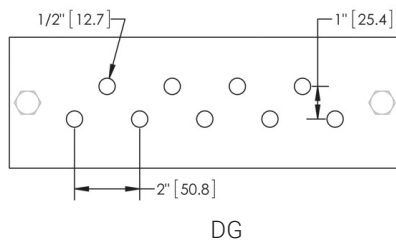
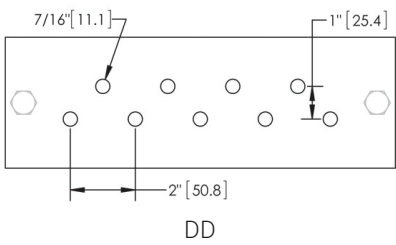
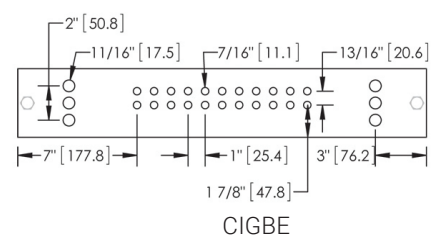
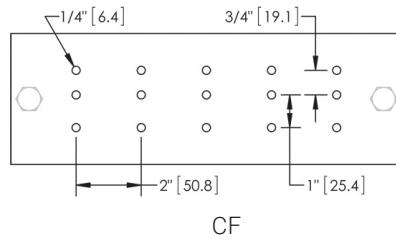
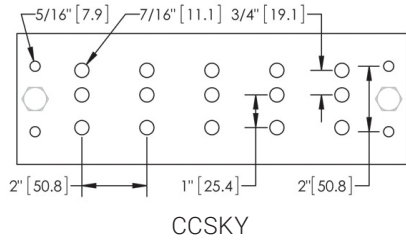
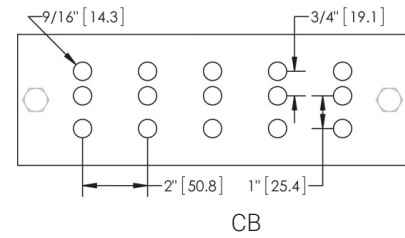
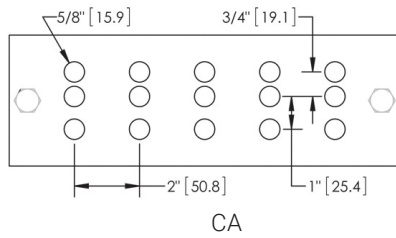
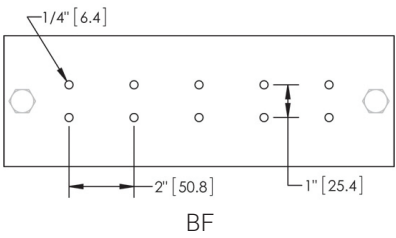
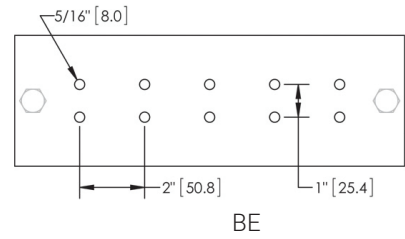
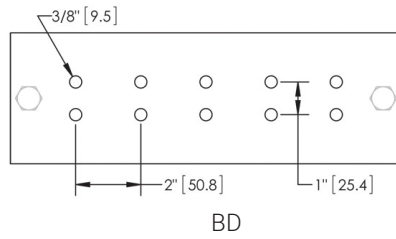
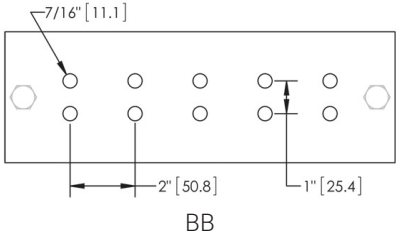
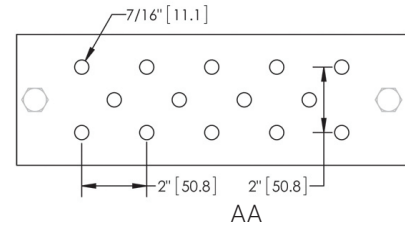
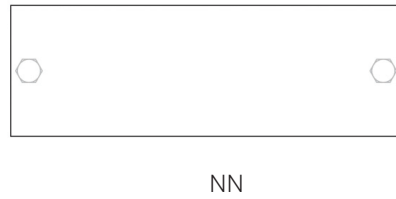
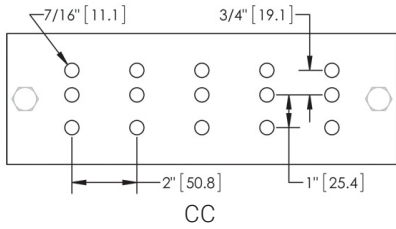

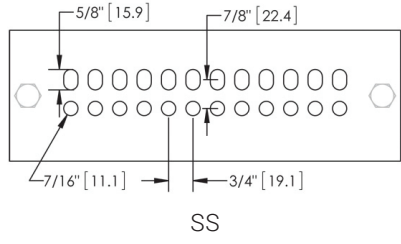
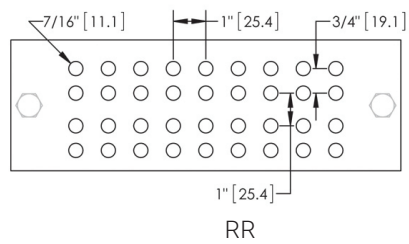
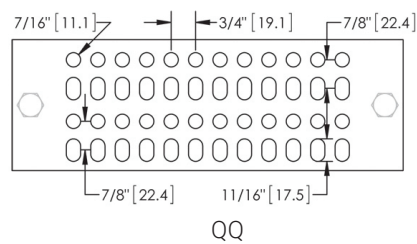
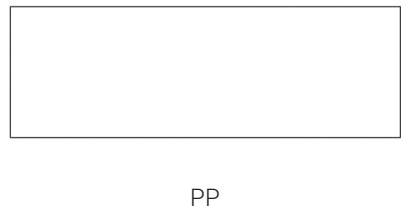
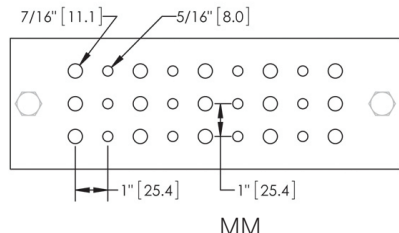
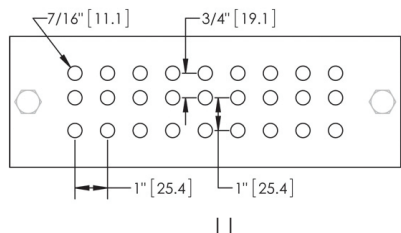
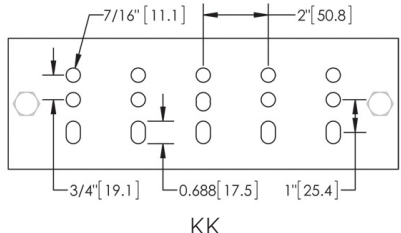
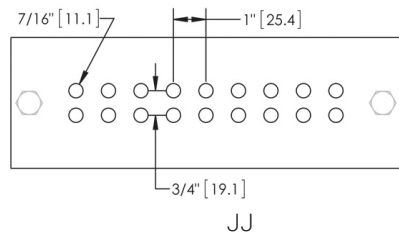
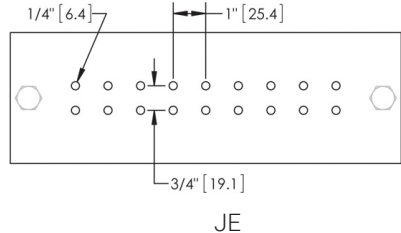
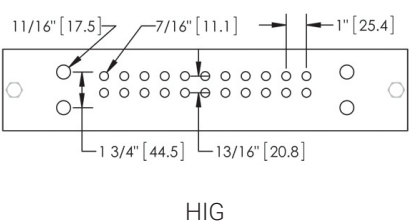
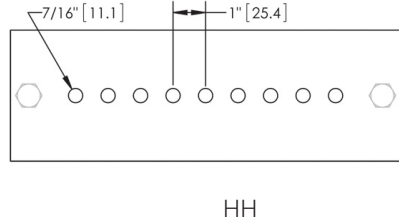
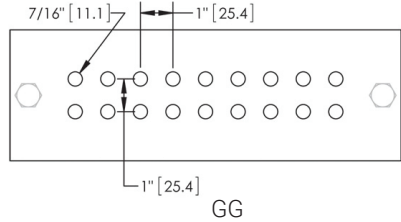
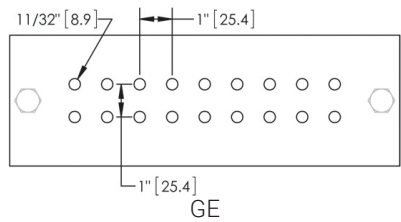

Global Part Number	Hole Pattern	Mounting Hole Size	Length	Width	Thickness	Tin Plating	Pigtail Included
EGBA14112EE	EE	0.438"	12"	1"	1/4"	No	No
EGBA14212BB	BB	0.438"	12"	2"	1/4"	No	No
EGBA14212EE	EE	0.438"	12"	2"	1/4"	No	No
EGBA14212HH	HH	0.438"	12"	2"	1/4"	No	No
EGBA14212NN	NN	0.438"	12"	2"	1/4"	No	No
EGBA14212TES	TES	0.438"	12"	2"	1/4"	No	No
EGBA14215JJ	JJ	0.438"	15"	2"	1/4"	No	No
EGBA14215TES	TES	0.438"	15"	2"	1/4"	No	No
EGBA14224NN	NN	0.438"	24"	2"	1/4"	No	No
EGBA14406CC	CC	0.438"	6"	4"	1/4"	No	No
EGBA14410FF	FF	0.438"	10"	4"	1/4"	No	No
EGBA14412AA	AA	0.438"	12"	4"	1/4"	No	No
EGBA14412BB	BB	0.438"	12"	4"	1/4"	No	No
EGBA14412CC	CC	0.438"	12"	4"	1/4"	No	No
EGBA14412GG	GG	0.438"	12"	4"	1/4"	No	No
EGBA14412LL	LL	0.438"	12"	4"	1/4"	No	No
EGBA14412MM	MM	0.438"	12"	4"	1/4"	No	No
EGBA14412NN	NN	0.438"	12"	4"	1/4"	No	No
EGBA14420CC	CC	0.438"	20"	4"	1/4"	No	No
EGBA14420CCT	CC	0.438"	20"	4"	1/4"	Yes	No
EGBA14420NN	NN	0.438"	20"	4"	1/4"	No	No
EGBA14424CC	CC	0.438"	24"	4"	1/4"	No	No
EGBA14424GG	GG	0.438"	24"	4"	1/4"	No	No
EGBA14424LL	LL	0.438"	24"	4"	1/4"	No	No
EGBA14424MM	MM	0.438"	24"	4"	1/4"	No	No
EGBA14424NN	NN	0.438"	24"	4"	1/4"	No	No
EGBA14436CC	CC	0.438"	36"	4"	1/4"	No	No