

E47 Precision Switch



Compact Prewired Switch



LS-Titan Miniature DIN Switch



E49 Compact Metal Switch



Heavy-Duty Factory Sealed 6P+ Switch



2.0	Introduction	
	Technical Reference	V8-T2-2
	Product Selection Guide	V8-T2-3
2.1	E47 Precision Switches	
	Product Description	V8-T2-6
	Product Selection	V8-T2-7
2.2	Compact Prewired Switches	
	Product Description	V8-T2-16
	Product Selection	V8-T2-17
2.3	LS-Titan Miniature DIN Switches	
	Product Description	V8-T2-21
	Product Selection	V8-T2-23
2.4	E49 Mini Metal Switches	
	Product Description	V8-T2-43
	Product Selection	V8-T2-44
2.5	E49 Compact Metal Switches	
	Product Description	V8-T2-49
	Product Selection	V8-T2-50
2.6	E50 Heavy-Duty Plug-In Switches	
	Product Description	V8-T2-53
	Product Selection	V8-T2-54
2.7	E50 Heavy-Duty Factory Sealed 6P+ Switches	
	Product Description	V8-T2-67
	Product Selection	V8-T2-68
2.8	Operators	
	Product Description	V8-T2-79
	Product Selection	V8-T2-80
2.9	Non Plug-In Switches	
	Product Description	V8-T2-87
	Product Selection	V8-T2-88
2.10	Hazardous Location Limit Switches	
	Product Description	V8-T2-90
	Product Selection	V8-T2-91
2.11	Special Purpose Limit Switches	
	Product Description	V8-T2-94
	Product Selection	V8-T2-95



Unless otherwise noted, the products contained in this section should not be used for functional safety applications. These products were not designed or tested to IEC 60947-5-3 or recommended for functional safety.



For Customer Service in the U.S. call 1-877-ETN CARE (386-2273),
in Canada call 1-800-268-3578.
For Application Assistance in the U.S. and Canada
call 1-800-426-9184.

Revision notes

Volume 8—Sensing Solutions, CA08100010E

Tab 2—Limit Switches

Revision date	Section	Change page(s)	Description
09/08/2017	2.0	V8-T2-3, V8-T2-4	Content edit
09/08/2017	2.1	V8-T2-9	Content edit
09/08/2017	2.2	V8-T2-18	Content edit
09/08/2017	2.3	V8-T2-21	Content edit
09/08/2017	2.6	V8-T2-53	Content edit
09/08/2017	2.7	V8-T2-67	Content edit
09/08/2017	2.9	V8-T2-87	Content edit
09/08/2017	All	All	Revision date changed to September 2017



Powering Business Worldwide

Technical Reference

Limit Switches

2



Mechanical Limit Switches are contact sensors widely used for detecting the presence or position of objects in industrial applications.

Limit Switches offer high precision in terms of accuracy and repeatability. This is primarily due to the fact that they make direct contact with the target. When an object contacts the limit switch lever (or plunger) the lever moves a pre-travel distance to the operating point where the contacts are tripped. Movement of the lever beyond this point is called the over-travel.

Lever Type Actuator

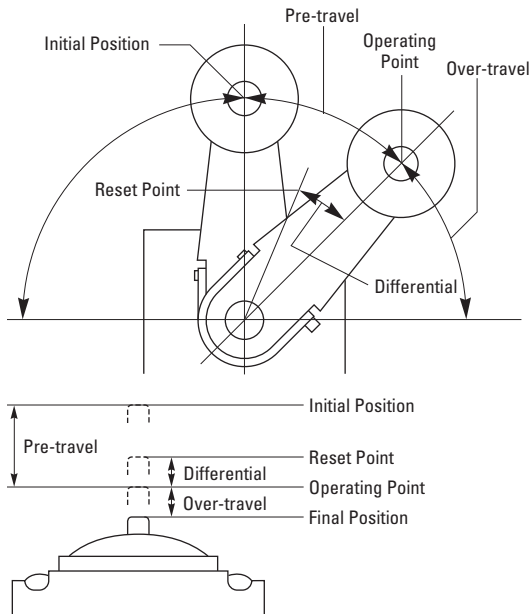

Refer to Sensor Learning Course, **Page V8-T12-4**, for a complete description of limit switch terminology.

Limit switches contain the following major components. These may be modular or part of a single-piece switch.

Limit Switch Components

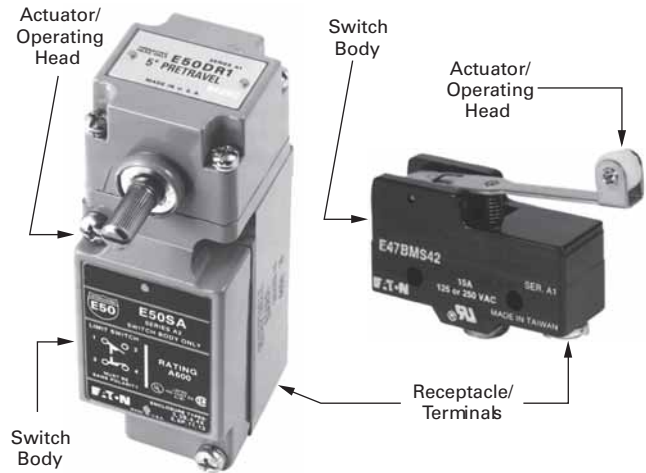

Actuator

This is the part of the switch that contacts the target. Typical actuators are levers and plungers. Several styles are available, see Sensor Learning Course, **Page V8-T12-4**, for more information.

Switch Body

This part contains the electrical contact mechanism. For complete information on electrical outputs, see Sensor Learning Course, **Page V8-T12-4**.

Terminals

The terminals are the point of connection for the wiring. These terminals may be on the body itself, or housed in a removable receptacle. The limit switch may also come equipped with a factory installed cable or pin-connector.

Product Selection Guide

E47 Precision Switches



Page V8-T2-6

Overview

Specified when accurate repeatability, choice of operating forces and travel characteristics and tightly controlled action of cam or target in space restricted areas are of prime importance. Cost effective and compact.

Applications

Overhead, folding and elevator doors, sliding gates, automated guided vehicles and commercial instrumentation

Product Features

Self-contained switches or with an enclosed cast housing for increased durability and conduit connection (1/2 in NPT)

High current capacity for power load switching and motor handling capability

Screw and solder terminations

Booted enclosed version shields actuators from debris

Mounting centers—1.0 in (25.4 mm), #8 screw size

Technical Data and Specifications

Mechanical life: 3,000,000 operations min.

Electrical life: 500,000 operations min.

Contact ratings—
NEMA A600, R300, AC-15, DC-13
15A/20A, 125 or 250 Vac

Enclosure ratings—
Enclosed: NEMA 1

Construction—
Basic: Phenolic
Enclosed: Aluminum die cast

Approvals

UL® Recognized, E117028
UL tested to Canadian safety standards
RoHS Compliant



Compact Prewired Switches



Page V8-T2-16

Overview

Designed to be a versatile, slim device for hard to fit applications where sealing integrity is required.

Applications

Machine tool, food processing and packaging

Product Features

Rugged aluminum alloy die cast housing
Sealed construction with enclosure ratings of NEMA 4, 6 and 13, IEC IP69K

Prewired with 3m of 18 AWG, AWM 2517, 300V cable

Stackable ridge for ganged operation

Technical Data and Specifications

Mechanical life: 10,000,000 operations min.

Electrical life: 200,000 operations
30 operations min.

Contact ratings—
NEMA B300

Enclosure ratings—
NEMA 4, 6 and 13; IP67, IP69

Construction—
Aluminum alloy die cast

Approvals

UL Listed, E170645 (cable versions only)
UL tested to Canadian safety standards
CE
RoHS Compliant



LS-Titan Miniature DIN Switches



Page V8-T2-21

Overview

Safety position switches with insulated plastic or rugged metal enclosures. Approved for worldwide safety application.

Applications

Automatic vending machines, electronic assembly machines, elevators and lifts, injection molding, packaging and safety applications

Product Features

Modular plug-in head and body components

Positive opening NC contacts for safety applications

Operating heads can be rotated 90 degrees to suit specific direction of operation

Technical Data and Specifications

Mechanical life: 8,000,000 operations

Contact ratings—
AC-15, 6A at 24V, 6A at 230/240V,
4A at 400/415V;
DC-13, 3A at 24V, 800 mA at 110V,
300 mA at 220V

Enclosure ratings—
IP66, IP67 (by model)

Construction—
Plastic or metal (by model)

Approvals

Safety function, IEC/EN 60947-5-1
TÜV-Rheinland certified (LSE models)
UL Listed, E29184
CSA Certified, 12528
CE
CCC
RoHS Compliant



E49 Mini Metal Switches



Page V8-T2-43

Overview

Suitable for OEMs who require a small, cost-effective solution but cannot sacrifice durability and mechanical life as they would if they chose a plastic IEC style switch.

Applications

Automatic vending machines, electronic assembly machines, elevators and lifts, injection molding, packaging

Product Features

Pre-wired units with custom cable lengths available for high volume customers

“Fingerproof” terminals protect against accidental shock

Double-spring mechanism for contact reliability

Grounding terminal included

Captive screws on enclosure cover make wiring hassle-free

SPDT double break

Technical Data and Specifications

Contact ratings—
5A at 250 Vac
5A at 30 Vdc

Enclosure ratings—
IP65

Construction—
Zinc alloy

Approvals

UL Recognized, E117028
(Model E49G31C1P3 is not
UL Recognized)
CE
RoHS Compliant



E49 Compact Metal Switches



Page V8-T2-49

Overview

Designed with high mechanical strength for harsh environments. The rugged Aluminum die cast construction provides reliable, oil-tight, waterproof and dustproof sealing for a variety of applications. Snap action 1NO-1NC contacts provide flexibility in design.

Applications

Packaging, material handling conveyors, end-of-travel and guarding operations, baler/compactor, industrial door lifts

Product Features

Rigid die cast switch housing
Set position indicator plate for easy maintenance
High mechanical strength
Oiltight, waterproof and dustproof construction

Technical Data and Specifications

Mechanical life: 15,000,000 operations min.
Electrical life: 500,000 operations min. at full load
Contact ratings—
NEMA A600, R300; AC-15, DC-13
Enclosure ratings—
NEMA 4, 4X, 6, 6P, 12, 13; IP65, IP67
Construction—
Aluminum die cast

Approvals

UL Listed, E170645
UL tested to Canadian safety standards
RoHS Compliant



E50 Heavy-Duty Plug-In Switches



Page V8-T2-53

Overview

Versatile in design. High reliability. Low maintenance costs with installation ease. BEST CHOICE for Heavy-Duty Limit Switch applications. Withstands physical and chemical abuse of harsh industrial environments.

Applications

Punch presses, waste water treatment, machine tool, automotive, retrieval systems, industrial truck, car wash lines

Product Features

Modular operating heads, switch bodies and receptacles are interchangeable without field adjustment
Order as complete assemblies or components for stocking and manufacturing flexibility
90 degree total travel, 5 degree pre-travel characteristics are standard features
Viton® gasket, boot, and seal material offers exceptional chemical resistance
Rotary head operating mode from CW, CCW or CW and CCW is easily changed without tools

Technical Data and Specifications

Mechanical life: 13,000,000 operations min.
Electrical life: 1,000,000 operations min. at full load (single-pole)
Contact ratings—
NEMA A600, R300
Lighted versions A150, R150
6A, 120 Vac; 10A continuous
Enclosure ratings—
NEMA 1, 3, 3S, 4, 4X, 6, 6P, 13; IP67
Construction—Zinc die cast

Approvals

UL Listed, E170645
CSA Certified, 50513
CE (some models)
RoHS Compliant



E50 Heavy-Duty Factory Sealed 6P+ Switches



Page V8-T2-67

Overview

Designed specifically to withstand the penetrating properties of new cutting fluids (coolants), acid or caustic washes, salt spray, severe vibration, shock and temperature fluctuations, grit and debris.

Applications

Automotive, pulp and paper, food processing, waste management, primary metals, machine tool (cutting, forming, bending)

Product Features

Tamperproof, one-piece switch body assembly, epoxy filled
Factory sealed. 6P submersible. Pre-wired with cable, pigtail or pin connector options. All with ground connection
Utilizes E50 modular operating heads
Special V-seal on switch body/head connection provides hermetic barrier against fluid ingress
LED indicating light, 24V–120 Vac/dc neon version too

Technical Data and Specifications

Mechanical life: 35,000,000 operations min.
Electrical life: 1,000,000 operations min. at full load
Contact ratings—
NEMA A600, R300
Lighted versions A150, R150
6A, 120 Vac; 10A continuous
Enclosure ratings—
NEMA 1, 2, 3, 3S, 4, 4X, 6, 6P, 13; IP67, IP69
Construction—Zinc die cast

Approvals

UL Listed, E170645
CSA Certified, 50513
CE (some models)
RoHS Compliant



Operators



Page V8-T2-79

Overview

Wide variety of operator types for rotary and wobble style limit switches.

Applications

Used with E50, E50 6P+ and 10316 limit switches

Product Features

Rollers and rods available in metal and nonmetal contact surfaces

Technical Data and Specifications

Varies by model

Approvals

Varies by model

Non Plug-In Switches**Page V8-T2-87****Overview**

The Industrial standard for Non Plug-In Heavy-Duty Limit Switches. Sold as complete assembled units only.

Applications

Serving MRO and USER replacement requirements with broad d market coverage

Product Features

Side and top rotary, side and top push or wobble operation
 CW, CCW or CW and CCW operating modes are field convertible
 Double break-make snap action contacts, same polarity each pole
 Captive saddle clamp terminals accept up to #12 wire
 Head can be mounted in any of four discrete positions, intervals of 90 degrees

Technical Data and Specifications

Mechanical life: 10,000,000 operations min.
 Electrical life: 500,000 operations at full load
 Contact ratings—NEMA A600, R300 6A, 120 Vac; 10A continuous
 Enclosure ratings—NEMA 1, 4, 13
 Construction—
 Zinc die cast

Approvals

UL Listed, E170645
 CSA Certified, 50513

**Hazardous Location Switches****Page V8-T2-90****Overview**

Designed for severe environmental service in locations where there exists a danger of an internal or external explosion of flammable gases, vapors, metal alloy or grain dust.

Applications

Mining, metal cutting, grain storage, forest products, petrochemical, waste and sewage management, pharmaceutical

Product Features

Sealed and unsealed versions available
 One-way gasket on sealed version keeps liquids out, yet allows a harmless release of gases in the event of an internal explosion
 Silicon bronze housing provides excellent corrosion resistant properties in extreme NEMA 4X applications
 Temperature build-up on limit switch surface is dissipated by housing design and materials used
 Utilizes the operating heads and internal switch mechanisms of the 10316 Non Plug-In line

Technical Data and Specifications

NEMA 7, Div. 1, Class I, BCD
 NEMA 9, Div. 1, Class II, EFG
 Contact ratings—NEMA B600 3A, 120 Vac; 5A continuous
 Enclosure ratings—LX: NEMA 7, 9
 CX: NEMA 1, 4, 7, 9
 CB: NEMA 1, 4, 4X, 13
 CBX: NEMA 1, 4, 4X, 7, 9, 13
 Construction—LX, CX: Aluminum die cast
 CB, CBX: Silicon bronze

Approvals

UL Listed, E170645, E183975
 UL tested to Canadian safety standards

**Special Purpose Switches****Page V8-T2-94****Overview**

Variety of special function limit switch products.

Applications

Serving MRO and USER replacement requirements with broad market coverage

Product Features

Special function switch lines include:
 Cabinet door interlocks — when plunger is pulled out, red band indicator visually shows that interlock is defeated
 Precision switches—1NO-1NC, 2NO-2NC, or operator only. Variety of mounting brackets available
 Pneumatic time delay—ON delay and OFF delay. Timing range—0.05 to 60 seconds
 Rotating cam shaft switches

Technical Data and Specifications

See **Page V8-T2-97** for more information
 Enclosure ratings—
 NEMA 1 or NEMA 4 versions
 Construction—
 Zinc die cast
 PS: Phenolic

Approvals

UL Listed, E170645
 CSA Certified, 50513 (PS and J only)



2.1

Limit Switches

E47 Precision Switches

E47 Precision Switches

2



E47 Precision Switches

Product Description

E47 Precision Switches from Eaton's electrical sector provide high accuracy switching at an affordable price. A variety of standard features, such as current capacity, operating force, travel characteristics and actuators, lets you custom fit the switch to your application.

The switches are available in their compact basic form, or enclosed in a rugged, metal housing.

Features

- Compact housings are ideal for use where space is restricted
- Precision, snap-action operators provide accurate repeatability of electrical and mechanical operating characteristics
- High current capacity (up to 20A) allows power load switching and motor handling capability
- Enclosed booted versions shield actuators from debris

Contents

Description

	<i>Page</i>
E47 Precision Switches	
Product Selection	
Basic Switches	V8-T2-7
Enclosed Switches	V8-T2-8
Accessories	V8-T2-9
Technical Data and Specifications	V8-T2-9
Dimensions	V8-T2-13

 Drawings
Online

Operating Characteristics

Definitions

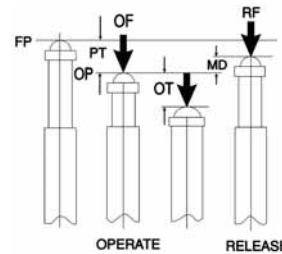

- OF—Operating Force
- RF—Return Force
- PT—Pre-Travel
- OT—Over-Travel
- MD—Movement Differential
- FP—Free Position
- OP—Operating Position

Standards and Certifications

- UL Recognized, E117028
- UL tested to Canadian safety standards
- RoHS Compliant



DANGER

THIS SENSOR IS NOT A SAFETY DEVICE AND IS NOT INTENDED TO BE USED AS A SAFETY DEVICE. This sensor is designed only to detect and read certain data in an electronic manner and perform no use apart from that, specifically no safety-related use. This sensor product does not include self-checking redundant circuitry, and the failure of this sensor product could cause either an energized or de-energized output condition, which could result in death, serious bodily injury, or property damage.

For the most current information on this product, visit our Web site: www.eaton.com

For Customer Service in the U.S. call 1-877-ETN CARE (386-2273), in Canada call 1-800-268-3578. For Application Assistance in the U.S. and Canada call 1-800-426-9184.

Product Selection

Basic Switches

E47 Precision Switches—Basic

	Type	15A Catalog Number	20A Catalog Number
Pin Plunger 	Pin Plunger		
	Screw terminal	E47BMS01	E47CMS01
	Solder terminal	E47BML01	E47CML01 ①
Extended Plunger 	Extended Plunger		
	Screw terminal	E47BMS03	—
	Solder terminal	E47BML03	—
Straight Plunger 	Straight Plunger		
	Screw terminal	E47BMS02	E47CMS02
	Solder terminal	E47BML02	E47CML02
Reversed Lever 	Reversed Lever		
	Screw terminal	E47BMS21	—
	Solder terminal	E47BML21	—
	Spade terminal	E47BMT21	—
Straight Lever 	Straight Lever		
	Screw terminal	E47BMS22	E47CMS22
	Solder terminal	E47BML22	—
Standard Lever 	Standard Lever		
	Screw terminal	E47BMS20	—
	Solder terminal	E47BML20	—
Extended Straight Plunger 	Extended Straight Plunger		
	Screw terminal	E47BMS04	E47CMS04
	Screw terminal (with space lugs)	E47BMT04	—
	Solder terminal	E47BML04	E47CML04

	Type	15A Catalog Number	20A Catalog Number
Roller Plunger 	Roller Plunger		
	Screw terminal	E47BMS10	E47CMS10
	Solder terminal	E47BML10	—
Cross Roller Plunger 	Cross Roller Plunger		
	Screw terminal	E47BMS11	E47CMS11
	Solder terminal	E47BML11	—
Reversed Roller Lever 	Reversed Roller Lever		
	Screw terminal	E47BMS41	—
	Solder terminal	E47BML41	—
Extended Roller Lever 	Extended Roller Lever		
	Screw terminal	E47BMS42	E47CMS42
	Solder terminal	E47BML42	—
Roller Lever 	Roller Lever		
	Screw terminal	E47BMS30	E47CMS30
	Solder terminal	E47BML30	—
	Spade terminal	E47BMT30	E47CMT30
One-Way Roller 	One-Way Roller		
	Screw terminal	E47BMS31	—
	Solder terminal	E47BML31	—
Integral Leaf 	Integral Leaf		
	Screw terminal	E47BMS23	E47CMS23
	Solder terminal	E47BML23	—

Note

① Contact Eaton’s Sensor Applications Department at 1-800-426-9184 for approval status.

2.1

Limit Switches

E47 Precision Switches

2

E47 Precision Switches—Basic, continued

Type	15A Catalog Number	20A Catalog Number
Adjustable Roller	Adjustable Roller	
Screw terminal	E47BMS40	—
Solder terminal	E47BML40	—
		
Extended Adjustable Roller	Extended Adjustable Roller	
Screw terminal	E47BMS43	—
Solder terminal	E47BML43	—
		

Enclosed Switches

E47 Precision Switches—Enclosed

	Catalog Number
Plunger Actuator	Plunger Actuator
	E47BLS05
	E47CLS05 ①②
Booted Plunger	Booted Plunger
	E47BLS06
	E47CLS06 ①②
Roller Lever	Roller Lever
	E47BLS32
	E47CLS32 ①②

E47 Precision Switches—Enclosed, continued



	Catalog Number
Booted Roller Lever	Booted Roller Lever
	E47BLS33
Roller Plunger	Roller Plunger
	E47BLS07
	E47BLS11 ③
Booted Roller Plunger	Booted Roller Plunger
	E47BLS08
	E47BLS12 ③
One-Way Roller	One-Way Roller
	E47BLS34
Booted One-Way Roller	Booted One-Way Roller
	E47BLS35
Booted Wobble	Booted Wobble
	E47BLS14

Notes

- ① Contact Eaton's Sensor Applications Department at 1-800-426-9184 for approval status.
- ② 20 ampere version.
- ③ Cross roller unit.

Accessories

Terminal Wire Covers for Basic Switches

	Description	Catalog Number
45° 	Terminal wire cover with 45° conduit interface	E47PA1
90° 	Terminal wire cover with 90° conduit interface	E47PA2

Technical Data and Specifications

E47 Precision Switches

Description	Specification
Operating speed	0.01m/second to 1m/second
Operating Frequency	
Mechanical	120 operations/minute
Electrical	20 operations/minute
Mechanical life	3,000,000 operations minimum
Electrical life	500,000 operations minimum
Contact resistance	15M ohms maximum, initial
Insulation resistance	100M ohms minimum at 500 Vdc
Dielectric Strength	
Between non-current carrying parts	1000 Vac, 50/60 Hz for 1 minute
Between current carrying parts and ground	2000 Vac, 50/60 Hz for 1 minute
Ambient Operating Temperature	
Basic	-13° to 176°F (-25° to 80°C)
Enclosed	5° to 176°F (-15° to 80°C)
Environmental rating enclosed, booted	NEMA 1
Mounting centers	1.0 in (25.4 mm), #8 screw size
Terminal screws	Bottom facing M4 x 0.7 Screws with cup washers will accept 22–12 AWG (2.5 sq. mm maximum) Maximum torque: 10 in-lbs.
Threaded bushing	15/32 in
Material of construction	Mineral filled phenolic
Enclosure rating	Aluminum die casting (ADC-3/A380); Seal boot: nitrile, butyl rubber (NBR)
Conduit fitting on enclosed type	1/2 in NPT

2.1

Limit Switches

E47 Precision Switches

2

Maximum Ampere Ratings ^{①②}

Model	Rated Voltage	Non-Inductive Load (A)			Inductive Load (A)			Inrush Current (A)	
		Resistive Load NC and NO	Lamp Load NC	NO	Inductive Load NC and NO	Motor Load NC	NO	NC	NO
15A	125 Vac	15	3	1.5	15	5	2.5	30 max.	15 max.
	250 Vac	15	2.5	1.25	15	3	1.5		
	500 Vac	3	1.5	0.75	2.5	1.5	0.75		
	8 Vdc	15	3	1.5	15	5	2.5		
	14 Vdc	15	3	1.5	10	5	2.5		
	30 Vdc	6 (2)	3	1.5	5	5	2.5		
	125 Vdc	0.4	0.4	0.4	0.05	0.05	0.05		
	250 Vdc	0.2	0.2	0.2	0.03	0.03	0.03		
20A	125 Vac	20	7.5	7.5	20	12.5	12.5	60 max.	30 max.
	250 Vac	20	7.5	7.5	20	8.3	8.3		
	500 Vac	6	4	4	5	2	2		
	8 Vdc	20	3	1.5	20	12.5	12.5		
	14 Vdc	20	3	1.5	15	12.5	12.5		
	30 Vdc	6	3	1.5	5	5	5		
	125 Vdc	0.5	0.5	0.5	0.05	0.05	0.05		
	250 Vdc	0.25	0.25	0.25	0.03	0.03	0.03		

Terminal Configurations

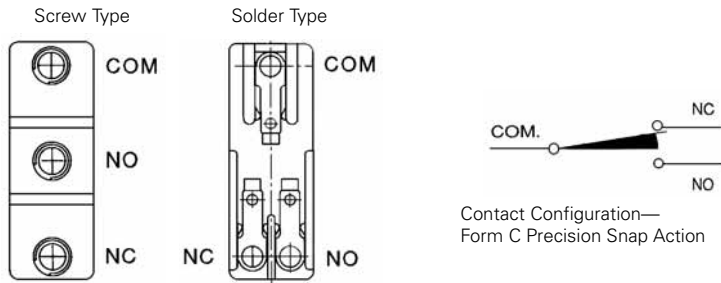

(Spade type not shown, available on some models)

Notes

- ① Inductive load has a power factor of 0.04 minimum (AC) and a time constant of 7 m/second (DC).
- ② Lamp load has an inrush current of six times steady-state current.

E47 Precision Switch Specifications—15 A

Catalog Number	E47B...01-V	E47B...02-V	E47B...03-V	E47B...04-V	E47B...05-V	E47B...06-V	E47B...07-V
Operating force (max.)	12.35 oz (350 g)	12.35 oz (350 g)	12.35 oz (350 g)	12.35 oz (350 g)	8.82–12.3 oz (250–350 g)	28.22 oz (800 g)	8.82–12.3 oz (250–350 g)
Return force (min.)	—	—	—	—	4.02 oz (114 g)	8.47 oz (240 g)	4.02 oz (114 g)
Return force (max.)	4.02 oz (114 g)	4.02 oz (114 g)	4.02 oz (114 g)	4.02 oz (114 g)	—	—	—
Pre-travel (max.)	0.016 in (0.4 mm)	0.016 in (0.4 mm)	0.016 in (0.4 mm)	0.016 in (0.4 mm)	0.016 in (0.4 mm)	0.079 in (2 mm)	0.02 in (0.5 mm)
Overtravel (max.)	0.005 in (0.13 mm)	0.063 in (1.6 mm)	0.063 in (1.6 mm)	0.217 in (5.5 mm)	0.217 in (5.5 mm)	0.197 in (5 mm)	0.142 in (3.6 mm)
Movement differential (max.)	0.002 in (0.05 mm)	0.002 in (0.05 mm)	0.002 in (0.05 mm)	0.002 in (0.05 mm)	0.002 in (0.05 mm)	0.004 in (0.1 mm)	0.002 in (0.05 mm)
Free position (max.)	—	—	—	—	—	—	—
Operating position (max.)	0.626 in (15.9 mm)	0.846 in (21.5 mm)	1.11 in (28.2 mm)	0.858 in (21.8 mm)	1.504 in (38.2 mm)	1.803 in (45.8 mm)	1.957 in (49.7 mm)

Catalog Number	E47B...08-V	E47B...10-V	E47B...11-V	E47B...11-V Cross Roller Unit	E47B...12-V Cross Roller Unit	E47B...14-V	E47B...20-V
Operating force (max.)	17.64 oz (500 g)	12.35 oz (350 g)	12.35 oz (350 g)	8.82–12.3 oz (250–350 g)	17.64 oz (500 g)	2.12 oz (60 g)	3.53 oz (100 g)
Return force (min.)	3.53 oz (100 g)	—	—	4.02 oz (114 g)	3.53 oz (100 g)	0.88 oz (25 g)	0.99 oz (28 g)
Return force (max.)	—	4.02 oz (114 g)	4.02 oz (114 g)	—	—	—	—
Pre-travel (max.)	0.039 in (1 mm)	0.016 in (0.4 mm)	0.016 in (0.4 mm)	0.02 in (0.5 mm)	0.039 in (1 mm)	0.52 in (13.2 mm)	0.197 in (5 mm)
Overtravel (max.)	0.138 in (3.5 mm)	0.141 in (3.58 mm)	0.141 in (3.58 mm)	0.142 in (3.6 mm)	0.138 in (3.5 mm)	0.315 in (8 mm)	0.079 in (2 mm)
Movement differential (max.)	0.005 in (0.12 mm)	0.002 in (0.05 mm)	0.002 in (0.05 mm)	0.002 in (0.05 mm)	0.005 in (0.12 mm)	0.039 in (1 mm)	0.039 in (1 mm)
Free position (max.)	—	—	—	—	—	—	0.976 in (24.8 mm)
Operating position (max.)	1.957 in (49.7 mm)	1.315 in (33.4 mm)	1.315 in (33.4 mm)	1.957 in (49.7 mm)	1.957 in (49.7 mm)	—	0.748 in (19 mm)

Catalog Number	E47B...21-V	E47B...22-V	E47B...23-V	E47B...30-V	E47B...31-V	E47B...32-V	E47B...33-V
Operating force (max.)	5.29 oz (150 g)	2.47 oz (70 g)	0.35 oz (10 g)	5.64 oz (160 g)	5.64 oz (160 g)	20.11 oz (570 g)	22.58 oz (640 g)
Return force (min.)	—	0.49 oz (14 g)	0.11 oz (3 g)	1.48 oz (42 g)	1.48 oz (42 g)	6 oz (170 g)	8.11 oz (230 g)
Return force (max.)	0.49 oz (14 g)	—	—	—	—	—	—
Pre-travel (max.)	0.157 in (4 mm)	0.394 in (10 mm)	0.787 in (20 mm)	0.106 in (2.7 mm)	0.106 in (2.7 mm)	0.157 in (4 mm)	0.197 in (5 mm)
Overtravel (max.)	0.063 in (1.6 mm)	0.22 in (5.6 mm)	0.22 in (5.6 mm)	0.094 in (2.4 mm)	0.094 in (2.4 mm)	0.236 in (6 mm)	0.236 in (6 mm)
Movement differential (max.)	0.051 in (1.3 mm)	0.051 in (1.3 mm)	0.118 in (3 mm)	0.02 in (0.5 mm)	0.02 in (0.5 mm)	0.016 in (0.4 mm)	0.016 in (0.4 mm)
Free position (max.)	0.811 in (20.6 mm)	1.11 in (28.2 mm)	—	1.28 in (32.5 mm)	1.717 in (43.6 mm)	—	—
Operating position (max.)	0.685 in (17.4 mm)	0.748 in (19 mm)	0.748 in (19 mm)	1.189 in (30.2 mm)	1.697 in (43.1 mm)	—	—

Catalog Number	E47B...34-V	E47B...35-V	E47B...40-V	E47B...41-V	E47B...42-V	E47B...43-V
Operating force (max.)	20.11 oz (570 g)	22.58 oz (640 g)	17.64 oz (500 g)	5.29 oz (150 g)	5.64 oz (160 g)	21.16 oz (600 g)
Return force (min.)	6 oz (170 g)	8.11 oz (230 g)	6 oz (170 g)	—	0.78 oz (22 g)	10.58 oz (300 g)
Return force (max.)	—	—	—	0.49 oz (14 g)	—	—
Pre-travel (max.)	0.157 in (4 mm)	0.197 in (5 mm)	0.197 in (5 mm)	0.157 in (4 mm)	0.28 in (7.1 mm)	0.118 in (3 mm)
Overtravel (max.)	0.236 in (6 mm)	0.236 in (6 mm)	0.5 in (12.7 mm)	0.063 in (1.6 mm)	0.157 in (4 mm)	0.236 in (6 mm)
Movement differential (max.)	0.016 in (0.4 mm)	0.016 in (0.4 mm)	0.087 in (2.2 mm)	0.051 in (1.3 mm)	0.04 in (1.02 mm)	0.079 in (2 mm)
Free position (max.)	—	—	1.752 in (44.5 mm)	1.252 in (31.8 mm)	1.437 in (36.5 mm)	1.614 in (41 mm)
Operating position (max.)	—	—	1.591 in (40.4 mm)	1.126 in (28.6 mm)	1.189 in (30.2 mm)	1.591 in (40.4 mm)

E47 Precision Switch Specifications—20 A

Catalog Number	E47C...01-V	E47C...02-V	E47C...03-V	E47C...04-V	E47C...05-V	E47C...06-V	E47C...07-V
Operating force (max.)	22.93 oz (650 g)	22.93 oz (650 g)	22.93 oz (650 g)	22.93 oz (650 g)	8.82–12.3 oz (250–350 g)	28.22 oz (800 g)	8.82–12.3 oz (250–350 g)
Return force (min.)	7.05 oz (200 g)	7.05 oz (200 g)	7.05 oz (200 g)	7.05 oz (200 g)	4.02 oz (114 g)	8.47 oz (240 g)	4.02 oz (114 g)
Return force (max.)	—	—	—	—	—	—	—
Pre-travel (max.)	0.028 in (0.7 mm)	0.028 in (0.7 mm)	0.028 in (0.7 mm)	0.028 in (0.7 mm)	0.016 in (0.4 mm)	0.079 in (2 mm)	0.02 in (0.5 mm)
Overtravel (max.)	0.005 in (0.13 mm)	0.063 in (1.6 mm)	0.063 in (1.6 mm)	0.217 in (5.5 mm)	0.217 in (5.5 mm)	0.197 in (5 mm)	0.142 in (3.6 mm)
Movement differential (max.)	0.008 in (0.2 mm)	0.008 in (0.2 mm)	0.002 in (0.05 mm)	0.008 in (0.2 mm)	0.002 in (0.05 mm)	0.004 in (0.1 mm)	0.002 in (0.05 mm)
Free position (max.)	—	—	—	—	—	—	—
Operating position (max.)	0.642 in (16.3 mm)	0.866 in (22 mm)	1.13 in (28.7 mm)	0.89 in (22.6 mm)	1.504 in (38.2 mm)	1.803 in (45.8 mm)	1.957 in (49.7 mm)

Catalog Number	E47C...08-V	E47C...10-V	E47C...11-V	E47C...11-V Cross Roller Unit	E47C...12-V Cross Roller Unit	E47C...14-V	E47C...20-V
Operating force (max.)	17.64 oz (500 g)	22.93 oz (650 g)	22.93 oz (650 g)	8.82–12.3 oz (250–350 g)	17.64 oz (500 g)	2.12 oz (60 g)	5.64 oz (160 g)
Return force (min.)	3.53 oz (100 g)	7.05 oz (200 g)	7.05 oz (200 g)	4.02 oz (114 g)	3.53 oz (100 g)	0.88 oz (25 g)	1.48 oz (42 g)
Return force (max.)	—	—	—	—	—	—	—
Pre-travel (max.)	0.039 in (1 mm)	0.028 in (0.7 mm)	0.028 in (0.7 mm)	0.02 in (0.5 mm)	0.039 in (1 mm)	0.52 in (13.2 mm)	0.256 in (6.5 mm)
Overtravel (max.)	0.138 in (3.5 mm)	0.141 in (3.58 mm)	0.141 in (3.58 mm)	0.142 in (3.6 mm)	0.138 in (3.5 mm)	0.315 in (8 mm)	0.047 in (1.2 mm)
Movement differential (max.)	0.005 in (0.12 mm)	0.008 in (0.2 mm)	0.008 in (0.2 mm)	0.002 in (0.05 mm)	0.005 in (0.12 mm)	0.039 in (1 mm)	0.047 in (1.2 mm)
Free position (max.)	—	—	—	—	—	—	—
Operating position (max.)	1.957 in (49.7 mm)	1.362 in (34.6 mm)	1.362 in (34.6 mm)	1.957 in (49.7 mm)	1.957 in (49.7 mm)	—	0.78 in (19.8 mm)

Catalog Number	E47C...21-V	E47C...22-V	E47C...23-V	E47C...30-V	E47C...31-V	E47C...32-V	E47C...33-V
Operating force (max.)	12.35 oz (350 g)	2.82 oz (80 g)	0.35 oz (10 g)	6.35 oz (180 g)	5.64 oz (160 g)	20.11 oz (570 g)	22.58 oz (640 g)
Return force (min.)	1.76 oz (50 g)	0.49 oz (14 g)	0.11 oz (3 g)	1.48 oz (42 g)	1.48 oz (42 g)	6 oz (170 g)	8.11 oz (230 g)
Return force (max.)	—	—	—	—	—	—	—
Pre-travel (max.)	0.157 in (4 mm)	0.394 in (10 mm)	0.787 in (20 mm)	0.106 in (2.7 mm)	0.106 in (2.7 mm)	0.157 in (4 mm)	0.197 in (5 mm)
Overtravel (max.)	0.063 in (1.6 mm)	0.22 in (5.6 mm)	0.22 in (5.6 mm)	0.094 in (2.4 mm)	0.094 in (2.4 mm)	0.236 in (6 mm)	0.236 in (6 mm)
Movement differential (max.)	0.051 in (1.3 mm)	0.05 in (1.27 mm)	0.118 in (3 mm)	0.02 in (0.5 mm)	0.02 in (0.5 mm)	0.016 in (0.4 mm)	0.016 in (0.4 mm)
Free position (max.)	0.811 in (20.6 mm)	1.11 in (28.2 mm)	—	1.28 in (32.5 mm)	1.717 in (43.6 mm)	—	—
Operating position (max.)	0.717 in (18.2 mm)	0.78 in (19.8 mm)	0.748 in (19 mm)	1.205 in (30.6 mm)	1.697 in (43.1 mm)	—	—

Catalog Number	E47C...34-V	E47C...35-V	E47C...40-V	E47C...41-V	E47C...42-V	E47C...43-V
Operating force (max.)	20.11 oz (570 g)	22.58 oz (640 g)	17.64 oz (500 g)	12.35 oz (350 g)	4.23 oz (120 g)	21.16 oz (600 g)
Return force (min.)	6 oz (170 g)	8.11 oz (230 g)	6 oz (170 g)	1.76 oz (50 g)	0.78 oz (22 g)	10.58 oz (300 g)
Return force (max.)	—	—	—	—	—	—
Pre-travel (max.)	0.157 in (4 mm)	0.197 in (5 mm)	0.197 in (5 mm)	0.157 in (4 mm)	0.28 in (7.1 mm)	0.118 in (3 mm)
Overtravel (max.)	0.236 in (6 mm)	0.236 in (6 mm)	0.5 in (12.7 mm)	0.063 in (1.6 mm)	0.157 in (4 mm)	0.236 in (6 mm)
Movement differential (max.)	0.016 in (0.4 mm)	0.016 in (0.4 mm)	0.087 in (2.2 mm)	0.051 in (1.3 mm)	0.04 in (1.02 mm)	0.079 in (2 mm)
Free position (max.)	—	—	1.752 in (44.5 mm)	1.252 in (31.8 mm)	1.437 in (36.5 mm)	1.614 in (41 mm)
Operating position (max.)	—	—	1.591 in (40.4 mm)	1.157 in (29.4 mm)	1.575 in (40 mm)	1.591 in (40.4 mm)

Dimensions

Approximate Dimensions in Inches [mm]

Basic Switches

Pin Plunger

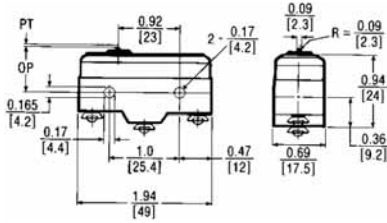

Standard Lever

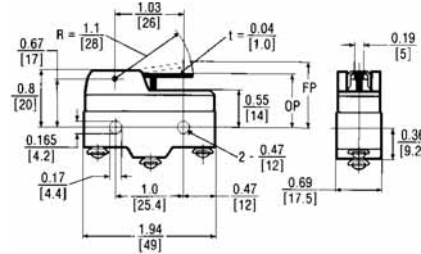

Extended Plunger

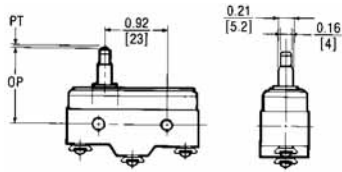

Extended Straight Plunger

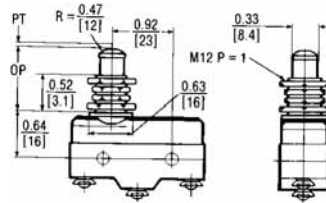

Straight Plunger

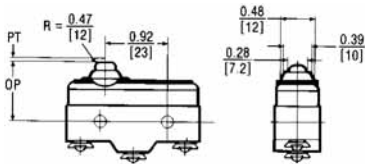

Roller Plunger

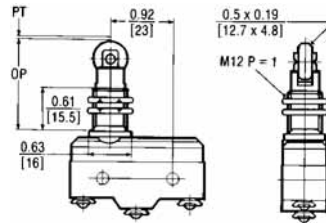

Reversed Lever

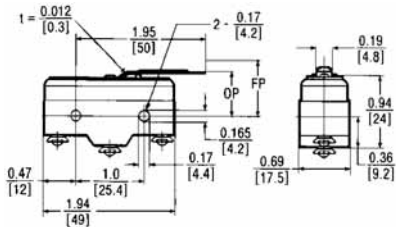

Cross Roller Plunger

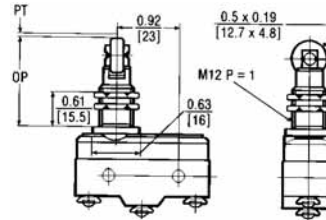

Straight Lever

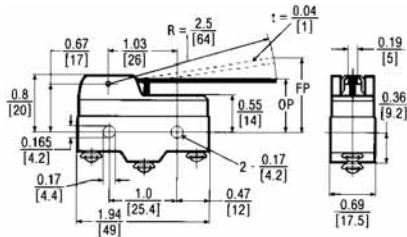

Reversed Roller Lever

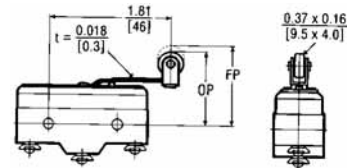

2.1

Limit Switches

E47 Precision Switches

Approximate Dimensions in Inches [mm]

2

Extended Roller Lever

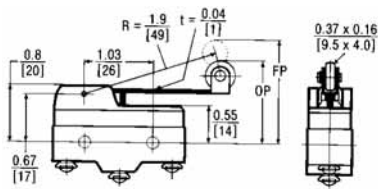

Integral Leaf

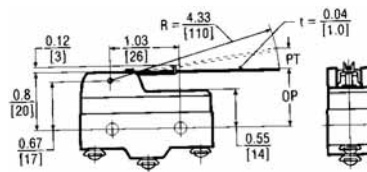

Roller Lever

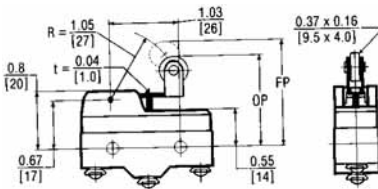

Adjustable Roller

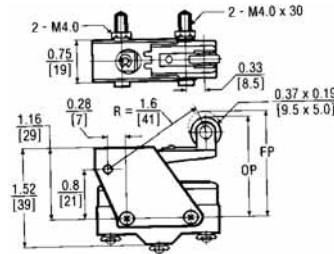

One-Way Roller

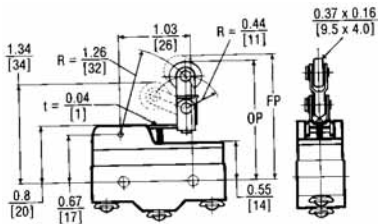

Extended Adjustable Roller

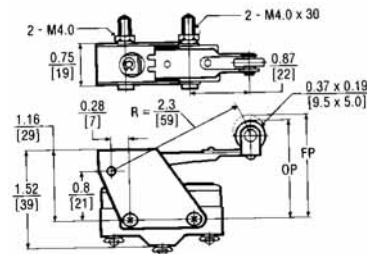

Enclosed Switches

Plunger Actuator

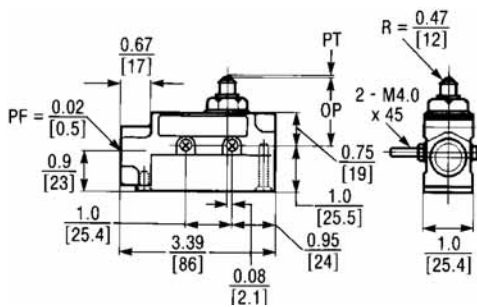

Roller Lever

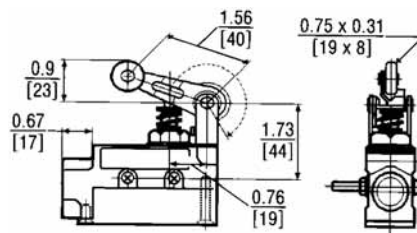

Booted Plunger

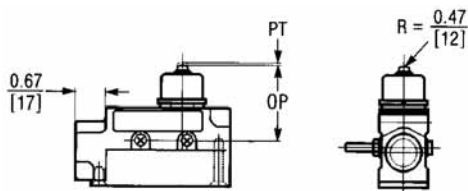

Booted Roller Lever

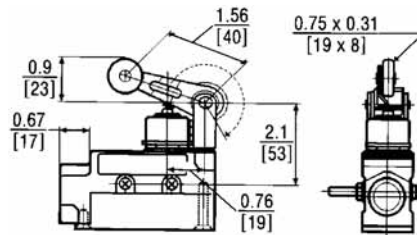

Approximate Dimensions in Inches [mm]

Roller Plunger

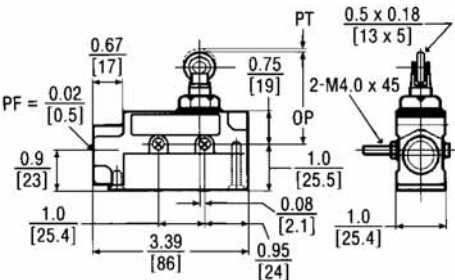

Booted One-Way Roller

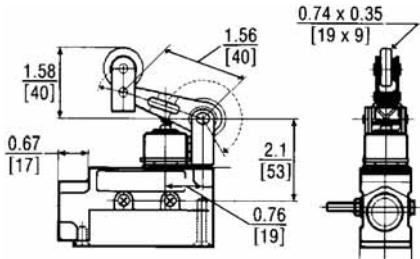

Booted Roller Plunger

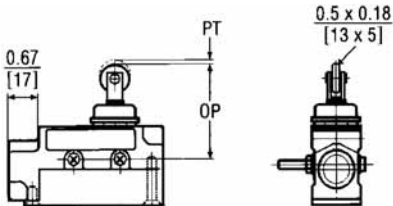

Booted Wobble

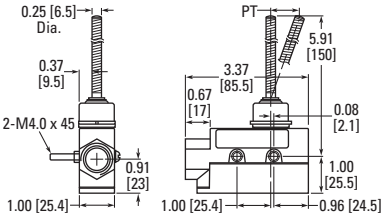

One-Way Roller

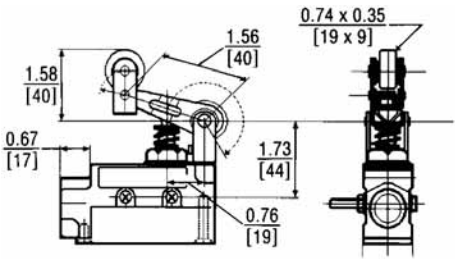

Accessories

Approximate Dimensions in mm

Terminal Wire Cover with 45° Conduit Interface

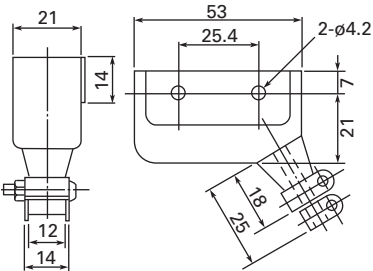

Terminal Wire Cover with 90° Conduit Interface

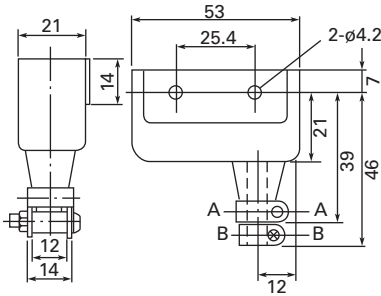

Compact Prewired Switches

2



Contents

Description

	<i>Page</i>
Compact Prewired Switches	
Product Selection	V8-T2-17
Technical Data and Specifications	V8-T2-18
Wiring Diagram	V8-T2-19
Dimensions	V8-T2-19

 Drawings
Online

Compact Prewired Switches

Product Description

The E47 Compact Prewired Limit Switch by Eaton's electrical sector is designed to be a versatile, slim device for hard to fit applications where sealing integrity is required. The rugged die cast aluminum alloy housing, cable connection and switch mechanism are encapsulated for protection against contaminants, moisture, shock and vibration. This factory wired (3m) device has NEMA® enclosure ratings of 4, 6 and 13, making it suitable for applications such as machine tool, food processing and packaging.

Features

- Rugged aluminum alloy die cast housing
- Sealed construction with enclosure ratings of NEMA 4, 6 and 13
- Prewired with 3m of 18 AWG, AWM 2517, 300V cable, or micro-connector version also available
- Stackable ridge for ganged operation

Standards and Certifications

- UL Listed, E170645 (cable versions only)
- UL tested to Canadian safety standards
- CE
- RoHS Compliant



DANGER

THIS SENSOR IS NOT A SAFETY DEVICE AND IS NOT INTENDED TO BE USED AS A SAFETY DEVICE. This sensor is designed only to detect and read certain data in an electronic manner and perform no use apart from that, specifically no safety-related use. This sensor product does not include self-checking redundant circuitry, and the failure of this sensor product could cause either an energized or de-energized output condition, which could result in death, serious bodily injury, or property damage.

For the most current information on this product, visit our Web site: www.eaton.com





For Customer Service in the U.S. call 1-877-ETN CARE (386-2273), in Canada call 1-800-268-3578. For Application Assistance in the U.S. and Canada call 1-800-426-9184.

Product Selection

Compact Prewired Switches

Actuator Type	Operating Force (Maximum)	Reset Force (Minimum)	Over-Travel (Maximum)	Pre-Travel	Movement Differential (Maximum)	Operating Position	Standard Version Catalog Number	Connector Version Catalog Number
Pin Plunger 	Pin Plunger							
	42.3 oz (1.2 kg)	15.9 oz (450g)	0.118 in (3 mm)	0.07 in (1.8 mm)	0.008 in (0.2 mm)	0.62 ± 0.04 in (15.7 ± 1 mm)	E47BCC05	E47BCC05P4
Sealed Plunger 	Sealed Plunger							
	63.5 oz (1.8 kg)	15.9 oz (450g)	0.118 in (3 mm)	0.07 in (1.8 mm)	0.008 in (0.2 mm)	0.99 ± 0.04 in (24.9 ± 1 mm)	E47BCC06	E47BCC06P4
Roller Plunger 	Roller Plunger							
	42.3 oz (1.2 kg)	15.9 oz (450g)	0.118 in (3 mm)	0.07 in (1.8 mm)	0.008 in (0.2 mm)	1.12 ± 0.04 in (28.5 ± 1 mm)	E47BCC07	E47BCC07P4
Sealed Roller Plunger 	Sealed Roller Plunger							
	63.5 oz (1.8 kg)	15.9 oz (450g)	0.118 in (3 mm)	0.07 in (1.8 mm)	0.008 in (0.2 mm)	1.35 ± 0.04 in (34.3 ± 1 mm)	E47BCC08	E47BCC08P4
Cross Roller Plunger 	Cross Roller Plunger							
	42.3 oz (1.2 kg)	15.9 oz (450g)	0.118 in (3 mm)	0.07 in (1.8 mm)	0.008 in (0.2 mm)	1.12 ± 0.04 in (28.5 ± 1 mm)	E47BCC11	E47BCC11P4
Sealed Cross Roller Plunger 	Sealed Cross Roller Plunger							
	63.5 oz (1.8 kg)	15.9 oz (450g)	0.118 in (3 mm)	0.07 in (1.8 mm)	0.008 in (0.2 mm)	1.35 ± 0.04 in (34.3 ± 1 mm)	E47BCC12	E47BCC12P4
Bevel Plunger 	Bevel Plunger							
	42.3 oz (1.2 kg)	15.9 oz (450g)	0.118 in (3 mm)	0.07 in (1.8 mm)	0.008 in (0.2 mm)	1.12 ± 0.04 in (28.5 ± 1 mm)	E47BCC13	E47BCC13P4

Compact Prewired Switches, continued

Actuator Type	Operating Force (Maximum)	Reset Force (Minimum)	Over-Travel (Maximum)	Pre-Travel	Movement Differential (Maximum)	Operating Position	Standard Version Catalog Number	Connector Version Catalog Number
Roller Lever	Roller Lever							
	20.5 oz (580g)	5.3 oz (150g)	40°	25° max.	3°	—	E47BCC15	E47BCC15P4
Wobble Stick	Wobble Stick							
	5.3 oz (150g)	—	—	15° max.	—	—	E47BCC20	E47BCC20P4
Rod Lever	Rod Lever							
	20.5 oz (580g)	5.3 oz (150g)	40°	25° max.	3°	—	—	E47BCC21P4
Adjustable Level Arm	Adjustable Level Arm							
	20.5 oz (580g)	5.3 oz (150g)	40°	25° max.	3°	—	E47BCC22	E47BCC22P4

Technical Data and Specifications

Compact Prewired Switches

Description	Specification
Contacts	1-SPDT (Form C)
Mechanical life	10,000,000 operations
Electrical life	200,000 operations, 30 operation/min. at rated load
Operating speed	30 operations per minute maximum
Operating temperature range	-10° to 70°C (14° to 158°F)
Storage temperature range	-10° to 70°C (14° to 158°F)
Humidity	95% maximum non-condensing
Vibration	Malfunction durability, 10 to 55 Hz 1.5 mm double amplitude
Shock	Malfunction durability, approximately 50G
Enclosure ratings	NEMA 4, 6 and 13; IEC IP69K

Maximum Ampere Ratings ①

Rated Voltage	Non-Inductive Load (A)		Inductive Load (A)		Motor Load		Inrush Current (A)	
	NC	NO	NC	NO	NC	NO	NC	NO
125 Vac	5	5	3	3	2.5	1.3	20 max.	10 max.
250 Vac	5	5	2	2	1.5	0.8		
8 Vdc	5	5	5	4	1.5	1.5		
14 Vdc	5	5	4	4	1.5	1.5		
30 Vdc	4	4	3	3	1.5	1.5		
125 Vdc	0.4	0.4	0.4	0.4	0.05	0.05		
250 Vdc	0.2	0.2	0.2	0.2	0.03	0.03		

Wiring Diagram

Compact Prewired Switches

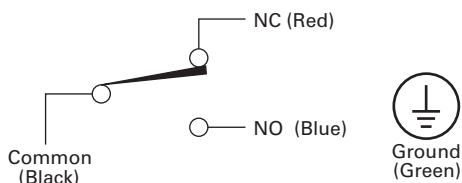

Micro-Connector Switches

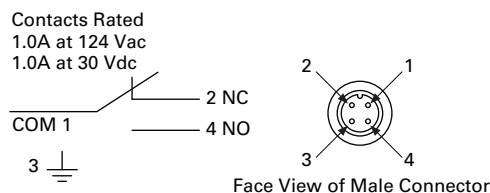

Note

① Inductive load ratings are tested at a power factor 0.4 min. for AC power and a time constant of 7 ms max. for DC power. Inrush current for motor load is six times the steady state current.

Dimensions

Approximate Dimensions in mm [in]

E47BCC05

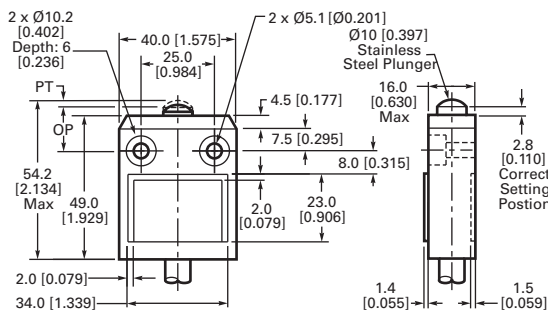

E47BCC07

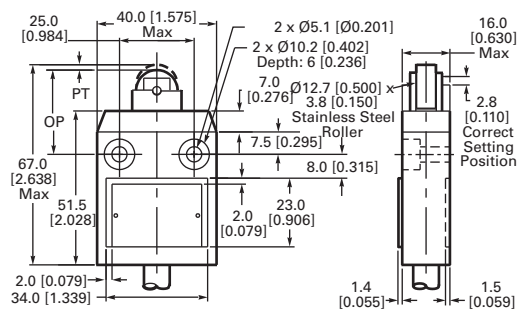

E47BCC06

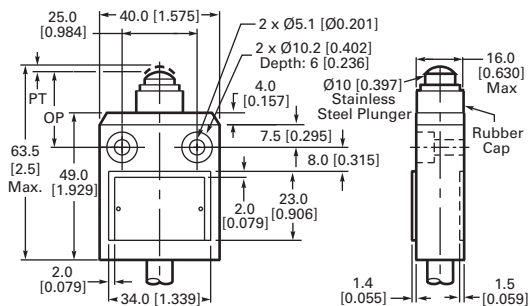

E47BCC08

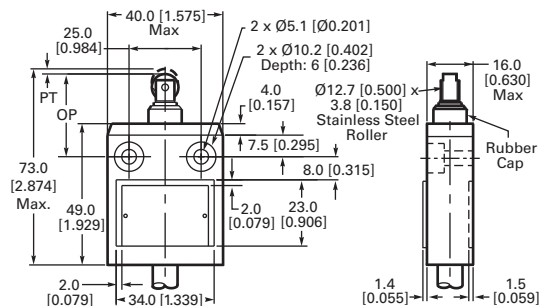

2.2

Limit Switches

Compact Prewired Switches

2

E47BCC11

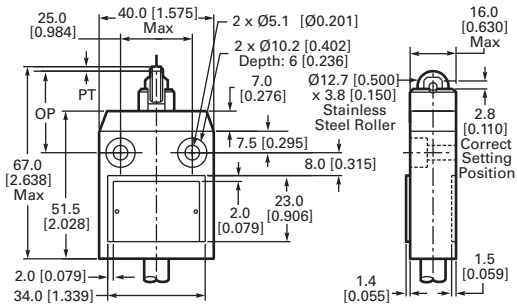

E47BCC20

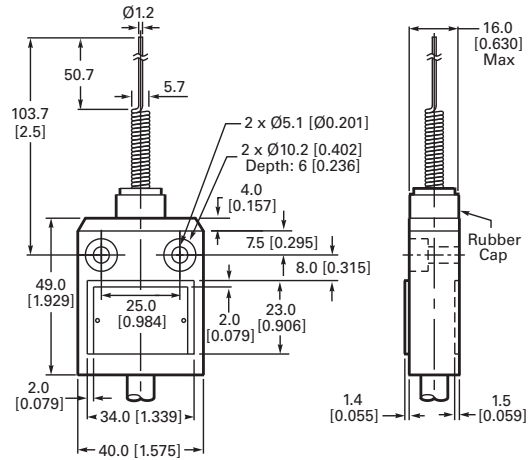

E47BCC12

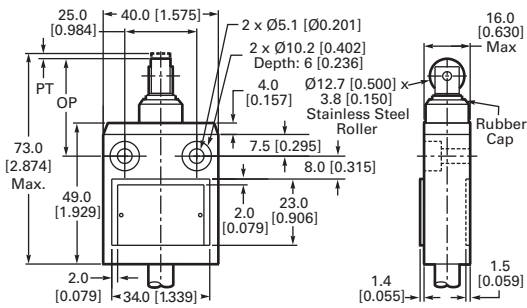

E47BCC21

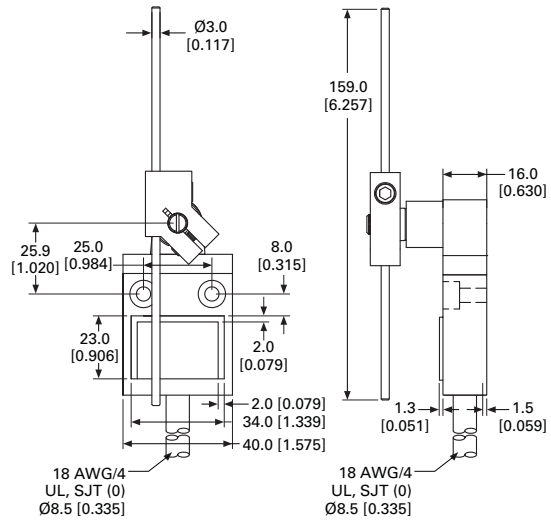

E47BCC13

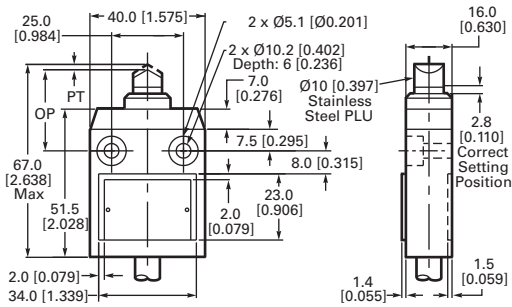

E47BCC22

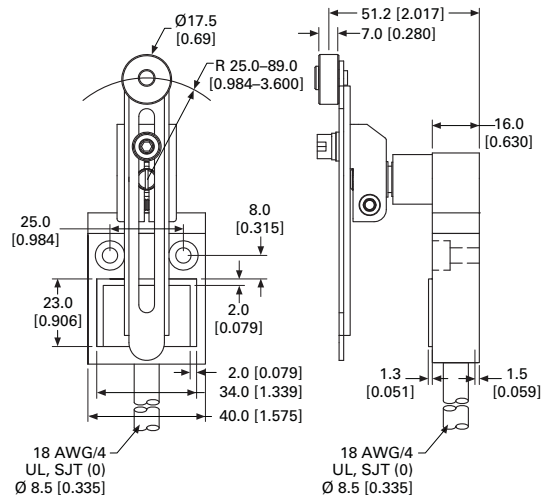

E47BCC15

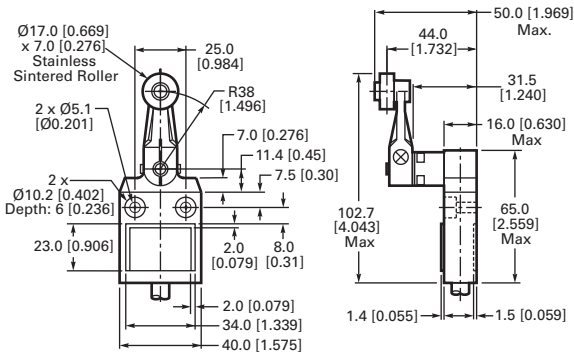

LS-Titan Miniature DIN Switches



Contents

Description	Page
LS-Titan Miniature DIN Switches	
Product Identification	V8-T2-22
Product Selection	V8-T2-23
LS-Titan Plastic Safety Switches	V8-T2-23
LS-Titan Plastic Electronic Safety Position Switches	V8-T2-26
LS-Titan Metal Safety Switches	V8-T2-30
Understanding LS-Titan Electronic Safety Position Switches	V8-T2-32
Operating Point Adjustment	V8-T2-32
Accessories	V8-T2-33
Technical Data and Specifications	V8-T2-34
Contact Travel Diagrams	V8-T2-37
Dimensions	V8-T2-40

LS-Titan Miniature DIN Switches

Product Description

Eaton's LS-Titan™ limit switch line is a complete offering of safety position switches designed for worldwide application. Economical insulated plastic or rugged metal enclosures and modular, plug-in operating heads and bodies make LS-Titan a flexible switching solution.

A highlight of the LS-Titan switch line is the world's first electronic position switch (LSE models). These switches feature freely programmable operating points that can be set individually at any time. Additional LSE models provide analog outputs proportional to the actuator position.

LS-Titan switches are suitable for use in safety applications designed to protect persons or processes.

Features

- Modular, plug-in system (head and body components)
- Positive opening NC contacts for safety applications
- Wide variety of economical plastic and rugged metal versions available
- Operating heads can be rotated 90 degrees to suit specific direction of operation
- Unique electronic safety position switches (LSE models) provide 0–10 Vdc outputs proportional to the actuator position and allow for easy configuration of a custom trip point
- Can be ordered as separate components (head and body) or as completely assembled switches
- Screw and Cage Clamp® (standard on LSE models and optionally available on mechanical models) connections provide larger wiring areas for easier installation
- Approved for worldwide application

Standards and Certifications

- Safety function by positive opening contacts per IEC/EN 60947-5-1
- TÜV-Rheinland Certified for Functional-Safety (LSE models)
- UL Listed, E29184
- CSA Certified, 12528
- RoHS Compliant
- CE
- CCC



Note: Cage Clamp is a registered trademark of Wago Kontakttechnik, 32423 Minden, Germany.

For the most current information on this product, visit our Web site: www.eaton.com

For Customer Service in the U.S. call 1-877-ETN CARE (386-2273), in Canada call 1-800-268-3578. For Application Assistance in the U.S. and Canada call 1-800-426-9184.

Product Identification

2

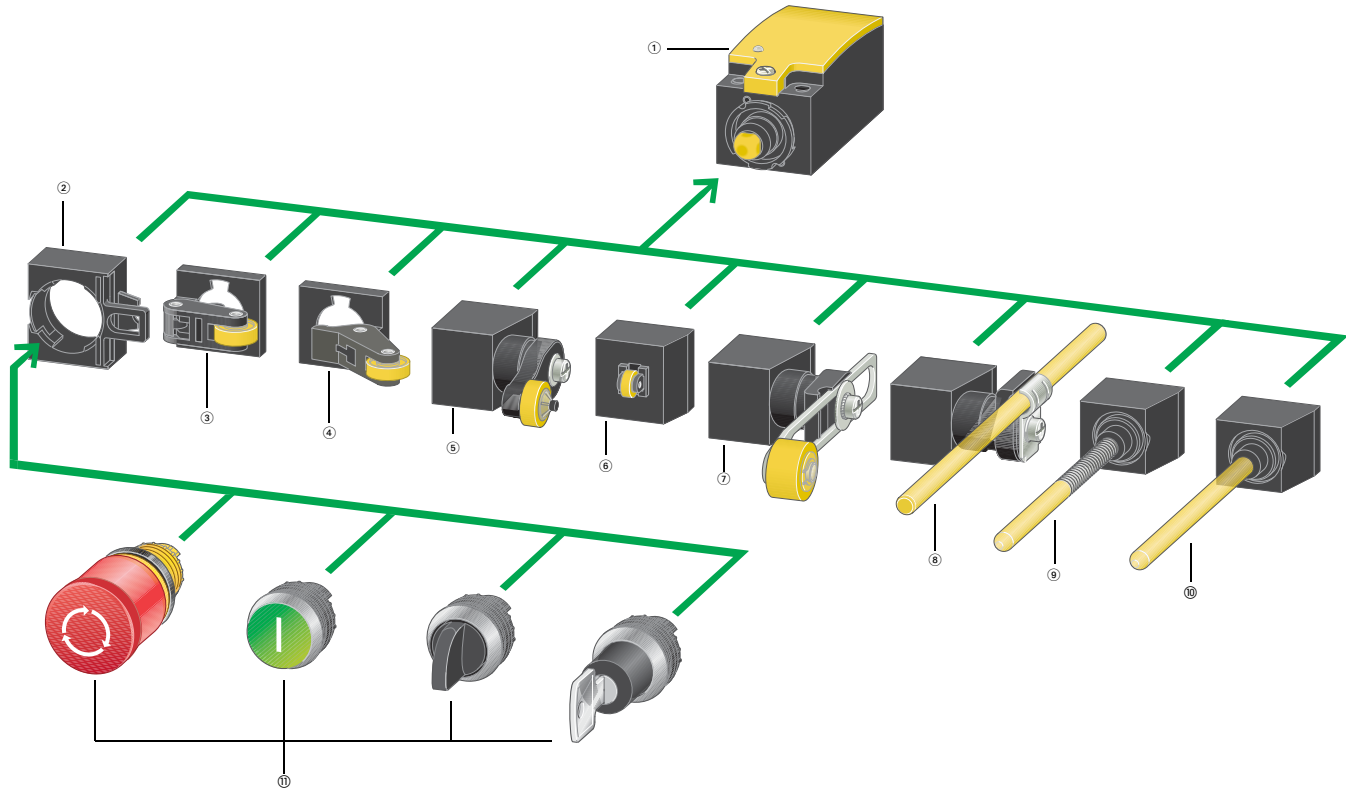

Notes

- ① **Basic device** (see Pages V8-T2-23 to V8-T2-31)
According to EN 50047
With screw-on cover
Contacts: 1NO-1NC, 2NO, 2NC
Cage Clamp, screw terminal
As snap-action or standard-action switch
As electronic snap-action switch (individually adjustable)
As 0–10 Vdc analog signal encoder
- ② **Fixing adapter** (see Page V8-T2-33)
Allows mounting of M22 pushbuttons
- ③ **Roller lever** (see Pages V8-T2-23 and V8-T2-26)
For one-sided operation with higher operating speed
- ④ **Angled roller lever** (see Pages V8-T2-23, V8-T2-26 and V8-T2-30)
For actuation along the unit axis
- ⑤ **Rotary lever** (see Pages V8-T2-23, V8-T2-27 and V8-T2-30)
For actuation from the side, for pendulum movements
- ⑥ **Roller plunger** (see Pages V8-T2-23, V8-T2-26 and V8-T2-30)
For actuation from the side with low actuating force
- ⑦ **Adjustable roller lever** (see Pages V8-T2-24, V8-T2-27, V8-T2-28 and V8-T2-30)
For length adjustment as required
- ⑧ **Actuating rod** (see Pages V8-T2-25, V8-T2-29 and V8-T2-31)
On conveyor belts for lightweight goods
- ⑨ **Spring-rod** (see Pages V8-T2-25, V8-T2-29 and V8-T2-31)
For flexible actuation from all sides
- ⑩ **Actuating rod** (see Pages V8-T2-25, V8-T2-29 and V8-T2-31)
Withdrawable mechanism from front
- ⑪ Pushbuttons from the M22 family; see M22 catalog (CA04716001E) or www.eaton.com/m22

Operating heads can be rotated by 90 degrees.

Product Selection

LS-Titan Plastic Safety Switches

		Plastic Safety Switches			
		Switch Body Catalog Number	LS-S02	LS-S20A	LS-S11S
		Output Function	2NC with positive opening contacts	2NO with slow make/break	1NO and 1NC with positive opening contact
		Terminal Connection	Screw terminal ①	Screw terminal ①	Screw terminal ①
		Contact Sequence			
		Contact Travel			
		Operating Head Type ②	Head Only Catalog Number	Assembled Switch Catalog Number	
Plastic Safety Switch Body	Assembled Switch				
Top Push Roller Plunger		LS-XP	LS-S02-P	LS-S20A-P	LS-S11S-P
Long Roller Lever		LS-XL	LS-S02-L	LS-S20A-L	LS-S11S-L
Short Roller Lever		LS-XLS	LS-S02-LS	LS-S20A-LS	LS-S11S-LS
Large Roller Lever		LS-XLB	LS-S02-LB	LS-S20A-LB	LS-S11S-LB
Angled Roller		LS-XLA	LS-S02-LA	LS-S20A-LA	LS-S11S-LA
Rotary Lever		LS-XRL	LS-S02-RL	LS-S20A-RL	LS-S11S-RL

Notes

- ① Cage Clamp versions available. Contact Application Engineering.
- ② For operating head dimensions, see **Page V8-T2-40**.

2.3

Limit Switches

LS-Titan Miniature DIN Switches

2

Plastic Safety Switch Body



Assembled Switch



Plastic Safety Switches, continued

Switch Body Catalog Number

Output Function

Terminal Connection

Contact Sequence

Contact Travel

- = contact closed
- = contact open

Operating Head Type ②

Head Only Catalog Number

LS-S02

2NC with positive opening contacts

Screw terminal ①

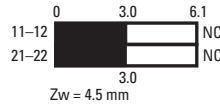

LS-S20A

2NO with slow make/break

Screw terminal ①

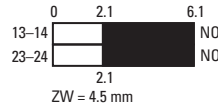

LS-S11S

1NO and 1NC with positive opening contact

Screw terminal ①



Snap-action contact

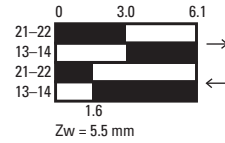

Assembled Switch Catalog Number

Adjustable Roller Lever (with 18 mm Roller)



LS-XRLA

LS-S02-RLA

LS-S20A-RLA

LS-S11S-RLA

Adjustable Roller Lever (with 30 mm Roller)



LS-XRLA30

LS-S02-RLA30

LS-S20A-RLA30

LS-S11S-RLA30

Adjustable Roller Lever (with 40 mm Roller)



LS-XRLA40

LS-S02-RLA40

LS-S20A-RLA40

LS-S11S-RLA40

Adjustable Roller Lever (with 40 mm Rubber Roller)



LS-XRLA40R

LS-S02-RLA40R

LS-S20A-RLA40R

LS-S11S-RLA40R

Notes

- ① Cage Clamp versions available. Contact Application Engineering.
- ② For operating head dimensions, see **Page V8-T2-40**.

Plastic Safety Switches, continued

Plastic Safety Switch Body



Assembled Switch



Switch Body Catalog Number

Output Function

Terminal Connection

Contact Sequence

Contact Travel

■ = contact closed

□ = contact open

Operating Head Type ②

Head Only Catalog Number

LS-S02

2NC with positive opening contacts

Screw terminal ①

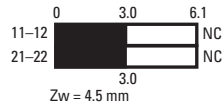

LS-S20A

2NO with slow make/break

Screw terminal ①

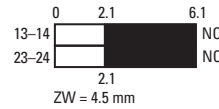

LS-S11S

1NO and 1NC with positive opening contact

Screw terminal ①

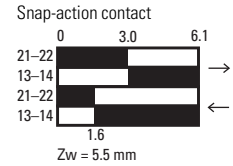

Plastic Rod Lever



LS-XRR

LS-S02-RR

LS-S20A-RR

LS-S11S-RR

Metal Rod



LS-XRRM

LS-S02-RRM

LS-S20A-RRM

LS-S11S-RRM

Spring Rod (Wobble) ③



LS-XS

LS-S02-S

LS-S20A-S

LS-S11S-S

Actuating Rod



LS-XOR

LS-S02-OR

LS-S20A-OR

LS-S11S-OR

Notes

① Cage Clamp versions available. Contact Application Engineering.

② For operating head dimensions, see **Page V8-T2-40**.

③ Not to be used as a safety position switch. Use only in conjunction with snap-action contact.

2.3

Limit Switches

LS-Titan Miniature DIN Switches

LS-Titan Plastic Electronic Safety Position Switches

2

Plastic Electronic Safety Position Switch Body



Assembled Switch



Plastic Electronic Safety Position Switches

Switch Body

Catalog Number

LSE-11

LSE-02

LSE-AU

Output Function

1NO and 1 NC

2NC

Analog 0–10V

Terminal Connections

Cage Clamp ①

Cage Clamp ①

Cage Clamp ①

Safety Functions and Approvals

These models may be used in safety-oriented circuits. Visual status LED indication is comparable to positive opening contacts. Certified by TÜV as a “Functional-Safety” device. Suitable for protection of people or processes.

Additional diagnostic output that registers a 0V signal in the event of a fault. Self-test function continuously tests both outputs for overloads, short circuits to 0V and short circuits to +U_β. Certified by TÜV to EN 954-1, Category 3 or 4. Suitable for protection of people or processes.



Contact Sequence

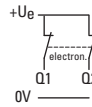
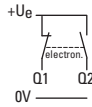

Analog 0–10V

Contact Travel

■ = contact closed

□ = contact open

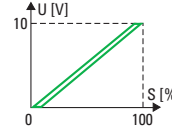
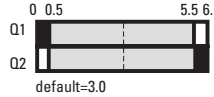
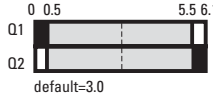

Operating Head Type ②

Head Only

Catalog Number

Assembled Switch

Catalog Number

Top Push Roller Plunger



LS-XP

LSE-11-P

LSE-02-P

LSE-AU-P

Long Roller Lever



LS-XL

LSE-11-L

LSE-02-L

LSE-AU-L

Short Roller Lever



LS-XLS

LSE-11-LS

LSE-02-LS

LSE-AU-LS

Large Roller Lever



LS-XLB

LSE-11-LB

LSE-02-LB

LSE-AU-LB

Angled Roller



LS-XLA

LSE-11-LA

LSE-02-LA

LSE-AU-LA

Notes

① A compatible Cage Clamp tool is available as an accessory on [Page V8-T2-33](#).

② For operating head dimensions, see [Page V8-T2-40](#).

Plastic Electronic Safety Position Switches, continued

Plastic Electronic Safety Position Switch Body



Switch Body Catalog Number	LSE-11	LSE-02	LSE-AU
Output Function	1NO and 1NC	2NC	Analog 0–10V
Terminal Connections	Cage Clamp ①	Cage Clamp ①	Cage Clamp ①
Safety Functions and Approvals	These models may be used in safety-oriented circuits. Visual status LED indication is comparable to positive opening contacts. Certified by TÜV as a “Functional-Safety” device. Suitable for protection of people or processes.		Additional diagnostic output that registers a 0V signal in the event of a fault. Self-test function continuously tests both outputs for overloads, short circuits to 0V and short circuits to +U _e . Certified by TÜV to EN 954-1, Category 3 or 4. Suitable for protection of people or processes.



Assembled Switch



Contact Sequence

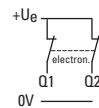
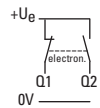

Analog 0–10V

Contact Travel

■ = contact closed
□ = contact open

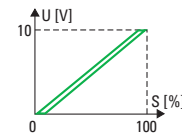
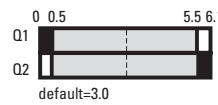
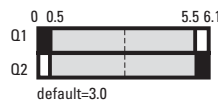

Operating Head Type ②

Head Only Catalog Number	Assembled Switch Catalog Number
--------------------------	---------------------------------

Rotary Lever



LS-XRL	LSE-11-RL	LSE-02-RL	LSE-AU-RL
--------	-----------	-----------	-----------

Adjustable Roller Lever (with 18 mm Roller)



LS-XRLA	LSE-11-RLA	LSE-02-RLA	LSE-AU-RLA
---------	------------	------------	------------

Adjustable Roller Lever (With 30 mm Roller)



LS-XRLA30	LSE-11-RLA30	LSE-02-RLA30	LSE-AU-RLA30
-----------	--------------	--------------	--------------

Notes

- ① A compatible Cage Clamp tool is available as an accessory on Page V8-T2-33.
- ② For operating head dimensions, see Page V8-T2-40.

Plastic Electronic Safety Position Switch Body



Assembled Switch



Plastic Electronic Safety Position Switches, continued

Switch Body

Catalog Number

LSE-11

LSE-02

LSE-AU

Output Function

1NO and 1NC

2NC

Analog 0–10V

Terminal Connections

Cage Clamp ①

Cage Clamp ①

Cage Clamp ①

Safety Functions and Approvals

These models may be used in safety-oriented circuits. Visual status LED indication is comparable to positive opening contacts. Certified by TÜV as a “Functional-Safety” device. Suitable for protection of people or processes.

Additional diagnostic output that registers a 0V signal in the event of a fault. Self-test function continuously tests both outputs for overloads, short circuits to 0V and short circuits to +U_e. Certified by TÜV to EN 954-1, Category 3 or 4. Suitable for protection of people or processes.



Contact Sequence

+U_e

+U_e

Analog 0–10V



Contact Travel

■ = contact closed

□ = contact open

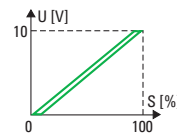
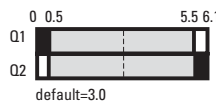
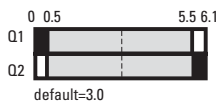

Operating Head Type ②

Head Only

Catalog Number

Assembled Switch

Catalog Number

Adjustable Roller Lever (With 40 mm Roller)



LS-XRLA40

LSE-11-RLA40

LSE-02-RLA40

LSE-AU-RLA40

Adjustable Roller Lever (With 40 mm Roller)



LS-XRLA40R

LSE-11-RLA40R

LSE-02-RLA40R

LSE-AU-RLA40R

Plastic Rod Lever



LS-XRR

LSE-11-RR

LSE-02-RR

LSE-AU-RR

Notes

① A compatible Cage Clamp tool is available as an accessory on **Page V8-T2-33**.

② For operating head dimensions, see **Page V8-T2-40**.

Plastic Electronic Safety Position Switches, continued

Plastic Electronic Safety Position Switch Body



Assembled Switch



Switch Body Catalog Number	LSE-11	LSE-02	LSE-AU
Output Function	1NO and 1NC	2NC	Analog 0–10V
Terminal Connections	Cage Clamp ①	Cage Clamp ①	Cage Clamp ①
Safety Functions and Approvals	These models may be used in safety-oriented circuits. Visual status LED indication is comparable to positive opening contacts. Certified by TÜV as a “Functional-Safety” device. Suitable for protection of people or processes.		Additional diagnostic output that registers a 0V signal in the event of a fault. Self-test function continuously tests both outputs for overloads, short circuits to 0V and short circuits to +U _e . Certified by TÜV to EN 954-1, Category 3 or 4. Suitable for protection of people or processes.



Contact Sequence

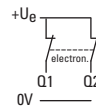
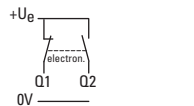

Analog 0–10V

Contact Travel
 ■ = contact closed
 □ = contact open

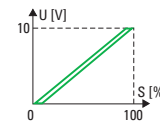
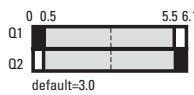
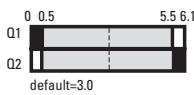

Operating Head Type ②

Head Only Catalog Number	Assembled Switch Catalog Number
--------------------------	---------------------------------

Metal Rod



LS-XRRM	LSE-11-RRM	LSE-02-RRM	LSE-AU-RRM
---------	------------	------------	------------

Spring Rod (Wobble) ③



LS-XS	LSE-11-S	LSE-02-S	LSE-AU-S
-------	----------	----------	----------

Actuating Rod



LS-XOR	LSE-11-OR	LSE-02-OR	LSE-AU-OR
--------	-----------	-----------	-----------

Notes

- ① A compatible Cage Clamp tool is available as an accessory on **Page V8-T2-33**.
- ② For operating head dimensions, see **Page V8-T2-40**.
- ③ Not to be used as a safety position switch. Use only in conjunction with snap-action contact.

2.3

Limit Switches

LS-Titan Miniature DIN Switches

LS-Titan Metal Safety Switches

2

Metal Safety Switch Body



Assembled Switch



Metal Safety Switches

Switch Body Catalog Number

Output Function

Terminal Connection

Contact Sequence

Contact Travel

■ = contact closed

□ = contact open

Operating Head Type ①

Head Only Catalog Number

LSM-02

2NC with positive opening contacts

Cage Clamp

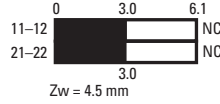

LSM-20A

2NO with slow make/break

Cage Clamp

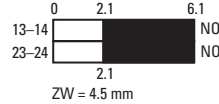

LSM-11S

1NO and 1NC with positive opening contact

Cage Clamp



Snap-action contact

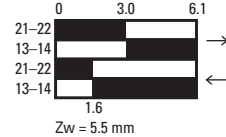

Top Push Roller Plunger



LSM-XP

LSM-02-P

LSM-20A-P

LSM-11S-P

Long Roller Lever



LSM-XL

LSM-02-L

LSM-20A-L

LSM-11S-L

Angled Roller



LSM-XLA

LSM-02-LA

LSM-20A-LA

LSM-11S-LA

Rotary Lever



LSM-XRL

LSM-02-RL

LSM-20A-RL

LSM-11S-RL

Adjustable Roller Lever



LSM-XRLA

LSM-02-RLA

LSM-20A-RLA

LSM-11S-RLA

Note

① For operating head dimensions, see **Page V8-T2-40**.

Metal Safety Switches, continued

Metal Safety Switch Body



Assembled Switch



Switch Body Catalog Number

Output Function

Terminal Connection

Contact Sequence

Contact Travel

■ = contact closed

□ = contact open

Operating Head Type ①

Head Only

Catalog Number

LSM-02

2NC with positive opening contacts

Cage Clamp

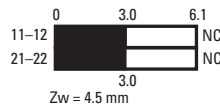

LSM-20A

2NO with slow make/break

Cage Clamp

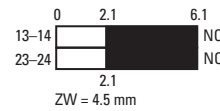

LSM-11S

1NO and 1NC with positive opening contact

Cage Clamp

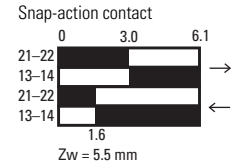

Assembled Switch Catalog Number

Plastic Rod Lever



LSM-XRR

LSM-02-RR

LSM-20A-RR

LSM-11S-RR

Metal Rod Lever



LSM-XRRM

LSM-02-RRM

LSM-20A-RRM

LSM-11S-RRM

Spring Rod (Wobble)



LSM-XS

LSM-02-S

LSM-20A-S

LSM-11S-S

Note

① For operating head dimensions, see **Page V8-T2-40**.

2.3

Limit Switches

LS-Titan Miniature DIN Switches

2

Understanding LS-Titan Electronic Safety Position Switches

All three LS-Titan LSE switch bodies are safety-rated products. The LSE-11 and LSE-02 switch bodies both have a freely programmable operating point and can be individually adjusted to suit the application, and can be changed as often as required. These devices feature an LED on the body, providing simple indication during programming and operation.

The LSE-AU (0–10 V) analog position switch takes position data and converts to an analog current or voltage value that can then be continuously fed into an automation system. The LSE-AU also features a diagnostic output for additional data processing.

This ensures that a safe operating state can be monitored and evaluated at any time. A self-test function is also present on these models. Outputs Q1 and Q2 are continuously tested for overloads, short circuits to 0V and short circuits to +U_e.

Like the electromechanical position switches, LS-Titan electronic position switches meet Category 3 or 4 of the EN 954-1 standard for machine safety when configured as a redundant system. All devices are thus suitable for safety applications that are used for the protection of persons or processes.

Operating Point Adjustment

LSE-11

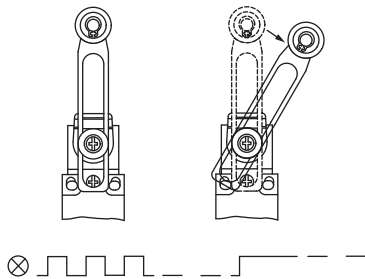

LSE-02

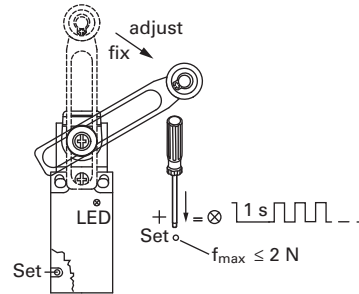

Example of LS-Titan LSE Models in a Safety-Oriented Circuit

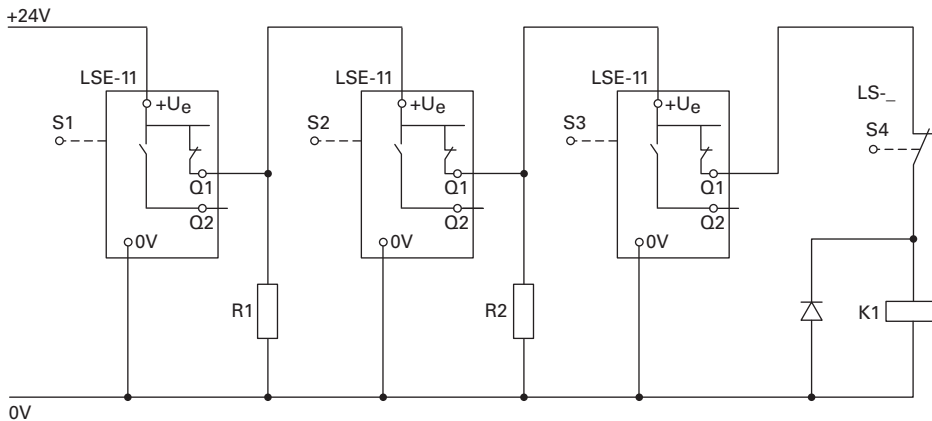

Notes

LSE-11 and LSE-02—individual operating point adjustment.

LSE-11 and LSE-02 can be used in safety circuits.



S1 is connected to 24 Vdc

S2, S3 each switch with a delay of 0.7s

R1, R2, for example, series element M22-XLED60 (2820 ohms/0.5W)

Accessories

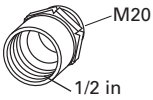
LS-Titan Safety Switches

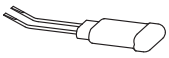
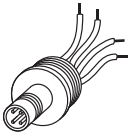
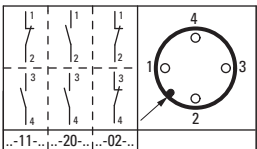
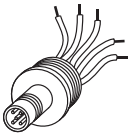
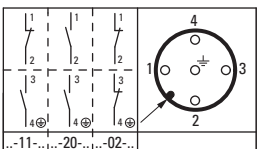
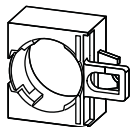
	For Use With	Description	Notes	Catalog Number
V1-2-M20 	Any	M20 screw terminal in 1/2 in. For use with American pipe thread, metal.	The screw connection must be earthed. Not total insulation.	V1-2-M20-NA
	Any	M20 screw terminal in 1/2 in. For use with American pipe thread, molded material.	—	V1-2-M20
EMS20 	Any	M20 diaphragm bolt. With internal push-through membrane. Will fit cable with an external diameter of up to 13 mm. Rated IP65 with cable inserted.	—	EMS20
LS-XTW 	Any	Cage Clamp tool.	—	LS-XTW
M12A 	LS-Titan plastic bodies (LS-_)	Plug connector, 12 mm, 4-pin male connector M12x1 (M12x1). Rated IP65. Molded material. Color coded to IEC/EN 60947-5-2.		M12A
M12A5 	LS-Titan metal bodies (LSM-_)	Plug connector, 12 mm, 5-pin male connector (M12x1). Rated IP65. Molded material. Color coded to IEC/EN 60947-5-2.		M12A5
M22-LS 	Any	Allows mounting of M22 pushbuttons. (See the M22 catalog, CA04716001E, for a full selection of pushbuttons.)	—	M22-LS

Technical Data and Specifications

LS-Titan Miniature DIN Switches—IP66, IP67 Complete Units

	Units		LS, LSM	LSE-11/LSE-02	LSE-AU ^①
General					
Standards			IEC/EN 60947	IEC/EN 60947 EN 61000-4	IEC/EN 60947 EN 61000-4
Climatic proofing			Damp heat, constant, to IEC 60068-2-78; damp heat, cyclical, to IEC 60068-2-30	Damp heat, constant, to IEC 60068-2-78; damp heat, cyclical, to IEC 60068-2-30	Damp heat, constant, to IEC 60068-2-78; damp heat, cyclical, to IEC 60068-2-30
Ambient temperature	°F (°C)		−13° to 158°F (−25° to 70°C)	−13° to 158°F (−25° to 70°C)	−13° to 158°F (−25° to 70°C)
Mounting position			As required	As required	As required
Protection type			IP66, IP67	IP66, IP67	IP66, IP67
Terminal capacity of screw terminal and Cage Clamp					
Solid	mm ²		1 x (0.5–2.5)	1 x (0.5–2.5)	1 x (0.5–2.5)
Flexible with ferrules to DIN 46228	mm ²		1 x (0.5–1.5)	1 x (0.5–1.5)	1 x (0.5–1.5)
Power Supply					
Rated voltage	U _e	Vdc	N/A	12–30	24 (−15%/+20%)
Burden current					
12V	I _e	mA	N/A	15	N/A
24V	I _e	mA	N/A	18	24
30V	I	mA	N/A	19	N/A
Contacts/Switching Capacity					
Rated impulse withstand voltage	U _{imp}	Vac	4000	N/A	N/A
Rated insulation voltage	U _i	V	400	N/A	N/A
Overvoltage category/ pollution degree			III/3	III/3	N/A
Rated Operational Current					
AC-15					
24V	I _e	A	6	N/A	N/A
230V/240V	I _e	A	6	N/A	N/A
400V/415V	I _e	A	4	N/A	N/A
DC-13					
24V	I _e	A	3	0.2	N/A
110V	I _e	A	0.8	N/A	N/A
220V	I _e	A	0.3	N/A	N/A

Note

^① The following applies for LSE-11 and LSE-02: ensure that the power supply operates correctly when setting the operating point.

LS-Titan Miniature DIN Switches—IP66, IP67 Complete Units. continued

	Units	LS, LSM	LSE-11/LSE-02	LSE-AU ①
Burden Current				
Analog output Q1				
Output voltage (max. 10 mA)	Vdc	N/A	N/A	0–10
Output current	mA	N/A	N/A	
Fault scenario	V	N/A	N/A	0
Resolution	Steps	N/A	N/A	100
Step tolerance	Steps	N/A	N/A	1
Shunt resistor, resistive load	ohms	N/A	N/A	>1000
Digital diagnostics output Q2 (switching to + pole PNP)				
Response threshold	V	N/A	N/A	Approx. U_g
	mA	N/A	N/A	<200
Control circuit reliability				
At 24 Vdc/5 mA	H_F	Fault probability	$<10^{-7}$, <1 fault in 10^7 operations	N/A
At 5 Vdc/1 mA	H_F	Fault probability	$<10^{-6}$, <1 failure at 5×10^6 operations	N/A
Supply frequency	Hz	Max. 400	N/A	N/A
Short-circuit rating to IEC/EN 60947-5-1				
Maximum fuse	A gG/gL	6	N/A	N/A
Repetition accuracy	mm	± 0.02	± 0.02	± 0.02

Note

① The following applies for LSE-11 and LSE-02: ensure that the power supply operates correctly when setting the operating point.

LS-Titan Miniature DIN Switches—IP66, IP67 Complete Units

	Units		LS, LSM	LSE-11/LSE-02	LSE-AU
Mechanical Variables					
Lifespan					
Standard-action contact	Operations	X 10 ⁶	8	N/A	N/A
Snap-action contact	Operations	X 10 ⁶	8	3 (electronic)	N/A
Contact temperature of roller head		°C	≤100	≤100	≤100
Mechanical shock resistance (half-sinusoidal shock, 20 ms)					
Standard-action contact		g	25	N/A	N/A
Snap-action contact		g	N/A	N/A	N/A
Basic unit		g	N/A	30	30
Operating frequency	Operations/h		≤6000	≤3000	≤3000
Switching point			N/A	0.5–5.5 mm freely adjustable	N/A
Hysteresis		mm	N/A	0.4	0.4
Contact sequence (contact closed open Zw = positive opening clearance)		mm	N/A	0.04	0.06
Actuation					
Mechanical					
Actuating force at beginning/ end of stroke					
Basic units		N	1.0/8.0	3.5/8.0	3.5/8.0
LS(M)-XP		N	1.0/8.0	1.0/8.0	1.0/8.0
LS(M)-XL		N	1.0/8.0	1.0/8.0	1.0/8.0
LS(M)-XLA		N	1.0/8.0	1.0/8.0	1.0/8.0
Actuating torque of rotary drives		Nm	0.2	0.2	0.2
Maximum operating speed with DIN cam					
Basic units for angle of actuation	$\alpha = 0^\circ/30^\circ$	m/s	1/0.5	1/0.5	1/0.5
LS(M)-XRL for angle of actuation	$\alpha = 0^\circ$	m/s	1.5	1.5	1.5
LS(M)-XRLA for angle of actuation	$\alpha = 30^\circ, L = 125 \text{ mm}$	m/s	1.5	1.5	1.5
LS(M)-XRR for angle of actuation	$L = 130 \text{ mm}$	m/s	1.5	1.5	1.5
LS(M)-XL for angle of actuation	$\alpha = 30^\circ/45^\circ$	m/s	1	1	1
LS(M)-XLA for angle of actuation	$\alpha = 30^\circ/45^\circ$	m/s	1	1	1
LS(M)-XP for angle of actuation	$\alpha = 0^\circ/30^\circ$	m/s	1/1	1/1	1/1
Electromagnetic Compatibility (EMC)					
Electrostatic discharge (IEC/EN 61000-4-2, Level 3 ESD)					
Air discharge		kV		8	8
Contact discharge		kV		4	4
Electromagnetic fields (IEC/EN 61000-403, RFI)		V/m		10	10
Burst pulses (IEC/EN 61000-4-4, Level 3)					
Supply cables		kV		2	2
Signal lines		kV		2	2
High-energy pulses (surge) (IEC/EN 61000-4-5)		kV		0.5	0.5
Immunity to line-conducted interference to (IEC/EN 61000-4-6)		V		10	10

Contact Travel Diagrams

LSE

Contact Travel

■ = contact closed
□ = contact open

LSE-11

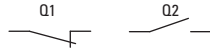

LSE-02



Description

Basic Units

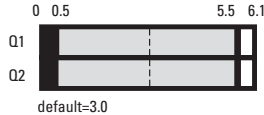
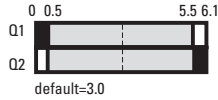

Operating Heads

Roller plunger

- LS-XP
- LSM-XP

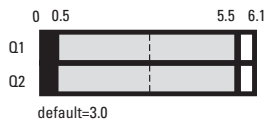
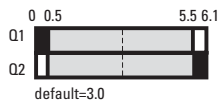

Roller lever

- LS-XL
- LSM-XL
- LS-XL
- LS-XLB

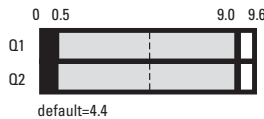
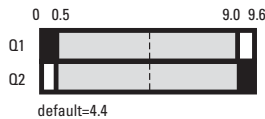

Angled roller lever

- LS-XLA
- LSM-XLA

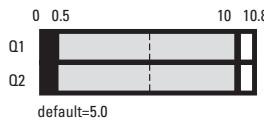
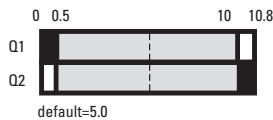

Rotary lever

- LS-XRL
- LSM-XRL

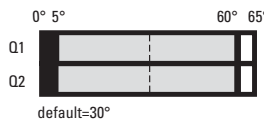
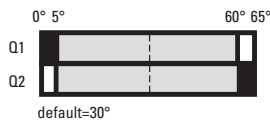

Adjustable roller lever

- LS-XRLA
- LSM-XRLA
- LS-XRLA30
- LS-XRLA40
- LS-XRLA40R

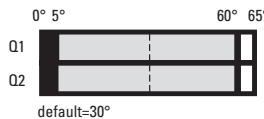
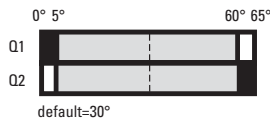

Actuating rod

- LS-XRR
- LSM-XRR
- LS-XRRM
- LSM-XRRM

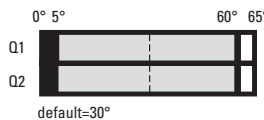
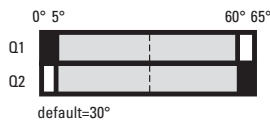

Spring rod

- LS-XS
- LSM-XS

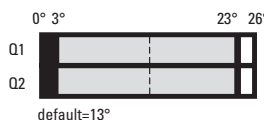
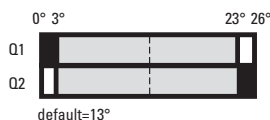

2.3

Limit Switches

LS-Titan Miniature DIN Switches

LS and LSM

2

Contact Travel

■ = contact closed
□ = contact open

LS-02, LS-S02, LSM-02

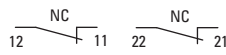

LS-11S, LS-S11S, LSM-11S

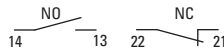

LS-20A, LS-S20A, LSM-20A

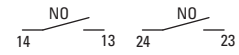

Description

Basic Units

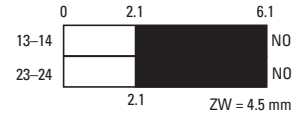
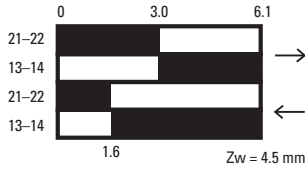
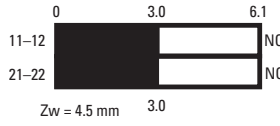

Operating Heads

Roller plunger

LS-XP, LSM-XP

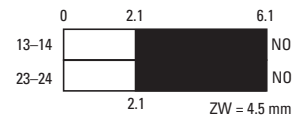
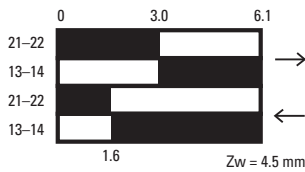
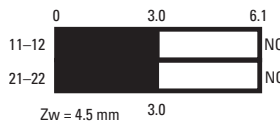

Roller lever

LS-XL, LSM-XL

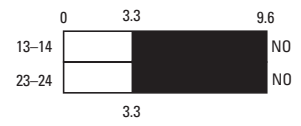
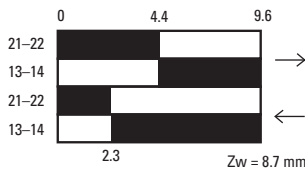
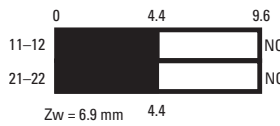

Roller lever, short

LS-XLS

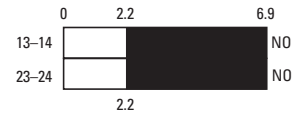
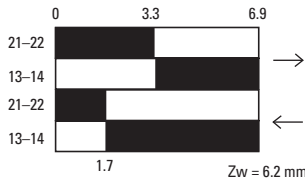
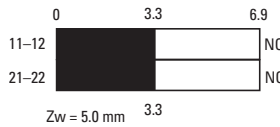

Roller lever, large

LS-XLB

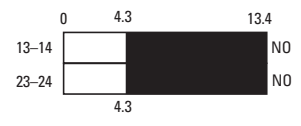
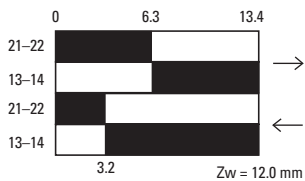
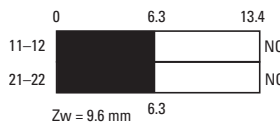

LS and LSM, continued

Contact Travel

= contact closed
 = contact open

LS-02, LS-S02, LSM-02

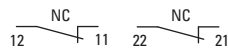

LS-11S, LS-S11S, LSM-11S

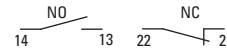

LS-20A, LS-S20A, LSM-20A

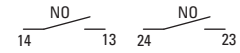

Description

Operating Heads

Angled roller lever

LS-XLA, LSM-XLA

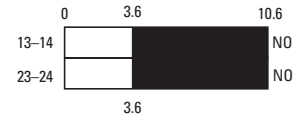
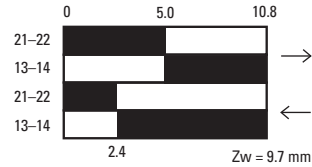
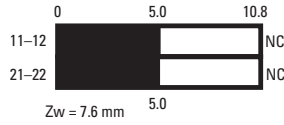

Rotary lever

LS-XRL, LSM-XRL

Adjustable roller lever

LS-XRLA, LSM-XRLA
LS-XRLA30, LS-XRLA40
LS-XRLA40R

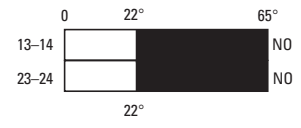
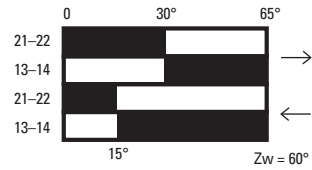
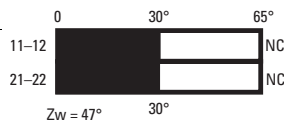

Actuating rod

LS-XRR, LSM-XRR
LS-XRRM, LSM-XRRM

Spring rod

LS-XS, LSM-XS

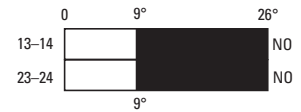
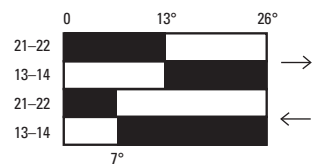
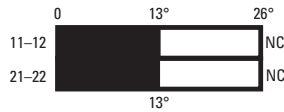

2.3

Limit Switches

LS-Titan Miniature DIN Switches

Dimensions

Approximate Dimensions in Inches (mm)

2

Position Switches

LS-_, LSM-_, LSE-_

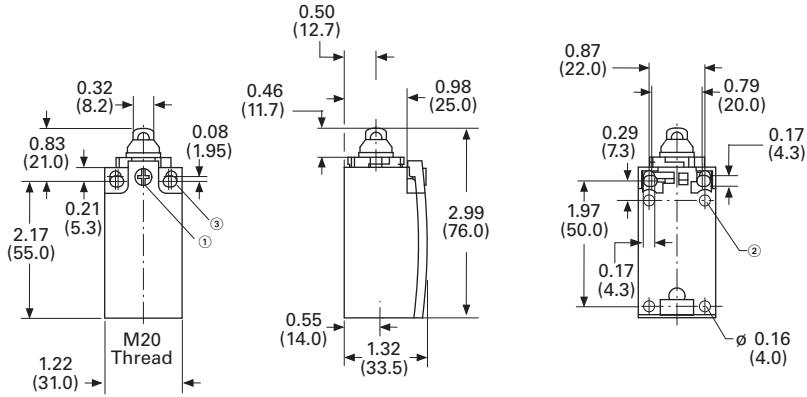

LS-_, LSM-_, LSE-_

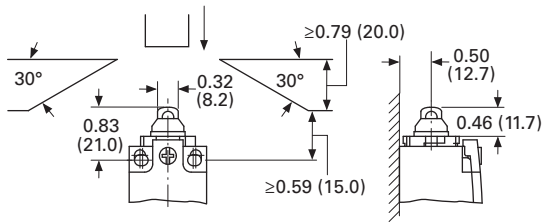

LS(M)-_/S

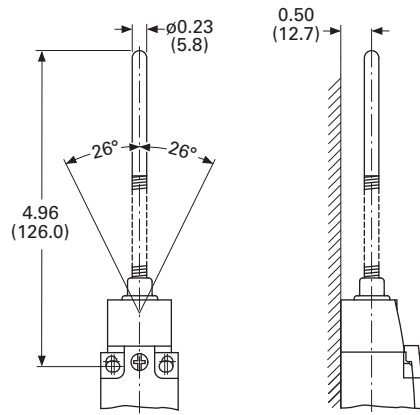

LS(M)-_/P

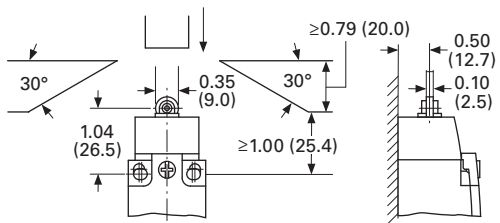

Notes

- ① Tightening torque of cover screws: 0.8 Nm \pm 0.2 Nm.
- ② Only with LS (insulated version).
- ③ Fixing screws 2 x M4 \geq 30
M_A = 1.5 Nm

Approximate Dimensions in Inches (mm)

Rotary Lever

LS(M)-_RL

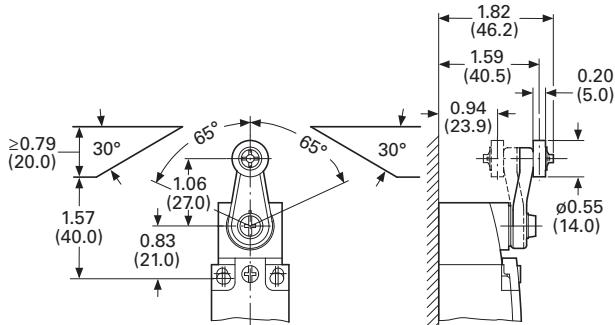

Roller Lever, Short

LS(M)-_LS

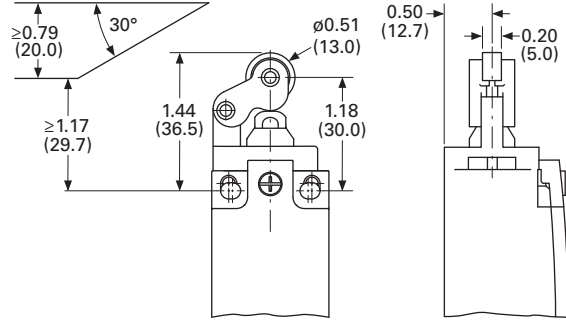

Roller Lever

LS(M)-_L

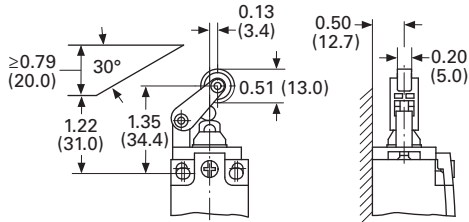

Adjustable Roller Lever

LS(M)-_RLA

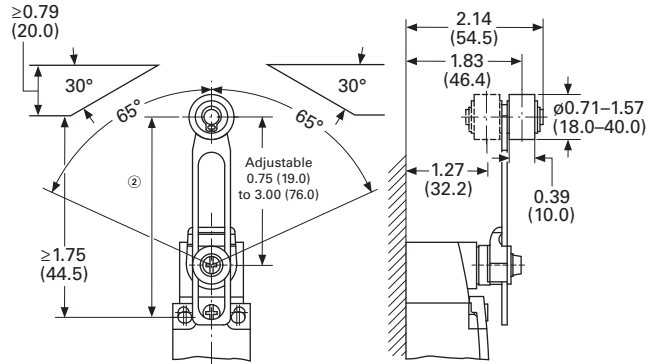

Roller Lever, Large

LS(M)-_LB ①

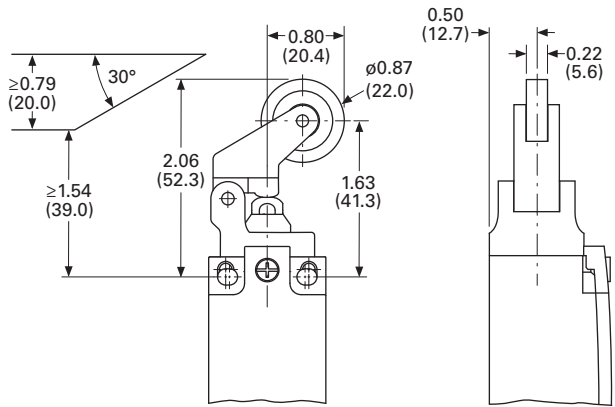

Angled Roller Lever

LS(M)-_XLA

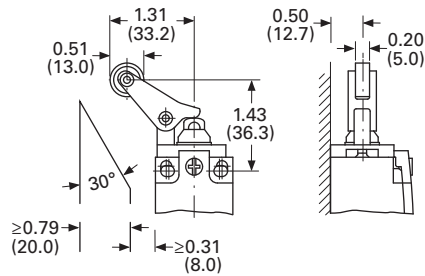

Notes

- ① Tightening torque of cover screws: 0.8 Nm ±0.2 Nm.
- ② Setting range of 54.5 to 97.

2.3

Limit Switches

LS-Titan Miniature DIN Switches

Approximate Dimensions in Inches (mm)

2

Actuating Rod

LS(M)-_/RR

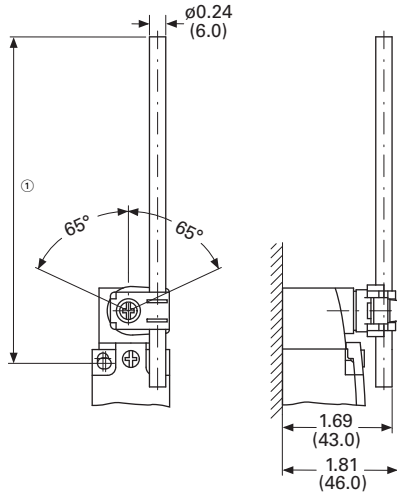

LS(M)-_/OR

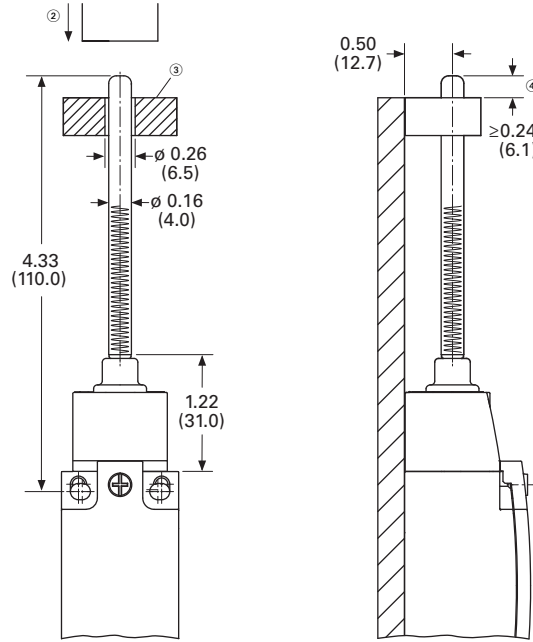

Notes

- ① LS_/RR ≤150
LS_/RRM ≤210
- ② Approach direction, vertical.
- ③ Guide is done by customer, not included.
- ④ Maximum push-through.

E49 Mini Metal Switches



Contents

Description**Page**

E49 Mini Metal Switches	
Product Selection	V8-T2-44
Technical Data and Specifications	V8-T2-46
Dimensions	V8-T2-47

Drawings
Online**E49 Mini Metal Switches****Product Description**

E49 Mini Metal Limit Switches from Eaton's electrical sector are designed small and tough, with machinery OEMs in mind. The small size, metal body and mechanical life make this product perfect for switching applications in packaging, material handling, elevators and lifts, electronic assembly equipment, injection molding machinery, and auto-vending machines. The E49 Mini Metal is the ideal switch for those who need a cost-effective, compact solution, but don't want to sacrifice durability in the process.

Features

- Long life—rated for 10 million operations
- Pre-wired units with custom cable lengths available for high volume customers
- "Fingerproof" terminals protect against accidental shock
- Double-spring mechanism for contact reliability
- Grounding terminal included
- Captive screws on enclosure cover make wiring hassle-free
- SPDT double break

Standards and Certifications

- UL Recognized, E117028 (Model E49G31C1P3 is not UL Recognized)
- CE
- RoHS Compliant

**⚠ DANGER**

THIS SENSOR IS NOT A SAFETY DEVICE AND IS NOT INTENDED TO BE USED AS A SAFETY DEVICE. This sensor is designed only to detect and read certain data in an electronic manner and perform no use apart from that, specifically no safety-related use. This sensor product does not include self-checking redundant circuitry, and the failure of this sensor product could cause either an energized or de-energized output condition, which could result in death, serious bodily injury, or property damage.

For the most current information on this product, visit our Web site: www.eaton.com

For Customer Service in the U.S. call 1-877-ETN CARE (386-2273), in Canada call 1-800-268-3578.
For Application Assistance in the U.S. and Canada call 1-800-426-9184.

Product Selection

2

E49 Mini Metal Switches

<i>Operating Head Type</i>	Travel to Operate Contacts	Travel to Reset Contacts	Total Travel	Force to Operate Contacts	Minimum Return Force	Assembled Unit (Switch Body and Head) 1NO-1NC Contacts Catalog Number
Side Rotary Lever 	Side Rotary Lever 20°	12°	70°	750g	100g	E49G31AP3
Adjustable Side Rotary Lever 	Adjustable Side Rotary Lever 20°	12°	70°	750g	100g	E49G31UP3
Top Pushbutton 	Top Pushbutton 0.06 in (1.5 mm)	0.04 in (1 mm)	0.22 in (5.5 mm)	900g	150g	E49G31BP3
Top Push Roller 	Top Push Roller 0.06 in (1.5 mm)	0.04 in (1 mm)	0.22 in (5.5 mm)	900g	150g	E49G31CP3
Top Push Roller (90° Roller) 	Top Push Roller (90° Roller) 0.06 in (1.5 mm)	0.04 in (1 mm)	0.22 in (5.5 mm)	900g	150g	E49G31C1P3
Adjustable Rod Lever 	Adjustable Rod Lever 20°	12°	70°	750g	100g	E49G31DP3

E49 Mini Metal Switches, continued

<i>Operating Head Type</i>	Travel to Operate Contacts	Travel to Reset Contacts	Total Travel	Force to Operate Contacts	Assembled Unit (Switch Body and Head) 1NO-1NC Contacts Catalog Number
Wobble Stick (Nylon Coil) 	Wobble Stick (Nylon Coil)				
	1.18 in (30 mm)	—	—	150g	E49G31NP3
Wobble Stick (Metal Coil) 	Wobble Stick (Metal Coil)				
	1.18 in (30 mm)	—	—	150g	E49G31VP3
Wobble Stick (Metal Rod) 	Wobble Stick (Metal Rod)				
	1.18 in (30 mm)	—	—	150g	E49G31MP3
Wobble Stick (Whisker) 	Wobble Stick (Whisker)				
	1.18 in (30 mm)	—	—	150g	E49G31XM3

Technical Data and Specifications

2

E49 Mini Metal Switches

Description	Specification
Operating speed	0.19 in (5 mm) to 19.7 in/s (50 cm/s)
Operating frequency	120 operations/min
Contact resistance	25M ohms (initial)
Insulation resistance	100M ohms min (at 500 Vdc)
Dielectric strength	1000 Vac, 50/60 Hz for one minute between non-continuous terminals
	1500 Vac, 50/60 Hz for one minute between current-carrying and non-current-carrying parts and between each terminal and ground
Vibration	10 to 55 Hz, 1.5 mm double amplitude
Shock	Approx. 300 m/s ² (approx. 30Gs)
Ambient operating temperature	23° to 149°F (–5° to 65°C)
Humidity	95% RH max.
Service life	Mechanical: 10,000,000 operations min.
	Electrical: 500,000 operations min.
Weight	Approx. 130 to 190g
Degree of protection	IEC: IP65
Material of construction	Shaft: stainless SUS303 Arm: stainless SUS304 Head and body: zinc alloy Terminal cover: PC/ABS plastic Rubber grommet: NBR rubber

Maximum Ampere Ratings

Rated Voltage	Non-Inductive Load (A)		Lamp Load ^②		Inductive Load (A) ^①		Motor Load	
	Resistive Load		NC	NO	Inductive Load		NC	NO
	NC	NO			NC	NO		
125 Vac	5	5	1.5	0.7	3	3	2	1
250 Vac	5	5	1	0.5	3	3	1.5	0.8
8 Vdc	5	5	3	3	5	4	3	3
14 Vdc	5	5	3	3	4	4	3	3
30 Vdc	5	5	3	3	4	4	3	3
125 Vdc	0.4	0.4	—	—	—	—	—	—
250 Vdc	0.2	0.2	—	—	—	—	—	—

Terminal Configuration

NO (4) —○ ○— NO (3)

NC (1) —● ●— NC (2)

Notes

- ^① Inductive load has a power factor of 0.4 min. (AC) and a time constant of 7 msec. max. (DC).
^② Lamp load has an inrush current of ten times the steady-state current, while motor load has an inrush current of six times the steady-state current.

Dimensions

Approximate Dimensions in Inches (mm)

E49G31AP3

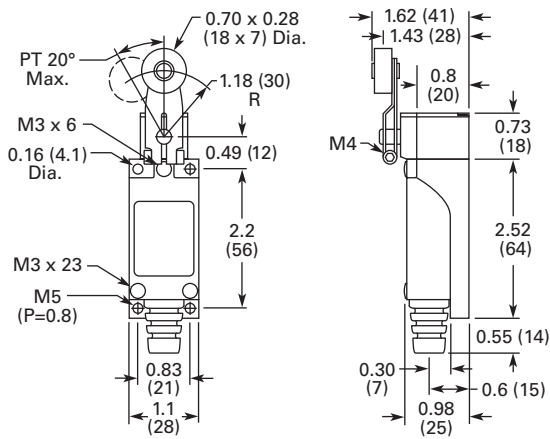

E49G31CP3

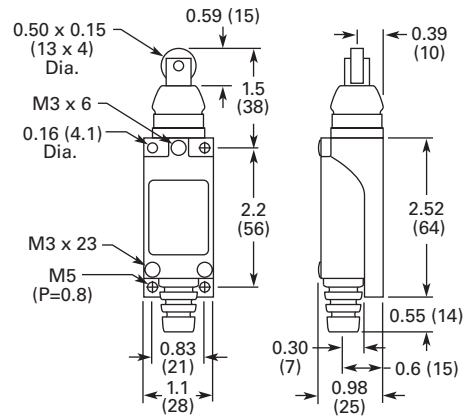

E49G31BP3

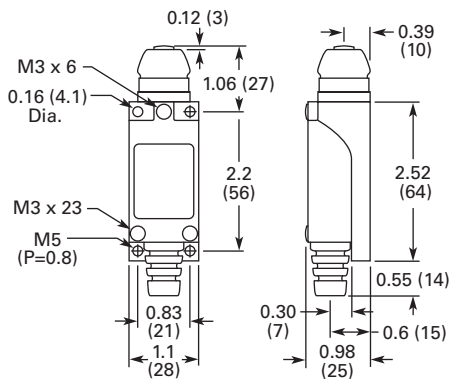

E49G31DP3

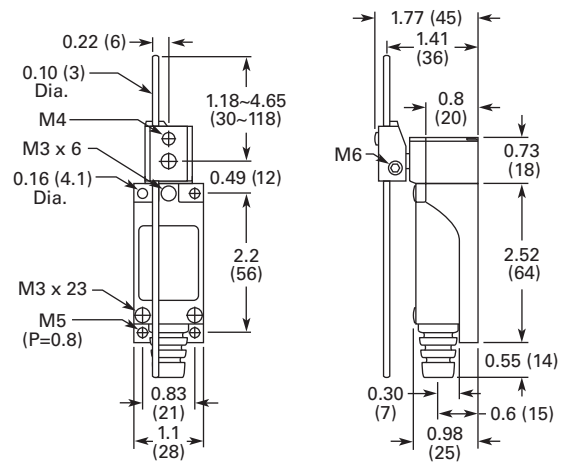

E49G31C1P3

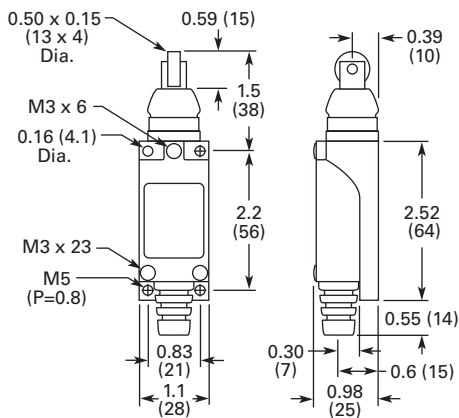

E49G31MP3

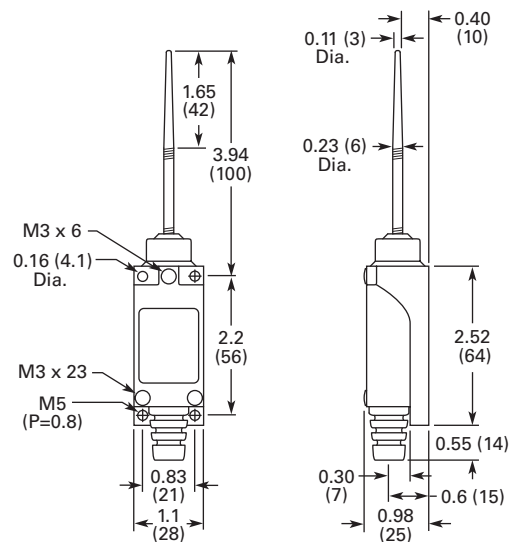

2.4

Limit Switches

E49 Mini Metal Switches

Approximate Dimensions in Inches (mm)

E49G31NP3

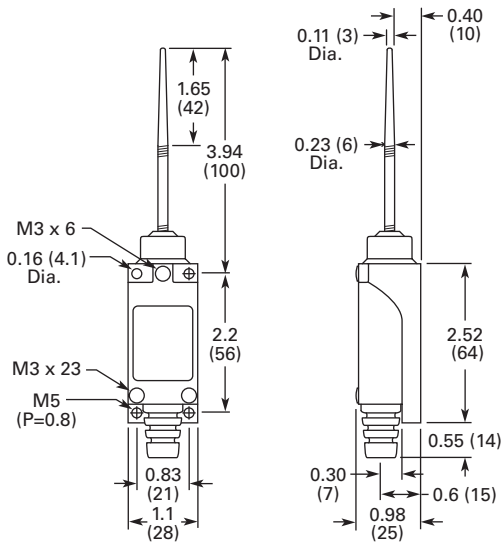

E49G31VP3

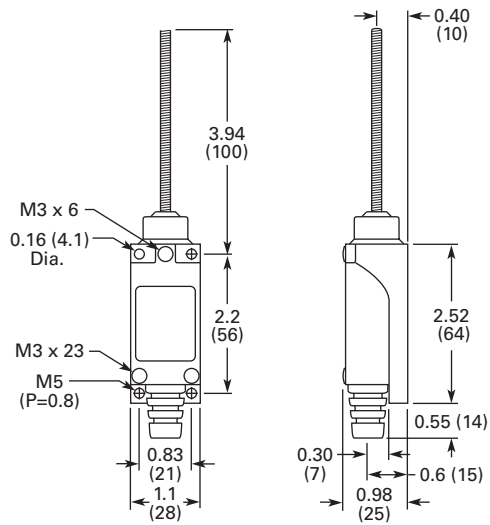

E49G31UP3

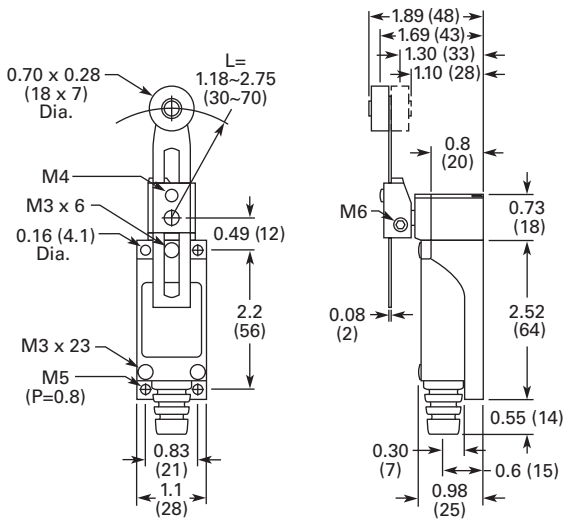

E49G31XM3

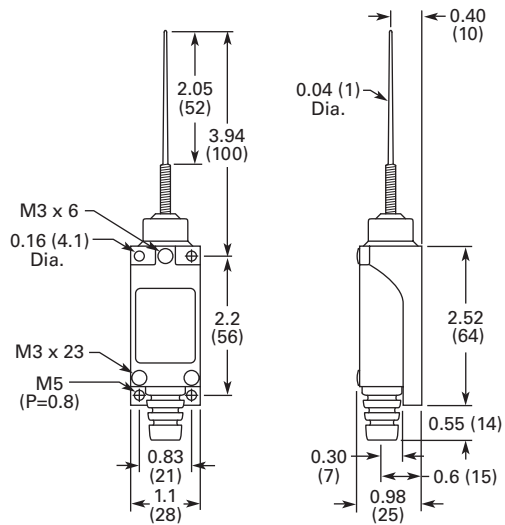

E49 Compact Metal Switches



Contents

<i>Description</i>	<i>Page</i>
E49 Compact Metal Switches	
Product Selection	V8-T2-50
Technical Data and Specifications	V8-T2-51
Dimensions	V8-T2-52

 Drawings Online

E49 Compact Metal Switches

Product Description

E49 Compact Metal Switches by Eaton’s electrical sector are designed with high mechanical strength for harsh environments. The rugged aluminum die cast construction provides reliable, oil-tight, waterproof and dustproof sealing for a variety of applications. Snap action 1NO-1NC contacts provide flexibility in design.

Features

- Rigid die cast switch housing
- High mechanical strength
- Oil-tight, waterproof and dustproof construction

Standards and Certifications

- UL Listed, E170645
- UL tested to Canadian safety standards
- RoHS Compliant



⚠ DANGER

THIS SENSOR IS NOT A SAFETY DEVICE AND IS NOT INTENDED TO BE USED AS A SAFETY DEVICE. This sensor is designed only to detect and read certain data in an electronic manner and perform no use apart from that, specifically no safety-related use. This sensor product does not include self-checking redundant circuitry, and the failure of this sensor product could cause either an energized or de-energized output condition, which could result in death, serious bodily injury, or property damage.

For the most current information on this product, visit our Web site: www.eaton.com

For Customer Service in the U.S. call 1-877-ETN CARE (386-2273), in Canada call 1-800-268-3578. For Application Assistance in the U.S. and Canada call 1-800-426-9184.



Product Selection

2

E49 Compact Metal Switches

<i>Operating Head Type</i>	Travel to Operate Contacts	Travel to Reset Contacts	Total Travel	Force to Operate Contacts (Maximum)	Minimum Return Force	Assembled Unit (Switch Body and Head) 1NO-1NC Contacts Catalog Number
Roller Lever 	20°	12°	50°	2.99 lbs	0.50 lb	E49M11AP1
Top Push 	0.067 in (1.7 mm)	0.04 in (1.0 mm)	—	6.02 lbs	2.01 lbs	E49M11BP1
Top Push Roller 	0.067 in (1.7 mm)	0.04 in (1.0 mm)	0.25 in (6.5 mm)	6.02 lbs	2.01 lbs	E49M11CP1 (as pictured) E49M11CP2 90° Cross Roller
Rod Lever 	20°	12°	50°	0.31 lb	0.06 lb	E49M11DP1
Adjustable Roller Lever 	20°	12°	50°	2.99 lbs	0.50 lb	E49M11UP1

E49 Compact Metal Switches, continued

Operating Head Type	Travel to Operate Contacts	Travel to Reset Contacts	Total Travel	Force to Operate Contacts (Maximum)	Minimum Return Force	Assembled Unit (Switch Body and Head) 1NO-1NC Contacts Catalog Number
Wobble	Wobble					
	1.10 in (28 mm)	N/A	N/A	0.33 lb	N/A	E49M11VP1
Cat Whisker	Cat Whisker					
	1.10 in (28 mm)	N/A	N/A	0.064 lb	N/A	E49M11XM1

Technical Data and Specifications

E49 Compact Metal Switches

Description	Specification
Operating speed	1 mm to 2m/sec
Operating frequency	Mechanically: 120 operations/min.; Electronically: 30 operations/min.
Contact resistance	15M ohms max. (initial)
Insulation resistance	100M ohms min. (at 500 Vdc)
Dielectric strength	1000 Vac, 50/60 Hz for 1 minute between non-continuous terminals; 2200 Vac, 50/60 Hz for 1 minute between each terminal and non-current carrying metal part and between each terminal and ground
Vibration	Malfunction durability: approx. 1000 m/sec ² (approx. 100 Gs); Malfunction durability: approx. 300/sec ² (30 Gs)
Ambient operating temperature	14° to 176°F (-10° to 80°C)
Humidity	95% RH max.
Service life	Mechanically: 15,000,000 operations/minute; Electronically: 500,000 operations/minute

Maximum Ampere Ratings—Isolated Contacts, No Polarity Restriction

NEMA A600 (AC-15) 50 or 60 Hz						NEMA R300 (DC-13)	
Rated Voltage	Current		Voltamperes			Rated Voltage	Current
	Continuous	Make	Break	Make	Break		
24 Vac	10A	60A	6.0A	7200 VA	720 VA	24 Vdc	1.5A
120 Vac	10A	60A	6.0A	7200 VA	720 VA	120 Vdc	0.22A
250 Vac	10A	30A	3.0A	7200 VA	720 VA	250 Vdc	0.11A
480 Vac	10A	15A	1.5A	7200 VA	720 VA		
600 Vac	10A	12A	1.2A	7200 VA	720 VA		

2.5

Limit Switches

E49 Compact Metal Switches

2

Dimensions

Approximate Dimensions in Inches (mm)

Switch Body with E49M11BP1

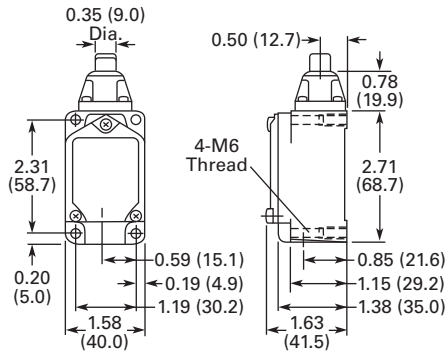

E49M11UP1

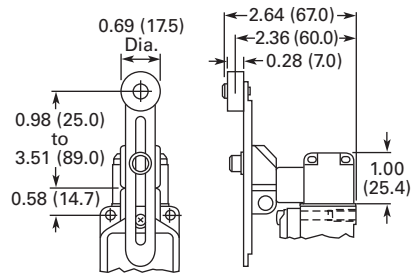

E49M11CP1/E49M11CP2

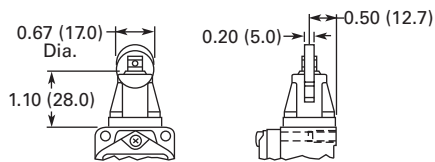

E49M11VP1

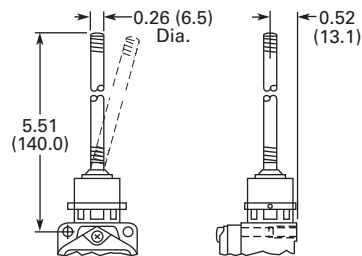

E49M11DP1

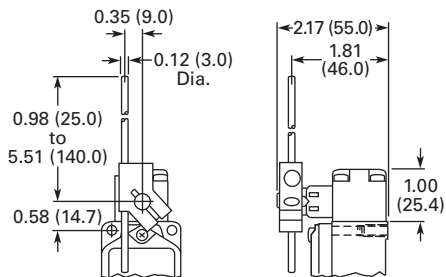

E49M11XM1

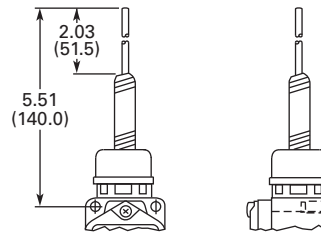

E49M11AP1

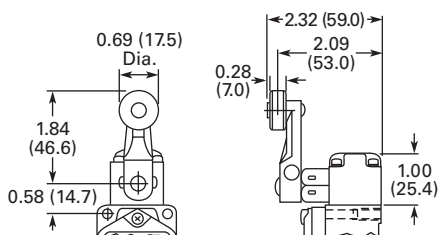

E50 Heavy-Duty Plug-In Switches



E50 Heavy-Duty Plug-In Switches

Product Description

E50 Modular Plug-In Limit Switch Components from Eaton's electrical sector are the industry standard with versatility of design and high reliability for low maintenance, installation and inventory costs. Standard Viton gaskets, seals and boots and a zinc die cast enclosure provide exceptional chemical resistance to the common coolants, cleansing agents, and hydraulic fluids found in machine tool, automotive, waste water treatment and other heavy-duty industrial applications. Mounting dimensions accommodate both U.S. and DIN standards for easy retrofit installations. Super bright 24–120 Vac/dc LED indicating light versions simplify setup and troubleshooting operations.

Features

- Modular, plug-in components (head, body and receptacle) provide application flexibility, reduced inventory and less downtime
- Manufactured to take the physical and environmental abuse (including cutting fluids and chemicals) of harsh industrial environments
- Chemical resistant Viton gaskets, seals and boots are standard, and so are captive, posi-drive screws
- The switches have terminal identification on the nameplate for a visual wiring checkout without guesswork. Heads and switch bodies can be replaced without rewiring
- E50 devices can be ordered in separate components or as complete assembled switches
- 600V rating, ridge-topped contacts and wiping action assure continuity even to logic level circuits
- Keyed, four direction head positioning
- Standard 5° pre-travel and 90° total travel
- 24–120 Vac/dc LED and 120 Vac neon indicating lights available
- Rotary heads are field convertible CW, CCW, or both, without special tools
- Epoxy filled, pin connector or pigtail pin connector receptacles available

Standards and Certifications

- UL Listed, E170645
- CSA Certified, 50513
- CE (where shown)
- RoHS Compliant



⚠ DANGER

THIS SENSOR IS NOT A SAFETY DEVICE AND IS NOT INTENDED TO BE USED AS A SAFETY DEVICE. This sensor is designed only to detect and read certain data in an electronic manner and perform no use apart from that, specifically no safety-related use. This sensor product does not include self-checking redundant circuitry, and the failure of this sensor product could cause either an energized or de-energized output condition, which could result in death, serious bodily injury, or property damage.

Contents

Description

Page

E50 Heavy-Duty Plug-In Switches	
Product Selection	
Assembled Switches—Standard	V8-T2-54
Assembled Switches—Special Purpose	V8-T2-57
Operating Heads	V8-T2-58
Switch Bodies	V8-T2-59
Receptacles	V8-T2-60
Compatible Connector Cables	V8-T2-61
Accessories	V8-T2-61
Technical Data and Specifications	V8-T2-62
Circuit Diagrams	V8-T2-64
Wiring Diagrams	V8-T2-64
Dimensions	V8-T2-65



Drawings
Online

For the most current information on this product, visit our Web site: www.eaton.com

For Customer Service in the U.S. call 1-877-ETN CARE (386-2273), in Canada call 1-800-268-3578.
For Application Assistance in the U.S. and Canada call 1-800-426-9184.

2.6

Limit Switches

E50 Heavy-Duty Plug-In Switches

Product Selection

Assembled Switches—Standard

2

Assembled Switch

E50 Heavy-Duty Plug-In Switches, Assembled—Standard



Single-Pole (5 Terminal Receptacle)

Two-Pole (9 Terminal Receptacle)

Indicating Light:	None	LED (24–120 Vac/dc)	Neon (120 Vac)	None	LED (24–120 Vac/dc)	Neon (120 Vac)	LED (24–120 Vac/dc)	Neon (120 Vac)
Switch Body:	E50SA	E50SAL	E50SAN	E50SB	E50SBL	E50SBN	E50SCL	—
Receptacle: ①	E50RA	E50RA	E50RA	E50RB	E50RB	E50RB	E50RB	E50RB
Description	Assembled Switch (Head + Receptacle + Body) Catalog Number			Assembled Switch (Head + Receptacle + Body) Catalog Number				

Operating Head Type ②

Side Rotary



Description	Side Rotary (requires an operating lever, see Page V8-T2-79)							
Standard spring return—E50DR1 ③	E50AR1 CE	E50ALR1	E50ANR1	E50BR1	E50BLR1	E50BNR1	—	—
Low force spring return—E50DL1 ③	E50AL1 CE	E50ALL1	E50ANL1	E50BL1	E50BLL1	E50BNL1	—	—
Maintained two-position—E50DM1	E50AM1 CE	E50ALM1	E50ANM1	E50BM1	E50BLM1	E50BNM1	—	—

Spring Return



Spring return—E50DS1	E50AS1 CE	E50ALS1	E50ANS1	E50BS1	E50BS1	E50BNS1	E50CLS1	—
----------------------	--------------	---------	---------	--------	--------	---------	---------	---

Adjustable Spring Return



Adjustable spring return—E50DS2	E50AS2 CE	E50ALS2	E50ANS2	E50BS2	E50BS2	E50BNS2	E50BLS2	E50CNS2
---------------------------------	--------------	---------	---------	--------	--------	---------	---------	---------

Circuit Diagrams, see [Page V8-T2-64](#).

Notes

① Connection options (add the code suffix from the table below to the end of the catalog number):

Option		Mating Cordset Catalog Number	Code Suffix
Mini-connector ④ (with epoxy filled receptacle)	Single-pole (5-pin mini-connector)	CSMS5D5CY1602	P5 ⑤
	Two-pole (9-pin mini-connector)	CSMS9D9CY1602	P9 ⑤
Micro-connector ④ (with epoxy filled receptacle)	Single-pole (5-pin micro-connector)	CSDS5A5CY2202	A5 ⑤
Cable connection (with epoxy filled receptacle)	8 ft cable length	—	S
	12 ft cable length	—	S12
	20 ft cable length	—	S20
Manifold mount (rear wiring entrance)	—	—	M
20 mm conduit entrance	—	—	20

② For operating head specifications, see [Page V8-T2-58](#).

③ CW (clockwise) and CCW (counterclockwise) operation, easily convertible to CW only or CCW only operation.

④ For a full selection of cable connectors, see [Tab 10, section 10.1](#).

⑤ Refer to [Page V8-T2-64](#) for wiring diagrams.

E50 Heavy-Duty Plug-In Switches, Assembled—Standard, continued

Assembled Switch



Single-Pole (5 Terminal Receptacle)

Two-Pole (9 Terminal Receptacle)

Indicating Light:	None	LED (24–120 Vac/dc)	Neon (120 Vac)	None	LED (24–120 Vac/dc)	Neon (120 Vac)	LED (24–120 Vac/dc)	Neon (120 Vac)
Switch Body:	E50SA	E50SAL	E50SAN	E50SB	E50SBL	E50SBN	E50SCL	—
Receptacle: ①	1NO-1NC	1NO-1NC	1NO-1NC	2NO-2NC	2NO-2NC	2NO-2NC	1NO-2NC	—
	E50RA	E50RA	E50RA	E50RB	E50RB	E50RB	E50RB	E50RB
Description	Assembled Switch (Head + Receptacle + Body)			Assembled Switch (Head + Receptacle + Body)				
Catalog Number	Catalog Number			Catalog Number				

Operating Head Type ②

Side Push Roller



Spring return—E50DS3 ③	E50AS3	E50ALS3	E50ANS3	E50BS3	E50BLS3	E50BNS3	E50BLS3	—
	CE							

Side Pushbutton



Maintained—E50DH1	E50AH1	E50ALH1	E50ANH1	E50BH1	E50BLH1	E50BNH1	E50BLH1	—
	CE							

Top Pushbutton

Spring Return



Spring return—E50DT1	E50AT1	E50ALT1	E50ANT1	E50BT1	E50BLT1	E50BNT1	E50CLT1	E50BNT1
	CE							

Adjustable Spring Return



Adjustable spring return—E50DT2	E50AT2	E50ALT2	E50ANT2	E50BT2	E50BLT2	E50BNT2	—	—
	CE							

Circuit Diagrams, see Page V8-T2-64.

Notes

① Connection options (add the code suffix from the table below to the end of the catalog number):

Option		Mating Cordset Catalog Number	Code Suffix
Mini-connector ④ (with epoxy filled receptacle)	Single-pole (5-pin mini-connector)	CSMS5D5CY1602	P5 ⑤
	Two-pole (9-pin mini-connector)	CSMS9D9CY1602	P9 ⑤
Micro-connector ④ (with epoxy filled receptacle)	Single-pole (5-pin micro-connector)	CSDS5A5CY2202	A5 ⑤
	8 ft cable length	—	S
	12 ft cable length	—	S12
Cable connection (with epoxy filled receptacle)	20 ft cable length	—	S20
	Manifold mount (rear wiring entrance)	—	M
20 mm conduit entrance	—	—	20

② For operating head specifications, see Page V8-T2-58.

③ Roller can be converted in the field between horizontal and vertical.

④ For a full selection of cable connectors, see Tab 10, section 10.1.

⑤ Refer to Page V8-T2-64 for wiring diagrams.

2.6

Limit Switches

E50 Heavy-Duty Plug-In Switches

2

Assembled Switch



E50 Heavy-Duty Plug-In Switches, Assembled—Standard, continued



Single-Pole (5 Terminal Receptacle)

Two-Pole (9 Terminal Receptacle)

Indicating Light:	None	LED (24–120 Vac/dc)	Neon (120 Vac)	None	LED (24–120 Vac/dc)	Neon (120 Vac)	LED (24–120 Vac/dc)	Neon (120 Vac)
Switch Body:	E50SA	E50SAL	E50SAN	E50SB	E50SBL	E50SBN	E50SCL	—
Receptacle: ①	1NO-1NC	1NO-1NC	1NO-1NC	2NO-2NC	2NO-2NC	2NO-2NC	1NO-2NC	—
	E50RA	E50RA	E50RA	E50RB	E50RB	E50RB	E50RB	E50RB
Description	Assembled Switch (Head + Receptacle + Body)			Assembled Switch (Head + Receptacle + Body)				
Catalog Number								

Operating Head Type ②

Top Push Roller



Description	Top Push Roller			Assembled Switch (Head + Receptacle + Body)				
Catalog Number								
Spring return E50DT3 ③	E50AT3 CE	E50ALT3	E50ANT3	E50BT3	E50BLT3	E50BNT3	—	—

Wobble Head, Spring Return



Description	Wobble Head, Spring Return (requires a wobble operator, see Page V8-T2-79)			Assembled Switch (Head + Receptacle + Body)				
Catalog Number								
Standard duty— E50DW1	E50AW1 CE	E50ALW1	E50ANW1	E50BW1	E50BLW1	E50BNW1	E50BLW1	—
Heavy-duty high strength steel— E50DW2	E50AW2 CE	E50ALW2	E50ANW2	E50BW2	E50BLW2	E50BNW2	E50CLW2	E50BNW2

Circuit Diagrams, see Page V8-T2-64.

Notes

① Connection options (add the code suffix from the table below to the end of the catalog number):

Option		Mating Cordset Catalog Number	Code Suffix	
Mini-connector ④ (with epoxy filled receptacle)	Single-pole (5-pin mini-connector)	CSMS5D5CY1602	P5 ⑤	
	Two-pole (9-pin mini-connector)	CSMS9D9CY1602	P9 ⑤	
Micro-connector ④ (with epoxy filled receptacle)	Single-pole (5-pin micro-connector)	CSDS5A5CY2202	A5 ⑤	
	Cable connection (with epoxy filled receptacle)	8 ft cable length	—	S
		12 ft cable length	—	S12
20 ft cable length		—	S20	
Manifold mount (rear wiring entrance)		—	M	
20 mm Conduit Entrance		—	20	

② For operating head specifications, see Page V8-T2-58.

③ Roller can be converted in the field between horizontal and vertical.

④ For a full selection of cable connectors, see Tab 10, section 10.1.

⑤ Refer to Page V8-T2-64 for wiring diagrams.

Assembled Switches—Special Purpose**E50 Heavy-Duty Plug-In Switches, Assembled—Special Purpose**

Operating Data— Nominal Switches	Assembled Switch Catalog Number	Switch Body Only Catalog Number	Receptacle Only Catalog Number	Operating Head Only Catalog Number
Neutral Position	Neutral Position (requires an operating lever, see Page V8-T2-79)			
5° Travel	E50NN1 ①	E50SN	E50RB	E50DN1 ①
5° Travel; stainless steel shaft	E50NN1SPL ②	—	—	—
15° Travel	E50NN2	E50SN	E50RB	E50DN2 ①
Travel to operate contacts:	—	—	—	5° or 15° ③
Travel to reset contacts:	—	—	—	2°
Total travel:	—	—	—	90°
Force to operate contacts:	—	—	—	1.8 in-lbs
Minimum return force:	—	—	—	2.5 in-oz
Operating temperature:	—	—	—	14° to 200°F (–10° to 94°C)
Two-Step	Two-Step CW, CCW, or both, Convertible (requires an operating lever, see Page V8-T2-79)			
—	E50TD1	E50ST	E50RB	E50DD1
Travel to operate contacts:	—	—	—	1st step 10°; 2nd step 20°
Travel to reset contacts:	—	—	—	4° each
Total travel:	—	—	—	90°
Force to operate contacts:	—	—	—	3 in-lbs
Minimum return force:	—	—	—	4.5 in-oz
Operating temperature:	—	—	—	CW or CCW: 14° to 250°F (–10° to 121°C) CW and CCW: 14° to 200°F (–10° to 94°C)
Gravity Return	Gravity Return (requires E50KL220, E50KL226 or equivalent operating lever, see Page V8-T2-79)			
Without indicating light	E50GG1	E50SG	E50RA	E50DG1
With LED indicating light (24–120 Vac/dc)	E50GLG1	E50SGL	E50RA	E50DG1
With neon indicating light (120 Vac)	E50GNG1	E50SGN	E50RA	E50DG1
Travel to operate contacts:	—	—	—	10° to 170°
Travel to reset contacts:	—	—	—	8°
Total travel:	—	—	—	360°
Force to operate contacts:	—	—	—	3.0 in-oz
Minimum return force:	—	—	—	Gravity
Operating temperature:	—	—	—	14° to 200°F (–10° to 94°C)
Circuit Diagrams , see Page V8-T2-64 .				

Notes

- ① Add **9** suffix to the model number for low temperature –40° to 174°F (–40 to 79°C) versions.
- ② Low temperature rating –40° to 174°F (–40° to 79°C)
- ③ Depending upon model selected.



2.6

Limit Switches

E50 Heavy-Duty Plug-In Switches

Operating Heads

2

E50 Heavy-Duty Plug-In Switches, Operating Heads

Description	Travel to Operate Contacts	Travel to Reset Contacts	Total Travel	Force to Operate Contacts	Minimum Return Force	Operating Temperature ^①		Catalog Number
						Without Cable	With Pre-Wired Cable	
Side Rotary (requires an operating lever, see Page V8-T2-79)								
Standard spring return ^②	5°	2°	90°	3 in-lbs	4.5 in-oz	10° to 200°F (-12° to 94°C) ^③	10° to 200°F (-12° to 94°C) ^③	E50DR1
Low temperature spring return ^②	5°	2°	90°	3 in-lbs	4.5 in-oz	-40° to 175°F (-40° to 79°C)	-31° to 175°F (-34° to 79°C)	E50DR19
Low force spring return ^②	15°	6°	90°	1.5 in-lbs	2.5 in-oz	10° to 200°F (-12° to 94°C) ^③	10° to 200°F (-12° to 94°C) ^③	E50DL1
Maintained two-position	50°	50°	90°	3 in-lbs	—	14° to 200°F (-10° to 94°C)	14° to 200°F (-10° to 94°C)	E50DM1
Side Pushbutton								
Spring return	0.065 in	0.030 in	0.250 in	4 lbs	8 oz	14° to 200°F (-10° to 94°C)	14° to 200°F (-10° to 94°C)	E50DS1
Adjustable Spring Return	0.065 in	0.030 in	0.250 in	4 lbs	8 oz	14° to 200°F (-10° to 94°C)	14° to 200°F (-10° to 94°C)	E50DS2
Side Push Roller								
Spring return ^④	0.065 in	0.030 in	0.250 in	4 lbs	8 oz	14° to 200°F (-10° to 94°C)	14° to 200°F (-10° to 94°C)	E50DS3 ^⑤
	0.065 in	0.030 in	0.250 in	4 lbs	8 oz	14° to 200°F (-10° to 94°C)	14° to 200°F (-10° to 94°C)	E50DS4 ^⑤
Side Pushbutton								
Maintained	0.200 in	0.130 in	0.320 in	5 lbs	5 lbs	14° to 200°F (-10° to 94°C)	14° to 200°F (-10° to 94°C)	E50DH1
Top Pushbutton								
Spring return	0.040 in	0.020 in	0.280 in	4 lbs	8 oz	14° to 250°F (-10° to 121°C)	14° to 221°F (-10° to 105°C)	E50DT1
Adjustable Spring Return	0.040 in	0.020 in	0.280 in	4 lbs	8 oz	14° to 250°F (-10° to 121°C)	14° to 221°F (-10° to 105°C)	E50DT2

Notes

- ① Temperature ranges below 32°F (0°C) are based on absence of freezing moisture or water.
- ② CW (clockwise) and CCW (counterclockwise) operation, easily convertible to CW only or CCW only operation.
- ③ For CW and CCW operation. For CW only or CCW only operation, high temperature limit increases to 250°F (121°C) without cable, and 221°F (105°C) with pre-wired cable.
- ④ Roller can be converted in the field between horizontal and vertical.
- ⑤ Roller shaft is 0.38 in (9.5 mm) longer on E50DS4, see Dimensions on **Page V8-T2-65**.

E50 Heavy-Duty Plug-In Switches, Operating Heads, continued

Description	Travel to Operate Contacts	Travel to Reset Contacts	Total Travel	Force to Operate Contacts	Minimum Return Force	Operating Temperature ①		Catalog Number
						Without Cable	With Pre-wired Cable	
Top Push Roller								
Top Push Roller								
Spring return	0.040 in	0.020 in	0.280 in	4 lbs	8 oz	14° to 250°F (-10° to 121°C)	14° to 221°F (-10° to 105°C)	E50DT3
Wobble Head, Spring Return (requires a wobble operator, see Page V8-T2-79)								
Standard duty	10°	6°	15°	2 in-lbs	2.4 in-oz	14° to 250°F (-10° to 121°C)	14° to 221°F (-10° to 105°C)	E50DW1
Heavy-duty high strength steel	10°	6°	15°	2 in-lbs	2.4 in-oz	14° to 250°F (-10° to 121°C)	14° to 221°F (-10° to 105°C)	E50DW2



Switch Bodies

E50 Heavy-Duty Plug-In Switches, Switch Bodies



Switch Body Construction ①	Single-Pole 1N0-1NC Catalog Number	Two-Pole 2N0-2NC Parallel Wired Indicator Light Catalog Number	Two-Pole 2NC-1N0 Series Wired Indicator Light Catalog Number
Without indicating light	E50SA CE	E50SB	—
With LED indicating light 24–120 Vac/dc	E50SAL	E50SBL	E50SCL
With neon indicating light 120 Vac	E50SAN	E50SBN	—

Circuit Diagrams, see [Page V8-T2-64](#).









Note

① Indicating lights are supplied from the factory wired as shown in Circuit Diagrams on [Page V8-T2-64](#). However, they can be easily re-connected to terminals 1 and 2 if necessary (SPDT).

Receptacles

2

E50 Heavy-Duty Plug-In Switches, Receptacles

	Description	Poles	Conduit Entrance	Cable Length	Catalog Number
Surface Mount 	Surface Mount				
	Conduit entrance, front or rear mounting	Single-pole (5 terminal)	1/2 NPT	—	E50RA
			20 mm	—	E50RA20
		Two-pole (9 terminal)	1/2 NPT	—	E50RB
			3/4 NPT	—	E50RB34
20 mm			—	E50RB20	
Manifold Mount 	Manifold Mount				
	Rear wiring entrance instead of conduit hole, gasket on back for oil tightness	Single-pole (5 terminal)	—	—	E50RAM
			Two-pole (9 terminal)	—	E50RBM
Mini-Connector 	Mini-Connector				
	Epoxy filled receptacle with pre-wired mini-connector. (The -W version is a wiring scheme typically used in automotive applications.)	Single-pole (5 terminal)	5-pin mini-connector	—	E50RAP5 
				—	E50RAP5-W 
Two-pole (9 terminal)	9-pin mini-connector	—	E50RBP9 		
Micro-Connector 	Micro-Connector				
	Epoxy filled receptacle with M12 DC micro-connector	Single-pole (5 terminal)	—	—	E50RAA5 
Pre-Wired Cable 	Pre-Wired Cable				
	Epoxy filled receptacle with pre-wired 16 gauge, yellow jacketed, type SOOW-A cable. Cable enters through hole threaded for conduit.	Single-pole (5 terminal)	1/2 NPT	8 ft	E50RAS
				12 ft	E50RAS12
				20 ft	E50RAS20
		20 mm	1/2 NPT	8 ft	E50RA20S
				12 ft	E50RA20S12
				20 ft	E50RA20S20
	Two-pole (9 terminal)	1/2 NPT	8 ft	E50RBS	
			12 ft	E50RBS12	
			20 ft	E50RBS20	
20 mm			8 ft	E50RB20S	
			12 ft	E50RB20S12	
			20 ft	E50RB20S20	

Wiring Diagrams, see [Page V8-T2-64](#).





Notes

 See listing of compatible connector cables on [Page V8-T2-61](#).

 Model E50RAA5 is not UL listed or CSA certified.



Compatible Connector Cables

Standard Cables ^①

	Current Rating at 600V	Voltage Style	Number of Pins	Gauge	Length	Pin Configuration/Wire Colors (Face View Female Shown)	Catalog Number
Mini-style Straight Female 	Mini-Style, Straight Female						
	8A	—	5-pin	16 AWG	6 ft (2m)	 <ul style="list-style-type: none"> 1-White 2-Red 3-Green 4-Orange 5-Black 	CSMS5D5CY1602
	7A	—	9-pin	16 AWG	12 ft (4m)	 <ul style="list-style-type: none"> 1-Orange 2-Blue 3-Red/Black 4-Green/Black 5-White 6-Red 7-Green 8-White/Black 9-Black 	CSMS9D9CY1602
Micro-Style 	Micro-Style						
	4A	—	5-pin, 5-wire	22 AWG	6.0 ft (2m)	 <ul style="list-style-type: none"> 1-Brown 2-White 3-Blue 4-Black 5-Green/Yellow 	CSDS5A5CY2202

Accessories

E50 Heavy-Duty Plug-In Switch Accessories





	Description	Catalog Number
E50KH7 	Adapter Plate	
	Allows E50 to replace Square D Type AW Surface Mounting Non Plug-In Standard Box Limit Switch	E50KH7
E50KH4 	Allows E50 to replace National Acme, Type D-1200M, Style 2 Mounting. Denison LoxSwitch, Model L-100W, Style 2 Mounting. Square D 9007 Type T, Style B Mounting. (Adapter plate is 1/8 in thick, with 1/4 in mounting holes.) Namco® long mount.	E50KH4 ^①
E50KH5 	Allows E50 to replace National Acme, Type D-1200M, Style 1 Mounting. Denison LoxSwitch, Model L-100W, Style 1 Mounting. Square D 9007 Type T, Style C mounting. (Adapter plate is 1/8 in thick, with 1/4 in mounting holes.)	E50KH5 ^①

Dimensions, see **Page V8-T2-66**.

Note

^① For a full selection of connector cables, see **Tab 10, section 10.1**.

E50 Heavy-Duty Plug-In Switch Accessories, continued

Description	Catalog Number
Adapter Plate, continued	
E50KH2  A rectangular metal plate with four mounting holes, two on each long side.	Allows E50 to replace Eaton's 10316 Type LT Non Plug-In Two-Pole Limit Switch E50KH2
E50KH10  A rectangular metal plate with a circular hole on the left side and two smaller circular holes below it.	Allows E50 to replace Allen-Bradley 802M Sealed Limit Switch E50KH10
Adjustable Mounting Plate	
E50KH3  A rectangular metal plate with a central circular hole and two side slots, accompanied by several screws and nuts.	This is a mounting plate only 5/16 in thick and includes the proper mounting bolts and nuts. The slots in the plate allow a maximum horizontal adjustment of 1 in and vertical adjustment of 1-1/4 in E50KH3 ①
E50KH6  A blue, ring-shaped plastic or rubber seal with a metal flange on one side.	Conduit Sealing Nut 1/2 in oiltight E50KH6

Dimensions, see **Page V8-T2-66**.

Note

① Limit switch not included.

Technical Data and Specifications

E50 Heavy-Duty Plug-In Switches

Description	Specification
Environmental ratings	NEMA 1, 3, 3S, 4, 4X, 6, 6P, 13, IP67
Material of construction	Zinc die cast
Switch gasket material	Viton
Universal U.S./DIN mounting dimensions	1.16 in (30 mm) x 2.34 in (60 mm)
Conduit entrance	1/2 in NPT or 20 mm threading
Contact ratings	See below
Contact operation	Snap action over center mechanism
Contact material	Fine silver
Maximum frequency of operation	8000 operations per hour
Mechanical life	
Side rotary	13,000,000 operations minimum
Side or top push	10,000,000 operations minimum
Electrical life	
Single-pole	1,000,000 operations typical at full load
Two-pole	100,000 operations typical at full load

E50 Heavy-Duty Plug-In Switches, continued

Description	Specification
Ambient temperature range—standard	
Standard without cable	14° to 250°F (–10° to 121°C)
Standard with cable	14° to 221°F (–10° to 105°C)
Low temperature without cable	–40° to 250°F (–40° to 121°C)
Low temperature with cable	–40° to 221°F (–40° to 105°C)
Repeat accuracy—standard	
Side operated	Within 0.0012 in
Top operated	Within 0.0003 in
Side rotary	Within 0.0014 in
Torque requirements:	
Switch body screws	25–30 lb-in
Operating head screws	14–18 lb-in
Wire size	Will accept AWG #22–#12, single or stranded wire

Electrical Data—Maximum Contact Ratings (Same polarity each pole)

AC Volts	Current, Amperes			Voltamperes		DC Volts	Current, Amperes	
	Make	Break	Cont. ①	Make	Break		Max. Make or Break	Cont. ①
All Switches Except Gravity Return and Indicating Light Versions								
NEMA A600 Rating						NEMA R300		
120	60	6	10	7200	720	125	0.22	1.0
240	30	3	10	7200	720	250	0.11	1.0
480	15	1.5	10	7200	720	250	0.11	1.0
600	12	1.2	10	7200	720	250	0.11	1.0
Switches with Indicating Lights (LED or Neon)								
NEMA A150 Rating						NEMA R150		
120	60	6	10	7200	720	125	0.22	1.0
Gravity Return Switches—Maximum Contact Ratings								
NEMA 6600 Rating—Contacts on same polarity								
120	30	3	5	3600	360	—	—	—
240	15	1.5	5	3600	360	—	—	—
480	7.5	0.75	5	3600	360	—	—	—
600	6	0.60	5	3600	360	—	—	—

Note

① Thermal rating. Valid only if switch does not have to make or break.

2.6

Limit Switches

E50 Heavy-Duty Plug-In Switches

Circuit Diagrams

Standard Assembled Switches and Switch Bodies

2

Single-Pole 1NO-1NC

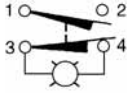

Must be same polarity.

Two-Pole 2NO-2NC

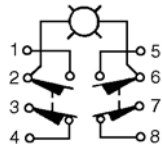

Parallel wired indicator light.
Same polarity each pole.

Two-Pole 1NO-2NC

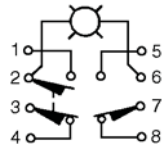

Series wired indicator light.
Same polarity each pole.

Special Purpose Assembled Switches

Neutral Position

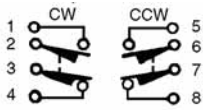

Same polarity, each pole.

Two-Step (CW, CCW, or Both)

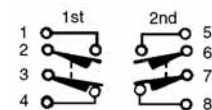

Same polarity, each pole.

Gravity Return



Must be same polarity.

Wiring Diagrams

Receptacles ①

E50RAP5

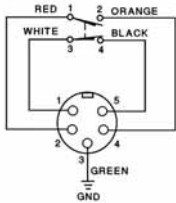

E50RAP5-W

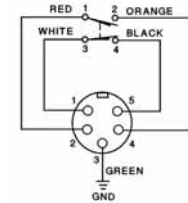

E50RBP9

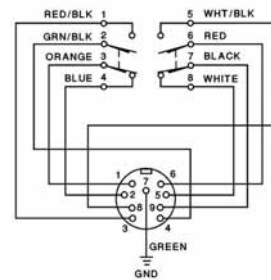

E50RAA5

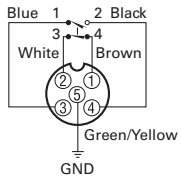

E50RAS_

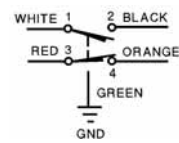

E50RBS_

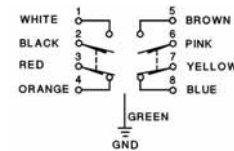

Note

① The wire colors referenced on these diagrams are those internal to the switch itself.

Dimensions

Approximate Dimensions in Inches (mm)

Standard

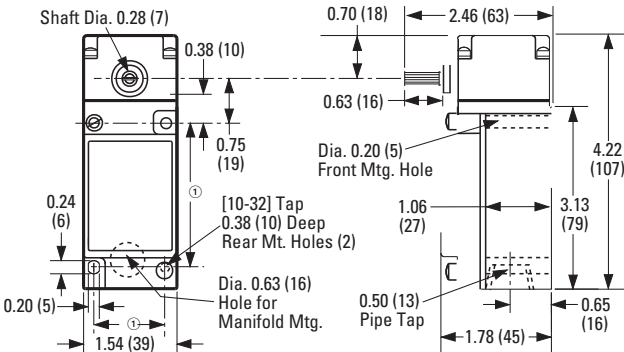

E50SB34

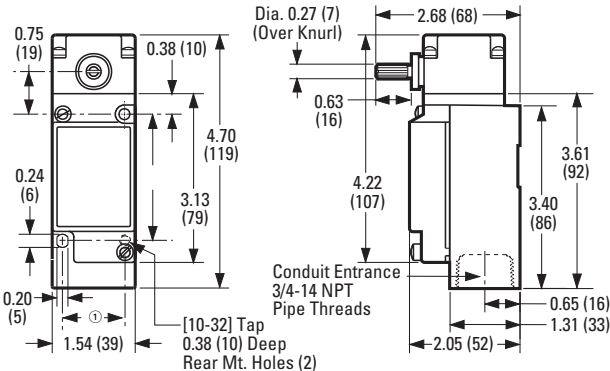

Side Push Operators

Approximate Dimensions in mm [in]

Pushbutton

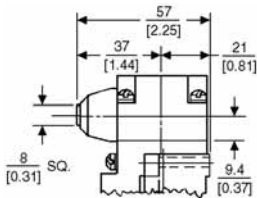

Adjustable Pushbutton

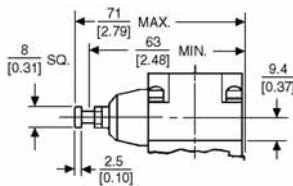

Roller

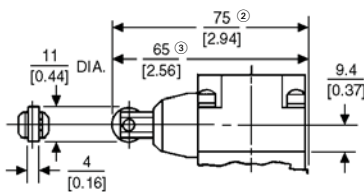

Maintained Pushbutton

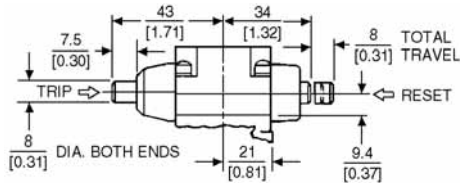

Top Push Operators

Pushbutton

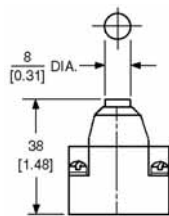

Adjustable Pushbutton

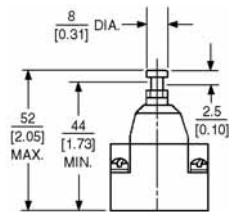

Roller

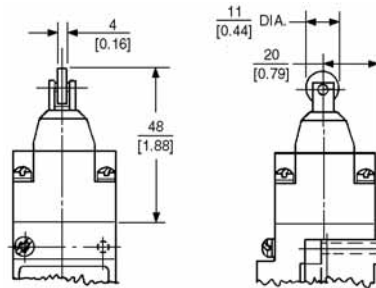

Wobble Operators

See Operators on Page V8-T2-79.

Notes

- ① Can accommodate both U.S., 1.16 (29.4) x 2.34 (59.5) and DIN, 1.18 (30) x 2.36 (60), mounting dimensions.
- ② For E50DS4.
- ③ For E50DS3.

2.6

Limit Switches

E50 Heavy-Duty Plug-In Switches

Accessories

Approximate Dimensions in mm [in]

2

Adapter Plates

E50KH1M

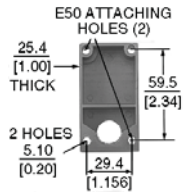

E50KH7

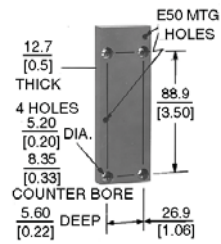

E50KH4

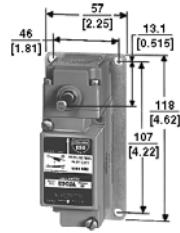

E50KH5

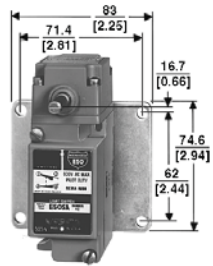

E50KH2

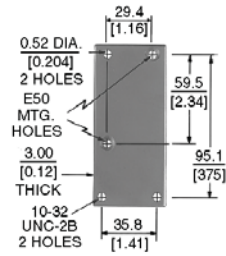

E50KH10

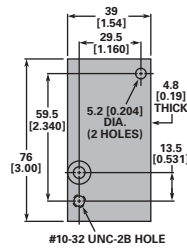

Adjustable Mounting Plate

E50KH3

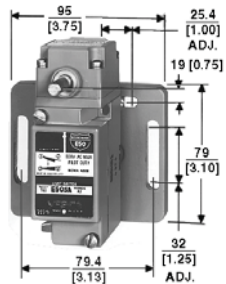

E50 Heavy-Duty Factory Sealed 6P+ Switches



Contents

Description

Page

E50 Heavy-Duty Factory Sealed 6P+ Switches	
Product Selection	
Assembled Switches—Standard	V8-T2-68
Operating Heads	V8-T2-71
Switch Bodies	V8-T2-72
Compatible Connector Cables	V8-T2-73
Accessories	V8-T2-73
Technical Data and Specifications	V8-T2-75
Circuit Diagrams	V8-T2-76
Wiring Diagrams	V8-T2-76
Dimensions	V8-T2-77

 Drawings Online

E50 Heavy-Duty Factory Sealed 6P+ Switches

Product Description

E50 6P+ Limit Switches by Eaton’s electrical sector were specifically designed to withstand the penetrating properties of cutting fluids and coolants, such as those used in the automotive industry, as well as extreme shock, vibration and temperature fluctuations. The one-piece, epoxy filled switch body is prewired at the factory to ensure leak-proof, submersible performance. This unique construction positively stops fluid from finding its way to any and all critical connections.

Our 6P+ switches can be ordered in separate components or as complete assembled devices. They are available with prewired 16 AWG cables or mini-connectors. Standard and custom cable lengths are available. As part of the E50 line, the 6P+ switches use the same operating heads as the standard E50 plug-in models to reduce the components you need to inventory.

Features

- Manufactured to take the physical and environmental abuse (including cutting fluids and chemicals) of harsh industrial environments
- Modular, plug-in components (head and switch body) provide application flexibility, reduced inventory and less downtime
- Chemical resistant Viton gaskets, seals and boots are standard, and so are captive, posi-drive screws
- A special internal seal on the switch body prevents fluid from entering even when the operating head is not attached
- 600V rating, ridge-topped contacts and wiping action assure continuity even to logic level circuits
- Factory wired cable features a 350 pound pullout capacity
- Keyed, four direction head positioning. Standard 5° pre-travel and 90° total travel
- 24–120 Vac/dc LED and 120 Vac neon indicating lights available
- Rotary heads are field convertible CW, CCW, or both, without special tools

Standards and Certifications

- UL Listed, E170645
- CSA Certified, 50513
- CE (where shown)
- RoHS Compliant



 DANGER

THIS SENSOR IS NOT A SAFETY DEVICE AND IS NOT INTENDED TO BE USED AS A SAFETY DEVICE. This sensor is designed only to detect and read certain data in an electronic manner and perform no use apart from that, specifically no safety-related use. This sensor product does not include self-checking redundant circuitry, and the failure of this sensor product could cause either an energized or de-energized output condition, which could result in death, serious bodily injury, or property damage.

For the most current information on this product, visit our Web site: www.eaton.com

For Customer Service in the U.S. call 1-877-ETN CARE (386-2273), in Canada call 1-800-268-3578. For Application Assistance in the U.S. and Canada call 1-800-426-9184.

Product Selection

2

Assembled Switches—Standard

Connection is by 8 ft cable ①.

Assembled Switch E50 Heavy-Duty Factory Sealed 6P+ Switches, Assembled—Standard



Lever sold separately



Single-Pole



Two-Pole

Indicating Light:	None	LED (24–120 Vac/dc)	Neon (120 Vac)	None	LED (24–120 Vac/dc)	Neon (120 Vac)
Switch Body:	E50SA6P 1NO-1NC	E50SAL6P 1NO-1NC	E50SAN6P 1NO-1NC	E50SB6P 2NO-2NC	E50SBL6P 2NO-2NC	E50SBN6P 2NO-2NC

Operating Head Type ②

Side Rotary



Description	Assembled Switch Catalog Number			Assembled Switch Catalog Number		
Side Rotary (requires an operating lever, see Page V8-T2-79)						
Standard spring return—E50DR1 ③	E50AR16P CE	E50ALR16P	E50ANR16P	E50BR16P	E50BLR16P	E50BNR16P
Low force spring return—E50DL1 ③	E50AL16P CE	E50ALL16P	E50ANL16P	E50BL16P	E50BLL16P	E50BNL16P
Maintained two-position—E50DM1	E50AM16P CE	E50ALM16P	E50ANM16P	E50BM16P	E50BLM16P	E50BNM16P

Spring Return



Spring return—E50DS1	E50AS16P CE	E50ALS16P	E50ANS16P	E50BS16P	E50BLS16P	E50BNS16P
----------------------	----------------	-----------	-----------	----------	-----------	-----------

Adjustable Spring Return



Adjustable spring return—E50DS2	E50AS26P CE	E50ALS26P	E50ANS26P	E50BS26P	E50BLS26P	E50BNS26P
---------------------------------	----------------	-----------	-----------	----------	-----------	-----------

Circuit Diagrams, see Page V8-T2-76.

Notes

① Connection options (add the code suffix from the table below to the end of the catalog number):

Option		Catalog Number	Code Suffix
Mini-connector ④	Single-pole (5-pin mini-connector)	CSMS5D5CY1602	C
	Two-pole (9-pin mini-connector)	CSMS9D9CY1602	C
Cable connection	12 ft cable length (standard)	—	12
	20 ft cable length (standard)	—	20
	Other lengths (special order)	—	Length in ft

② For operating head specifications, see Page V8-T2-71.

③ CW (clockwise) and CCW (counterclockwise) operation, easily convertible to CW only or CCW only operation.

④ For a full selection of connector cables, see Tab 10, section 10.1.

Connection is by 8 ft cable ①.

E50 Heavy-Duty Factory Sealed 6P+ Switches, Assembled—Standard, continued

Assembled Switch



Lever sold separately



Single-Pole



Two-Pole

Indicating Light:	None	LED (24–120 Vac/dc)	Neon (120 Vac)	None	LED (24–120 Vac/dc)	Neon (120 Vac)
Switch Body:	E50SA6P 1NO-1NC	E50SAL6P 1NO-1NC	E50SAN6P 1NO-1NC	E50SB6P 2NO-2NC	E50SBL6P 2NO-2NC	E50SBN6P 2NO-2NC

Operating Head Type ②

Description	Assembled Switch Catalog Number			Assembled Switch Catalog Number		
-------------	---------------------------------	--	--	---------------------------------	--	--

Side Push Roller



Side Push Roller						
-------------------------	--	--	--	--	--	--

Spring return— E50DS3 ③	E50AS36P CE	E50ALS36P	E50ANS36P	E50BS36P	E50BLS36P	E50BNS36P
----------------------------	----------------	-----------	-----------	----------	-----------	-----------

Side Pushbutton



Side Pushbutton						
------------------------	--	--	--	--	--	--

Maintained— E50DH1	E50AH16P CE	E50ALH16P	E50ANH16P	E50BH16P	E50BLH16P	E50BNH16P
-----------------------	----------------	-----------	-----------	----------	-----------	-----------

Top Pushbutton

Spring Return



Spring return— E50DT1	E50AT16P CE	E50ALT16P	E50ANT16P	E50BT16P	E50BLT16P	E50BNT16P
--------------------------	----------------	-----------	-----------	----------	-----------	-----------

Adjustable Spring Return



Adjustable spring return—E50DT2	E50AT26P CE	E50ALT26P	E50ANT26P	E50BT26P	E50BLT26P	E50BNT26P
------------------------------------	----------------	-----------	-----------	----------	-----------	-----------

Circuit Diagrams, see Page V8-T2-76.

Notes

① Connection options (add the code suffix from the table below to the end of the catalog number):

Option		Catalog Number	Code Suffix
Mini-connector ④	Single-pole (5-pin mini-connector)	CSMS5D5CY1602	C
	Two-pole (9-pin mini-connector)	CSMS9D9CY1602	C
Cable connection	12 ft cable length (standard)	—	12
	20 ft cable length (standard)	—	20
	Other lengths (special order)	—	Length in ft

② For operating head specifications, see Page V8-T2-71.

③ Roller can be converted in the field between horizontal and vertical.

④ For a full selection of connector cables, see Tab 10, section 10.1.

2.7

Limit Switches

E50 Heavy-Duty Factory Sealed 6P+ Switches

Connection is by 8 ft cable ①.

2

Assembled Switch

E50 Heavy-Duty Factory Sealed 6P+ Switches, Assembled—Standard, continued



Lever sold separately



Single-Pole



Two-Pole

Indicating Light:	Single-Pole			Two-Pole		
	None	LED (24–120 Vac/dc)	Neon (120 Vac)	None	LED (24–120 Vac/dc)	Neon (120 Vac)
Switch Body:	E50SA6P 1NO-1NC	E50SAL6P 1NO-1NC	E50SAN6P 1NO-1NC	E50SB6P 2NO-2NC	E50SBL6P 2NO-2NC	E50SBN6P 2NO-2NC

Operating Head Type ②

Top Push Roller



Description	Assembled Switch Catalog Number			Assembled Switch Catalog Number		
Top Push Roller						
Spring return— E50DT3	E50AT36P CE	E50ALT36P	E50ANT36P	E50BT36P	E50BLT36P	E50BNT36P

Wobble Head, Spring Return



Wobble Head, Spring Return (requires a wobble operator, see Page V8-T2-79)						
Standard duty— E50DW1	E50AW16P CE	E50ALW16P	E50ANW16P	E50BW16P	E50BLW16P	E50BNW16P
Heavy-duty high strength steel— E50DW2	E50AW26P CE	E50ALW26P	E50ANW26P	E50BW26P	E50BLW26P	E50BNW26P

Circuit Diagrams, see Page V8-T2-76.

Notes

① Connection options (add the code suffix from the table below to the end of the catalog number):

Option		Catalog Number	Code Suffix
Mini-connector ③	Single-pole (5-pin mini-connector)	CSMS5D5CY1602	C
	Double-pole (9-pin mini-connector)	CSMS9D9CY1602	C
Cable connection	12 ft cable length (standard)	—	12
	20 ft cable length (standard)	—	20
	Other lengths (special order)	—	Length in ft







② For operating head specifications, see Page V8-T2-71.

③ For a full selection of connector cables, see Tab 10, section 10.1.

E50 Heavy-Duty Factory Sealed 6P+ Switches

Operating Heads

E50 Heavy-Duty Factory Sealed 6P+ Switches, Operating Heads

Description	Travel to Operate Contacts	Travel to Reset Contacts	Total Travel	Force to Operate Contacts	Minimum Return Force	Operating Temperature ^①		Catalog Number	
						Without Cable	With Pre-wired Cable		
Side Rotary									
Side Rotary (requires an operating lever, see Page V8-T2-79)									
 Standard spring return ^②	5°	2°	90°	3 in-lbs	4.5 in-oz	10° to 200°F (-12° to 94°C) ^③	10° to 200°F (-12° to 94°C) ^③	E50DR1	
Low temperature spring return ^②	5°	2°	90°	3 in-lbs	4.5 in-oz	-40° to 175°F (-40° to 79°C)	-31° to 175°F (-34° to 79°C)	E50DR19	
Low force spring return ^②	15°	6°	90°	1.5 in-lbs	2.5 in-oz	10° to 200°F (-12° to 94°C) ^③	10° to 200°F (-12° to 94°C) ^③	E50DL1	
Maintained two-position	50°	50°	90°	3 in-lbs	—	14° to 200°F (-10° to 94°C)	14° to 200°F (-10° to 94°C)	E50DM1	
Side Pushbutton									
 Spring return	0.065 in	0.030 in	0.250 in	4 lbs	8 oz	14° to 200°F (-10° to 94°C)	14° to 200°F (-10° to 94°C)	E50DS1	
Adjustable Spring Return	Adjustable spring return	0.065 in	0.030 in	0.250 in	4 lbs	8 oz	14° to 200°F (-10° to 94°C)	14° to 200°F (-10° to 94°C)	E50DS2
									
Side Push Roller									
 Spring return ^④	0.065 in	0.030 in	0.250 in	4 lbs	8 oz	14° to 200°F (-10° to 94°C)	14° to 200°F (-10° to 94°C)	E50DS3 ^⑤	
	0.065 in	0.030 in	0.250 in	4 lbs	8 oz	14° to 200°F (-10° to 94°C)	14° to 200°F (-10° to 94°C)	E50DS4 ^⑤	
Side Pushbutton									
 Maintained	0.200 in	0.130 in	0.320 in	5 lbs	5 lbs	14° to 200°F (-10° to 94°C)	14° to 200°F (-10° to 94°C)	E50DH1	
Top Pushbutton									
 Spring return	0.040 in	0.020 in	0.280 in	4 lbs	8 oz	14° to 250°F (-10° to 121°C)	14° to 221°F (-10° to 105°C)	E50DT1	
Adjustable Spring Return	Adjustable spring return	0.040 in	0.020 in	0.280 in	4 lbs	8 oz	14° to 250°F (-10° to 121°C)	14° to 221°F (-10° to 105°C)	E50DT2
									

Notes

- ① Temperature ranges below 32°F (0°C) are based on absence of freezing moisture or water.
- ② CW (clockwise) and CCW (counterclockwise) operation, easily convertible to CW only or CCW only operation.
- ③ For CW and CCW operation. For CW only or CCW only operation, high temperature limit increases to 250°F (121°C) without cable, and 221°F (105°C) with pre-wired cable.
- ④ Roller can be converted in the field between horizontal and vertical.
- ⑤ Roller shaft is 0.38 in (9.5 mm) longer on E50DS4, see Dimensions on **Page V8-T2-77**.

E50 Heavy-Duty Factory Sealed 6P+ Switches, Operating Heads, continued

Description	Travel to Operate Contacts	Travel to Reset Contacts	Total Travel	Force to Operate Contacts	Minimum Return Force	Operating Temperature ^①		Catalog Number
						Without Cable	With Pre-Wired Cable	
Top Push Roller								
Top Push Roller								
Spring return	0.040 in	0.020 in	0.280 in	4 lbs	8 oz	14° to 250°F (-10° to 121°C)	14° to 221°F (-10° to 105°C)	E50DT3
Wobble Head, Spring Return (requires a wobble operator, see Page V8-T2-79)								
Standard duty	10°	6°	15°	2 in-lbs	2.4 in-oz	14° to 250°F (-10° to 121°C)	14° to 221°F (-10° to 105°C)	E50DW1
Heavy-duty high strength steel	10°	6°	15°	2 in-lbs	2.4 in-oz	14° to 250°F (-10° to 121°C)	14° to 221°F (-10° to 105°C)	E50DW2
Circuit Diagrams, see Page V8-T2-76.								

Switch Bodies

E50 Heavy-Duty Factory Sealed 6P+, Switch Bodies

Circuit	Switch Body Construction	Cable Length	Catalog Number	
Pre-Wired Cable				
Single-pole 1NO-1NC	Without indicating light	8 ft	E50SA6P	
		12 ft	E50SA6P12	
		20 ft	E50SA6P20	
	With LED indicating light 24–120 Vac/dc	8 ft	E50SAL6P	
		12 ft	E50SAL6P12	
		20 ft	E50SAL6P20	
	With neon indicating light 120 Vac	8 ft	E50SAN6P	
		12 ft	E50SAN6P12	
		20 ft	E50SAN6P20	
	Two-pole 2NO-2NC	Without indicating light	8 ft	E50SB6P
			12 ft	E50SB6P12
			20 ft	E50SB6P20
With LED indicating light 24–120 Vac/dc		8 ft	E50SBL6P	
		12 ft	E50SBL6P12	
		20 ft	E50SBL6P20	
With neon indicating light 120 Vac		8 ft	E50SBN6P	
		12 ft	E50SBN6P12	
		20 ft	E50SBN6P20	
Mini-Connector				
Single-pole 1NO-1NC	Without indicating light normal wiring	—	E50SA6PC ☼	
	Without indicating light alternate wiring	—	E50SA6PC-W ☼	
	With LED indicating light 24–120 Vac/dc	—	E50SAL6PC ☼	
	With neon indicating light 120 Vac	—	E50SAN6PC ☼	
Two-pole 2NO-2NC	Without indicating light	—	E50SB6PC ☼	
	With LED indicating light 24–120 Vac/dc	—	E50SBL6PC ☼	
	With neon indicating light 120 Vac	—	E50SBN6PC ☼	



Notes

☼☼ See listing of compatible connector cables on **Page V8-T2-73**.

① Temperature ranges below 32°F (0°C) are based on absence of freezing moisture or water.





Compatible Connector Cables

Standard Cables ①

	Current Rating at 600V	Voltage Style	Number of Pins	Gauge	Length	Pin Configuration/Wire Colors (Face View Female Shown)	Catalog Number
 <p>Mini-Style, Straight Female</p>	Mini-Style, Straight Female						
	8A	—	5-pin	16 AWG	6 ft (2m)	 <p>1-White 2-Red 3-Green 4-Orange 5-Black</p>	CSMS5D5CY1602
	7A	—	9-pin	16 AWG	12 ft (4m)	 <p>1-Orange 2-Blue 3-Red/Black 4-Green/Black 5-White 6-Red 7-Green 8-White/Black 9-Black</p>	CSMS9D9CY1602

Accessories

E50 Heavy-Duty Factory Sealed 6P+ Switch Accessories

		Catalog Number
<p>E50KH1M</p> 	<p>Adapter Plate</p> <p>Allows E50 to replace Eaton's 10316 Type LP Manifold Mounting Plug-In Limit Switch</p>	E50KH1M
<p>E50KH7</p> 	<p>Allows E50 to replace Square D Type AW Surface Mounting Non Plug-In Standard Box Limit Switch</p>	E50KH7
<p>E50KH4</p> 	<p>Allows E50 to replace National Acme, Type D-1200M, Style 2 Mounting. Denison LoxSwitch, Model L-100W, Style 2 Mounting. Square D 9007 Type T, Style B Mounting. (Adapter plate is 1/8 in thick, with 1/4 in mounting holes.) Namco® long mount.</p>	E50KH4 ①
<p>E50KH5</p> 	<p>Allows E50 to replace National Acme, Type D-1200M, Style 1 Mounting. Denison LoxSwitch, Model L-100W, Style 1 Mounting. Square D 9007 Type T, Style B mounting. (Adapter plate is 1/8 in thick, with 1/4 in mounting holes.)</p>	E50KH5 ①

Dimensions, see **Page V8-T2-77**.

Note

① For a full selection of connector cables, see **Tab 10, section 10.1**.

E50 Heavy-Duty Factory Sealed 6P+ Switch Accessories, continued

Catalog Number

Adapter Plate, continued

E50KH2

Allows E50 to replace Eaton's 10316 Type LT Non Plug-In Two-Pole Limit Switch

E50KH2



E50KH10

Allows E50 to replace Allen-Bradley 802M Sealed Limit Switch

E50KH10

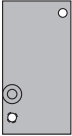

Adjustable Mounting Plate

E50KH3

This is a mounting plate only 5/16 in thick and includes the proper mounting bolts and nuts. The slots in the plate allow a maximum horizontal adjustment of 1 in and vertical adjustment of 1-1/4 in

E50KH3 ①

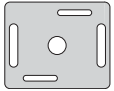

Conduit Sealing Nut

E50KH6

1/2 in oiltight

E50KH6



Dimensions, see **Page V8-T2-77**.

Note

① Limit switch not included.

Technical Data and Specifications

E50 Heavy-Duty Factory Sealed 6P+ Switches

Description	Specification
Environmental ratings	NEMA 1, 3, 3S, 4, 4X, 6, 6P, 13, IP67, IP69
Material of construction	Zinc die cast
Switch gasket material	Viton
Universal U.S./DIN mounting dimensions	1.16 in (30 mm) x 2.34 in (60 mm)
Conduit entrance	1/2 in NPT or 20 mm threading
Contact ratings	See below
Contact operation	Snap action over center mechanism
Contact material	Fine silver
Maximum frequency of operation	8000 operations per hour
Mechanical life	
Side rotary	13,000,000 operations minimum
Side or top push	10,000,000 operations minimum
Electrical life	
Single-pole	1,000,000 operations typical at full load
Double-pole	100,000 operations typical at full load
Ambient temperature range—standard	
Standard without cable	14° to 250°F (–10° to 121°C)
Standard with cable	14° to 221°F (–10° to 105°C)
Low temperature without cable	–40° to 250°F (–40° to 121°C)
Low temperature with cable	–40° to 221°F (–40° to 105°C)
Repeat accuracy—standard	
Side operated	Within 0.0012 in
Top operated	Within 0.0003 in
Side rotary	Within 0.0014 in
Torque requirements	
Operating head screws	14–18 lb-in

Electrical Data—Maximum Contact Ratings (Same polarity each pole)

AC Volts	Current, Amperes			Voltamperes		DC Volts	Current, Amperes	
	Make	Break	Cont. ①	Make	Break		Max. Make or Break	Cont. ①
All Switches Except Gravity Return and Indicating Light Versions								
NEMA A600 Rating						NEMA R300		
120	60	6	10	7200	720	125	0.22	1.0
240	30	3	10	7200	720	250	0.11	1.0
480	15	1.5	10	7200	720	250	0.11	1.0
600	12	1.2	10	7200	720	250	0.11	1.0
Switches with Indicating Lights (LED or Neon)								
NEMA A150 Rating						NEMA R150		
120	60	6	10	7200	720	125	0.22	1.0

Note

① Thermal rating. Valid only if switch does not have to make or break.

2.7

Limit Switches

E50 Heavy-Duty Factory Sealed 6P+ Switches

2

Circuit Diagrams ①

Standard Assembled Switches

Single-Pole 1NO-1NC

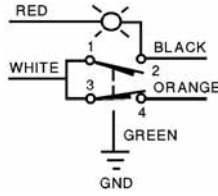
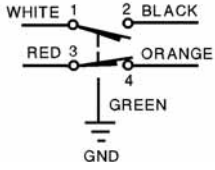

Two-Pole 2NO-2NC

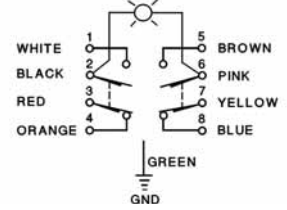
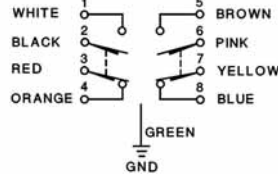

Must be same polarity.

Same polarity, each pole.

Switch Bodies

Pre-Wired Cable—Single-Pole 1NO-1NC

E50SA6P_

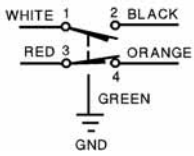

E50SAL6P_

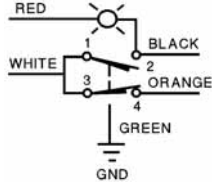

E50SB6P_

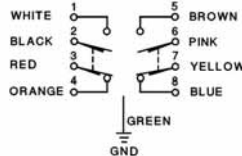

E50SBL6P_

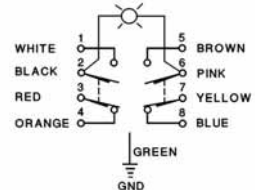

Wiring Diagrams ①

Mini-Connector—Single-Pole 1NO-1NC

E50SA6PC

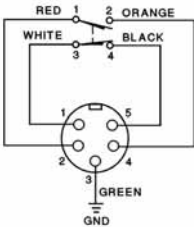

E50SA6PC-W

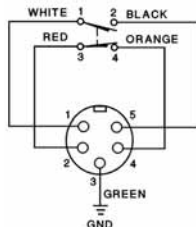

E50SAL6PC/E50SAN6PC

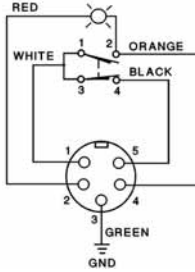

Mini-Connector—Two-Pole 2NO-2NC

E50SB6PC

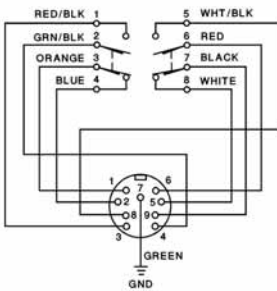

E50SBL6PC/E50SBN6PC

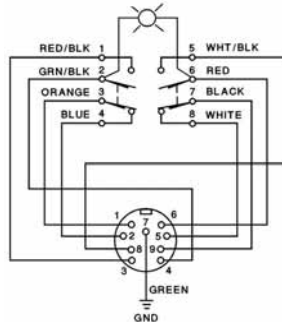

Note

① The wire colors referenced on these diagrams are those internal to the switch itself.

Dimensions

Approximate Dimensions in Inches (mm)

Standard

6P+ Limit Switch with Rotary Operating Head

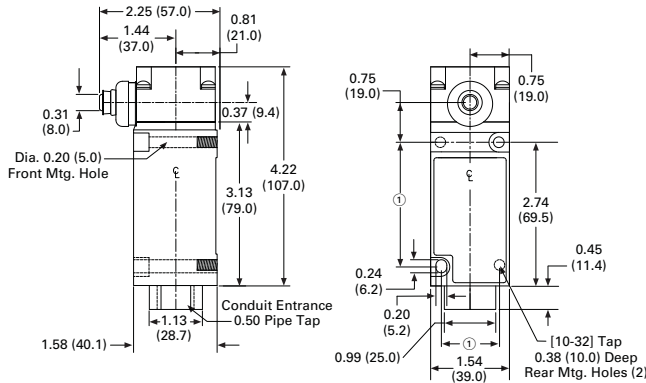

Side Push Operators

Approximate Dimensions in mm [in]

Pushbutton

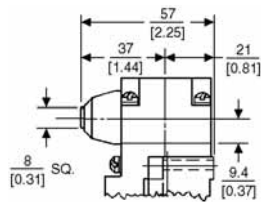

Adjustable Pushbutton

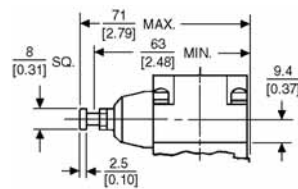

Roller

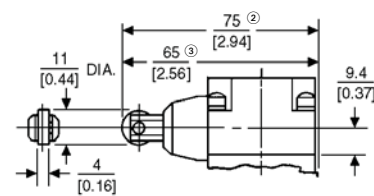

Maintained Pushbutton

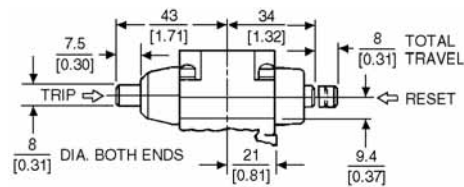

Top Push Operators

Pushbutton

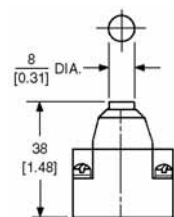

Adjustable Pushbutton

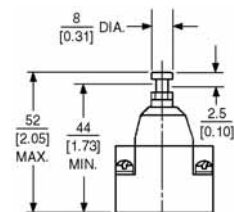

Roller

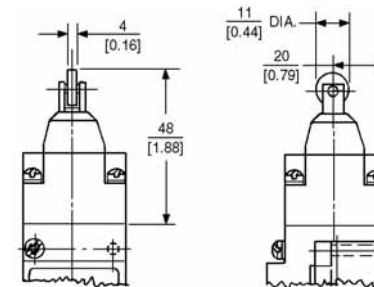

Wobble Operators

See Operators on **Page V8-T2-79**.

Notes

- ① Can accommodate both U.S., 1.16 (29.4) x 2.34 (59.5) and DIN, 1.18 (30.0) x 3.26 (60.0), mounting dimensions.
- ② For E50DS4.
- ③ For E50DS3.

Accessories

Approximate Dimensions in mm [in]

2

Adapter Plates

E50KH1M

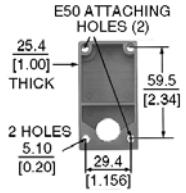

E50KH7

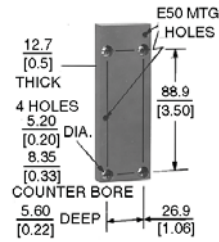

E50KH4

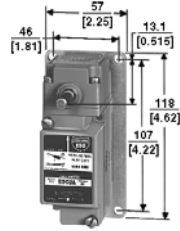

E50KH5

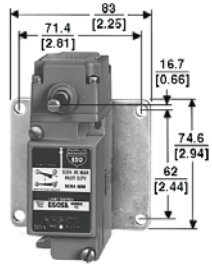

E50KH2

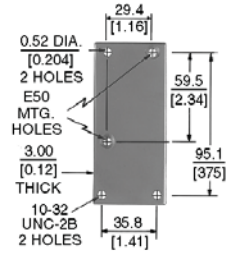

E50KH10

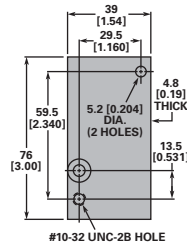

Adjustable Mounting Plate

E50KH3

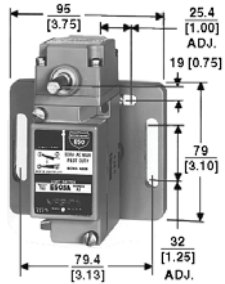

Operators



Contents

Description

Page

Operators	
Product Selection	
Roller Type Operators	V8-T2-80
Rod Type Operators	V8-T2-82
Wobble Type Operators	V8-T2-83
Dimensions	V8-T2-83

 Drawings
Online

Operators

Product Description

The Operators presented here are used with Eaton’s E50 Plug-In and 6P+ limit switches, as well as our 10316 rotary type limit switches. A wide variety of styles and sizes are available to provide optimum performance for nearly any application.

Features

- Wide variety of operator types for rotary and wobble style limit switches
- Rollers and rods available in metal and nonmetal contact surfaces

 DANGER

THIS SENSOR IS NOT A SAFETY DEVICE AND IS NOT INTENDED TO BE USED AS A SAFETY DEVICE. This sensor is designed only to detect and read certain data in an electronic manner and perform no use apart from that, specifically no safety-related use. This sensor product does not include self-checking redundant circuitry, and the failure of this sensor product could cause either an energized or de-energized output condition, which could result in death, serious bodily injury, or property damage.

For the most current information on this product, visit our Web site: www.eaton.com

For Customer Service in the U.S. call 1-877-ETN CARE (386-2273), in Canada call 1-800-268-3578.
For Application Assistance in the U.S. and Canada call 1-800-426-9184.

Product Selection



2

Roller Type Operators

For rotary head switches: E50 Plug-In, E50 6P+, and 10316.





Note: Only operators with Nylatron rods or rollers should be used with explosion-proof limit switches.

Operators—Roller Type



Roller Type	Minimum Required Return Torque ^①	Approximate Dimensions in Inches (mm)						Catalog Number	
		A Lever Length ^②	B Roller Diameter	C Roller Width	D	E	F		
E50KL200	Standard Roller (Stainless Steel)								
	Metal	0.95 in-oz	1.38 (34.9)	0.75 (19.0)	0.32 (8.1)	0.34 (8.6)	0.13 (3.3)	0.17 (4.3)	E50KL40
	Ball bearing	0.77 in-oz	1.50 (38.1)	0.69 (17.5)	0.25 (6.4)	0.34 (8.6)	0.05 (1.3)	0.11 (2.8)	E50KL531
	Nylatron	0.53 in-oz	1.50 (38.1)	0.75 (19.0)	0.32 (8.1)	0.34 (8.6)	0.13 (3.3)	0.17 (4.3)	E50KL200
	Metal	1.10 in-oz	1.50 (38.1)	0.75 (19.0)	0.32 (8.1)	0.34 (8.6)	0.13 (3.3)	0.17 (4.3)	E50KL355
E50KL355	Nylatron	0.96 in-oz	1.50 (38.1)	0.75 (19.0)	1.00 (25.4)	0.34 (8.6)	0.83 (21.1)	0.83 (21.1)	E50KL377
	Without roller	0.32 in-oz	1.50 (38.1)	—	—	0.34 (8.6)	—	—	E50KL132
	Ball bearing	1.10 in-oz	2.00 (50.8)	0.69 (17.5)	0.25 (6.4)	0.34 (8.6)	0.05 (1.3)	0.11 (2.8)	E50KL552
	Nylatron	0.71 in-oz	2.00 (50.8)	0.75 (19.0)	0.32 (8.1)	0.34 (8.6)	0.13 (3.3)	0.17 (4.3)	E50KL546
	Metal	1.50 in-oz	2.00 (50.8)	0.75 (19.0)	0.32 (8.1)	0.34 (8.6)	0.13 (3.3)	0.17 (4.3)	E50KL549
E50KL377	Nylatron	1.45 in-oz	2.00 (50.8)	0.75 (19.0)	1.00 (25.4)	0.34 (8.6)	0.83 (21.1)	0.83 (21.1)	E50KL572
	Ball bearing	1.50 in-oz	2.50 (63.5)	0.69 (17.5)	0.25 (6.4)	0.34 (8.6)	0.05 (1.3)	0.11 (2.8)	E50KL553
	Nylatron	1.00 in-oz	2.50 (63.5)	0.75 (19.0)	0.32 (8.1)	0.34 (8.6)	0.13 (3.3)	0.17 (4.3)	E50KL547
	Metal	2.00 in-oz	2.50 (63.5)	0.75 (19.0)	0.32 (8.1)	0.34 (8.6)	0.13 (3.3)	0.17 (4.3)	E50KL550
	Nylatron	1.80 in-oz	2.50 (63.5)	0.75 (19.0)	1.00 (25.4)	0.34 (8.6)	0.83 (21.1)	0.83 (21.1)	E50KL573
E50KL554	Nylatron	1.40 in-oz	2.50 (63.5)	1.50 (38.1)	0.28 (7.1)	0.34 (8.6)	0.11 (2.8)	0.17 (4.3)	E50KL575
	Ball bearing	1.80 in-oz	3.00 (76.2)	0.69 (17.5)	0.25 (6.4)	0.34 (8.6)	0.05 (1.3)	0.11 (2.8)	E50KL554
	Nylatron	1.30 in-oz	3.00 (76.2)	0.75 (19.0)	0.32 (8.1)	0.34 (8.6)	0.13 (3.3)	0.17 (4.3)	E50KL548
	Metal	2.50 in-oz	3.00 (76.2)	0.75 (19.0)	0.32 (8.1)	0.34 (8.6)	0.13 (3.3)	0.17 (4.3)	E50KL551
	Nylatron	2.30 in-oz	3.00 (76.2)	0.75 (19.0)	1.00 (25.4)	0.34 (8.6)	0.83 (21.1)	0.83 (21.1)	E50KL574
	Nylatron	1.80 in-oz	3.00 (76.2)	1.50 (38.1)	0.28 (7.1)	0.34 (8.6)	0.11 (2.8)	0.17 (4.3)	E50KL576
Dimensions, see Page V8-T2-83.									
E50KL580	Roller On Reverse Side (Stainless Steel)								
	Ball bearing	0.77 in-oz	1.50 (38.1)	0.69 (17.5)	0.25 (6.4)	0.34 (8.6)	0.18 (4.6)	0.24 (6.1)	E50KL580
	Nylatron	0.53 in-oz	1.50 (38.1)	0.75 (19.0)	0.32 (8.1)	0.34 (8.6)	0.27 (6.9)	0.31 (7.9)	E50KL310
	Metal	1.10 in-oz	1.50 (38.1)	0.75 (19.0)	0.32 (8.1)	0.34 (8.6)	0.27 (6.9)	0.31 (7.9)	E50KL579
	Nylatron	0.96 in-oz	1.50 (38.1)	1.50 (38.1)	0.28 (7.1)	0.34 (8.6)	0.23 (5.8)	0.31 (7.9)	E50KL536
E50KL24	Offset Inboard Roller (Stainless Steel)								
	Nylatron	0.65 in-oz	1.50 (38.1)	0.75 (19.0)	0.32 (8.1)	0.03 (0.8)	—	—	E50KL24
	Metal	1.20 in-oz	1.50 (38.1)	0.75 (19.0)	0.32 (8.1)	0.03 (0.8)	—	—	E50KL25
	Ball bearing	0.90 in-oz	1.50 (38.1)	0.69 (17.5)	0.25 (6.4)	0.04 (1.0)	—	—	E50KL26
E50KL27	Offset Outboard Roller (Stainless Steel)								
	Nylatron	0.65 in-oz	1.50 (38.1)	0.75 (19.0)	0.32 (8.1)	0.03 (0.8)	—	—	E50KL27
	Metal	1.20 in-oz	1.50 (38.1)	0.75 (19.0)	0.32 (8.1)	0.03 (0.8)	—	—	E50KL28
	Ball bearing	0.90 in-oz	1.50 (38.1)	0.69 (17.5)	0.25 (6.4)	0.04 (1.0)	—	—	E50KL29
	Nylatron	1.10 in-oz	1.50 (38.1)	0.75 (19.0)	1.00 (25.4)	—	—	—	E50KL30
Dimensions, see Page V8-T2-84.									
Notes									
① Caution: When selecting lever, the minimum required return torque of lever should not exceed minimum return force available in operating head as given in operating head specifications.									
② Length from the operating shaft axis to the roller axis (or to the tip for non-roller operators).									

Note: Only operators with Nylatron rods or rollers should be used with explosion-proof limit switches.

Operators—Roller Type, continued

Roller Type	Minimum Required Return Torque ^①	Approximate Dimensions in Inches (mm)							Catalog Number
		A Lever Length ^②	B Roller Diameter	C Roller Width	D	E	F		
E50KL532									
Bantam Lever									
 Metal	0.45 in-oz	0.69 (17.5)	0.85 (22.0)	0.18 (4.6)	—	—	—		E50KL532
E50KL340									
Precision Adjustment									
 Nylatron	0.65 in-oz	0.69 (17.5)	0.75 (19.0)	0.32 (8.1)	0.48 (12.2)	0.24 (6.1)	0.28 (7.1)		E50KL340
Metal	1.20 in-oz	1.50 (38.1) ^③	0.75 (19.0)	0.32 (8.1)	0.48 (12.2)	0.24 (6.1)	0.28 (7.1)		E50KL465
Ball bearing	0.90 in-oz		0.69 (17.5)	0.25 (6.4)	0.48 (12.2)	0.16 (4.1)	0.22 (5.6)		E50KL535
E50KL201									
Dimensions, see Page V8-T2-84.									
Adjustable Roller (Stainless Steel)									
 Ball bearing	2.50 in-oz ^④	1.0 (25.4) to 3.75 (95.2) ^⑤	0.69 (17.5)	0.25 (6.4)	0.23 (5.8)	0.30 (7.6)	—		E50KL539
Nylatron	1.90 in-oz ^④		0.75 (19.0)	0.32 (8.1)	0.29 (7.4)	0.33 (8.4)	—		E50KL201
			0.75 (19.0)	0.32 (8.1)	0.29 (7.4)	0.33 (8.4)	—		E50KL201SPL ^⑥
 Metal	3.40 in-oz ^④		0.75 (19.0)	0.32 (8.1)	0.29 (7.4)	0.33 (8.4)	—		E50KL538
Nylatron	1.90 in-oz ^④		0.75 (19.0)	0.50 (12.7)	0.46 (11.6)	0.48 (12.2)	—		E50KL599
Nylatron	3.10 in-oz ^④		0.75 (19.0)	1.00 (25.4)	0.90 (22.9)	0.95 (24.1)	—		E50KL537
Large Nylatron	4.50 in-oz ^④	0.5 (12.7) to 3.25 (82.6)	4.00 (102.0)	0.11 (2.8)	0.11 (2.8)	0.19 (4.8)	—		E50KL598
Without roller	1.20 in-oz ^④	0.5 (12.7) to 3.75 (95.2)	—	—	—	—	—		E50KL131
Nylatron	2.50 in-oz ^④	1.63 (41.3) to 3.75 (95.2) ^⑥	1.50 (38.1)	0.29 (7.4)	0.26 (6.6)	0.32 (8.1)	—		E50KL443
Dimensions, see Page V8-T2-85.									

Operators—Fork Lever

Roller Type	Minimum Required Return Torque ^①	Approximate Dimensions in Inches (mm)							Catalog Number
		A Lever Length ^②	B Roller Diameter	C Roller Width	D	E	F	G	
E50KL545									
Fork Lever—Both Rollers on One Side									
 Ball bearing	—	1.50 (38.1)	0.69 (17.5)	0.25 (6.4)	0.08 (2.0)	0.14 (3.6)	—	—	E50KL545
Nylatron	—		0.75 (19.0)	0.32 (8.1)	0.16 (4.1)	0.20 (5.1)	—	—	E50KL204
Metal	—		0.75 (19.0)	0.32 (8.1)	0.16 (4.1)	0.20 (5.1)	—	—	E50KL544
Nylatron	—		0.75 (19.0)	1.00 (25.4)	0.84 (21.3)	0.88 (22.4)	—	—	E50KL543
E50KL542									
Fork Lever—One Roller Outside, One Inside									
 Ball bearing	—	1.50 (38.1)	0.69 (17.5)	0.25 (6.4)	0.08 (2.0)	0.14 (3.6)	0.64 (16.3)	0.70 (17.8)	E50KL542
Nylatron	—		0.75 (19.0)	0.32 (8.1)	0.16 (4.1)	0.20 (5.1)	0.73 (18.5)	0.77 (19.6)	E50KL203
Metal	—		0.75 (19.0)	0.32 (8.1)	0.16 (4.1)	0.20 (5.1)	0.73 (18.5)	0.77 (19.6)	E50KL541
Dimensions, see Page V8-T2-85.									

Notes

- ① **Caution:** When selecting lever, the minimum required return torque of lever should not exceed minimum return force available in operating head as given in operating head specifications.
- ② Length from the operating shaft axis to the roller axis (or to the tip for non-roller operators).
- ③ Maximum length dimension between operating shaft axis to roller axis for comparison. Precision adjustable to lesser dimensions.
- ④ Applies when lever is extended to the maximum dimension.
- ⑤ By reassembling lever, minimum length can be reduced another 0.5 in (12.7 mm).
- ⑥ High-grade stainless steel.



Rod Type Operators

For rotary head switches: E50 Plug-In, E50 6P+, and 10316.





2

Note: Only operators with Nylatron rods or rollers should be used with explosion-proof limit switches.

Operators—Rod Type

Rod Type	Minimum Required Return Torque ^①	Approximate Dimensions in Inches (mm)			Catalog Number
		A Rod Length (Maximum) ^②	B Rod Diameter	C	
Nylon/Metal					
Adjustable Rod					
 Nylon	0.40 in-oz ^③	5.50 (140.0)	0.19 (4.8)		E50KL399
Metal	0.92 in-oz ^③		0.12 (3.2)		E50KL202
Metal	2.20 in-oz ^③	8.75 (222.0)	Rod size (square): 0.12 (3.2) x 0.12 (3.2)		E50KL581
Metal/Steel					
 Stainless steel	7.00 in-oz ^③	9.00 (229.0)	0.19 (4.8)		E50KL220
Bendable steel	5.00 in-oz ^③	12.00 (305.0)	0.12 (3.2)		E50KL226
Clamps for Adjustable Rods (Rod not included)					
Clamp for ...					
					E50KL35
					E50KL36
					E50KL41
Dimensions, see Page V8-T2-86.					

Operators—Rod Type, continued

Rod Type	Minimum Required Return Torque ^①	Approximate Dimensions in Inches (mm)				Catalog Number
		A Rod Length ^②	B Rod Diameter	C	D	
Nylon/Steel						
Spring Rod						
 Nylon	3.50 in-oz	—	—	—	—	E50KL556
Stainless steel	2.80 in-oz	—	—	—	—	E50KL421
Nylon Covered Wire						
Adjustable Wire						
 Nylon covered wire	1.50 in-oz ^③	—	—	—	—	E50KL533
Nylatron						
Adjustable Wide Roller Lever						
 Nylatron	4.50 in-oz ^③	—	—	—	—	E50KL37
Nylatron						
Nylatron Loop						
 Nylatron	0.40 in-oz	6.00 (152.0)	∅: 0.158 (4.0)	—	—	E50KL142
Zinc-Plated Steel						
Eye Bolt						
 Zinc-plated steel	0.53 in-oz	150.00 (38.1)	∅: 0.1875 (4.8) Loop ID: 0.375 (9.5)	0.52 (13.1)	0.24 (8.6)	E50KL33

Dimensions, see Page V8-T2-86.

Notes

- ^① **Caution:** When selecting lever, the minimum required return torque of lever should not exceed minimum return force available in operating head as given in operating head specifications.
- ^② Length from the operating shaft axis to tip.
- ^③ Applies when lever is extended to the maximum dimension.

Wobble Type Operators

For E50DW1 and E50DWZ Operator Heads on E50 Plug-In and E50 6P+ Switches.

Note: Only operators with Nylatron rods or rollers should be used with explosion-proof limit switches.

Operators—Wobble Type

	Wobble Type	Catalog Number
E50KW2	Nylon Rod	E50KW2
E50KW3	Stainless Steel Rod	E50KW3
E50KW4	Coil Spring	E50KW4
Dimensions, see Page V8-T2-86.		

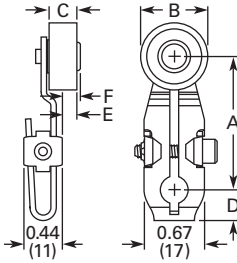
Dimensions**Roller Type Operators****Standard Roller**

Approximate Dimensions in Inches (mm)

Catalog Number	A Lever Length ^①	B Roller Diameter	C Roller Width	D	E	F
E50KL39	0.88 (22.2)	0.75 (19.0)	0.32 (8.1)	0.31 (7.9)	0.20 (5.1)	0.24 (6.1)
E50KL40	1.38 (34.9)	0.75 (19.0)	0.32 (8.1)	0.34 (8.6)	0.13 (3.3)	0.17 (4.3)
E50KL531	1.50 (38.1)	0.69 (17.5)	0.25 (6.4)	0.34 (8.6)	0.05 (1.3)	0.11 (2.8)
E50KL200	1.50 (38.1)	0.75 (19.0)	0.32 (8.1)	0.34 (8.6)	0.13 (3.3)	0.17 (4.3)
E50KL355	1.50 (38.1)	0.75 (19.0)	0.32 (8.1)	0.34 (8.6)	0.13 (3.3)	0.17 (4.3)
E50KL377	1.50 (38.1)	0.75 (19.0)	1.00 (25.4)	0.34 (8.6)	0.83 (21.1)	0.83 (21.1)
E50KL32	1.50 (38.1)	—	—	0.34 (8.6)	—	—
E50KL552	2.00 (50.8)	0.69 (17.5)	0.25 (6.4)	0.34 (8.6)	0.05 (1.3)	0.11 (2.8)
E50KL546	2.00 (50.8)	0.75 (19.0)	0.32 (8.1)	0.34 (8.6)	0.13 (3.3)	0.17 (4.3)
E50KL549	2.00 (50.8)	0.75 (19.0)	0.32 (8.1)	0.34 (8.6)	0.13 (3.3)	0.17 (4.3)
E50KL572	2.00 (50.8)	0.75 (19.0)	1.00 (25.4)	0.34 (8.6)	0.83 (21.1)	0.83 (21.1)
E50KL553	2.50 (63.5)	0.69 (17.5)	0.25 (6.4)	0.34 (8.6)	0.05 (1.3)	0.11 (2.8)
E50KL547	2.50 (63.5)	0.75 (19.0)	0.32 (8.1)	0.34 (8.6)	0.13 (3.3)	0.17 (4.3)
E50KL550	2.50 (63.5)	0.75 (19.0)	0.32 (8.1)	0.34 (8.6)	0.13 (3.3)	0.17 (4.3)
E50KL573	2.50 (63.5)	0.75 (19.0)	1.00 (25.4)	0.34 (8.6)	0.83 (21.1)	0.83 (21.1)
E50KL575	2.50 (63.5)	1.50 (38.1)	0.28 (7.1)	0.34 (8.6)	0.11 (2.8)	0.17 (4.3)
E50KL554	3.00 (76.2)	0.69 (17.5)	0.25 (6.4)	0.34 (8.6)	0.05 (1.3)	0.11 (2.8)
E50KL548	3.00 (76.2)	0.75 (19.0)	0.32 (8.1)	0.34 (8.6)	0.13 (3.3)	0.17 (4.3)
E50KL551	3.00 (76.2)	0.75 (19.0)	0.32 (8.1)	0.34 (8.6)	0.13 (3.3)	0.17 (4.3)
E50KL574	3.00 (76.2)	0.75 (19.0)	1.00 (25.4)	0.34 (8.6)	0.83 (21.1)	0.83 (21.1)
E50KL576	3.00 (76.2)	1.50 (38.1)	0.28 (7.1)	0.34 (8.6)	0.11 (2.8)	0.17 (4.3)

Note

^① Length from the operating shaft axis to the roller axis (or to the tip for non-roller operators).

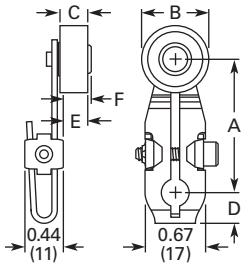

Roller on Reverse Side

Approximate Dimensions in Inches (mm)

Catalog Number	A Lever Length ①	B Roller Diameter	C Roller Width	D	E	F
E50KL580	1.50 (38.1)	0.69 (17.5)	0.25 (6.4)	0.34 (8.6)	0.18 (4.6)	0.24 (6.1)
E50KL310	1.50 (38.1)	0.75 (19.0)	0.32 (8.1)	0.34 (8.6)	0.27 (6.9)	0.31 (7.9)
E50KL579	1.50 (38.1)	0.75 (19.0)	0.32 (8.1)	0.34 (8.6)	0.27 (6.9)	0.31 (7.9)
E50KL536	1.50 (38.1)	1.50 (38.1)	0.28 (7.1)	0.34 (8.6)	0.23 (5.8)	0.31 (7.9)

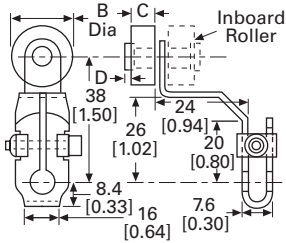

Offset Roller

Approximate Dimensions in mm [in]

Catalog Number	A Lever Length ①	B Roller Diameter	C Roller Width	D
Inboard				
E50KL24	38.1 [1.50]	19.0 [0.75]	8.1 [0.32]	0.8 [0.03]
E50KL25	38.1 [1.50]	19.0 [0.75]	8.1 [0.32]	0.8 [0.03]
E50KL26	38.1 [1.50]	17.5 [0.69]	6.4 [0.25]	1.0 [0.04]
Outboard				
E50KL27	38.1 [1.50]	19.0 [0.75]	8.1 [0.32]	0.8 [0.03]
E50KL28	38.1 [1.50]	19.0 [0.75]	8.1 [0.32]	0.8 [0.03]
E50KL29	38.1 [1.50]	17.5 [0.69]	6.4 [0.25]	1.0 [0.04]
E50KL30	38.1 [1.50]	19.0 [0.75]	25.4 [1.00]	—

Bantam Lever

Approximate Dimensions in mm [in]

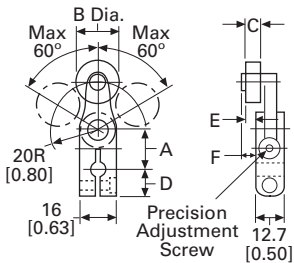
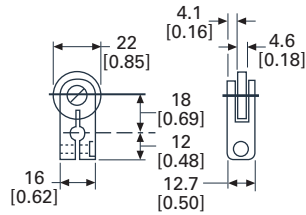

Precision Adjustment

Approximate Dimensions in mm [in]

Catalog Number	A Lever Length ①	B Roller Diameter	C Roller Width	D	E	F
E50KL340	17.5 [0.69]	19.0 [0.75]	8.1 [0.32]	12.2 [0.48]	6.1 [0.24]	7.1 [0.28]
E50KL465	Roller length: 38.1 [1.50] ②	19.0 [0.75]	8.1 [0.32]	12.2 [0.48]	6.1 [0.24]	7.1 [0.28]
E50KL535		17.5 [0.69]	6.4 [0.25]	12.2 [0.48]	4.1 [0.16]	5.6 [0.22]

Notes

- ① Length from the operating shaft axis to the roller axis (or to the tip for non-roller operators).
- ② Maximum length dimension between operating shaft axis to the roller axis for comparison. Precision adjustable to lesser dimensions.

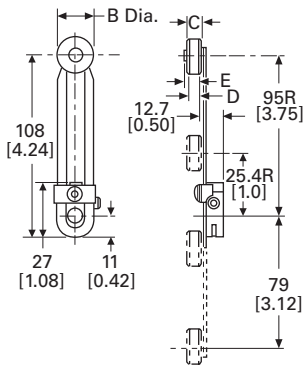

Adjustable Roller

Approximate Dimensions in mm [in]

Catalog Number	A Lever Length ①	B Roller Diameter	C Roller Width	D	E
E50KL539	25.4 [1.0] to 95.2 [3.75] ②	17.5 [0.69]	6.4 [0.25]	5.8 [0.23]	7.6 [0.30]
E50KL201		19.0 [0.75]	8.1 [0.32]	7.4 [0.29]	8.4 [0.33]
E50KL201SPL ③		19.0 [0.75]	8.1 [0.32]	7.4 [0.29]	8.4 [0.33]
E50KL538		19.0 [0.75]	8.1 [0.32]	7.4 [0.29]	8.4 [0.33]
E50KL599		19.0 [0.75]	12.7 [0.50]	11.6 [0.46]	12.2 [0.48]
E50KL537		19.0 [0.75]	25.4 [1.00]	22.9 [0.90]	24.1 [0.95]
E50KL598	12.7 [0.50] to 82.6 [3.25]	102.0 [4.00]	2.8 [0.11]	4.8 [0.19]	24.1 [0.95]
E50KL31	12.7 [0.50] to 95.2 [3.75]	—	—	—	—
E50KL443	41.3 [1.63] to 95.2 [3.75] ②	38.1 [1.50]	7.4 [0.29]	6.6 [0.26]	8.1 [0.32]

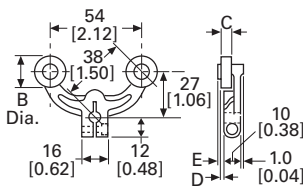

Fork Lever—Both Rollers on One Side

Approximate Dimensions in mm [in]

Catalog Number	A Lever Length ①	B Roller Diameter	C Roller Width	D	E
E50KL545	38.1 [1.50]	17.5 [0.69]	6.4 [0.25]	2.0 [0.08]	3.6 [0.14]
E50KL204	38.1 [1.50]	19.0 [0.75]	8.1 [0.32]	4.1 [0.16]	5.1 [0.20]
E50KL544	38.1 [1.50]	19.0 [0.75]	8.1 [0.32]	4.1 [0.16]	5.1 [0.20]
E50KL543	38.1 [1.50]	19.0 [0.75]	25.4 [1.00]	21.3 [0.84]	22.4 [0.88]

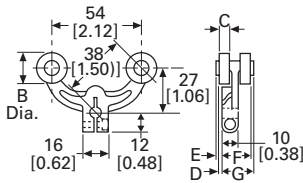

Fork Lever—One Roller Outside, One Inside

Approximate Dimensions in mm [in]

Catalog Number	A Lever Length ①	B Roller Diameter	C Roller Width	D	E	F	G
E50KL542	38.1 [1.50]	17.5 [0.69]	6.4 [0.25]	2.0 [0.08]	3.6 [0.14]	16.3 [0.64]	17.8 [0.70]
E50KL203	38.1 [1.50]	19.0 [0.75]	8.1 [0.32]	4.1 [0.16]	5.1 [0.20]	18.5 [0.73]	19.6 [0.77]
E50KL541	38.1 [1.50]	19.0 [0.75]	8.1 [0.32]	4.1 [0.16]	5.1 [0.20]	18.5 [0.73]	19.6 [0.77]

Rod Type Operators

Approximate Dimensions in Inches or mm [in]

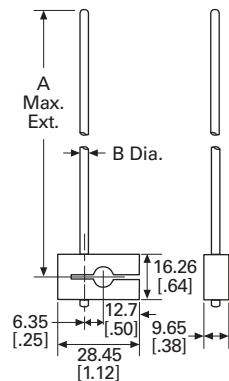

Adjustable Rod

Catalog Number	A Rod Length ①	B Rod Diameter
E50KL399	140.0 [5.50]	4.8 [0.19]
E50KL202		3.2 [0.12]
E50KL581	222.0 [8.75]	Rod size (square): 3.2 [0.12] x 3.2 [0.12]
E50KL220	229.0 [9.00]	4.8 [0.19]
E50KL226	305.0 [12.00]	3.2 [0.12]

Notes

- ① Length from the operating shaft axis to the roller axis (or to the tip for non-roller operators).
- ② By reassembling lever, minimum length can be reduced another 12.7 mm [0.5 in].
- ③ High-grade stainless steel.

2.8

Limit Switches

Operators

2

Rod Type Operators, continued

Approximate Dimensions in Inches or mm [in]

Spring Rod—E50KL556

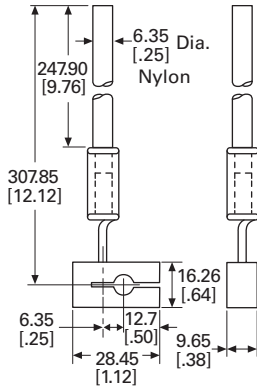

Adjustable Wire

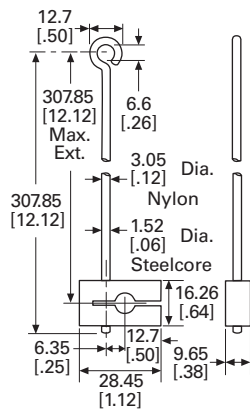

Eye Bolt

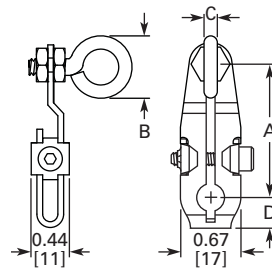

Catalog Number	A Rod Length ②	B Rod Diameter	C Rod Width	D
E50KL33	38.1 [1.50]	4.8 [0.1875] Loop ID: 9.5 [0.375]	13.1 [0.52]	8.6 [0.34]

Spring Rod—E50KL421

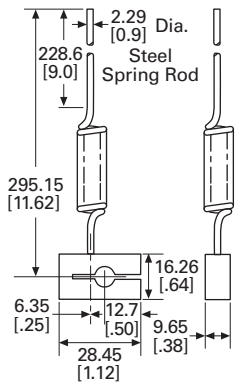

Adjustable Wide Roller Lever

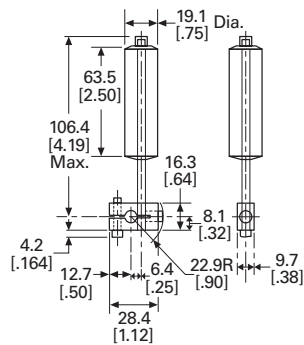

Wobble Type Operators

Nylon Rod

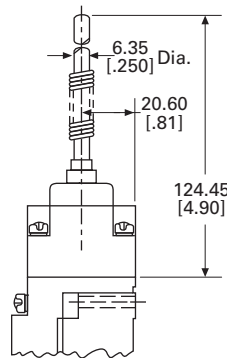

Coil Spring

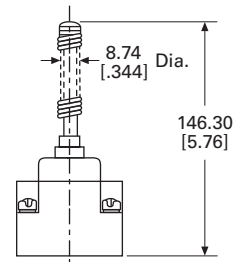

Nylatron Loop—E50KL142

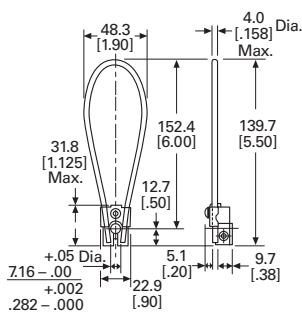

Nylatron Loop—E50KL142

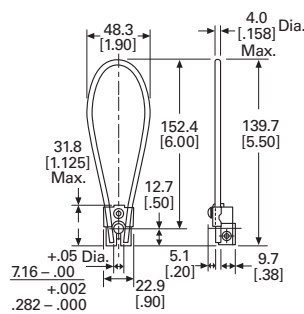

Stainless Steel Rod

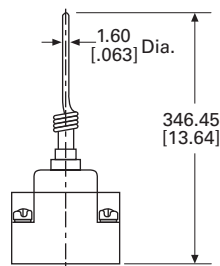

Notes

- ① Applies when lever is extended to the maximum dimension.
- ② Length from the operating shaft axis to tip.

Non Plug-In Switches



Non Plug-In Switches

Product Description

10316 Type L non plug-in limit switches by Eaton's electrical sector are sold as completely assembled devices only, with a wide array of operating head configurations. All switches are single-pole 1NO-1NC.

Features

- Side and top rotary, side and top push or wobble operation
- CW, CCW or CW and CCW operating modes are field convertible
- Double break-make snap action contacts, same polarity each pole
- Captive saddle clamp terminals accept up to #12 wire
- Head can be mounted in any of four discrete positions, intervals of 90°

Contents

Description

Description	Page
Non Plug-In Switches	
Product Selection	V8-T2-88
Technical Data and Specifications	V8-T2-89
Dimensions	V8-T2-89

Standards and Certifications

- UL Listed, E170645
- CSA Certified, 50513



⚠ DANGER

THIS SENSOR IS NOT A SAFETY DEVICE AND IS NOT INTENDED TO BE USED AS A SAFETY DEVICE. This sensor is designed only to detect and read certain data in an electronic manner and perform no use apart from that, specifically no safety-related use. This sensor product does not include self-checking redundant circuitry, and the failure of this sensor product could cause either an energized or de-energized output condition, which could result in death, serious bodily injury, or property damage.

For the most current information on this product, visit our Web site: www.eaton.com

For Customer Service in the U.S. call 1-877-ETN CARE (386-2273), in Canada call 1-800-268-3578.

For Application Assistance in the U.S. and Canada call 1-800-426-9184.

Product Selection

2

Complete Assembled Switches Single-Pole 1NO-1NC

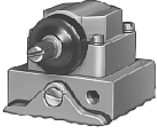
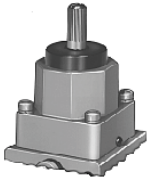
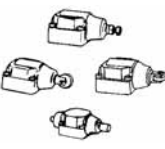
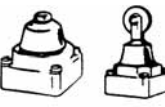
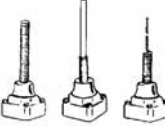
Operating Characteristics	Operating Data—Nominal			Force to Operate Contacts	Minimum Return Force	Catalog Number
	Travel to Operate Contacts	Travel to Reset Contacts	Total Travel			
Side Rotary Operated	Side Rotary Operated ①					
 Standard	10°	4°	50°	3 in-lbs	4.5 in-oz	10316H187
Top Rotary Operated	Top Rotary Operated ①					
 Clockwise	20°	12°	140°	1.1 in-lbs	3 in-oz	10316H700
Counterclockwise	20°	12°	140°	1.1 in-lbs	3 in-oz	10316H701
Side Push Operated	Side Push Operated					
 Adjustable pushbutton	0.07 in (1.8 mm)	0.03 in (0.8 mm)	0.29 in (7.4 mm)	4 lbs	8 oz	10316H621
Vertical roller— 0.44 in (11.2 mm) dia.	0.07 in (1.8 mm)	0.03 in (0.8 mm)	0.29 in (7.4 mm)	4 lbs	8 oz	10316H284
Horizontal roller— 0.44 in (11.2 mm) dia.	0.07 in (1.8 mm)	0.03 in (0.8 mm)	0.29 in (7.4 mm)	4 lbs	8 oz	10316H285
Top Push Operated	Top Push Operated					
 Pushbutton	0.04 in (1.0 mm)	0.02 in (0.5 mm)	0.28 in (7.1 mm)	4 lbs	8 oz	10316H281
Roller—0.44 in (11.2 mm) dia.	0.04 in (1.0 mm)	0.02 in (0.5 mm)	0.28 in (7.1 mm)	4 lbs	8 oz	10316H283
Roller—0.75 in (19.1 mm) dia.	0.04 in (1.0 mm)	0.02 in (0.5 mm)	0.28 in (7.1 mm)	4 lbs	8 oz	10316H577
Wobble Operated	Wobble Operated ②					
 Spring	10°	6°	15°	1 in-lb	2.4 in-oz	10316H299
Nylon rod	10°	6°	15°	2 in-lbs	2.4 in-oz	10316H296
Wire	10°	6°	15°	2 in-lbs	2.4 in-oz	10316H484
Cat whisker	15°	5°	30°	0.63 in-lb	1.7 in-oz	10316H341

Notes

- ① For operating levers, see **Page V8-T2-79**.
- ② For wobble operators, see **Page V8-T2-79**.

Technical Data and Specifications

Non Plug-In Switches

Description	Specification
Contact rating	NEMA A600, R300 double break-make snap action contacts
Electrical life	500,000 operations minimum
Mechanical life	5,000,000 operations minimum at full load
Conduit entrance	0.5 in (12.7 mm) NPT
Material of construction	Zinc die cast
Enclosure rating	NEMA 1, 4, 13
Ambient operating temperature	-20° to 200°F (-29° to 93°C) ①
Approximate shipping weight	2 lbs

Electrical Data—Maximum Contact Ratings per Pole ②

AC Volts	Current, Amperes		Cont. Thermal Ratings	Volts, Amperes		DC Volts	DC Current, Ampere
	Make	Break		Make	Break		
NEMA A600, R300 Rating							
120	60	6	10	7200	720	125	0.22
240	30	3	10	7200	720	250	0.11
480	15	1.5	10	7200	720	250	0.11
600	12	1.2	10	7200	720	250	0.11

Dimensions

Approximate Dimensions in Inches or Inches (mm)

Side Rotary Operated Head with Switch

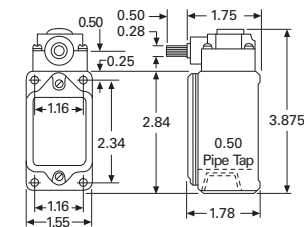

(2) 0.203 Dia. Holes for Front Mtg.
(2) 10-32 Tapped Holes 0.375 Deep for Rear Mtg.

Side Pushbutton, Adjustable

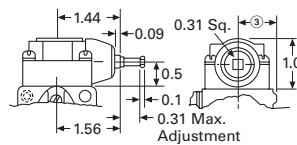

Top Pushbutton

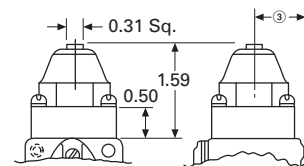

Side Push, Vertical Roller

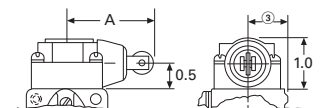

Dimension "A"

With 0.44 (11.2) dia. roller	1.78 (45.2)
With 0.75 (19.1) dia. roller	2.09 (53.1)

Side Push Maintained Contact

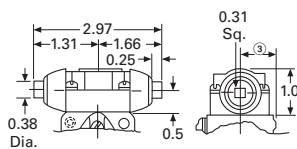

Top Push Roller

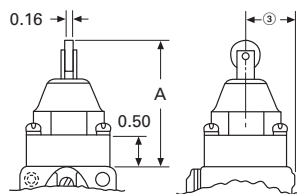

Dimension "A"

With 0.44 (11.2) dia. roller	2.03 (51.6)
With 0.75 (19.1) dia. roller	2.34 (59.4)

Wobble Operators

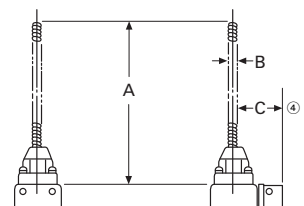

A	B	C
Wobble Spring		
5.44 (138.2)	0.31 (7.9)	0.81 (20.6)
Wire Wobble Stick		
12.5 (317.5)	0.08 (2.0)	0.81 (20.6)
Nylon Wobble Stick		
4.5 (114.3)	0.25 (6.4)	0.81 (20.6)

Notes

- ① Ranges below 32°F (0°C) are based on absence of freezing moisture or water.
- ② Contacts must be same polarity when both circuits are used.
- ③ Dimension from centerline of head to mounting surface is 0.78 in (20 mm).
- ④ Center to mounting surface.

Hazardous Location Limit Switches

2



Hazardous Location Limit Switches

Product Description

Type LX, CX and CBX limit switches by Eaton's electrical sector are designed for extreme environmental service in NEMA 7–9 locations where the danger of an internal or external explosion of flammable gases, vapors, metal alloy or grain dust exists. Type CB provides excellent corrosion resistant properties in NEMA 4X applications. Markets served include mining, grain storage, forest products, petrochemical, pharmaceutical and waste and sewage management.

Features

- Sealed and unsealed versions available
- One-way gasket on sealed version keeps liquids out, yet allows a harmless release of gases in the event of an internal explosion
- Silicon bronze housing provides excellent corrosion resistant properties in extreme NEMA 4X applications
- Temperature buildup on limit switch surface is dissipated by housing design and materials used
- Utilizes the operating heads and internal switch mechanisms of the 10316 L non plug-in line

Contents

Description

	<i>Page</i>
Hazardous Location Limit Switches	
Product Selection	V8-T2-91
Technical Data and Specifications	V8-T2-92
Dimensions	V8-T2-89

Standards and Certifications

- UL Listed, E170645, E183975
- UL tested to Canadian safety standards



NEMA Ratings Comparison

Switch Type	LX	CX	CBX	CB ①
NEMA 1, 4, 13	—	✓	✓	✓
NEMA 4X	—	—	✓	✓
NEMA 7 Division I, Class I, BCD	✓	✓	✓	—
NEMA 9 Division I, Class II, EFG	✓	✓	✓	—

Note

① Not rated for explosive locations.



DANGER
THIS SENSOR IS NOT A SAFETY DEVICE AND IS NOT INTENDED TO BE USED AS A SAFETY DEVICE. This sensor is designed only to detect and read certain data in an electronic manner and perform no use apart from that, specifically no safety-related use. This sensor product does not include self-checking redundant circuitry, and the failure of this sensor product could cause either an energized or de-energized output condition, which could result in death, serious bodily injury, or property damage.

For the most current information on this product, visit our Web site: www.eaton.com

For Customer Service in the U.S. call 1-877-ETN CARE (386-2273), in Canada call 1-800-268-3578. For Application Assistance in the U.S. and Canada call 1-800-426-9184.

Product Selection

Complete Assembled Switches with Spring Return Heads ^①

Operating Data—Nominal

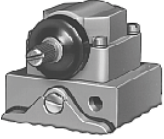
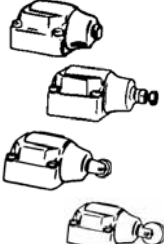
Head Type	Travel to Operate Contacts	Travel to Reset Contacts	Total Travel	Force to Operate Contacts	Minimum Return Force	Body Type	Contacts	Catalog Number
Side Rotary Operated ^② 	Standard, 10° Pre-Travel ^③							
	10°	4°	50°	3.0 in-lbs	4.5 in-oz	Type LX	1NO-1NC ^④	10316H1002
							2NO	10316H1039
							1NO and 1NC ^④	10316H1049
							2NC	10316H1059
						Type CX	1NO-1NC ^④	10316H2200
							1NO and 1NC ^④	10316H2176
							2NC	10316H2178
						Type CB	1NO-1NC ^④	10316H2149
							2NC	10316H2140
						Type CBX	1NO-1NC ^④	10316H2168
							2NC	10316H2159
	Narrow Differential 5° Pre-Travel ^③							
	5°	2°	50°	6.0 in-lbs	4.5 in-oz	Type LX	1NO-1NC ^④	10316H1146
						Type CX	1NO-1NC ^④	10316H2197
	Neutral Position, 18° Pre-Travel ^⑤							
	18°	6°	50°	1.8 in-lbs	2.5 in-oz	Type LX	2NO	10316H1071
							2NC	10316H1072
						Type CX	2NO	10316H2179
						Type CBX	2NC	10316H2160
Side Push Operated 	Pushbutton							
	0.07 in (1.8 mm)	0.03 in (0.76 mm)	0.29 in (7.4 mm)	4 lbs	8 oz	Type LX	1NO and 1NC ^④	10316H1213
	Adjustable Pushbutton							
	0.07 in (1.8 mm)	0.03 in (0.76 mm)	0.29 in (7.4 mm)	4 lbs	8 oz	Type LX	1NO-1NC ^④	10316H1192
	Vertical Roller, 0.44 in (11.2 mm) Diameter							
	0.07 in (1.8 mm)	0.03 in (0.76 mm)	0.29 in (7.4 mm)	4 lbs	8 oz	Type LX	1NO-1NC ^④	10316H1007
Vertical Roller, 0.75 in (19.1 mm) Diameter								
0.07 in (1.8 mm)	0.03 in (0.76 mm)	0.29 in (7.4 mm)	4 lbs	8 oz	Type LX	1NO-1NC ^④	10316H1194	

Notes

- ① Contact Eaton's Sensor Applications Engineering at 1-800-426-9184 for replacement contact blocks.
- ② For operating levers, see **Page V8-T2-79**. Only levers with Nylatron rods or rollers should be used with explosion-proof limit switches.
- ③ Field convertible to clockwise only or counterclockwise only operation.
- ④ 1NO-1NC contacts must be same polarity when both circuits are used—1NO and 1NC contacts have isolated poles and may be used on opposite polarity.
- ⑤ Neutral position switches operate one circuit in each direction.

Complete Assembled Switches with Spring Return Heads, continued ^①

Operating Data—Nominal

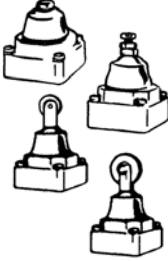
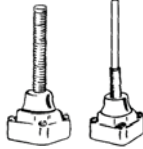
Head Type	Travel to Operate Contacts	Travel to Reset Contacts	Total Travel	Force to Operate Contacts	Minimum Return Force	Body Type	Contacts	Catalog Number
Top Push Operated 	Pushbutton							
	0.04 in (1 mm)	0.02 in (0.5 mm)	0.28 in (7.1 mm)	4 lbs	8 oz	Type LX	1NO-1NC ^②	10316H1004
						Type CX	1NO and 1NC ^②	10316H2188
	Adjustable Pushbutton							
	0.04 in (1 mm)	0.02 in (0.5 mm)	0.28 in (7.1 mm)	4 lbs	8 oz	Type LX	1NO-1NC ^②	10316H1191
							1NO and 1NC ^②	10316H1212
	Roller, 0.44 in (11.2 mm) Diameter							
	0.04 in (1 mm)	0.02 in (0.5 mm)	0.28 in (7.1 mm)	4 lbs	8 oz	Type LX	1NO-1NC ^②	10316H1006
						Type CBX	1NO-1NC ^②	10316H2170
	Roller, 0.75 in (19.1 mm) Diameter							
0.04 in (1 mm)	0.02 in (0.5 mm)	0.28 in (7.1 mm)	4 lbs	8 oz	Type LX	1NO-1NC ^②	10316H1193	
Wobble Operated 	Spring							
	10° ^③	6°	15°	1 in-lb	2.4 in-oz	Type LX	1NO-1NC ^②	10316H1237
	Nylon Rod							
	10° ^③	6°	15°	2 in-lbs	5.6 in-oz	Type LX	1NO-1NC ^②	10316H1009

Technical Data and Specifications

Hazardous Location Limit Switches

Description	Specification
Material of construction	
LX, CX	Cast aluminum die cast
CB, CBX	Silicon bronze
Conduit entrance	
LX	1/2 in pipe tap
CB, CBX, CX	3/4 in pipe tap
Mounting	Surface mount
Enclosure rating	
LX, CX, CBX	NEMA 7 Div. 1, Class I BCD; NEMA 9 Div. 1, Class II, EFG ^④
CB, CBX	NEMA 1, 4, 4X, 13 ^④
CX	NEMA 1, 4, 13 ^④
Ambient operating temperature	-20° to 200°F (-29° to 93°C) ^⑤
Approximate shipping weight	
LX	2 lbs
CX	2.5 lbs
CB, CBX	6 lbs

Notes

- ① Contact Eaton's Sensor Applications Engineering at 1-800-426-9184 for replacement contact blocks.
- ② 1NO-1NC contacts must be same polarity when both circuits are used—1NO and 1NC contacts have isolated poles and may be used on opposite polarity.
- ③ Travel with force applied at one-in (25.4 mm) radius. Applied at end of operator, travel is approximately 14.
- ④ A conduit seal-off kit is required for these switches
- ⑤ Ranges below 32°F (0°C) are based on absence of freezing moisture or water.

Electrical Data—Maximum Contact Ratings, per Pole

AC Volts	Current, Amperes		Cont. ①	Volt Amperes		DC Volts	DC Current, Ampere
	Make	Break		Make	Break		
1NO-1NC Switches							
NEMA A600, R300 rating							
120	60	6	10	7200	720	125	0.2
240	30	3	10	7200	720	250	0.1
480	15	1.5	10	7200	720	250	0.1
600	12	1.2	10	7200	720	250	0.1
All Other Switches, B600							
120	30	3	5	3600	360	120	0.1
240	15	1.5	5	3600	360	240	0.05
480	7.5	0.75	5	3600	360	240	0.05
600	6	0.60	5	3600	360	240	0.05

Dimensions

Approximate Dimensions in Inches or Inches (mm)

Type LX Switch with Side Rotary Head

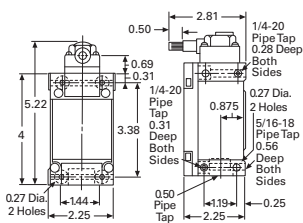

Side Pushbutton Head

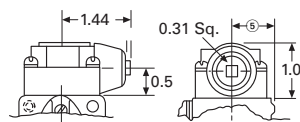

Top Pushbutton Head

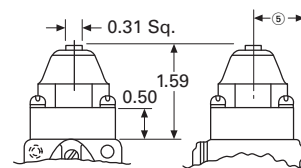

Side Push, Vertical Roller Head

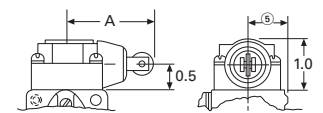

Dimension "A"

With 0.44 (11.2) dia. roller	1.78 (45.2)
With 0.75 (19.1) dia. roller	2.09 (53.1)

Type CX, CB and CBX Switches with Side Rotary Head

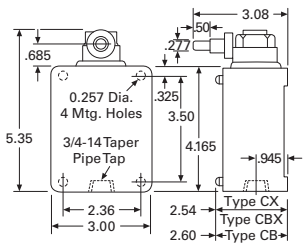

Adjustable Top Pushbutton Head

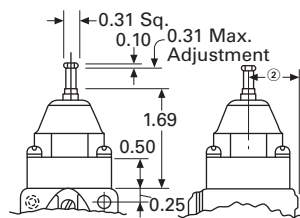

Wobble Operators

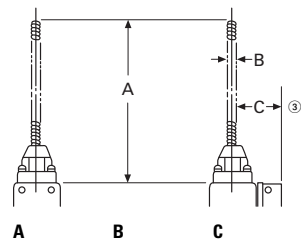

Notes

- ① 1NO-1NC contacts must be same polarity when both circuits are used—1NO and 1NC contacts have isolated poles and may be used on opposite polarities.
- ② Dimension from centerline of head to mounting surface is 0.78 in (20 mm).
- ③ Center to mounting surface.

Adjustable Side Pushbutton Head

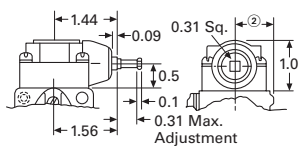

Top Push Roller Head

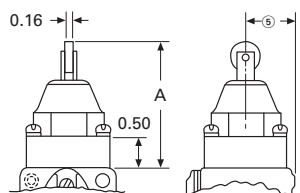

Dimension "A"

With 0.44 (11.2) dia. roller	2.03 (51.6)
With 0.75 (19.1) dia. roller	2.34 (59.4)

Wobble Spring

5.44 (138.2)	0.31 (7.9)	0.94 (23.9)
--------------	------------	-------------

Nylon Red

4.5 (114.3)	0.25 (6.4)	0.94 (23.9)
-------------	------------	-------------

Special Purpose Limit Switches

2



Special Purpose Limit Switches

Product Description

Special Purpose (Type F), Rotating Shaft (Type J), Pneumatic Time Delay (Type LP) and Precision and Cabinet Door Interlock (Type PS) Limit Switches from Eaton's electrical sector serve a variety of special purpose industrial applications for MRO and User Replacement requirements.

Features

- UL Listed
- CSA Certified (PS and J only)

Contents

Description

Special Purpose Limit Switches

Product Selection

Roller Lever Switches	V8-T2-95
Rotating Shaft Switches	V8-T2-95
Pneumatic Time Delay Switches	V8-T2-96
Precision Switches	V8-T2-96
Technical Data and Specifications	V8-T2-97
Dimensions	V8-T2-98

Page

Standards and Certifications

Standards and Certifications

Type J

- UL Listed, E170645
- CSA Certified, 50513



Type LP

- UL Listed, E170645



Type PS

- UL Listed, E170645
- CSA Certified, 50513



THIS SENSOR IS NOT A SAFETY DEVICE AND IS NOT INTENDED TO BE USED AS A SAFETY DEVICE. This sensor is designed only to detect and read certain data in an electronic manner and perform no use apart from that, specifically no safety-related use. This sensor product does not include self-checking redundant circuitry, and the failure of this sensor product could cause either an energized or de-energized output condition, which could result in death, serious bodily injury, or property damage.

For the most current information on this product, visit our Web site: www.eaton.com

For Customer Service in the U.S. call 1-877-ETN CARE (386-2273), in Canada call 1-800-268-3578. For Application Assistance in the U.S. and Canada call 1-800-426-9184.

Product Selection

Roller Lever Switches

Roller Lever



Type F Switches ^①

Operator	Circuit	Travel to Operate Contacts	Travel to Reset Contacts	Total Travel	Over-Travel	Catalog Number
Roller lever (CW and CCW operation, spring return)	1NO-1NC	40°	35°	65°	25°	10316H18
	2NO-2NC	17°	6°	60°	43°	10316H320

Rotating Shaft Switches

Type J

Rotating Shaft Limit Switches allow the shaft to be rotated a preset number of revolutions (adjustable from 1/2 to 100 with an accuracy of 1/20 of a turn) before the contacts will switch. A second set of

contacts will trip when reaching a preset limit in the opposite direction. These switches are typically used in crane and hoist applications to provide end of travel stops for the hook assembly.

Rotating Shaft



Type J Switches

Shaft to Cam Ratio	Max. Turns to Trip Contacts	Min. Turns to Trip Contacts	Over-Travel Before Resetting Contacts	Reversal After Tripping to Reset Contacts	Circuit ^②	Enclosure Rating	Catalog Number
103:1	100 input shaft turns	1/2 input shaft turns	103 input shaft turns max.	1/8 input shaft turns min.	2NC	NEMA 1	10316H50
					2NO-2NC ^③	NEMA 4	10316H54 ^③

Notes

- ① Replacement operator head is available with part number **86-862-22**.
Replacement roller lever is available with part number **24-1712**.
Replacement key pin and washer for roller is available with part number **16-906**.
- ② For replacement NO contacts, order **17-1403**; NC contacts, order **17-702**.
- ③ 10316H54 has factory set circuits, but is easily convertible to any of three circuits (2NO-2NC, 4NO or 4NC). Full instructions enclosed with every switch.

Pneumatic Time Delay Switches

Pneumatic Time Delay

Type LP Switches



Operator	Total Travel	Pre-Travel	Circuit	Timed Contacts	Direction of Rotation ^②	Catalog Number
Side rotary (Spring return to center) ^①	50°	10°	1NO-1NC	ON delay	CW	10316H1580
					CW and CCW	10316H1600
				OFF delay	CW	10316H1610
					CW and CCW	10316H1630

Precision Switches

Cabinet Door Interlock

Type PS Switches



Operator	Circuits— SPDT 1NO-1NC Catalog Number	Circuits— DPDT 2NO-2NC Catalog Number	Operator Only Catalog Number
Precision Switch Devices			
Precision switch only	10316H89	10316H2000	—
Pushbutton with oiltight plunger	—	10316H2006	—
Roller with oiltight plunger perpendicular to mounting holes	—	10316H2012	—
Roller with oiltight plunger in line with mounting holes	10316H110	—	—
6 in lever with top and right-hand mounting bracket	10316H113	—	10316H143
6 in lever with top and left-hand mounting bracket	—	—	10316H144
Roller lever with top and right-hand mounting bracket	10316H119	—	10316H145
Roller lever with top and left-hand mounting bracket	10316H122	—	10316H146
One way roller lever with top and right-hand mounting bracket	—	—	10316H147
One way roller lever with top and left-hand mounting bracket	—	—	10316H148
Cabinet Door Interlocks			
Precision switch only	10316H828	10316H829A	—
Cabinet door interlock operator with one precision switch and with red (defeated ^③) indicator	10316H1028	10316H2042	10316H150
Cabinet door interlock operator with two each of listed precision switches and with red (defeated ^③) indicator	10316H1029	—	—

Notes

- ① Requires an operating lever, see **Page V8-T2-79**.
- ② Field convertible.
- ③ The plunger exposes a red band when pulled out to indicate that interlock is defeated.

Technical Data and Specifications

Special Purpose Limit Switches

Description	Specification
Roller Lever Switches – Type F	
Enclosure rating	NEMA 4
Operating temperature	0° to 180°F (–18° to 82°C)
Conduit entrance	0.5 in NPT
Shipping weight	4.0 lbs
Rotating Shaft Switches – Type J	
Shipping weight	
NEMA 1 models	5.5 lbs
NEMA 4 models	13 lbs
Pneumatic Time Delay Switches – Type LP	
Timing range	0.05 to 60 seconds
ON delay function	Timing begins when lever is actuated and held
OFF delay function	Timing begins when lever is released
Repeat accuracy ^①	With 15 second or higher interval between timing periods: ±10% of setting maximum With less than 15 second interval between timing periods: ±25% of setting maximum
Operating frequency	250 operations per minute maximum
Enclosure rating	NEMA 4, 13
Ambient operating temperature	32° to 150°F (0° to 65°C)
Conduit entrance	0.5 in NPT
Shipping weight	2 lbs

Type F—Maximum Ampere Ratings

Circuit	State	AC Volts				DC Volts		
		120	240	480	600	120	240	600
1NO-1NC	Make	60	30	20	15	—	—	—
	Break	6	3	1.5	1.2	2.2	1.1	0.40
2NO-2NC	Make	40	20	10	8	—	—	—
	Break	15	10	6	5	0.5	0.2	0.02

Type J—Maximum Ampere Ratings

State	AC Volts				DC Volts		
	120	240	480	600	120	240	600
Make	60	30	15	12	2.2	1.1	—
Break	6	3	1.5	1.2	2.2	1.1	—
Continuous ^①	10	10	10	10	10	10	—

Note

^① To maintain operating accuracy during the timing cycle, the switch lever must be faster than the timed setting.

2.11

Limit Switches

Special Purpose Limit Switches

2

Type LP— Electrical Data, Maximum Contact Ratings/Pole

AC Volts	Current, Amperes		Cont. ①	Volt Amperes		DC Volts	DC Current Amperes
	Make	Break		Make	Break		
All Switches 1NO-1NC							
NEMA A600, R300 Rating							
120	60	6	10	7200	720	120	0.2
240	30	3	10	7200	720	240	0.1
480	15	1.5	10	7200	720	240	0.1
600	12	1.2	10	7200	720	240	0.1

Type PS—Maximum Ampere Ratings

Type	State	AC Volts				DC Volts Double Throw		
		120	240	480	600	120	240	600
Heavy-Duty 1/2 hp, 250 Vac Maximum								
Single-pole	Make	40	20	10	8	2.0	0.5	0.1
	Break	15	10	6	5	0.5	0.2	0.02
Double-pole	Make	30	15	8	6	0.5	0.2	0.2
	Break	3	1.5	1	0.8	0.2	0.1	—

Dimensions

Approximate Dimensions in Inches (mm)

Roller Lever Switches

Type F

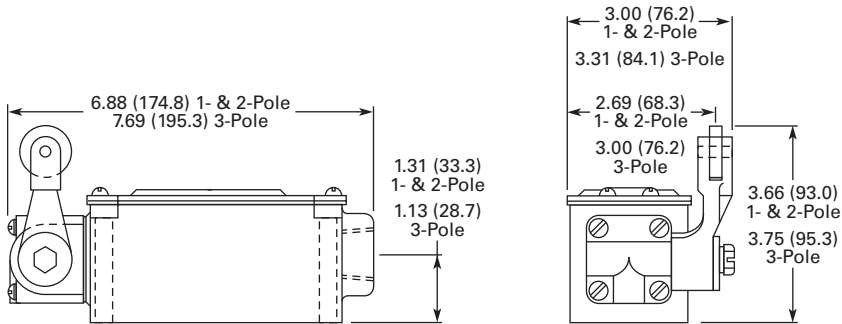

Note

① Thermal rating. Valid only if switch does not have to make or break.

Approximate Dimensions in Inches only

Rotating Shaft Switches

Type J—NEMA 1 Models

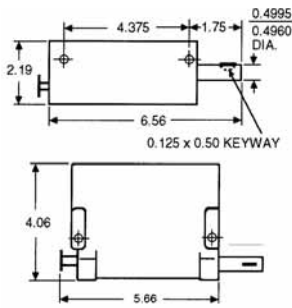

Type J—NEMA 4 Models

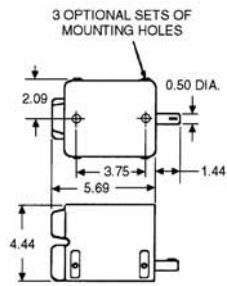

Pneumatic Time Delay Switches

Type LP

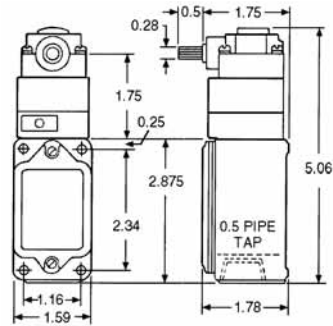

Precision Switches

Type PS

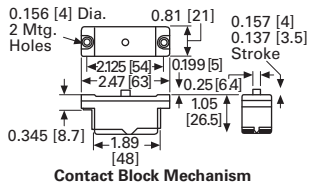

Contact Block Mechanism

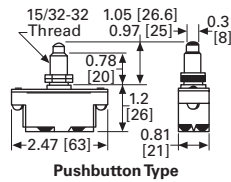

Pushbutton Type

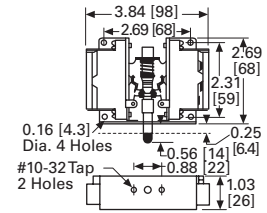

Cabinet Door Type Two Contact Blocks

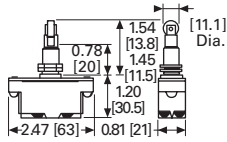

Push Roller Type

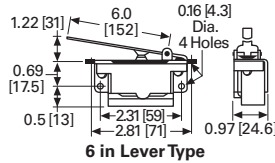

6 in Lever Type

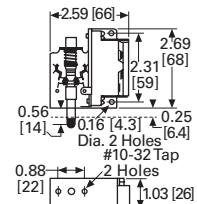

Cabinet Door Type One Contact Block

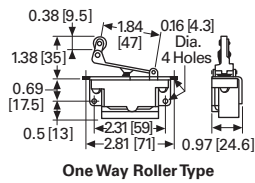

One Way Roller Type

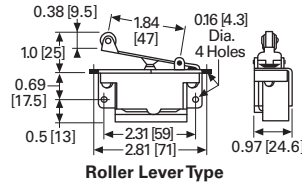

Roller Lever Type

E47 Precision Switch



Compact Prewired Switch



LS-Titan Miniature DIN Switch



E49 Compact Metal Switch



Heavy-Duty Factory Sealed 6P+ Switch



2.0	Introduction	
	Technical Reference	V8-T2-2
	Product Selection Guide	V8-T2-3
2.1	E47 Precision Switches	
	Product Description	V8-T2-6
	Product Selection	V8-T2-7
2.2	Compact Prewired Switches	
	Product Description	V8-T2-16
	Product Selection	V8-T2-17
2.3	LS-Titan Miniature DIN Switches	
	Product Description	V8-T2-21
	Product Selection	V8-T2-23
2.4	E49 Mini Metal Switches	
	Product Description	V8-T2-43
	Product Selection	V8-T2-44
2.5	E49 Compact Metal Switches	
	Product Description	V8-T2-49
	Product Selection	V8-T2-50
2.6	E50 Heavy-Duty Plug-In Switches	
	Product Description	V8-T2-53
	Product Selection	V8-T2-54
2.7	E50 Heavy-Duty Factory Sealed 6P+ Switches	
	Product Description	V8-T2-67
	Product Selection	V8-T2-68
2.8	Operators	
	Product Description	V8-T2-79
	Product Selection	V8-T2-80
2.9	Non Plug-In Switches	
	Product Description	V8-T2-87
	Product Selection	V8-T2-88
2.10	Hazardous Location Limit Switches	
	Product Description	V8-T2-90
	Product Selection	V8-T2-91
2.11	Special Purpose Limit Switches	
	Product Description	V8-T2-94
	Product Selection	V8-T2-95



Unless otherwise noted, the products contained in this section should not be used for functional safety applications. These products were not designed or tested to IEC 60947-5-3 or recommended for functional safety.



For Customer Service in the U.S. call 1-877-ETN CARE (386-2273),
in Canada call 1-800-268-3578.
For Application Assistance in the U.S. and Canada
call 1-800-426-9184.

Revision notes

Volume 8—Sensing Solutions, CA08100010E

Tab 2—Limit Switches

Revision date	Section	Change page(s)	Description
09/08/2017	2.0	V8-T2-3, V8-T2-4	Content edit
09/08/2017	2.1	V8-T2-9	Content edit
09/08/2017	2.2	V8-T2-18	Content edit
09/08/2017	2.3	V8-T2-21	Content edit
09/08/2017	2.6	V8-T2-53	Content edit
09/08/2017	2.7	V8-T2-67	Content edit
09/08/2017	2.9	V8-T2-87	Content edit
09/08/2017	All	All	Revision date changed to September 2017



Powering Business Worldwide

Technical Reference

Limit Switches

2



Mechanical Limit Switches are contact sensors widely used for detecting the presence or position of objects in industrial applications.

Limit Switches offer high precision in terms of accuracy and repeatability. This is primarily due to the fact that they make direct contact with the target. When an object contacts the limit switch lever (or plunger) the lever moves a pre-travel distance to the operating point where the contacts are tripped. Movement of the lever beyond this point is called the over-travel.

Lever Type Actuator

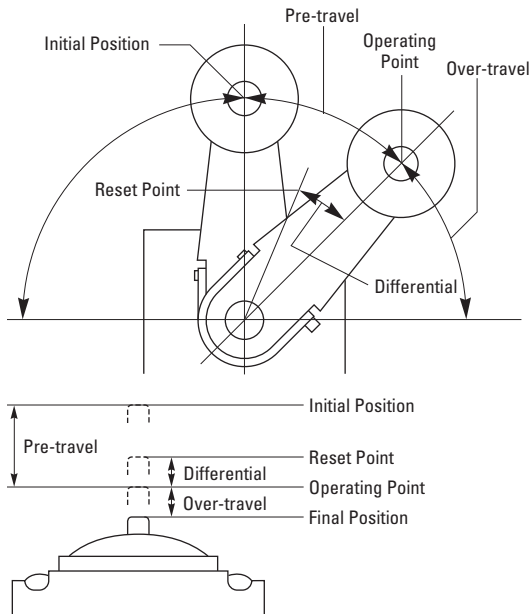

Refer to Sensor Learning Course, **Page V8-T12-4**, for a complete description of limit switch terminology.

Limit switches contain the following major components. These may be modular or part of a single-piece switch.

Limit Switch Components

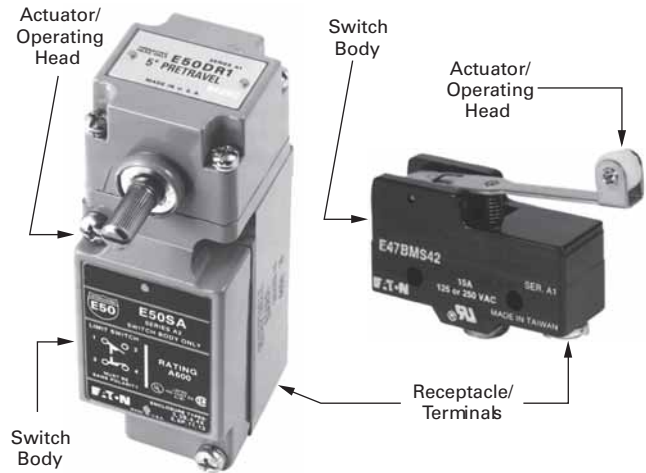

Actuator

This is the part of the switch that contacts the target. Typical actuators are levers and plungers. Several styles are available, see Sensor Learning Course, **Page V8-T12-4**, for more information.

Switch Body

This part contains the electrical contact mechanism. For complete information on electrical outputs, see Sensor Learning Course, **Page V8-T12-4**.

Terminals

The terminals are the point of connection for the wiring. These terminals may be on the body itself, or housed in a removable receptacle. The limit switch may also come equipped with a factory installed cable or pin-connector.

Product Selection Guide

E47 Precision Switches



Page V8-T2-6

Overview

Specified when accurate repeatability, choice of operating forces and travel characteristics and tightly controlled action of cam or target in space restricted areas are of prime importance. Cost effective and compact.

Applications

Overhead, folding and elevator doors, sliding gates, automated guided vehicles and commercial instrumentation

Product Features

Self-contained switches or with an enclosed cast housing for increased durability and conduit connection (1/2 in NPT)

High current capacity for power load switching and motor handling capability

Screw and solder terminations

Booted enclosed version shields actuators from debris

Mounting centers—1.0 in (25.4 mm), #8 screw size

Technical Data and Specifications

Mechanical life: 3,000,000 operations min.

Electrical life: 500,000 operations min.

Contact ratings—
NEMA A600, R300, AC-15, DC-13
15A/20A, 125 or 250 Vac

Enclosure ratings—
Enclosed: NEMA 1

Construction—
Basic: Phenolic
Enclosed: Aluminum die cast

Approvals

UL® Recognized, E117028
UL tested to Canadian safety standards
RoHS Compliant



Compact Prewired Switches



Page V8-T2-16

Overview

Designed to be a versatile, slim device for hard to fit applications where sealing integrity is required.

Applications

Machine tool, food processing and packaging

Product Features

Rugged aluminum alloy die cast housing
Sealed construction with enclosure ratings of NEMA 4, 6 and 13, IEC IP69K

Prewired with 3m of 18 AWG, AWM 2517, 300V cable

Stackable ridge for ganged operation

Technical Data and Specifications

Mechanical life: 10,000,000 operations min.

Electrical life: 200,000 operations
30 operations min.

Contact ratings—
NEMA B300

Enclosure ratings—
NEMA 4, 6 and 13; IP67, IP69

Construction—
Aluminum alloy die cast

Approvals

UL Listed, E170645 (cable versions only)
UL tested to Canadian safety standards
CE
RoHS Compliant



LS-Titan Miniature DIN Switches



Page V8-T2-21

Overview

Safety position switches with insulated plastic or rugged metal enclosures. Approved for worldwide safety application.

Applications

Automatic vending machines, electronic assembly machines, elevators and lifts, injection molding, packaging and safety applications

Product Features

Modular plug-in head and body components

Positive opening NC contacts for safety applications

Operating heads can be rotated 90 degrees to suit specific direction of operation

Technical Data and Specifications

Mechanical life: 8,000,000 operations

Contact ratings—
AC-15, 6A at 24V, 6A at 230/240V,
4A at 400/415V;
DC-13, 3A at 24V, 800 mA at 110V,
300 mA at 220V

Enclosure ratings—
IP66, IP67 (by model)

Construction—
Plastic or metal (by model)

Approvals

Safety function, IEC/EN 60947-5-1
TÜV-Rheinland certified (LSE models)
UL Listed, E29184
CSA Certified, 12528
CE
CCC
RoHS Compliant



E49 Mini Metal Switches



Page V8-T2-43

Overview

Suitable for OEMs who require a small, cost-effective solution but cannot sacrifice durability and mechanical life as they would if they chose a plastic IEC style switch.

Applications

Automatic vending machines, electronic assembly machines, elevators and lifts, injection molding, packaging

Product Features

Pre-wired units with custom cable lengths available for high volume customers

"Fingerproof" terminals protect against accidental shock

Double-spring mechanism for contact reliability

Grounding terminal included

Captive screws on enclosure cover make wiring hassle-free

SPDT double break

Technical Data and Specifications

Contact ratings—
5A at 250 Vac
5A at 30 Vdc

Enclosure ratings—
IP65

Construction—
Zinc alloy

Approvals

UL Recognized, E117028
(Model E49G31C1P3 is not
UL Recognized)
CE
RoHS Compliant



E49 Compact Metal Switches



Page V8-T2-49

Overview

Designed with high mechanical strength for harsh environments. The rugged Aluminum die cast construction provides reliable, oil-tight, waterproof and dustproof sealing for a variety of applications. Snap action 1NO-1NC contacts provide flexibility in design.

Applications

Packaging, material handling conveyors, end-of-travel and guarding operations, baler/compactor, industrial door lifts

Product Features

Rigid die cast switch housing
Set position indicator plate for easy maintenance
High mechanical strength
Oiltight, waterproof and dustproof construction

Technical Data and Specifications

Mechanical life: 15,000,000 operations min.
Electrical life: 500,000 operations min. at full load
Contact ratings—
NEMA A600, R300; AC-15, DC-13
Enclosure ratings—
NEMA 4, 4X, 6, 6P, 12, 13; IP65, IP67
Construction—
Aluminum die cast

Approvals

UL Listed, E170645
UL tested to Canadian safety standards
RoHS Compliant



E50 Heavy-Duty Plug-In Switches



Page V8-T2-53

Overview

Versatile in design. High reliability. Low maintenance costs with installation ease. BEST CHOICE for Heavy-Duty Limit Switch applications. Withstands physical and chemical abuse of harsh industrial environments.

Applications

Punch presses, waste water treatment, machine tool, automotive, retrieval systems, industrial truck, car wash lines

Product Features

Modular operating heads, switch bodies and receptacles are interchangeable without field adjustment
Order as complete assemblies or components for stocking and manufacturing flexibility
90 degree total travel, 5 degree pre-travel characteristics are standard features
Viton® gasket, boot, and seal material offers exceptional chemical resistance
Rotary head operating mode from CW, CCW or CW and CCW is easily changed without tools

Technical Data and Specifications

Mechanical life: 13,000,000 operations min.
Electrical life: 1,000,000 operations min. at full load (single-pole)
Contact ratings—
NEMA A600, R300
Lighted versions A150, R150
6A, 120 Vac; 10A continuous
Enclosure ratings—
NEMA 1, 3, 3S, 4, 4X, 6, 6P, 13; IP67
Construction—Zinc die cast

Approvals

UL Listed, E170645
CSA Certified, 50513
CE (some models)
RoHS Compliant



E50 Heavy-Duty Factory Sealed 6P+ Switches



Page V8-T2-67

Overview

Designed specifically to withstand the penetrating properties of new cutting fluids (coolants), acid or caustic washes, salt spray, severe vibration, shock and temperature fluctuations, grit and debris.

Applications

Automotive, pulp and paper, food processing, waste management, primary metals, machine tool (cutting, forming, bending)

Product Features

Tamperproof, one-piece switch body assembly, epoxy filled
Factory sealed. 6P submersible. Pre-wired with cable, pigtail or pin connector options. All with ground connection
Utilizes E50 modular operating heads
Special V-seal on switch body/head connection provides hermetic barrier against fluid ingress
LED indicating light, 24V–120 Vac/dc neon version too

Technical Data and Specifications

Mechanical life: 35,000,000 operations min.
Electrical life: 1,000,000 operations min. at full load
Contact ratings—
NEMA A600, R300
Lighted versions A150, R150
6A, 120 Vac; 10A continuous
Enclosure ratings—
NEMA 1, 2, 3, 3S, 4, 4X, 6, 6P, 13; IP67, IP69
Construction—Zinc die cast

Approvals

UL Listed, E170645
CSA Certified, 50513
CE (some models)
RoHS Compliant



Operators



Page V8-T2-79

Overview

Wide variety of operator types for rotary and wobble style limit switches.

Applications

Used with E50, E50 6P+ and 10316 limit switches

Product Features

Rollers and rods available in metal and nonmetal contact surfaces

Technical Data and Specifications

Varies by model

Approvals

Varies by model

Non Plug-In Switches**Page V8-T2-87****Overview**

The Industrial standard for Non Plug-In Heavy-Duty Limit Switches. Sold as complete assembled units only.

Applications

Serving MRO and USER replacement requirements with broad d market coverage

Product Features

Side and top rotary, side and top push or wobble operation
 CW, CCW or CW and CCW operating modes are field convertible
 Double break-make snap action contacts, same polarity each pole
 Captive saddle clamp terminals accept up to #12 wire
 Head can be mounted in any of four discrete positions, intervals of 90 degrees

Technical Data and Specifications

Mechanical life: 10,000,000 operations min.
 Electrical life: 500,000 operations at full load
 Contact ratings—NEMA A600, R300 6A, 120 Vac; 10A continuous
 Enclosure ratings—NEMA 1, 4, 13
 Construction—
 Zinc die cast

Approvals

UL Listed, E170645
 CSA Certified, 50513

**Hazardous Location Switches****Page V8-T2-90****Overview**

Designed for severe environmental service in locations where there exists a danger of an internal or external explosion of flammable gases, vapors, metal alloy or grain dust.

Applications

Mining, metal cutting, grain storage, forest products, petrochemical, waste and sewage management, pharmaceutical

Product Features

Sealed and unsealed versions available
 One-way gasket on sealed version keeps liquids out, yet allows a harmless release of gases in the event of an internal explosion
 Silicon bronze housing provides excellent corrosion resistant properties in extreme NEMA 4X applications
 Temperature build-up on limit switch surface is dissipated by housing design and materials used
 Utilizes the operating heads and internal switch mechanisms of the 10316 Non Plug-In line

Technical Data and Specifications

NEMA 7, Div. 1, Class I, BCD
 NEMA 9, Div. 1, Class II, EFG
 Contact ratings—NEMA B600 3A, 120 Vac; 5A continuous
 Enclosure ratings—LX: NEMA 7, 9
 CX: NEMA 1, 4, 7, 9
 CB: NEMA 1, 4, 4X, 13
 CBX: NEMA 1, 4, 4X, 7, 9, 13
 Construction—LX, CX: Aluminum die cast
 CB, CBX: Silicon bronze

Approvals

UL Listed, E170645, E183975
 UL tested to Canadian safety standards

**Special Purpose Switches****Page V8-T2-94****Overview**

Variety of special function limit switch products.

Applications

Serving MRO and USER replacement requirements with broad market coverage

Product Features

Special function switch lines include:
 Cabinet door interlocks — when plunger is pulled out, red band indicator visually shows that interlock is defeated
 Precision switches—1NO-1NC, 2NO-2NC, or operator only. Variety of mounting brackets available
 Pneumatic time delay—ON delay and OFF delay. Timing range—0.05 to 60 seconds
 Rotating cam shaft switches

Technical Data and Specifications

See **Page V8-T2-97** for more information
 Enclosure ratings—
 NEMA 1 or NEMA 4 versions
 Construction—
 Zinc die cast
 PS: Phenolic

Approvals

UL Listed, E170645
 CSA Certified, 50513 (PS and J only)



2.1

Limit Switches

E47 Precision Switches

E47 Precision Switches

2



E47 Precision Switches

Product Description

E47 Precision Switches from Eaton's electrical sector provide high accuracy switching at an affordable price. A variety of standard features, such as current capacity, operating force, travel characteristics and actuators, lets you custom fit the switch to your application.

The switches are available in their compact basic form, or enclosed in a rugged, metal housing.

Features

- Compact housings are ideal for use where space is restricted
- Precision, snap-action operators provide accurate repeatability of electrical and mechanical operating characteristics
- High current capacity (up to 20A) allows power load switching and motor handling capability
- Enclosed booted versions shield actuators from debris

Contents

Description

	<i>Page</i>
E47 Precision Switches	
Product Selection	
Basic Switches	V8-T2-7
Enclosed Switches	V8-T2-8
Accessories	V8-T2-9
Technical Data and Specifications	V8-T2-9
Dimensions	V8-T2-13

Drawings Online

Operating Characteristics

Definitions

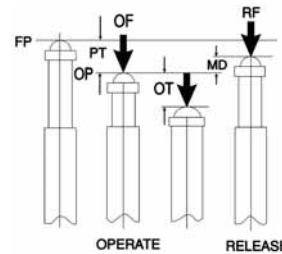

- OF—Operating Force
- RF—Return Force
- PT—Pre-Travel
- OT—Over-Travel
- MD—Movement Differential
- FP—Free Position
- OP—Operating Position

Standards and Certifications

- UL Recognized, E117028
- UL tested to Canadian safety standards
- RoHS Compliant



DANGER

THIS SENSOR IS NOT A SAFETY DEVICE AND IS NOT INTENDED TO BE USED AS A SAFETY DEVICE. This sensor is designed only to detect and read certain data in an electronic manner and perform no use apart from that, specifically no safety-related use. This sensor product does not include self-checking redundant circuitry, and the failure of this sensor product could cause either an energized or de-energized output condition, which could result in death, serious bodily injury, or property damage.

For the most current information on this product, visit our Web site: www.eaton.com

For Customer Service in the U.S. call 1-877-ETN CARE (386-2273), in Canada call 1-800-268-3578. For Application Assistance in the U.S. and Canada call 1-800-426-9184.

Product Selection

Basic Switches

E47 Precision Switches—Basic

	Type	15A Catalog Number	20A Catalog Number
Pin Plunger 	Pin Plunger		
	Screw terminal	E47BMS01	E47CMS01
	Solder terminal	E47BML01	E47CML01 ①
Extended Plunger 	Extended Plunger		
	Screw terminal	E47BMS03	—
	Solder terminal	E47BML03	—
Straight Plunger 	Straight Plunger		
	Screw terminal	E47BMS02	E47CMS02
	Solder terminal	E47BML02	E47CML02
Reversed Lever 	Reversed Lever		
	Screw terminal	E47BMS21	—
	Solder terminal	E47BML21	—
	Spade terminal	E47BMT21	—
Straight Lever 	Straight Lever		
	Screw terminal	E47BMS22	E47CMS22
	Solder terminal	E47BML22	—
Standard Lever 	Standard Lever		
	Screw terminal	E47BMS20	—
	Solder terminal	E47BML20	—
Extended Straight Plunger 	Extended Straight Plunger		
	Screw terminal	E47BMS04	E47CMS04
	Screw terminal (with space lugs)	E47BMT04	—
	Solder terminal	E47BML04	E47CML04

	Type	15A Catalog Number	20A Catalog Number
Roller Plunger 	Roller Plunger		
	Screw terminal	E47BMS10	E47CMS10
	Solder terminal	E47BML10	—
Cross Roller Plunger 	Cross Roller Plunger		
	Screw terminal	E47BMS11	E47CMS11
	Solder terminal	E47BML11	—
Reversed Roller Lever 	Reversed Roller Lever		
	Screw terminal	E47BMS41	—
	Solder terminal	E47BML41	—
Extended Roller Lever 	Extended Roller Lever		
	Screw terminal	E47BMS42	E47CMS42
	Solder terminal	E47BML42	—
Roller Lever 	Roller Lever		
	Screw terminal	E47BMS30	E47CMS30
	Solder terminal	E47BML30	—
	Spade terminal	E47BMT30	E47CMT30
One-Way Roller 	One-Way Roller		
	Screw terminal	E47BMS31	—
	Solder terminal	E47BML31	—
Integral Leaf 	Integral Leaf		
	Screw terminal	E47BMS23	E47CMS23
	Solder terminal	E47BML23	—

Note

① Contact Eaton’s Sensor Applications Department at 1-800-426-9184 for approval status.

2.1

Limit Switches

E47 Precision Switches

2

E47 Precision Switches—Basic, continued

Type	15A Catalog Number	20A Catalog Number
Adjustable Roller	Adjustable Roller	
Screw terminal	E47BMS40	—
Solder terminal	E47BML40	—
Extended Adjustable Roller	Extended Adjustable Roller	
Screw terminal	E47BMS43	—
Solder terminal	E47BML43	—



Enclosed Switches

E47 Precision Switches—Enclosed

Type	Catalog Number
Plunger Actuator	Plunger Actuator
	E47BLS05
	E47CLS05 ①②
Booted Plunger	Booted Plunger
	E47BLS06
	E47CLS06 ①②
Roller Lever	Roller Lever
	E47BLS32
	E47CLS32 ①②



E47 Precision Switches—Enclosed, continued

Type	Catalog Number
Booted Roller Lever	Booted Roller Lever
	E47BLS33
Roller Plunger	Roller Plunger
	E47BLS07
	E47BLS11 ③
Booted Roller Plunger	Booted Roller Plunger
	E47BLS08
	E47BLS12 ③
One-Way Roller	One-Way Roller
	E47BLS34
Booted One-Way Roller	Booted One-Way Roller
	E47BLS35
Booted Wobble	Booted Wobble
	E47BLS14





Notes

- ① Contact Eaton's Sensor Applications Department at 1-800-426-9184 for approval status.
- ② 20 ampere version.
- ③ Cross roller unit.

Accessories

Terminal Wire Covers for Basic Switches

	Description	Catalog Number
45° 	Terminal wire cover with 45° conduit interface	E47PA1
90° 	Terminal wire cover with 90° conduit interface	E47PA2

Technical Data and Specifications

E47 Precision Switches

Description	Specification
Operating speed	0.01m/second to 1m/second
Operating Frequency	
Mechanical	120 operations/minute
Electrical	20 operations/minute
Mechanical life	3,000,000 operations minimum
Electrical life	500,000 operations minimum
Contact resistance	15M ohms maximum, initial
Insulation resistance	100M ohms minimum at 500 Vdc
Dielectric Strength	
Between non-current carrying parts	1000 Vac, 50/60 Hz for 1 minute
Between current carrying parts and ground	2000 Vac, 50/60 Hz for 1 minute
Ambient Operating Temperature	
Basic	-13° to 176°F (-25° to 80°C)
Enclosed	5° to 176°F (-15° to 80°C)
Environmental rating enclosed, booted	NEMA 1
Mounting centers	1.0 in (25.4 mm), #8 screw size
Terminal screws	Bottom facing M4 x 0.7 Screws with cup washers will accept 22–12 AWG (2.5 sq. mm maximum) Maximum torque: 10 in-lbs.
Threaded bushing	15/32 in
Material of construction	Mineral filled phenolic
Enclosure rating	Aluminum die casting (ADC-3/A380); Seal boot: nitrile, butyl rubber (NBR)
Conduit fitting on enclosed type	1/2 in NPT

2.1

Limit Switches

E47 Precision Switches

2

Maximum Ampere Ratings ^{①②}

Model	Rated Voltage	Non-Inductive Load (A)			Inductive Load (A)			Inrush Current (A)	
		Resistive Load NC and NO	Lamp Load NC	NO	Inductive Load NC and NO	Motor Load NC	NO	NC	NO
15A	125 Vac	15	3	1.5	15	5	2.5	30 max.	15 max.
	250 Vac	15	2.5	1.25	15	3	1.5		
	500 Vac	3	1.5	0.75	2.5	1.5	0.75		
	8 Vdc	15	3	1.5	15	5	2.5		
	14 Vdc	15	3	1.5	10	5	2.5		
	30 Vdc	6 (2)	3	1.5	5	5	2.5		
	125 Vdc	0.4	0.4	0.4	0.05	0.05	0.05		
	250 Vdc	0.2	0.2	0.2	0.03	0.03	0.03		
20A	125 Vac	20	7.5	7.5	20	12.5	12.5	60 max.	30 max.
	250 Vac	20	7.5	7.5	20	8.3	8.3		
	500 Vac	6	4	4	5	2	2		
	8 Vdc	20	3	1.5	20	12.5	12.5		
	14 Vdc	20	3	1.5	15	12.5	12.5		
	30 Vdc	6	3	1.5	5	5	5		
	125 Vdc	0.5	0.5	0.5	0.05	0.05	0.05		
	250 Vdc	0.25	0.25	0.25	0.03	0.03	0.03		

Terminal Configurations

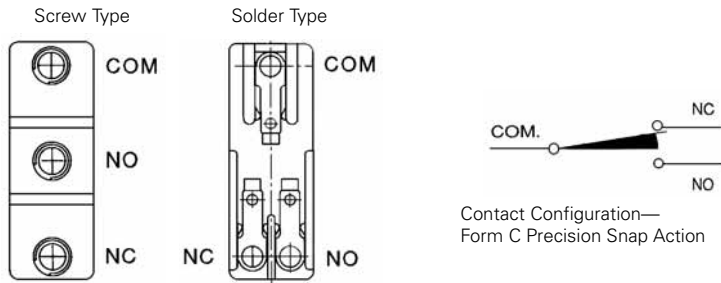

(Spade type not shown, available on some models)

Notes

- ① Inductive load has a power factor of 0.04 minimum (AC) and a time constant of 7 m/second (DC).
- ② Lamp load has an inrush current of six times steady-state current.

E47 Precision Switch Specifications—15 A

Catalog Number	E47B...01-V	E47B...02-V	E47B...03-V	E47B...04-V	E47B...05-V	E47B...06-V	E47B...07-V
Operating force (max.)	12.35 oz (350 g)	12.35 oz (350 g)	12.35 oz (350 g)	12.35 oz (350 g)	8.82–12.3 oz (250–350 g)	28.22 oz (800 g)	8.82–12.3 oz (250–350 g)
Return force (min.)	—	—	—	—	4.02 oz (114 g)	8.47 oz (240 g)	4.02 oz (114 g)
Return force (max.)	4.02 oz (114 g)	4.02 oz (114 g)	4.02 oz (114 g)	4.02 oz (114 g)	—	—	—
Pre-travel (max.)	0.016 in (0.4 mm)	0.016 in (0.4 mm)	0.016 in (0.4 mm)	0.016 in (0.4 mm)	0.016 in (0.4 mm)	0.079 in (2 mm)	0.02 in (0.5 mm)
Overtravel (max.)	0.005 in (0.13 mm)	0.063 in (1.6 mm)	0.063 in (1.6 mm)	0.217 in (5.5 mm)	0.217 in (5.5 mm)	0.197 in (5 mm)	0.142 in (3.6 mm)
Movement differential (max.)	0.002 in (0.05 mm)	0.002 in (0.05 mm)	0.002 in (0.05 mm)	0.002 in (0.05 mm)	0.002 in (0.05 mm)	0.004 in (0.1 mm)	0.002 in (0.05 mm)
Free position (max.)	—	—	—	—	—	—	—
Operating position (max.)	0.626 in (15.9 mm)	0.846 in (21.5 mm)	1.11 in (28.2 mm)	0.858 in (21.8 mm)	1.504 in (38.2 mm)	1.803 in (45.8 mm)	1.957 in (49.7 mm)

Catalog Number	E47B...08-V	E47B...10-V	E47B...11-V	E47B...11-V Cross Roller Unit	E47B...12-V Cross Roller Unit	E47B...14-V	E47B...20-V
Operating force (max.)	17.64 oz (500 g)	12.35 oz (350 g)	12.35 oz (350 g)	8.82–12.3 oz (250–350 g)	17.64 oz (500 g)	2.12 oz (60 g)	3.53 oz (100 g)
Return force (min.)	3.53 oz (100 g)	—	—	4.02 oz (114 g)	3.53 oz (100 g)	0.88 oz (25 g)	0.99 oz (28 g)
Return force (max.)	—	4.02 oz (114 g)	4.02 oz (114 g)	—	—	—	—
Pre-travel (max.)	0.039 in (1 mm)	0.016 in (0.4 mm)	0.016 in (0.4 mm)	0.02 in (0.5 mm)	0.039 in (1 mm)	0.52 in (13.2 mm)	0.197 in (5 mm)
Overtravel (max.)	0.138 in (3.5 mm)	0.141 in (3.58 mm)	0.141 in (3.58 mm)	0.142 in (3.6 mm)	0.138 in (3.5 mm)	0.315 in (8 mm)	0.079 in (2 mm)
Movement differential (max.)	0.005 in (0.12 mm)	0.002 in (0.05 mm)	0.002 in (0.05 mm)	0.002 in (0.05 mm)	0.005 in (0.12 mm)	0.039 in (1 mm)	0.039 in (1 mm)
Free position (max.)	—	—	—	—	—	—	0.976 in (24.8 mm)
Operating position (max.)	1.957 in (49.7 mm)	1.315 in (33.4 mm)	1.315 in (33.4 mm)	1.957 in (49.7 mm)	1.957 in (49.7 mm)	—	0.748 in (19 mm)

Catalog Number	E47B...21-V	E47B...22-V	E47B...23-V	E47B...30-V	E47B...31-V	E47B...32-V	E47B...33-V
Operating force (max.)	5.29 oz (150 g)	2.47 oz (70 g)	0.35 oz (10 g)	5.64 oz (160 g)	5.64 oz (160 g)	20.11 oz (570 g)	22.58 oz (640 g)
Return force (min.)	—	0.49 oz (14 g)	0.11 oz (3 g)	1.48 oz (42 g)	1.48 oz (42 g)	6 oz (170 g)	8.11 oz (230 g)
Return force (max.)	0.49 oz (14 g)	—	—	—	—	—	—
Pre-travel (max.)	0.157 in (4 mm)	0.394 in (10 mm)	0.787 in (20 mm)	0.106 in (2.7 mm)	0.106 in (2.7 mm)	0.157 in (4 mm)	0.197 in (5 mm)
Overtravel (max.)	0.063 in (1.6 mm)	0.22 in (5.6 mm)	0.22 in (5.6 mm)	0.094 in (2.4 mm)	0.094 in (2.4 mm)	0.236 in (6 mm)	0.236 in (6 mm)
Movement differential (max.)	0.051 in (1.3 mm)	0.051 in (1.3 mm)	0.118 in (3 mm)	0.02 in (0.5 mm)	0.02 in (0.5 mm)	0.016 in (0.4 mm)	0.016 in (0.4 mm)
Free position (max.)	0.811 in (20.6 mm)	1.11 in (28.2 mm)	—	1.28 in (32.5 mm)	1.717 in (43.6 mm)	—	—
Operating position (max.)	0.685 in (17.4 mm)	0.748 in (19 mm)	0.748 in (19 mm)	1.189 in (30.2 mm)	1.697 in (43.1 mm)	—	—

Catalog Number	E47B...34-V	E47B...35-V	E47B...40-V	E47B...41-V	E47B...42-V	E47B...43-V
Operating force (max.)	20.11 oz (570 g)	22.58 oz (640 g)	17.64 oz (500 g)	5.29 oz (150 g)	5.64 oz (160 g)	21.16 oz (600 g)
Return force (min.)	6 oz (170 g)	8.11 oz (230 g)	6 oz (170 g)	—	0.78 oz (22 g)	10.58 oz (300 g)
Return force (max.)	—	—	—	0.49 oz (14 g)	—	—
Pre-travel (max.)	0.157 in (4 mm)	0.197 in (5 mm)	0.197 in (5 mm)	0.157 in (4 mm)	0.28 in (7.1 mm)	0.118 in (3 mm)
Overtravel (max.)	0.236 in (6 mm)	0.236 in (6 mm)	0.5 in (12.7 mm)	0.063 in (1.6 mm)	0.157 in (4 mm)	0.236 in (6 mm)
Movement differential (max.)	0.016 in (0.4 mm)	0.016 in (0.4 mm)	0.087 in (2.2 mm)	0.051 in (1.3 mm)	0.04 in (1.02 mm)	0.079 in (2 mm)
Free position (max.)	—	—	1.752 in (44.5 mm)	1.252 in (31.8 mm)	1.437 in (36.5 mm)	1.614 in (41 mm)
Operating position (max.)	—	—	1.591 in (40.4 mm)	1.126 in (28.6 mm)	1.189 in (30.2 mm)	1.591 in (40.4 mm)

E47 Precision Switch Specifications—20 A

Catalog Number	E47C...01-V	E47C...02-V	E47C...03-V	E47C...04-V	E47C...05-V	E47C...06-V	E47C...07-V
Operating force (max.)	22.93 oz (650 g)	22.93 oz (650 g)	22.93 oz (650 g)	22.93 oz (650 g)	8.82–12.3 oz (250–350 g)	28.22 oz (800 g)	8.82–12.3 oz (250–350 g)
Return force (min.)	7.05 oz (200 g)	7.05 oz (200 g)	7.05 oz (200 g)	7.05 oz (200 g)	4.02 oz (114 g)	8.47 oz (240 g)	4.02 oz (114 g)
Return force (max.)	—	—	—	—	—	—	—
Pre-travel (max.)	0.028 in (0.7 mm)	0.028 in (0.7 mm)	0.028 in (0.7 mm)	0.028 in (0.7 mm)	0.016 in (0.4 mm)	0.079 in (2 mm)	0.02 in (0.5 mm)
Overtravel (max.)	0.005 in (0.13 mm)	0.063 in (1.6 mm)	0.063 in (1.6 mm)	0.217 in (5.5 mm)	0.217 in (5.5 mm)	0.197 in (5 mm)	0.142 in (3.6 mm)
Movement differential (max.)	0.008 in (0.2 mm)	0.008 in (0.2 mm)	0.002 in (0.05 mm)	0.008 in (0.2 mm)	0.002 in (0.05 mm)	0.004 in (0.1 mm)	0.002 in (0.05 mm)
Free position (max.)	—	—	—	—	—	—	—
Operating position (max.)	0.642 in (16.3 mm)	0.866 in (22 mm)	1.13 in (28.7 mm)	0.89 in (22.6 mm)	1.504 in (38.2 mm)	1.803 in (45.8 mm)	1.957 in (49.7 mm)

Catalog Number	E47C...08-V	E47C...10-V	E47C...11-V	E47C...11-V Cross Roller Unit	E47C...12-V Cross Roller Unit	E47C...14-V	E47C...20-V
Operating force (max.)	17.64 oz (500 g)	22.93 oz (650 g)	22.93 oz (650 g)	8.82–12.3 oz (250–350 g)	17.64 oz (500 g)	2.12 oz (60 g)	5.64 oz (160 g)
Return force (min.)	3.53 oz (100 g)	7.05 oz (200 g)	7.05 oz (200 g)	4.02 oz (114 g)	3.53 oz (100 g)	0.88 oz (25 g)	1.48 oz (42 g)
Return force (max.)	—	—	—	—	—	—	—
Pre-travel (max.)	0.039 in (1 mm)	0.028 in (0.7 mm)	0.028 in (0.7 mm)	0.02 in (0.5 mm)	0.039 in (1 mm)	0.52 in (13.2 mm)	0.256 in (6.5 mm)
Overtravel (max.)	0.138 in (3.5 mm)	0.141 in (3.58 mm)	0.141 in (3.58 mm)	0.142 in (3.6 mm)	0.138 in (3.5 mm)	0.315 in (8 mm)	0.047 in (1.2 mm)
Movement differential (max.)	0.005 in (0.12 mm)	0.008 in (0.2 mm)	0.008 in (0.2 mm)	0.002 in (0.05 mm)	0.005 in (0.12 mm)	0.039 in (1 mm)	0.047 in (1.2 mm)
Free position (max.)	—	—	—	—	—	—	—
Operating position (max.)	1.957 in (49.7 mm)	1.362 in (34.6 mm)	1.362 in (34.6 mm)	1.957 in (49.7 mm)	1.957 in (49.7 mm)	—	0.78 in (19.8 mm)

Catalog Number	E47C...21-V	E47C...22-V	E47C...23-V	E47C...30-V	E47C...31-V	E47C...32-V	E47C...33-V
Operating force (max.)	12.35 oz (350 g)	2.82 oz (80 g)	0.35 oz (10 g)	6.35 oz (180 g)	5.64 oz (160 g)	20.11 oz (570 g)	22.58 oz (640 g)
Return force (min.)	1.76 oz (50 g)	0.49 oz (14 g)	0.11 oz (3 g)	1.48 oz (42 g)	1.48 oz (42 g)	6 oz (170 g)	8.11 oz (230 g)
Return force (max.)	—	—	—	—	—	—	—
Pre-travel (max.)	0.157 in (4 mm)	0.394 in (10 mm)	0.787 in (20 mm)	0.106 in (2.7 mm)	0.106 in (2.7 mm)	0.157 in (4 mm)	0.197 in (5 mm)
Overtravel (max.)	0.063 in (1.6 mm)	0.22 in (5.6 mm)	0.22 in (5.6 mm)	0.094 in (2.4 mm)	0.094 in (2.4 mm)	0.236 in (6 mm)	0.236 in (6 mm)
Movement differential (max.)	0.051 in (1.3 mm)	0.05 in (1.27 mm)	0.118 in (3 mm)	0.02 in (0.5 mm)	0.02 in (0.5 mm)	0.016 in (0.4 mm)	0.016 in (0.4 mm)
Free position (max.)	0.811 in (20.6 mm)	1.11 in (28.2 mm)	—	1.28 in (32.5 mm)	1.717 in (43.6 mm)	—	—
Operating position (max.)	0.717 in (18.2 mm)	0.78 in (19.8 mm)	0.748 in (19 mm)	1.205 in (30.6 mm)	1.697 in (43.1 mm)	—	—

Catalog Number	E47C...34-V	E47C...35-V	E47C...40-V	E47C...41-V	E47C...42-V	E47C...43-V
Operating force (max.)	20.11 oz (570 g)	22.58 oz (640 g)	17.64 oz (500 g)	12.35 oz (350 g)	4.23 oz (120 g)	21.16 oz (600 g)
Return force (min.)	6 oz (170 g)	8.11 oz (230 g)	6 oz (170 g)	1.76 oz (50 g)	0.78 oz (22 g)	10.58 oz (300 g)
Return force (max.)	—	—	—	—	—	—
Pre-travel (max.)	0.157 in (4 mm)	0.197 in (5 mm)	0.197 in (5 mm)	0.157 in (4 mm)	0.28 in (7.1 mm)	0.118 in (3 mm)
Overtravel (max.)	0.236 in (6 mm)	0.236 in (6 mm)	0.5 in (12.7 mm)	0.063 in (1.6 mm)	0.157 in (4 mm)	0.236 in (6 mm)
Movement differential (max.)	0.016 in (0.4 mm)	0.016 in (0.4 mm)	0.087 in (2.2 mm)	0.051 in (1.3 mm)	0.04 in (1.02 mm)	0.079 in (2 mm)
Free position (max.)	—	—	1.752 in (44.5 mm)	1.252 in (31.8 mm)	1.437 in (36.5 mm)	1.614 in (41 mm)
Operating position (max.)	—	—	1.591 in (40.4 mm)	1.157 in (29.4 mm)	1.575 in (40 mm)	1.591 in (40.4 mm)

Dimensions

Approximate Dimensions in Inches [mm]

Basic Switches

Pin Plunger

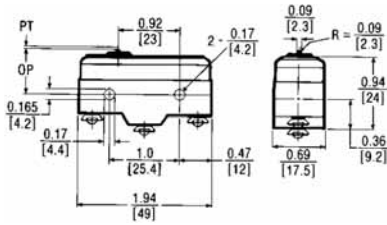

Standard Lever

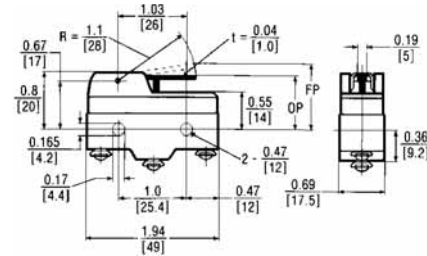

Extended Plunger

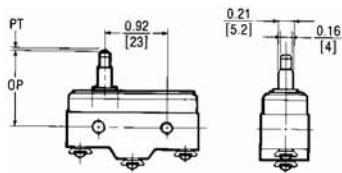

Extended Straight Plunger

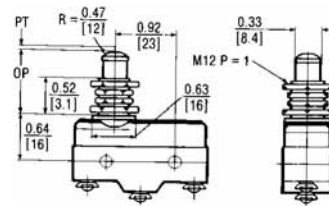

Straight Plunger

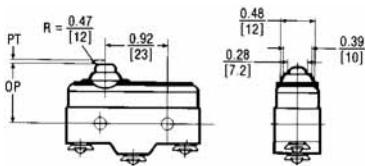

Roller Plunger

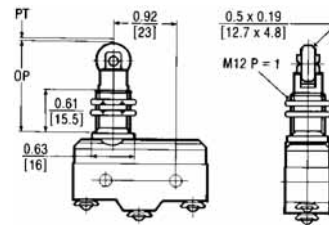

Reversed Lever

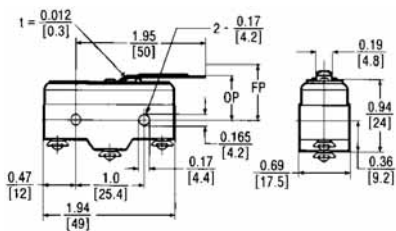

Cross Roller Plunger

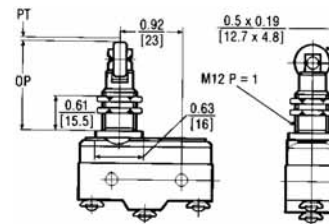

Straight Lever

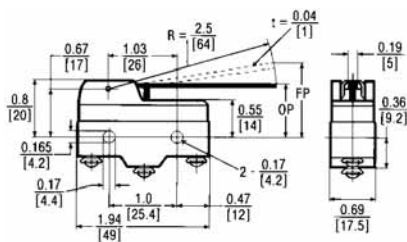

Reversed Roller Lever

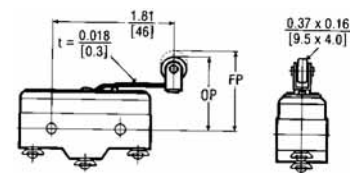

2.1

Limit Switches

E47 Precision Switches

Approximate Dimensions in Inches [mm]

2

Extended Roller Lever

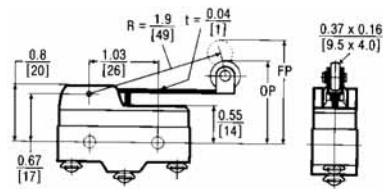

Integral Leaf

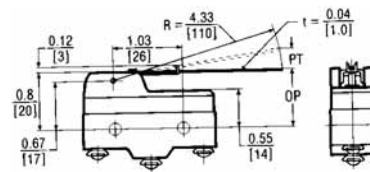

Roller Lever

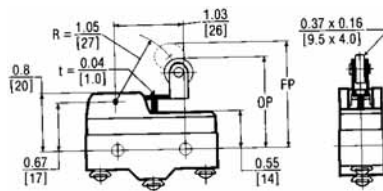

Adjustable Roller

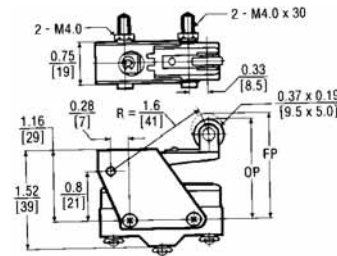

One-Way Roller

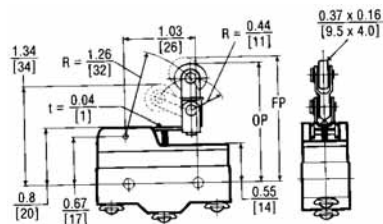

Extended Adjustable Roller

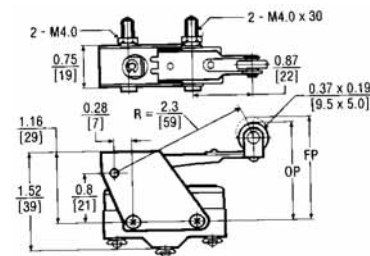

Enclosed Switches

Plunger Actuator

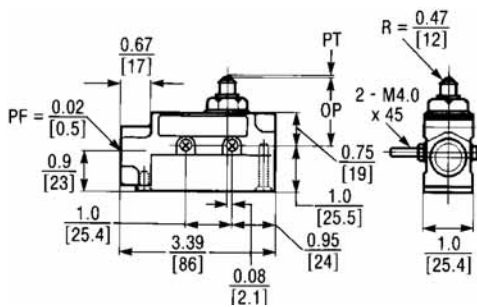

Roller Lever

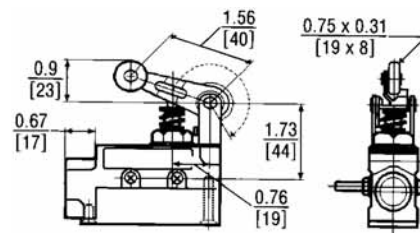

Booted Plunger

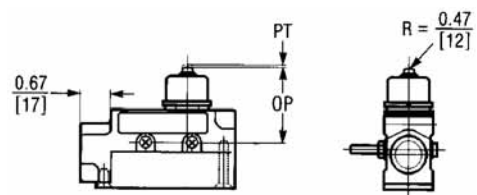

Booted Roller Lever

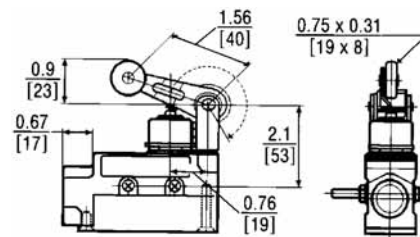

Approximate Dimensions in Inches [mm]

Roller Plunger

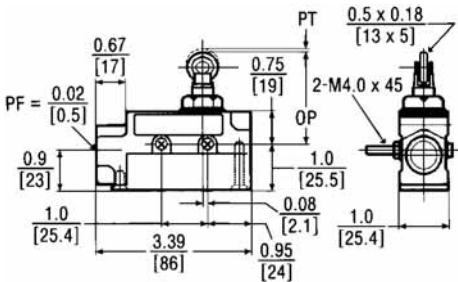

Booted One-Way Roller

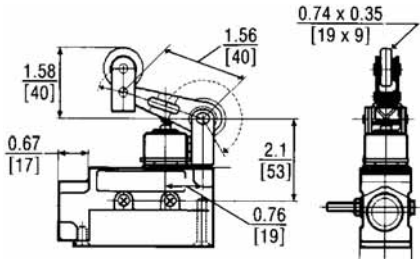

Booted Roller Plunger

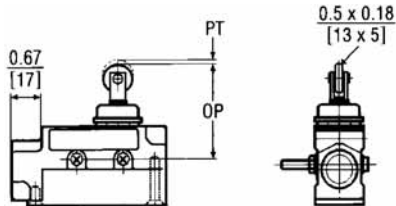

Booted Wobble

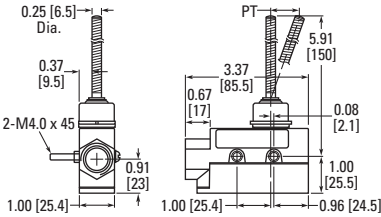

One-Way Roller

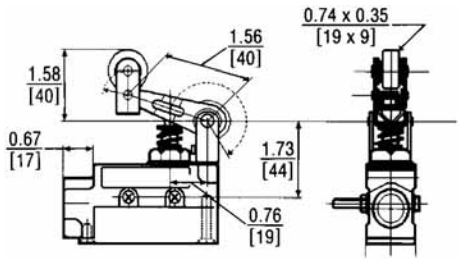

Accessories

Approximate Dimensions in mm

Terminal Wire Cover with 45° Conduit Interface

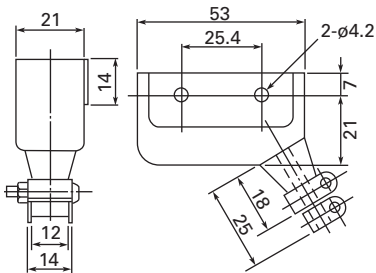

Terminal Wire Cover with 90° Conduit Interface

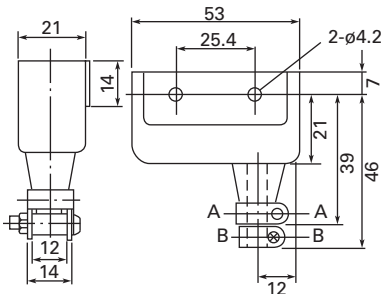

Compact Prewired Switches

2



Contents

Description

	<i>Page</i>
Compact Prewired Switches	
Product Selection	V8-T2-17
Technical Data and Specifications	V8-T2-18
Wiring Diagram	V8-T2-19
Dimensions	V8-T2-19

 Drawings
Online

Compact Prewired Switches

Product Description

The E47 Compact Prewired Limit Switch by Eaton's electrical sector is designed to be a versatile, slim device for hard to fit applications where sealing integrity is required. The rugged die cast aluminum alloy housing, cable connection and switch mechanism are encapsulated for protection against contaminants, moisture, shock and vibration. This factory wired (3m) device has NEMA® enclosure ratings of 4, 6 and 13, making it suitable for applications such as machine tool, food processing and packaging.

Features

- Rugged aluminum alloy die cast housing
- Sealed construction with enclosure ratings of NEMA 4, 6 and 13
- Prewired with 3m of 18 AWG, AWM 2517, 300V cable, or micro-connector version also available
- Stackable ridge for ganged operation

Standards and Certifications

- UL Listed, E170645 (cable versions only)
- UL tested to Canadian safety standards
- CE
- RoHS Compliant



DANGER

THIS SENSOR IS NOT A SAFETY DEVICE AND IS NOT INTENDED TO BE USED AS A SAFETY DEVICE. This sensor is designed only to detect and read certain data in an electronic manner and perform no use apart from that, specifically no safety-related use. This sensor product does not include self-checking redundant circuitry, and the failure of this sensor product could cause either an energized or de-energized output condition, which could result in death, serious bodily injury, or property damage.

For the most current information on this product, visit our Web site: www.eaton.com





For Customer Service in the U.S. call 1-877-ETN CARE (386-2273), in Canada call 1-800-268-3578. For Application Assistance in the U.S. and Canada call 1-800-426-9184.

Product Selection

Compact Prewired Switches

Actuator Type	Operating Force (Maximum)	Reset Force (Minimum)	Over-Travel (Maximum)	Pre-Travel	Movement Differential (Maximum)	Operating Position	Standard Version Catalog Number	Connector Version Catalog Number
 Pin Plunger	42.3 oz (1.2 kg)	15.9 oz (450g)	0.118 in (3 mm)	0.07 in (1.8 mm)	0.008 in (0.2 mm)	0.62 ± 0.04 in (15.7 ± 1 mm)	E47BCC05	E47BCC05P4
 Sealed Plunger	63.5 oz (1.8 kg)	15.9 oz (450g)	0.118 in (3 mm)	0.07 in (1.8 mm)	0.008 in (0.2 mm)	0.99 ± 0.04 in (24.9 ± 1 mm)	E47BCC06	E47BCC06P4
 Roller Plunger	42.3 oz (1.2 kg)	15.9 oz (450g)	0.118 in (3 mm)	0.07 in (1.8 mm)	0.008 in (0.2 mm)	1.12 ± 0.04 in (28.5 ± 1 mm)	E47BCC07	E47BCC07P4
 Sealed Roller Plunger	63.5 oz (1.8 kg)	15.9 oz (450g)	0.118 in (3 mm)	0.07 in (1.8 mm)	0.008 in (0.2 mm)	1.35 ± 0.04 in (34.3 ± 1 mm)	E47BCC08	E47BCC08P4
 Cross Roller Plunger	42.3 oz (1.2 kg)	15.9 oz (450g)	0.118 in (3 mm)	0.07 in (1.8 mm)	0.008 in (0.2 mm)	1.12 ± 0.04 in (28.5 ± 1 mm)	E47BCC11	E47BCC11P4
 Sealed Cross Roller Plunger	63.5 oz (1.8 kg)	15.9 oz (450g)	0.118 in (3 mm)	0.07 in (1.8 mm)	0.008 in (0.2 mm)	1.35 ± 0.04 in (34.3 ± 1 mm)	E47BCC12	E47BCC12P4
 Bevel Plunger	42.3 oz (1.2 kg)	15.9 oz (450g)	0.118 in (3 mm)	0.07 in (1.8 mm)	0.008 in (0.2 mm)	1.12 ± 0.04 in (28.5 ± 1 mm)	E47BCC13	E47BCC13P4

Compact Prewired Switches, continued

Actuator Type	Operating Force (Maximum)	Reset Force (Minimum)	Over-Travel (Maximum)	Pre-Travel	Movement Differential (Maximum)	Operating Position	Standard Version Catalog Number	Connector Version Catalog Number
Roller Lever 	Roller Lever							
	20.5 oz (580g)	5.3 oz (150g)	40°	25° max.	3°	—	E47BCC15	E47BCC15P4
Wobble Stick 	Wobble Stick							
	5.3 oz (150g)	—	—	15° max.	—	—	E47BCC20	E47BCC20P4
Rod Lever 	Rod Lever							
	20.5 oz (580g)	5.3 oz (150g)	40°	25° max.	3°	—	—	E47BCC21P4
Adjustable Level Arm 	Adjustable Level Arm							
	20.5 oz (580g)	5.3 oz (150g)	40°	25° max.	3°	—	E47BCC22	E47BCC22P4

Technical Data and Specifications

Compact Prewired Switches

Description	Specification
Contacts	1-SPDT (Form C)
Mechanical life	10,000,000 operations
Electrical life	200,000 operations, 30 operation/min. at rated load
Operating speed	30 operations per minute maximum
Operating temperature range	-10° to 70°C (14° to 158°F)
Storage temperature range	-10° to 70°C (14° to 158°F)
Humidity	95% maximum non-condensing
Vibration	Malfunction durability, 10 to 55 Hz 1.5 mm double amplitude
Shock	Malfunction durability, approximately 50G
Enclosure ratings	NEMA 4, 6 and 13; IEC IP69K

Maximum Ampere Ratings ①

Rated Voltage	Non-Inductive Load (A)		Inductive Load (A)		Motor Load		Inrush Current (A)	
	NC	NO	NC	NO	NC	NO	NC	NO
125 Vac	5	5	3	3	2.5	1.3	20 max.	10 max.
250 Vac	5	5	2	2	1.5	0.8		
8 Vdc	5	5	5	4	1.5	1.5		
14 Vdc	5	5	4	4	1.5	1.5		
30 Vdc	4	4	3	3	1.5	1.5		
125 Vdc	0.4	0.4	0.4	0.4	0.05	0.05		
250 Vdc	0.2	0.2	0.2	0.2	0.03	0.03		

Wiring Diagram

Compact Prewired Switches

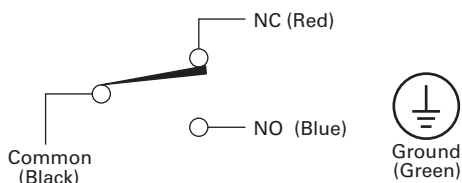

Micro-Connector Switches

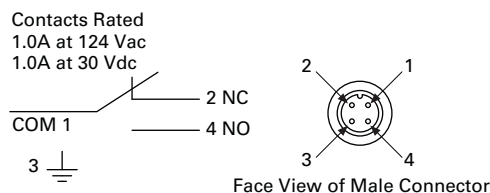

Note

① Inductive load ratings are tested at a power factor 0.4 min. for AC power and a time constant of 7 ms max. for DC power. Inrush current for motor load is six times the steady state current.

Dimensions

Approximate Dimensions in mm [in]

E47BCC05

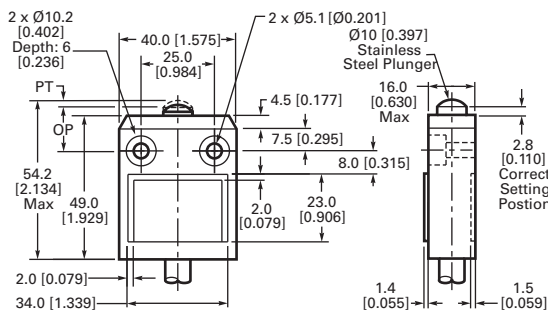

E47BCC07

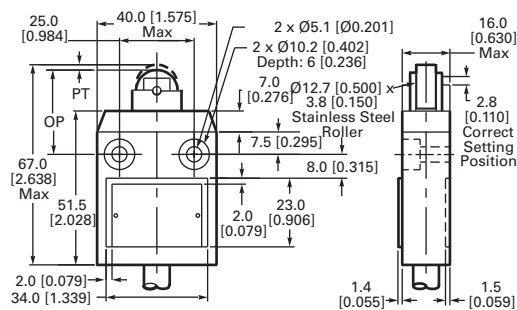

E47BCC06

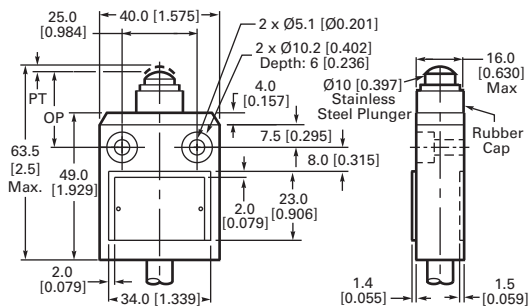

E47BCC08

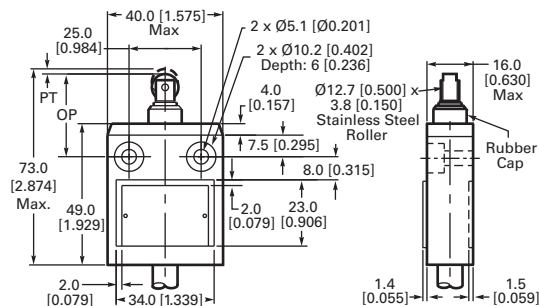

2.2

Limit Switches

Compact Prewired Switches

2

E47BCC11

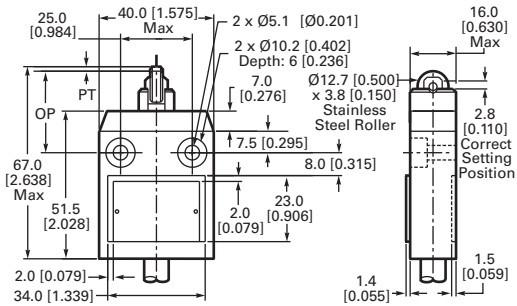

E47BCC20

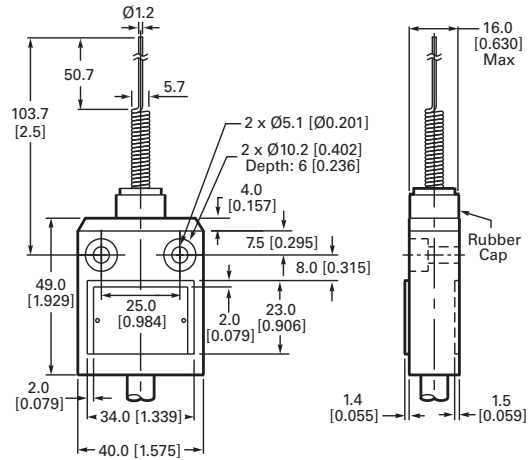

E47BCC12

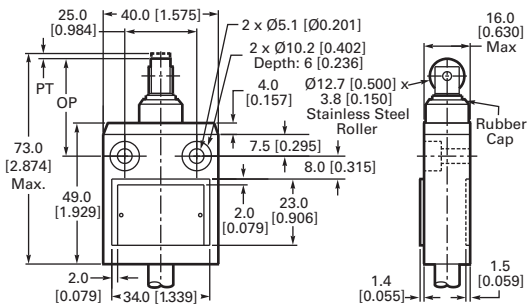

E47BCC21

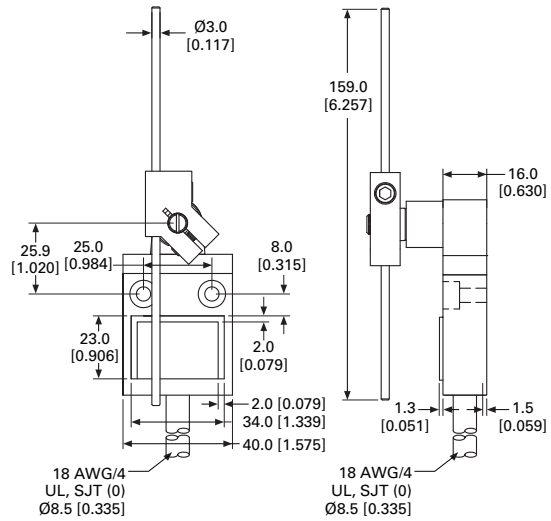

E47BCC13

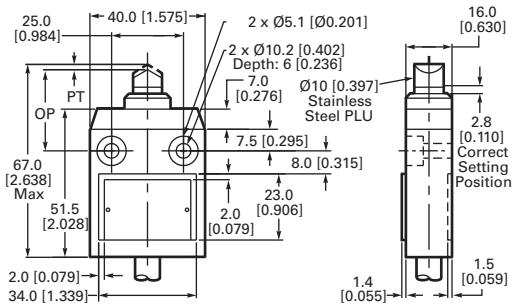

E47BCC22

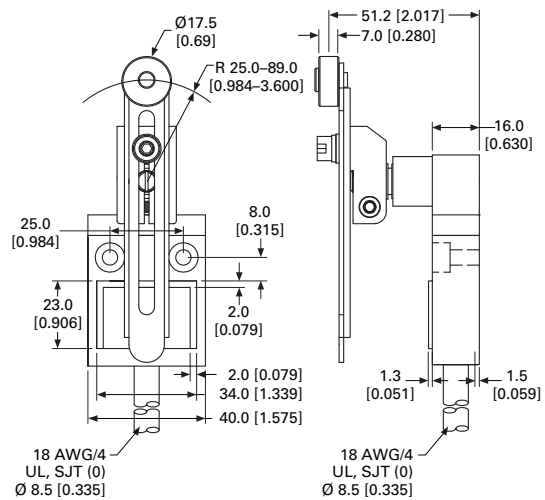

E47BCC15

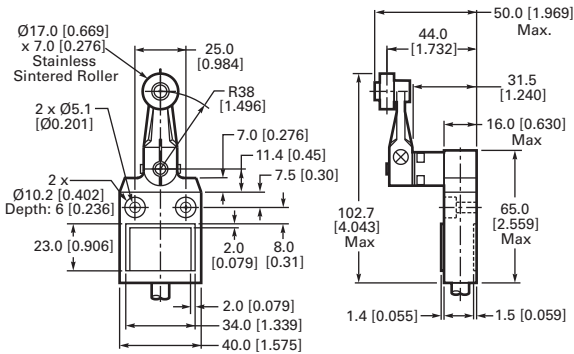

LS-Titan Miniature DIN Switches



Contents

Description	Page
LS-Titan Miniature DIN Switches	
Product Identification	V8-T2-22
Product Selection	V8-T2-23
LS-Titan Plastic Safety Switches	V8-T2-23
LS-Titan Plastic Electronic Safety Position Switches	V8-T2-26
LS-Titan Metal Safety Switches	V8-T2-30
Understanding LS-Titan Electronic Safety Position Switches	V8-T2-32
Operating Point Adjustment	V8-T2-32
Accessories	V8-T2-33
Technical Data and Specifications	V8-T2-34
Contact Travel Diagrams	V8-T2-37
Dimensions	V8-T2-40

LS-Titan Miniature DIN Switches

Product Description

Eaton's LS-Titan™ limit switch line is a complete offering of safety position switches designed for worldwide application. Economical insulated plastic or rugged metal enclosures and modular, plug-in operating heads and bodies make LS-Titan a flexible switching solution.

A highlight of the LS-Titan switch line is the world's first electronic position switch (LSE models). These switches feature freely programmable operating points that can be set individually at any time. Additional LSE models provide analog outputs proportional to the actuator position.

LS-Titan switches are suitable for use in safety applications designed to protect persons or processes.

Features

- Modular, plug-in system (head and body components)
- Positive opening NC contacts for safety applications
- Wide variety of economical plastic and rugged metal versions available
- Operating heads can be rotated 90 degrees to suit specific direction of operation
- Unique electronic safety position switches (LSE models) provide 0–10 Vdc outputs proportional to the actuator position and allow for easy configuration of a custom trip point
- Can be ordered as separate components (head and body) or as completely assembled switches
- Screw and Cage Clamp® (standard on LSE models and optionally available on mechanical models) connections provide larger wiring areas for easier installation
- Approved for worldwide application

Standards and Certifications

- Safety function by positive opening contacts per IEC/EN 60947-5-1
- TÜV-Rheinland Certified for Functional-Safety (LSE models)
- UL Listed, E29184
- CSA Certified, 12528
- RoHS Compliant
- CE
- CCC



Note: Cage Clamp is a registered trademark of Wago Kontakttechnik, 32423 Minden, Germany.

For the most current information on this product, visit our Web site: www.eaton.com

For Customer Service in the U.S. call 1-877-ETN CARE (386-2273), in Canada call 1-800-268-3578.
For Application Assistance in the U.S. and Canada call 1-800-426-9184.

Product Identification

2

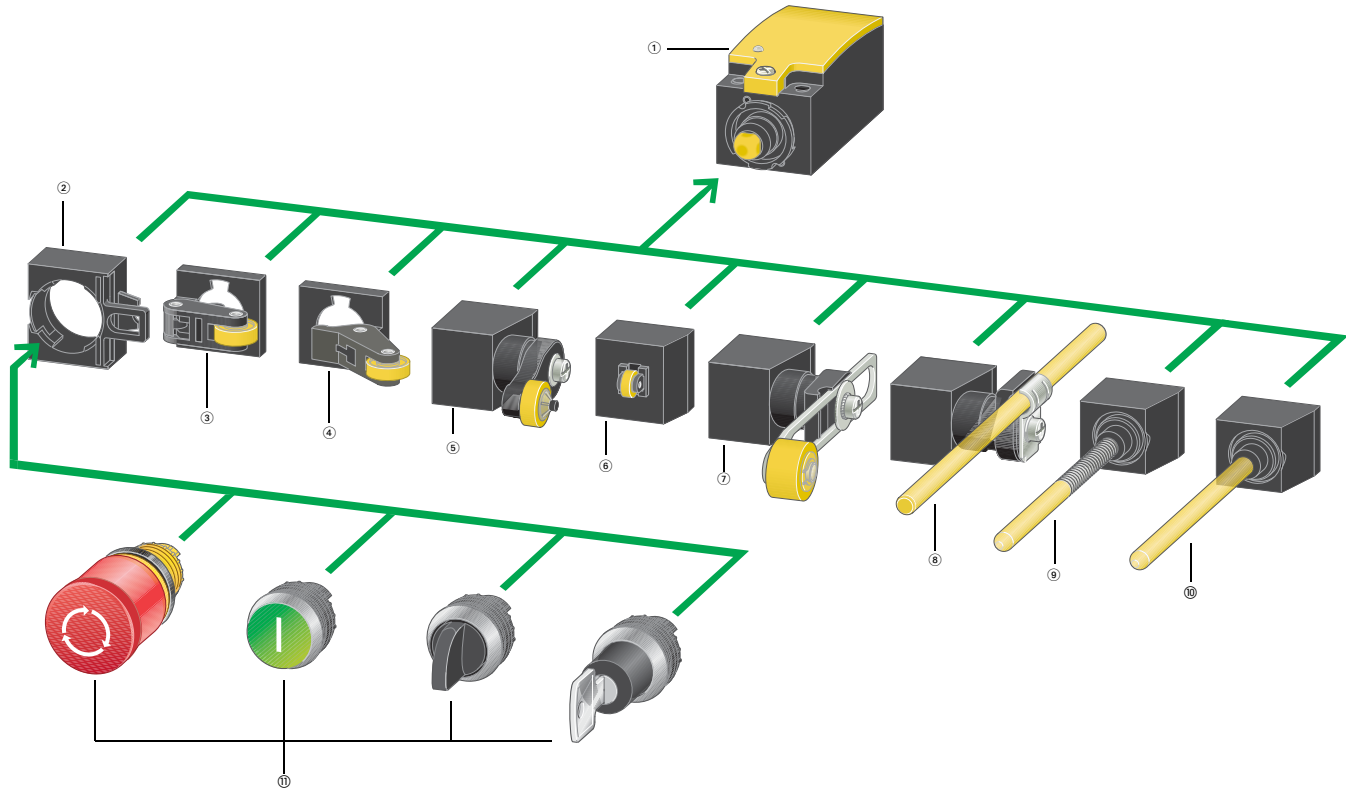

Notes

- ① **Basic device** (see Pages V8-T2-23 to V8-T2-31)
According to EN 50047
With screw-on cover
Contacts: 1NO-1NC, 2NO, 2NC
Cage Clamp, screw terminal
As snap-action or standard-action switch
As electronic snap-action switch (individually adjustable)
As 0–10 Vdc analog signal encoder
- ② **Fixing adapter** (see Page V8-T2-33)
Allows mounting of M22 pushbuttons
- ③ **Roller lever** (see Pages V8-T2-23 and V8-T2-26)
For one-sided operation with higher operating speed
- ④ **Angled roller lever** (see Pages V8-T2-23, V8-T2-26 and V8-T2-30)
For actuation along the unit axis
- ⑤ **Rotary lever** (see Pages V8-T2-23, V8-T2-27 and V8-T2-30)
For actuation from the side, for pendulum movements
- ⑥ **Roller plunger** (see Pages V8-T2-23, V8-T2-26 and V8-T2-30)
For actuation from the side with low actuating force
- ⑦ **Adjustable roller lever** (see Pages V8-T2-24, V8-T2-27, V8-T2-28 and V8-T2-30)
For length adjustment as required
- ⑧ **Actuating rod** (see Pages V8-T2-25, V8-T2-29 and V8-T2-31)
On conveyor belts for lightweight goods
- ⑨ **Spring-rod** (see Pages V8-T2-25, V8-T2-29 and V8-T2-31)
For flexible actuation from all sides
- ⑩ **Actuating rod** (see Pages V8-T2-25, V8-T2-29 and V8-T2-31)
Withdrawable mechanism from front
- ⑪ Pushbuttons from the M22 family; see M22 catalog (CA04716001E) or www.eaton.com/m22

Operating heads can be rotated by 90 degrees.

Product Selection

LS-Titan Plastic Safety Switches

Plastic Safety Switch Body



Assembled Switch



Plastic Safety Switches

Switch Body Catalog Number

Output Function

Terminal Connection

Contact Sequence

Contact Travel

- = contact closed
- = contact open

Operating Head Type ②

Head Only Catalog Number

LS-S02

2NC with positive opening contacts

Screw terminal ①

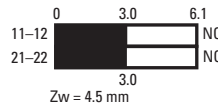

LS-S20A

2NO with slow make/break

Screw terminal ①

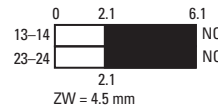

LS-S11S

1NO and 1NC with positive opening contact

Screw terminal ①

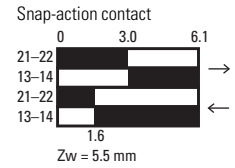

Assembled Switch Catalog Number

Top Push Roller Plunger



LS-XP

LS-S02-P

LS-S20A-P

LS-S11S-P

Long Roller Lever



LS-XL

LS-S02-L

LS-S20A-L

LS-S11S-L

Short Roller Lever



LS-XLS

LS-S02-LS

LS-S20A-LS

LS-S11S-LS

Large Roller Lever



LS-XLB

LS-S02-LB

LS-S20A-LB

LS-S11S-LB

Angled Roller



LS-XLA

LS-S02-LA

LS-S20A-LA

LS-S11S-LA

Rotary Lever



LS-XRL

LS-S02-RL

LS-S20A-RL

LS-S11S-RL

Notes

- ① Cage Clamp versions available. Contact Application Engineering.
- ② For operating head dimensions, see **Page V8-T2-40**.

2.3

Limit Switches

LS-Titan Miniature DIN Switches

2

Plastic Safety Switch Body



Assembled Switch



Plastic Safety Switches, continued

Switch Body Catalog Number

Output Function

Terminal Connection

Contact Sequence

Contact Travel

■ = contact closed

□ = contact open

LS-S02

2NC with positive opening contacts

Screw terminal ①

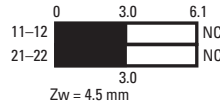

LS-S20A

2NO with slow make/break

Screw terminal ①

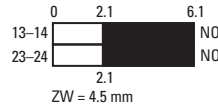

LS-S11S

1NO and 1NC with positive opening contact

Screw terminal ①

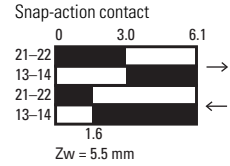

Operating Head Type ②

Head Only Catalog Number

Assembled Switch Catalog Number

Adjustable Roller Lever (with 18 mm Roller)



LS-XRLA

LS-S02-RLA

LS-S20A-RLA

LS-S11S-RLA

Adjustable Roller Lever (with 30 mm Roller)



LS-XRLA30

LS-S02-RLA30

LS-S20A-RLA30

LS-S11S-RLA30

Adjustable Roller Lever (with 40 mm Roller)



LS-XRLA40

LS-S02-RLA40

LS-S20A-RLA40

LS-S11S-RLA40

Adjustable Roller Lever (with 40 mm Rubber Roller)



LS-XRLA40R

LS-S02-RLA40R

LS-S20A-RLA40R

LS-S11S-RLA40R

Notes

① Cage Clamp versions available. Contact Application Engineering.

② For operating head dimensions, see **Page V8-T2-40**.

Plastic Safety Switches, continued

Plastic Safety Switch Body



Assembled Switch



Switch Body Catalog Number

Output Function

Terminal Connection

Contact Sequence

Contact Travel

■ = contact closed

□ = contact open

Operating Head Type ②

Head Only Catalog Number

LS-S02

2NC with positive opening contacts

Screw terminal ①

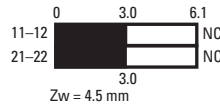

LS-S20A

2NO with slow make/break

Screw terminal ①

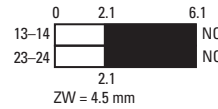

LS-S11S

1NO and 1NC with positive opening contact

Screw terminal ①

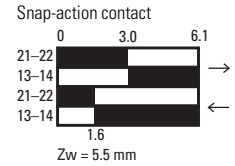

Assembled Switch Catalog Number

Plastic Rod Lever



LS-XRR

LS-S02-RR

LS-S20A-RR

LS-S11S-RR

Metal Rod



LS-XRRM

LS-S02-RRM

LS-S20A-RRM

LS-S11S-RRM

Spring Rod (Wobble) ③



LS-XS

LS-S02-S

LS-S20A-S

LS-S11S-S

Actuating Rod



LS-XOR

LS-S02-OR

LS-S20A-OR

LS-S11S-OR

Notes

- ① Cage Clamp versions available. Contact Application Engineering.
- ② For operating head dimensions, see Page V8-T2-40.
- ③ Not to be used as a safety position switch. Use only in conjunction with snap-action contact.

2.3

Limit Switches

LS-Titan Miniature DIN Switches

LS-Titan Plastic Electronic Safety Position Switches

2

Plastic Electronic Safety Position Switch Body



Assembled Switch



Plastic Electronic Safety Position Switches

Switch Body

Catalog Number

LSE-11

LSE-02

LSE-AU

Output Function

1NO and 1 NC

2NC

Analog 0–10V

Terminal Connections

Cage Clamp ①

Cage Clamp ①

Cage Clamp ①

Safety Functions and Approvals

These models may be used in safety-oriented circuits. Visual status LED indication is comparable to positive opening contacts. Certified by TÜV as a “Functional-Safety” device. Suitable for protection of people or processes.

Additional diagnostic output that registers a 0V signal in the event of a fault. Self-test function continuously tests both outputs for overloads, short circuits to 0V and short circuits to +U_e. Certified by TÜV to EN 954-1, Category 3 or 4. Suitable for protection of people or processes.



Contact Sequence

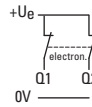
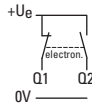

Analog 0–10V

Contact Travel

■ = contact closed

□ = contact open

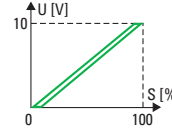
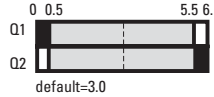
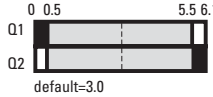

Operating Head Type ②

Head Only

Catalog Number

Assembled Switch

Catalog Number

Top Push Roller Plunger



LS-XP

LSE-11-P

LSE-02-P

LSE-AU-P

Long Roller Lever



LS-XL

LSE-11-L

LSE-02-L

LSE-AU-L

Short Roller Lever



LS-XLS

LSE-11-LS

LSE-02-LS

LSE-AU-LS

Large Roller Lever



LS-XLB

LSE-11-LB

LSE-02-LB

LSE-AU-LB

Angled Roller



LS-XLA

LSE-11-LA

LSE-02-LA

LSE-AU-LA

Notes

① A compatible Cage Clamp tool is available as an accessory on [Page V8-T2-33](#).

② For operating head dimensions, see [Page V8-T2-40](#).

Plastic Electronic Safety Position Switches, continued

Plastic Electronic Safety Position Switch Body



Switch Body Catalog Number	LSE-11	LSE-02	LSE-AU
Output Function	1NO and 1NC	2NC	Analog 0–10V
Terminal Connections	Cage Clamp ①	Cage Clamp ①	Cage Clamp ①
Safety Functions and Approvals	These models may be used in safety-oriented circuits. Visual status LED indication is comparable to positive opening contacts. Certified by TÜV as a “Functional-Safety” device. Suitable for protection of people or processes.		Additional diagnostic output that registers a 0V signal in the event of a fault. Self-test function continuously tests both outputs for overloads, short circuits to 0V and short circuits to +U _e . Certified by TÜV to EN 954-1, Category 3 or 4. Suitable for protection of people or processes.



Assembled Switch



Contact Sequence

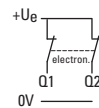
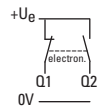

Analog 0–10V

Contact Travel

■ = contact closed
□ = contact open

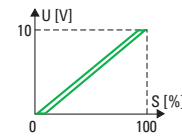
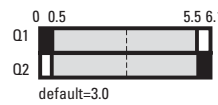
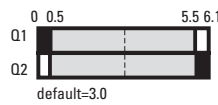

Operating Head Type ②

Head Only Catalog Number	Assembled Switch Catalog Number
--------------------------	---------------------------------

Rotary Lever



LS-XRL	LSE-11-RL	LSE-02-RL	LSE-AU-RL
--------	-----------	-----------	-----------

Adjustable Roller Lever (with 18 mm Roller)



LS-XRLA	LSE-11-RLA	LSE-02-RLA	LSE-AU-RLA
---------	------------	------------	------------

Adjustable Roller Lever (With 30 mm Roller)



LS-XRLA30	LSE-11-RLA30	LSE-02-RLA30	LSE-AU-RLA30
-----------	--------------	--------------	--------------

Notes

- ① A compatible Cage Clamp tool is available as an accessory on [Page V8-T2-33](#).
- ② For operating head dimensions, see [Page V8-T2-40](#).

Plastic Electronic Safety Position Switch Body



Assembled Switch



Plastic Electronic Safety Position Switches, continued

Switch Body

Catalog Number

LSE-11

LSE-02

LSE-AU

Output Function

1NO and 1NC

2NC

Analog 0–10V

Terminal Connections

Cage Clamp ①

Cage Clamp ①

Cage Clamp ①

Safety Functions and Approvals

These models may be used in safety-oriented circuits. Visual status LED indication is comparable to positive opening contacts. Certified by TÜV as a “Functional-Safety” device. Suitable for protection of people or processes.

Additional diagnostic output that registers a 0V signal in the event of a fault. Self-test function continuously tests both outputs for overloads, short circuits to 0V and short circuits to +U_e. Certified by TÜV to EN 954-1, Category 3 or 4. Suitable for protection of people or processes.



Contact Sequence

+U_e

+U_e

Analog 0–10V



Contact Travel

■ = contact closed

□ = contact open

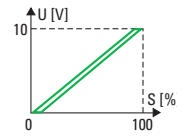
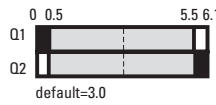
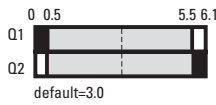

Operating Head Type ②

Head Only

Catalog Number

Assembled Switch

Catalog Number

Adjustable Roller Lever (With 40 mm Roller)



LS-XRLA40

LSE-11-RLA40

LSE-02-RLA40

LSE-AU-RLA40

Adjustable Roller Lever (With 40 mm Roller)



LS-XRLA40R

LSE-11-RLA40R

LSE-02-RLA40R

LSE-AU-RLA40R

Plastic Rod Lever



LS-XRR

LSE-11-RR

LSE-02-RR

LSE-AU-RR

Notes

① A compatible Cage Clamp tool is available as an accessory on **Page V8-T2-33**.

② For operating head dimensions, see **Page V8-T2-40**.

Plastic Electronic Safety Position Switches, continued

Plastic Electronic Safety Position Switch Body



Assembled Switch



Switch Body Catalog Number	LSE-11	LSE-02	LSE-AU
Output Function	1NO and 1NC	2NC	Analog 0–10V
Terminal Connections	Cage Clamp ①	Cage Clamp ①	Cage Clamp ①
Safety Functions and Approvals	These models may be used in safety-oriented circuits. Visual status LED indication is comparable to positive opening contacts. Certified by TÜV as a “Functional-Safety” device. Suitable for protection of people or processes.		Additional diagnostic output that registers a 0V signal in the event of a fault. Self-test function continuously tests both outputs for overloads, short circuits to 0V and short circuits to +U _e . Certified by TÜV to EN 954-1, Category 3 or 4. Suitable for protection of people or processes.



Contact Sequence

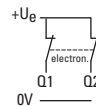
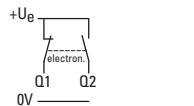

Analog 0–10V

Contact Travel
 ■ = contact closed
 □ = contact open

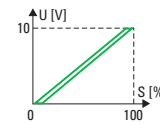
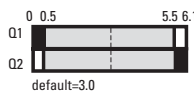
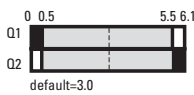

Operating Head Type ②

Head Only Catalog Number	Assembled Switch Catalog Number
--------------------------	---------------------------------

Metal Rod



LS-XRRM	LSE-11-RRM	LSE-02-RRM	LSE-AU-RRM
---------	------------	------------	------------

Spring Rod (Wobble) ③



LS-XS	LSE-11-S	LSE-02-S	LSE-AU-S
-------	----------	----------	----------

Actuating Rod



LS-XOR	LSE-11-OR	LSE-02-OR	LSE-AU-OR
--------	-----------	-----------	-----------

Notes

- ① A compatible Cage Clamp tool is available as an accessory on **Page V8-T2-33**.
- ② For operating head dimensions, see **Page V8-T2-40**.
- ③ Not to be used as a safety position switch. Use only in conjunction with snap-action contact.

2.3

Limit Switches

LS-Titan Miniature DIN Switches

LS-Titan Metal Safety Switches

2

Metal Safety Switch Body



Assembled Switch



Metal Safety Switches

Switch Body Catalog Number

Output Function

Terminal Connection

Contact Sequence

Contact Travel

■ = contact closed

□ = contact open

Operating Head Type ①

Head Only Catalog Number

LSM-02

2NC with positive opening contacts

Cage Clamp

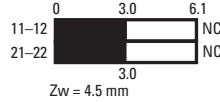

LSM-20A

2NO with slow make/break

Cage Clamp

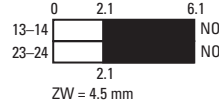

LSM-11S

1NO and 1NC with positive opening contact

Cage Clamp



Snap-action contact

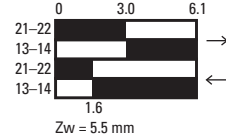

Top Push Roller Plunger



LSM-XP

LSM-02-P

LSM-20A-P

LSM-11S-P

Long Roller Lever



LSM-XL

LSM-02-L

LSM-20A-L

LSM-11S-L

Angled Roller



LSM-XLA

LSM-02-LA

LSM-20A-LA

LSM-11S-LA

Rotary Lever



LSM-XRL

LSM-02-RL

LSM-20A-RL

LSM-11S-RL

Adjustable Roller Lever



LSM-XRLA

LSM-02-RLA

LSM-20A-RLA

LSM-11S-RLA

Note

① For operating head dimensions, see **Page V8-T2-40**.

Metal Safety Switches, continued

Metal Safety Switch Body



Assembled Switch



Switch Body Catalog Number

Output Function

Terminal Connection

Contact Sequence

Contact Travel

■ = contact closed

□ = contact open

Operating Head Type ①

Head Only

Catalog Number

LSM-02

2NC with positive opening contacts

Cage Clamp

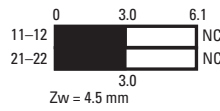

LSM-20A

2NO with slow make/break

Cage Clamp

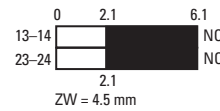

LSM-11S

1NO and 1NC with positive opening contact

Cage Clamp

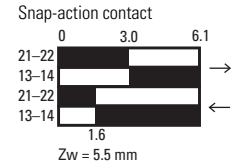

Assembled Switch Catalog Number

Plastic Rod Lever



LSM-XRR

LSM-02-RR

LSM-20A-RR

LSM-11S-RR

Metal Rod Lever



LSM-XRRM

LSM-02-RRM

LSM-20A-RRM

LSM-11S-RRM

Spring Rod (Wobble)



LSM-XS

LSM-02-S

LSM-20A-S

LSM-11S-S

Note

① For operating head dimensions, see **Page V8-T2-40**.

2.3

Limit Switches

LS-Titan Miniature DIN Switches

2

Understanding LS-Titan Electronic Safety Position Switches

All three LS-Titan LSE switch bodies are safety-rated products. The LSE-11 and LSE-02 switch bodies both have a freely programmable operating point and can be individually adjusted to suit the application, and can be changed as often as required. These devices feature an LED on the body, providing simple indication during programming and operation.

The LSE-AU (0–10 V) analog position switch takes position data and converts to an analog current or voltage value that can then be continuously fed into an automation system. The LSE-AU also features a diagnostic output for additional data processing.

This ensures that a safe operating state can be monitored and evaluated at any time. A self-test function is also present on these models. Outputs Q1 and Q2 are continuously tested for overloads, short circuits to 0V and short circuits to +U_e.

Like the electromechanical position switches, LS-Titan electronic position switches meet Category 3 or 4 of the EN 954-1 standard for machine safety when configured as a redundant system. All devices are thus suitable for safety applications that are used for the protection of persons or processes.

Operating Point Adjustment

LSE-11

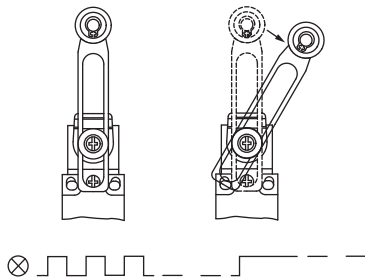

LSE-02

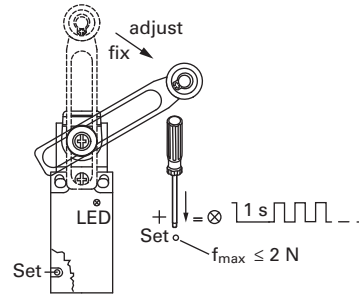

Example of LS-Titan LSE Models in a Safety-Oriented Circuit

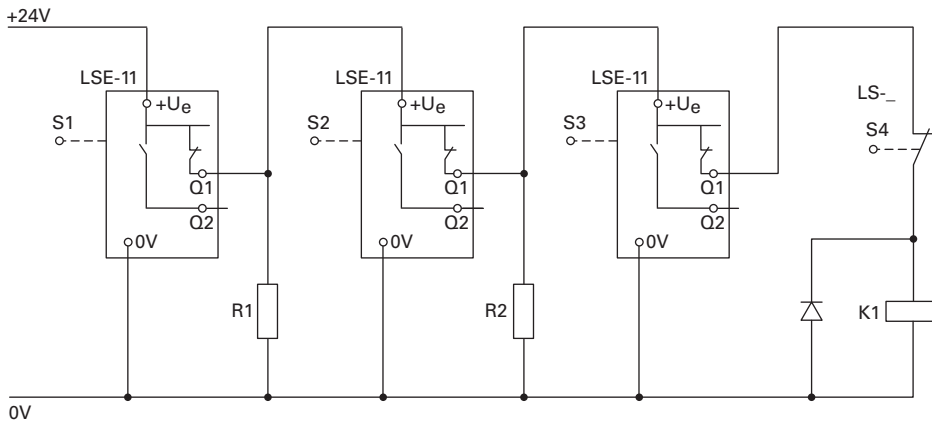

Notes

LSE-11 and LSE-02—individual operating point adjustment.

LSE-11 and LSE-02 can be used in safety circuits.



S1 is connected to 24 Vdc

S2, S3 each switch with a delay of 0.7s

R1, R2, for example, series element M22-XLED60 (2820 ohms/0.5W)

Accessories

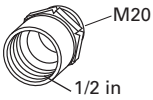
LS-Titan Safety Switches

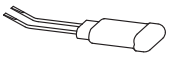
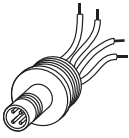
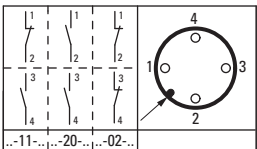
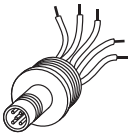
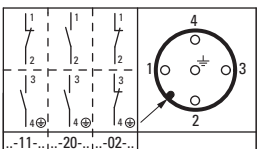
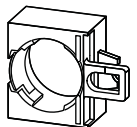
	For Use With	Description	Notes	Catalog Number
V1-2-M20 	Any	M20 screw terminal in 1/2 in. For use with American pipe thread, metal.	The screw connection must be earthed. Not total insulation.	V1-2-M20-NA
	Any	M20 screw terminal in 1/2 in. For use with American pipe thread, molded material.	—	V1-2-M20
EMS20 	Any	M20 diaphragm bolt. With internal push-through membrane. Will fit cable with an external diameter of up to 13 mm. Rated IP65 with cable inserted.	—	EMS20
LS-XTW 	Any	Cage Clamp tool.	—	LS-XTW
M12A 	LS-Titan plastic bodies (LS-_)	Plug connector, 12 mm, 4-pin male connector M12x1 (M12x1). Rated IP65. Molded material. Color coded to IEC/EN 60947-5-2.		M12A
M12A5 	LS-Titan metal bodies (LSM-_)	Plug connector, 12 mm, 5-pin male connector (M12x1). Rated IP65. Molded material. Color coded to IEC/EN 60947-5-2.		M12A5
M22-LS 	Any	Allows mounting of M22 pushbuttons. (See the M22 catalog, CA04716001E, for a full selection of pushbuttons.)	—	M22-LS

Technical Data and Specifications

LS-Titan Miniature DIN Switches—IP66, IP67 Complete Units

	Units		LS, LSM	LSE-11/LSE-02	LSE-AU ^①
General					
Standards			IEC/EN 60947	IEC/EN 60947 EN 61000-4	IEC/EN 60947 EN 61000-4
Climatic proofing			Damp heat, constant, to IEC 60068-2-78; damp heat, cyclical, to IEC 60068-2-30	Damp heat, constant, to IEC 60068-2-78; damp heat, cyclical, to IEC 60068-2-30	Damp heat, constant, to IEC 60068-2-78; damp heat, cyclical, to IEC 60068-2-30
Ambient temperature	°F (°C)		−13° to 158°F (−25° to 70°C)	−13° to 158°F (−25° to 70°C)	−13° to 158°F (−25° to 70°C)
Mounting position			As required	As required	As required
Protection type			IP66, IP67	IP66, IP67	IP66, IP67
Terminal capacity of screw terminal and Cage Clamp					
Solid	mm ²		1 x (0.5–2.5)	1 x (0.5–2.5)	1 x (0.5–2.5)
Flexible with ferrules to DIN 46228	mm ²		1 x (0.5–1.5)	1 x (0.5–1.5)	1 x (0.5–1.5)
Power Supply					
Rated voltage	U _e	Vdc	N/A	12–30	24 (−15%/+20%)
Burden current					
12V	I _e	mA	N/A	15	N/A
24V	I _e	mA	N/A	18	24
30V	I	mA	N/A	19	N/A
Contacts/Switching Capacity					
Rated impulse withstand voltage	U _{imp}	Vac	4000	N/A	N/A
Rated insulation voltage	U _i	V	400	N/A	N/A
Overvoltage category/ pollution degree			III/3	III/3	N/A
Rated Operational Current					
AC-15					
24V	I _e	A	6	N/A	N/A
230V/240V	I _e	A	6	N/A	N/A
400V/415V	I _e	A	4	N/A	N/A
DC-13					
24V	I _e	A	3	0.2	N/A
110V	I _e	A	0.8	N/A	N/A
220V	I _e	A	0.3	N/A	N/A

Note

^① The following applies for LSE-11 and LSE-02: ensure that the power supply operates correctly when setting the operating point.

LS-Titan Miniature DIN Switches—IP66, IP67 Complete Units. continued

	Units	LS, LSM	LSE-11/LSE-02	LSE-AU ①
Burden Current				
Analog output Q1				
Output voltage (max. 10 mA)	Vdc	N/A	N/A	0–10
Output current	mA	N/A	N/A	
Fault scenario	V	N/A	N/A	0
Resolution	Steps	N/A	N/A	100
Step tolerance	Steps	N/A	N/A	1
Shunt resistor, resistive load	ohms	N/A	N/A	>1000
Digital diagnostics output Q2 (switching to + pole PNP)				
Response threshold	V	N/A	N/A	Approx. U_g
	mA	N/A	N/A	<200
Control circuit reliability				
At 24 Vdc/5 mA	H_F	Fault probability	$<10^{-7}$, <1 fault in 10^7 operations	N/A
At 5 Vdc/1 mA	H_F	Fault probability	$<10^{-6}$, <1 failure at 5×10^6 operations	N/A
Supply frequency	Hz	Max. 400	N/A	N/A
Short-circuit rating to IEC/EN 60947-5-1				
Maximum fuse	A gG/gL	6	N/A	N/A
Repetition accuracy	mm	± 0.02	± 0.02	± 0.02

Note

① The following applies for LSE-11 and LSE-02: ensure that the power supply operates correctly when setting the operating point.

LS-Titan Miniature DIN Switches—IP66, IP67 Complete Units

2

	Units		LS, LSM	LSE-11/LSE-02	LSE-AU
Mechanical Variables					
Lifespan					
Standard-action contact	Operations	X 10 ⁶	8	N/A	N/A
Snap-action contact	Operations	X 10 ⁶	8	3 (electronic)	N/A
Contact temperature of roller head		°C	≤100	≤100	≤100
Mechanical shock resistance (half-sinusoidal shock, 20 ms)					
Standard-action contact		g	25	N/A	N/A
Snap-action contact		g	N/A	N/A	N/A
Basic unit		g	N/A	30	30
Operating frequency	Operations/h		≤6000	≤3000	≤3000
Switching point			N/A	0.5–5.5 mm freely adjustable	N/A
Hysteresis		mm	N/A	0.4	0.4
Contact sequence (contact closed open Zw = positive opening clearance)		mm	N/A	0.04	0.06
Actuation					
Mechanical					
Actuating force at beginning/ end of stroke					
Basic units		N	1.0/8.0	3.5/8.0	3.5/8.0
LS(M)-XP		N	1.0/8.0	1.0/8.0	1.0/8.0
LS(M)-XL		N	1.0/8.0	1.0/8.0	1.0/8.0
LS(M)-XLA		N	1.0/8.0	1.0/8.0	1.0/8.0
Actuating torque of rotary drives		Nm	0.2	0.2	0.2
Maximum operating speed with DIN cam					
Basic units for angle of actuation	$\alpha = 0^\circ/30^\circ$	m/s	1/0.5	1/0.5	1/0.5
LS(M)-XRL for angle of actuation	$\alpha = 0^\circ$	m/s	1.5	1.5	1.5
LS(M)-XRLA for angle of actuation	$\alpha = 30^\circ, L = 125 \text{ mm}$	m/s	1.5	1.5	1.5
LS(M)-XRR for angle of actuation	$L = 130 \text{ mm}$	m/s	1.5	1.5	1.5
LS(M)-XL for angle of actuation	$\alpha = 30^\circ/45^\circ$	m/s	1	1	1
LS(M)-XLA for angle of actuation	$\alpha = 30^\circ/45^\circ$	m/s	1	1	1
LS(M)-XP for angle of actuation	$\alpha = 0^\circ/30^\circ$	m/s	1/1	1/1	1/1
Electromagnetic Compatibility (EMC)					
Electrostatic discharge (IEC/EN 61000-4-2, Level 3 ESD)					
Air discharge		kV		8	8
Contact discharge		kV		4	4
Electromagnetic fields (IEC/EN 61000-403, RFI)		V/m		10	10
Burst pulses (IEC/EN 61000-4-4, Level 3)					
Supply cables		kV		2	2
Signal lines		kV		2	2
High-energy pulses (surge) (IEC/EN 61000-4-5)		kV		0.5	0.5
Immunity to line-conducted interference to (IEC/EN 61000-4-6)		V		10	10

Contact Travel Diagrams

LSE

Contact Travel

■ = contact closed
□ = contact open

LSE-11

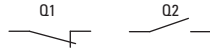

LSE-02

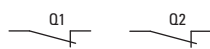

Description

Basic Units

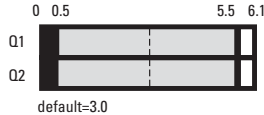
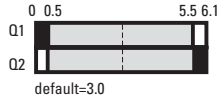

Operating Heads

Roller plunger

- LS-XP
- LSM-XP

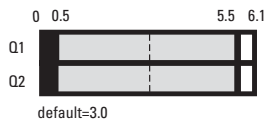
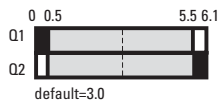

Roller lever

- LS-XL
- LSM-XL
- LS-XL
- LS-XLB

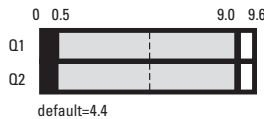
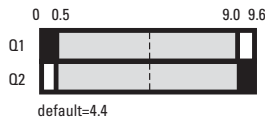

Angled roller lever

- LS-XLA
- LSM-XLA

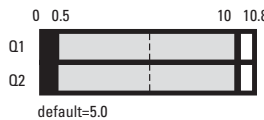
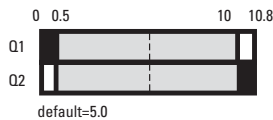

Rotary lever

- LS-XRL
- LSM-XRL

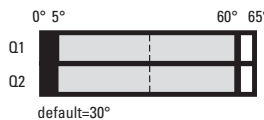
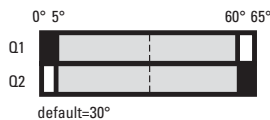

Adjustable roller lever

- LS-XRLA
- LSM-XRLA
- LS-XRLA30
- LS-XRLA40
- LS-XRLA40R

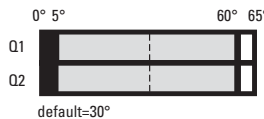
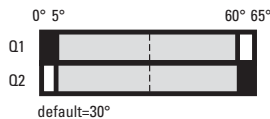

Actuating rod

- LS-XRR
- LSM-XRR
- LS-XRRM
- LSM-XRRM

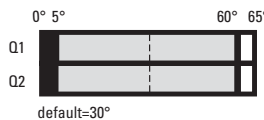
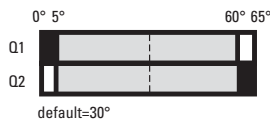

Spring rod

- LS-XS
- LSM-XS

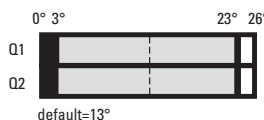
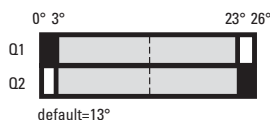

2.3

Limit Switches

LS-Titan Miniature DIN Switches

LS and LSM

2

Contact Travel

■ = contact closed
□ = contact open

LS-02, LS-S02, LSM-02

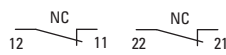

LS-11S, LS-S11S, LSM-11S

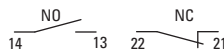

LS-20A, LS-S20A, LSM-20A

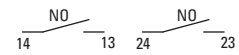

Description

Basic Units

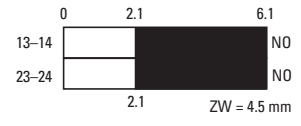
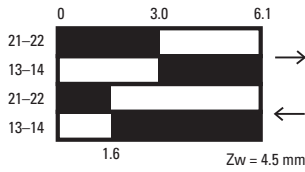
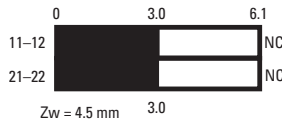

Operating Heads

Roller plunger

LS-XP, LSM-XP

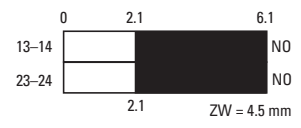
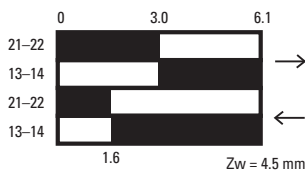
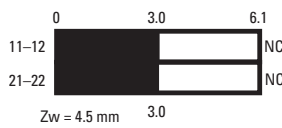

Roller lever

LS-XL, LSM-XL

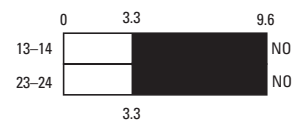
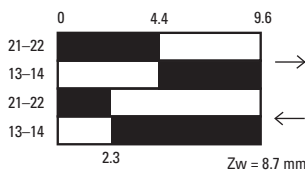
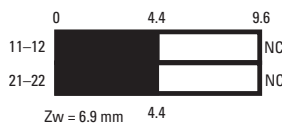

Roller lever, short

LS-XLS

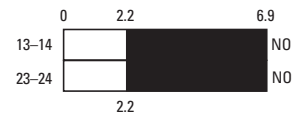
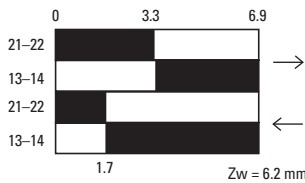
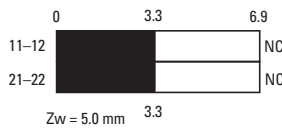

Roller lever, large

LS-XLB

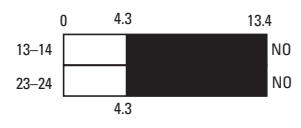
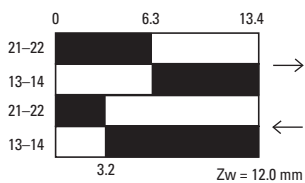
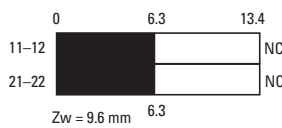

LS and LSM, continued

	Contact Travel	LS-02, LS-S02, LSM-02	LS-11S, LS-S11S, LSM-11S	LS-20A, LS-S20A, LSM-20A
Description	■ = contact closed □ = contact open			
Operating Heads				
Angled roller lever				
LS-XLA, LSM-XLA				
Rotary lever				
LS-XRL, LSM-XRL				
Adjustable roller lever				
LS-XRLA, LSM-XRLA LS-XRLA30, LS-XRLA40 LS-XRLA40R				
Actuating rod				
LS-XRR, LSM-XRR LS-XRRM, LSM-XRRM				
Spring rod				
LS-XS, LSM-XS				

2.3

Limit Switches

LS-Titan Miniature DIN Switches

Dimensions

Approximate Dimensions in Inches (mm)

2

Position Switches

LS-_, LSM-_, LSE-_

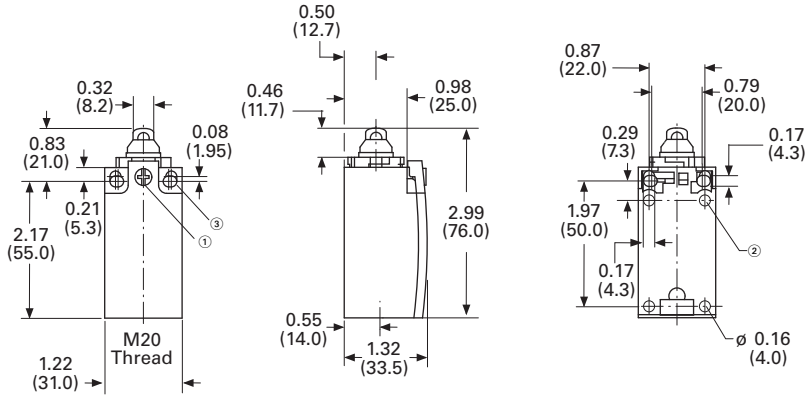

LS-_, LSM-_, LSE-_

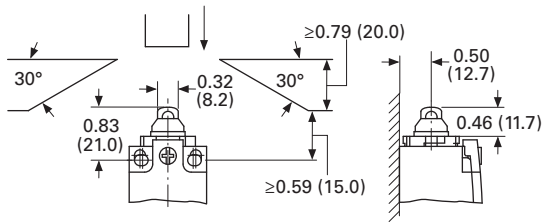

LS(M)-_/S

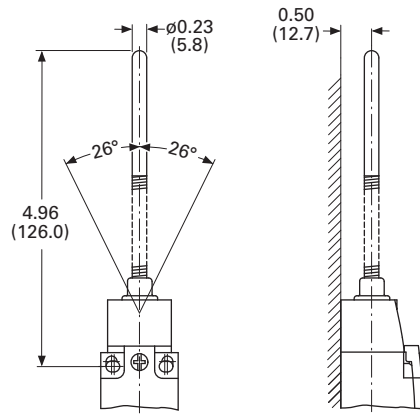

LS(M)-_/P

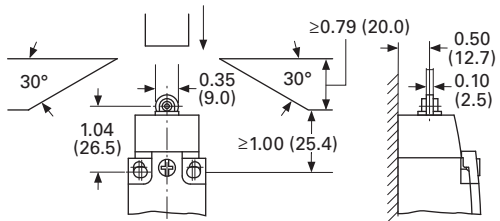

Notes

- ① Tightening torque of cover screws: 0.8 Nm \pm 0.2 Nm.
- ② Only with LS (insulated version).
- ③ Fixing screws 2 x M4 \geq 30
M_A = 1.5 Nm

Approximate Dimensions in Inches (mm)

Rotary Lever

LS(M)-_RL

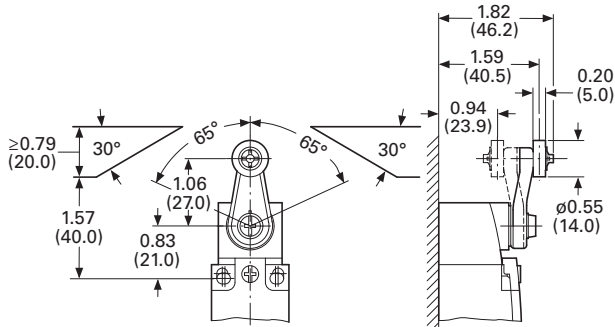

Roller Lever, Short

LS(M)-_LS

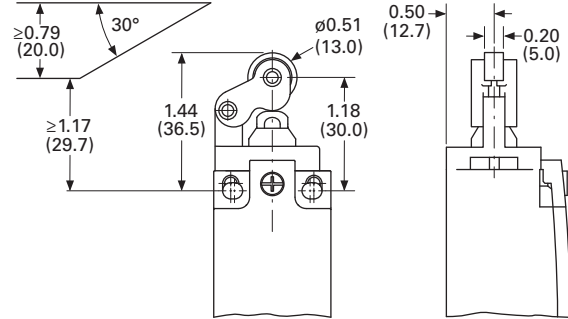

Roller Lever

LS(M)-_L

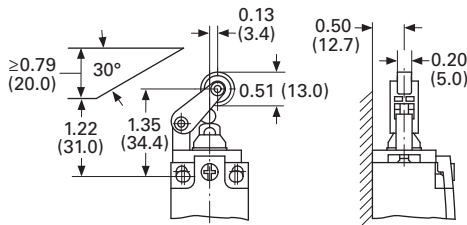

Adjustable Roller Lever

LS(M)-_RLA

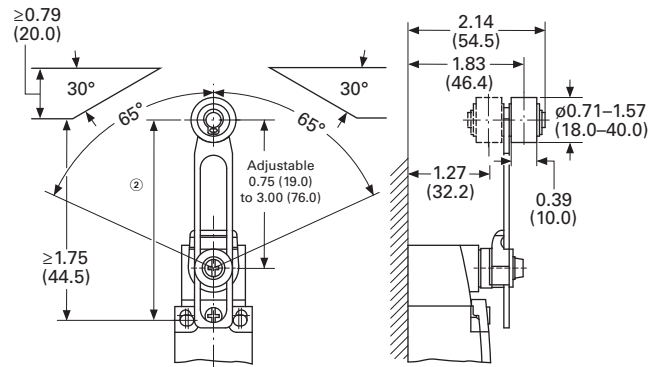

Roller Lever, Large

LS(M)-_LB ①

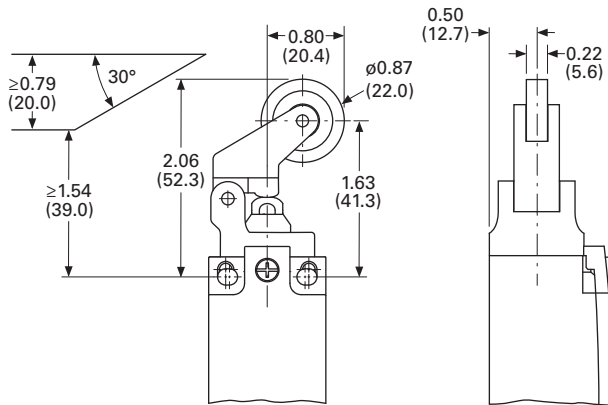

Angled Roller Lever

LS(M)-_XLA

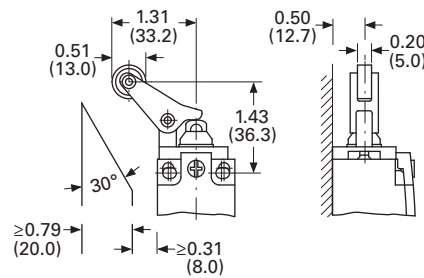

Notes

- ① Tightening torque of cover screws: 0.8 Nm ±0.2 Nm.
- ② Setting range of 54.5 to 97.

2.3

Limit Switches

LS-Titan Miniature DIN Switches

Approximate Dimensions in Inches (mm)

2

Actuating Rod

LS(M)-_/RR

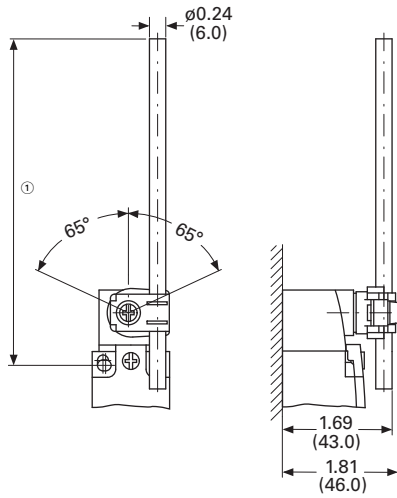

LS(M)-_/OR

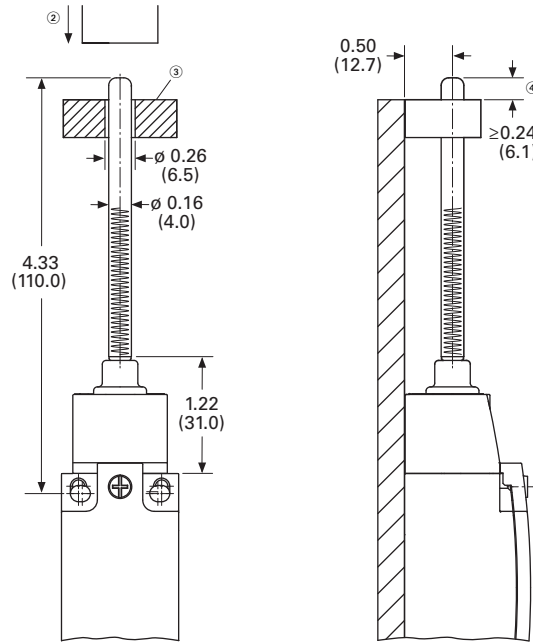

Notes

- ① LS_/RR ≤150
LS_/RRM ≤210
- ② Approach direction, vertical.
- ③ Guide is done by customer, not included.
- ④ Maximum push-through.

E49 Mini Metal Switches



E49 Mini Metal Switches

Product Description

E49 Mini Metal Limit Switches from Eaton's electrical sector are designed small and tough, with machinery OEMs in mind. The small size, metal body and mechanical life make this product perfect for switching applications in packaging, material handling, elevators and lifts, electronic assembly equipment, injection molding machinery, and auto-vending machines. The E49 Mini Metal is the ideal switch for those who need a cost-effective, compact solution, but don't want to sacrifice durability in the process.

Features

- Long life—rated for 10 million operations
- Pre-wired units with custom cable lengths available for high volume customers
- "Fingerproof" terminals protect against accidental shock
- Double-spring mechanism for contact reliability
- Grounding terminal included
- Captive screws on enclosure cover make wiring hassle-free
- SPDT double break

Contents

Description

	Page
E49 Mini Metal Switches	
Product Selection	V8-T2-44
Technical Data and Specifications	V8-T2-46
Dimensions	V8-T2-47

 Drawings
Online

Standards and Certifications

- UL Recognized, E117028 (Model E49G31C1P3 is not UL Recognized)
- CE
- RoHS Compliant

 **DANGER**

THIS SENSOR IS NOT A SAFETY DEVICE AND IS NOT INTENDED TO BE USED AS A SAFETY DEVICE. This sensor is designed only to detect and read certain data in an electronic manner and perform no use apart from that, specifically no safety-related use. This sensor product does not include self-checking redundant circuitry, and the failure of this sensor product could cause either an energized or de-energized output condition, which could result in death, serious bodily injury, or property damage.

For the most current information on this product, visit our Web site: www.eaton.com

For Customer Service in the U.S. call 1-877-ETN CARE (386-2273), in Canada call 1-800-268-3578.
For Application Assistance in the U.S. and Canada call 1-800-426-9184.

Product Selection

2

E49 Mini Metal Switches

<i>Operating Head Type</i>	Travel to Operate Contacts	Travel to Reset Contacts	Total Travel	Force to Operate Contacts	Minimum Return Force	Assembled Unit (Switch Body and Head) 1NO-1NC Contacts Catalog Number
Side Rotary Lever 	Side Rotary Lever 20°	12°	70°	750g	100g	E49G31AP3
Adjustable Side Rotary Lever 	Adjustable Side Rotary Lever 20°	12°	70°	750g	100g	E49G31UP3
Top Pushbutton 	Top Pushbutton 0.06 in (1.5 mm)	0.04 in (1 mm)	0.22 in (5.5 mm)	900g	150g	E49G31BP3
Top Push Roller 	Top Push Roller 0.06 in (1.5 mm)	0.04 in (1 mm)	0.22 in (5.5 mm)	900g	150g	E49G31CP3
Top Push Roller (90° Roller) 	Top Push Roller (90° Roller) 0.06 in (1.5 mm)	0.04 in (1 mm)	0.22 in (5.5 mm)	900g	150g	E49G31C1P3
Adjustable Rod Lever 	Adjustable Rod Lever 20°	12°	70°	750g	100g	E49G31DP3

E49 Mini Metal Switches, continued

<i>Operating Head Type</i>	Travel to Operate Contacts	Travel to Reset Contacts	Total Travel	Force to Operate Contacts	Assembled Unit (Switch Body and Head) 1NO-1NC Contacts Catalog Number
Wobble Stick (Nylon Coil) 	Wobble Stick (Nylon Coil)				
	1.18 in (30 mm)	—	—	150g	E49G31NP3
Wobble Stick (Metal Coil) 	Wobble Stick (Metal Coil)				
	1.18 in (30 mm)	—	—	150g	E49G31VP3
Wobble Stick (Metal Rod) 	Wobble Stick (Metal Rod)				
	1.18 in (30 mm)	—	—	150g	E49G31MP3
Wobble Stick (Whisker) 	Wobble Stick (Whisker)				
	1.18 in (30 mm)	—	—	150g	E49G31XM3

Technical Data and Specifications

2

E49 Mini Metal Switches

Description	Specification
Operating speed	0.19 in (5 mm) to 19.7 in/s (50 cm/s)
Operating frequency	120 operations/min
Contact resistance	25M ohms (initial)
Insulation resistance	100M ohms min (at 500 Vdc)
Dielectric strength	1000 Vac, 50/60 Hz for one minute between non-continuous terminals
	1500 Vac, 50/60 Hz for one minute between current-carrying and non-current-carrying parts and between each terminal and ground
Vibration	10 to 55 Hz, 1.5 mm double amplitude
Shock	Approx. 300 m/s ² (approx. 30Gs)
Ambient operating temperature	23° to 149°F (–5° to 65°C)
Humidity	95% RH max.
Service life	Mechanical: 10,000,000 operations min.
	Electrical: 500,000 operations min.
Weight	Approx. 130 to 190g
Degree of protection	IEC: IP65
Material of construction	Shaft: stainless SUS303 Arm: stainless SUS304 Head and body: zinc alloy Terminal cover: PC/ABS plastic Rubber grommet: NBR rubber

Maximum Ampere Ratings

Rated Voltage	Non-Inductive Load (A)		Lamp Load ^②		Inductive Load (A) ^①		Motor Load	
	Resistive Load		NC	NO	Inductive Load		NC	NO
	NC	NO			NC	NO		
125 Vac	5	5	1.5	0.7	3	3	2	1
250 Vac	5	5	1	0.5	3	3	1.5	0.8
8 Vdc	5	5	3	3	5	4	3	3
14 Vdc	5	5	3	3	4	4	3	3
30 Vdc	5	5	3	3	4	4	3	3
125 Vdc	0.4	0.4	—	—	—	—	—	—
250 Vdc	0.2	0.2	—	—	—	—	—	—

Terminal Configuration

NO (4) —○ ○— NO (3)

NC (1) —● ●— NC (2)

Notes

- ^① Inductive load has a power factor of 0.4 min. (AC) and a time constant of 7 msec. max. (DC).
^② Lamp load has an inrush current of ten times the steady-state current, while motor load has an inrush current of six times the steady-state current.

Dimensions

Approximate Dimensions in Inches (mm)

E49G31AP3

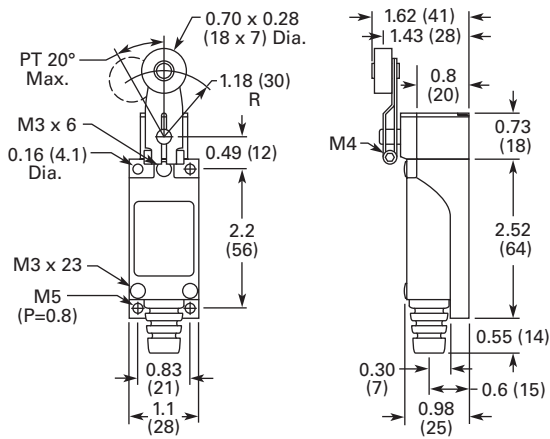

E49G31CP3

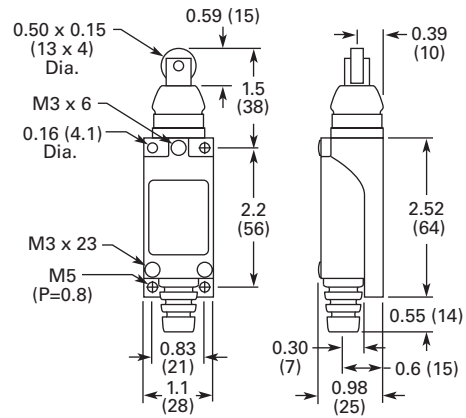

E49G31BP3

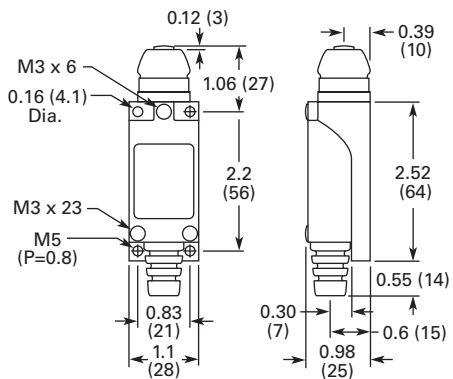

E49G31DP3

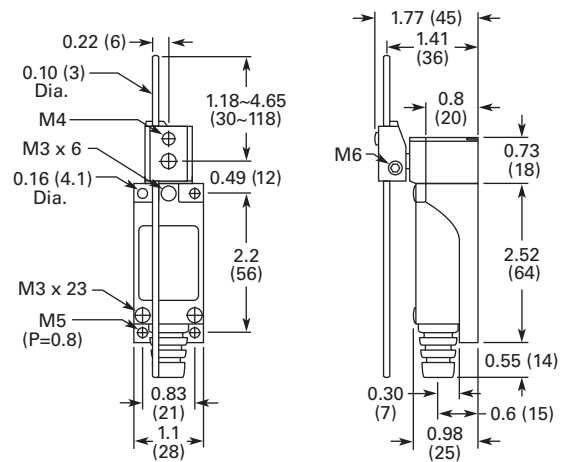

E49G31C1P3

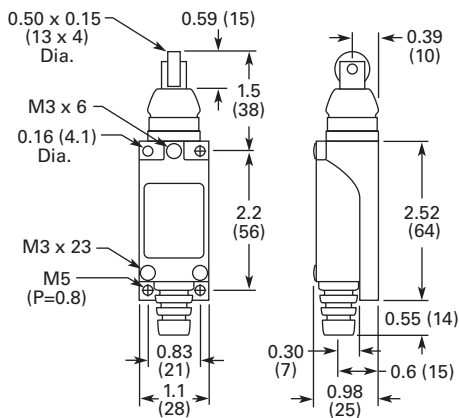

E49G31MP3

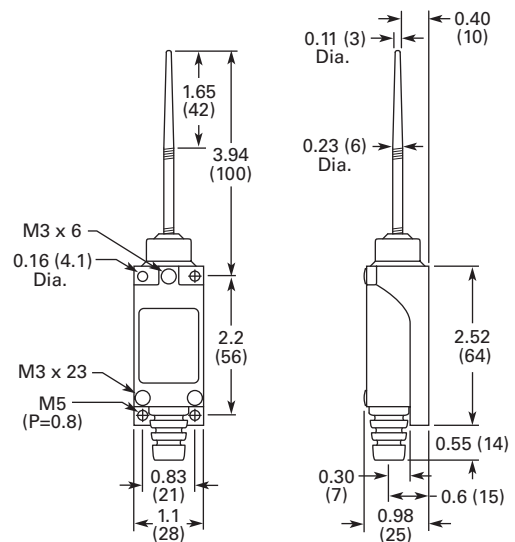

2.4

Limit Switches

E49 Mini Metal Switches

Approximate Dimensions in Inches (mm)

E49G31NP3

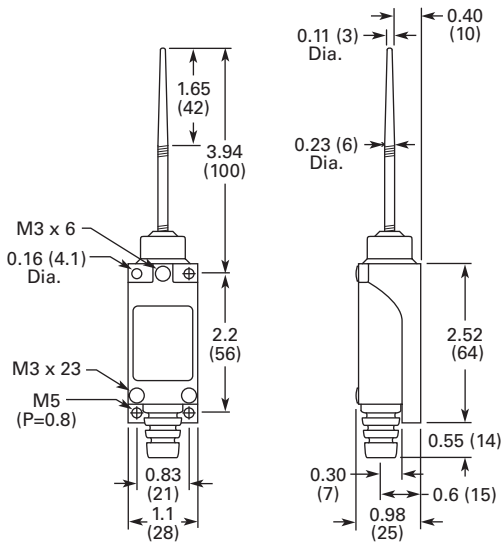

E49G31VP3

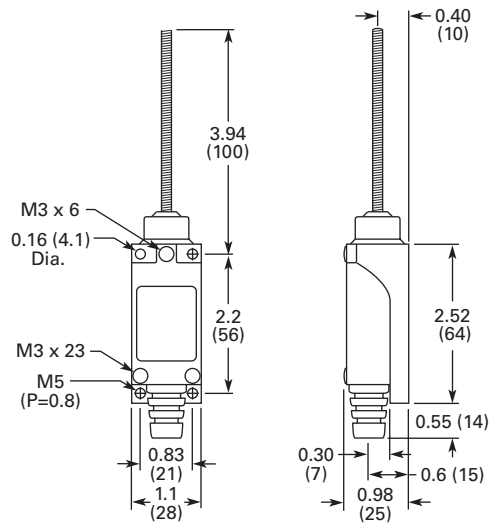

E49G31UP3

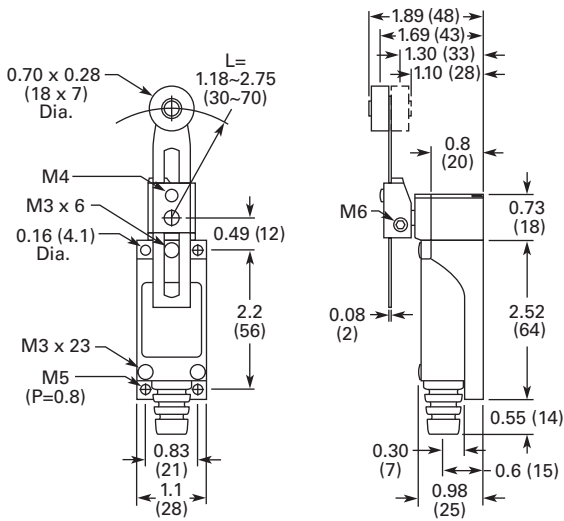

E49G31XM3

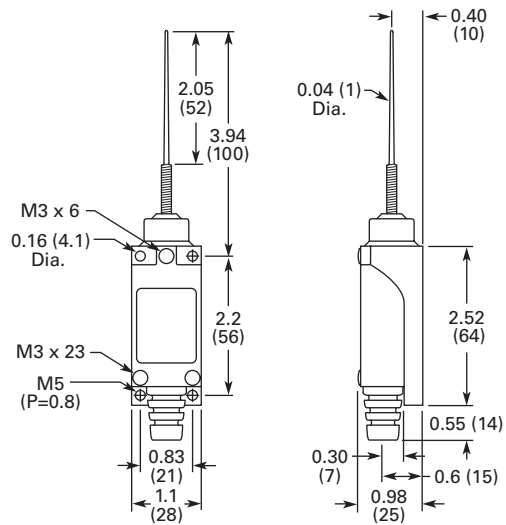

E49 Compact Metal Switches



Contents

Description

Page

E49 Compact Metal Switches	
Product Selection	V8-T2-50
Technical Data and Specifications	V8-T2-51
Dimensions	V8-T2-52

 Drawings Online

E49 Compact Metal Switches

Product Description

E49 Compact Metal Switches by Eaton’s electrical sector are designed with high mechanical strength for harsh environments. The rugged aluminum die cast construction provides reliable, oil-tight, waterproof and dustproof sealing for a variety of applications. Snap action 1NO-1NC contacts provide flexibility in design.

Features

- Rigid die cast switch housing
- High mechanical strength
- Oil-tight, waterproof and dustproof construction

Standards and Certifications

- UL Listed, E170645
- UL tested to Canadian safety standards
- RoHS Compliant



 DANGER

THIS SENSOR IS NOT A SAFETY DEVICE AND IS NOT INTENDED TO BE USED AS A SAFETY DEVICE. This sensor is designed only to detect and read certain data in an electronic manner and perform no use apart from that, specifically no safety-related use. This sensor product does not include self-checking redundant circuitry, and the failure of this sensor product could cause either an energized or de-energized output condition, which could result in death, serious bodily injury, or property damage.

For the most current information on this product, visit our Web site: www.eaton.com

For Customer Service in the U.S. call 1-877-ETN CARE (386-2273), in Canada call 1-800-268-3578. For Application Assistance in the U.S. and Canada call 1-800-426-9184.



Product Selection

2

E49 Compact Metal Switches

<i>Operating Head Type</i>	Travel to Operate Contacts	Travel to Reset Contacts	Total Travel	Force to Operate Contacts (Maximum)	Minimum Return Force	Assembled Unit (Switch Body and Head) 1NO-1NC Contacts Catalog Number
Roller Lever 	20°	12°	50°	2.99 lbs	0.50 lb	E49M11AP1
Top Push 	0.067 in (1.7 mm)	0.04 in (1.0 mm)	—	6.02 lbs	2.01 lbs	E49M11BP1
Top Push Roller 	0.067 in (1.7 mm)	0.04 in (1.0 mm)	0.25 in (6.5 mm)	6.02 lbs	2.01 lbs	E49M11CP1 (as pictured) E49M11CP2 90° Cross Roller
Rod Lever 	20°	12°	50°	0.31 lb	0.06 lb	E49M11DP1
Adjustable Roller Lever 	20°	12°	50°	2.99 lbs	0.50 lb	E49M11UP1

E49 Compact Metal Switches, continued

Operating Head Type	Travel to Operate Contacts	Travel to Reset Contacts	Total Travel	Force to Operate Contacts (Maximum)	Minimum Return Force	Assembled Unit (Switch Body and Head) 1NO-1NC Contacts Catalog Number
Wobble	Wobble					
	1.10 in (28 mm)	N/A	N/A	0.33 lb	N/A	E49M11VP1
Cat Whisker	Cat Whisker					
	1.10 in (28 mm)	N/A	N/A	0.064 lb	N/A	E49M11XM1

Technical Data and Specifications

E49 Compact Metal Switches

Description	Specification
Operating speed	1 mm to 2m/sec
Operating frequency	Mechanically: 120 operations/min.; Electronically: 30 operations/min.
Contact resistance	15M ohms max. (initial)
Insulation resistance	100M ohms min. (at 500 Vdc)
Dielectric strength	1000 Vac, 50/60 Hz for 1 minute between non-continuous terminals; 2200 Vac, 50/60 Hz for 1 minute between each terminal and non-current carrying metal part and between each terminal and ground
Vibration	Malfunction durability: approx. 1000 m/sec ² (approx. 100 Gs); Malfunction durability: approx. 300/sec ² (30 Gs)
Ambient operating temperature	14° to 176°F (-10° to 80°C)
Humidity	95% RH max.
Service life	Mechanically: 15,000,000 operations/minute; Electronically: 500,000 operations/minute

Maximum Ampere Ratings—Isolated Contacts, No Polarity Restriction

NEMA A600 (AC-15) 50 or 60 Hz						NEMA R300 (DC-13)	
Rated Voltage	Current		Voltamperes		Rated Voltage	Current	
	Continuous	Make	Break	Make			Break
24 Vac	10A	60A	6.0A	7200 VA	720 VA	24 Vdc	1.5A
120 Vac	10A	60A	6.0A	7200 VA	720 VA	120 Vdc	0.22A
250 Vac	10A	30A	3.0A	7200 VA	720 VA	250 Vdc	0.11A
480 Vac	10A	15A	1.5A	7200 VA	720 VA		
600 Vac	10A	12A	1.2A	7200 VA	720 VA		

2.5

Limit Switches

E49 Compact Metal Switches

2

Dimensions

Approximate Dimensions in Inches (mm)

Switch Body with E49M11BP1

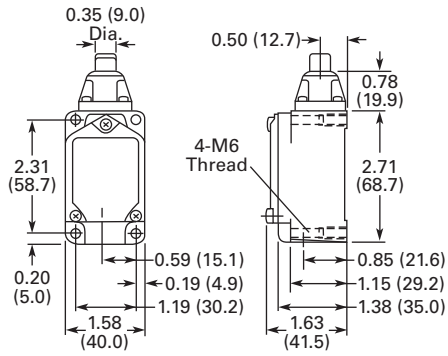

E49M11UP1

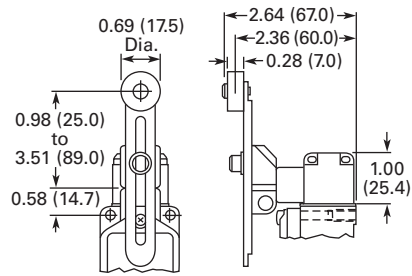

E49M11CP1/E49M11CP2

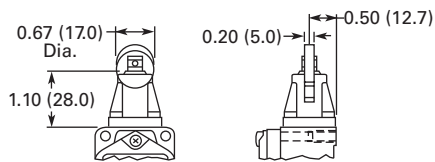

E49M11VP1

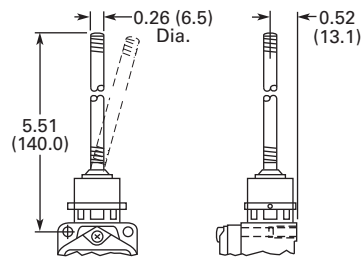

E49M11DP1

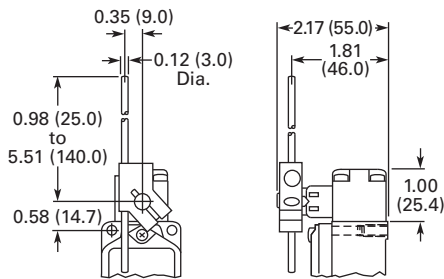

E49M11XM1

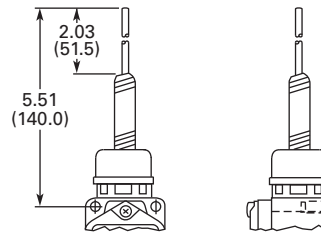

E49M11AP1

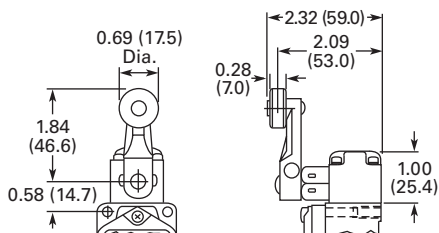

E50 Heavy-Duty Plug-In Switches



E50 Heavy-Duty Plug-In Switches

Product Description

E50 Modular Plug-In Limit Switch Components from Eaton's electrical sector are the industry standard with versatility of design and high reliability for low maintenance, installation and inventory costs. Standard Viton gaskets, seals and boots and a zinc die cast enclosure provide exceptional chemical resistance to the common coolants, cleansing agents, and hydraulic fluids found in machine tool, automotive, waste water treatment and other heavy-duty industrial applications. Mounting dimensions accommodate both U.S. and DIN standards for easy retrofit installations. Super bright 24–120 Vac/dc LED indicating light versions simplify setup and troubleshooting operations.

Features

- Modular, plug-in components (head, body and receptacle) provide application flexibility, reduced inventory and less downtime
- Manufactured to take the physical and environmental abuse (including cutting fluids and chemicals) of harsh industrial environments
- Chemical resistant Viton gaskets, seals and boots are standard, and so are captive, posi-drive screws
- The switches have terminal identification on the nameplate for a visual wiring checkout without guesswork. Heads and switch bodies can be replaced without rewiring
- E50 devices can be ordered in separate components or as complete assembled switches
- 600V rating, ridge-topped contacts and wiping action assure continuity even to logic level circuits
- Keyed, four direction head positioning
- Standard 5° pre-travel and 90° total travel
- 24–120 Vac/dc LED and 120 Vac neon indicating lights available
- Rotary heads are field convertible CW, CCW, or both, without special tools
- Epoxy filled, pin connector or pigtail pin connector receptacles available

Standards and Certifications

- UL Listed, E170645
- CSA Certified, 50513
- CE (where shown)
- RoHS Compliant



⚠ DANGER

THIS SENSOR IS NOT A SAFETY DEVICE AND IS NOT INTENDED TO BE USED AS A SAFETY DEVICE. This sensor is designed only to detect and read certain data in an electronic manner and perform no use apart from that, specifically no safety-related use. This sensor product does not include self-checking redundant circuitry, and the failure of this sensor product could cause either an energized or de-energized output condition, which could result in death, serious bodily injury, or property damage.

Contents

Description

Page

E50 Heavy-Duty Plug-In Switches	
Product Selection	
Assembled Switches—Standard	V8-T2-54
Assembled Switches—Special Purpose	V8-T2-57
Operating Heads	V8-T2-58
Switch Bodies	V8-T2-59
Receptacles	V8-T2-60
Compatible Connector Cables	V8-T2-61
Accessories	V8-T2-61
Technical Data and Specifications	V8-T2-62
Circuit Diagrams	V8-T2-64
Wiring Diagrams	V8-T2-64
Dimensions	V8-T2-65



Drawings
Online

For the most current information on this product, visit our Web site: www.eaton.com

For Customer Service in the U.S. call 1-877-ETN CARE (386-2273), in Canada call 1-800-268-3578.
For Application Assistance in the U.S. and Canada call 1-800-426-9184.

2.6

Limit Switches

E50 Heavy-Duty Plug-In Switches

Product Selection

Assembled Switches—Standard

2

Assembled Switch

E50 Heavy-Duty Plug-In Switches, Assembled—Standard



Single-Pole (5 Terminal Receptacle)

Two-Pole (9 Terminal Receptacle)

Indicating Light:	None	LED (24–120 Vac/dc)	Neon (120 Vac)	None	LED (24–120 Vac/dc)	Neon (120 Vac)	LED (24–120 Vac/dc)	Neon (120 Vac)
Switch Body:	E50SA	E50SAL	E50SAN	E50SB	E50SBL	E50SBN	E50SCL	—
Receptacle: ①	E50RA	E50RA	E50RA	E50RB	E50RB	E50RB	E50RB	E50RB
Description	Assembled Switch (Head + Receptacle + Body) Catalog Number			Assembled Switch (Head + Receptacle + Body) Catalog Number				

Operating Head Type ②

Side Rotary



Standard spring return—E50DR1 ③	E50AR1	E50ALR1	E50ANR1	E50BR1	E50BLR1	E50BNR1	—	—
Low force spring return—E50DL1 ③	E50AL1	E50ALL1	E50ANL1	E50BL1	E50BLL1	E50BNL1	—	—
Maintained two-position—E50DM1	E50AM1	E50ALM1	E50ANM1	E50BM1	E50BLM1	E50BNM1	—	—

Side Pushbutton

Spring Return



Spring return—E50DS1	E50AS1	E50ALS1	E50ANS1	E50BS1	E50BS1	E50BNS1	E50CLS1	—
----------------------	--------	---------	---------	--------	--------	---------	---------	---

Adjustable Spring Return



Adjustable spring return—E50DS2	E50AS2	E50ALS2	E50ANS2	E50BS2	E50BS2	E50BNS2	E50BLS2	E50CNS2
---------------------------------	--------	---------	---------	--------	--------	---------	---------	---------

Circuit Diagrams, see **Page V8-T2-64**.

Notes

① Connection options (add the code suffix from the table below to the end of the catalog number):

Option		Mating Cordset Catalog Number	Code Suffix
Mini-connector ④ (with epoxy filled receptacle)	Single-pole (5-pin mini-connector)	CSMS5D5CY1602	P5 ⑤
	Two-pole (9-pin mini-connector)	CSMS9D9CY1602	P9 ⑤
Micro-connector ④ (with epoxy filled receptacle)	Single-pole (5-pin micro-connector)	CSDS5A5CY2202	A5 ⑤
Cable connection (with epoxy filled receptacle)	8 ft cable length	—	S
	12 ft cable length	—	S12
	20 ft cable length	—	S20
Manifold mount (rear wiring entrance)	—	—	M
20 mm conduit entrance	—	—	20

② For operating head specifications, see **Page V8-T2-58**.

③ CW (clockwise) and CCW (counterclockwise) operation, easily convertible to CW only or CCW only operation.

④ For a full selection of cable connectors, see **Tab 10, section 10.1**.

⑤ Refer to **Page V8-T2-64** for wiring diagrams.

E50 Heavy-Duty Plug-In Switches, Assembled—Standard, continued

Assembled Switch



Single-Pole (5 Terminal Receptacle)

Two-Pole (9 Terminal Receptacle)

Indicating Light:	None	LED (24–120 Vac/dc)	Neon (120 Vac)	None	LED (24–120 Vac/dc)	Neon (120 Vac)	LED (24–120 Vac/dc)	Neon (120 Vac)
Switch Body:	E50SA	E50SAL	E50SAN	E50SB	E50SBL	E50SBN	E50SCL	—
Receptacle: ①	1NO-1NC	1NO-1NC	1NO-1NC	2NO-2NC	2NO-2NC	2NO-2NC	1NO-2NC	—
	E50RA	E50RA	E50RA	E50RB	E50RB	E50RB	E50RB	E50RB
Operating Head Type ②	Description			Description				
	Assembled Switch (Head + Receptacle + Body)			Assembled Switch (Head + Receptacle + Body)				
	Catalog Number			Catalog Number				

Side Push Roller



Spring return— E50DS3 ③	E50AS3	E50ALS3	E50ANS3	E50BS3	E50BLS3	E50BNS3	E50BLS3	—
	CE							

Side Pushbutton



Maintained— E50DH1	E50AH1	E50ALH1	E50ANH1	E50BH1	E50BLH1	E50BNH1	E50BLH1	—
	CE							

Top Pushbutton

Spring Return



Spring return— E50DT1	E50AT1	E50ALT1	E50ANT1	E50BT1	E50BLT1	E50BNT1	E50CLT1	E50BNT1
	CE							

Adjustable Spring Return



Adjustable spring return—E50DT2	E50AT2	E50ALT2	E50ANT2	E50BT2	E50BLT2	E50BNT2	—	—
	CE							

Circuit Diagrams, see Page V8-T2-64.

Notes

① Connection options (add the code suffix from the table below to the end of the catalog number):

Option		Mating Cordset Catalog Number	Code Suffix	
Mini-connector ④ (with epoxy filled receptacle)	Single-pole (5-pin mini-connector)	CSMS5D5CY1602	P5 ⑤	
	Two-pole (9-pin mini-connector)	CSMS9D9CY1602	P9 ⑤	
Micro-connector ④ (with epoxy filled receptacle)	Single-pole (5-pin micro-connector)	CSDS5A5CY2202	A5 ⑤	
	Cable connection (with epoxy filled receptacle)	8 ft cable length	—	S
		12 ft cable length	—	S12
20 ft cable length		—	S20	
Manifold mount (rear wiring entrance)		—	M	
20 mm conduit entrance		—	20	

② For operating head specifications, see Page V8-T2-58.

③ Roller can be converted in the field between horizontal and vertical.

④ For a full selection of cable connectors, see Tab 10, section 10.1.

⑤ Refer to Page V8-T2-64 for wiring diagrams.

2.6

Limit Switches

E50 Heavy-Duty Plug-In Switches

2

Assembled Switch



E50 Heavy-Duty Plug-In Switches, Assembled—Standard, continued



Single-Pole (5 Terminal Receptacle)

Two-Pole (9 Terminal Receptacle)

Indicating Light:	None	LED (24–120 Vac/dc)	Neon (120 Vac)	None	LED (24–120 Vac/dc)	Neon (120 Vac)	LED (24–120 Vac/dc)	Neon (120 Vac)
Switch Body:	E50SA	E50SAL	E50SAN	E50SB	E50SBL	E50SBN	E50SCL	—
Receptacle: ①	1NO-1NC	1NO-1NC	1NO-1NC	2NO-2NC	2NO-2NC	2NO-2NC	1NO-2NC	—
	E50RA	E50RA	E50RA	E50RB	E50RB	E50RB	E50RB	E50RB
Description	Assembled Switch (Head + Receptacle + Body)			Assembled Switch (Head + Receptacle + Body)				
Catalog Number	Catalog Number			Catalog Number				

Operating Head Type ②

Top Push Roller



Spring return E50DT3 ③	E50AT3 CE	E50ALT3	E50ANT3	E50BT3	E50BLT3	E50BNT3	—	—
---------------------------	--------------	---------	---------	--------	---------	---------	---	---

Wobble Head, Spring Return



Standard duty— E50DW1	E50AW1 CE	E50ALW1	E50ANW1	E50BW1	E50BLW1	E50BNW1	EB50BLW1	—
Heavy-duty high strength steel— E50DW2	E50AW2 CE	E50ALW2	E50ANW2	E50BW2	E50BLW2	E50BNW2	E50CLW2	E50BNW2

Circuit Diagrams, see [Page V8-T2-64](#).

Notes

① Connection options (add the code suffix from the table below to the end of the catalog number):

Option		Mating Cordset Catalog Number	Code Suffix	
Mini-connector ④ (with epoxy filled receptacle)	Single-pole (5-pin mini-connector)	CSMS5D5CY1602	P5 ⑤	
	Two-pole (9-pin mini-connector)	CSMS9D9CY1602	P9 ⑤	
Micro-connector ④ (with epoxy filled receptacle)	Single-pole (5-pin micro-connector)	CSDS5A5CY2202	A5 ⑤	
	Cable connection (with epoxy filled receptacle)	8 ft cable length	—	S
		12 ft cable length	—	S12
	20 ft cable length	—	S20	
Manifold mount (rear wiring entrance)		—	M	
20 mm Conduit Entrance		—	20	



② For operating head specifications, see [Page V8-T2-58](#).

③ Roller can be converted in the field between horizontal and vertical.

④ For a full selection of cable connectors, see [Tab 10, section 10.1](#).

⑤ Refer to [Page V8-T2-64](#) for wiring diagrams.

Assembled Switches—Special Purpose**E50 Heavy-Duty Plug-In Switches, Assembled—Special Purpose**

	Operating Data— Nominal Switches	Assembled Switch Catalog Number	Switch Body Only Catalog Number	Receptacle Only Catalog Number	Operating Head Only Catalog Number
Neutral Position	Neutral Position (requires an operating lever, see Page V8-T2-79)				
	5° Travel	E50NN1 ①	E50SN	E50RB	E50DN1 ①
	5° Travel; stainless steel shaft	E50NN1SPL ②	—	—	—
	15° Travel	E50NN2	E50SN	E50RB	E50DN2 ①
	Travel to operate contacts:	—	—	—	5° or 15° ③
	Travel to reset contacts:	—	—	—	2°
	Total travel:	—	—	—	90°
	Force to operate contacts:	—	—	—	1.8 in-lbs
	Minimum return force:	—	—	—	2.5 in-oz
	Operating temperature:	—	—	—	14° to 200°F (–10° to 94°C)
Two-Step	Two-Step CW, CCW, or both, Convertible (requires an operating lever, see Page V8-T2-79)				
	—	E50TD1	E50ST	E50RB	E50DD1
	Travel to operate contacts:	—	—	—	1st step 10°; 2nd step 20°
	Travel to reset contacts:	—	—	—	4° each
	Total travel:	—	—	—	90°
	Force to operate contacts:	—	—	—	3 in-lbs
	Minimum return force:	—	—	—	4.5 in-oz
	Operating temperature:	—	—	—	CW or CCW: 14° to 250°F (–10° to 121°C) CW and CCW: 14° to 200°F (–10° to 94°C)
Gravity Return	Gravity Return (requires E50KL220, E50KL226 or equivalent operating lever, see Page V8-T2-79)				
	Without indicating light	E50GG1	E50SG	E50RA	E50DG1
	With LED indicating light (24–120 Vac/dc)	E50GLG1	E50SGL	E50RA	E50DG1
	With neon indicating light (120 Vac)	E50GNG1	E50SGN	E50RA	E50DG1
	Travel to operate contacts:	—	—	—	10° to 170°
	Travel to reset contacts:	—	—	—	8°
	Total travel:	—	—	—	360°
	Force to operate contacts:	—	—	—	3.0 in-oz
	Minimum return force:	—	—	—	Gravity
	Operating temperature:	—	—	—	14° to 200°F (–10° to 94°C)
	Circuit Diagrams , see Page V8-T2-64 .				

Notes

- ① Add **9** suffix to the model number for low temperature –40° to 174°F (–40 to 79°C) versions.
 ② Low temperature rating –40° to 174°F (–40° to 79°C)
 ③ Depending upon model selected.

2.6

Limit Switches

E50 Heavy-Duty Plug-In Switches

Operating Heads

2

E50 Heavy-Duty Plug-In Switches, Operating Heads

Description	Travel to Operate Contacts	Travel to Reset Contacts	Total Travel	Force to Operate Contacts	Minimum Return Force	Operating Temperature ^①		Catalog Number
						Without Cable	With Pre-Wired Cable	
Side Rotary (requires an operating lever, see Page V8-T2-79)								
Standard spring return ^②	5°	2°	90°	3 in-lbs	4.5 in-oz	10° to 200°F (-12° to 94°C) ^③	10° to 200°F (-12° to 94°C) ^③	E50DR1
Low temperature spring return ^②	5°	2°	90°	3 in-lbs	4.5 in-oz	-40° to 175°F (-40° to 79°C)	-31° to 175°F (-34° to 79°C)	E50DR19
Low force spring return ^②	15°	6°	90°	1.5 in-lbs	2.5 in-oz	10° to 200°F (-12° to 94°C) ^③	10° to 200°F (-12° to 94°C) ^③	E50DL1
Maintained two-position	50°	50°	90°	3 in-lbs	—	14° to 200°F (-10° to 94°C)	14° to 200°F (-10° to 94°C)	E50DM1
Side Pushbutton								
Spring return	0.065 in	0.030 in	0.250 in	4 lbs	8 oz	14° to 200°F (-10° to 94°C)	14° to 200°F (-10° to 94°C)	E50DS1
Adjustable Spring Return	0.065 in	0.030 in	0.250 in	4 lbs	8 oz	14° to 200°F (-10° to 94°C)	14° to 200°F (-10° to 94°C)	E50DS2
Side Push Roller								
Spring return ^④	0.065 in	0.030 in	0.250 in	4 lbs	8 oz	14° to 200°F (-10° to 94°C)	14° to 200°F (-10° to 94°C)	E50DS3 ^⑤
	0.065 in	0.030 in	0.250 in	4 lbs	8 oz	14° to 200°F (-10° to 94°C)	14° to 200°F (-10° to 94°C)	E50DS4 ^⑤
Side Pushbutton								
Maintained	0.200 in	0.130 in	0.320 in	5 lbs	5 lbs	14° to 200°F (-10° to 94°C)	14° to 200°F (-10° to 94°C)	E50DH1
Top Pushbutton								
Spring return	0.040 in	0.020 in	0.280 in	4 lbs	8 oz	14° to 250°F (-10° to 121°C)	14° to 221°F (-10° to 105°C)	E50DT1
Adjustable Spring Return	0.040 in	0.020 in	0.280 in	4 lbs	8 oz	14° to 250°F (-10° to 121°C)	14° to 221°F (-10° to 105°C)	E50DT2

Notes

- ① Temperature ranges below 32°F (0°C) are based on absence of freezing moisture or water.
- ② CW (clockwise) and CCW (counterclockwise) operation, easily convertible to CW only or CCW only operation.
- ③ For CW and CCW operation. For CW only or CCW only operation, high temperature limit increases to 250°F (121°C) without cable, and 221°F (105°C) with pre-wired cable.
- ④ Roller can be converted in the field between horizontal and vertical.
- ⑤ Roller shaft is 0.38 in (9.5 mm) longer on E50DS4, see Dimensions on [Page V8-T2-65](#).

E50 Heavy-Duty Plug-In Switches, Operating Heads, continued

Description	Travel to Operate Contacts	Travel to Reset Contacts	Total Travel	Force to Operate Contacts	Minimum Return Force	Operating Temperature ^①		Catalog Number
						Without Cable	With Pre-wired Cable	
Top Push Roller	Top Push Roller							
Spring return	0.040 in	0.020 in	0.280 in	4 lbs	8 oz	14° to 250°F (-10° to 121°C)	14° to 221°F (-10° to 105°C)	E50DT3
Wobble Head, Spring Return	Wobble Head, Spring Return (requires a wobble operator, see Page V8-T2-79)							
Standard duty	10°	6°	15°	2 in-lbs	2.4 in-oz	14° to 250°F (-10° to 121°C)	14° to 221°F (-10° to 105°C)	E50DW1
Heavy-duty high strength steel	10°	6°	15°	2 in-lbs	2.4 in-oz	14° to 250°F (-10° to 121°C)	14° to 221°F (-10° to 105°C)	E50DW2

Switch Bodies

E50 Heavy-Duty Plug-In Switches, Switch Bodies



Single-Pole 1N0-1NC
Catalog Number



Two-Pole 2N0-2NC
Parallel Wired Indicator Light
Catalog Number



Two-Pole 2NC-1N0
Series Wired Indicator Light
Catalog Number

Switch Body Construction ^①	Single-Pole 1N0-1NC Catalog Number	Two-Pole 2N0-2NC Parallel Wired Indicator Light Catalog Number	Two-Pole 2NC-1N0 Series Wired Indicator Light Catalog Number
Without indicating light	E50SA CE	E50SB	—
With LED indicating light 24–120 Vac/dc	E50SAL	E50SBL	E50SCL
With neon indicating light 120 Vac	E50SAN	E50SBN	—









Circuit Diagrams, see [Page V8-T2-64](#).

Note

^① Indicating lights are supplied from the factory wired as shown in Circuit Diagrams on [Page V8-T2-64](#). However, they can be easily re-connected to terminals 1 and 2 if necessary (SPDT).

Receptacles

E50 Heavy-Duty Plug-In Switches, Receptacles

	Description	Poles	Conduit Entrance	Cable Length	Catalog Number
	Surface Mount				
	Conduit entrance, front or rear mounting	Single-pole (5 terminal)	1/2 NPT	—	E50RA
			20 mm	—	E50RA20
		Two-pole (9 terminal)	1/2 NPT	—	E50RB
			3/4 NPT	—	E50RB34
20 mm	—	E50RB20			
	Manifold Mount				
	Rear wiring entrance instead of conduit hole, gasket on back for oil tightness	Single-pole (5 terminal)	—	—	E50RAM
		Two-pole (9 terminal)	—	—	E50RBM
	Mini-Connector				
	Epoxy filled receptacle with pre-wired mini-connector. (The -W version is a wiring scheme typically used in automotive applications.)	Single-pole (5 terminal)	5-pin mini-connector	—	E50RAP5 
				—	E50RAP5-W 
Two-pole (9 terminal)	9-pin mini-connector	—	E50RBP9 		
	Micro-Connector				
Epoxy filled receptacle with M12 DC micro-connector	Single-pole (5 terminal)	—	—	E50RAA5 ^①	
	Pre-Wired Cable				
	Epoxy filled receptacle with pre-wired 16 gauge, yellow jacketed, type SOOW-A cable. Cable enters through hole threaded for conduit.	Single-pole (5 terminal)	1/2 NPT	8 ft	E50RAS
				12 ft	E50RAS12
				20 ft	E50RAS20
			20 mm	8 ft	E50RA20S
				12 ft	E50RA20S12
				20 ft	E50RA20S20
		Two-pole (9 terminal)	1/2 NPT	8 ft	E50RBS
				12 ft	E50RBS12
			20 ft	E50RBS20	
20 mm				8 ft	E50RB20S
	12 ft	E50RB20S12			
20 ft	E50RB20S20				

Wiring Diagrams, see [Page V8-T2-64](#).





Notes

 See listing of compatible connector cables on [Page V8-T2-61](#).

^① Model E50RAA5 is not UL listed or CSA certified.



Compatible Connector Cables

Standard Cables ^①

	Current Rating at 600V	Voltage Style	Number of Pins	Gauge	Length	Pin Configuration/Wire Colors (Face View Female Shown)	Catalog Number
Mini-style Straight Female 	Mini-Style, Straight Female						
	8A	—	5-pin	16 AWG	6 ft (2m)	 <ul style="list-style-type: none"> 1-White 2-Red 3-Green 4-Orange 5-Black 	CSMS5D5CY1602
	7A	—	9-pin	16 AWG	12 ft (4m)	 <ul style="list-style-type: none"> 1-Orange 2-Blue 3-Red/Black 4-Green/Black 5-White 6-Red 7-Green 8-White/Black 9-Black 	CSMS9D9CY1602
Micro-Style 	Micro-Style						
	4A	—	5-pin, 5-wire	22 AWG	6.0 ft (2m)	 <ul style="list-style-type: none"> 1-Brown 2-White 3-Blue 4-Black 5-Green/Yellow 	CSDS5A5CY2202

Accessories

E50 Heavy-Duty Plug-In Switch Accessories





	Description	Catalog Number
E50KH7 	Adapter Plate	
	Allows E50 to replace Square D Type AW Surface Mounting Non Plug-In Standard Box Limit Switch	E50KH7
E50KH4 	Allows E50 to replace National Acme, Type D-1200M, Style 2 Mounting. Denison LoxSwitch, Model L-100W, Style 2 Mounting. Square D 9007 Type T, Style B Mounting. (Adapter plate is 1/8 in thick, with 1/4 in mounting holes.) Namco® long mount.	E50KH4 ^①
E50KH5 	Allows E50 to replace National Acme, Type D-1200M, Style 1 Mounting. Denison LoxSwitch, Model L-100W, Style 1 Mounting. Square D 9007 Type T, Style C mounting. (Adapter plate is 1/8 in thick, with 1/4 in mounting holes.)	E50KH5 ^①

Dimensions, see **Page V8-T2-66**.

Note

^① For a full selection of connector cables, see **Tab 10, section 10.1**.

E50 Heavy-Duty Plug-In Switch Accessories, continued

Description	Catalog Number
Adapter Plate, continued	
E50KH2  Allows E50 to replace Eaton's 10316 Type LT Non Plug-In Two-Pole Limit Switch	E50KH2
E50KH10  Allows E50 to replace Allen-Bradley 802M Sealed Limit Switch	E50KH10
Adjustable Mounting Plate	
E50KH3  This is a mounting plate only 5/16 in thick and includes the proper mounting bolts and nuts. The slots in the plate allow a maximum horizontal adjustment of 1 in and vertical adjustment of 1-1/4 in	E50KH3 ①
E50KH6  1/2 in oiltight	E50KH6

Dimensions, see **Page V8-T2-66**.

Note

① Limit switch not included.

Technical Data and Specifications

E50 Heavy-Duty Plug-In Switches

Description	Specification
Environmental ratings	NEMA 1, 3, 3S, 4, 4X, 6, 6P, 13, IP67
Material of construction	Zinc die cast
Switch gasket material	Viton
Universal U.S./DIN mounting dimensions	1.16 in (30 mm) x 2.34 in (60 mm)
Conduit entrance	1/2 in NPT or 20 mm threading
Contact ratings	See below
Contact operation	Snap action over center mechanism
Contact material	Fine silver
Maximum frequency of operation	8000 operations per hour
Mechanical life	
Side rotary	13,000,000 operations minimum
Side or top push	10,000,000 operations minimum
Electrical life	
Single-pole	1,000,000 operations typical at full load
Two-pole	100,000 operations typical at full load

E50 Heavy-Duty Plug-In Switches, continued

Description	Specification
Ambient temperature range—standard	
Standard without cable	14° to 250°F (–10° to 121°C)
Standard with cable	14° to 221°F (–10° to 105°C)
Low temperature without cable	–40° to 250°F (–40° to 121°C)
Low temperature with cable	–40° to 221°F (–40° to 105°C)
Repeat accuracy—standard	
Side operated	Within 0.0012 in
Top operated	Within 0.0003 in
Side rotary	Within 0.0014 in
Torque requirements:	
Switch body screws	25–30 lb-in
Operating head screws	14–18 lb-in
Wire size	Will accept AWG #22–#12, single or stranded wire

Electrical Data—Maximum Contact Ratings (Same polarity each pole)

AC Volts	Current, Amperes			Voltamperes		DC Volts	Current, Amperes	
	Make	Break	Cont. ①	Make	Break		Max. Make or Break	Cont. ①
All Switches Except Gravity Return and Indicating Light Versions								
NEMA A600 Rating						NEMA R300		
120	60	6	10	7200	720	125	0.22	1.0
240	30	3	10	7200	720	250	0.11	1.0
480	15	1.5	10	7200	720	250	0.11	1.0
600	12	1.2	10	7200	720	250	0.11	1.0
Switches with Indicating Lights (LED or Neon)								
NEMA A150 Rating						NEMA R150		
120	60	6	10	7200	720	125	0.22	1.0
Gravity Return Switches—Maximum Contact Ratings								
NEMA 6600 Rating—Contacts on same polarity								
120	30	3	5	3600	360	—	—	—
240	15	1.5	5	3600	360	—	—	—
480	7.5	0.75	5	3600	360	—	—	—
600	6	0.60	5	3600	360	—	—	—

Note

① Thermal rating. Valid only if switch does not have to make or break.

2.6

Limit Switches

E50 Heavy-Duty Plug-In Switches

Circuit Diagrams

Standard Assembled Switches and Switch Bodies

2

Single-Pole 1NO-1NC

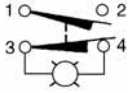

Must be same polarity.

Two-Pole 2NO-2NC

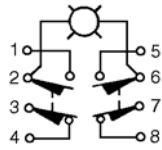

Parallel wired indicator light.
Same polarity each pole.

Two-Pole 1NO-2NC

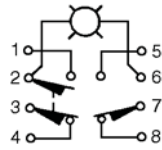

Series wired indicator light.
Same polarity each pole.

Special Purpose Assembled Switches

Neutral Position

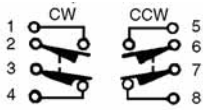

Same polarity, each pole.

Two-Step (CW, CCW, or Both)

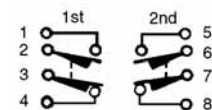

Same polarity, each pole.

Gravity Return



Must be same polarity.

Wiring Diagrams

Receptacles ①

E50RAP5

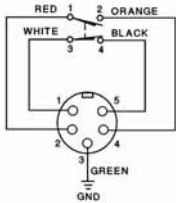

E50RAP5-W

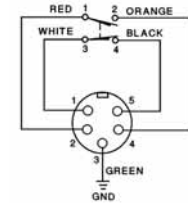

E50RBP9

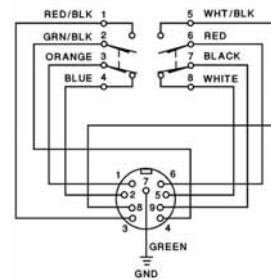

E50RAA5

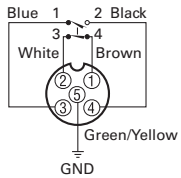

E50RAS_

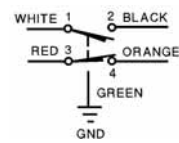

E50RBS_

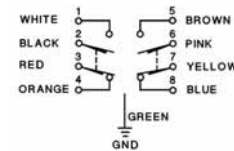

Note

① The wire colors referenced on these diagrams are those internal to the switch itself.

Dimensions

Approximate Dimensions in Inches (mm)

Standard

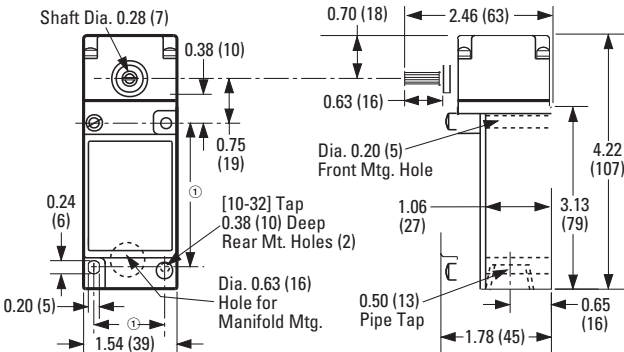

E50SB34

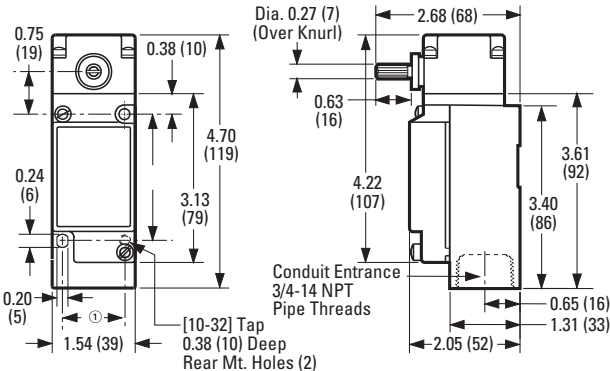

Side Push Operators

Approximate Dimensions in mm [in]

Pushbutton

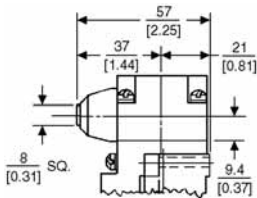

Adjustable Pushbutton

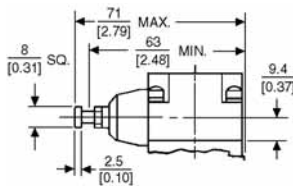

Roller

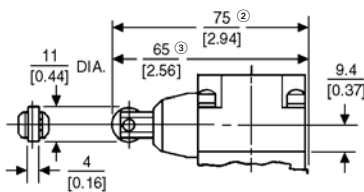

Maintained Pushbutton

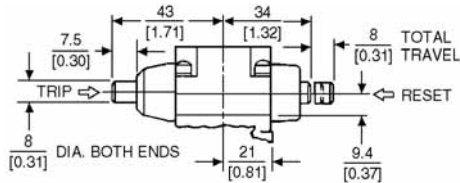

Top Push Operators

Pushbutton

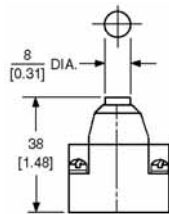

Adjustable Pushbutton

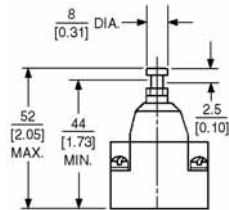

Roller

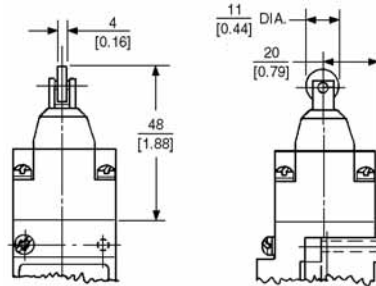

Wobble Operators

See Operators on Page V8-T2-79.

Notes

- ① Can accommodate both U.S., 1.16 (29.4) x 2.34 (59.5) and DIN, 1.18 (30) x 2.36 (60), mounting dimensions.
- ② For E50DS4.
- ③ For E50DS3.

2.6

Limit Switches

E50 Heavy-Duty Plug-In Switches

Accessories

Approximate Dimensions in mm [in]

2

Adapter Plates

E50KH1M

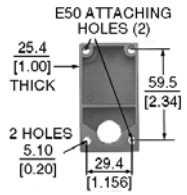

E50KH7

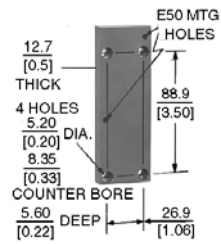

E50KH4

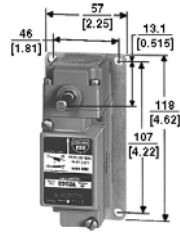

E50KH5

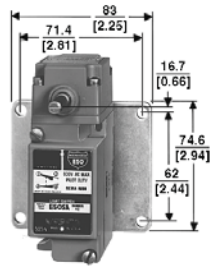

E50KH2

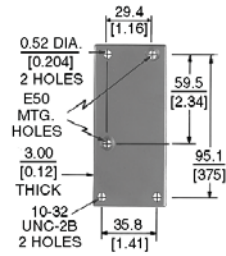

E50KH10

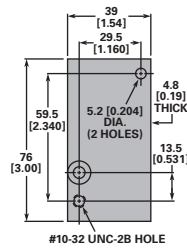

Adjustable Mounting Plate

E50KH3

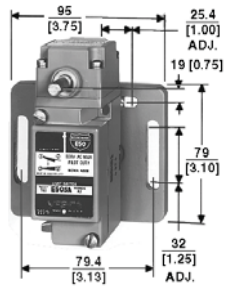

E50 Heavy-Duty Factory Sealed 6P+ Switches



Contents

Description

Page

E50 Heavy-Duty Factory Sealed 6P+ Switches	
Product Selection	
Assembled Switches—Standard	V8-T2-68
Operating Heads	V8-T2-71
Switch Bodies	V8-T2-72
Compatible Connector Cables	V8-T2-73
Accessories	V8-T2-73
Technical Data and Specifications	V8-T2-75
Circuit Diagrams	V8-T2-76
Wiring Diagrams	V8-T2-76
Dimensions	V8-T2-77

Drawings
Online

E50 Heavy-Duty Factory Sealed 6P+ Switches

Product Description

E50 6P+ Limit Switches by Eaton's electrical sector were specifically designed to withstand the penetrating properties of cutting fluids and coolants, such as those used in the automotive industry, as well as extreme shock, vibration and temperature fluctuations. The one-piece, epoxy filled switch body is prewired at the factory to ensure leak-proof, submersible performance. This unique construction positively stops fluid from finding its way to any and all critical connections.

Our 6P+ switches can be ordered in separate components or as complete assembled devices. They are available with prewired 16 AWG cables or mini-connectors. Standard and custom cable lengths are available. As part of the E50 line, the 6P+ switches use the same operating heads as the standard E50 plug-in models to reduce the components you need to inventory.

Features

- Manufactured to take the physical and environmental abuse (including cutting fluids and chemicals) of harsh industrial environments
- Modular, plug-in components (head and switch body) provide application flexibility, reduced inventory and less downtime
- Chemical resistant Viton gaskets, seals and boots are standard, and so are captive, posi-drive screws
- A special internal seal on the switch body prevents fluid from entering even when the operating head is not attached
- 600V rating, ridge-topped contacts and wiping action assure continuity even to logic level circuits
- Factory wired cable features a 350 pound pullout capacity
- Keyed, four direction head positioning. Standard 5° pre-travel and 90° total travel
- 24–120 Vac/dc LED and 120 Vac neon indicating lights available
- Rotary heads are field convertible CW, CCW, or both, without special tools

Standards and Certifications

- UL Listed, E170645
- CSA Certified, 50513
- CE (where shown)
- RoHS Compliant

DANGER

THIS SENSOR IS NOT A SAFETY DEVICE AND IS NOT INTENDED TO BE USED AS A SAFETY DEVICE. This sensor is designed only to detect and read certain data in an electronic manner and perform no use apart from that, specifically no safety-related use. This sensor product does not include self-checking redundant circuitry, and the failure of this sensor product could cause either an energized or de-energized output condition, which could result in death, serious bodily injury, or property damage.

For the most current information on this product, visit our Web site: www.eaton.com

For Customer Service in the U.S. call 1-877-ETN CARE (386-2273), in Canada call 1-800-268-3578.

For Application Assistance in the U.S. and Canada call 1-800-426-9184.

Product Selection

2

Assembled Switches—Standard

Connection is by 8 ft cable ①.

Assembled Switch

E50 Heavy-Duty Factory Sealed 6P+ Switches, Assembled—Standard



Lever sold separately



Single-Pole



Two-Pole

Indicating Light:	None	LED (24–120 Vac/dc)	Neon (120 Vac)	None	LED (24–120 Vac/dc)	Neon (120 Vac)
Switch Body:	E50SA6P 1NO-1NC	E50SAL6P 1NO-1NC	E50SAN6P 1NO-1NC	E50SB6P 2NO-2NC	E50SBL6P 2NO-2NC	E50SBN6P 2NO-2NC

Operating Head Type ②

Side Rotary



Description	Assembled Switch Catalog Number			Assembled Switch Catalog Number		
Side Rotary (requires an operating lever, see Page V8-T2-79)						
Standard spring return—E50DR1 ③	E50AR16P CE	E50ALR16P	E50ANR16P	E50BR16P	E50BLR16P	E50BNR16P
Low force spring return—E50DL1 ③	E50AL16P CE	E50ALL16P	E50ANL16P	E50BL16P	E50BLL16P	E50BNL16P
Maintained two-position—E50DM1	E50AM16P CE	E50ALM16P	E50ANM16P	E50BM16P	E50BLM16P	E50BNM16P

Spring Return



Spring return—E50DS1	E50AS16P CE	E50ALS16P	E50ANS16P	E50BS16P	E50BLS16P	E50BNS16P
----------------------	----------------	-----------	-----------	----------	-----------	-----------

Adjustable Spring Return



Adjustable spring return—E50DS2	E50AS26P CE	E50ALS26P	E50ANS26P	E50BS26P	E50BLS26P	E50BNS26P
---------------------------------	----------------	-----------	-----------	----------	-----------	-----------

Circuit Diagrams, see Page V8-T2-76.

Notes

① Connection options (add the code suffix from the table below to the end of the catalog number):

Option		Catalog Number	Code Suffix
Mini-connector ④	Single-pole (5-pin mini-connector)	CSMS5D5CY1602	C
	Two-pole (9-pin mini-connector)	CSMS9D9CY1602	C
Cable connection	12 ft cable length (standard)	—	12
	20 ft cable length (standard)	—	20
	Other lengths (special order)	—	Length in ft

② For operating head specifications, see Page V8-T2-71.

③ CW (clockwise) and CCW (counterclockwise) operation, easily convertible to CW only or CCW only operation.

④ For a full selection of connector cables, see Tab 10, section 10.1.

Connection is by 8 ft cable ①.

E50 Heavy-Duty Factory Sealed 6P+ Switches, Assembled—Standard, continued

Assembled Switch



Lever sold separately



Single-Pole



Two-Pole

Indicating Light:	None	LED (24–120 Vac/dc)	Neon (120 Vac)	None	LED (24–120 Vac/dc)	Neon (120 Vac)
Switch Body:	E50SA6P 1NO-1NC	E50SAL6P 1NO-1NC	E50SAN6P 1NO-1NC	E50SB6P 2NO-2NC	E50SBL6P 2NO-2NC	E50SBN6P 2NO-2NC

Operating Head Type ②

Description	Assembled Switch Catalog Number			Assembled Switch Catalog Number		
-------------	---------------------------------	--	--	---------------------------------	--	--

Side Push Roller



Side Push Roller						
-------------------------	--	--	--	--	--	--

Spring return— E50DS3 ③	E50AS36P CE	E50ALS36P	E50ANS36P	E50BS36P	E50BLS36P	E50BNS36P
----------------------------	----------------	-----------	-----------	----------	-----------	-----------

Side Pushbutton



Side Pushbutton						
------------------------	--	--	--	--	--	--

Maintained— E50DH1	E50AH16P CE	E50ALH16P	E50ANH16P	E50BH16P	E50BLH16P	E50BNH16P
-----------------------	----------------	-----------	-----------	----------	-----------	-----------

Top Pushbutton

Spring Return



Spring return— E50DT1	E50AT16P CE	E50ALT16P	E50ANT16P	E50BT16P	E50BLT16P	E50BNT16P
--------------------------	----------------	-----------	-----------	----------	-----------	-----------

Adjustable Spring Return



Adjustable spring return—E50DT2	E50AT26P CE	E50ALT26P	E50ANT26P	E50BT26P	E50BLT26P	E50BNT26P
------------------------------------	----------------	-----------	-----------	----------	-----------	-----------

Circuit Diagrams, see Page V8-T2-76.

Notes

① Connection options (add the code suffix from the table below to the end of the catalog number):

Option		Catalog Number	Code Suffix
Mini-connector ④	Single-pole (5-pin mini-connector)	CSMS5D5CY1602	C
	Two-pole (9-pin mini-connector)	CSMS9D9CY1602	C
Cable connection	12 ft cable length (standard)	—	12
	20 ft cable length (standard)	—	20
	Other lengths (special order)	—	Length in ft

② For operating head specifications, see Page V8-T2-71.

③ Roller can be converted in the field between horizontal and vertical.

④ For a full selection of connector cables, see Tab 10, section 10.1.

2.7

Limit Switches

E50 Heavy-Duty Factory Sealed 6P+ Switches

Connection is by 8 ft cable ①.

2

Assembled Switch

E50 Heavy-Duty Factory Sealed 6P+ Switches, Assembled—Standard, continued



Lever sold separately



Single-Pole



Two-Pole

Indicating Light:	Single-Pole			Two-Pole		
	None	LED (24–120 Vac/dc)	Neon (120 Vac)	None	LED (24–120 Vac/dc)	Neon (120 Vac)
Switch Body:	E50SA6P 1NO-1NC	E50SAL6P 1NO-1NC	E50SAN6P 1NO-1NC	E50SB6P 2NO-2NC	E50SBL6P 2NO-2NC	E50SBN6P 2NO-2NC

Operating Head Type ②

Top Push Roller



Description	Assembled Switch Catalog Number			Assembled Switch Catalog Number		
Top Push Roller						
Spring return— E50DT3	E50AT36P CE	E50ALT36P	E50ANT36P	E50BT36P	E50BLT36P	E50BNT36P

Wobble Head, Spring Return



Wobble Head, Spring Return (requires a wobble operator, see Page V8-T2-79)						
Standard duty— E50DW1	E50AW16P CE	E50ALW16P	E50ANW16P	E50BW16P	E50BLW16P	E50BNW16P
Heavy-duty high strength steel— E50DW2	E50AW26P CE	E50ALW26P	E50ANW26P	E50BW26P	E50BLW26P	E50BNW26P

Circuit Diagrams, see Page V8-T2-76.

Notes

① Connection options (add the code suffix from the table below to the end of the catalog number):

Option		Catalog Number	Code Suffix
Mini-connector ③	Single-pole (5-pin mini-connector)	CSMS5D5CY1602	C
	Double-pole (9-pin mini-connector)	CSMS9D9CY1602	C
Cable connection	12 ft cable length (standard)	—	12
	20 ft cable length (standard)	—	20
	Other lengths (special order)	—	Length in ft







② For operating head specifications, see Page V8-T2-71.

③ For a full selection of connector cables, see Tab 10, section 10.1.

E50 Heavy-Duty Factory Sealed 6P+ Switches

Operating Heads

E50 Heavy-Duty Factory Sealed 6P+ Switches, Operating Heads

Description	Travel to Operate Contacts	Travel to Reset Contacts	Total Travel	Force to Operate Contacts	Minimum Return Force	Operating Temperature ^①		Catalog Number	
						Without Cable	With Pre-wired Cable		
Side Rotary									
Side Rotary (requires an operating lever, see Page V8-T2-79)									
 Standard spring return ^②	5°	2°	90°	3 in-lbs	4.5 in-oz	10° to 200°F (-12° to 94°C) ^③	10° to 200°F (-12° to 94°C) ^③	E50DR1	
Low temperature spring return ^②	5°	2°	90°	3 in-lbs	4.5 in-oz	-40° to 175°F (-40° to 79°C)	-31° to 175°F (-34° to 79°C)	E50DR19	
Low force spring return ^②	15°	6°	90°	1.5 in-lbs	2.5 in-oz	10° to 200°F (-12° to 94°C) ^③	10° to 200°F (-12° to 94°C) ^③	E50DL1	
Maintained two-position	50°	50°	90°	3 in-lbs	—	14° to 200°F (-10° to 94°C)	14° to 200°F (-10° to 94°C)	E50DM1	
Side Pushbutton									
 Spring return	0.065 in	0.030 in	0.250 in	4 lbs	8 oz	14° to 200°F (-10° to 94°C)	14° to 200°F (-10° to 94°C)	E50DS1	
Adjustable Spring Return	Adjustable spring return	0.065 in	0.030 in	0.250 in	4 lbs	8 oz	14° to 200°F (-10° to 94°C)	14° to 200°F (-10° to 94°C)	E50DS2
									
Side Push Roller									
 Spring return ^④	0.065 in	0.030 in	0.250 in	4 lbs	8 oz	14° to 200°F (-10° to 94°C)	14° to 200°F (-10° to 94°C)	E50DS3 ^⑤	
	0.065 in	0.030 in	0.250 in	4 lbs	8 oz	14° to 200°F (-10° to 94°C)	14° to 200°F (-10° to 94°C)	E50DS4 ^⑤	
Side Pushbutton									
 Maintained	0.200 in	0.130 in	0.320 in	5 lbs	5 lbs	14° to 200°F (-10° to 94°C)	14° to 200°F (-10° to 94°C)	E50DH1	
Top Pushbutton									
 Spring return	0.040 in	0.020 in	0.280 in	4 lbs	8 oz	14° to 250°F (-10° to 121°C)	14° to 221°F (-10° to 105°C)	E50DT1	
Adjustable Spring Return	Adjustable spring return	0.040 in	0.020 in	0.280 in	4 lbs	8 oz	14° to 250°F (-10° to 121°C)	14° to 221°F (-10° to 105°C)	E50DT2
									

Notes

- ① Temperature ranges below 32°F (0°C) are based on absence of freezing moisture or water.
- ② CW (clockwise) and CCW (counterclockwise) operation, easily convertible to CW only or CCW only operation.
- ③ For CW and CCW operation. For CW only or CCW only operation, high temperature limit increases to 250°F (121°C) without cable, and 221°F (105°C) with pre-wired cable.
- ④ Roller can be converted in the field between horizontal and vertical.
- ⑤ Roller shaft is 0.38 in (9.5 mm) longer on E50DS4, see Dimensions on **Page V8-T2-77**.

E50 Heavy-Duty Factory Sealed 6P+ Switches, Operating Heads, continued

Description	Travel to Operate Contacts	Travel to Reset Contacts	Total Travel	Force to Operate Contacts	Minimum Return Force	Operating Temperature ^①		Catalog Number
						Without Cable	With Pre-Wired Cable	
Top Push Roller								
Top Push Roller								
Spring return	0.040 in	0.020 in	0.280 in	4 lbs	8 oz	14° to 250°F (-10° to 121°C)	14° to 221°F (-10° to 105°C)	E50DT3
Wobble Head, Spring Return (requires a wobble operator, see Page V8-T2-79)								
Standard duty	10°	6°	15°	2 in-lbs	2.4 in-oz	14° to 250°F (-10° to 121°C)	14° to 221°F (-10° to 105°C)	E50DW1
Heavy-duty high strength steel	10°	6°	15°	2 in-lbs	2.4 in-oz	14° to 250°F (-10° to 121°C)	14° to 221°F (-10° to 105°C)	E50DW2
Circuit Diagrams, see Page V8-T2-76.								

Switch Bodies

E50 Heavy-Duty Factory Sealed 6P+, Switch Bodies

Circuit	Switch Body Construction	Cable Length	Catalog Number	
Pre-Wired Cable				
Single-pole 1NO-1NC	Without indicating light	8 ft	E50SA6P	
		12 ft	E50SA6P12	
		20 ft	E50SA6P20	
	With LED indicating light 24–120 Vac/dc	8 ft	E50SAL6P	
		12 ft	E50SAL6P12	
		20 ft	E50SAL6P20	
	With neon indicating light 120 Vac	8 ft	E50SAN6P	
		12 ft	E50SAN6P12	
		20 ft	E50SAN6P20	
	Two-pole 2NO-2NC	Without indicating light	8 ft	E50SB6P
			12 ft	E50SB6P12
			20 ft	E50SB6P20
With LED indicating light 24–120 Vac/dc		8 ft	E50SBL6P	
		12 ft	E50SBL6P12	
		20 ft	E50SBL6P20	
With neon indicating light 120 Vac		8 ft	E50SBN6P	
		12 ft	E50SBN6P12	
		20 ft	E50SBN6P20	
Mini-Connector				
Single-pole 1NO-1NC	Without indicating light normal wiring	—	E50SA6PC ☼	
	Without indicating light alternate wiring	—	E50SA6PC-W ☼	
	With LED indicating light 24–120 Vac/dc	—	E50SAL6PC ☼	
	With neon indicating light 120 Vac	—	E50SAN6PC ☼	
Two-pole 2NO-2NC	Without indicating light	—	E50SB6PC ☼	
	With LED indicating light 24–120 Vac/dc	—	E50SBL6PC ☼	
	With neon indicating light 120 Vac	—	E50SBN6PC ☼	



Notes

☼☼ See listing of compatible connector cables on [Page V8-T2-73](#).

① Temperature ranges below 32°F (0°C) are based on absence of freezing moisture or water.





Compatible Connector Cables

Standard Cables ^①

	Current Rating at 600V	Voltage Style	Number of Pins	Gauge	Length	Pin Configuration/Wire Colors (Face View Female Shown)	Catalog Number
 <p>Mini-Style, Straight Female</p>	Mini-Style, Straight Female						
	8A	—	5-pin	16 AWG	6 ft (2m)	 <p>1-White 2-Red 3-Green 4-Orange 5-Black</p>	CSMS5D5CY1602
	7A	—	9-pin	16 AWG	12 ft (4m)	 <p>1-Orange 2-Blue 3-Red/Black 4-Green/Black 5-White 6-Red 7-Green 8-White/Black 9-Black</p>	CSMS9D9CY1602

Accessories

E50 Heavy-Duty Factory Sealed 6P+ Switch Accessories

		Catalog Number
<p>E50KH1M</p> 	<p>Adapter Plate</p> <p>Allows E50 to replace Eaton's 10316 Type LP Manifold Mounting Plug-In Limit Switch</p>	E50KH1M
<p>E50KH7</p> 	<p>Allows E50 to replace Square D Type AW Surface Mounting Non Plug-In Standard Box Limit Switch</p>	E50KH7
<p>E50KH4</p> 	<p>Allows E50 to replace National Acme, Type D-1200M, Style 2 Mounting. Denison LoxSwitch, Model L-100W, Style 2 Mounting. Square D 9007 Type T, Style B Mounting. (Adapter plate is 1/8 in thick, with 1/4 in mounting holes.) Namco® long mount.</p>	E50KH4 ^①
<p>E50KH5</p> 	<p>Allows E50 to replace National Acme, Type D-1200M, Style 1 Mounting. Denison LoxSwitch, Model L-100W, Style 1 Mounting. Square D 9007 Type T, Style B mounting. (Adapter plate is 1/8 in thick, with 1/4 in mounting holes.)</p>	E50KH5 ^①

Dimensions, see **Page V8-T2-77**.

Note

^① For a full selection of connector cables, see **Tab 10, section 10.1**.

E50 Heavy-Duty Factory Sealed 6P+ Switch Accessories, continued

Catalog Number

Adapter Plate, continued

E50KH2

Allows E50 to replace Eaton's 10316 Type LT Non Plug-In Two-Pole Limit Switch

E50KH2



E50KH10

Allows E50 to replace Allen-Bradley 802M Sealed Limit Switch

E50KH10



Adjustable Mounting Plate

E50KH3

This is a mounting plate only 5/16 in thick and includes the proper mounting bolts and nuts. The slots in the plate allow a maximum horizontal adjustment of 1 in and vertical adjustment of 1-1/4 in

E50KH3 ①

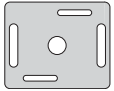

Conduit Sealing Nut

E50KH6

1/2 in oiltight

E50KH6



Dimensions, see **Page V8-T2-77**.

Note

① Limit switch not included.

Technical Data and Specifications

E50 Heavy-Duty Factory Sealed 6P+ Switches

Description	Specification
Environmental ratings	NEMA 1, 3, 3S, 4, 4X, 6, 6P, 13, IP67, IP69
Material of construction	Zinc die cast
Switch gasket material	Viton
Universal U.S./DIN mounting dimensions	1.16 in (30 mm) x 2.34 in (60 mm)
Conduit entrance	1/2 in NPT or 20 mm threading
Contact ratings	See below
Contact operation	Snap action over center mechanism
Contact material	Fine silver
Maximum frequency of operation	8000 operations per hour
Mechanical life	
Side rotary	13,000,000 operations minimum
Side or top push	10,000,000 operations minimum
Electrical life	
Single-pole	1,000,000 operations typical at full load
Double-pole	100,000 operations typical at full load
Ambient temperature range—standard	
Standard without cable	14° to 250°F (–10° to 121°C)
Standard with cable	14° to 221°F (–10° to 105°C)
Low temperature without cable	–40° to 250°F (–40° to 121°C)
Low temperature with cable	–40° to 221°F (–40° to 105°C)
Repeat accuracy—standard	
Side operated	Within 0.0012 in
Top operated	Within 0.0003 in
Side rotary	Within 0.0014 in
Torque requirements	
Operating head screws	14–18 lb-in

Electrical Data—Maximum Contact Ratings (Same polarity each pole)

AC Volts	Current, Amperes			Voltamperes		DC Volts	Current, Amperes	
	Make	Break	Cont. ①	Make	Break		Max. Make or Break	Cont. ①
All Switches Except Gravity Return and Indicating Light Versions								
NEMA A600 Rating						NEMA R300		
120	60	6	10	7200	720	125	0.22	1.0
240	30	3	10	7200	720	250	0.11	1.0
480	15	1.5	10	7200	720	250	0.11	1.0
600	12	1.2	10	7200	720	250	0.11	1.0
Switches with Indicating Lights (LED or Neon)								
NEMA A150 Rating						NEMA R150		
120	60	6	10	7200	720	125	0.22	1.0

Note

① Thermal rating. Valid only if switch does not have to make or break.

2.7

Limit Switches

E50 Heavy-Duty Factory Sealed 6P+ Switches

2

Circuit Diagrams ①

Standard Assembled Switches

Single-Pole 1NO-1NC

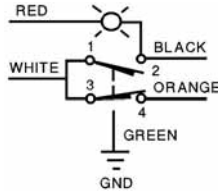
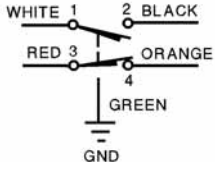

Two-Pole 2NO-2NC

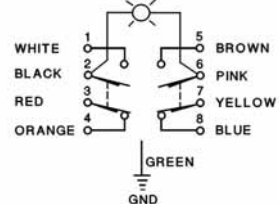
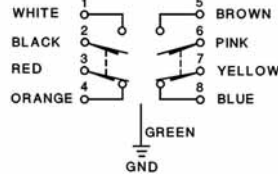

Must be same polarity.

Same polarity, each pole.

Switch Bodies

Pre-Wired Cable—Single-Pole 1NO-1NC

E50SA6P_

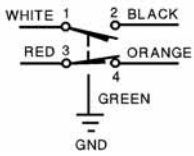

E50SAL6P_

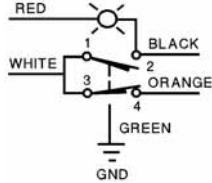

E50SB6P_

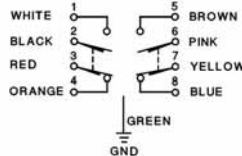

E50SBL6P_

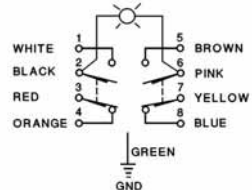

Wiring Diagrams ①

Mini-Connector—Single-Pole 1NO-1NC

E50SA6PC

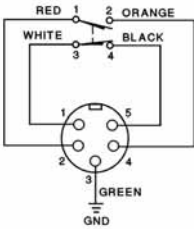

E50SA6PC-W

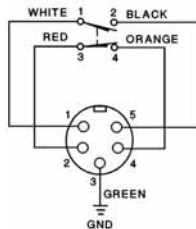

E50SAL6PC/E50SAN6PC

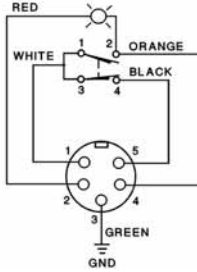

Mini-Connector—Two-Pole 2NO-2NC

E50SB6PC

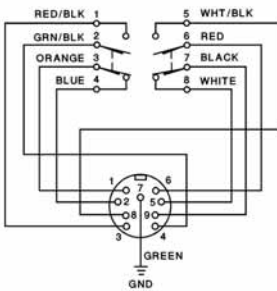

E50SBL6PC/E50SBN6PC

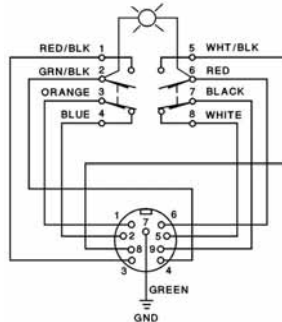

Note

① The wire colors referenced on these diagrams are those internal to the switch itself.

Dimensions

Approximate Dimensions in Inches (mm)

Standard

6P+ Limit Switch with Rotary Operating Head

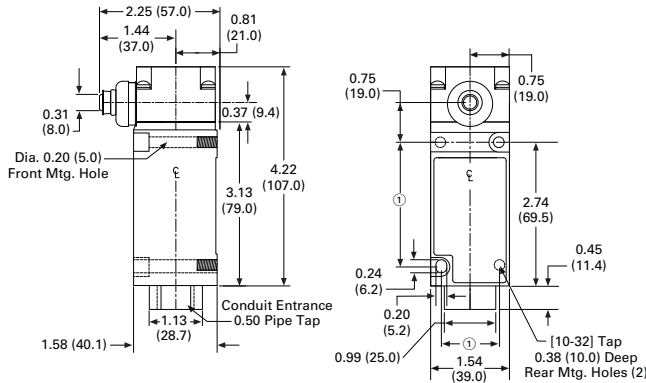

Side Push Operators

Approximate Dimensions in mm [in]

Pushbutton

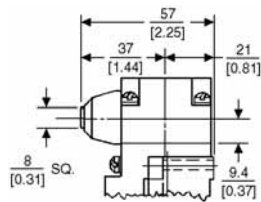

Adjustable Pushbutton

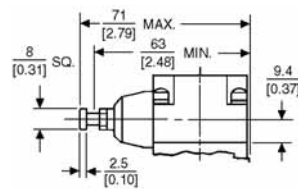

Roller

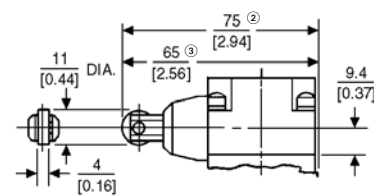

Maintained Pushbutton

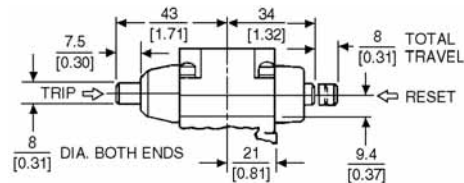

Top Push Operators

Pushbutton

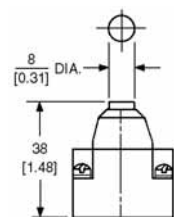

Adjustable Pushbutton

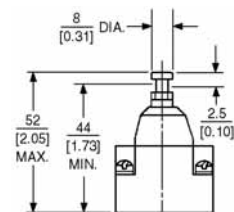

Roller

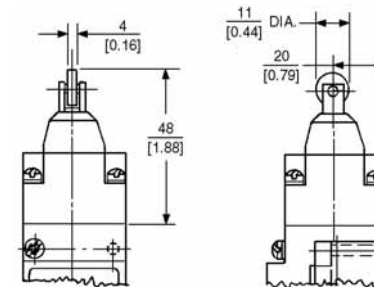

Wobble Operators

See Operators on **Page V8-T2-79**.

Notes

- ① Can accommodate both U.S., 1.16 (29.4) x 2.34 (59.5) and DIN, 1.18 (30.0) x 3.26 (60.0), mounting dimensions.
- ② For E50DS4.
- ③ For E50DS3.

Accessories

Approximate Dimensions in mm [in]

2

Adapter Plates

E50KH1M



E50KH7

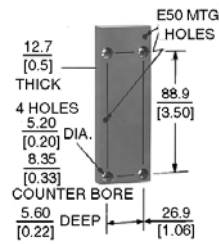

E50KH4

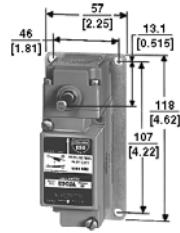

E50KH5

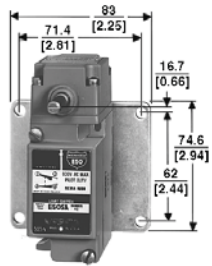

E50KH2

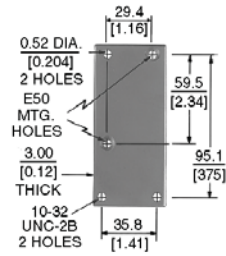

E50KH10

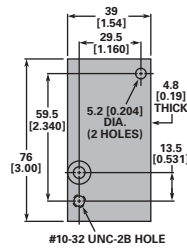

Adjustable Mounting Plate

E50KH3

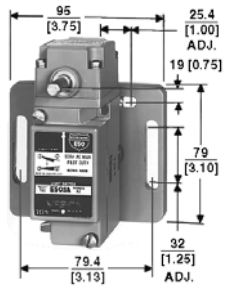

Operators



Contents

Description

Page

Operators	
Product Selection	
Roller Type Operators	V8-T2-80
Rod Type Operators	V8-T2-82
Wobble Type Operators	V8-T2-83
Dimensions	V8-T2-83

 Drawings
Online

Operators

Product Description

The Operators presented here are used with Eaton’s E50 Plug-In and 6P+ limit switches, as well as our 10316 rotary type limit switches. A wide variety of styles and sizes are available to provide optimum performance for nearly any application.

Features

- Wide variety of operator types for rotary and wobble style limit switches
- Rollers and rods available in metal and nonmetal contact surfaces

 **DANGER**

THIS SENSOR IS NOT A SAFETY DEVICE AND IS NOT INTENDED TO BE USED AS A SAFETY DEVICE. This sensor is designed only to detect and read certain data in an electronic manner and perform no use apart from that, specifically no safety-related use. This sensor product does not include self-checking redundant circuitry, and the failure of this sensor product could cause either an energized or de-energized output condition, which could result in death, serious bodily injury, or property damage.

For the most current information on this product, visit our Web site: www.eaton.com

For Customer Service in the U.S. call 1-877-ETN CARE (386-2273), in Canada call 1-800-268-3578.
For Application Assistance in the U.S. and Canada call 1-800-426-9184.



Product Selection

2

Roller Type Operators





For rotary head switches: E50 Plug-In, E50 6P+, and 10316.

Note: Only operators with Nylatron rods or rollers should be used with explosion-proof limit switches.**Operators—Roller Type**



Roller Type	Minimum Required Return Torque ^①	Approximate Dimensions in Inches (mm)						Catalog Number	
		A Lever Length ^②	B Roller Diameter	C Roller Width	D	E	F		
E50KL200	Standard Roller (Stainless Steel)								
	Metal	0.95 in-oz	1.38 (34.9)	0.75 (19.0)	0.32 (8.1)	0.34 (8.6)	0.13 (3.3)	0.17 (4.3)	E50KL40
	Ball bearing	0.77 in-oz	1.50 (38.1)	0.69 (17.5)	0.25 (6.4)	0.34 (8.6)	0.05 (1.3)	0.11 (2.8)	E50KL531
	Nylatron	0.53 in-oz	1.50 (38.1)	0.75 (19.0)	0.32 (8.1)	0.34 (8.6)	0.13 (3.3)	0.17 (4.3)	E50KL200
	Metal	1.10 in-oz	1.50 (38.1)	0.75 (19.0)	0.32 (8.1)	0.34 (8.6)	0.13 (3.3)	0.17 (4.3)	E50KL355
E50KL355	Nylatron	0.96 in-oz	1.50 (38.1)	0.75 (19.0)	1.00 (25.4)	0.34 (8.6)	0.83 (21.1)	0.83 (21.1)	E50KL377
	Without roller	0.32 in-oz	1.50 (38.1)	—	—	0.34 (8.6)	—	—	E50KL32
	Ball bearing	1.10 in-oz	2.00 (50.8)	0.69 (17.5)	0.25 (6.4)	0.34 (8.6)	0.05 (1.3)	0.11 (2.8)	E50KL552
	Nylatron	0.71 in-oz	2.00 (50.8)	0.75 (19.0)	0.32 (8.1)	0.34 (8.6)	0.13 (3.3)	0.17 (4.3)	E50KL546
	Metal	1.50 in-oz	2.00 (50.8)	0.75 (19.0)	0.32 (8.1)	0.34 (8.6)	0.13 (3.3)	0.17 (4.3)	E50KL549
E50KL377	Nylatron	1.45 in-oz	2.00 (50.8)	0.75 (19.0)	1.00 (25.4)	0.34 (8.6)	0.83 (21.1)	0.83 (21.1)	E50KL572
	Ball bearing	1.50 in-oz	2.50 (63.5)	0.69 (17.5)	0.25 (6.4)	0.34 (8.6)	0.05 (1.3)	0.11 (2.8)	E50KL553
	Nylatron	1.00 in-oz	2.50 (63.5)	0.75 (19.0)	0.32 (8.1)	0.34 (8.6)	0.13 (3.3)	0.17 (4.3)	E50KL547
	Metal	2.00 in-oz	2.50 (63.5)	0.75 (19.0)	0.32 (8.1)	0.34 (8.6)	0.13 (3.3)	0.17 (4.3)	E50KL550
	Nylatron	1.80 in-oz	2.50 (63.5)	0.75 (19.0)	1.00 (25.4)	0.34 (8.6)	0.83 (21.1)	0.83 (21.1)	E50KL573
E50KL554	Nylatron	1.40 in-oz	2.50 (63.5)	1.50 (38.1)	0.28 (7.1)	0.34 (8.6)	0.11 (2.8)	0.17 (4.3)	E50KL575
	Ball bearing	1.80 in-oz	3.00 (76.2)	0.69 (17.5)	0.25 (6.4)	0.34 (8.6)	0.05 (1.3)	0.11 (2.8)	E50KL554
	Nylatron	1.30 in-oz	3.00 (76.2)	0.75 (19.0)	0.32 (8.1)	0.34 (8.6)	0.13 (3.3)	0.17 (4.3)	E50KL548
	Metal	2.50 in-oz	3.00 (76.2)	0.75 (19.0)	0.32 (8.1)	0.34 (8.6)	0.13 (3.3)	0.17 (4.3)	E50KL551
	Nylatron	2.30 in-oz	3.00 (76.2)	0.75 (19.0)	1.00 (25.4)	0.34 (8.6)	0.83 (21.1)	0.83 (21.1)	E50KL574
	Nylatron	1.80 in-oz	3.00 (76.2)	1.50 (38.1)	0.28 (7.1)	0.34 (8.6)	0.11 (2.8)	0.17 (4.3)	E50KL576
Dimensions, see Page V8-T2-83.									
E50KL580	Roller On Reverse Side (Stainless Steel)								
	Ball bearing	0.77 in-oz	1.50 (38.1)	0.69 (17.5)	0.25 (6.4)	0.34 (8.6)	0.18 (4.6)	0.24 (6.1)	E50KL580
	Nylatron	0.53 in-oz	1.50 (38.1)	0.75 (19.0)	0.32 (8.1)	0.34 (8.6)	0.27 (6.9)	0.31 (7.9)	E50KL310
	Metal	1.10 in-oz	1.50 (38.1)	0.75 (19.0)	0.32 (8.1)	0.34 (8.6)	0.27 (6.9)	0.31 (7.9)	E50KL579
	Nylatron	0.96 in-oz	1.50 (38.1)	1.50 (38.1)	0.28 (7.1)	0.34 (8.6)	0.23 (5.8)	0.31 (7.9)	E50KL536
E50KL24	Offset Inboard Roller (Stainless Steel)								
	Nylatron	0.65 in-oz	1.50 (38.1)	0.75 (19.0)	0.32 (8.1)	0.03 (0.8)	—	—	E50KL24
	Metal	1.20 in-oz	1.50 (38.1)	0.75 (19.0)	0.32 (8.1)	0.03 (0.8)	—	—	E50KL25
	Ball bearing	0.90 in-oz	1.50 (38.1)	0.69 (17.5)	0.25 (6.4)	0.04 (1.0)	—	—	E50KL26
E50KL27	Offset Outboard Roller (Stainless Steel)								
	Nylatron	0.65 in-oz	1.50 (38.1)	0.75 (19.0)	0.32 (8.1)	0.03 (0.8)	—	—	E50KL27
	Metal	1.20 in-oz	1.50 (38.1)	0.75 (19.0)	0.32 (8.1)	0.03 (0.8)	—	—	E50KL28
	Ball bearing	0.90 in-oz	1.50 (38.1)	0.69 (17.5)	0.25 (6.4)	0.04 (1.0)	—	—	E50KL29
	Nylatron	1.10 in-oz	1.50 (38.1)	0.75 (19.0)	1.00 (25.4)	—	—	—	E50KL30
Dimensions, see Page V8-T2-84.									
Notes									
① Caution: When selecting lever, the minimum required return torque of lever should not exceed minimum return force available in operating head as given in operating head specifications.									
② Length from the operating shaft axis to the roller axis (or to the tip for non-roller operators).									

Note: Only operators with Nylatron rods or rollers should be used with explosion-proof limit switches.

Operators—Roller Type, continued

Roller Type	Minimum Required Return Torque ^①	Approximate Dimensions in Inches (mm)							Catalog Number
		A Lever Length ^②	B Roller Diameter	C Roller Width	D	E	F		
E50KL532									
Bantam Lever									
 Metal	0.45 in-oz	0.69 (17.5)	0.85 (22.0)	0.18 (4.6)	—	—	—		E50KL532
E50KL340									
Precision Adjustment									
 Nylatron	0.65 in-oz	0.69 (17.5)	0.75 (19.0)	0.32 (8.1)	0.48 (12.2)	0.24 (6.1)	0.28 (7.1)		E50KL340
Metal	1.20 in-oz	1.50 (38.1) ^③	0.75 (19.0)	0.32 (8.1)	0.48 (12.2)	0.24 (6.1)	0.28 (7.1)		E50KL465
Ball bearing	0.90 in-oz		0.69 (17.5)	0.25 (6.4)	0.48 (12.2)	0.16 (4.1)	0.22 (5.6)		E50KL535
E50KL201									
Dimensions, see Page V8-T2-84.									
Adjustable Roller (Stainless Steel)									
 Ball bearing	2.50 in-oz ^④	1.0 (25.4) to 3.75 (95.2) ^⑤	0.69 (17.5)	0.25 (6.4)	0.23 (5.8)	0.30 (7.6)	—		E50KL539
Nylatron	1.90 in-oz ^④		0.75 (19.0)	0.32 (8.1)	0.29 (7.4)	0.33 (8.4)	—		E50KL201
			0.75 (19.0)	0.32 (8.1)	0.29 (7.4)	0.33 (8.4)	—		E50KL201SPL ^⑥
 Metal	3.40 in-oz ^④		0.75 (19.0)	0.32 (8.1)	0.29 (7.4)	0.33 (8.4)	—		E50KL538
Nylatron	1.90 in-oz ^④		0.75 (19.0)	0.50 (12.7)	0.46 (11.6)	0.48 (12.2)	—		E50KL599
Nylatron	3.10 in-oz ^④		0.75 (19.0)	1.00 (25.4)	0.90 (22.9)	0.95 (24.1)	—		E50KL537
Large Nylatron	4.50 in-oz ^④	0.5 (12.7) to 3.25 (82.6)	4.00 (102.0)	0.11 (2.8)	0.11 (2.8)	0.19 (4.8)	—		E50KL598
Without roller	1.20 in-oz ^④	0.5 (12.7) to 3.75 (95.2)	—	—	—	—	—		E50KL131
Nylatron	2.50 in-oz ^④	1.63 (41.3) to 3.75 (95.2) ^⑥	1.50 (38.1)	0.29 (7.4)	0.26 (6.6)	0.32 (8.1)	—		E50KL443
Dimensions, see Page V8-T2-85.									

Operators—Fork Lever

Roller Type	Minimum Required Return Torque ^①	Approximate Dimensions in Inches (mm)							Catalog Number
		A Lever Length ^②	B Roller Diameter	C Roller Width	D	E	F	G	
E50KL545									
Fork Lever—Both Rollers on One Side									
 Ball bearing	—	1.50 (38.1)	0.69 (17.5)	0.25 (6.4)	0.08 (2.0)	0.14 (3.6)	—	—	E50KL545
Nylatron	—		0.75 (19.0)	0.32 (8.1)	0.16 (4.1)	0.20 (5.1)	—	—	E50KL204
Metal	—		0.75 (19.0)	0.32 (8.1)	0.16 (4.1)	0.20 (5.1)	—	—	E50KL544
Nylatron	—		0.75 (19.0)	1.00 (25.4)	0.84 (21.3)	0.88 (22.4)	—	—	E50KL543
E50KL542									
Fork Lever—One Roller Outside, One Inside									
 Ball bearing	—	1.50 (38.1)	0.69 (17.5)	0.25 (6.4)	0.08 (2.0)	0.14 (3.6)	0.64 (16.3)	0.70 (17.8)	E50KL542
Nylatron	—		0.75 (19.0)	0.32 (8.1)	0.16 (4.1)	0.20 (5.1)	0.73 (18.5)	0.77 (19.6)	E50KL203
Metal	—		0.75 (19.0)	0.32 (8.1)	0.16 (4.1)	0.20 (5.1)	0.73 (18.5)	0.77 (19.6)	E50KL541
Dimensions, see Page V8-T2-85.									

Notes

- ① **Caution:** When selecting lever, the minimum required return torque of lever should not exceed minimum return force available in operating head as given in operating head specifications.
- ② Length from the operating shaft axis to the roller axis (or to the tip for non-roller operators).
- ③ Maximum length dimension between operating shaft axis to roller axis for comparison. Precision adjustable to lesser dimensions.
- ④ Applies when lever is extended to the maximum dimension.
- ⑤ By reassembling lever, minimum length can be reduced another 0.5 in (12.7 mm).
- ⑥ High-grade stainless steel.

Rod Type Operators

For rotary head switches: E50 Plug-In, E50 6P+, and 10316.

2

Note: Only operators with Nylatron rods or rollers should be used with explosion-proof limit switches.

Operators—Rod Type

Rod Type	Minimum Required Return Torque ^①	Approximate Dimensions in Inches (mm)			Catalog Number
		A Rod Length (Maximum) ^②	B Rod Diameter	C	
Nylon/Metal					
Adjustable Rod					
Nylon	0.40 in-oz ^③	5.50 (140.0)	0.19 (4.8)		E50KL399
Metal	0.92 in-oz ^③		0.12 (3.2)		E50KL202
Metal	2.20 in-oz ^③	8.75 (222.0)	Rod size (square): 0.12 (3.2) x 0.12 (3.2)		E50KL581
Metal/Steel					
Stainless steel	7.00 in-oz ^③	9.00 (229.0)	0.19 (4.8)		E50KL220
Bendable steel	5.00 in-oz ^③	12.00 (305.0)	0.12 (3.2)		E50KL226
Clamps for Adjustable Rods (Rod not included)					
Clamp for ...					
		0.19 (4.8) diameter rods			E50KL35
		0.12 (3.2) diameter rods			E50KL36
		0.25 (6.4) diameter rods			E50KL41
Dimensions, see Page V8-T2-86.					

Operators—Rod Type, continued

Rod Type	Minimum Required Return Torque ^①	Approximate Dimensions in Inches (mm)				Catalog Number
		A Rod Length ^②	B Rod Diameter	C	D	
Nylon/Steel						
Spring Rod						
Nylon	3.50 in-oz	—	—	—	—	E50KL556
Stainless steel	2.80 in-oz	—	—	—	—	E50KL421
Nylon Covered Wire						
Adjustable Wire						
Nylon covered wire	1.50 in-oz ^③	—	—	—	—	E50KL533
Nylatron						
Adjustable Wide Roller Lever						
Nylatron	4.50 in-oz ^③	—	—	—	—	E50KL37
Nylatron						
Nylatron Loop						
Nylatron	0.40 in-oz	6.00 (152.0)	∅: 0.158 (4.0)	—	—	E50KL142
Zinc-Plated Steel						
Eye Bolt						
Zinc-plated steel	0.53 in-oz	150.00 (38.1)	∅: 0.1875 (4.8) Loop ID: 0.375 (9.5)	0.52 (13.1)	0.24 (8.6)	E50KL33

Dimensions, see Page V8-T2-86.

Notes

- ^① **Caution:** When selecting lever, the minimum required return torque of lever should not exceed minimum return force available in operating head as given in operating head specifications.
- ^② Length from the operating shaft axis to tip.
- ^③ Applies when lever is extended to the maximum dimension.

Wobble Type Operators

For E50DW1 and E50DWZ Operator Heads on E50 Plug-In and E50 6P+ Switches.

Note: Only operators with Nylatron rods or rollers should be used with explosion-proof limit switches.

Operators—Wobble Type

	Wobble Type	Catalog Number
E50KW2	Nylon Rod	E50KW2
E50KW3	Stainless Steel Rod	E50KW3
E50KW4	Coil Spring	E50KW4
Dimensions, see Page V8-T2-86.		

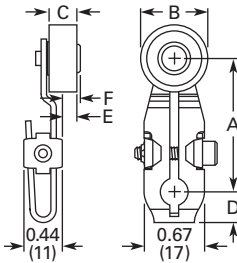
Dimensions**Roller Type Operators****Standard Roller**

Approximate Dimensions in Inches (mm)

Catalog Number	A Lever Length ^①	B Roller Diameter	C Roller Width	D	E	F
E50KL39	0.88 (22.2)	0.75 (19.0)	0.32 (8.1)	0.31 (7.9)	0.20 (5.1)	0.24 (6.1)
E50KL40	1.38 (34.9)	0.75 (19.0)	0.32 (8.1)	0.34 (8.6)	0.13 (3.3)	0.17 (4.3)
E50KL531	1.50 (38.1)	0.69 (17.5)	0.25 (6.4)	0.34 (8.6)	0.05 (1.3)	0.11 (2.8)
E50KL200	1.50 (38.1)	0.75 (19.0)	0.32 (8.1)	0.34 (8.6)	0.13 (3.3)	0.17 (4.3)
E50KL355	1.50 (38.1)	0.75 (19.0)	0.32 (8.1)	0.34 (8.6)	0.13 (3.3)	0.17 (4.3)
E50KL377	1.50 (38.1)	0.75 (19.0)	1.00 (25.4)	0.34 (8.6)	0.83 (21.1)	0.83 (21.1)
E50KL32	1.50 (38.1)	—	—	0.34 (8.6)	—	—
E50KL552	2.00 (50.8)	0.69 (17.5)	0.25 (6.4)	0.34 (8.6)	0.05 (1.3)	0.11 (2.8)
E50KL546	2.00 (50.8)	0.75 (19.0)	0.32 (8.1)	0.34 (8.6)	0.13 (3.3)	0.17 (4.3)
E50KL549	2.00 (50.8)	0.75 (19.0)	0.32 (8.1)	0.34 (8.6)	0.13 (3.3)	0.17 (4.3)
E50KL572	2.00 (50.8)	0.75 (19.0)	1.00 (25.4)	0.34 (8.6)	0.83 (21.1)	0.83 (21.1)
E50KL553	2.50 (63.5)	0.69 (17.5)	0.25 (6.4)	0.34 (8.6)	0.05 (1.3)	0.11 (2.8)
E50KL547	2.50 (63.5)	0.75 (19.0)	0.32 (8.1)	0.34 (8.6)	0.13 (3.3)	0.17 (4.3)
E50KL550	2.50 (63.5)	0.75 (19.0)	0.32 (8.1)	0.34 (8.6)	0.13 (3.3)	0.17 (4.3)
E50KL573	2.50 (63.5)	0.75 (19.0)	1.00 (25.4)	0.34 (8.6)	0.83 (21.1)	0.83 (21.1)
E50KL575	2.50 (63.5)	1.50 (38.1)	0.28 (7.1)	0.34 (8.6)	0.11 (2.8)	0.17 (4.3)
E50KL554	3.00 (76.2)	0.69 (17.5)	0.25 (6.4)	0.34 (8.6)	0.05 (1.3)	0.11 (2.8)
E50KL548	3.00 (76.2)	0.75 (19.0)	0.32 (8.1)	0.34 (8.6)	0.13 (3.3)	0.17 (4.3)
E50KL551	3.00 (76.2)	0.75 (19.0)	0.32 (8.1)	0.34 (8.6)	0.13 (3.3)	0.17 (4.3)
E50KL574	3.00 (76.2)	0.75 (19.0)	1.00 (25.4)	0.34 (8.6)	0.83 (21.1)	0.83 (21.1)
E50KL576	3.00 (76.2)	1.50 (38.1)	0.28 (7.1)	0.34 (8.6)	0.11 (2.8)	0.17 (4.3)

Note

^① Length from the operating shaft axis to the roller axis (or to the tip for non-roller operators).

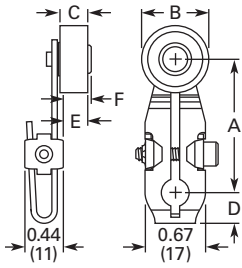

Roller on Reverse Side

Approximate Dimensions in Inches (mm)

Catalog Number	A Lever Length ①	B Roller Diameter	C Roller Width	D	E	F
E50KL580	1.50 (38.1)	0.69 (17.5)	0.25 (6.4)	0.34 (8.6)	0.18 (4.6)	0.24 (6.1)
E50KL310	1.50 (38.1)	0.75 (19.0)	0.32 (8.1)	0.34 (8.6)	0.27 (6.9)	0.31 (7.9)
E50KL579	1.50 (38.1)	0.75 (19.0)	0.32 (8.1)	0.34 (8.6)	0.27 (6.9)	0.31 (7.9)
E50KL536	1.50 (38.1)	1.50 (38.1)	0.28 (7.1)	0.34 (8.6)	0.23 (5.8)	0.31 (7.9)

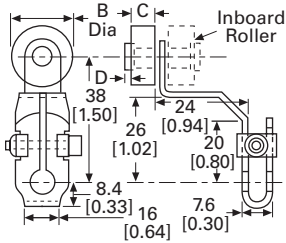

Offset Roller

Approximate Dimensions in mm [in]

Catalog Number	A Lever Length ①	B Roller Diameter	C Roller Width	D
Inboard				
E50KL24	38.1 [1.50]	19.0 [0.75]	8.1 [0.32]	0.8 [0.03]
E50KL25	38.1 [1.50]	19.0 [0.75]	8.1 [0.32]	0.8 [0.03]
E50KL26	38.1 [1.50]	17.5 [0.69]	6.4 [0.25]	1.0 [0.04]
Outboard				
E50KL27	38.1 [1.50]	19.0 [0.75]	8.1 [0.32]	0.8 [0.03]
E50KL28	38.1 [1.50]	19.0 [0.75]	8.1 [0.32]	0.8 [0.03]
E50KL29	38.1 [1.50]	17.5 [0.69]	6.4 [0.25]	1.0 [0.04]
E50KL30	38.1 [1.50]	19.0 [0.75]	25.4 [1.00]	—

Bantam Lever

Approximate Dimensions in mm [in]

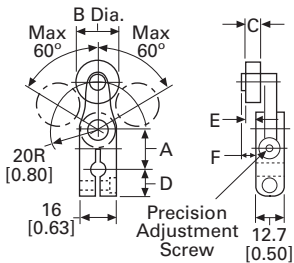
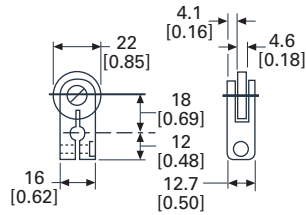

Precision Adjustment

Approximate Dimensions in mm [in]

Catalog Number	A Lever Length ①	B Roller Diameter	C Roller Width	D	E	F
E50KL340	17.5 [0.69]	19.0 [0.75]	8.1 [0.32]	12.2 [0.48]	6.1 [0.24]	7.1 [0.28]
E50KL465	Roller length: 38.1 [1.50] ②	19.0 [0.75]	8.1 [0.32]	12.2 [0.48]	6.1 [0.24]	7.1 [0.28]
E50KL535		17.5 [0.69]	6.4 [0.25]	12.2 [0.48]	4.1 [0.16]	5.6 [0.22]

Notes

- ① Length from the operating shaft axis to the roller axis (or to the tip for non-roller operators).
- ② Maximum length dimension between operating shaft axis to the roller axis for comparison. Precision adjustable to lesser dimensions.

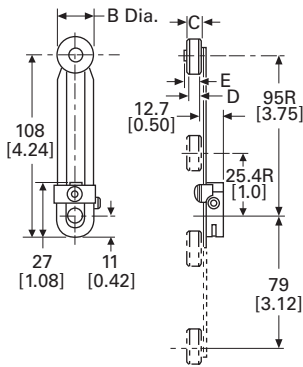

Adjustable Roller

Approximate Dimensions in mm [in]

Catalog Number	A Lever Length ①	B Roller Diameter	C Roller Width	D	E
E50KL539	25.4 [1.0] to 95.2 [3.75] ②	17.5 [0.69]	6.4 [0.25]	5.8 [0.23]	7.6 [0.30]
E50KL201		19.0 [0.75]	8.1 [0.32]	7.4 [0.29]	8.4 [0.33]
E50KL201SPL ③		19.0 [0.75]	8.1 [0.32]	7.4 [0.29]	8.4 [0.33]
E50KL538		19.0 [0.75]	8.1 [0.32]	7.4 [0.29]	8.4 [0.33]
E50KL599		19.0 [0.75]	12.7 [0.50]	11.6 [0.46]	12.2 [0.48]
E50KL537		19.0 [0.75]	25.4 [1.00]	22.9 [0.90]	24.1 [0.95]
E50KL598	12.7 [0.50] to 82.6 [3.25]	102.0 [4.00]	2.8 [0.11]	4.8 [0.19]	24.1 [0.95]
E50KL31	12.7 [0.50] to 95.2 [3.75]	—	—	—	—
E50KL443	41.3 [1.63] to 95.2 [3.75] ②	38.1 [1.50]	7.4 [0.29]	6.6 [0.26]	8.1 [0.32]

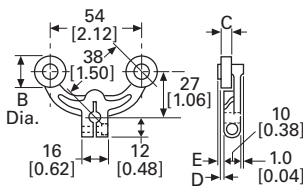

Fork Lever—Both Rollers on One Side

Approximate Dimensions in mm [in]

Catalog Number	A Lever Length ①	B Roller Diameter	C Roller Width	D	E
E50KL545	38.1 [1.50]	17.5 [0.69]	6.4 [0.25]	2.0 [0.08]	3.6 [0.14]
E50KL204	38.1 [1.50]	19.0 [0.75]	8.1 [0.32]	4.1 [0.16]	5.1 [0.20]
E50KL544	38.1 [1.50]	19.0 [0.75]	8.1 [0.32]	4.1 [0.16]	5.1 [0.20]
E50KL543	38.1 [1.50]	19.0 [0.75]	25.4 [1.00]	21.3 [0.84]	22.4 [0.88]

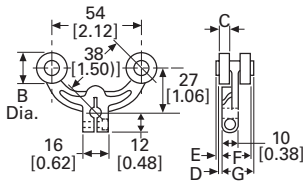

Fork Lever—One Roller Outside, One Inside

Approximate Dimensions in mm [in]

Catalog Number	A Lever Length ①	B Roller Diameter	C Roller Width	D	E	F	G
E50KL542	38.1 [1.50]	17.5 [0.69]	6.4 [0.25]	2.0 [0.08]	3.6 [0.14]	16.3 [0.64]	17.8 [0.70]
E50KL203	38.1 [1.50]	19.0 [0.75]	8.1 [0.32]	4.1 [0.16]	5.1 [0.20]	18.5 [0.73]	19.6 [0.77]
E50KL541	38.1 [1.50]	19.0 [0.75]	8.1 [0.32]	4.1 [0.16]	5.1 [0.20]	18.5 [0.73]	19.6 [0.77]

Rod Type Operators

Approximate Dimensions in Inches or mm [in]

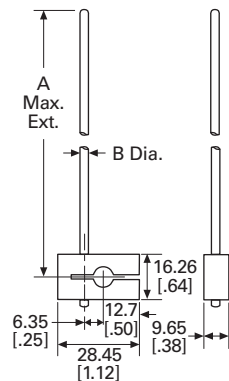

Adjustable Rod

Catalog Number	A Rod Length ①	B Rod Diameter
E50KL399	140.0 [5.50]	4.8 [0.19]
E50KL202		3.2 [0.12]
E50KL581	222.0 [8.75]	Rod size (square): 3.2 [0.12] x 3.2 [0.12]
E50KL220	229.0 [9.00]	4.8 [0.19]
E50KL226	305.0 [12.00]	3.2 [0.12]

Notes

- ① Length from the operating shaft axis to the roller axis (or to the tip for non-roller operators).
- ② By reassembling lever, minimum length can be reduced another 12.7 mm [0.5 in].
- ③ High-grade stainless steel.

2.8

Limit Switches

Operators

2

Rod Type Operators, continued

Approximate Dimensions in Inches or mm [in]

Spring Rod—E50KL556

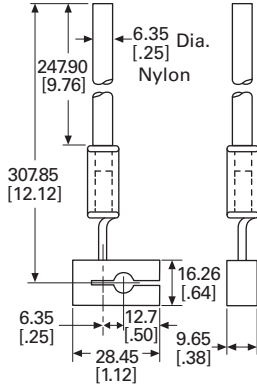

Adjustable Wire

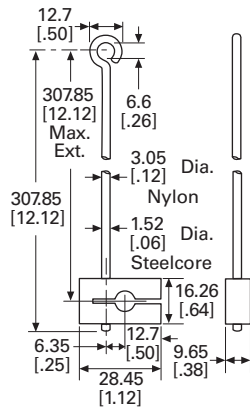

Eye Bolt

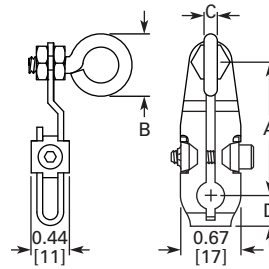

Catalog Number	A Rod Length ②	B Rod Diameter	C Rod Width	D
E50KL33	38.1 [1.50]	4.8 [0.1875] Loop ID: 9.5 [0.375]	13.1 [0.52]	8.6 [0.34]

Spring Rod—E50KL421

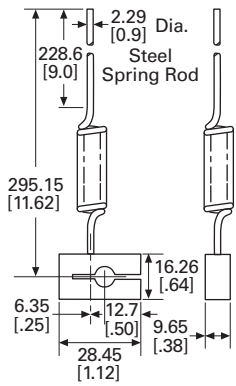

Adjustable Wide Roller Lever

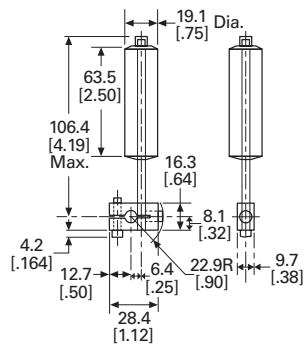

Wobble Type Operators

Nylon Rod

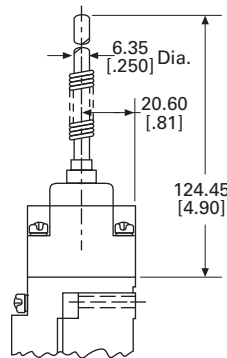

Coil Spring

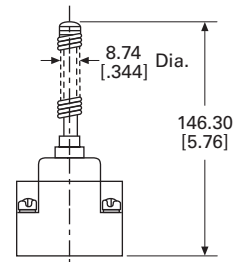

Nylatron Loop—E50KL142

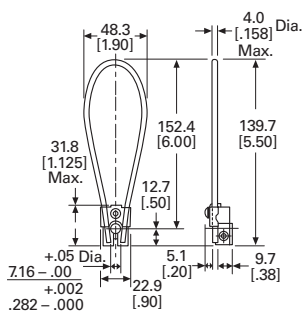

Nylatron Loop—E50KL142

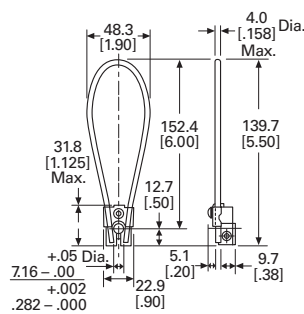

Stainless Steel Rod

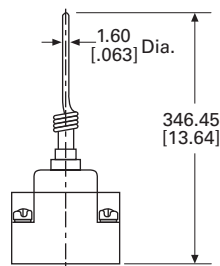

Notes

- ① Applies when lever is extended to the maximum dimension.
- ② Length from the operating shaft axis to tip.

Non Plug-In Switches



Non Plug-In Switches

Product Description

10316 Type L non plug-in limit switches by Eaton's electrical sector are sold as completely assembled devices only, with a wide array of operating head configurations. All switches are single-pole 1NO-1NC.

Features

- Side and top rotary, side and top push or wobble operation
- CW, CCW or CW and CCW operating modes are field convertible
- Double break-make snap action contacts, same polarity each pole
- Captive saddle clamp terminals accept up to #12 wire
- Head can be mounted in any of four discrete positions, intervals of 90°

Contents

Description

Description	Page
Non Plug-In Switches	
Product Selection	V8-T2-88
Technical Data and Specifications	V8-T2-89
Dimensions	V8-T2-89

Standards and Certifications

- UL Listed, E170645
- CSA Certified, 50513



⚠ DANGER

THIS SENSOR IS NOT A SAFETY DEVICE AND IS NOT INTENDED TO BE USED AS A SAFETY DEVICE. This sensor is designed only to detect and read certain data in an electronic manner and perform no use apart from that, specifically no safety-related use. This sensor product does not include self-checking redundant circuitry, and the failure of this sensor product could cause either an energized or de-energized output condition, which could result in death, serious bodily injury, or property damage.

For the most current information on this product, visit our Web site: www.eaton.com

For Customer Service in the U.S. call 1-877-ETN CARE (386-2273), in Canada call 1-800-268-3578.
For Application Assistance in the U.S. and Canada call 1-800-426-9184.

Product Selection

2

Complete Assembled Switches Single-Pole 1NO-1NC

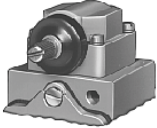
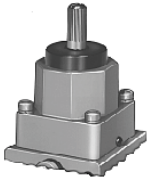
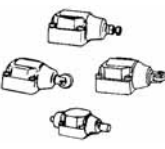
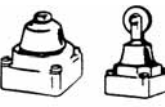
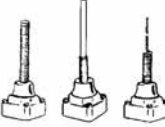
Operating Characteristics	Operating Data—Nominal			Force to Operate Contacts	Minimum Return Force	Catalog Number
	Travel to Operate Contacts	Travel to Reset Contacts	Total Travel			
Side Rotary Operated	Side Rotary Operated ①					
 Standard	10°	4°	50°	3 in-lbs	4.5 in-oz	10316H187
Top Rotary Operated	Top Rotary Operated ①					
 Clockwise	20°	12°	140°	1.1 in-lbs	3 in-oz	10316H700
Counterclockwise	20°	12°	140°	1.1 in-lbs	3 in-oz	10316H701
Side Push Operated	Side Push Operated					
 Adjustable pushbutton	0.07 in (1.8 mm)	0.03 in (0.8 mm)	0.29 in (7.4 mm)	4 lbs	8 oz	10316H621
Vertical roller— 0.44 in (11.2 mm) dia.	0.07 in (1.8 mm)	0.03 in (0.8 mm)	0.29 in (7.4 mm)	4 lbs	8 oz	10316H284
Horizontal roller— 0.44 in (11.2 mm) dia.	0.07 in (1.8 mm)	0.03 in (0.8 mm)	0.29 in (7.4 mm)	4 lbs	8 oz	10316H285
Top Push Operated	Top Push Operated					
 Pushbutton	0.04 in (1.0 mm)	0.02 in (0.5 mm)	0.28 in (7.1 mm)	4 lbs	8 oz	10316H281
Roller—0.44 in (11.2 mm) dia.	0.04 in (1.0 mm)	0.02 in (0.5 mm)	0.28 in (7.1 mm)	4 lbs	8 oz	10316H283
Roller—0.75 in (19.1 mm) dia.	0.04 in (1.0 mm)	0.02 in (0.5 mm)	0.28 in (7.1 mm)	4 lbs	8 oz	10316H577
Wobble Operated	Wobble Operated ②					
 Spring	10°	6°	15°	1 in-lb	2.4 in-oz	10316H299
Nylon rod	10°	6°	15°	2 in-lbs	2.4 in-oz	10316H296
Wire	10°	6°	15°	2 in-lbs	2.4 in-oz	10316H484
Cat whisker	15°	5°	30°	0.63 in-lb	1.7 in-oz	10316H341

Notes

- ① For operating levers, see **Page V8-T2-79**.
- ② For wobble operators, see **Page V8-T2-79**.

Technical Data and Specifications

Non Plug-In Switches

Description	Specification
Contact rating	NEMA A600, R300 double break-make snap action contacts
Electrical life	500,000 operations minimum
Mechanical life	5,000,000 operations minimum at full load
Conduit entrance	0.5 in (12.7 mm) NPT
Material of construction	Zinc die cast
Enclosure rating	NEMA 1, 4, 13
Ambient operating temperature	-20° to 200°F (-29° to 93°C) ①
Approximate shipping weight	2 lbs

Electrical Data—Maximum Contact Ratings per Pole ②

AC Volts	Current, Amperes		Cont. Thermal Ratings	Volts, Amperes		DC Volts	DC Current, Ampere
	Make	Break		Make	Break		
NEMA A600, R300 Rating							
120	60	6	10	7200	720	125	0.22
240	30	3	10	7200	720	250	0.11
480	15	1.5	10	7200	720	250	0.11
600	12	1.2	10	7200	720	250	0.11

Dimensions

Approximate Dimensions in Inches or Inches (mm)

Side Rotary Operated Head with Switch

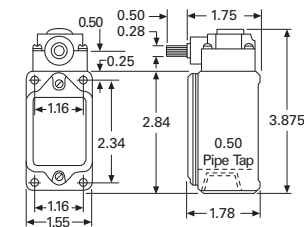

(2) 0.203 Dia. Holes for Front Mtg.
(2) 10-32 Tapped Holes 0.375 Deep for Rear Mtg.

Side Pushbutton, Adjustable

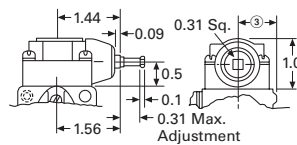

Top Pushbutton

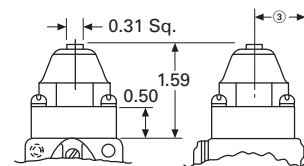

Side Push, Vertical Roller

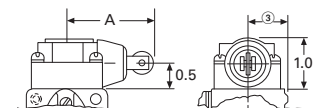

Dimension "A"

With 0.44 (11.2) dia. roller	1.78 (45.2)
With 0.75 (19.1) dia. roller	2.09 (53.1)

Side Push Maintained Contact

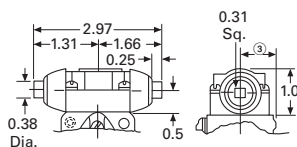

Top Push Roller

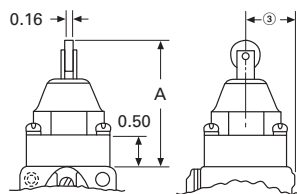

Dimension "A"

With 0.44 (11.2) dia. roller	2.03 (51.6)
With 0.75 (19.1) dia. roller	2.34 (59.4)

Wobble Operators

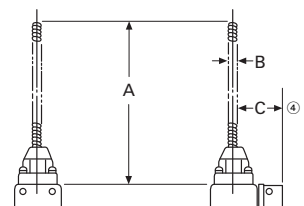

A	B	C
Wobble Spring		
5.44 (138.2)	0.31 (7.9)	0.81 (20.6)
Wire Wobble Stick		
12.5 (317.5)	0.08 (2.0)	0.81 (20.6)
Nylon Wobble Stick		
4.5 (114.3)	0.25 (6.4)	0.81 (20.6)

Notes

- ① Ranges below 32°F (0°C) are based on absence of freezing moisture or water.
- ② Contacts must be same polarity when both circuits are used.
- ③ Dimension from centerline of head to mounting surface is 0.78 in (20 mm).
- ④ Center to mounting surface.

Hazardous Location Limit Switches

2



Hazardous Location Limit Switches

Product Description

Type LX, CX and CBX limit switches by Eaton's electrical sector are designed for extreme environmental service in NEMA 7–9 locations where the danger of an internal or external explosion of flammable gases, vapors, metal alloy or grain dust exists. Type CB provides excellent corrosion resistant properties in NEMA 4X applications. Markets served include mining, grain storage, forest products, petrochemical, pharmaceutical and waste and sewage management.

Features

- Sealed and unsealed versions available
- One-way gasket on sealed version keeps liquids out, yet allows a harmless release of gases in the event of an internal explosion
- Silicon bronze housing provides excellent corrosion resistant properties in extreme NEMA 4X applications
- Temperature buildup on limit switch surface is dissipated by housing design and materials used
- Utilizes the operating heads and internal switch mechanisms of the 10316 L non plug-in line

Contents

Description

	<i>Page</i>
Hazardous Location Limit Switches	
Product Selection	V8-T2-91
Technical Data and Specifications	V8-T2-92
Dimensions	V8-T2-89

Standards and Certifications

- UL Listed, E170645, E183975
- UL tested to Canadian safety standards



NEMA Ratings Comparison

Switch Type	LX	CX	CBX	CB ①
NEMA 1, 4, 13	—	✓	✓	✓
NEMA 4X	—	—	✓	✓
NEMA 7 Division I, Class I, BCD	✓	✓	✓	—
NEMA 9 Division I, Class II, EFG	✓	✓	✓	—

Note

① Not rated for explosive locations.



DANGER
THIS SENSOR IS NOT A SAFETY DEVICE AND IS NOT INTENDED TO BE USED AS A SAFETY DEVICE. This sensor is designed only to detect and read certain data in an electronic manner and perform no use apart from that, specifically no safety-related use. This sensor product does not include self-checking redundant circuitry, and the failure of this sensor product could cause either an energized or de-energized output condition, which could result in death, serious bodily injury, or property damage.





For the most current information on this product, visit our Web site: www.eaton.com

For Customer Service in the U.S. call 1-877-ETN CARE (386-2273), in Canada call 1-800-268-3578. For Application Assistance in the U.S. and Canada call 1-800-426-9184.

Product Selection

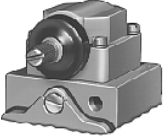
Complete Assembled Switches with Spring Return Heads ^①

Operating Data—Nominal

Head Type	Travel to Operate Contacts	Travel to Reset Contacts	Total Travel	Force to Operate Contacts	Minimum Return Force	Body Type	Contacts	Catalog Number	
Side Rotary Operated ^② 	Standard, 10° Pre-Travel ^③								
	10°	4°	50°	3.0 in-lbs	4.5 in-oz	Type LX	1NO-1NC ^④	10316H1002	
							2NO	10316H1039	
							1NO and 1NC ^④	10316H1049	
							2NC	10316H1059	
						Type CX	1NO-1NC ^④	10316H2200	
							1NO and 1NC ^④	10316H2176	
							2NC	10316H2178	
						Type CB	1NO-1NC ^④	10316H2149	
							2NC	10316H2140	
						Type CBX	1NO-1NC ^④	10316H2168	
							2NC	10316H2159	
		Narrow Differential 5° Pre-Travel ^③							
		5°	2°	50°	6.0 in-lbs	4.5 in-oz	Type LX	1NO-1NC ^④	10316H1146
							Type CX	1NO-1NC ^④	10316H2197
	Neutral Position, 18° Pre-Travel ^⑤								
	18°	6°	50°	1.8 in-lbs	2.5 in-oz	Type LX	2NO	10316H1071	
							2NC	10316H1072	
						Type CX	2NO	10316H2179	
						Type CBX	2NC	10316H2160	
Side Push Operated    	Pushbutton								
	0.07 in (1.8 mm)	0.03 in (0.76 mm)	0.29 in (7.4 mm)	4 lbs	8 oz	Type LX	1NO and 1NC ^④	10316H1213	
	Adjustable Pushbutton								
	0.07 in (1.8 mm)	0.03 in (0.76 mm)	0.29 in (7.4 mm)	4 lbs	8 oz	Type LX	1NO-1NC ^④	10316H1192	
	Vertical Roller, 0.44 in (11.2 mm) Diameter								
	0.07 in (1.8 mm)	0.03 in (0.76 mm)	0.29 in (7.4 mm)	4 lbs	8 oz	Type LX	1NO-1NC ^④	10316H1007	
	Vertical Roller, 0.75 in (19.1 mm) Diameter								
0.07 in (1.8 mm)	0.03 in (0.76 mm)	0.29 in (7.4 mm)	4 lbs	8 oz	Type LX	1NO-1NC ^④	10316H1194		

Notes

- ① Contact Eaton's Sensor Applications Engineering at 1-800-426-9184 for replacement contact blocks.
- ② For operating levers, see **Page V8-T2-79**. Only levers with Nylatron rods or rollers should be used with explosion-proof limit switches.
- ③ Field convertible to clockwise only or counterclockwise only operation.
- ④ 1NO-1NC contacts must be same polarity when both circuits are used—1NO and 1NC contacts have isolated poles and may be used on opposite polarity.
- ⑤ Neutral position switches operate one circuit in each direction.

Complete Assembled Switches with Spring Return Heads, continued ^①

Operating Data—Nominal

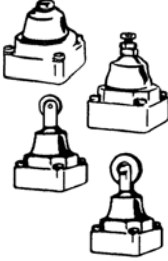
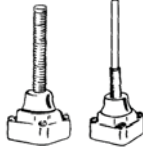
Head Type	Travel to Operate Contacts	Travel to Reset Contacts	Total Travel	Force to Operate Contacts	Minimum Return Force	Body Type	Contacts	Catalog Number
Top Push Operated 	Pushbutton							
	0.04 in (1 mm)	0.02 in (0.5 mm)	0.28 in (7.1 mm)	4 lbs	8 oz	Type LX	1NO-1NC ^②	10316H1004
						Type CX	1NO and 1NC ^②	10316H2188
	Adjustable Pushbutton							
	0.04 in (1 mm)	0.02 in (0.5 mm)	0.28 in (7.1 mm)	4 lbs	8 oz	Type LX	1NO-1NC ^②	10316H1191
							1NO and 1NC ^②	10316H1212
	Roller, 0.44 in (11.2 mm) Diameter							
	0.04 in (1 mm)	0.02 in (0.5 mm)	0.28 in (7.1 mm)	4 lbs	8 oz	Type LX	1NO-1NC ^②	10316H1006
						Type CBX	1NO-1NC ^②	10316H2170
	Roller, 0.75 in (19.1 mm) Diameter							
0.04 in (1 mm)	0.02 in (0.5 mm)	0.28 in (7.1 mm)	4 lbs	8 oz	Type LX	1NO-1NC ^②	10316H1193	
Wobble Operated 	Spring							
	10° ^③	6°	15°	1 in-lb	2.4 in-oz	Type LX	1NO-1NC ^②	10316H1237
	Nylon Rod							
	10° ^③	6°	15°	2 in-lbs	5.6 in-oz	Type LX	1NO-1NC ^②	10316H1009

Technical Data and Specifications

Hazardous Location Limit Switches

Description	Specification
Material of construction	
LX, CX	Cast aluminum die cast
CB, CBX	Silicon bronze
Conduit entrance	
LX	1/2 in pipe tap
CB, CBX, CX	3/4 in pipe tap
Mounting	Surface mount
Enclosure rating	
LX, CX, CBX	NEMA 7 Div. 1, Class I BCD; NEMA 9 Div. 1, Class II, EFG ^④
CB, CBX	NEMA 1, 4, 4X, 13 ^④
CX	NEMA 1, 4, 13 ^④
Ambient operating temperature	-20° to 200°F (-29° to 93°C) ^⑤
Approximate shipping weight	
LX	2 lbs
CX	2.5 lbs
CB, CBX	6 lbs

Notes

- ① Contact Eaton's Sensor Applications Engineering at 1-800-426-9184 for replacement contact blocks.
- ② 1NO-1NC contacts must be same polarity when both circuits are used—1NO and 1NC contacts have isolated poles and may be used on opposite polarity.
- ③ Travel with force applied at one-in (25.4 mm) radius. Applied at end of operator, travel is approximately 14.
- ④ A conduit seal-off kit is required for these switches
- ⑤ Ranges below 32°F (0°C) are based on absence of freezing moisture or water.

Electrical Data—Maximum Contact Ratings, per Pole

AC Volts	Current, Amperes		Cont. ①	Volt Amperes		DC Volts	DC Current, Ampere
	Make	Break		Make	Break		
1NO-1NC Switches							
NEMA A600, R300 rating							
120	60	6	10	7200	720	125	0.2
240	30	3	10	7200	720	250	0.1
480	15	1.5	10	7200	720	250	0.1
600	12	1.2	10	7200	720	250	0.1
All Other Switches, B600							
120	30	3	5	3600	360	120	0.1
240	15	1.5	5	3600	360	240	0.05
480	7.5	0.75	5	3600	360	240	0.05
600	6	0.60	5	3600	360	240	0.05

Dimensions

Approximate Dimensions in Inches or Inches (mm)

Type LX Switch with Side Rotary Head

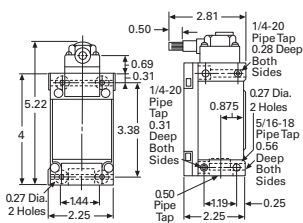

Side Pushbutton Head

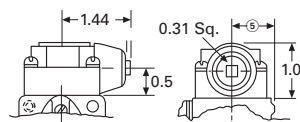

Top Pushbutton Head

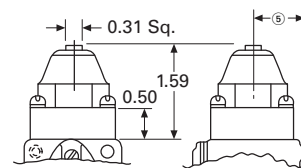

Side Push, Vertical Roller Head

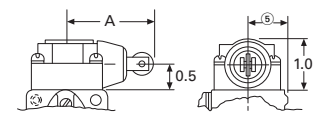

Dimension "A"

With 0.44 (11.2) dia. roller	1.78 (45.2)
With 0.75 (19.1) dia. roller	2.09 (53.1)

Type CX, CB and CBX Switches with Side Rotary Head

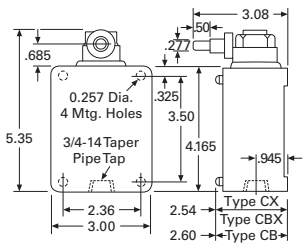

Adjustable Top Pushbutton Head

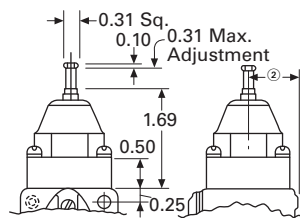

Wobble Operators

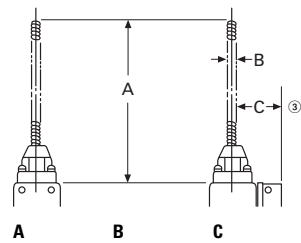

Notes

- ① 1NO-1NC contacts must be same polarity when both circuits are used—1NO and 1NC contacts have isolated poles and may be used on opposite polarities.
- ② Dimension from centerline of head to mounting surface is 0.78 in (20 mm).
- ③ Center to mounting surface.

Adjustable Side Pushbutton Head

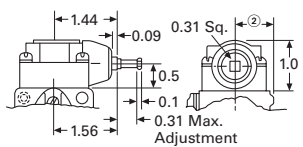

Top Push Roller Head

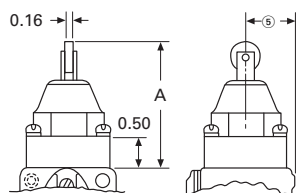

Dimension "A"

With 0.44 (11.2) dia. roller	2.03 (51.6)
With 0.75 (19.1) dia. roller	2.34 (59.4)

Wobble Spring

5.44 (138.2)	0.31 (7.9)	0.94 (23.9)
--------------	------------	-------------

Nylon Red

4.5 (114.3)	0.25 (6.4)	0.94 (23.9)
-------------	------------	-------------

Special Purpose Limit Switches

2



Special Purpose Limit Switches

Product Description

Special Purpose (Type F), Rotating Shaft (Type J), Pneumatic Time Delay (Type LP) and Precision and Cabinet Door Interlock (Type PS) Limit Switches from Eaton's electrical sector serve a variety of special purpose industrial applications for MRO and User Replacement requirements.

Features

- UL Listed
- CSA Certified (PS and J only)

Contents

Description

	<i>Page</i>
Special Purpose Limit Switches	
Product Selection	
Roller Lever Switches	V8-T2-95
Rotating Shaft Switches	V8-T2-95
Pneumatic Time Delay Switches	V8-T2-96
Precision Switches	V8-T2-96
Technical Data and Specifications	V8-T2-97
Dimensions	V8-T2-98

Standards and Certifications

Type J

- UL Listed, E170645
- CSA Certified, 50513



Type LP

- UL Listed, E170645



Type PS

- UL Listed, E170645
- CSA Certified, 50513



THIS SENSOR IS NOT A SAFETY DEVICE AND IS NOT INTENDED TO BE USED AS A SAFETY DEVICE. This sensor is designed only to detect and read certain data in an electronic manner and perform no use apart from that, specifically no safety-related use. This sensor product does not include self-checking redundant circuitry, and the failure of this sensor product could cause either an energized or de-energized output condition, which could result in death, serious bodily injury, or property damage.

For the most current information on this product, visit our Web site: www.eaton.com

For Customer Service in the U.S. call 1-877-ETN CARE (386-2273), in Canada call 1-800-268-3578. For Application Assistance in the U.S. and Canada call 1-800-426-9184.

Product Selection

Roller Lever Switches

Roller Lever



Type F Switches ^①

Operator	Circuit	Travel to Operate Contacts	Travel to Reset Contacts	Total Travel	Over-Travel	Catalog Number
Roller lever (CW and CCW operation, spring return)	1NO-1NC	40°	35°	65°	25°	10316H18
	2NO-2NC	17°	6°	60°	43°	10316H320

Rotating Shaft Switches

Type J

Rotating Shaft Limit Switches allow the shaft to be rotated a preset number of revolutions (adjustable from 1/2 to 100 with an accuracy of 1/20 of a turn) before the contacts will switch. A second set of

contacts will trip when reaching a preset limit in the opposite direction. These switches are typically used in crane and hoist applications to provide end of travel stops for the hook assembly.

Rotating Shaft



Type J Switches

Shaft to Cam Ratio	Max. Turns to Trip Contacts	Min. Turns to Trip Contacts	Over-Travel Before Resetting Contacts	Reversal After Tripping to Reset Contacts	Circuit ^②	Enclosure Rating	Catalog Number
103:1	100 input shaft turns	1/2 input shaft turns	103 input shaft turns max.	1/8 input shaft turns min.	2NC	NEMA 1	10316H50
					2NO-2NC ^③	NEMA 4	10316H54 ^③

Notes

- ① Replacement operator head is available with part number **86-862-22**.
Replacement roller lever is available with part number **24-1712**.
Replacement key pin and washer for roller is available with part number **16-906**.
- ② For replacement NO contacts, order **17-1403**; NC contacts, order **17-702**.
- ③ 10316H54 has factory set circuits, but is easily convertible to any of three circuits (2NO-2NC, 4NO or 4NC). Full instructions enclosed with every switch.

Pneumatic Time Delay Switches

Pneumatic Time Delay

Type LP Switches



Operator	Total Travel	Pre-Travel	Circuit	Timed Contacts	Direction of Rotation ^②	Catalog Number
Side rotary (Spring return to center) ^①	50°	10°	1NO-1NC	ON delay	CW	10316H1580
					CW and CCW	10316H1600
				OFF delay	CW	10316H1610
					CW and CCW	10316H1630

Precision Switches

Cabinet Door Interlock

Type PS Switches



Operator	Circuits— SPDT 1NO-1NC Catalog Number	Circuits— DPDT 2NO-2NC Catalog Number	Operator Only Catalog Number
Precision Switch Devices			
Precision switch only	10316H89	10316H2000	—
Pushbutton with oiltight plunger	—	10316H2006	—
Roller with oiltight plunger perpendicular to mounting holes	—	10316H2012	—
Roller with oiltight plunger in line with mounting holes	10316H110	—	—
6 in lever with top and right-hand mounting bracket	10316H113	—	10316H143
6 in lever with top and left-hand mounting bracket	—	—	10316H144
Roller lever with top and right-hand mounting bracket	10316H119	—	10316H145
Roller lever with top and left-hand mounting bracket	10316H122	—	10316H146
One way roller lever with top and right-hand mounting bracket	—	—	10316H147
One way roller lever with top and left-hand mounting bracket	—	—	10316H148
Cabinet Door Interlocks			
Precision switch only	10316H828	10316H829A	—
Cabinet door interlock operator with one precision switch and with red (defeated ^③) indicator	10316H1028	10316H2042	10316H150
Cabinet door interlock operator with two each of listed precision switches and with red (defeated ^③) indicator	10316H1029	—	—

Notes

- ① Requires an operating lever, see **Page V8-T2-79**.
- ② Field convertible.
- ③ The plunger exposes a red band when pulled out to indicate that interlock is defeated.

Technical Data and Specifications

Special Purpose Limit Switches

Description	Specification
Roller Lever Switches – Type F	
Enclosure rating	NEMA 4
Operating temperature	0° to 180°F (–18° to 82°C)
Conduit entrance	0.5 in NPT
Shipping weight	4.0 lbs
Rotating Shaft Switches – Type J	
Shipping weight	
NEMA 1 models	5.5 lbs
NEMA 4 models	13 lbs
Pneumatic Time Delay Switches – Type LP	
Timing range	0.05 to 60 seconds
ON delay function	Timing begins when lever is actuated and held
OFF delay function	Timing begins when lever is released
Repeat accuracy ^①	With 15 second or higher interval between timing periods: ±10% of setting maximum With less than 15 second interval between timing periods: ±25% of setting maximum
Operating frequency	250 operations per minute maximum
Enclosure rating	NEMA 4, 13
Ambient operating temperature	32° to 150°F (0° to 65°C)
Conduit entrance	0.5 in NPT
Shipping weight	2 lbs

Type F—Maximum Ampere Ratings

Circuit	State	AC Volts				DC Volts		
		120	240	480	600	120	240	600
1NO-1NC	Make	60	30	20	15	—	—	—
	Break	6	3	1.5	1.2	2.2	1.1	0.40
2NO-2NC	Make	40	20	10	8	—	—	—
	Break	15	10	6	5	0.5	0.2	0.02

Type J—Maximum Ampere Ratings

State	AC Volts				DC Volts		
	120	240	480	600	120	240	600
Make	60	30	15	12	2.2	1.1	—
Break	6	3	1.5	1.2	2.2	1.1	—
Continuous ^①	10	10	10	10	10	10	—

Note

^① To maintain operating accuracy during the timing cycle, the switch lever must be faster than the timed setting.

2.11

Limit Switches

Special Purpose Limit Switches

2

Type LP— Electrical Data, Maximum Contact Ratings/Pole

AC Volts	Current, Amperes		Cont. ①	Volt Amperes		DC Volts	DC Current Amperes
	Make	Break		Make	Break		
All Switches 1NO-1NC							
NEMA A600, R300 Rating							
120	60	6	10	7200	720	120	0.2
240	30	3	10	7200	720	240	0.1
480	15	1.5	10	7200	720	240	0.1
600	12	1.2	10	7200	720	240	0.1

Type PS—Maximum Ampere Ratings

Type	State	AC Volts				DC Volts Double Throw		
		120	240	480	600	120	240	600
Heavy-Duty 1/2 hp, 250 Vac Maximum								
Single-pole	Make	40	20	10	8	2.0	0.5	0.1
	Break	15	10	6	5	0.5	0.2	0.02
Double-pole	Make	30	15	8	6	0.5	0.2	0.2
	Break	3	1.5	1	0.8	0.2	0.1	—

Dimensions

Approximate Dimensions in Inches (mm)

Roller Lever Switches

Type F

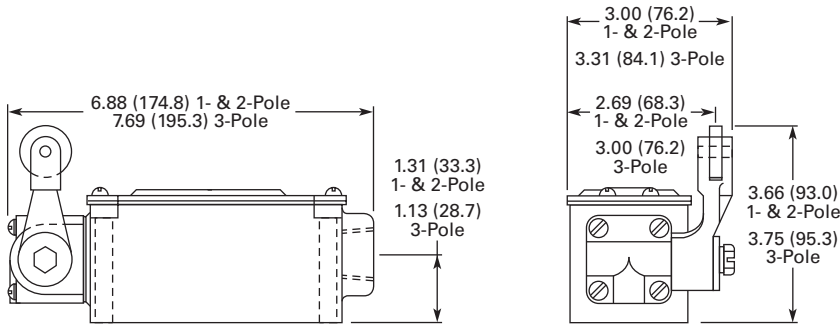

Note

① Thermal rating. Valid only if switch does not have to make or break.

Approximate Dimensions in Inches only

Rotating Shaft Switches

Type J—NEMA 1 Models

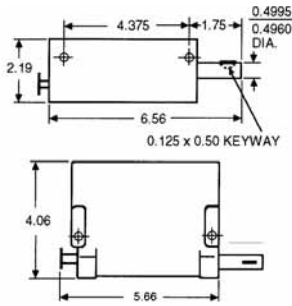

Type J—NEMA 4 Models

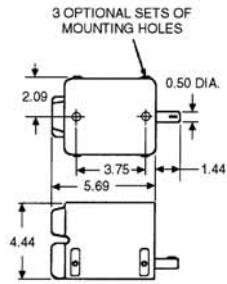

Pneumatic Time Delay Switches

Type LP

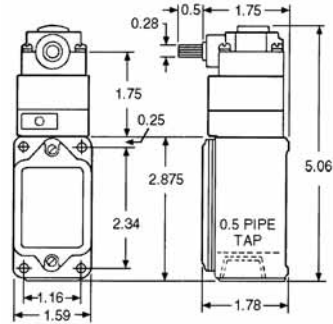

Precision Switches

Type PS

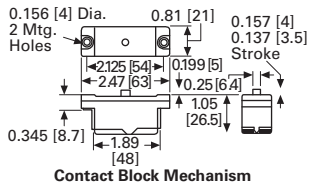

Contact Block Mechanism

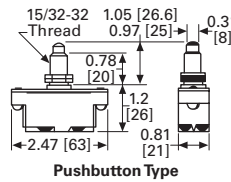

Pushbutton Type

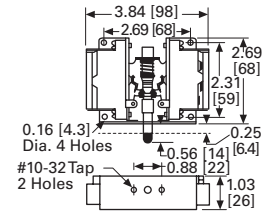

Cabinet Door Type Two Contact Blocks

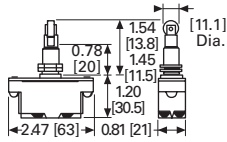

Push Roller Type

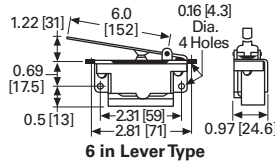

6 in Lever Type

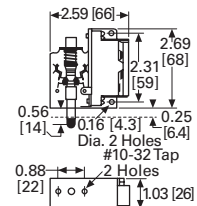

Cabinet Door Type One Contact Block

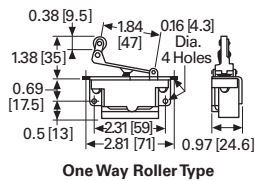

One Way Roller Type

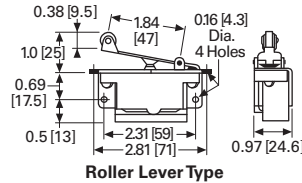

Roller Lever Type