

DC disconnects for
solar photovoltaic installations

Connecting the
power of the sun

EATON

Powering Business Worldwide



Solar energy is heating up

Interest in renewable energy sources has never been greater, and the fastest growing of these new green technologies is the use of photovoltaic (PV) panels (modules) to generate power from the sun. PV modules directly convert the sun's light into electricity, providing power during daylight hours. PV systems are being installed on virtually every type of building, resulting in a growing need for products to meet the requirements of these systems.

Switching 600 Vdc

When photovoltaic panels convert the sun's energy into electricity, the power generated is direct current (DC). Typically, the systems are designed with DC system voltages in the 400–600 V range. This is much higher voltage than typically found in building systems. The higher voltage, when combined with the lack of a current sine wave with zero crossings, creates a number of challenges in wiring, particularly when switching circuits on and off.

DC circuits consist of two wires—a positive and a negative. In most PV systems, one of these wires is grounded (like a neutral in an AC system). Which of the two wires is grounded is specified by the solar panel manufacturer. The more common application is a negative ground, and the location of this bond is usually found at the inverter. Per the National Electrical Code® (NEC®) Section 690.5(A), only the current-carrying ungrounded conductor should be switched. Thus, in a negative-grounded system, only the positive wire is switched.

Unlike AC systems that possess a current sine wave with zero crossings, the interruption of higher voltage DC circuits requires an increased air gap to safely and quickly interrupt and break the arc. The increased gap is accomplished by wiring multiple poles of a single switch in series for safe arc interruption. All switch manufacturers require the use of multiple poles at 600 Vdc to maintain the UL® listing. For this reason, a switch should only be used to switch one circuit. The UL listing of these products does not permit multiple circuits to be switched by one switch. Eaton's new offering of PV switches have multiple poles factory-wired, and they are approved for NEC Article 690 applications right from the box. Other manufacturers require the contractor to add jumpers to a two- or three-pole switch, add a neutral, and add labels to meet this requirement. For fusible switches, the new Eaton PV switch requires only one fuse per switch—saving the customer at least one fuse on each switch.

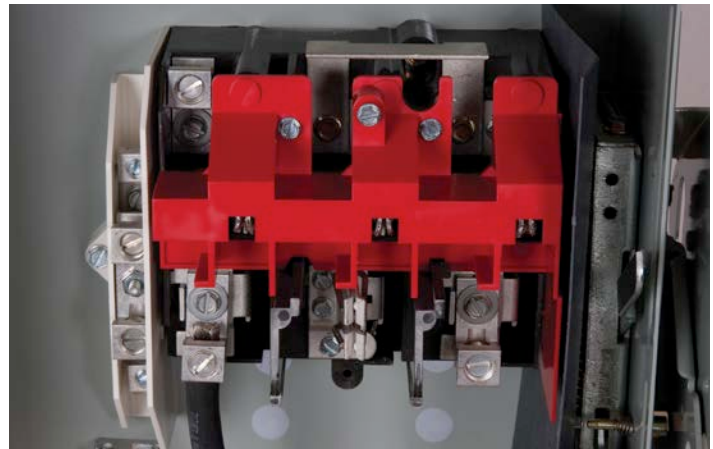
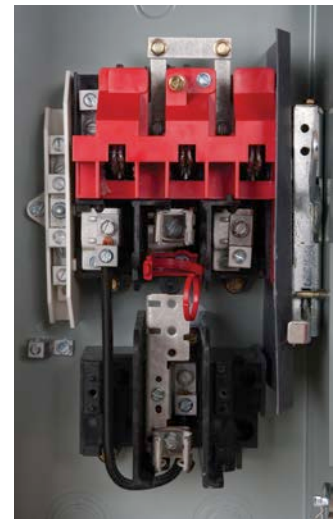

Eaton's solar disconnect

Eaton is proud to offer a new line of solar disconnects that provide the best solution for switching solar PV circuits. This exciting new offering is the first UL 98 listed switch that is labeled as "suitable for NEC Article 690 photovoltaic applications per UL 1741 requirements."

Features include:

- Marked as suitable for NEC 690 PV applications up to 600 Vdc
- UL 98 listed
- All switches are single-pole and suitable for switching one circuit
- Clear polycarbonate deadfront to guard against accidental contact with live parts
- NEC 690.17-compliant labeling warning that the switch terminals may be energized in the open position
- NEC 690.14.(C) 2 required "PV System Disconnect" label included
- Isolated ground terminals (neutral) for grounded conductors
- Ground lug for equipment grounding conductor
- NEMA® 3R, 12 and 4X stainless enclosures
- Fusible and non-fusible configurations—Class R fuse clips standard
- Fuse clips are located on the center pole to ensure that both fuse clips are de-energized—meets NEC Article 690.16, which requires isolation of the fuse from all potential supply sources
- Available for Flex Center modifications (windows, pilot lights, 316 grade stainless, and so on)

Non-fusible 600 Vdc

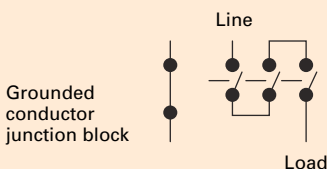
Wiring diagram	Ampere rating	NEMA 3R	NEMA 12	NEMA 4X	Lug capacity main and neutral (isolated ground) ①	Ground lug
 <p>Grounded conductor junction block</p>	30	DH161URKN	DH161UDKN	DH161UWKN	#2 – #14 Cu/Al	#4 – #14 Cu/Al
	60	DH162URKN	DH162UDKN	DH162UWKN	#2 – #14 Cu/Al	#4 – #14 Cu/Al
	100	DH163URKN	DH163UDKN	DH163UWKN	1/0 – #14 Cu/Al	#4 – #14 Cu/Al
	200	DH164URKN	DH164UDKN	DH164UWKN	300 kcmil—#6 Cu/Al ②	#2 – #14 Cu/Al
	400	DH165URKN	DH165UDKN	DH165UWKN	(1) 750 kcmil—1/0 or (2) 300 kcmil—1/0 Cu/Al	250 kcmil—#6 Cu/Al
	600	DH166URKN	DH166UDKN	DH166UWKN	(1) 750 kcmil—1/0 and (1) 600 kcmil—#2 Cu/Al	250 kcmil—#6 Cu/Al

① UL 98 limits the conductor current sizing to 75 °C. 90 °C wire may be terminated per Article 110.14(C); however, the maximum current capacity is limited to NEC Table 310.16, 75 °C column.

② NEMA 3R has 250 kcmil—#6 Cu/Al maximum lug capacity. NEMA 12 and 4X have 300 kcmil—#6 Cu/Al.

Fusible 600 Vdc (Class R fuse clips—one fuse required per switch)

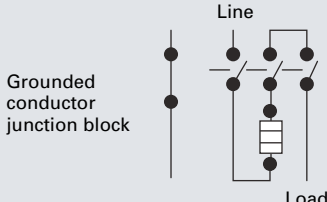
Wiring diagram	Ampere rating	NEMA 3R	NEMA 12	NEMA 4X	Lug capacity main and neutral (isolated ground) ①	Ground lug
 <p>Grounded conductor junction block</p>	30	DH161NRK	DH161NDK	DH161NWK	#2 – #14 Cu/Al	#4 – #14 Cu/Al
	60	DH162NRK	DH162NDK	DH162NWK	#2 – #14 Cu/Al	#4 – #14 Cu/Al
	100	DH163NRK	DH163NDK	DH163NWK	1/0 – #14 Cu/Al	#4 – #14 Cu/Al
	200	DH164NRK	DH164NDK	DH164NWK	300 kcmil—#6 Cu/Al ②	#2 – #14 Cu/Al
	400	DH165NRK	DH165NDK	DH165NWK	(1) 750 kcmil—1/0 or (2) 300 kcmil—1/0 Cu/Al	250 kcmil—#6 Cu/Al
	600	DH166NRK	DH166NDK	DH166NWK	(1) 750 kcmil—1/0 and (1) 600 kcmil—#2 Cu/Al	250 kcmil—#6 Cu/Al

① UL 98 limits the conductor current sizing to 75 °C. 90 °C wire may be terminated per Article 110.14(C); however, the maximum current capacity is limited to NEC Table 310.16, 75 °C column.

② NEMA 3R has 250 kcmil—#6 Cu/Al maximum lug capacity. NEMA 12 and 4X have 300 kcmil—#6 Cu/Al.

600 Vdc solar switches features and benefits

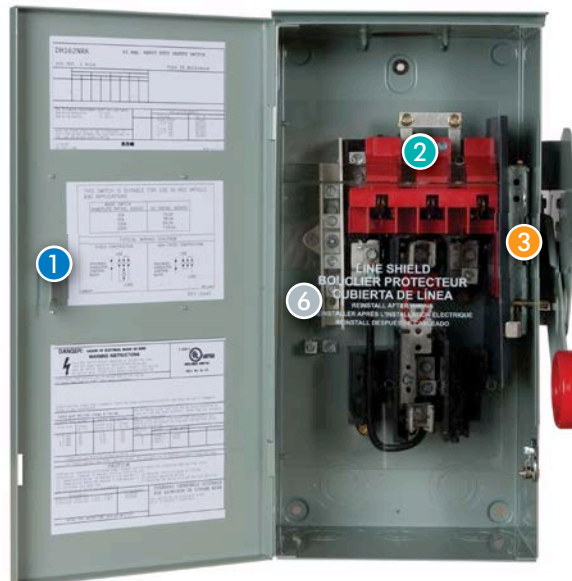

- ① NEC required labeling
- ② Factory-installed jumpers
- ③ Standard K-Switch mechanism
- ④ Clear deadfront shield
Covering all potentially live parts
- ⑤ Fused center pole
Isolates fuse clips from potential back feed—only one fuse required per switch
- ⑥ Factory installed
Isolated ground and equipment ground lug

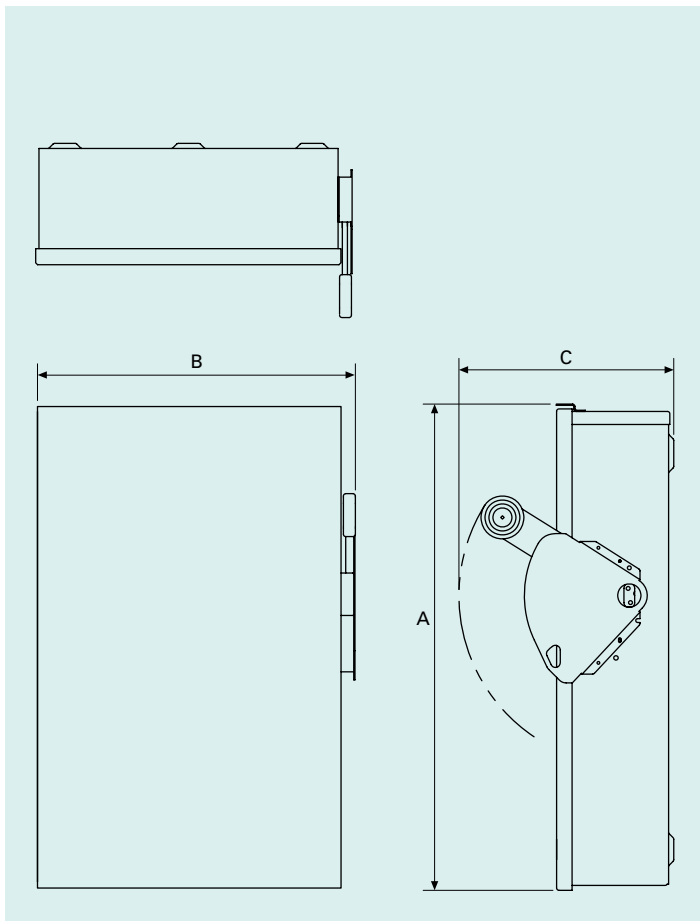

Type 3R solar switch dimensions ❶

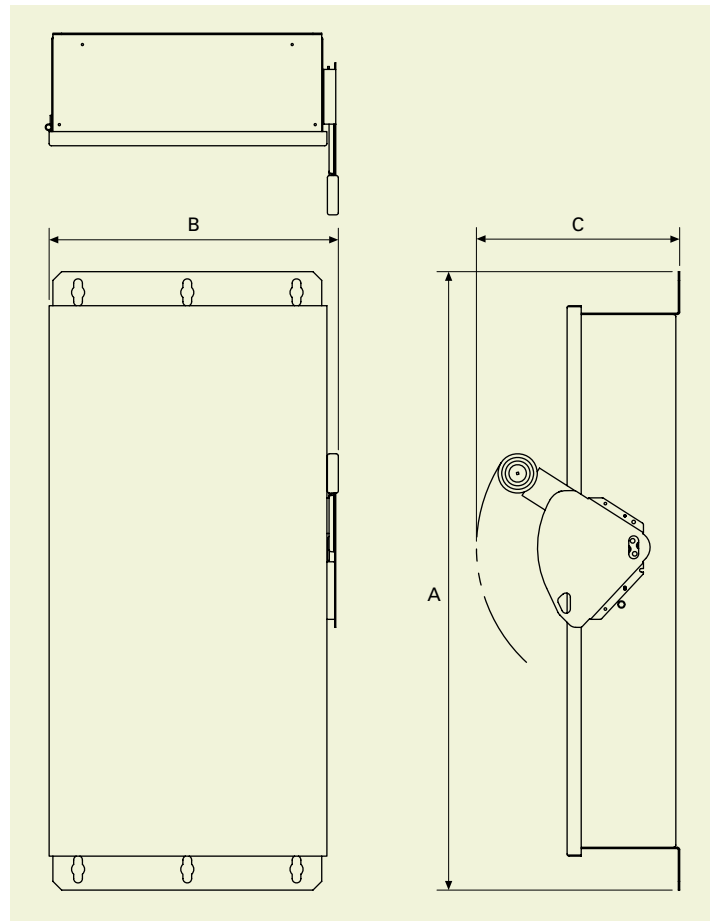

Type 12-3R and 4X solar switch dimensions

Type 3R solar switch dimensions

Amperes	A	B	C	Main lug capacity ❶	Ground lug capacity
30	16.35	8.87	9.89	#2 AWG – #14 AWG Cu/Al	#4 AWG – #14 AWG Cu/Al
60	16.35	8.87	9.89	#2 AWG – #14 AWG Cu/Al	#4 AWG – #14 AWG Cu/Al
100	22.15	11.84	9.89	1/0 AWG – #14 AWG Cu/Al	#4 AWG – #14 AWG Cu/Al
200	28.27	16.66	11.26	250 kcmil – #6 AWG Cu/Al	#2 AWG – #14 AWG Cu/Al
400	45.00	24.12	12.39	(1) 750 kcmil—1/0 or (2) 300 kcmil—1/0 Cu/Al	250 kcmil—#6 AWG Cu/Al
600	52.50	25.12	14.07	(1) 750 kcmil—1/0 and (1) 600 kcmil—#2 AWG Cu/Al	250 kcmil—#6 AWG Cu/Al

❶ UL 98 limits the conductor current sizing to 75 °C. 90 °C wire may be terminated per Article 110.14(C); however, the maximum current capacity is limited to NEC Table 310.16, 75 °C column.

Type 12, 3R and 4X solar switch dimensions

Amperes	A	B	C	Main lug capacity ❶	Ground lug capacity
30 non-fusible	14.14	8.76	10.22	#2 AWG – #14 AWG Cu/Al	#4 AWG – #14 AWG Cu/Al
30 fusible	19.08	8.76	10.22	#2 AWG – #14 AWG Cu/Al	#4 AWG – #14 AWG Cu/Al
60 non-fusible	14.14	8.76	10.22	#2 AWG – #14 AWG Cu/Al	#4 AWG – #14 AWG Cu/Al
60 fusible	19.08	8.76	10.22	#2 AWG – #14 AWG Cu/Al	#4 AWG – #14 AWG Cu/Al
100	24.95	11.79	10.22	1/0 AWG – #14 AWG Cu/Al	#4 AWG – #14 AWG Cu/Al
200	35.38	16.95	11.63	300 kcmil – #6 AWG Cu/Al	#2 AWG – #14 AWG Cu/Al
400	57.47	24.12	12.43	(1) 750 kcmil—1/0 or (2) 300 kcmil—1/0 Cu/Al	250 kcmil—#6 AWG Cu/Al
600	63.00	26.34	14.25	(1) 750 kcmil—1/0 and (1) 600 kcmil—#2 AWG Cu/Al	250 kcmil—#6 AWG Cu/Al

❶ UL 98 limits the conductor current sizing to 75 °C. 90 °C wire may be terminated per Article 110.14(C); however, the maximum current capacity is limited to NEC Table 310.16, 75 °C column.

Eaton is dedicated to ensuring that reliable, efficient and safe power is available when it's needed most. With unparalleled knowledge of electrical power management across industries, experts at Eaton deliver customized, integrated solutions to solve our customers' most critical challenges.

Our focus is on delivering the right solution for the application. But, decision makers demand more than just innovative products. They turn to Eaton for an unwavering commitment to personal support that makes customer success a top priority. For more information, **visit www.eaton.com/electrical**.

Eaton
1000 Eaton Boulevard
Cleveland, OH 44122
United States
Eaton.com

© 2015 Eaton
All Rights Reserved
Printed in USA
Publication No. PA00801007E / Z16018
January 2015

Eaton is a registered trademark.
All other trademarks are property
of their respective owners.

