

DURA-BLOK™ Rooftop Supports



DURA-BLOK is made from 100% recycled rubber and qualifies for LEED credits. Reflective strips on both sides allow for easy product visibility.

Channels are through bolted on all sizes for added strength and a 1" (25.4mm) gap between blocks allows water to flow freely around longer assemblies.

Product composition is not sharp or abrasive, helping to extend the roof life and no penetration through the roof is required.

The DURA-BLOK dampens vibration, needs no supplemental rubber pad, and will not float or blow away.

The DURA-BLOK is UV resistant and is suitable on any type roofing material or other flat surface. For sloped surfaces see page 289 for adjustable hinge fitting (B634).

The open ends allow for easier adjustments to DBE, DBR, and DBM series supports. A drainage channel through the center of the block keeps water from pooling under the support.

DURA-BLOK can be used to support piping, HVAC/Ducts, roof walkways, conduit and cable tray.

Base Only

Dimensions - 4" (101mm) High x 6" (152mm) Wide x Base Length

Material - 100% recycled rubber, UV resistant

Ultimate Load Capacity - (uniform load) *

DBP = 500 lbs. (2.22kN)

DBM = 200 lbs. (0.89kN)

DURA-BLOK channel support is designed as an economical support for piping systems, cable tray, HVAC equipment and many other applications. The DURA-BLOK is UV resistant and is suitable for any type of roofing material or other flat surfaces. Material effectively accepts screw fasteners for securing accessories.

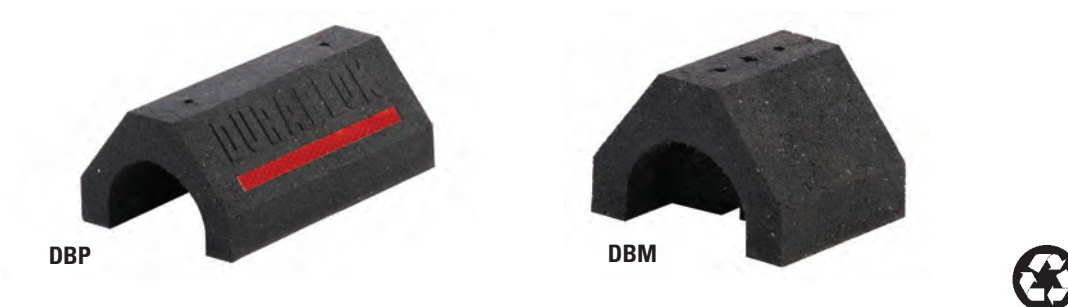

Part No.	Height	Width	Length	Weight Each
	in. (mm)	in. (mm)	in. (mm)	lbs. (kg)
DBP	4" (101)	6" (152)	9.6" (244)	4.48 (2.03)
DBM	4" (101)	6" (152)	4.8" (122)	2.35 (1.07)

*** For Roof Loading, Consult Roofing Manufacturer or Engineer. As with most commercial roofs, the weakest point may be the insulation board beneath the rubber membrane.**

All dimensions in charts and on drawings are in inches. Dimensions shown in parentheses are in millimeters unless otherwise specified.

DURA-BLOK™ Rooftop Supports

DB - Series

Base with Galv. Channel - 1" (25.4mm) high

Dimensions - 5" (127mm) High x 6" (152mm) Wide x Length (overall length)

Material - 100% recycled rubber, UV resistant

Ultimate Load Capacity - (uniform load) *

DB5 = 500 lbs. (2.22kN)

DB10 = 500 lbs. (2.22kN)

DB20 = 1,000 lbs. (4.45kN)

DB30 = 1,500 lbs. (6.67kN)

DB40 = 2,000 lbs. (8.89kN)

DB48 = 2,500 lbs. (11.12kN)



DURA-BLOK DB-Series channel support is designed for superior support of piping systems, cable tray, HVAC equipment, walkway systems and many other applications. The DURA-BLOK is UV resistant and suitable for installation on any type of roofing material or other flat surfaces. For sloped roofs see adjustable hinge fitting (B634).

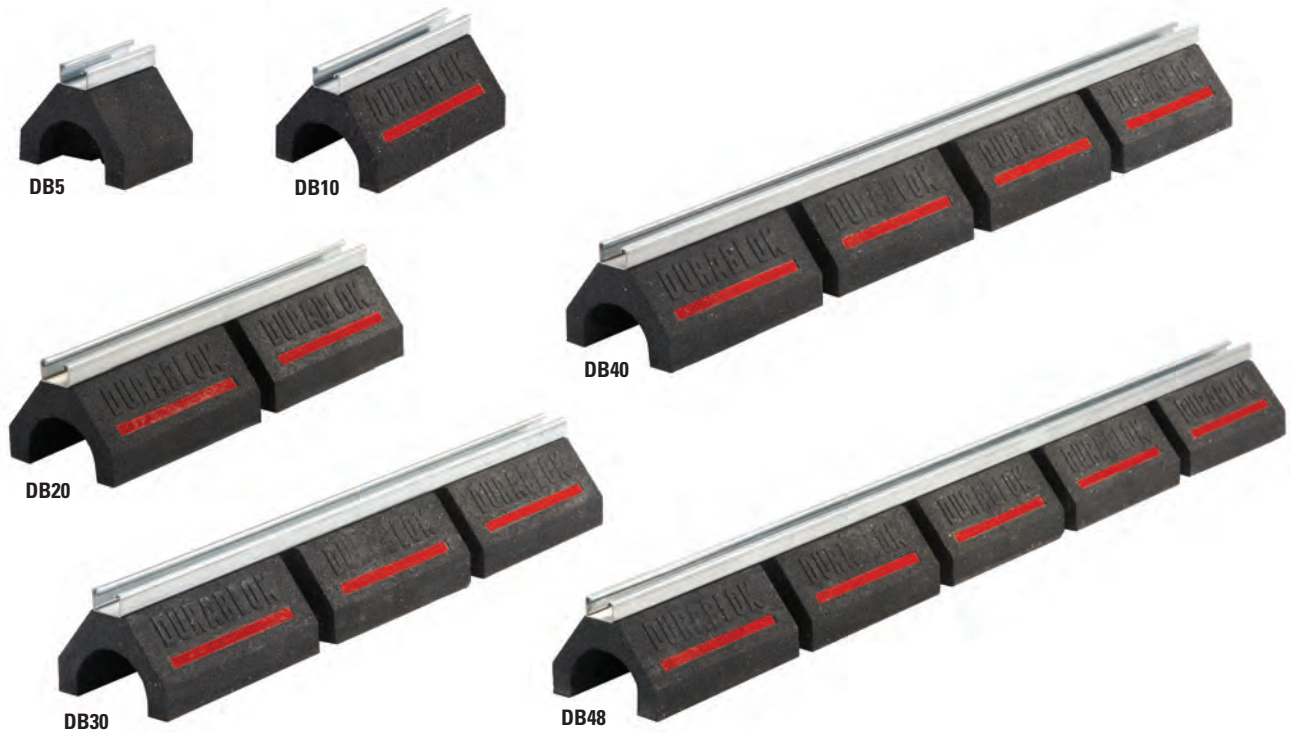

Part No.	Height	Width	Overall Length	Weight Each	
	in. (mm)	in. (mm)	in. (mm)	lbs.	(kg)
DB5	5" (127)	6" (152)	4.8" (122)	2.75	(1.25)
DB10	5" (127)	6" (152)	9.6" (244)	5.28	(2.39)
DB20	5" (127)	6" (152)	20.2" (513)	10.63	(4.82)
DB30	5" (127)	6" (152)	30.8" (782)	15.99	(7.25)
DB40	5" (127)	6" (152)	41.4" (1052)	21.34	(9.68)
DB48	5" (127)	6" (152)	52.0" (1321)	26.70	(12.4)

For pipe straps/clamps, rollers and roller supports that can be used with these DURA-BLOK supports, see page 289.

*** For Roof Loading, Consult Roofing Manufacturer or Engineer. As with most commercial roofs, the weakest point may be the insulation board beneath the rubber membrane.**

All dimensions in charts and on drawings are in inches. Dimensions shown in parentheses are in millimeters unless otherwise specified.

DB6 - Series

Base with Galv. Channel - 27/16" (62mm) high

Dimensions - 67/16" (163mm) High x 6" (152mm) Wide x Length (overall length)

Material - 100% recycled rubber, UV resistant

Ultimate Load Capacity - (uniform load) *

DB610 = 500 lbs. (2.22kN)

DB620 = 1,000 lbs. (4.45kN)

DB630 = 1,500 lbs. (6.67kN)

DB640 = 2,000 lbs. (8.89kN)

DB648 = 2,500 lbs. (22.12kN)



DURA-BLOK DB6-Series channel support is designed for superior support of piping systems, cable tray, HVAC equipment, walkway systems and many other applications. The DURA-BLOK is UV resistant and suitable for installation on any type of roofing material or other flat surfaces. For sloped roofs see adjustable hinge fitting (B634).



Part No.	Height in. (mm)	Width in. (mm)	Overall Length in. (mm)	Weight Each lbs. (kg)
DB610	67/16" (167)	6" (152)	9.6" (244)	6.36 (2.88)
DB620	67/16" (167)	6" (152)	20.2" (513)	12.90 (5.85)
DB630	67/16" (167)	6" (152)	30.8" (782)	19.45 (8.82)
DB640	67/16" (167)	6" (152)	41.4" (1052)	26.00 (11.79)
DB648	67/16" (167)	6" (152)	52.0" (1321)	32.55 (14.76)

For pipe straps/clamps, rollers and roller supports that can be used with these DURA-BLOK supports, see page 289.

*** For Roof Loading, Consult Roofing Manufacturer or Engineer. As with most commercial roofs, the weakest point may be the insulation board beneath the rubber membrane.**

All dimensions in charts and on drawings are in inches. Dimensions shown in parentheses are in millimeters unless otherwise specified.

DURA-BLOK™ Rooftop Supports

DB10 - Series

Two (2) Bases with Galv. Channel - 1⁵/₈" (41mm) high

Dimensions - 5³/₈" (143mm) High x 6" (152mm) Wide x Length (overall length)

Material - 100% recycled rubber, UV resistant

Ultimate Load Capacity - 1,000 lbs. (4.45kN) (uniform load) *

DURA-BLOK DB10-Series channel support is designed for superior support of piping systems, cable tray, HVAC equipment, walkway systems and many other applications. The DURA-BLOK is UV resistant and suitable for installation on any type of roofing material or other flat surfaces.

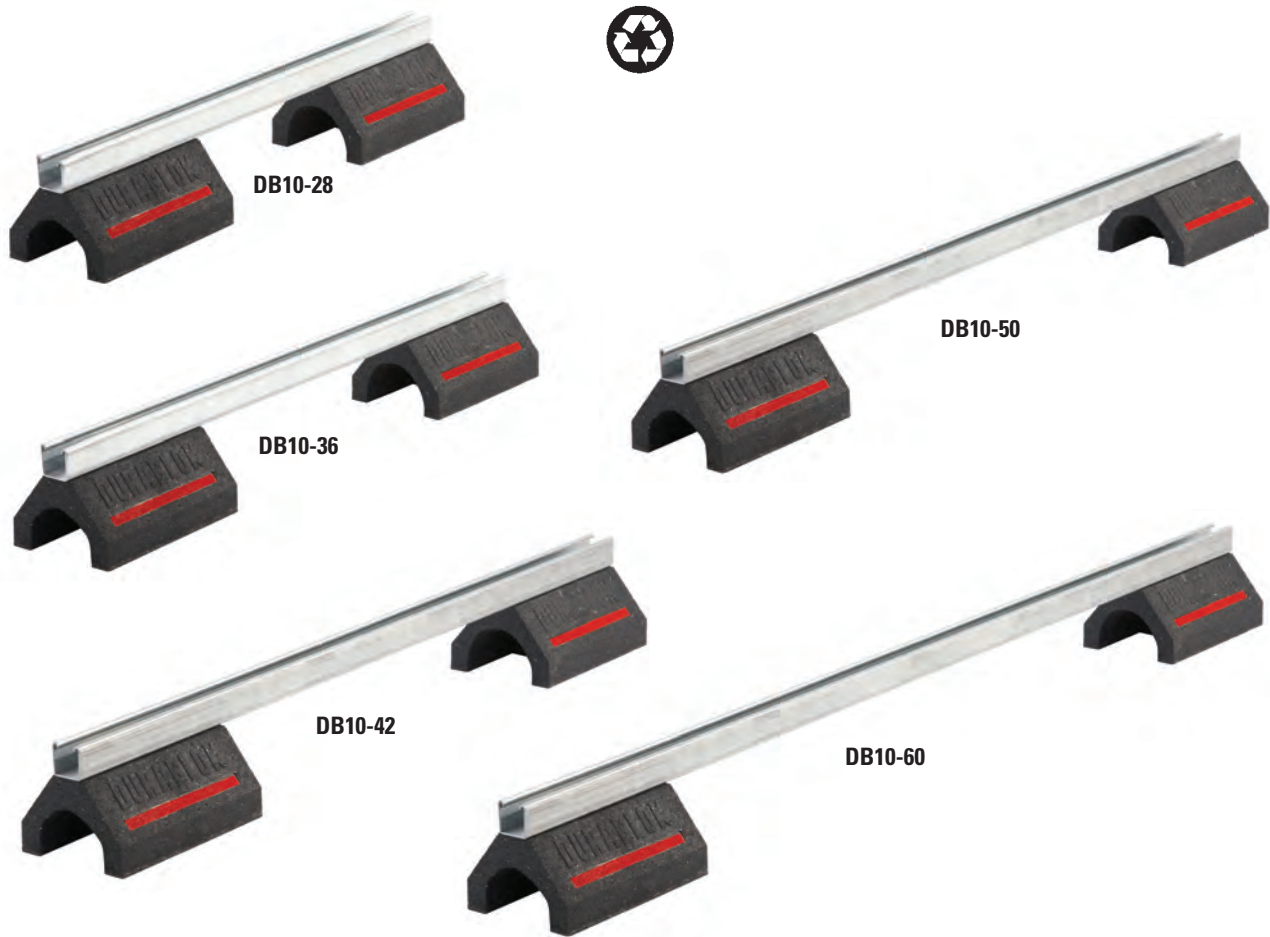

Part No.	Height in. (mm)	Width in. (mm)	Individual Base Length in. (mm)	Bridge Length in. (mm)	Weight Each lbs. (kg)
DB10-28	5 ³ / ₈ " (143)	6" (152)	9.6" (244)	28" (711)	13.16 (5.97)
DB10-36	5 ³ / ₈ " (143)	6" (152)	9.6" (244)	36" (914)	14.36 (6.51)
DB10-42	5 ³ / ₈ " (143)	6" (152)	9.6" (244)	42" (1067)	15.52 (7.04)
DB10-50	5 ³ / ₈ " (143)	6" (152)	9.6" (244)	50" (1270)	16.45 (7.46)
DB10-60	5 ³ / ₈ " (143)	6" (152)	9.6" (244)	60" (1524)	17.94 (8.14)

For pipe straps/clamps, rollers and roller supports that can be used with these DURA-BLOK supports, see page 289.

*** For Roof Loading, Consult Roofing Manufacturer or Engineer. As with most commercial roofs, the weakest point may be the insulation board beneath the rubber membrane.**

All dimensions in charts and on drawings are in inches. Dimensions shown in parentheses are in millimeters unless otherwise specified.

DBM - Series

Base with one (1) 3/8"-16 Electro Zinc All Threaded Rod and Hinged Pipe Clamp

Dimensions - Height to Pipe Center x 6" (152mm) Wide x 4.8" (122mm) Long (overall length)

Material - 100% recycled rubber, UV resistant

Pipe Clamp Material - Malleable Iron -

Pipe Sizes - Electro Plated

Copper Tubing Sizes - Dura Copper™

Threaded Rod/Hardware - Electro Plated Steel

Ultimate Load Capacity - 50 lbs. (0.22kN) (uniform load) *



DBM-2CT

DURA-BLOK DBM-Series pipe/tubing support is designed for support of single piping systems where elevation adjustment is needed. The DURA-BLOK is UV resistant and suitable for installation on any type of roofing material or other flat surfaces.

Part No.	Height (Minimum) *		Height (Maximum) **		Width		Length	
	in.	(mm)	in.	(mm)	in.	(mm)	in.	(mm)
DBM-1/2CT	9.69"	(246)	11.19"	(284)	6"	(152)	4.80"	(122)
DBM-3/4CT	9.84"	(250)	11.34"	(288)	6"	(152)	4.80"	(122)
DBM-1CT	9.95"	(253)	11.45"	(291)	6"	(152)	4.80"	(122)
DBM-1 1/4CT	10.13"	(257)	11.63"	(295)	6"	(152)	4.80"	(122)
DBM-1 1/2CT	10.28"	(261)	11.78"	(299)	6"	(152)	4.80"	(122)
DBM-2CT	10.53"	(267)	12.03"	(305)	6"	(152)	4.80"	(122)
DBM-1/2	9.86"	(250)	11.36"	(288)	6"	(152)	4.80"	(122)
DBM-3/4	10.06"	(255)	11.56"	(293)	6"	(152)	4.80"	(122)
DBM-1	10.14"	(257)	11.64"	(296)	6"	(152)	4.80"	(122)
DBM-1 1/4	10.25"	(260)	11.75"	(298)	6"	(152)	4.80"	(122)
DBM-1 1/2	10.42"	(265)	11.92"	(303)	6"	(152)	4.80"	(122)
DBM-2	10.66"	(271)	12.16"	(309)	6"	(152)	4.80"	(122)

Part No.	Clamp Part No. †	Weight Each lbs. (kg)
DBM-1/2CT	B3198HCT-1/2	2.75 (1.25)
DBM-3/4CT	B3198HCT-3/4	2.76 (1.25)
DBM-1CT	B3198HCT-1	2.84 (1.29)
DBM-1 1/4CT	B3198HCT-1 1/4	2.95 (1.34)
DBM-1 1/2CT	B3198HCT-1 1/2	2.96 (1.34)
DBM-2CT	B3198HCT-2	3.03 (1.37)
DBM-1/2	B3198H-1/2	2.78 (1.26)
DBM-3/4	B3198H-3/4	2.84 (1.29)
DBM-1	B3198H-1	2.86 (1.30)
DBM-1 1/4	B3198H-1 1/4	2.93 (1.33)
DBM-1 1/2	B3198H-1 1/2	2.99 (1.36)
DBM-2	B3198H-2	3.10 (1.41)



DBM-1

† See Pipe Hanger Catalog for dimensions and specifications. ** From bottom of rubber block to center of pipe/tubing.

*** For Roof Loading, Consult Roofing Manufacturer or Engineer. As with most commercial roofs, the weakest point may be the insulation board beneath the rubber membrane.**

All dimensions in charts and on drawings are in inches. Dimensions shown in parentheses are in millimeters unless otherwise specified.

DURA-BLOK™ Rooftop Supports

DB_DS - Series

**Two (2) Base Supports with Galv. Channel - 1⁵/₈" (41mm) high
Riser Channels (SH Style) - 1⁵/₈" (41mm) x 1⁵/₈" (41mm)
Fittings & Hardware - Electro-Plated Steel**

Dimensions - Height (overall) x Width (overall) x Length (overall)

Material - 100% recycled rubber, UV resistant

Ultimate Load Capacity - 1,000 lbs. (4.45kN) (uniform load) *

DURA-BLOK DB_DS-Series channel support with risers is designed for superior support of piping systems, cable tray, HVAC equipment, walkway systems and many other applications. The DURA-BLOK is UV resistant and suitable for installation on any type of roofing material or other flat surfaces.

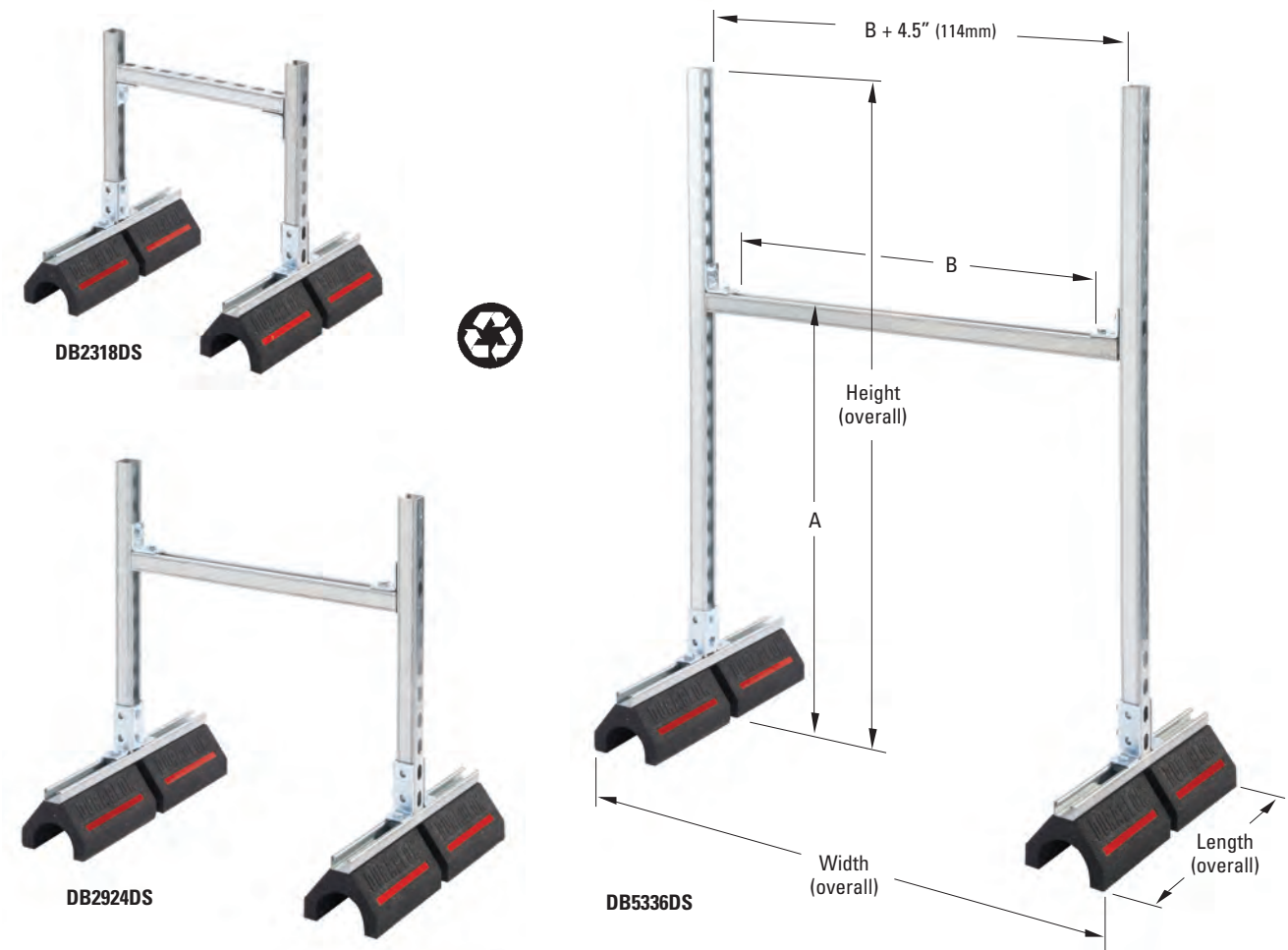

Product is shipped unassembled.

For pipe straps/clamps, rollers and roller supports that can be used with these DURA-BLOK supports, see page 289.

*** For Roof Loading, Consult Roofing Manufacturer or Engineer. As with most commercial roofs, the weakest point may be the insulation board beneath the rubber membrane.**

All dimensions in charts and on drawings are in inches. Dimensions shown in parentheses are in millimeters unless otherwise specified.

Part No.	A (Minimum)		A (Maximum)		B	
	in.	(mm)	in.	(mm)	in.	(mm)
DB2318DS	10.56"	(268)	20.75"	(527)	13.50"	(343)
DB2918DS	10.56"	(268)	26.75"	(679)	13.50"	(343)
DB4118DS	10.56"	(268)	38.75"	(984)	13.50"	(343)
DB5318DS	10.56"	(268)	50.75"	(1289)	13.50"	(343)
DB2324DS	10.56"	(268)	20.75"	(527)	19.50"	(495)
DB2924DS	10.56"	(268)	26.75"	(679)	19.50"	(495)
DB4124DS	10.56"	(268)	38.75"	(984)	19.50"	(495)
DB5324DS	10.56"	(268)	50.75"	(1289)	19.50"	(495)
DB2336DS	10.56"	(268)	20.75"	(527)	31.50"	(800)
DB2936DS	10.56"	(268)	26.75"	(679)	31.50"	(800)
DB4136DS	10.56"	(268)	38.75"	(984)	31.50"	(800)
DB5336DS	10.56"	(268)	50.75"	(1289)	31.50"	(800)
DB2348DS	10.56"	(268)	20.75"	(527)	43.50"	(1105)
DB2948DS	10.56"	(268)	26.75"	(679)	43.50"	(1105)
DB4148DS	10.56"	(268)	38.75"	(984)	43.50"	(1105)
DB5348DS	10.56"	(268)	50.75"	(1289)	43.50"	(1105)

Part No.	Height (overall)		Width (overall)		Length (overall)		Weight Each	
	in.	(mm)	in.	(mm)	in.	(mm)	lbs.	(kg)
DB2318DS	23"	(584)	25 ⁵ / ₈ "	(651)	20.2"	(513)	33.31	(15.11)
DB2918DS	29"	(736)	25 ⁵ / ₈ "	(651)	20.2"	(513)	35.00	(15.88)
DB4118DS	41"	(1041)	25 ⁵ / ₈ "	(651)	20.2"	(513)	38.40	(17.42)
DB5318DS	53"	(1346)	25 ⁵ / ₈ "	(651)	20.2"	(513)	41.80	(18.96)
DB2324DS	23"	(584)	31 ⁵ / ₈ "	(803)	20.2"	(513)	34.15	(15.49)
DB2924DS	29"	(736)	31 ⁵ / ₈ "	(803)	20.2"	(513)	35.84	(16.26)
DB4124DS	41"	(1041)	31 ⁵ / ₈ "	(803)	20.2"	(513)	39.25	(17.80)
DB5324DS	53"	(1346)	31 ⁵ / ₈ "	(803)	20.2"	(513)	42.65	(19.34)
DB2336DS	23"	(584)	43 ⁵ / ₈ "	(1108)	20.2"	(513)	35.84	(16.26)
DB2936DS	29"	(736)	43 ⁵ / ₈ "	(1108)	20.2"	(513)	37.55	(17.03)
DB4136DS	41"	(1041)	43 ⁵ / ₈ "	(1108)	20.2"	(513)	40.95	(18.57)
DB5336DS	53"	(1346)	43 ⁵ / ₈ "	(1108)	20.2"	(513)	44.34	(20.11)
DB2348DS	23"	(584)	55 ⁵ / ₈ "	(1415)	20.2"	(513)	37.55	(17.03)
DB2948DS	29"	(736)	55 ⁵ / ₈ "	(1415)	20.2"	(513)	39.25	(17.80)
DB4148DS	41"	(1041)	55 ⁵ / ₈ "	(1415)	20.2"	(513)	42.65	(19.34)
DB5348DS	53"	(1346)	55 ⁵ / ₈ "	(1415)	20.2"	(513)	46.03	(20.88)

A = Adjustable height from bottom of DURA-BLOK to top of horizontal channel.

B = Space between fittings that support horizontal channel.

Height (overall) = Distance from bottom of DURA-BLOK to top of upright channel.

Width (overall) = Distance from outside-to-outside of DURA-BLOK supports.

Length (overall) = Distance from end-to-end of DURA-BLOK supports.

All dimensions in charts and on drawings are in inches. Dimensions shown in parentheses are in millimeters unless otherwise specified.

DURA-BLOK™ Rooftop Supports

DBR - Series (Fixed Height)

Base with Galv. Channel - 1" (25.4mm) high and Pipe Roller Assembly

Dimensions - Height to Bottom of Pipe x 6" (152mm) Wide x Long (overall length)

Material - 100% recycled rubber, UV resistant

Pipe Roller Material - Cast Iron - Electro Plated

Brackets, Axle, & Hardware - Electro Plated Steel

Ultimate Load Capacity - (uniform load) *

DBR2-3¹/₂ = 500 lbs. (2.22kN)

DBR4-6 = 500 lbs. (2.22kN)

DBR8-10 = 1000 lbs. (4.44kN)

DBR12-14 = 1000 lbs. (4.44kN)

DBR16-20 = 1000 lbs. (4.44kN)



DBR4-6



DBR16-20

DURA-BLOK DBR-Series support is designed to support pipe where longitudinal movement is expected. The DURA-BLOK is UV resistant and approved for installation on any type of roofing material or other flat surfaces.

Part No.	Height **		Width		Length	
	in.	(mm)	in.	(mm)	in.	(mm)
DBR2-3¹/₂	7.09"	(180)	6"	(152)	9.6"	(244)
DBR4-6	7.09"	(180)	6"	(152)	9.6"	(244)
DBR8-10	8.34"	(212)	6"	(152)	20.2"	(513)
DBR12-14	9.38"	(238)	6"	(152)	20.2"	(513)
DBR16-20	9.78"	(248)	6"	(152)	20.2"	(513)

Part No.	Roller Part No. †	Weight Each	
		lbs.	(kg)
DBR2-3¹/₂	B3126-2 to 3 ¹ / ₂	5.28	(2.39)
DBR4-6	B3126-4 to 6	10.63	(4.82)
DBR8-10	B3126-8 to 10	15.99	(7.25)
DBR12-14	B3126-12 to 14	21.34	(9.68)
DBR16-20	B3126-16 to 20	26.70	(12.11)

† See Pipe Hanger Catalog for dimensions and specifications. ** From bottom of rubber block to bottom of pipe/tubing.

*** For Roof Loading, Consult Roofing Manufacturer or Engineer. As with most commercial roofs, the weakest point may be the insulation board beneath the rubber membrane.**

All dimensions in charts and on drawings are in inches. Dimensions shown in parentheses are in millimeters unless otherwise specified.

DBR - Series (Adjustable Height)

Base with two (2) 1/2"-13 Electro Zinc All Threaded Rod Risers and a B3114-3 1/2 Pipe Roll with Sockets

Dimensions - Overall Height 12" (305mm) from bottom of base to pipe contact point on roller.

Base - 4" High (101mm) x 6" (152mm) Wide x 9.6" (244mm) Length (base length)

Material - 100% recycled rubber, UV resistant

Pipe Roll & Sockets - For up to 3 1/2" (90mm) pipe sizes.

Ultimate Load Capacity - 200 lbs. (0.89kN) *

(To increase load capacity use CLDP10 load distribution plate.)



DURA-BLOK DBR-Series support is designed to support pipe up to 3 1/2" (90mm) nominal size where difference in elevation is required and longitudinal movement is expected. The DURA-BLOK is UV resistant and approved for installation on any type of roofing material or other flat surfaces.

Part No.	Adjustable Height		Width		Length		Weight Each	
	in.	(mm)	in.	(mm)	in.	(mm)	lbs.	(kg)
DBR10-12	up to 12"	(up to 305)	6"	(152)	9.6"	(244)	6.46	(2.93)

DBE - Series

Base with two (2) 1/2"-13 Electro Zinc All Threaded Rod Risers and Galv. Channel - 1" (25mm) high

Dimensions - Overall Height as Specified

Base - 4" High (101mm) x 6" (152mm) Wide x 9.6" (244mm) Length (base length)

Material - 100% recycled rubber, UV resistant

Ultimate Load Capacity - 200 lbs. (0.89kN) * (To increase load capacity use CLDP10 load distribution plate.)

DURA-BLOK DBE-Series channel support is designed as a support of piping systems, cable tray, HVAC equipment and many other applications where elevation adjustment is critical. The DURA-BLOK is UV resistant and suitable for installation on any type of roofing material or other flat surfaces.

For pipe straps/clamps, rollers and roller supports that can be used with these DURA-BLOK supports, see page 289.



DBE10-12

Part No.	Adjustable Height		Width		Channel Length		Weight Each	
	in.	(mm)	in.	(mm)	in.	(mm)	lbs.	(kg)
DBE10-8	5 1/2" - 8"	(140 - 203)	6"	(152)	9.35"	(238)	5.68	(2.58)
DBE10-12	5 1/2" - 12"	(140 - 305)	6"	(152)	9.35"	(238)	5.72	(2.59)
DBE10-16	5 1/2" - 16"	(140 - 406)	6"	(152)	9.35"	(238)	5.76	(2.61)

** Longer base lengths available.

Note: At heights above 12" (305mm), we suggest using the DB_DS Series Channel Support with Risers for additional stability to piping system.

*** For Roof Loading, Consult Roofing Manufacturer or Engineer. As with most commercial roofs, the weakest point may be the insulation board beneath the rubber membrane.**

DURA-BLOK™ Rooftop Supports

CLDP10 - Load Distribution Plate

Steel Plate with Slots

Dimensions - 1⁵/₈" (41mm) Wide x 6¹/₂" (65mm) Long

Material - 11 Ga. steel (3.0mm)

Increases ultimate uniform load capacity on DBE & DBR Series supports to 500 lbs. (2.22kN)

DURA-BLOK CLDP10 load bearing stabilizer plate increases load ratings for DBE Series and DBR Series supports by allowing the load from the threaded rods to be distributed over the length of the base instead of the point load where the rods attach to the base.

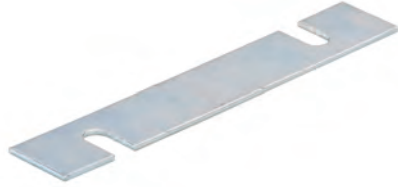

Loosen hex nuts and slide plate under the flat washers



Retighten the hex nuts with plate in place

Part No.	Adjustable Height		Width in. (mm)	Length in. (mm)	Weight Each lbs. (kg)
	in.	(mm)			
CLDP10	11 Ga.	(3.05)	1 ⁵ / ₈ " (41)	9 ¹ / ₂ " (241)	0.53 (0.24)

Compatible Components Available to make DURA-BLOK bases more versatile

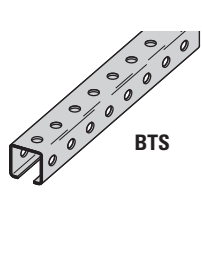

BTS



TN Nuts



HHCS

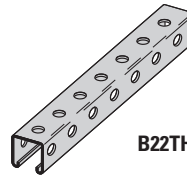

B22TH

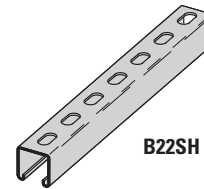

B22SH

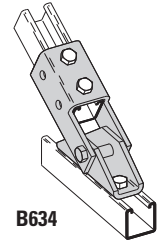

B634

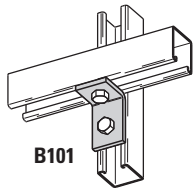

B101

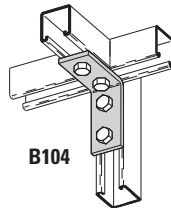

B104

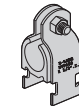

BVT Series

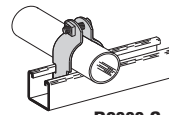

B2000 Series

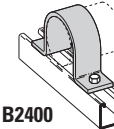

B2400 Series



B3124 Series

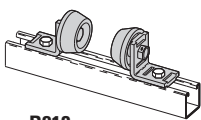

B218

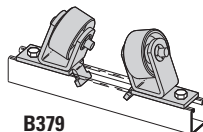

B379

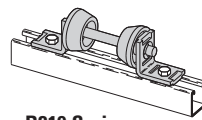

B219 Series

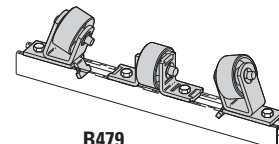

B479

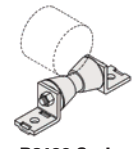

B3126 Series

Above rollers can be mounted on DB Series, DB6 Series, and DB10 Series units.

All dimensions in charts and on drawings are in inches. Dimensions shown in parentheses are in millimeters unless otherwise specified.

Rooftop Support Specification

SECTION 07720

ROOFTOP SUPPORT SYSTEMS

(Applicable to Section 15060 (Mechanical) and Section 16070 (Electrical))

PART 1 GENERAL

1.01 SECTION INCLUDES

- A. The work covered by this specification consists of furnishing all labor, equipment, materials and accessories, and performing all operations required for the correct installation of recycled rubber pipe [conduit] supports for mechanical piping [electrical conduit] systems.

1.02 REFERENCES

- A. ASTM A653 G90 SS Gr. 33 - Specification for Steel Sheet, Zinc Coated (Galvanized) by the Hot Dipped Process
- B. ASTM B633 - Specification for Electrodeposited Coatings of Zinc on Iron and Steel
- C. ASTM C531 – Test Method for Linear Shrinkage and Coefficient of Thermal Expansion of Chemical Resistant Mortars, Grouts, Monolithic Surfaces, and Polymer Concretes
- D. ASTM C642 – Test Method for Specific Gravity, Absorption, and Voids in Hardened Concrete
- E. ASTM C672 – Test Methods for Scaling Resistance of Concrete Surfaces Exposed to Deicing Chemicals
- F. ASTM D412 – Test Methods for Vulcanized Rubber and Thermoplastic Elastomers – Tension
- G. ASTM D395 – Standard Test Methods for Rubber Property – Compression Set
- H. ASTM D573 – Test Method for Rubber – Deterioration in an Air Oven
- I. ASTM D746 – Test Method for Brittleness Temperature of Plastics and Elastomers by Impact
- J. ASTM D2240 – Test Method for Rubber Property – Durometer Hardness
- K. NFPA 70 – National Electrical Code

1.03 QUALITY ASSURANCE

- A. Rubber / steel pipe supports shall be manufactured under a strict quality control program assuring quality product delivered to the jobsite. Pipe supports that are damaged shall not be installed.
- B. Workmanship: All pipe [conduit] supports to be installed by a qualified piping [electrical] contractor and installed in accordance with manufacturer's recommendations.
 1. All work shall comply with all applicable federal, state, and local codes and laws having jurisdiction.
 2. All work shall conform to accepted industry and trade standards for pipe support [conduit] installations.

PART 2 PRODUCTS

2.01 ACCEPTABLE MANUFACTURERS

- A. Manufacturer: Subject to compliance with these specifications, pipe support systems shall be DURA-BLOK™ design as supplied by Eaton B-Line Business [or engineer approved equal].

2.02 MATERIALS

- A. Curb base must be made of 100% recycled rubber and polyurethane prepolymer with a uniform load capacity of 500 pounds per linear foot of support*. In addition, each base to have a reflective red stripe.
(*See 3.01(C))
- B. Dimensions: 6-inches wide by [4] [5.0] [6.75] inches tall by [9.6] [20.2] [30.8] [41.4] [52.0] inches long.
- C. Steel frame: Steel, 14ga strut galvanized per ASTM A653 or 12ga strut galvanized per ASTM A653 for bridge series.
- D. Attaching hardware: Zinc-plated threaded rod, nuts and attaching hardware per ASTM B633.

DURA-BLOK™ Rooftop Supports

GRATEWALK™ Rooftop Walkway with Integrated DURA-BLOK™ Supports

B-Line series GRATEWALK™ Rooftop Walkways with DURA-BLOK™ provides the optimal solution to extend the life of your roof, while providing a safe pathway to roof mounted support equipment.

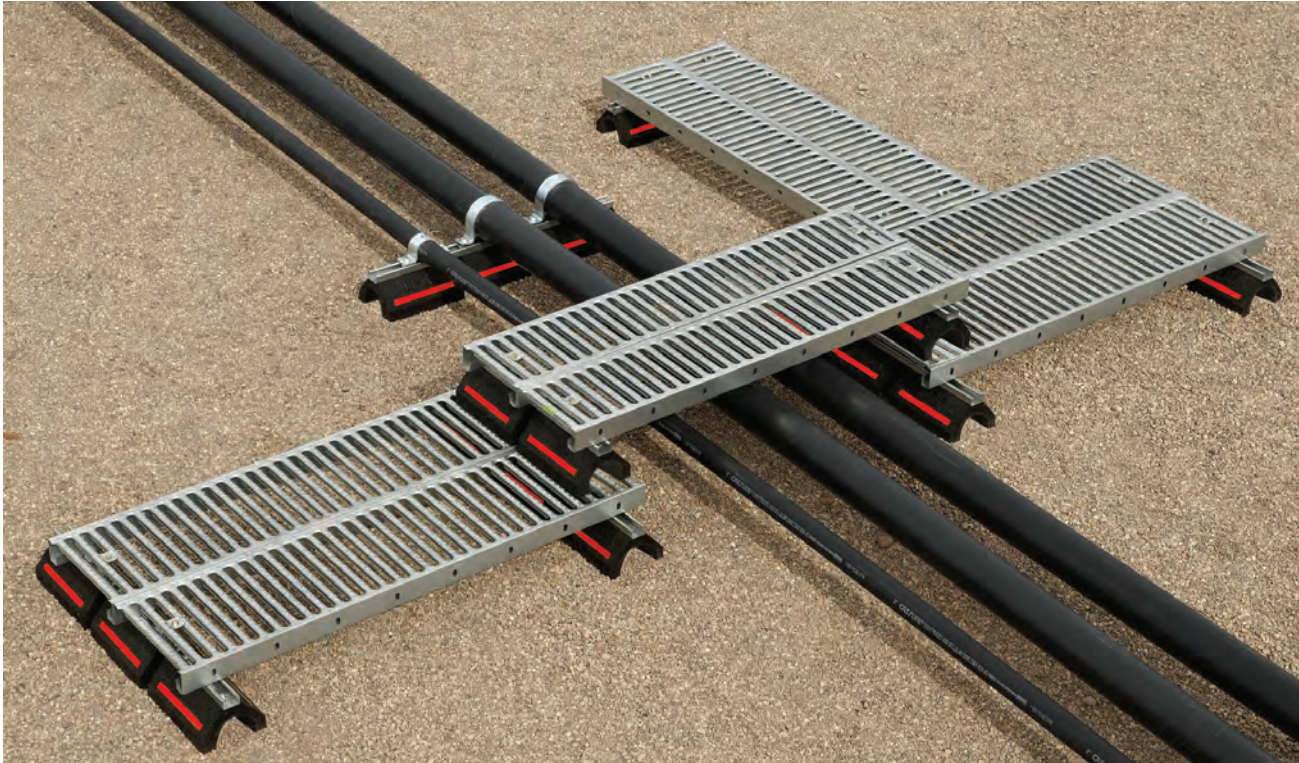

Features & Benefits of the GRATEWALK Rooftop Walkway

- Available with slip resistant GRATE-LOCK™, helping provide a safe walkway for foot traffic on the roof.
- Easy to install, elevated design, creates an identifiable path for foot traffic helping prevent wear and tear to the roof surface.
- The cross-over design offers safe passage over existing cabling, piping, cable tray or any other interference on the rooftop.
- The self cleaning pattern allows water and dirt to easily flow through, helping make the grating an ideal walkway in all weather conditions.
- Handrail options are available
- Integrated with 100% post-consumer recycled rubber supporting LEED credit qualification.
- Provide solid support for the walkway that stays in place and replaces the need for separate rubber roof mounting pads which tend to float away.

All dimensions in charts and on drawings are in inches. Dimensions shown in parentheses are in millimeters unless otherwise specified.

GRATEWALK™ Rooftop Walkway with Integrated DURA-BLOK™ Supports

The GRATEWALK™ Rooftop Walkway with Integrated DURA-BLOK™ Supports* is available in a variety of configurations.

- Straight sections for long straight stretches of pathway
- Cross-over options to install over the existing cable trays, piping, and more
- Stairways over the top of existing equipment or leading up to existing equipment
- Handrail options available for additional walkway safety and support
- Platforms to provide access to rooftop mounted equipment
- Accessories available to support unique requirements

* All Items are shipped individually for field assembly.



Engineering Design Service

- Take-off and estimating
- Specification review and development
- Alternative layout designs
- Technical consultation
- Submittal drawing packages (see Figure A) including assembly instructions

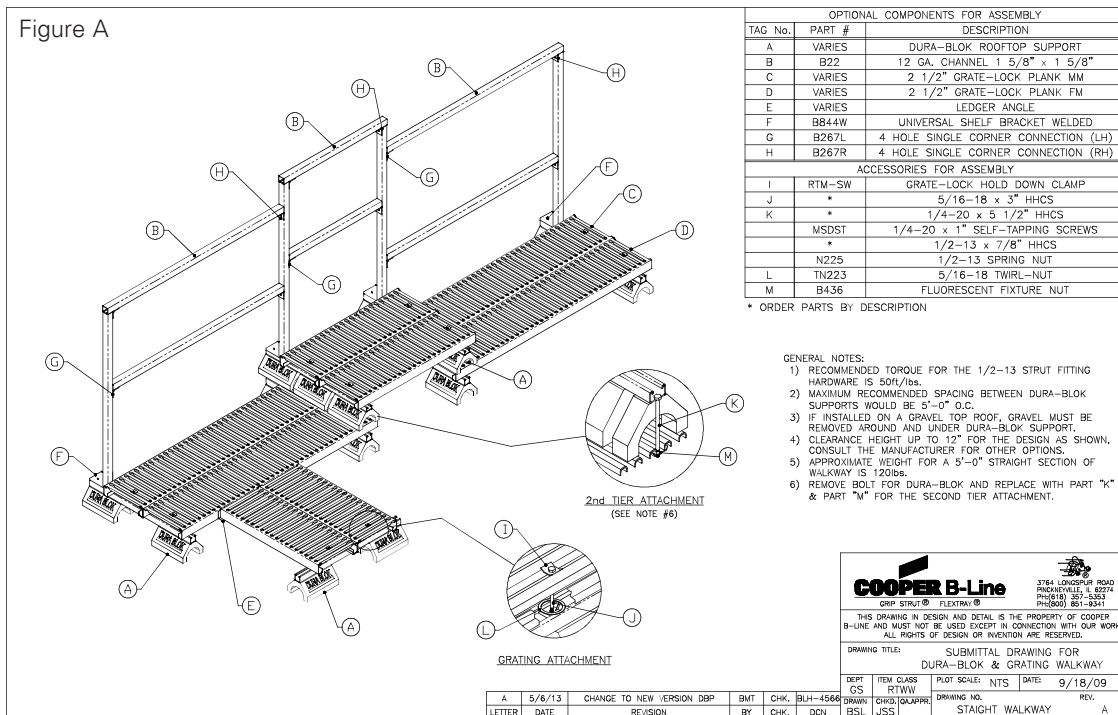

DURA-BLOK™ Rooftop Supports



DURA-BLOK is made from 100% recycled rubber and qualifies for LEED credits. Reflective strips on both sides allow for easy product visibility.

Channels are through bolted on all sizes for added strength and a 1" (25.4mm) gap between blocks allows water to flow freely around longer assemblies.

Product composition is not sharp or abrasive, helping to extend the roof life and no penetration through the roof is required.

The DURA-BLOK dampens vibration, needs no supplemental rubber pad, and will not float or blow away.

The DURA-BLOK is UV resistant and is suitable on any type roofing material or other flat surface. For sloped surfaces see page 289 for adjustable hinge fitting (B634).

The open ends allow for easier adjustments to DBE, DBR, and DBM series supports. A drainage channel through the center of the block keeps water from pooling under the support.

DURA-BLOK can be used to support piping, HVAC/Ducts, roof walkways, conduit and cable tray.

Base Only

Dimensions - 4" (101mm) High x 6" (152mm) Wide x Base Length

Material - 100% recycled rubber, UV resistant

Ultimate Load Capacity - (uniform load) *

DBP = 500 lbs. (2.22kN)

DBM = 200 lbs. (0.89kN)

DURA-BLOK channel support is designed as an economical support for piping systems, cable tray, HVAC equipment and many other applications. The DURA-BLOK is UV resistant and is suitable for any type of roofing material or other flat surfaces. Material effectively accepts screw fasteners for securing accessories.

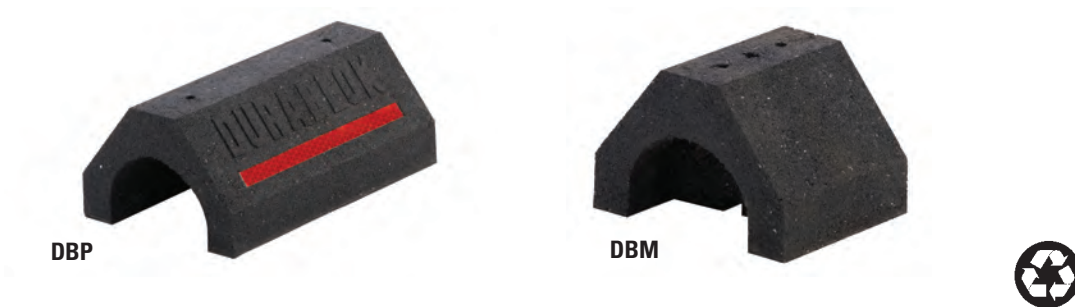

Part No.	Height	Width	Length	Weight Each
	in. (mm)	in. (mm)	in. (mm)	lbs. (kg)
DBP	4" (101)	6" (152)	9.6" (244)	4.48 (2.03)
DBM	4" (101)	6" (152)	4.8" (122)	2.35 (1.07)

*** For Roof Loading, Consult Roofing Manufacturer or Engineer. As with most commercial roofs, the weakest point may be the insulation board beneath the rubber membrane.**

All dimensions in charts and on drawings are in inches. Dimensions shown in parentheses are in millimeters unless otherwise specified.

DURA-BLOK™ Rooftop Supports

DB - Series

Base with Galv. Channel - 1" (25.4mm) high

Dimensions - 5" (127mm) High x 6" (152mm) Wide x Length (overall length)

Material - 100% recycled rubber, UV resistant

Ultimate Load Capacity - (uniform load) *

DB5 = 500 lbs. (2.22kN)

DB10 = 500 lbs. (2.22kN)

DB20 = 1,000 lbs. (4.45kN)

DB30 = 1,500 lbs. (6.67kN)

DB40 = 2,000 lbs. (8.89kN)

DB48 = 2,500 lbs. (11.12kN)



DURA-BLOK DB-Series channel support is designed for superior support of piping systems, cable tray, HVAC equipment, walkway systems and many other applications. The DURA-BLOK is UV resistant and suitable for installation on any type of roofing material or other flat surfaces. For sloped roofs see adjustable hinge fitting (B634).



Part No.	Height		Width		Overall Length		Weight Each	
	in.	(mm)	in.	(mm)	in.	(mm)	lbs.	(kg)
DB5	5"	(127)	6"	(152)	4.8"	(122)	2.75	(1.25)
DB10	5"	(127)	6"	(152)	9.6"	(244)	5.28	(2.39)
DB20	5"	(127)	6"	(152)	20.2"	(513)	10.63	(4.82)
DB30	5"	(127)	6"	(152)	30.8"	(782)	15.99	(7.25)
DB40	5"	(127)	6"	(152)	41.4"	(1052)	21.34	(9.68)
DB48	5"	(127)	6"	(152)	52.0"	(1321)	26.70	(12.4)

For pipe straps/clamps, rollers and roller supports that can be used with these DURA-BLOK supports, see page 289.

*** For Roof Loading, Consult Roofing Manufacturer or Engineer. As with most commercial roofs, the weakest point may be the insulation board beneath the rubber membrane.**

All dimensions in charts and on drawings are in inches. Dimensions shown in parentheses are in millimeters unless otherwise specified.

DB6 - Series

Base with Galv. Channel - 27/16" (62mm) high

Dimensions - 67/16" (163mm) High x 6" (152mm) Wide x Length (overall length)

Material - 100% recycled rubber, UV resistant

Ultimate Load Capacity - (uniform load) *

DB610 = 500 lbs. (2.22kN)

DB620 = 1,000 lbs. (4.45kN)

DB630 = 1,500 lbs. (6.67kN)

DB640 = 2,000 lbs. (8.89kN)

DB648 = 2,500 lbs. (22.12kN)



DURA-BLOK DB6-Series channel support is designed for superior support of piping systems, cable tray, HVAC equipment, walkway systems and many other applications. The DURA-BLOK is UV resistant and suitable for installation on any type of roofing material or other flat surfaces. For sloped roofs see adjustable hinge fitting (B634).



Part No.	Height in. (mm)	Width in. (mm)	Overall Length in. (mm)	Weight Each lbs. (kg)
DB610	67/16" (167)	6" (152)	9.6" (244)	6.36 (2.88)
DB620	67/16" (167)	6" (152)	20.2" (513)	12.90 (5.85)
DB630	67/16" (167)	6" (152)	30.8" (782)	19.45 (8.82)
DB640	67/16" (167)	6" (152)	41.4" (1052)	26.00 (11.79)
DB648	67/16" (167)	6" (152)	52.0" (1321)	32.55 (14.76)

For pipe straps/clamps, rollers and roller supports that can be used with these DURA-BLOK supports, see page 289.

*** For Roof Loading, Consult Roofing Manufacturer or Engineer. As with most commercial roofs, the weakest point may be the insulation board beneath the rubber membrane.**

All dimensions in charts and on drawings are in inches. Dimensions shown in parentheses are in millimeters unless otherwise specified.

DURA-BLOK™ Rooftop Supports

DB10 - Series

Two (2) Bases with Galv. Channel - 1⁵/₈" (41mm) high

Dimensions - 5³/₈" (143mm) High x 6" (152mm) Wide x Length (overall length)

Material - 100% recycled rubber, UV resistant

Ultimate Load Capacity - 1,000 lbs. (4.45kN) (uniform load) *

DURA-BLOK DB10-Series channel support is designed for superior support of piping systems, cable tray, HVAC equipment, walkway systems and many other applications. The DURA-BLOK is UV resistant and suitable for installation on any type of roofing material or other flat surfaces.

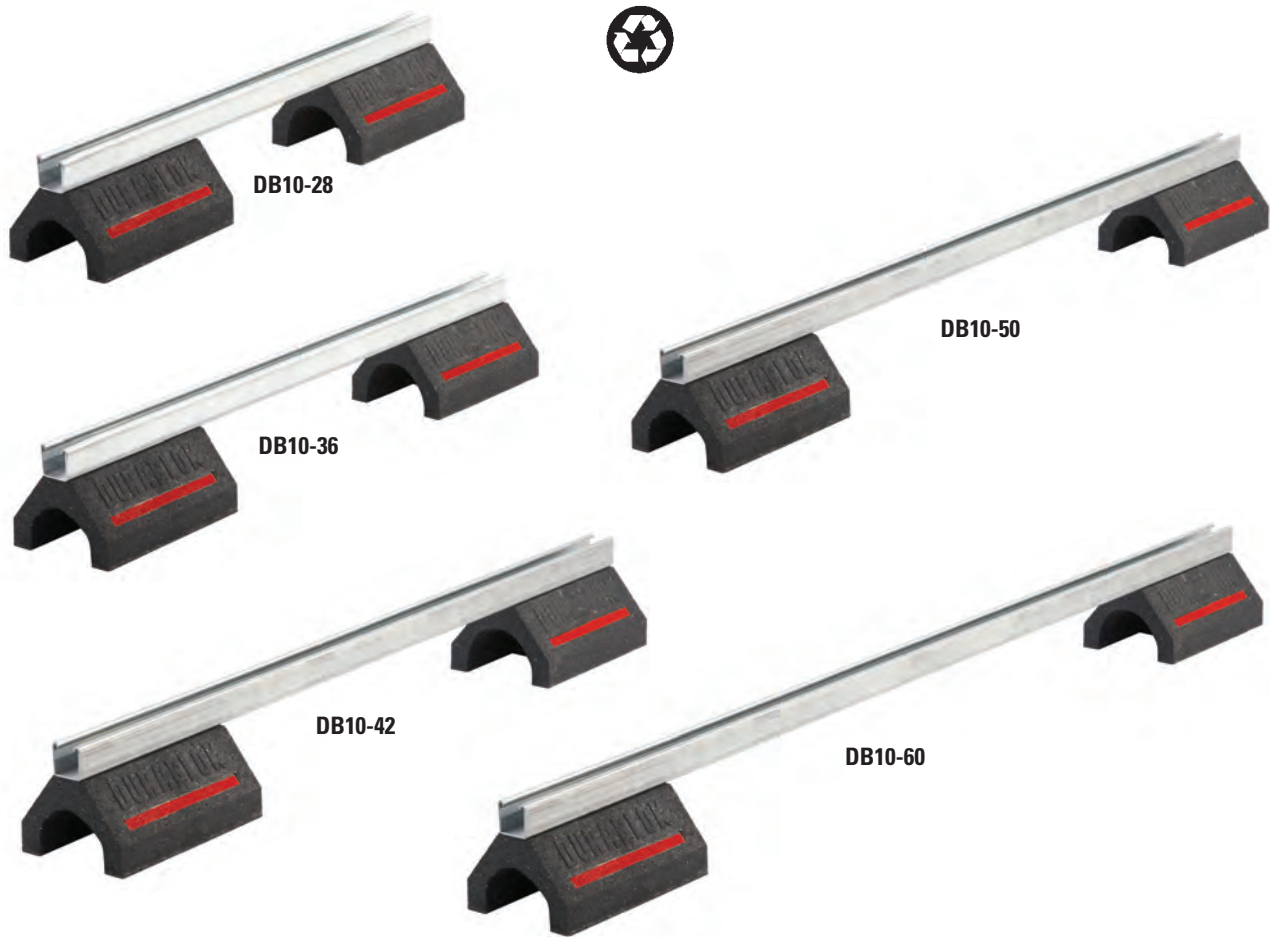

Part No.	Height		Width		Individual Base Length		Bridge Length		Weight Each	
	in.	(mm)	in.	(mm)	in.	(mm)	in.	(mm)	lbs.	(kg)
DB10-28	5 ³ / ₈ "	(143)	6"	(152)	9.6"	(244)	28"	(711)	13.16	(5.97)
DB10-36	5 ³ / ₈ "	(143)	6"	(152)	9.6"	(244)	36"	(914)	14.36	(6.51)
DB10-42	5 ³ / ₈ "	(143)	6"	(152)	9.6"	(244)	42"	(1067)	15.52	(7.04)
DB10-50	5 ³ / ₈ "	(143)	6"	(152)	9.6"	(244)	50"	(1270)	16.45	(7.46)
DB10-60	5 ³ / ₈ "	(143)	6"	(152)	9.6"	(244)	60"	(1524)	17.94	(8.14)

For pipe straps/clamps, rollers and roller supports that can be used with these DURA-BLOK supports, see page 289.

*** For Roof Loading, Consult Roofing Manufacturer or Engineer. As with most commercial roofs, the weakest point may be the insulation board beneath the rubber membrane.**

All dimensions in charts and on drawings are in inches. Dimensions shown in parentheses are in millimeters unless otherwise specified.

DBM - Series

Base with one (1) 3/8"-16 Electro Zinc All Threaded Rod and Hinged Pipe Clamp

Dimensions - Height to Pipe Center x 6" (152mm) Wide x 4.8" (122mm) Long (overall length)

Material - 100% recycled rubber, UV resistant

Pipe Clamp Material - Malleable Iron -

Pipe Sizes - Electro Plated

Copper Tubing Sizes - Dura Copper™

Threaded Rod/Hardware - Electro Plated Steel

Ultimate Load Capacity - 50 lbs. (0.22kN) (uniform load) *



DBM-2CT

DURA-BLOK DBM-Series pipe/tubing support is designed for support of single piping systems where elevation adjustment is needed. The DURA-BLOK is UV resistant and suitable for installation on any type of roofing material or other flat surfaces.

Part No.	Height (Minimum) *		Height (Maximum) **		Width		Length	
	in.	(mm)	in.	(mm)	in.	(mm)	in.	(mm)
DBM-1/2CT	9.69"	(246)	11.19"	(284)	6"	(152)	4.80"	(122)
DBM-3/4CT	9.84"	(250)	11.34"	(288)	6"	(152)	4.80"	(122)
DBM-1CT	9.95"	(253)	11.45"	(291)	6"	(152)	4.80"	(122)
DBM-1 1/4CT	10.13"	(257)	11.63"	(295)	6"	(152)	4.80"	(122)
DBM-1 1/2CT	10.28"	(261)	11.78"	(299)	6"	(152)	4.80"	(122)
DBM-2CT	10.53"	(267)	12.03"	(305)	6"	(152)	4.80"	(122)
DBM-1/2	9.86"	(250)	11.36"	(288)	6"	(152)	4.80"	(122)
DBM-3/4	10.06"	(255)	11.56"	(293)	6"	(152)	4.80"	(122)
DBM-1	10.14"	(257)	11.64"	(296)	6"	(152)	4.80"	(122)
DBM-1 1/4	10.25"	(260)	11.75"	(298)	6"	(152)	4.80"	(122)
DBM-1 1/2	10.42"	(265)	11.92"	(303)	6"	(152)	4.80"	(122)
DBM-2	10.66"	(271)	12.16"	(309)	6"	(152)	4.80"	(122)

Part No.	Clamp Part No. †	Weight Each lbs. (kg)
DBM-1/2CT	B3198HCT-1/2	2.75 (1.25)
DBM-3/4CT	B3198HCT-3/4	2.76 (1.25)
DBM-1CT	B3198HCT-1	2.84 (1.29)
DBM-1 1/4CT	B3198HCT-1 1/4	2.95 (1.34)
DBM-1 1/2CT	B3198HCT-1 1/2	2.96 (1.34)
DBM-2CT	B3198HCT-2	3.03 (1.37)
DBM-1/2	B3198H-1/2	2.78 (1.26)
DBM-3/4	B3198H-3/4	2.84 (1.29)
DBM-1	B3198H-1	2.86 (1.30)
DBM-1 1/4	B3198H-1 1/4	2.93 (1.33)
DBM-1 1/2	B3198H-1 1/2	2.99 (1.36)
DBM-2	B3198H-2	3.10 (1.41)



DBM-1

† See Pipe Hanger Catalog for dimensions and specifications. ** From bottom of rubber block to center of pipe/tubing.

*** For Roof Loading, Consult Roofing Manufacturer or Engineer. As with most commercial roofs, the weakest point may be the insulation board beneath the rubber membrane.**

All dimensions in charts and on drawings are in inches. Dimensions shown in parentheses are in millimeters unless otherwise specified.

DURA-BLOK™ Rooftop Supports

DB_DS - Series

**Two (2) Base Supports with Galv. Channel - 1⁵/₈" (41mm) high
Riser Channels (SH Style) - 1⁵/₈" (41mm) x 1⁵/₈" (41mm)
Fittings & Hardware - Electro-Plated Steel**

Dimensions - Height (overall) x Width (overall) x Length (overall)

Material - 100% recycled rubber, UV resistant

Ultimate Load Capacity - 1,000 lbs. (4.45kN) (uniform load) *

DURA-BLOK DB_DS-Series channel support with risers is designed for superior support of piping systems, cable tray, HVAC equipment, walkway systems and many other applications. The DURA-BLOK is UV resistant and suitable for installation on any type of roofing material or other flat surfaces.

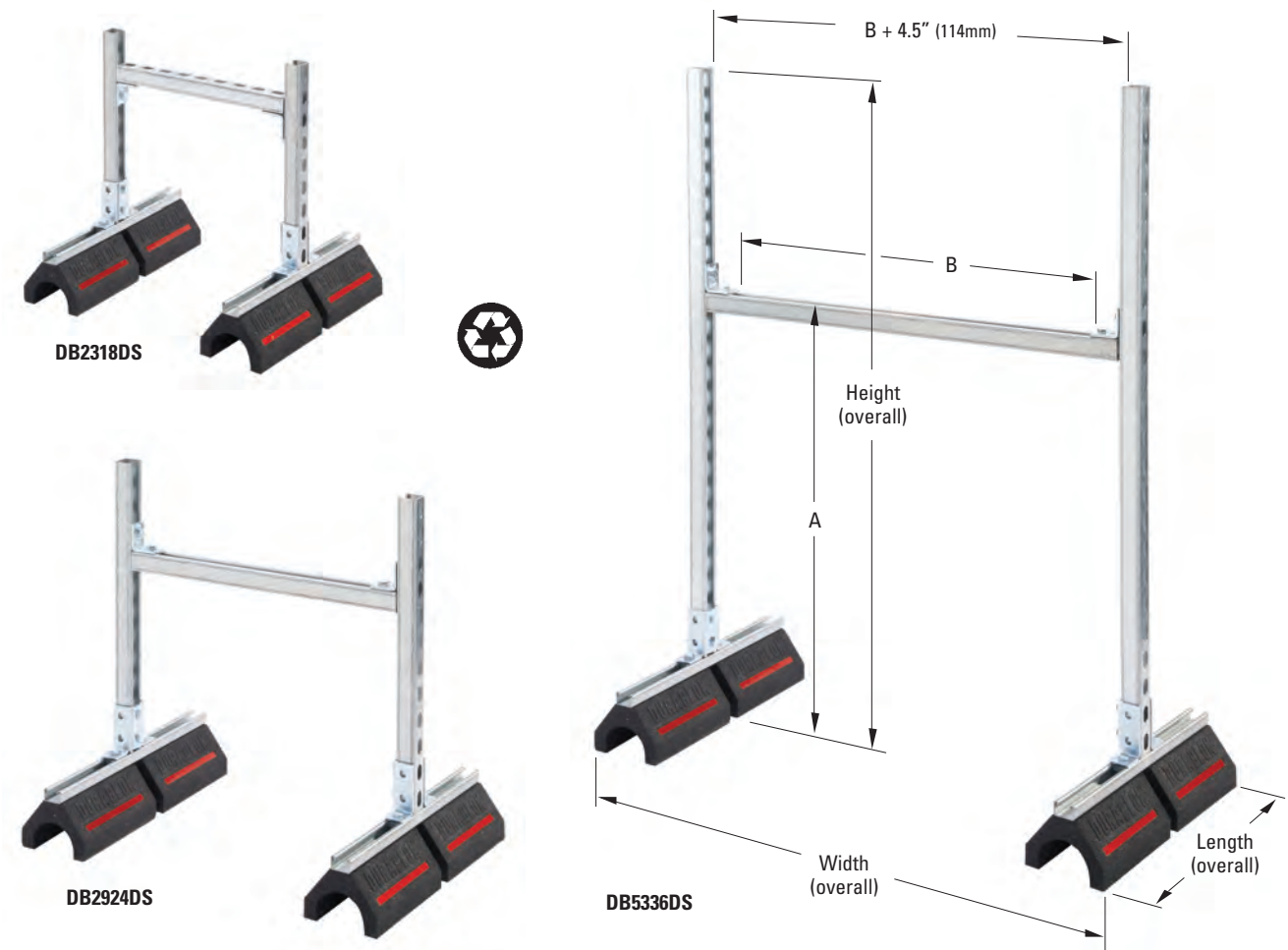

Product is shipped unassembled.

For pipe straps/clamps, rollers and roller supports that can be used with these DURA-BLOK supports, see page 289.

*** For Roof Loading, Consult Roofing Manufacturer or Engineer. As with most commercial roofs, the weakest point may be the insulation board beneath the rubber membrane.**

All dimensions in charts and on drawings are in inches. Dimensions shown in parentheses are in millimeters unless otherwise specified.

Part No.	A (Minimum)		A (Maximum)		B	
	in.	(mm)	in.	(mm)	in.	(mm)
DB2318DS	10.56"	(268)	20.75"	(527)	13.50"	(343)
DB2918DS	10.56"	(268)	26.75"	(679)	13.50"	(343)
DB4118DS	10.56"	(268)	38.75"	(984)	13.50"	(343)
DB5318DS	10.56"	(268)	50.75"	(1289)	13.50"	(343)
DB2324DS	10.56"	(268)	20.75"	(527)	19.50"	(495)
DB2924DS	10.56"	(268)	26.75"	(679)	19.50"	(495)
DB4124DS	10.56"	(268)	38.75"	(984)	19.50"	(495)
DB5324DS	10.56"	(268)	50.75"	(1289)	19.50"	(495)
DB2336DS	10.56"	(268)	20.75"	(527)	31.50"	(800)
DB2936DS	10.56"	(268)	26.75"	(679)	31.50"	(800)
DB4136DS	10.56"	(268)	38.75"	(984)	31.50"	(800)
DB5336DS	10.56"	(268)	50.75"	(1289)	31.50"	(800)
DB2348DS	10.56"	(268)	20.75"	(527)	43.50"	(1105)
DB2948DS	10.56"	(268)	26.75"	(679)	43.50"	(1105)
DB4148DS	10.56"	(268)	38.75"	(984)	43.50"	(1105)
DB5348DS	10.56"	(268)	50.75"	(1289)	43.50"	(1105)

Part No.	Height (overall)		Width (overall)		Length (overall)		Weight Each	
	in.	(mm)	in.	(mm)	in.	(mm)	lbs.	(kg)
DB2318DS	23"	(584)	25 ⁵ / ₈ "	(651)	20.2"	(513)	33.31	(15.11)
DB2918DS	29"	(736)	25 ⁵ / ₈ "	(651)	20.2"	(513)	35.00	(15.88)
DB4118DS	41"	(1041)	25 ⁵ / ₈ "	(651)	20.2"	(513)	38.40	(17.42)
DB5318DS	53"	(1346)	25 ⁵ / ₈ "	(651)	20.2"	(513)	41.80	(18.96)
DB2324DS	23"	(584)	31 ⁵ / ₈ "	(803)	20.2"	(513)	34.15	(15.49)
DB2924DS	29"	(736)	31 ⁵ / ₈ "	(803)	20.2"	(513)	35.84	(16.26)
DB4124DS	41"	(1041)	31 ⁵ / ₈ "	(803)	20.2"	(513)	39.25	(17.80)
DB5324DS	53"	(1346)	31 ⁵ / ₈ "	(803)	20.2"	(513)	42.65	(19.34)
DB2336DS	23"	(584)	43 ⁵ / ₈ "	(1108)	20.2"	(513)	35.84	(16.26)
DB2936DS	29"	(736)	43 ⁵ / ₈ "	(1108)	20.2"	(513)	37.55	(17.03)
DB4136DS	41"	(1041)	43 ⁵ / ₈ "	(1108)	20.2"	(513)	40.95	(18.57)
DB5336DS	53"	(1346)	43 ⁵ / ₈ "	(1108)	20.2"	(513)	44.34	(20.11)
DB2348DS	23"	(584)	55 ⁵ / ₈ "	(1415)	20.2"	(513)	37.55	(17.03)
DB2948DS	29"	(736)	55 ⁵ / ₈ "	(1415)	20.2"	(513)	39.25	(17.80)
DB4148DS	41"	(1041)	55 ⁵ / ₈ "	(1415)	20.2"	(513)	42.65	(19.34)
DB5348DS	53"	(1346)	55 ⁵ / ₈ "	(1415)	20.2"	(513)	46.03	(20.88)

A = Adjustable height from bottom of DURA-BLOK to top of horizontal channel.

B = Space between fittings that support horizontal channel.

Height (overall) = Distance from bottom of DURA-BLOK to top of upright channel.

Width (overall) = Distance from outside-to-outside of DURA-BLOK supports.

Length (overall) = Distance from end-to-end of DURA-BLOK supports.

All dimensions in charts and on drawings are in inches. Dimensions shown in parentheses are in millimeters unless otherwise specified.

DURA-BLOK™ Rooftop Supports

DBR - Series (Fixed Height)

Base with Galv. Channel - 1" (25.4mm) high and Pipe Roller Assembly

Dimensions - Height to Bottom of Pipe x 6" (152mm) Wide x Long (overall length)

Material - 100% recycled rubber, UV resistant

Pipe Roller Material - Cast Iron - Electro Plated

Brackets, Axle, & Hardware - Electro Plated Steel

Ultimate Load Capacity - (uniform load) *

DBR2-3¹/₂ = 500 lbs. (2.22kN)

DBR4-6 = 500 lbs. (2.22kN)

DBR8-10 = 1000 lbs. (4.44kN)

DBR12-14 = 1000 lbs. (4.44kN)

DBR16-20 = 1000 lbs. (4.44kN)



DBR4-6



DBR16-20

DURA-BLOK DBR-Series support is designed to support pipe where longitudinal movement is expected. The DURA-BLOK is UV resistant and approved for installation on any type of roofing material or other flat surfaces.

Part No.	Height **		Width		Length	
	in.	(mm)	in.	(mm)	in.	(mm)
DBR2-3¹/₂	7.09"	(180)	6"	(152)	9.6"	(244)
DBR4-6	7.09"	(180)	6"	(152)	9.6"	(244)
DBR8-10	8.34"	(212)	6"	(152)	20.2"	(513)
DBR12-14	9.38"	(238)	6"	(152)	20.2"	(513)
DBR16-20	9.78"	(248)	6"	(152)	20.2"	(513)

Part No.	Roller Part No. †	Weight Each	
		lbs.	(kg)
DBR2-3¹/₂	B3126-2 to 3 ¹ / ₂	5.28	(2.39)
DBR4-6	B3126-4 to 6	10.63	(4.82)
DBR8-10	B3126-8 to 10	15.99	(7.25)
DBR12-14	B3126-12 to 14	21.34	(9.68)
DBR16-20	B3126-16 to 20	26.70	(12.11)

† See Pipe Hanger Catalog for dimensions and specifications. ** From bottom of rubber block to bottom of pipe/tubing.

*** For Roof Loading, Consult Roofing Manufacturer or Engineer. As with most commercial roofs, the weakest point may be the insulation board beneath the rubber membrane.**

All dimensions in charts and on drawings are in inches. Dimensions shown in parentheses are in millimeters unless otherwise specified.

DBR - Series (Adjustable Height)

Base with two (2) 1/2"-13 Electro Zinc All Threaded Rod Risers and a B3114-3 1/2 Pipe Roll with Sockets

Dimensions - Overall Height 12" (305mm) from bottom of base to pipe contact point on roller.

Base - 4" High (101mm) x 6" (152mm) Wide x 9.6" (244mm) Length (base length)

Material - 100% recycled rubber, UV resistant

Pipe Roll & Sockets - For up to 3 1/2" (90mm) pipe sizes.

Ultimate Load Capacity - 200 lbs. (0.89kN) *

(To increase load capacity use CLDP10 load distribution plate.)



DURA-BLOK DBR-Series support is designed to support pipe up to 3 1/2" (90mm) nominal size where difference in elevation is required and longitudinal movement is expected. The DURA-BLOK is UV resistant and approved for installation on any type of roofing material or other flat surfaces.

Part No.	Adjustable Height		Width		Length		Weight Each	
	in.	(mm)	in.	(mm)	in.	(mm)	lbs.	(kg)
DBR10-12	up to 12"	(up to 305)	6"	(152)	9.6"	(244)	6.46	(2.93)

DBE - Series

Base with two (2) 1/2"-13 Electro Zinc All Threaded Rod Risers and Galv. Channel - 1" (25mm) high

Dimensions - Overall Height as Specified

Base - 4" High (101mm) x 6" (152mm) Wide x 9.6" (244mm) Length (base length)

Material - 100% recycled rubber, UV resistant

Ultimate Load Capacity - 200 lbs. (0.89kN) * (To increase load capacity use CLDP10 load distribution plate.)

DURA-BLOK DBE-Series channel support is designed as a support of piping systems, cable tray, HVAC equipment and many other applications where elevation adjustment is critical. The DURA-BLOK is UV resistant and suitable for installation on any type of roofing material or other flat surfaces.

For pipe straps/clamps, rollers and roller supports that can be used with these DURA-BLOK supports, see page 289.



DBE10-12

Part No.	Adjustable Height		Width		Channel Length		Weight Each	
	in.	(mm)	in.	(mm)	in.	(mm)	lbs.	(kg)
DBE10-8	5 1/2" - 8"	(140 - 203)	6"	(152)	9.35"	(238)	5.68	(2.58)
DBE10-12	5 1/2" - 12"	(140 - 305)	6"	(152)	9.35"	(238)	5.72	(2.59)
DBE10-16	5 1/2" - 16"	(140 - 406)	6"	(152)	9.35"	(238)	5.76	(2.61)

** Longer base lengths available.

Note: At heights above 12" (305mm), we suggest using the DB_DS Series Channel Support with Risers for additional stability to piping system.

*** For Roof Loading, Consult Roofing Manufacturer or Engineer. As with most commercial roofs, the weakest point may be the insulation board beneath the rubber membrane.**

DURA-BLOK™ Rooftop Supports

CLDP10 - Load Distribution Plate

Steel Plate with Slots

Dimensions - 1⁵/₈" (41mm) Wide x 6¹/₂" (65mm) Long

Material - 11 Ga. steel (3.0mm)

Increases ultimate uniform load capacity on DBE & DBR Series supports to 500 lbs. (2.22kN)

DURA-BLOK CLDP10 load bearing stabilizer plate increases load ratings for DBE Series and DBR Series supports by allowing the load from the threaded rods to be distributed over the length of the base instead of the point load where the rods attach to the base.



Loosen hex nuts and slide plate under the flat washers



Retighten the hex nuts with plate in place

Part No.	Adjustable Height		Width in. (mm)	Length in. (mm)	Weight Each lbs. (kg)
	in.	(mm)			
CLDP10	11 Ga.	(3.05)	1 ⁵ / ₈ " (41)	9 ¹ / ₂ " (241)	0.53 (0.24)

Compatible Components Available to make DURA-BLOK bases more versatile

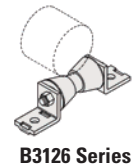
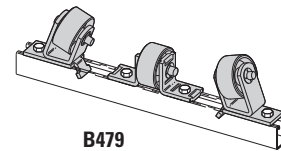
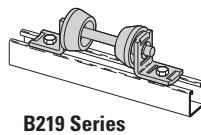
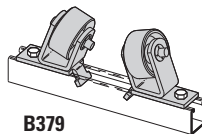
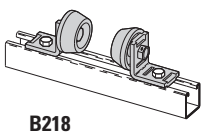
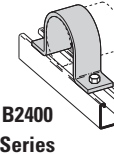
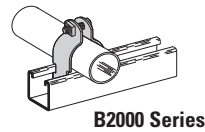
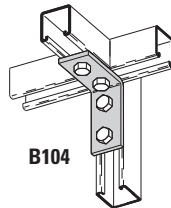
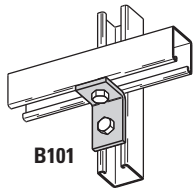
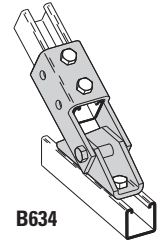
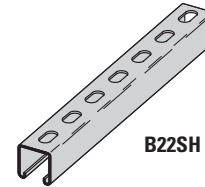
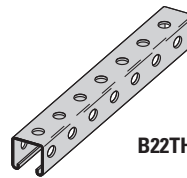
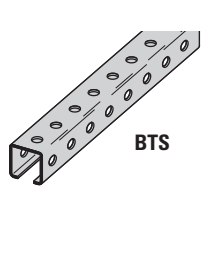

Above rollers can be mounted on DB Series, DB6 Series, and DB10 Series units.

All dimensions in charts and on drawings are in inches. Dimensions shown in parentheses are in millimeters unless otherwise specified.

Rooftop Support Specification

SECTION 07720

ROOFTOP SUPPORT SYSTEMS

(Applicable to Section 15060 (Mechanical) and Section 16070 (Electrical))

PART 1 GENERAL

1.01 SECTION INCLUDES

- A. The work covered by this specification consists of furnishing all labor, equipment, materials and accessories, and performing all operations required for the correct installation of recycled rubber pipe [conduit] supports for mechanical piping [electrical conduit] systems.

1.02 REFERENCES

- A. ASTM A653 G90 SS Gr. 33 - Specification for Steel Sheet, Zinc Coated (Galvanized) by the Hot Dipped Process
- B. ASTM B633 - Specification for Electrodeposited Coatings of Zinc on Iron and Steel
- C. ASTM C531 – Test Method for Linear Shrinkage and Coefficient of Thermal Expansion of Chemical Resistant Mortars, Grouts, Monolithic Surfaces, and Polymer Concretes
- D. ASTM C642 – Test Method for Specific Gravity, Absorption, and Voids in Hardened Concrete
- E. ASTM C672 – Test Methods for Scaling Resistance of Concrete Surfaces Exposed to Deicing Chemicals
- F. ASTM D412 – Test Methods for Vulcanized Rubber and Thermoplastic Elastomers – Tension
- G. ASTM D395 – Standard Test Methods for Rubber Property – Compression Set
- H. ASTM D573 – Test Method for Rubber – Deterioration in an Air Oven
- I. ASTM D746 – Test Method for Brittleness Temperature of Plastics and Elastomers by Impact
- J. ASTM D2240 – Test Method for Rubber Property – Durometer Hardness
- K. NFPA 70 – National Electrical Code

1.03 QUALITY ASSURANCE

- A. Rubber / steel pipe supports shall be manufactured under a strict quality control program assuring quality product delivered to the jobsite. Pipe supports that are damaged shall not be installed.
- B. Workmanship: All pipe [conduit] supports to be installed by a qualified piping [electrical] contractor and installed in accordance with manufacturer's recommendations.
 1. All work shall comply with all applicable federal, state, and local codes and laws having jurisdiction.
 2. All work shall conform to accepted industry and trade standards for pipe support [conduit] installations.

PART 2 PRODUCTS

2.01 ACCEPTABLE MANUFACTURERS

- A. Manufacturer: Subject to compliance with these specifications, pipe support systems shall be DURA-BLOK™ design as supplied by Eaton B-Line Business [or engineer approved equal].

2.02 MATERIALS

- A. Curb base must be made of 100% recycled rubber and polyurethane prepolymer with a uniform load capacity of 500 pounds per linear foot of support*. In addition, each base to have a reflective red stripe.
(*See 3.01(C))
- B. Dimensions: 6-inches wide by [4] [5.0] [6.75] inches tall by [9.6] [20.2] [30.8] [41.4] [52.0] inches long.
- C. Steel frame: Steel, 14ga strut galvanized per ASTM A653 or 12ga strut galvanized per ASTM A653 for bridge series.
- D. Attaching hardware: Zinc-plated threaded rod, nuts and attaching hardware per ASTM B633.

DURA-BLOK™ Rooftop Supports

GRATEWALK™ Rooftop Walkway with Integrated DURA-BLOK™ Supports

B-Line series GRATEWALK™ Rooftop Walkways with DURA-BLOK™ provides the optimal solution to extend the life of your roof, while providing a safe pathway to roof mounted support equipment.

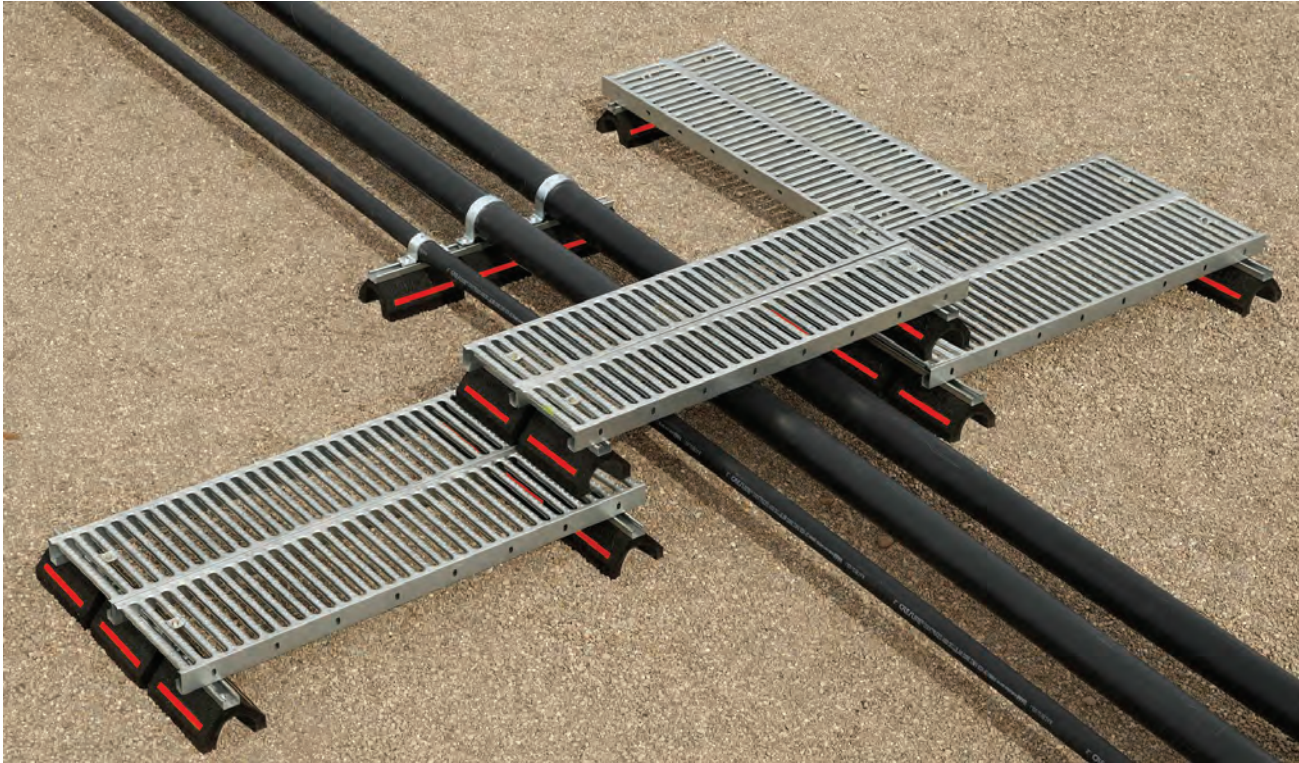

Features & Benefits of the GRATEWALK Rooftop Walkway

- Available with slip resistant GRATE-LOCK™, helping provide a safe walkway for foot traffic on the roof.
- Easy to install, elevated design, creates an identifiable path for foot traffic helping prevent wear and tear to the roof surface.
- The cross-over design offers safe passage over existing cabling, piping, cable tray or any other interference on the rooftop.
- The self cleaning pattern allows water and dirt to easily flow through, helping make the grating an ideal walkway in all weather conditions.
- Handrail options are available
- Integrated with 100% post-consumer recycled rubber supporting LEED credit qualification.
- Provide solid support for the walkway that stays in place and replaces the need for separate rubber roof mounting pads which tend to float away.

All dimensions in charts and on drawings are in inches. Dimensions shown in parentheses are in millimeters unless otherwise specified.

GRATEWALK™ Rooftop Walkway with Integrated DURA-BLOK™ Supports

The GRATEWALK™ Rooftop Walkway with Integrated DURA-BLOK™ Supports* is available in a variety of configurations.

- Straight sections for long straight stretches of pathway
- Cross-over options to install over the existing cable trays, piping, and more
- Stairways over the top of existing equipment or leading up to existing equipment
- Handrail options available for additional walkway safety and support
- Platforms to provide access to rooftop mounted equipment
- Accessories available to support unique requirements

* All Items are shipped individually for field assembly.



Engineering Design Service

- Take-off and estimating
- Specification review and development
- Alternative layout designs
- Technical consultation
- Submittal drawing packages (see Figure A) including assembly instructions

