

Commercial grade straight blade duplex receptacles

| | |
|-----------------|--------------|
| Project Name: | Prepared By: |
| Project Number: | Date: |
| Catalog Number: | Type: |

Description

2-Pole, 3-Wire Grounding
 15A 125V/AC; 15A 250V/AC
 20A 125V/AC; 20A 250V/AC
 NEMA 5-15, 5-20, 6-15, 6-20



5-15R



5-20R



6-15R



6-20R



BR15



CR20



1877

Design features

- Galvanized steel, wrap-around yoke mounting strap for superior assembly security; extra length/width helps reach large panel cutouts for Code Compliance
- Automatic grounding system eliminates need for bonding jumper in grounded metal enclosure, provides redundant measure of ground continuity where jumper used
- Screw-Catch feature on duplex devices speeds mounting of wallplates
- Tamper Resistant receptacles provide compliance with 2014 NEC® Article 406.12 that states that all 15A & 20A, 125V receptacles installed in dwelling units must be tamper resistant

Table 1. Commercial Grade Receptacles

| Catalog No. | Description | Amps | Volts | Color Suffix |
|---------------------------------|--|------|-------|----------------------------|
| <input type="checkbox"/> BR15__ | NEMA 5-15R Duplex Receptacle, Back & Side Wire | 15 | 125 | A, B, BK, GY, LA, V, W |
| <input type="checkbox"/> CR15__ | NEMA 5-15R Duplex Receptacle, Side Wire | 15 | 125 | A, B, BK, GY, LA, V, W |
| <input type="checkbox"/> 817__ | NEMA 5-15R Single Receptacle, Side Wire | 15 | 125 | B, BK, LA, V, W |
| <input type="checkbox"/> BR20__ | NEMA 5-20R Duplex Receptacle, Back & Side Wire | 20 | 125 | A, B, BK, GY, LA, RD, V, W |
| <input type="checkbox"/> CR20__ | NEMA 5-20R Duplex Receptacle, Side Wire | 20 | 125 | A, B, BK, GY, LA, V, W |
| <input type="checkbox"/> 1877__ | NEMA 5-20R Single Receptacle, Side Wire | 20 | 125 | A, B, BK, LA, V, W |
| <input type="checkbox"/> 826__ | NEMA 6-15R Duplex Receptacle, Side Wire | 15 | 250 | B, V, W |
| <input type="checkbox"/> 816__ | NEMA 6-15R Single Receptacle, Side Wire | 15 | 250 | B, V, W |
| <input type="checkbox"/> 815__ | NEMA 6-20R Duplex Receptacle, Side Wire | 20 | 250 | B, V, W |
| <input type="checkbox"/> 1876__ | NEMA 6-20R Single Receptacle, Side Wire | 20 | 250 | A, B, BK, LA, V, W |

Compliances, specifications and availability are subject to change without notice.



Powering Business Worldwide

| | |
|-----------------|--------------|
| Project Name: | Prepared By: |
| Project Number: | Date: |
| Catalog Number: | Type: |



TR817



Table 2. Dual Voltage Commercial Grade Receptacles, Side Wire

| Catalog No. | Description | Amps | Volts | Color |
|-------------|--|------|-------------|-------|
| □ 829V | NEMA 5-15R/6-15R Dual Voltage Duplex Receptacle, Side Wire | 15 | 125/ 250 | V |

Table 3. Commercial Grade Tamper Resistant Receptacles

| Catalog No. | Description | Amps | Volts | Color Suffix |
|-------------|---|------|-------|----------------------------|
| □ TRBR15__ | NEMA 5-15R Tamper Resistant Duplex Receptacle, Back & Side Wire | 15 | 125 | A, B, BK, GY, LA, V, W |
| □ TRCR15__ | NEMA 5-15R Tamper Resistant Duplex Receptacle, Side Wire | 15 | 125 | A, B, BK, GY, LA, V, W |
| □ TR817__ | NEMA 5-15R Single Receptacle, Side Wire | 15 | 125 | A, B, BK, LA, V, W |
| □ TRBR20__ | NEMA 5-20R Tamper Resistant Duplex Receptacle, Back & Side Wire | 20 | 125 | A, B, BK, GY, LA, RD, V, W |
| □ TRCR20__ | NEMA 5-20R Tamper Resistant Duplex Receptacle, Side Wire | 20 | 125 | A, B, BK, GY, LA, V, W |
| □ TR1877__ | NEMA 5-20 Single Receptacle, Side Wire | 20 | 125 | A, B, BK, LA, V, W |

| | |
|-----------------|--------------|
| Project Name: | Prepared By: |
| Project Number: | Date: |
| Catalog Number: | Type: |

Applications

Commercial grade duplex receptacles are challenged on a daily basis to provide a consistent, reliable means of connectivity in a wide variety of environments. The applications vary greatly by environment, and provide challenges from impact and chemical resistance to environmental extremes such as heat and moisture. The breadth of the Arrow Hart Straight Blade Receptacle line provides solutions for all environments and applications.

Table 4. Specifications

| Catalog No. | BR15, BR20, Series | CR15, CR20 Series | 815, 826 Series |
|--------------------------------------|--|--|--|
| Device Type | Straight Blade Duplex Receptacles, BR Series | Straight Blade Duplex Receptacles, CR Series | Straight Blade Duplex Receptacles |
| Wiring Type | Back & side wire | Side wire | Side wire |
| Testing & Code Compliance | <ul style="list-style-type: none"> cULus Listed to UL 498, file no. E15058 CSA Certified to C22.2, no. 42, file no. 6914, class 6233-01 UL verified to Federal Spec. WC-596G NOM certified | <ul style="list-style-type: none"> cULus Listed to UL 498, file no. E15058 UL verified to Federal Spec. WC-596G NOM certified | <ul style="list-style-type: none"> cULus Listed to UL 498, file no. E15058 UL verified to Federal Spec. WC-596G NOM certified |
| Environmental Specifications | Flammability: Meets UL 94 requirements; V2 rated Temperature Rating: -20°C to 60°C (-4°F to 140°F) | Flammability: Meets UL 94 requirements; V2 rated Temperature Rating: -20°C to 60°C (-4°F to 140°F) | Flammability: Meets UL 94 requirements; V2 rated Temperature Rating: -20°C to 60°C (-4°F to 140°F) |
| Electrical Specifications | Dielectric Voltage: Withstands 2000V per UL 498 Current Interrupting: Yes, at full-rated current Temperature Rise: Max. 30°C (86°F) after 100 cycles of overload @ 150% of rated current (DC) | Dielectric Voltage: Withstands 2000V per UL 498 Current Interrupting: Yes, at full-rated current Temperature Rise: Max. 30°C (86°F) after 100 cycles of overload @ 150% of rated current (DC) | Dielectric Voltage: Withstands 2000V per UL 498 Current Interrupting: Yes, at full-rated current Temperature Rise: Max. 30°C (86°F) after 100 cycles of overload VVV@ 150% of rated current (DC) |
| Mechanical Specifications | Terminal Accommodation: #14 - 10 AWG Voltage Ratings: Permanently marked on device | Terminal Accommodation: #14 - 10 AWG Voltage Ratings: Permanently marked on device | Terminal Accommodation: #14 - 10 AWG Voltage Ratings: Permanently marked on device |

Table 5. Materials

| Catalog No. | BR15, BR20, Series | CR15, CR20 Series | 815, 826 Series |
|----------------------------------|-------------------------------|---|-------------------------------|
| Top Housing | Nylon | PVC | PC |
| Bottom Housing | PVC | PVC | PC |
| Strap | 0.046" thick galvanized steel | 0.040" thick galvanized steel | 0.040" thick galvanized steel |
| Ground Contact | 0.030" thick brass | 0.030" thick brass | 0.030" thick brass |
| Auto Ground | Phosphor bronze staple | Phosphor bronze staple | Phosphor bronze staple |
| Line Contacts | .030" thick 3-leaf brass | .030" thick 3-leaf neutral/2-leaf hot brass | .030" thick 3-leaf brass |
| Terminal Screws | #8-32 Steel brass plated hot | #8-32 Steel brass plated hot | #8-32 Steel brass plated hot |
| Ground Screw | #8-32 Steel (Green) | #8-32 Steel (Green) | #8-32 Steel (Green) |
| Tamper Resistant Shutters | N/A | N/A | N/A |

| | |
|-----------------|--------------|
| Project Name: | Prepared By: |
| Project Number: | Date: |
| Catalog Number: | Type: |

Table 6. Specifications

| Catalog No. | 829 Series | 817, 1877 Series | 816, 1876 Series |
|--------------------------------------|--|--|--|
| Device Type | Straight Blade Dual Voltage Duplex Receptacles | Straight Blade Single Receptacles | Straight Blade Single Receptacles |
| Wiring Type | Side wire | Side wire | Side wire |
| Testing & Code Compliance | <ul style="list-style-type: none"> UL Listed to UL 498, file no. E15058 CSA Certified to C22.2, no. 42, file no. 6914, class 6233-01 NOM certified | <ul style="list-style-type: none"> UL Listed to UL 498, file no. E15058 CSA Certified to C22.2, no. 42, file no. 6914, class 6233-01 NOM certified | <ul style="list-style-type: none"> cULus Listed to UL 498, file no. E15058 NOM certified |
| Environmental Specifications | Flammability: Meets UL 94 requirements; V2 rated Temperature Rating: -20°C to 60°C (-4°F to 140°F) | Flammability: Meets UL 94 requirements; V2 rated Temperature Rating: -20°C to 60°C (-4°F to 140°F) | Flammability: Meets UL 94 requirements; V2 rated Temperature Rating: -20°C to 60°C (-4°F to 140°F) |
| Electrical Specifications | Dielectric Voltage: Withstands 2000V per UL 498 Current Interrupting: Yes, at full-rated current Temperature Rise: Max. 30°C (86°F) after 100 cycles of overload @ 150% of rated current (DC) | Dielectric Voltage: Withstands 2000V per UL 498 Current Interrupting: Yes, at full-rated current Temperature Rise: Max. 30°C (86°F) after 100 cycles of overload @ 150% of rated current (DC) | Dielectric Voltage: Withstands 2000V per UL 498 Current Interrupting: Yes, at full-rated current Temperature Rise: Max. 30°C (86°F) after 100 cycles of overload WW@ 150% of rated current (DC) |
| Mechanical Specifications | Terminal Accommodation: #14 - 10 AWG Voltage Ratings: Permanently marked on device | Terminal Accommodation: #14 - 10 AWG Voltage Ratings: Permanently marked on device | Terminal Accommodation: #14 - 10 AWG Voltage Ratings: Permanently marked on device |

Table 7. Materials

| Catalog No. | 829 Series | 817, 1877 Series | 816, 1876 Series |
|----------------------------------|---|-------------------------------|-------------------------------|
| Top Housing | PC | PVC | Nylon |
| Bottom Housing | PC | PVC | PVC |
| Strap | 0.040" thick galvanized steel | 0.040" thick galvanized steel | 0.040" thick galvanized steel |
| Ground Contact | 0.030" thick brass | 0.030" thick brass | 0.030" thick brass |
| Auto Ground | Phosphor bronze staple | N/A | N/A |
| Line Contacts | .030" thick 3-leaf neutral/2-leaf hot brass | .030" thick 3-leaf brass | .030" thick 3-leaf brass |
| Terminal Screws | #8-32 Steel brass plated hot | #8-32 Steel brass plated hot | #8-32 Steel brass plated hot |
| Ground Screw | #8-32 Steel (Green) | #8-32 Steel (Green) | #8-32 Steel (Green) |
| Tamper Resistant Shutters | N/A | N/A | N/A |

| | |
|-----------------|--------------|
| Project Name: | Prepared By: |
| Project Number: | Date: |
| Catalog Number: | Type: |

Table 8. Specifications

| Catalog No. | TRBR15, TRCR15, TRBR20, TRCR20 Series | TR817, TR1877 Series |
|--------------------------------------|--|--|
| Device Type | Tamper Resistant Straight Blade Duplex Receptacles | Tamper Resistant Straight Blade Single Receptacles |
| Wiring Type | Back & side wire (TRCR side wire only) | Side wire |
| Testing & Code Compliance | <ul style="list-style-type: none"> • cULus Listed to UL 498, file no. E15058 • UL verified to Federal Spec. WVC-596G (TRBR only) • NOM certified | <ul style="list-style-type: none"> • cULus Listed to UL 498, file no. E15058 • NOM certified |
| Environmental Specifications | Flammability: Meets UL 94 requirements; V2 rated Temperature Rating: -20°C to 60°C (-4°F to 140°F) | Flammability: Meets UL 94 requirements; V2 rated Temperature Rating: -20°C to 60°C (-4°F to 140°F) |
| Electrical Specifications | Dielectric Voltage: Withstands 2000V per UL 498 Current Interrupting: Yes, at full-rated current Temperature Rise: Max. 30°C (86°F) after 100 cycles of overload @ 150% of rated current (DC) | Dielectric Voltage: Withstands 2000V per UL 498 Current Interrupting: Yes, at full-rated current Temperature Rise: Max. 30°C (86°F) after 100 cycles of overload @ 150% of rated current (DC) |
| Mechanical Specifications | Terminal Accommodation: #14 - 10 AWG Voltage Ratings: Permanently marked on device | Terminal Accommodation: #14 - 10 AWG Voltage Ratings: Permanently marked on device |

Table 9. Materials

| Catalog No. | TRBR15, TRCR15, TRBR20, TRCR20 Series | TR817, TR1877 Series |
|----------------------------------|---|-----------------------------------|
| Top Housing | PVC | PVC |
| Bottom Housing | PVC | PVC |
| Strap | 0.040" thick galvanized steel | 0.040" thick galvanized steel |
| Ground Contact | 0.030" thick brass | 0.030" thick brass |
| Auto Ground | Phosphor bronze staple | Phosphor bronze staple |
| Line Contacts | .030" thick 3-leaf neutral/2-leaf hot brass | .030" thick 3-leaf brass |
| Terminal Screws | #8-32 Steel brass plated hot | #8-32 Steel brass plated hot |
| Ground Screw | #8-32 Steel (Green) | #8-32 Steel (Green) |
| Tamper Resistant Shutters | Reliable Delrin® shutter assembly | Reliable Delrin® shutter assembly |

Table 10. Color Ordering Information

For ordering devices, include Cat. No. followed by the color code: A (Almond), B (Brown), BK (Black), GY (Gray) LA (Light Almond), RD (Red), V (Ivory), W (White)

| | | | | | | | |
|--------|-------|-------|------|------------|-----|-------|-------|
| A | B | BK | GY | LA | RD | V | W |
| Almond | Brown | Black | Gray | Lt. Almond | Red | Ivory | White |

| | |
|-----------------|--------------|
| Project Name: | Prepared By: |
| Project Number: | Date: |
| Catalog Number: | Type: |

Product Dimensions

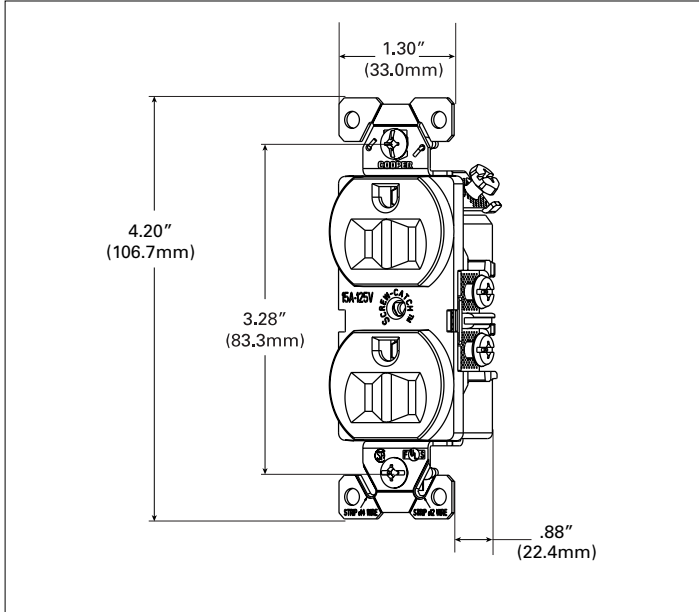

Figure 1. BR15 Line Art with Dimensions

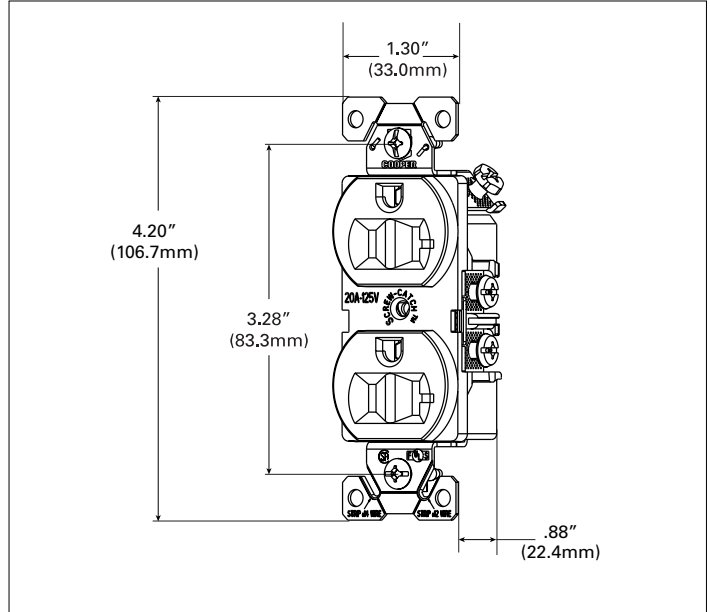

Figure 2. BR20 Line Art with Dimensions

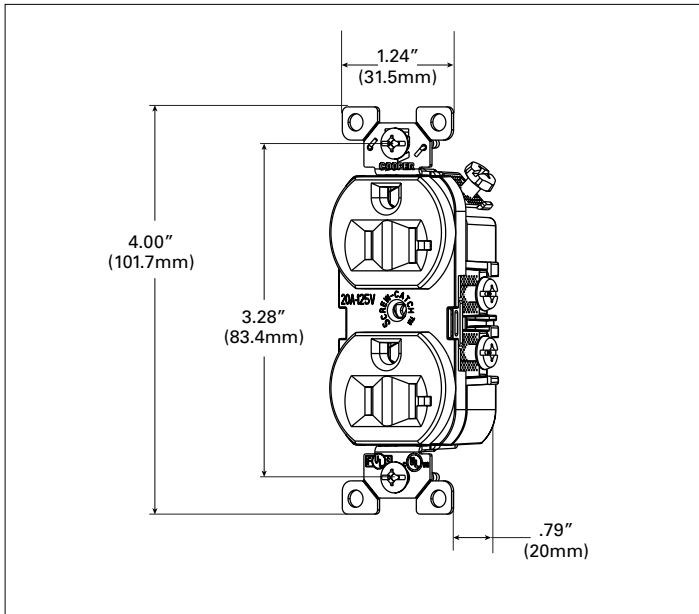

Figure 3. CR20 Line Art with Dimensions

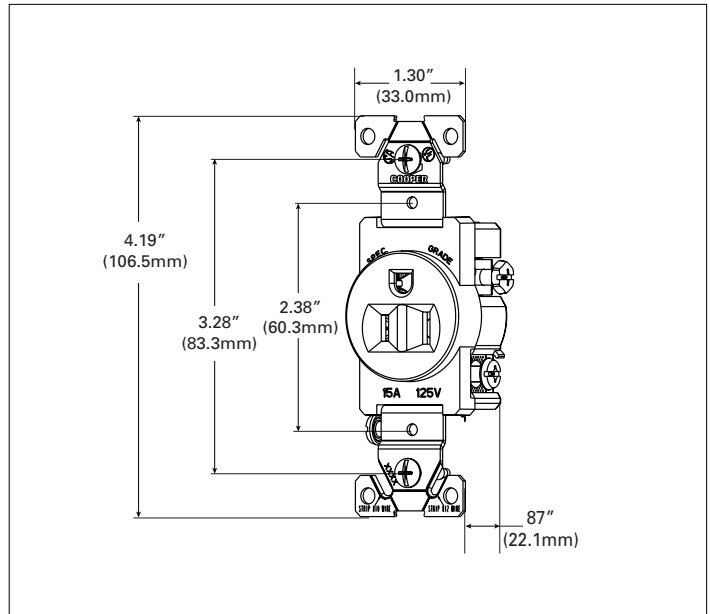

Figure 4. 817 Line Art with Dimensions

| | |
|-----------------|--------------|
| Project Name: | Prepared By: |
| Project Number: | Date: |
| Catalog Number: | Type: |

Product Dimensions

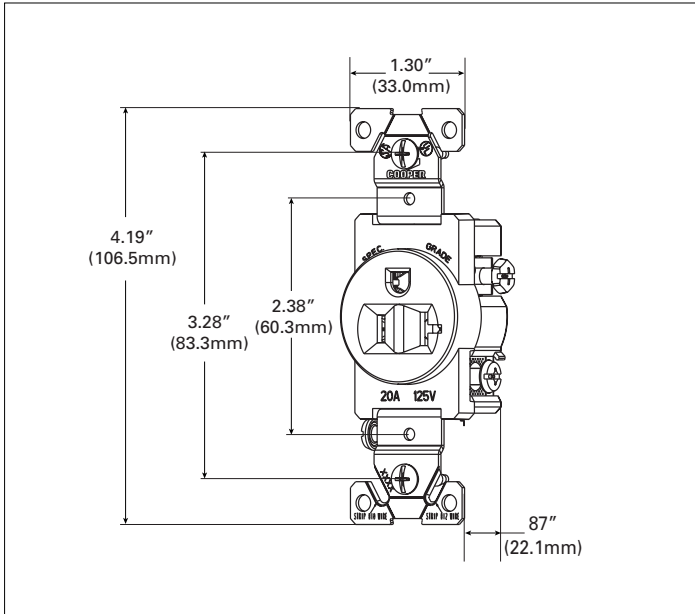

Figure 5. 1877 Line Art with Dimensions

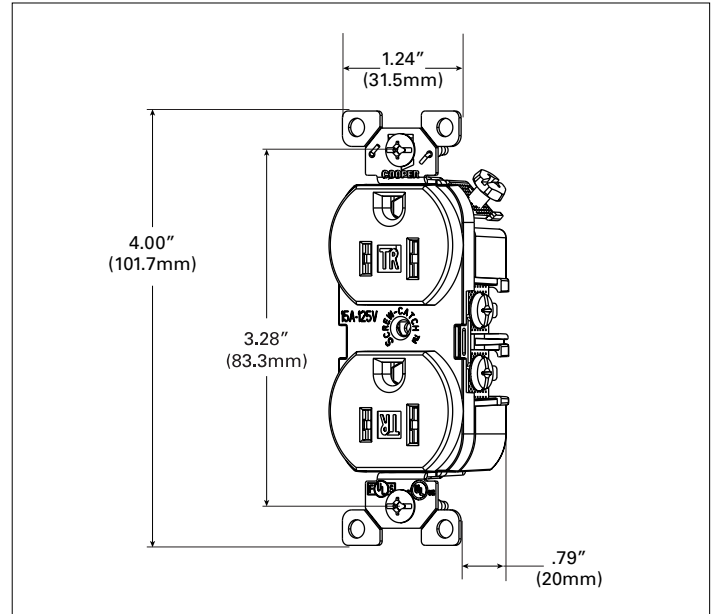

Figure 6. TRBR15 Line Art with Dimensions

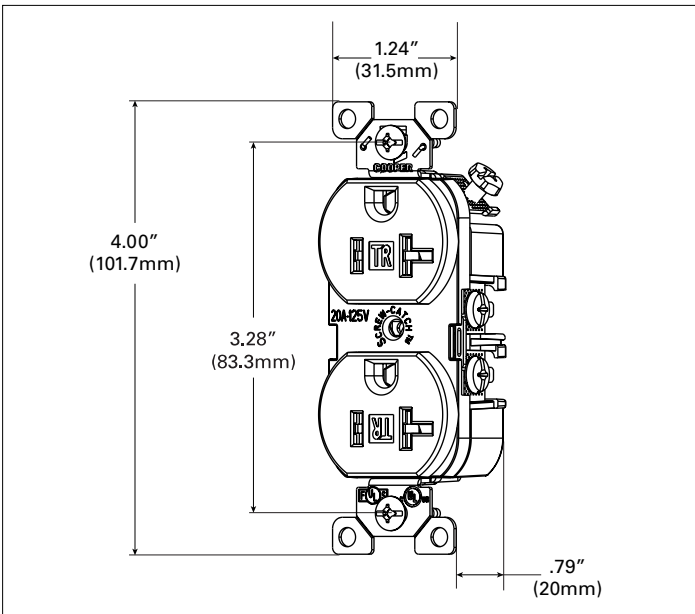

Figure 7. TRBR20 Line Art with Dimensions

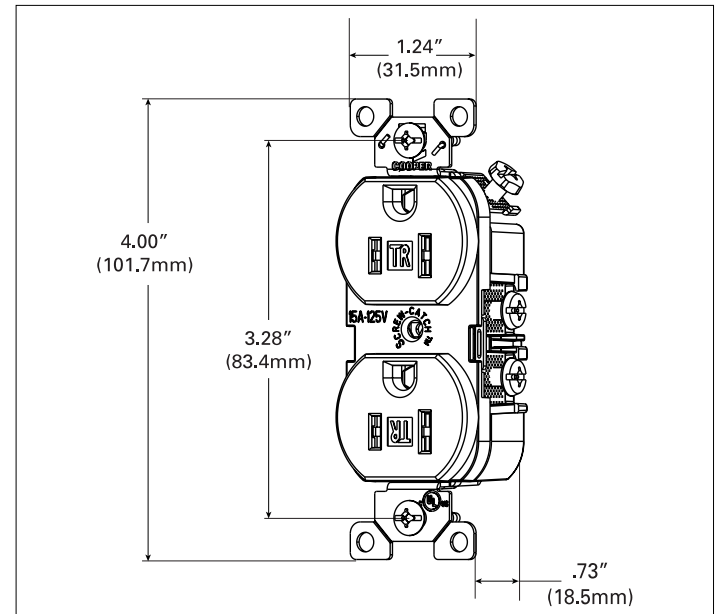

Figure 8. TRCR15 Line Art with Dimensions

| | |
|-----------------|--------------|
| Project Name: | Prepared By: |
| Project Number: | Date: |
| Catalog Number: | Type: |

Product Dimensions

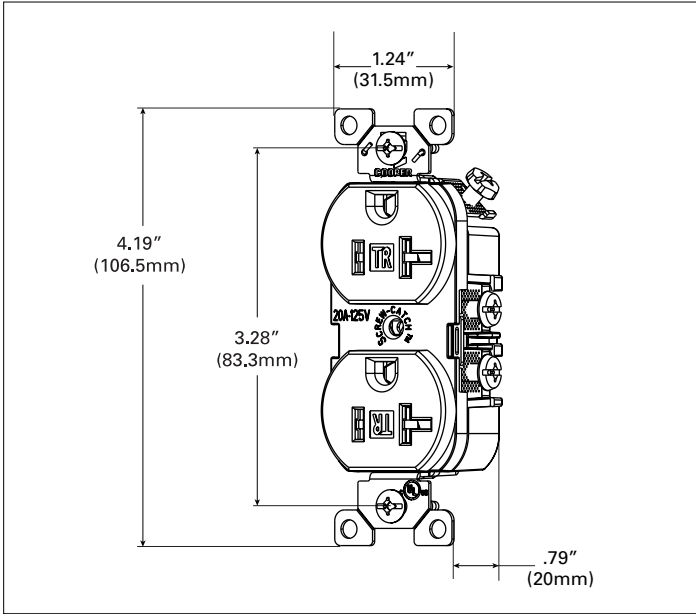

Figure 9. TRCR20 Line Art with Dimensions

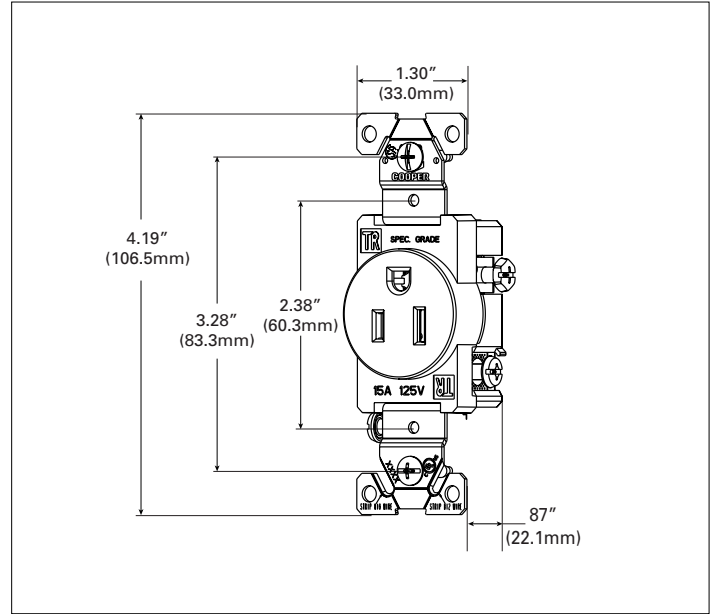

Figure 10. TR817 Line Art with Dimensions

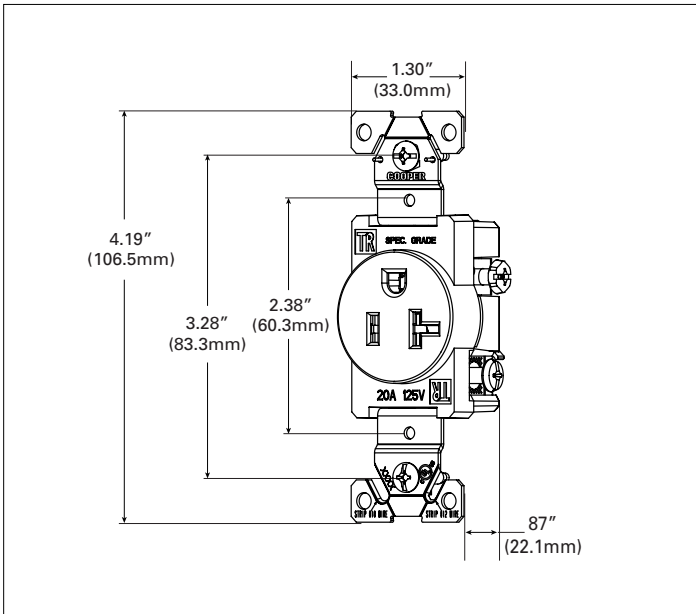

Figure 11. TR1877 Line Art with Dimensions

| | |
|-----------------|--------------|
| Project Name: | Prepared By: |
| Project Number: | Date: |
| Catalog Number: | Type: |

Certifications & compliances

| Catalog No. | | | | | | | | | |
|-------------|---|---|---|---|---|---|---|---|---|
| BR15 | • | • | • | • | • | • | • | • | • |
| CR15 | • | | • | | | • | | • | • |
| 817 | | • | | • | • | • | | • | • |
| BR20 | • | • | • | • | • | • | • | • | • |
| CR20 | • | | • | | | • | | • | • |
| 1877 | | • | | • | • | • | | • | • |
| 826 | • | | • | | | • | | • | • |
| 816 | • | | • | | | • | | • | • |
| 815 | • | • | • | | • | • | | • | • |
| 1876 | • | | • | | | • | | • | • |
| 829 | | • | • | | • | • | | • | • |
| TRBR15 | • | | • | | | • | • | • | • |
| TRCR15 | • | | | | | • | | • | • |
| TR817 | • | | • | | | • | | • | • |
| TRBR20 | • | | • | | | • | • | • | • |
| TRCR20 | • | | | | | • | | • | • |
| TR1877 | • | | | | | • | | • | • |

KEY: cULus UL Fed Spec NAFTA CSA
 NOM Arrowlink Build-To-Spec ROHS

Parts are manufactured and designed in accordance with article 4 of the European Union's RoHS2 directive 2011/65/EU

Build-To-Spec Customizable Devices

Compliances, specifications and availability are subject to change without notice.

Electrical Sector
203 Cooper Circle
Peachtree City, GA 30269
United States
Eaton.com
Eaton.com/arrowhart

Electrical Sector
Canada Operations
5925 McLaughlin Road
Mississauga, Ontario, L5R 1B8
Canada
EatonCanada.ca
Eaton.com/arrowhart

Electrical Sector
Mexico Operations
Carr. Tlalnepantla -
Cuautitlan Km 17.8 s/n
Col. Villa Jardin esq.
Cerrada 8 de Mayo
Cuautitlan, Mexico CP 54800
Mexico
Eaton.mx
Eaton.com/arrowhart

Commercial grade straight blade duplex receptacles

| | |
|-----------------|--------------|
| Project Name: | Prepared By: |
| Project Number: | Date: |
| Catalog Number: | Type: |

Description

2-Pole, 3-Wire Grounding
 15A 125V/AC; 15A 250V/AC
 20A 125V/AC; 20A 250V/AC
 NEMA 5-15, 5-20, 6-15, 6-20



5-15R



5-20R



6-15R



6-20R



BR15



CR20



1877

Design features

- Galvanized steel, wrap-around yoke mounting strap for superior assembly security; extra length/width helps reach large panel cutouts for Code Compliance
- Automatic grounding system eliminates need for bonding jumper in grounded metal enclosure, provides redundant measure of ground continuity where jumper used
- Screw-Catch feature on duplex devices speeds mounting of wallplates
- Tamper Resistant receptacles provide compliance with 2014 NEC® Article 406.12 that states that all 15A & 20A, 125V receptacles installed in dwelling units must be tamper resistant

Table 1. Commercial Grade Receptacles

| Catalog No. | Description | Amps | Volts | Color Suffix |
|---------------------------------|--|------|-------|----------------------------|
| <input type="checkbox"/> BR15__ | NEMA 5-15R Duplex Receptacle, Back & Side Wire | 15 | 125 | A, B, BK, GY, LA, V, W |
| <input type="checkbox"/> CR15__ | NEMA 5-15R Duplex Receptacle, Side Wire | 15 | 125 | A, B, BK, GY, LA, V, W |
| <input type="checkbox"/> 817__ | NEMA 5-15R Single Receptacle, Side Wire | 15 | 125 | B, BK, LA, V, W |
| <input type="checkbox"/> BR20__ | NEMA 5-20R Duplex Receptacle, Back & Side Wire | 20 | 125 | A, B, BK, GY, LA, RD, V, W |
| <input type="checkbox"/> CR20__ | NEMA 5-20R Duplex Receptacle, Side Wire | 20 | 125 | A, B, BK, GY, LA, V, W |
| <input type="checkbox"/> 1877__ | NEMA 5-20R Single Receptacle, Side Wire | 20 | 125 | A, B, BK, LA, V, W |
| <input type="checkbox"/> 826__ | NEMA 6-15R Duplex Receptacle, Side Wire | 15 | 250 | B, V, W |
| <input type="checkbox"/> 816__ | NEMA 6-15R Single Receptacle, Side Wire | 15 | 250 | B, V, W |
| <input type="checkbox"/> 815__ | NEMA 6-20R Duplex Receptacle, Side Wire | 20 | 250 | B, V, W |
| <input type="checkbox"/> 1876__ | NEMA 6-20R Single Receptacle, Side Wire | 20 | 250 | A, B, BK, LA, V, W |

Compliances, specifications and availability are subject to change without notice.



Powering Business Worldwide

| | |
|-----------------|--------------|
| Project Name: | Prepared By: |
| Project Number: | Date: |
| Catalog Number: | Type: |



TR817

Table 2. Dual Voltage Commercial Grade Receptacles, Side Wire

| Catalog No. | Description | Amps | Volts | Color |
|-------------|--|------|-------------|-------|
| □ 829V | NEMA 5-15R/6-15R Dual Voltage Duplex Receptacle, Side Wire | 15 | 125/ 250 | V |

Table 3. Commercial Grade Tamper Resistant Receptacles

| Catalog No. | Description | Amps | Volts | Color Suffix |
|-------------|---|------|-------|----------------------------|
| □ TRBR15__ | NEMA 5-15R Tamper Resistant Duplex Receptacle, Back & Side Wire | 15 | 125 | A, B, BK, GY, LA, V, W |
| □ TRCR15__ | NEMA 5-15R Tamper Resistant Duplex Receptacle, Side Wire | 15 | 125 | A, B, BK, GY, LA, V, W |
| □ TR817__ | NEMA 5-15R Single Receptacle, Side Wire | 15 | 125 | A, B, BK, LA, V, W |
| □ TRBR20__ | NEMA 5-20R Tamper Resistant Duplex Receptacle, Back & Side Wire | 20 | 125 | A, B, BK, GY, LA, RD, V, W |
| □ TRCR20__ | NEMA 5-20R Tamper Resistant Duplex Receptacle, Side Wire | 20 | 125 | A, B, BK, GY, LA, V, W |
| □ TR1877__ | NEMA 5-20 Single Receptacle, Side Wire | 20 | 125 | A, B, BK, LA, V, W |

| | |
|-----------------|--------------|
| Project Name: | Prepared By: |
| Project Number: | Date: |
| Catalog Number: | Type: |

Applications

Commercial grade duplex receptacles are challenged on a daily basis to provide a consistent, reliable means of connectivity in a wide variety of environments. The applications vary greatly by environment, and provide challenges from impact and chemical resistance to environmental extremes such as heat and moisture. The breadth of the Arrow Hart Straight Blade Receptacle line provides solutions for all environments and applications.

Table 4. Specifications

| Catalog No. | BR15, BR20, Series | CR15, CR20 Series | 815, 826 Series |
|--------------------------------------|--|--|--|
| Device Type | Straight Blade Duplex Receptacles, BR Series | Straight Blade Duplex Receptacles, CR Series | Straight Blade Duplex Receptacles |
| Wiring Type | Back & side wire | Side wire | Side wire |
| Testing & Code Compliance | <ul style="list-style-type: none"> cULus Listed to UL 498, file no. E15058 CSA Certified to C22.2, no. 42, file no. 6914, class 6233-01 UL verified to Federal Spec. WC-596G NOM certified | <ul style="list-style-type: none"> cULus Listed to UL 498, file no. E15058 UL verified to Federal Spec. WC-596G NOM certified | <ul style="list-style-type: none"> cULus Listed to UL 498, file no. E15058 UL verified to Federal Spec. WC-596G NOM certified |
| Environmental Specifications | Flammability: Meets UL 94 requirements; V2 rated Temperature Rating: -20°C to 60°C (-4°F to 140°F) | Flammability: Meets UL 94 requirements; V2 rated Temperature Rating: -20°C to 60°C (-4°F to 140°F) | Flammability: Meets UL 94 requirements; V2 rated Temperature Rating: -20°C to 60°C (-4°F to 140°F) |
| Electrical Specifications | Dielectric Voltage: Withstands 2000V per UL 498 Current Interrupting: Yes, at full-rated current Temperature Rise: Max. 30°C (86°F) after 100 cycles of overload @ 150% of rated current (DC) | Dielectric Voltage: Withstands 2000V per UL 498 Current Interrupting: Yes, at full-rated current Temperature Rise: Max. 30°C (86°F) after 100 cycles of overload @ 150% of rated current (DC) | Dielectric Voltage: Withstands 2000V per UL 498 Current Interrupting: Yes, at full-rated current Temperature Rise: Max. 30°C (86°F) after 100 cycles of overload VVV@ 150% of rated current (DC) |
| Mechanical Specifications | Terminal Accommodation: #14 - 10 AWG Voltage Ratings: Permanently marked on device | Terminal Accommodation: #14 - 10 AWG Voltage Ratings: Permanently marked on device | Terminal Accommodation: #14 - 10 AWG Voltage Ratings: Permanently marked on device |

Table 5. Materials

| Catalog No. | BR15, BR20, Series | CR15, CR20 Series | 815, 826 Series |
|----------------------------------|-------------------------------|---|-------------------------------|
| Top Housing | Nylon | PVC | PC |
| Bottom Housing | PVC | PVC | PC |
| Strap | 0.046" thick galvanized steel | 0.040" thick galvanized steel | 0.040" thick galvanized steel |
| Ground Contact | 0.030" thick brass | 0.030" thick brass | 0.030" thick brass |
| Auto Ground | Phosphor bronze staple | Phosphor bronze staple | Phosphor bronze staple |
| Line Contacts | .030" thick 3-leaf brass | .030" thick 3-leaf neutral/2-leaf hot brass | .030" thick 3-leaf brass |
| Terminal Screws | #8-32 Steel brass plated hot | #8-32 Steel brass plated hot | #8-32 Steel brass plated hot |
| Ground Screw | #8-32 Steel (Green) | #8-32 Steel (Green) | #8-32 Steel (Green) |
| Tamper Resistant Shutters | N/A | N/A | N/A |

| | |
|-----------------|--------------|
| Project Name: | Prepared By: |
| Project Number: | Date: |
| Catalog Number: | Type: |

Table 6. Specifications

| Catalog No. | 829 Series | 817, 1877 Series | 816, 1876 Series |
|--------------------------------------|--|--|--|
| Device Type | Straight Blade Dual Voltage Duplex Receptacles | Straight Blade Single Receptacles | Straight Blade Single Receptacles |
| Wiring Type | Side wire | Side wire | Side wire |
| Testing & Code Compliance | <ul style="list-style-type: none"> UL Listed to UL 498, file no. E15058 CSA Certified to C22.2, no. 42, file no. 6914, class 6233-01 NOM certified | <ul style="list-style-type: none"> UL Listed to UL 498, file no. E15058 CSA Certified to C22.2, no. 42, file no. 6914, class 6233-01 NOM certified | <ul style="list-style-type: none"> cULus Listed to UL 498, file no. E15058 NOM certified |
| Environmental Specifications | Flammability: Meets UL 94 requirements; V2 rated Temperature Rating: -20°C to 60°C (-4°F to 140°F) | Flammability: Meets UL 94 requirements; V2 rated Temperature Rating: -20°C to 60°C (-4°F to 140°F) | Flammability: Meets UL 94 requirements; V2 rated Temperature Rating: -20°C to 60°C (-4°F to 140°F) |
| Electrical Specifications | Dielectric Voltage: Withstands 2000V per UL 498 Current Interrupting: Yes, at full-rated current Temperature Rise: Max. 30°C (86°F) after 100 cycles of overload @ 150% of rated current (DC) | Dielectric Voltage: Withstands 2000V per UL 498 Current Interrupting: Yes, at full-rated current Temperature Rise: Max. 30°C (86°F) after 100 cycles of overload @ 150% of rated current (DC) | Dielectric Voltage: Withstands 2000V per UL 498 Current Interrupting: Yes, at full-rated current Temperature Rise: Max. 30°C (86°F) after 100 cycles of overload WW@ 150% of rated current (DC) |
| Mechanical Specifications | Terminal Accommodation: #14 - 10 AWG Voltage Ratings: Permanently marked on device | Terminal Accommodation: #14 - 10 AWG Voltage Ratings: Permanently marked on device | Terminal Accommodation: #14 - 10 AWG Voltage Ratings: Permanently marked on device |

Table 7. Materials

| Catalog No. | 829 Series | 817, 1877 Series | 816, 1876 Series |
|----------------------------------|---|-------------------------------|-------------------------------|
| Top Housing | PC | PVC | Nylon |
| Bottom Housing | PC | PVC | PVC |
| Strap | 0.040" thick galvanized steel | 0.040" thick galvanized steel | 0.040" thick galvanized steel |
| Ground Contact | 0.030" thick brass | 0.030" thick brass | 0.030" thick brass |
| Auto Ground | Phosphor bronze staple | N/A | N/A |
| Line Contacts | .030" thick 3-leaf neutral/2-leaf hot brass | .030" thick 3-leaf brass | .030" thick 3-leaf brass |
| Terminal Screws | #8-32 Steel brass plated hot | #8-32 Steel brass plated hot | #8-32 Steel brass plated hot |
| Ground Screw | #8-32 Steel (Green) | #8-32 Steel (Green) | #8-32 Steel (Green) |
| Tamper Resistant Shutters | N/A | N/A | N/A |

Commercial grade straight blade duplex receptacles

| | |
|-----------------|--------------|
| Project Name: | Prepared By: |
| Project Number: | Date: |
| Catalog Number: | Type: |

Table 8. Specifications

| Catalog No. | TRBR15, TRCR15, TRBR20, TRCR20 Series | TR817, TR1877 Series |
|--------------------------------------|--|--|
| Device Type | Tamper Resistant Straight Blade Duplex Receptacles | Tamper Resistant Straight Blade Single Receptacles |
| Wiring Type | Back & side wire (TRCR side wire only) | Side wire |
| Testing & Code Compliance | <ul style="list-style-type: none"> cULus Listed to UL 498, file no. E15058 UL verified to Federal Spec. WVC-596G (TRBR only) NOM certified | <ul style="list-style-type: none"> cULus Listed to UL 498, file no. E15058 NOM certified |
| Environmental Specifications | Flammability: Meets UL 94 requirements; V2 rated Temperature Rating: -20°C to 60°C (-4°F to 140°F) | Flammability: Meets UL 94 requirements; V2 rated Temperature Rating: -20°C to 60°C (-4°F to 140°F) |
| Electrical Specifications | Dielectric Voltage: Withstands 2000V per UL 498 Current Interrupting: Yes, at full-rated current Temperature Rise: Max. 30°C (86°F) after 100 cycles of overload @ 150% of rated current (DC) | Dielectric Voltage: Withstands 2000V per UL 498 Current Interrupting: Yes, at full-rated current Temperature Rise: Max. 30°C (86°F) after 100 cycles of overload @ 150% of rated current (DC) |
| Mechanical Specifications | Terminal Accommodation: #14 - 10 AWG Voltage Ratings: Permanently marked on device | Terminal Accommodation: #14 - 10 AWG Voltage Ratings: Permanently marked on device |

Table 9. Materials

| Catalog No. | TRBR15, TRCR15, TRBR20, TRCR20 Series | TR817, TR1877 Series |
|----------------------------------|---|-----------------------------------|
| Top Housing | PVC | PVC |
| Bottom Housing | PVC | PVC |
| Strap | 0.040" thick galvanized steel | 0.040" thick galvanized steel |
| Ground Contact | 0.030" thick brass | 0.030" thick brass |
| Auto Ground | Phosphor bronze staple | Phosphor bronze staple |
| Line Contacts | .030" thick 3-leaf neutral/2-leaf hot brass | .030" thick 3-leaf brass |
| Terminal Screws | #8-32 Steel brass plated hot | #8-32 Steel brass plated hot |
| Ground Screw | #8-32 Steel (Green) | #8-32 Steel (Green) |
| Tamper Resistant Shutters | Reliable Delrin® shutter assembly | Reliable Delrin® shutter assembly |

Table 10. Color Ordering Information

For ordering devices, include Cat. No. followed by the color code: A (Almond), B (Brown), BK (Black), GY (Gray) LA (Light Almond), RD (Red), V (Ivory), W (White)

| | | | | | | | |
|--------|-------|-------|------|------------|-----|-------|-------|
| A | B | BK | GY | LA | RD | V | W |
| Almond | Brown | Black | Gray | Lt. Almond | Red | Ivory | White |

| | |
|-----------------|--------------|
| Project Name: | Prepared By: |
| Project Number: | Date: |
| Catalog Number: | Type: |

Product Dimensions

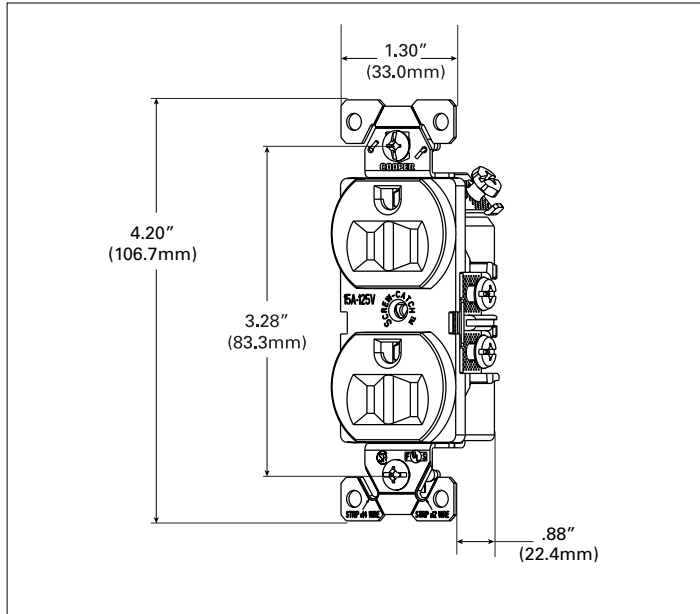

Figure 1. BR15 Line Art with Dimensions

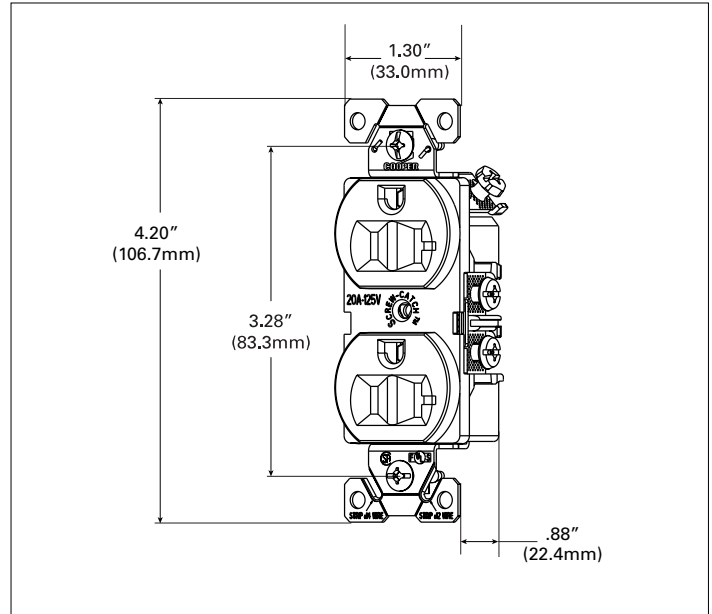

Figure 2. BR20 Line Art with Dimensions

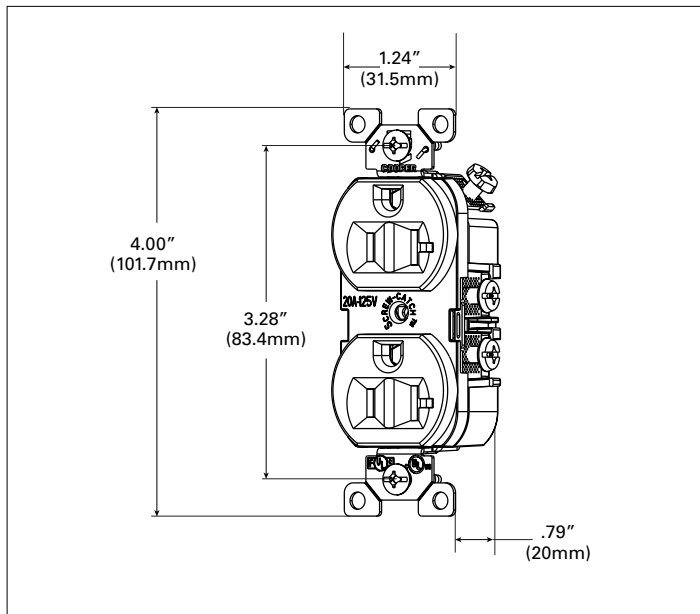

Figure 3. CR20 Line Art with Dimensions

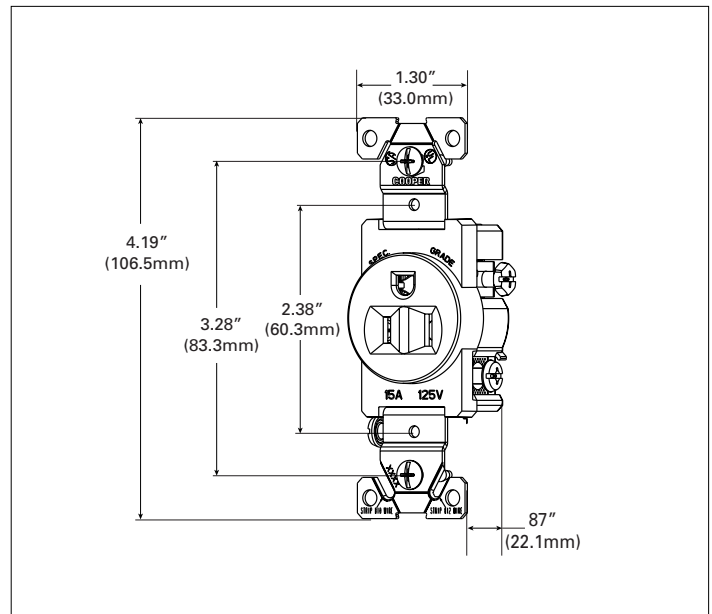

Figure 4. 817 Line Art with Dimensions

| | |
|-----------------|--------------|
| Project Name: | Prepared By: |
| Project Number: | Date: |
| Catalog Number: | Type: |

Product Dimensions

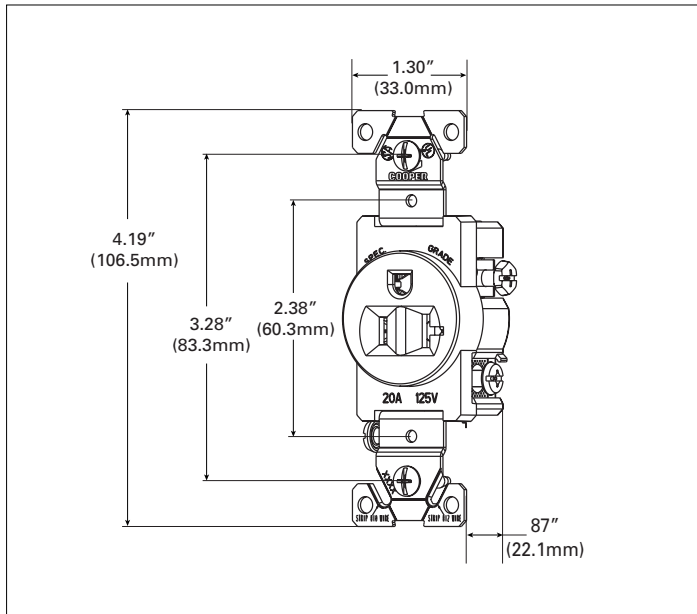

Figure 5. 1877 Line Art with Dimensions

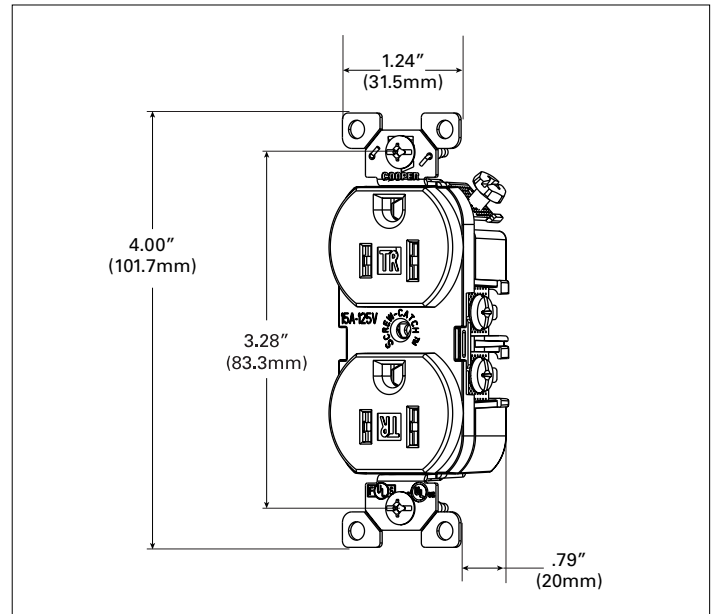

Figure 6. TRBR15 Line Art with Dimensions

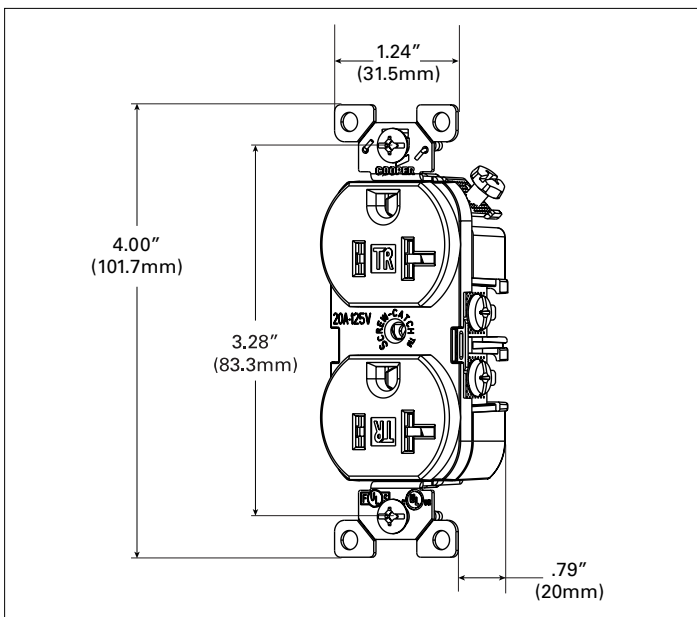

Figure 7. TRBR20 Line Art with Dimensions

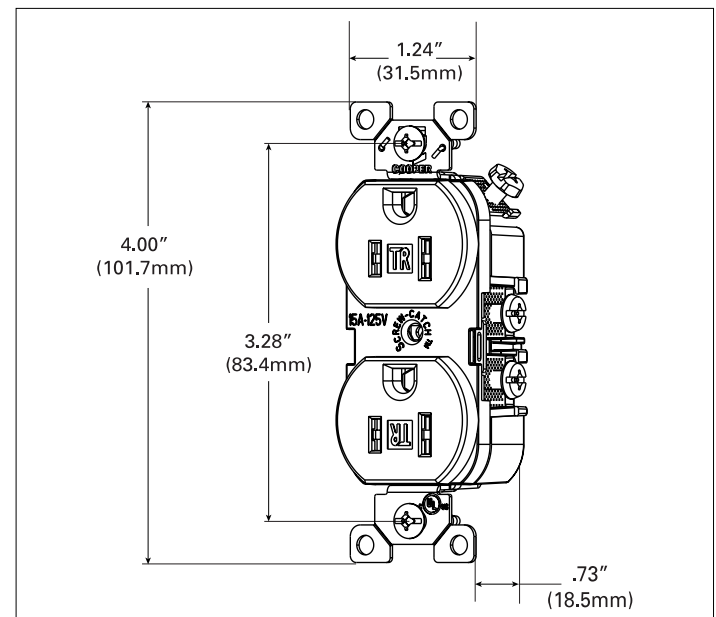

Figure 8. TRCR15 Line Art with Dimensions

| | |
|-----------------|--------------|
| Project Name: | Prepared By: |
| Project Number: | Date: |
| Catalog Number: | Type: |

Product Dimensions

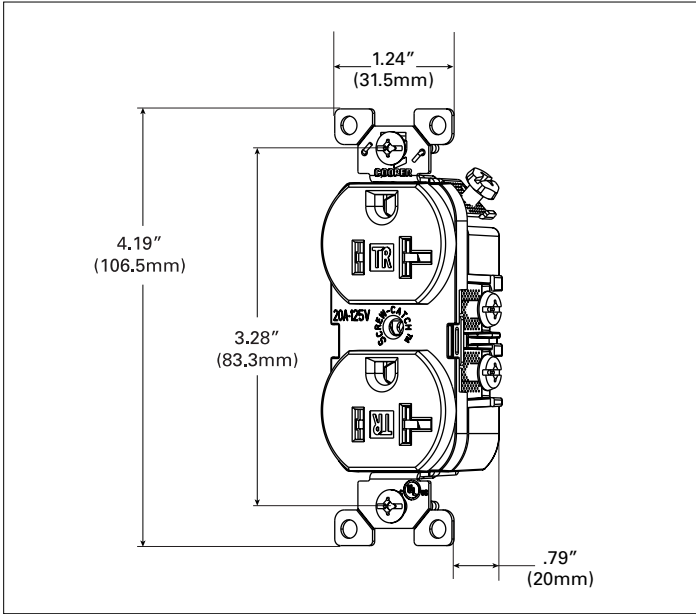

Figure 9. TRCR20 Line Art with Dimensions

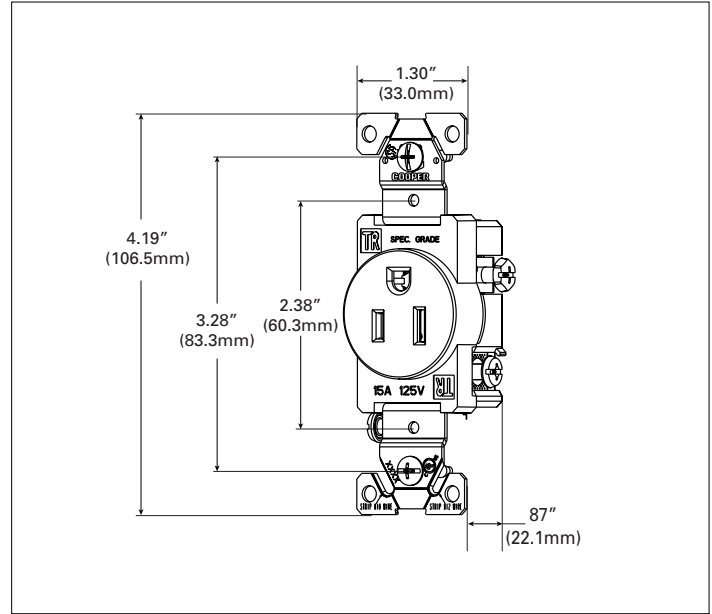

Figure 10. TR817 Line Art with Dimensions

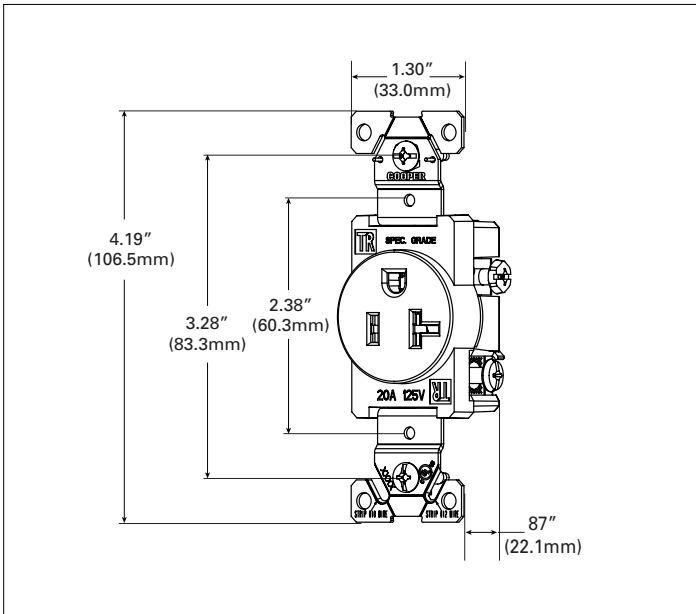











Figure 11. TR1877 Line Art with Dimensions

| | |
|-----------------|--------------|
| Project Name: | Prepared By: |
| Project Number: | Date: |
| Catalog Number: | Type: |

Certifications & compliances

| Catalog No. |  |  |  |  |  |  |  |  |  |
|-------------|---|---|---|---|---|---|---|---|---|
| BR15 | • | • | • | • | • | • | • | • | • |
| CR15 | • | | • | | | • | | • | • |
| 817 | | • | | • | • | • | | • | • |
| BR20 | • | • | • | • | • | • | • | • | • |
| CR20 | • | | • | | | • | | • | • |
| 1877 | | • | | • | • | • | | • | • |
| 826 | • | | • | | | • | | • | • |
| 816 | • | | • | | | • | | • | • |
| 815 | • | • | • | | • | • | | • | • |
| 1876 | • | | • | | | • | | • | • |
| 829 | | • | • | | • | • | | • | • |
| TRBR15 | • | | • | | | • | • | • | • |
| TRCR15 | • | | | | | • | | • | • |
| TR817 | • | | • | | | • | | • | • |
| TRBR20 | • | | • | | | • | • | • | • |
| TRCR20 | • | | | | | • | | • | • |
| TR1877 | • | | | | | • | | • | • |

KEY:  cULus  UL  Fed Spec  NAFTA  CSA
 NOM  Arrowlink  Build-To-Spec  ROHS

 Parts are manufactured and designed in accordance with article 4 of the European Union's RoHS2 directive 2011/65/EU

 Build-To-Spec Customizable Devices

Compliances, specifications and availability are subject to change without notice.

Electrical Sector
203 Cooper Circle
Peachtree City, GA 30269
United States
Eaton.com
Eaton.com/arrowhart

Electrical Sector
Canada Operations
5925 McLaughlin Road
Mississauga, Ontario, L5R 1B8
Canada
EatonCanada.ca
Eaton.com/arrowhart

Electrical Sector
Mexico Operations
Carr. Tlalnepantla -
Cuautitlan Km 17.8 s/n
Col. Villa Jardin esq.
Cerrada 8 de Mayo
Cuautitlan, Mexico CP 54800
Mexico
Eaton.mx
Eaton.com/arrowhart