

Supplementary Fuseblocks

Type M, For 1³/₃₂" × 1¹/₂" Fuses

600 Volt AC, 1/10 to 30 Amps

BM Series

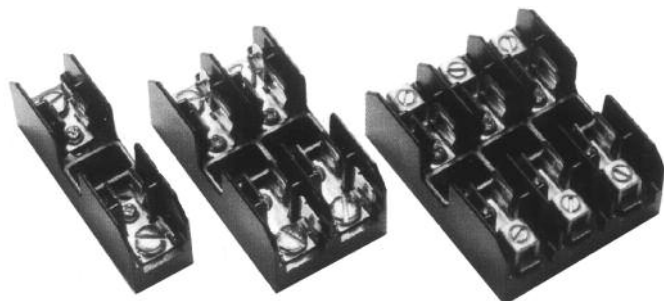

Catalog Symbol: BM Series
Type M Supplementary Fuseblocks

Ampere Rating: 1/10 to 30 Amperes

Voltage Rating: 600 Volts AC

Withstand Rating: 10,000 A RMS Sym. or interrupting rating of the fuse used, whichever is lower.

Agency Information:

U.L. Recognized, U.L. 512, Guide IZLT2, File E14853
 CSA Certified, C22.2 No. 39, Class 6225-01, File 47235
 For use with any 1³/₃₂" × 1¹/₂" Fuses
 (Bussmann KTK, FNQ, FNM, BAF, BAN and AGU)

U.L. Flammability: 94 V0

Material: Thermoplastic

Catalog Data (600V)

		Terminal Type			
Amps	Poles	Screw with Quick Connect*	Pressure Plate w/ Quick Connect*	Box Lug	Fig. No.
1/10 to 30	1	BM6031SQ	BM6031PQ	BM6031B	1
	2	BM6032SQ	BM6032PQ	BM6032B	2
	3	BM6033SQ	BM6033PQ	BM6033B	3

Wire Range
 CU Only



#10-#18



#10-#18



#6-#14

* QUICK CONNECT RATED FOR 20A MAXIMUM.

CE CE logo denotes compliance with European Union Low Voltage Directive (50-1000 Vac, 75-1500 Vdc). Refer to BIF document #8002 or contact Bussmann Application Engineering at 636-527-1270 for more information.

Dimensional Data All dimensions (±0.015)

1 POLE

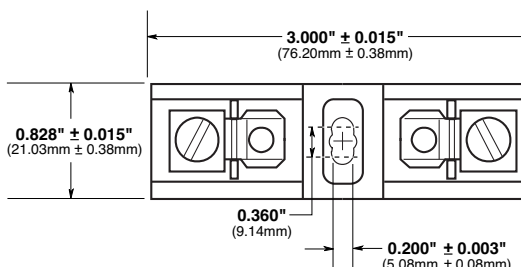

2 POLE

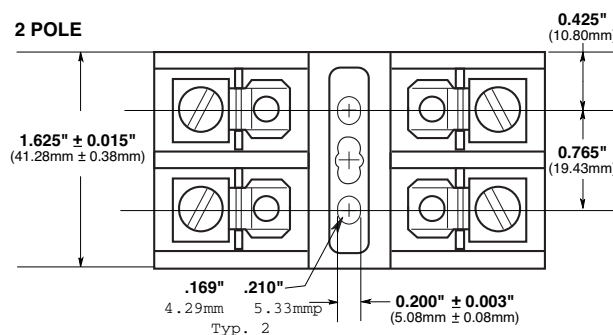

3 POLE

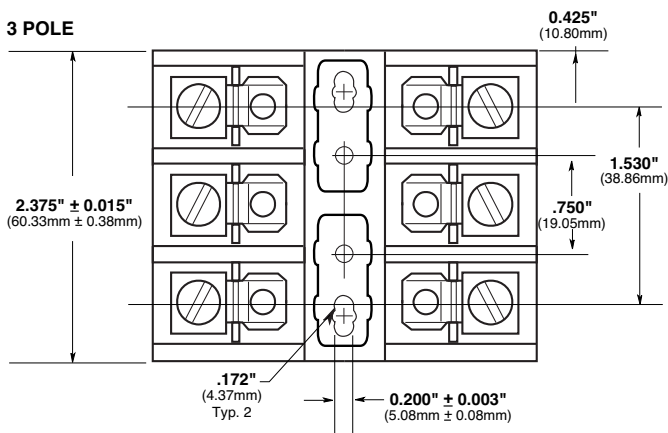

FUSEBLOCK LABEL (EXAMPLE SHOWN)

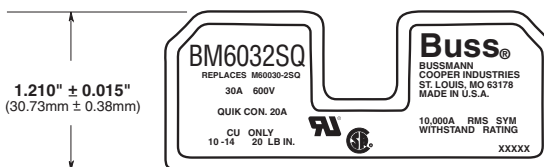

The only controlled copy of this BIF document is the electronic read-only version located on the Bussmann Network Drive. All other copies of this document are by definition uncontrolled. This bulletin is intended to clearly present comprehensive product data and provide technical information that will help the end user with design applications. Bussmann reserves the right, without notice, to change design or construction of any products and to discontinue or limit distribution of any products. Bussmann also reserves the right to change or update, without notice, any technical information contained in this bulletin. Once a product has been selected, it should be tested by the user in all possible applications.

Supplementary Fuseblocks

Type M, For 1³/₃₂" × 1¹/₂" Fuses

600 Volt AC, 1/10 to 30 Amps

BM Series

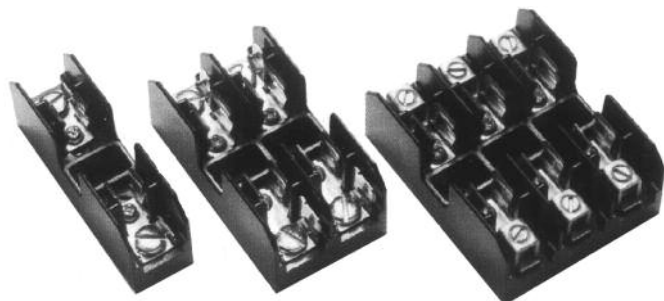

Catalog Symbol: BM Series
Type M Supplementary Fuseblocks

Ampere Rating: 1/10 to 30 Amperes

Voltage Rating: 600 Volts AC

Withstand Rating: 10,000 A RMS Sym. or interrupting rating of the fuse used, whichever is lower.

Agency Information:

U.L. Recognized, U.L. 512, Guide IZLT2, File E14853
 CSA Certified, C22.2 No. 39, Class 6225-01, File 47235
 For use with any 1³/₃₂" × 1¹/₂" Fuses
 (Bussmann KTK, FNQ, FNM, BAF, BAN and AGU)

U.L. Flammability: 94 V0

Material: Thermoplastic

Catalog Data (600V)

		Terminal Type			
Amps	Poles	Screw with Quick Connect*	Pressure Plate w/ Quick Connect*	Box Lug	Fig. No.
1/10	1	BM6031SQ	BM6031PQ	BM6031B	1
to	2	BM6032SQ	BM6032PQ	BM6032B	2
30	3	BM6033SQ	BM6033PQ	BM6033B	3

Wire Range
 CU Only



#10-#18



#10-#18



#6-#14

* QUICK CONNECT RATED FOR 20A MAXIMUM.

Dimensional Data All dimensions (±0.015)

1 POLE

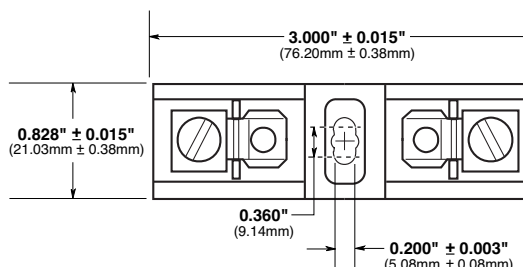

2 POLE

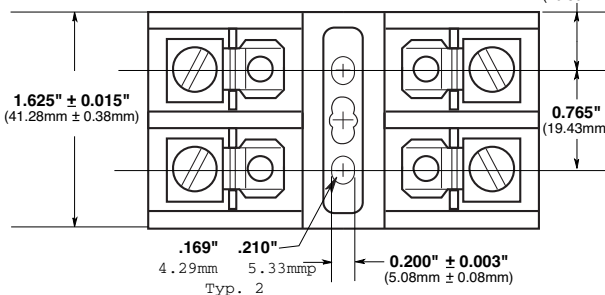

3 POLE

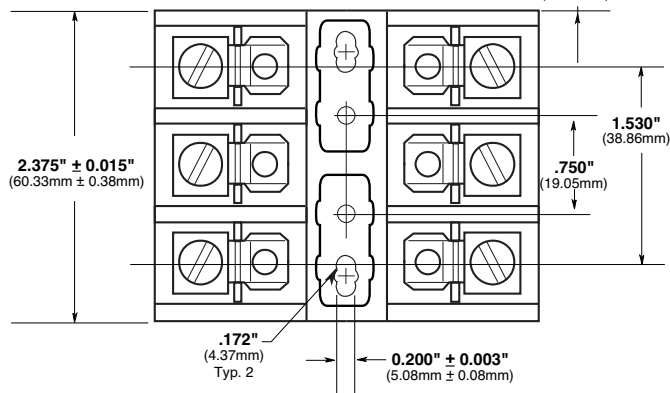

FUSEBLOCK LABEL (EXAMPLE SHOWN)

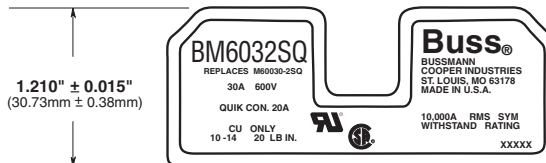

CE CE logo denotes compliance with European Union Low Voltage Directive (50-1000 Vac, 75-1500 Vdc). Refer to BIF document #8002 or contact Bussmann Application Engineering at 636-527-1270 for more information.

The only controlled copy of this BIF document is the electronic read-only version located on the Bussmann Network Drive. All other copies of this document are by definition uncontrolled. This bulletin is intended to clearly present comprehensive product data and provide technical information that will help the end user with design applications. Bussmann reserves the right, without notice, to change design or construction of any products and to discontinue or limit distribution of any products. Bussmann also reserves the right to change or update, without notice, any technical information contained in this bulletin. Once a product has been selected, it should be tested by the user in all possible applications.