

Project		Catalog #		Type	
Prepared by		Notes		Date	



HALO

BLD4 Series

4" Backlit LED Downlight
90 CRI

Typical Applications

Residential

Interactive Menu

- Order Information [page 2](#)
- Product Specifications [page 2](#)
- Photometric Data [page 4](#)
- Energy & Performance Data [page 3](#)
- Product Warranty

Product Certification



Refer to ENERGY STAR® Certified Products List.
Can be used to comply with California Title 24 High Efficacy requirements.
Certified to California Appliance Efficiency Database under J48.

Product Features



Top Product Features

- Backlit LED technology, with no housing
- Easy Install: Mounts to most junction boxes (including pancake boxes)
- Alternate Install: Mount to most recessed housings (hardware included)
- Adjustable white tuning, from 2700K–5000K
- Dimmable down to 5%

Dimensional and Mounting Details

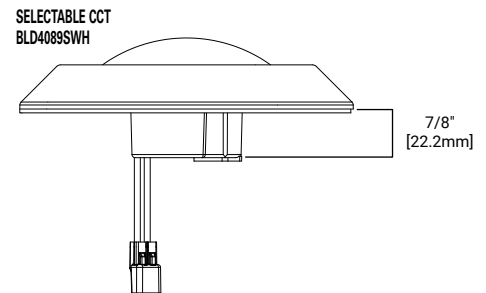
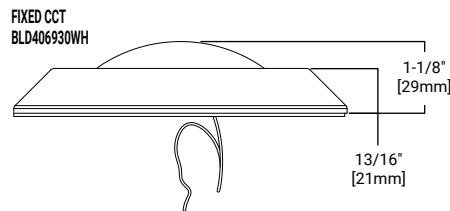
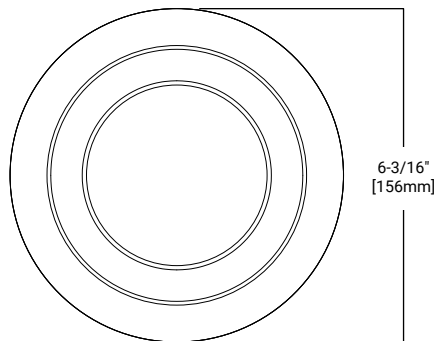

Order Information

SAMPLE NUMBER: **BLD406930WH** = 4" Backlit LED Downlight, 90CRI, 3000K

Models	Lumens	CRI/CCT	Finish	Voltage	Packaging
Models	Lumens	CRI/CCT	Finish	Voltage	Packaging
BLD4 = 4" Backlit LED Downlight	06 = 600 lumens (nominal)	930 = 90CRI, 3000K CCT	WH = Matte White	Blank = 120V	R = Recycled

SAMPLE NUMBER: **BLD406930WH** = 4" Backlit LED Downlight, 90CRI, 3000K

Models	Lumens	CRI/CCT	Finish	Voltage	Packaging
Models	Lumens	CRI/CCT	Finish	Voltage	Packaging
BLD4 = 4" Backlit LED Downlight	08 = 600 lumens (nominal)	9S = 90 CRI, SeleCCTable 2700K, 3000K, 3500K, 4000K & 5000K	WH = Matte White	Blank = 120V	R = Recycled

*For T20 California product, apply "-CA" to the catalog number (i.e. BLD406930WH-CA)

Housing Compatibility

The BLD4 is UL Certified in for use with **any** 4 inch diameter recessed housing constructed of steel or aluminum with an internal volume that exceeds 62.3 in³ in addition to those noted below:

Housing Compatibility

Compatible Halo LED Housings with LED luminaire connector (high-efficacy compliant)

H995ICAT = 4" IC, airtight shallow new construction housing, LED, 120 - 277V
H995RICAT = 4" IC, airtight shallow remodeler housing, LED, 120 - 277V
H245ICAT = 4" IC, airtight ultra-shallow new construction housing, LED, 120 - 277V
H245RICAT = 4" IC, airtight ultra-shallow remodeler housing, LED, 120 - 277V

Housing Compatibility

Compatible Halo Incandescent E26 Screwbase Housings

H99ICAT = 4" IC, airtight shallow new construction housing, E26, 120V
H99TAT = 4" non-IC, airtight shallow new construction housing, E26, 120V
H99RTAT = 4" Non-Insulated Ceiling Shallow Remodel Housing, 120V
E4ICATSB = 4" non-IC, airtight shallow new construction housing, adjustable socket bracket, E26, 120V
E4TATSB = 4" non-IC, airtight shallow new construction housing, adjustable socket bracket, E26, 120V
E4RTATSB = 4" non-IC, airtight shallow remodeler housing, adjustable socket bracket, E26, 120V

Product Specifications

Construction

- Stamped aluminum housing and frame

Optics

- Precision engineered optic provides uniform luminance from a low profile convex lens

LED

- Backlit LED technology
- Color Temperature options include: standard 3000K dedicated or SeleCCTable configuration including 2700K, 3000K, 3500K, 4000K and 5000K options
- 90 CRI is standard
- L70 at 50,000 hours projected in accordance with TM-21

Driver

- Integral 120V 60Hz constant current driver provides virtually noise free operation
- Continuous, flicker-free dimming from 100% to 5% with select leading or trailing edge 120V phase cut dimmers. See dimming guide.
- Dimming to 5% is best assured using dimmers with low end trim adjustment. Consult dimmer manufacturer for compatibility and conditions of use. (Note some dimmers require a neutral in the wallbox.)
- Inline electrical quick connect and E26 adapter (provided) provides mains connections

Electrical Junction Box Mounting

- BLD may be used in compatible electrical junction boxes in direct contact with insulation including spray foam insulation
- Suitable for installation in many 3-1/2" and 4" octagon and round electrical junction boxes.
- Dedicated CCT SKUs are compatible with compact (pancake) junction boxes
- Selectable CCT configuration, driver consumes 3 cubic inches of junction box, selectable CCT configuration is not compatible with pancake junction boxes
- Installer must ensure compatibility of fit, wiring and proper mounting in the electrical junction box. This includes all applicable national and local electrical and building coded Recessed Housing Mounting
- Can be installed in industry standard 4-inch recessed housings using friction mounting springs and (E26) medium base adapter provided.
- Not for use in recessed housings in direct contact with spray foam insulation refer to NEMA LSD 57-2013

Warranty

- Five year limited warranty, consult website for details. www.eaton.com/lighting/legal

Compliance

- cULus certified for use with Halo housings and other's housings, see instruction sheet for conditions of acceptability.
- Wet and Damp Location listed, airtight per ASTM-E283 (protected ceiling only)
- Suitable for use in clothes closets when installed in accordance with the NEC 410.16 spacing requirements.
- EMI/RFI emissions per FCC 47CFR Part 15B
- Contains no mercury or lead and RoHS compliant.
- Photometric testing in accordance with IES LM-79-08
- Lumen maintenance projections in accordance with IES LM-80-08 and TM-21-11
- Can be used for State of California Title 24 high efficacy luminaire compliance, reference the California Energy Commission Title 20 Appliance Efficiency Database for current listings
- Can be used for International Energy Conservation Coe (IECC) and Washington State Energy Code high efficiency luminaire Compliance
- ENERGY STAR® Certified luminaire - consult ENERGY STAR® Certified Product List

Energy Data

3000K - dedicated	
Lumens	690
Wattage	8.2W
Input current	0.07
Efficacy	84.1 LPW
THD	15.1%
Frequency	60 Hz
T Ambient	-30 - +40°C
Voltage	120V
Sound Rating	Class A
Power Factor	0.99

SeleCCTable 2700K - 5000K	
Lumens	802
Wattage	10.3W
Input current	0.087
Efficacy	77.9 LPW
THD	11.9%
Frequency	60 Hz
T Ambient	-30 - +40°C
Voltage	120V
Sound Rating	Class A
Power Factor	0.99

COMPATIBLE WITH EATON'S CROUSE-HINDS JUNCTION BOXES

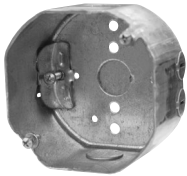

TP316
for non-metallic cable
4" x 4" x 2-1/8"
(102mm x 102mm x 54mm)

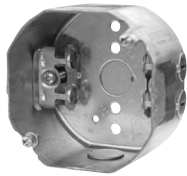

TP317
for metal clad cable
4" x 4" x 2-1/8"
(102mm x 102mm x 54mm)

- **TP316** - for non-metallic cable
- **TP317** - for metal clad cable
- UL Listed
- Refer to www.crouse-hinds.com

COMPATIBLE WITH MANY OTHER JUNCTION BOXES*



4" octagon light fixture/fan steel box
4" x 4" x 2-1/8"
(102mm x 102mm x 54mm)



4" octagon steel box
4" x 4" x 1-1/2"
(102mm x 102mm x 38mm)



4" round new work non-metallic box with hanger bar assembly
4" diameter x 2-3/16" (102mm x 56mm)



4" round new work non-metallic light fixture/fan box
4" diameter x 2-3/16"
(102mm x 56mm)



3-1/2" round new work non-metallic ceiling box
3-1/2" diameter x 2-3/4"
(89mm x 70mm)



3-1/2" round old work non-metallic box
4-1/4" O.D. flange, 3-1/2" I.D. x 2-5/8"
(108mm O.D., 89mm I.D. x 67mm)



4" round surface mount box
4" diameter x 1-1/2"
(102mm x 38mm)



Round ceiling pan
4" diameter x 13/16"
(102mm x 21mm)
Note: only compatible with fixed CCT BLD406930

*This is a representative list of compatible junction boxes only. Information contained in this literature about other manufacturers' products is from published information made available by the manufacturer and is deemed to be reliable, but has not been verified. Eaton makes no specific recommendation on product selection and there are no warranties of performance or compatibility implied. Installer must determine that site conditions are suitable to allow proper installation of the mounting bracket in the box.

Photometric Data

BLD406930WH		
Luminaire lumens	690	
Input watts	8.2	
LER (LPW)	84.1	
Spacing Criteria	0-180	1.26
	90-270	1.26
	Diagonal	1.38
Beam angle (degrees)	114.4	
Field angle (degrees)	178.6	
Max. Candela	222	
Zonal lumen	Lumens	% Lumens
0-30	172	24.9%
0-40	282	40.8%
0-60	502	72.7%
0-90	690	100.00%

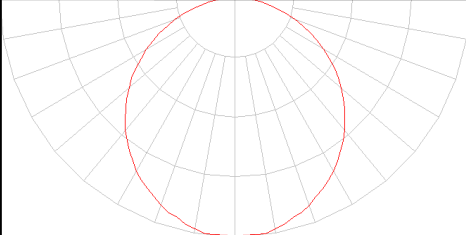

BLD4089SWH		
Luminaire lumens	802	
Input watts	10.3	
LER (LPW)	77.9	
Spacing Criteria	0-180	1.28
	90-270	1.28
	Diagonal	1.4
Beam angle (degrees)	116.8	
Field angle (degrees)	180	
Max. Candela	250	
Zonal lumen	Lumens	% Lumens
0-30	195	24.3%
0-40	321	40.0%
0-60	576	71.8%
0-90	802	100.00%

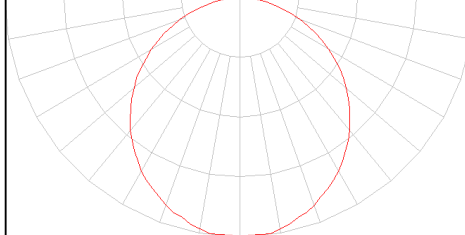

Color Metric Summary

	BLD406930WH	BLD4089SWH
TM-30-15	Rf = 91	Rf = 91.8
	Rg = 101.1	Rg = 101.3
CRI/CIE	Ra = 93	Ra = 93
	R9 = 75	R9 = 70

CCT - Range of 2700K- 5000K



Foot-candle Values at Nadir 0 degree Aiming Angle				
DD (FT)	BLD406930WH (FC)	DIA (FT)	BLD4089SWH (FC)	DIA (FT)
5.5	7.3	6.8	8.2	6.8
7	4.5	8.6	5.1	8.8
8	3.5	10	3.9	10
9	2.7	11.2	3.1	11.4
10	2.2	12.4	2.5	12.6
12	1.5	15	1.7	15.2

DD = distance down to illuminated work plane
 FC = initial foot-candles at nadir
 DIA = diameter

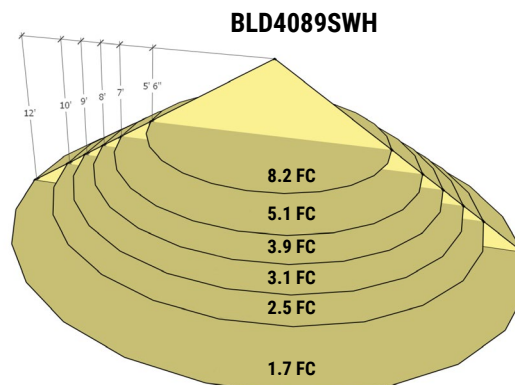
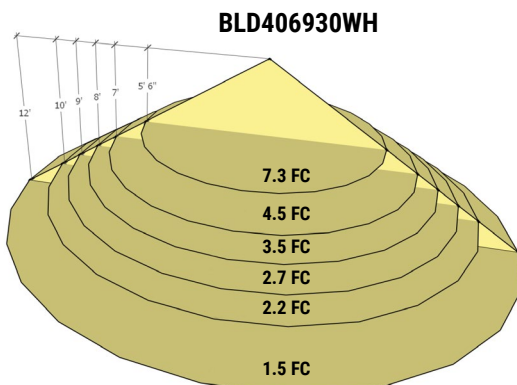

Project		Catalog #		Type	
Prepared by		Notes		Date	



HALO

BLD4 Series

4" Backlit LED Downlight
90 CRI

Typical Applications

Residential

Interactive Menu

- Order Information [page 2](#)
- Product Specifications [page 2](#)
- Photometric Data [page 4](#)
- Energy & Performance Data [page 3](#)
- Product Warranty

Product Certification



Refer to ENERGY STAR® Certified Products List.
Can be used to comply with California Title 24 High Efficacy requirements.
Certified to California Appliance Efficiency Database under J48.

Product Features



Top Product Features

- Backlit LED technology, with no housing
- Easy Install: Mounts to most junction boxes (including pancake boxes)
- Alternate Install: Mount to most recessed housings (hardware included)
- Adjustable white tuning, from 2700K–5000K
- Dimmable down to 5%

Dimensional and Mounting Details

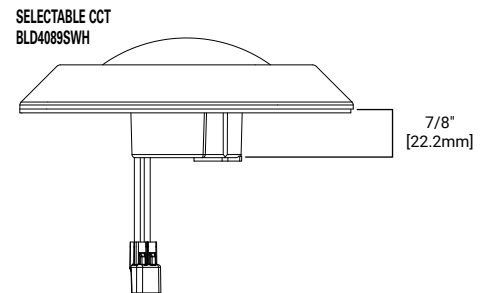
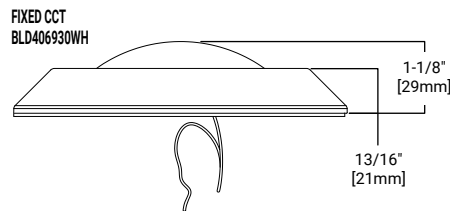
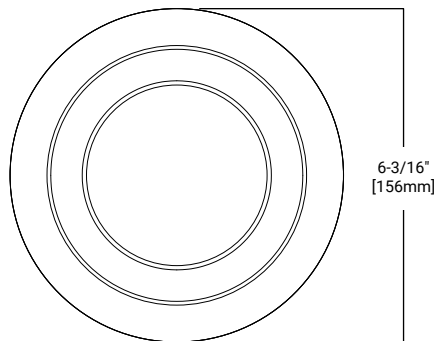

Order Information

SAMPLE NUMBER: **BLD406930WH** = 4" Backlit LED Downlight, 90CRI, 3000K

Models	Lumens	CRI/CCT	Finish	Voltage	Packaging
Models	Lumens	CRI/CCT	Finish	Voltage	Packaging
BLD4 = 4" Backlit LED Downlight	06 = 600 lumens (nominal)	930 = 90CRI, 3000K CCT	WH = Matte White	Blank = 120V	R = Recycled

SAMPLE NUMBER: **BLD406930WH** = 4" Backlit LED Downlight, 90CRI, 3000K

Models	Lumens	CRI/CCT	Finish	Voltage	Packaging
Models	Lumens	CRI/CCT	Finish	Voltage	Packaging
BLD4 = 4" Backlit LED Downlight	08 = 600 lumens (nominal)	9S = 90 CRI, SeleCCTable 2700K, 3000K, 3500K, 4000K & 5000K	WH = Matte White	Blank = 120V	R = Recycled

*For T20 California product, apply "-CA" to the catalog number (i.e. BLD406930WH-CA)

Housing Compatibility

The BLD4 is UL Certified in for use with **any** 4 inch diameter recessed housing constructed of steel or aluminum with an internal volume that exceeds 62.3 in³ in addition to those noted below:

Housing Compatibility

Compatible Halo LED Housings with LED luminaire connector (high-efficacy compliant)

H995ICAT = 4" IC, airtight shallow new construction housing, LED, 120 - 277V
H995RICAT = 4" IC, airtight shallow remodeler housing, LED, 120 - 277V
H245ICAT = 4" IC, airtight ultra-shallow new construction housing, LED, 120 - 277V
H245RICAT = 4" IC, airtight ultra-shallow remodeler housing, LED, 120 - 277V

Housing Compatibility

Compatible Halo Incandescent E26 Screwbase Housings

H99ICAT = 4" IC, airtight shallow new construction housing, E26, 120V
H99TAT = 4" non-IC, airtight shallow new construction housing, E26, 120V
H99RTAT = 4" Non-Insulated Ceiling Shallow Remodel Housing, 120V
E4ICATSB = 4" non-IC, airtight shallow new construction housing, adjustable socket bracket, E26, 120V
E4TATSB = 4" non-IC, airtight shallow new construction housing, adjustable socket bracket, E26, 120V
E4RTATSB = 4" non-IC, airtight shallow remodeler housing, adjustable socket bracket, E26, 120V

Product Specifications

Construction

- Stamped aluminum housing and frame

Optics

- Precision engineered optic provides uniform luminance from a low profile convex lens

LED

- Backlit LED technology
- Color Temperature options include: standard 3000K dedicated or SeleCCTable configuration including 2700K, 3000K, 3500K, 4000K and 5000K options
- 90 CRI is standard
- L70 at 50,000 hours projected in accordance with TM-21

Driver

- Integral 120V 60Hz constant current driver provides virtually noise free operation
- Continuous, flicker-free dimming from 100% to 5% with select leading or trailing edge 120V phase cut dimmers. See dimming guide.
- Dimming to 5% is best assured using dimmers with low end trim adjustment. Consult dimmer manufacturer for compatibility and conditions of use. (Note some dimmers require a neutral in the wallbox.)
- Inline electrical quick connect and E26 adapter (provided) provides mains connections

Electrical Junction Box Mounting

- BLD may be used in compatible electrical junction boxes in direct contact with insulation including spray foam insulation
- Suitable for installation in many 3-1/2" and 4" octagon and round electrical junction boxes.
- Dedicated CCT SKUs are compatible with compact (pancake) junction boxes
- Selectable CCT configuration, driver consumes 3 cubic inches of junction box, selectable CCT configuration is not compatible with pancake junction boxes
- Installer must ensure compatibility of fit, wiring and proper mounting in the electrical junction box. This includes all applicable national and local electrical and building coded Recessed Housing Mounting
- Can be installed in industry standard 4-inch recessed housings using friction mounting springs and (E26) medium base adapter provided.
- Not for use in recessed housings in direct contact with spray foam insulation refer to NEMA LSD 57-2013

Warranty

- Five year limited warranty, consult website for details. www.eaton.com/lighting/legal

Compliance

- cULus certified for use with Halo housings and other's housings, see instruction sheet for conditions of acceptability.
- Wet and Damp Location listed, airtight per ASTM-E283 (protected ceiling only)
- Suitable for use in clothes closets when installed in accordance with the NEC 410.16 spacing requirements.
- EMI/RFI emissions per FCC 47CFR Part 15B
- Contains no mercury or lead and RoHS compliant.
- Photometric testing in accordance with IES LM-79-08
- Lumen maintenance projections in accordance with IES LM-80-08 and TM-21-11
- Can be used for State of California Title 24 high efficacy luminaire compliance, reference the California Energy Commission Title 20 Appliance Efficiency Database for current listings
- Can be used for International Energy Conservation Code (IECC) and Washington State Energy Code high efficiency luminaire Compliance
- ENERGY STAR® Certified luminaire - consult ENERGY STAR® Certified Product List

Energy Data

3000K - dedicated	
Lumens	690
Wattage	8.2W
Input current	0.07
Efficacy	84.1 LPW
THD	15.1%
Frequency	60 Hz
T Ambient	-30 - +40°C
Voltage	120V
Sound Rating	Class A
Power Factor	0.99

SeleCCTable 2700K - 5000K	
Lumens	802
Wattage	10.3W
Input current	0.087
Efficacy	77.9 LPW
THD	11.9%
Frequency	60 Hz
T Ambient	-30 - +40°C
Voltage	120V
Sound Rating	Class A
Power Factor	0.99

COMPATIBLE WITH EATON'S CROUSE-HINDS JUNCTION BOXES

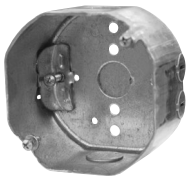

TP316
for non-metallic cable
4" x 4" x 2-1/8"
(102mm x 102mm x 54mm)



TP317
for metal clad cable
4" x 4" x 2-1/8"
(102mm x 102mm x 54mm)

- **TP316** - for non-metallic cable
- **TP317** - for metal clad cable
- UL Listed
- Refer to www.crouse-hinds.com

COMPATIBLE WITH MANY OTHER JUNCTION BOXES*



4" octagon light fixture/fan steel box
4" x 4" x 2-1/8"
(102mm x 102mm x 54mm)



4" octagon steel box
4" x 4" x 1-1/2"
(102mm x 102mm x 38mm)



4" round new work non-metallic box with hanger bar assembly
4" diameter x 2-3/16" (102mm x 56mm)



4" round new work non-metallic light fixture/fan box
4" diameter x 2-3/16"
(102mm x 56mm)



3-1/2" round new work non-metallic ceiling box
3-1/2" diameter x 2-3/4"
(89mm x 70mm)



3-1/2" round old work non-metallic box
4-1/4" O.D. flange, 3-1/2" I.D. x 2-5/8"
(108mm O.D., 89mm I.D. x 67mm)



4" round surface mount box
4" diameter x 1-1/2"
(102mm x 38mm)



Round ceiling pan
4" diameter x 13/16"
(102mm x 21mm)
Note: only compatible with fixed CCT BLD406930

*This is a representative list of compatible junction boxes only. Information contained in this literature about other manufacturers' products is from published information made available by the manufacturer and is deemed to be reliable, but has not been verified. Eaton makes no specific recommendation on product selection and there are no warranties of performance or compatibility implied. Installer must determine that site conditions are suitable to allow proper installation of the mounting bracket in the box.

Photometric Data

BLD406930WH		
Luminaire lumens	690	
Input watts	8.2	
LER (LPW)	84.1	
Spacing Criteria	0-180	1.26
	90-270	1.26
	Diagonal	1.38
Beam angle (degrees)	114.4	
Field angle (degrees)	178.6	
Max. Candela	222	
Zonal lumen	Lumens	% Lumens
0-30	172	24.9%
0-40	282	40.8%
0-60	502	72.7%
0-90	690	100.00%

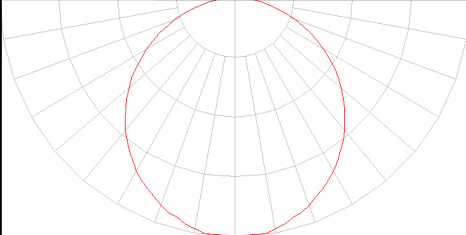

BLD4089SWH		
Luminaire lumens	802	
Input watts	10.3	
LER (LPW)	77.9	
Spacing Criteria	0-180	1.28
	90-270	1.28
	Diagonal	1.4
Beam angle (degrees)	116.8	
Field angle (degrees)	180	
Max. Candela	250	
Zonal lumen	Lumens	% Lumens
0-30	195	24.3%
0-40	321	40.0%
0-60	576	71.8%
0-90	802	100.00%

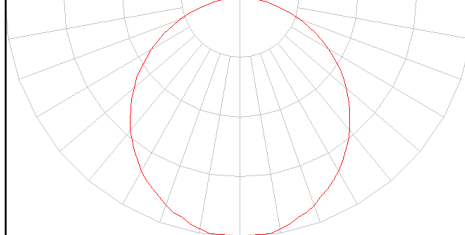

Color Metric Summary

	BLD406930WH	BLD4089SWH
TM-30-15	Rf = 91	Rf = 91.8
	Rg = 101.1	Rg = 101.3
CRI/CIE	Ra = 93	Ra = 93
	R9 = 75	R9 = 70

CCT - Range of 2700K- 5000K



Foot-candle Values at Nadir 0 degree Aiming Angle				
DD (FT)	BLD406930WH (FC)	DIA (FT)	BLD4089SWH (FC)	DIA (FT)
5.5	7.3	6.8	8.2	6.8
7	4.5	8.6	5.1	8.8
8	3.5	10	3.9	10
9	2.7	11.2	3.1	11.4
10	2.2	12.4	2.5	12.6
12	1.5	15	1.7	15.2

DD = distance down to illuminated work plane
FC = initial foot-candles at nadir
DIA = diameter

