

Series 2, 3, 4, & 5 Steel - Accessories

Splice Plates

- Standard 8-hole pattern for all steel splice plates.
- Furnished in pairs with hardware.
- One pair including hardware provided with straight section. (Expansion splice quantity subtracted)
- Boxed in pairs with hardware.
- (*) Insert **ZN** or **G**

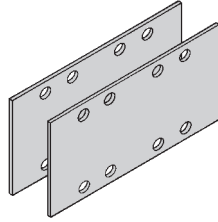

Catalog No.	Height in. mm
9(*)-8004	4 (101)
9(*)-8005	5 (127)
9(*)-8006	6 (152)
9(*)-8007	7 (178)

Expansion Splice Plates

- Expansion plates allow for one inch expansion or contraction of the cable tray, or where expansion joints occur in the support structure.
- Furnished in pairs with hardware.
- Bonding Jumpers are required on each siderail. Order Separately.
- (*) Insert **ZN** or **G**

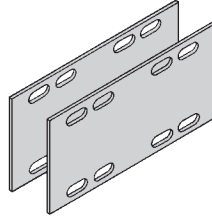

For heavy duty expansion splice plates see page APP-3.

Catalog No.	Height in. mm
9(*)-8014	4 (101)
9(*)-8015	5 (127)
9(*)-8016	6 (152)
9(*)-8017	7 (178)

Universal Splice Plates

- Used to splice to existing cable tray systems.
- Furnished in pairs with hardware.
- (*) Insert **ZN** or **G**

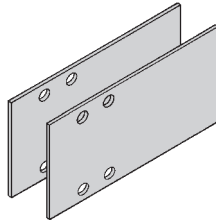

Catalog No.	Height in. mm
9(*)-8004-1/2	4 (101)
9(*)-8005-1/2	5 (127)
9(*)-8006 -1/2	6 (152)
9(*)-8007 -1/2	7 (178)

Step Down Splice Plates

- These splice plates are offered for connecting cable tray sections having side rails of different heights.
- Furnished in pairs with hardware.
- (*) Insert **ZN** or **G**

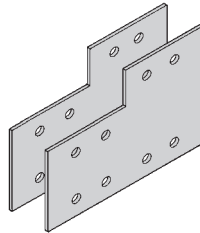

Catalog No.	Height in. mm
9(*)-8045	5 to 4 (127 to 101)
9(*)-8046	6 to 4 (152 to 101)
9(*)-8060	6 to 5 (152 to 127)
9(*)-8047	7 to 4 (178 to 101)
9(*)-8061	7 to 5 (178 to 127)
9(*)-8062	7 to 6 (178 to 152)

Vertical Adjustable Splice Plates

- These plates provide for changes in elevation that do not conform to standard vertical fittings.
- Furnished in pairs with hardware.
- **Bonding Jumpers not required.**
- (*) Insert **G** or **P**

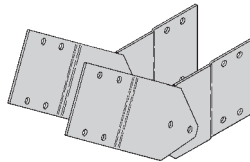

Requires supports within 24" on both sides, per NEMA VE 2.

Catalog No.	Height in. mm
9(*)-8024	4 (101)
9(*)-8025	5 (127)
9(*)-8026	6 (152)
9(*)-8027	7 (178)

Branch Pivot Connectors

- Branch from existing cable tray runs at any point.
- Pivot to any required angle.
- UL Classified for grounding (bonding jumpers not required).
- Furnished in pairs with hardware.
- (*) Insert **ZN** or **G**

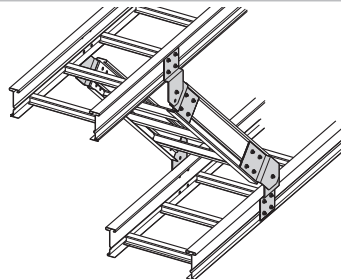

Catalog No.	Height in. mm
9(*)-8244	4 (101)
9(*)-8245	5 (127)
9(*)-8246	6 (152)
9(*)-8247	7 (178)

● Green = Fastest shipped items ● Black = Normal lead-time items ● Red = Normally long lead-time items

All dimensions in parentheses are millimeters unless otherwise specified.

Horizontal Adjustable Splice Plates

- Offered to adjust a cable tray run for changes in direction in a horizontal plane that do not conform to standard horizontal fittings.
- Furnished in pairs with hardware.
- Bonding jumpers **not** required.
- (*) Insert **ZN** or **G**
- (X) Insert 4, 5, 6 or 7 for side rail height.

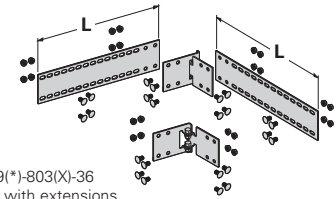
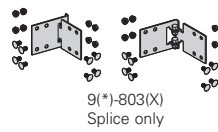

Catalog No.	Cable Tray End Cut	Thru Tray Width		'L'
		in.	(mm)	in. (mm)
9(*)-803(X)	Mitered	36	(914)	N/A (NA)
9(*)-803(X)-12	Not mitered	12	(305)	16 (406)
9(*)-803(X)-36	Not mitered	36	(914)	41 (1041)

Requires supports within 24" on both sides, per NEMA VE 2.

Offset Reducing Splice Plate

- This plate is used for joining cable trays having different widths. When used in pairs they form a straight reduction; when used singly with a standard splice plate, they form an offset reduction.
- Furnished as one plate with hardware.
- (‡) Insert reduction
- (*) Insert **G** or **P**

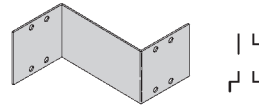

Catalog No.	Height	
	in.	mm
9(*)-8064-(‡)	4	(101)
9(*)-8065-(‡)	5	(127)
9(*)-8066-(‡)	6	(152)
9(*)-8067-(‡)	7	(178)

Tray to Box Splice Plates

- Used to attach the end of a cable tray run to a distribution box or control panel.
- Furnished in pairs with hardware.
- (*) Insert **G** or **P**

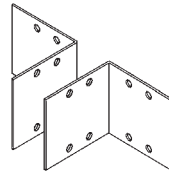

Catalog No.	Height	
	in.	mm
9(*)-8054	4	(101)
9(*)-8055	5	(127)
9(*)-8056	6	(152)
9(*)-8057	7	(178)

Frame Type Box Connector

- Designed to attach the end of a cable tray run to a distribution cabinet or control center to help reinforce the box at the point of entry.
- Furnished with tray connection hardware.
- (*) Insert **ZN** or **G**
- (‡) Insert tray width

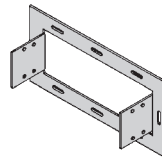

Catalog No.	Height	
	in.	mm
9(*)-8074-(‡)	4	(101)
9(*)-8075-(‡)	5	(127)
9(*)-8076-(‡)	6	(152)
9(*)-8077-(‡)	7	(178)

Blind End

- This plate forms a closure for a dead end cable tray.
- Furnished as one plate with hardware.
- (*) Insert **G** or **P**
- (‡) Insert tray width

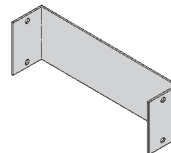

Catalog No.	Height	
	in.	mm
9(*)-8084-(‡)	4	(101)
9(*)-8085-(‡)	5	(127)
9(*)-8086-(‡)	6	(152)
9(*)-8087-(‡)	7	(178)

Cross Connector Bracket

- For field connecting crossing section.
- Furnished in pairs with 3/8" hardware.
- (*) Insert **ZN** or **G**

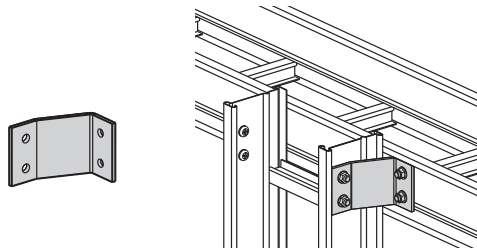

Catalog No.
9(*)-1240

● Green = Fastest shipped items ● Black = Normal lead-time items ● Red = Normally long lead-time items

All dimensions in parentheses are millimeters unless otherwise specified.

Series 2, 3, 4, & 5 Steel - Accessories

Standard Tray Hardware (for field installation drill $1\frac{3}{32}$ " hole)

- Finishes: [ZN] Zinc Plated ASTM B633 SC1 for pre-galvanized tray
[CZ] Chromium Zinc Plated F1136-88 Grade A for hot dip galvanized tray

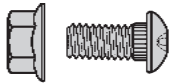

Catalog No.	Description
● RNCB $\frac{3}{8}$" x $\frac{3}{4}$" ZN	Ribbed Neck Carriage Bolt ASTM A307 Grade A
● SFHN $\frac{3}{8}$"-16 ZN	Serrated Flange Hex Nut ASTM A563 Grade A
● RNCB $\frac{3}{8}$" x $\frac{3}{4}$" CZ	Ribbed Neck Carriage Bolt ASTM F1136-88 Grade 3
● SFHN $\frac{3}{8}$"-16 CZ	Serrated Flange Hex Nut ASTM F1136-88 Grade A

Optional Tray Hardware (for field installation drill $1\frac{3}{32}$ " hole)

- To order 316 stainless steel hardware add SS6 suffix to catalog number - Example: 9G-8004SS6

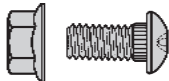

Catalog No.	Description
● RNCB $\frac{3}{8}$" x $\frac{3}{4}$" SS6	Ribbed Neck Carriage Bolt AISI 316 Stainless Steel
● SFHN $\frac{3}{8}$"-16 SS6	Serrated Flange Hex Nut AISI 316 Stainless Steel

Conduit to Cable Tray Adaptor

- For easy attachment of conduit terminating at a cable tray.
- Use on aluminum or steel cable trays.

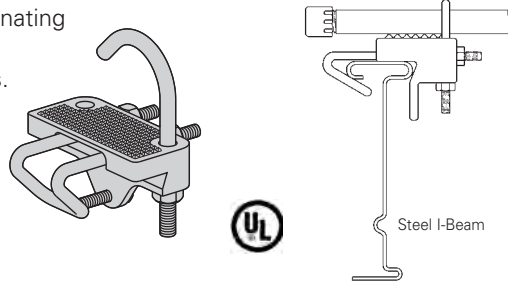

Catalog No.	Conduit Size	
	in.	mm
● 9G-1158-1/2, 3/2	$1\frac{1}{2}, \frac{3}{4}$	(15, 20)
● 9G-1158-1, 1 1/4	1, $1\frac{1}{4}$	(25, 32)
● 9G-1158-1 1/2, 2	$1\frac{1}{2}, 2$	(40, 50)
● 9G-1158-2 1/2, 3	$2\frac{1}{2}, 3$	(65, 80)
● 9G-1158-3 1/2, 4	$3\frac{1}{2}, 4$	(90, 100)

Conduit to Cable Tray Adaptor

- Assembly required.
- Mounting hardware included.
- Conduit clamps provided.
- (‡) = Insert conduit size ($\frac{1}{2}$ " thru 4").

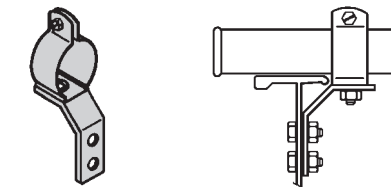

Catalog No.
● 9ZN-1150-(‡)

Conduit to Cable Tray Adaptor

- Assembly required.
- Conduit clamps included.
- (‡) = Insert conduit size ($\frac{1}{2}$ " thru 4").

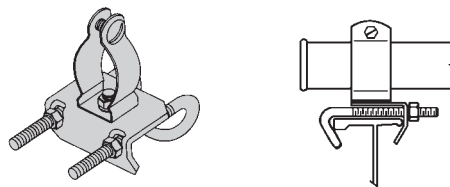

Catalog No.
● 9ZN-1155-(‡)

Cable Tie (Ladder Tray)

- Nylon ties provide easy attachment of cable to ladder rungs; maximum cable O.D. is 3" (76mm).

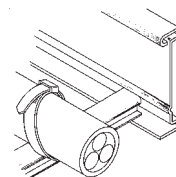
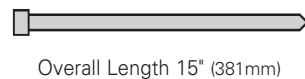

Catalog No.
● 99-2125-15

● Green = Fastest shipped items ● Black = Normal lead-time items ● Red = Normally long lead-time items

All dimensions in parentheses are millimeters unless otherwise specified.

Ladder Drop-Out

- Specially-designed Ladder Drop-Outs provide a rounded surface with 4" (101 mm) radius to protect cable as it exits the cable tray, preventing damage to insulation. The drop-out will attach to any desired rung.
- (*) Insert **P** or **G**
- (‡) Insert tray width

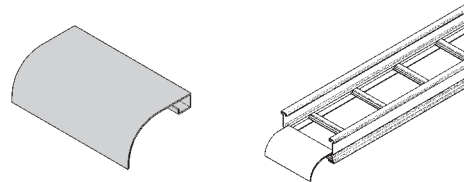

Catalog No.
● 9(*)-1104-(‡)

Trough Drop-Out & Drop-Out Bushing

- These devices provide a rounded surface to protect cable as it exits from the trough-type cable tray.
- Hardware is included for attachment of the trough bottom drop-out.
- (*) Insert **P** or **G**
- (‡) Insert tray width

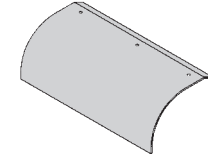
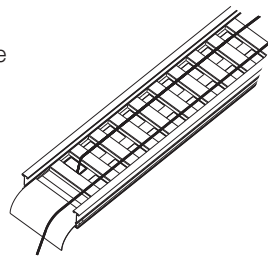

Trough-Type Drop-Out

Catalog No.
● 9(*)-1104T-(‡)

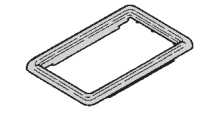

Snap-In Plastic Bushing

Catalog No.
● 99-1124

Barrier - Straight Section

- Length: Insert 120 for [120" - 10 ft.] (3.0 m) or 144 for [144" - 12 ft.] (3.6 m)
- Order catalog number based on loading depth.
- Furnished with four #10 x 1/2" plated self-drilling screws and a 99-9982 Barrier Strip Splice.
- (*) Insert **P** or **G**

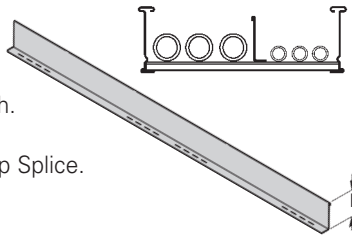

Catalog No.	Side Rail Height in. mm	Loading Depth 'H' in. mm
73(*)-Length	4 (101)	3 (76)
74(*)-Length	5 (127)	4 (101)
75(*)-Length	6 (152)	5 (127)
76(*)-Length	7 (178)	6 (152)

Barrier - Horizontal Bend

- Horizontal Bend Barriers are flexible in order to conform to any horizontal fitting radius. Can be cut to desired length.
- Standard length is 72" [6 ft.] (1.8 m) - sold individually
- Order catalog number based on loading depth.
- Furnished with three #10 x 1/2" plated self-drilling screws and a 99-9982 Barrier Strip Splice.
- (*) Insert **P** or **G**

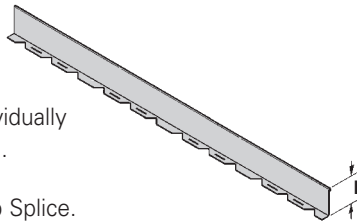

Catalog No.	Side Rail Height in. mm	Loading Depth 'H' in. mm
73(*)-90HBFL	4 (101)	3 (76)
74(*)-90HBFL	5 (127)	4 (101)
75(*)-90HBFL	6 (152)	5 (127)
76(*)-90HBFL	7 (178)	6 (152)

Barrier - Vertical Outside Bend

- Vertical Outside Bend Barriers are preformed to conform to a specific vertical outside bend fitting.
- Furnished with three #10 x 1/2" plated self-drilling screws and a 99-9982 Barrier Strip Splice.
- (*) Insert **P** or **G**
- (**) Insert 30, 45, 60 or 90 for degrees
- (t) Insert 12, 24, 36 or 48 for radius

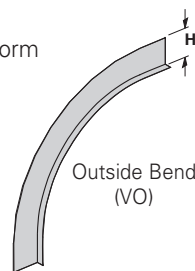

Catalog No.	Side Rail Height in. mm	Loading Depth 'H' in. mm
73(*)-(**)VO(t)	4 (101)	3 (76)
74(*)-(**)VO(t)	5 (127)	4 (101)
75(*)-(**)VO(t)	6 (152)	5 (127)
76(*)-(**)VO(t)	7 (178)	6 (152)

Barrier - Vertical Inside Bend

- Vertical Inside Bend Barriers are preformed to conform to a specific vertical inside bend fitting.
- Furnished with three #10 x 1/2" plated self-drilling screws and a 99-9982 Barrier Strip Splice.
- (*) Insert **P** or **G**
- (**) Insert 30, 45, 60 or 90 for degrees
- (t) Insert 12, 24, 36 or 48 for radius

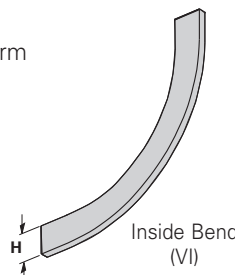

Catalog No.	Side Rail Height in. mm	Loading Depth 'H' in. mm
73(*)-(**)VI(t)	4 (101)	3 (76)
74(*)-(**)VI(t)	5 (127)	4 (101)
75(*)-(**)VI(t)	6 (152)	5 (127)
76(*)-(**)VI(t)	7 (178)	6 (152)

● Green = Fastest shipped items ● Black = Normal lead-time items ● Red = Normally long lead-time items

All dimensions in parentheses are millimeters unless otherwise specified.

Series 2, 3, 4, & 5 Steel - Accessories

Barrier Strip Clip

- Zinc plated steel barrier clip fastens to either aluminum or steel ladder rung.
- Furnished with one #10 x 1/2" zinc plated self-drilling screw.

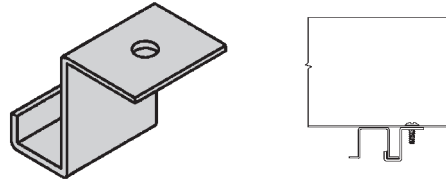

Catalog No.

● 92N-9002

Barrier Strip Splice

- Plastic splice holds adjoining barrier strips in straight alignment.
- 3" (76mm) long.

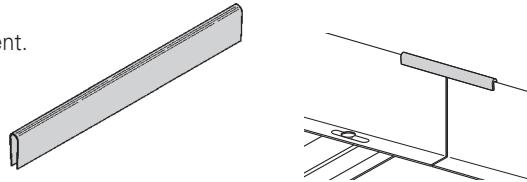

Catalog No.

● 99-9982

Bonding Jumper

Use at each expansion splice and where the cable tray is not mechanically/electrically continuous to ground. Sold individually.

- Hardware included.
- See table 392.7(B)(2) on page CTS-9 for amperage ratings required to match the UL cross-sectional area of the tray.
- See tray loading chart for UL cross-sectional area.
- Bonding jumper is 14 1/2" (368mm) long.

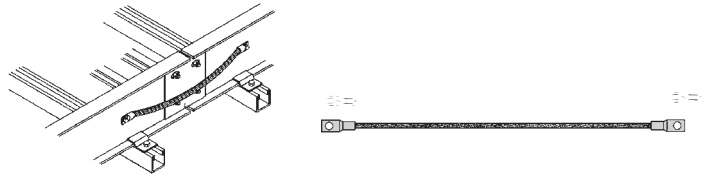

Catalog No.	Copper Wire Size	Ampacity
● 99-N1	#1	600

Grounding Clamp

B-Line series cable tray is UL® classified as to its suitability as an equipment grounding conductor. If a separate conductor for additional grounding capability is desired, we offer this clamp for bolting the conductor at least once to each cable tray section.

- Accepts #6 AWG to 250 MCM.

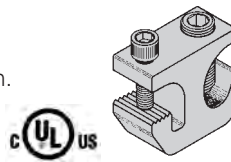

Catalog No.	Material
● 9A-2130	Tin Plated Aluminum

Ground Wire Clamp

- Mechanically attaches grounding cables to cable tray.
- Hardware included.
- (*) Insert **ZN** or **SS4**

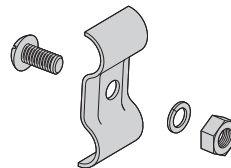

Catalog No.	Material
9(*)-2351	#1 thru 2/0
9(*)-2352	3/0 thru 250 MCM

Thread Rod (ATR) & Rod Couplings

Loading based on safety factor 5.

Standard Finish: Zinc plated
See B-Line series Strut Systems Catalog for other sizes and finishes.

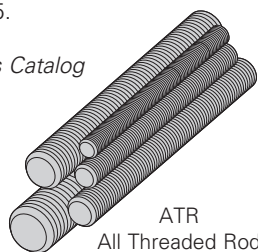
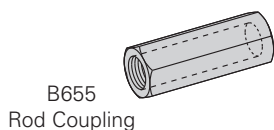

Size	Catalog No.	Available Length	Loading
All Threaded Rod			
3/8"-16	● ATR 3/8" x Length	36", 72", 120", 144"	730 lbs.
1/2"-13	● ATR 1/2" x Length	36", 72", 120", 144"	1350 lbs.
Rod Coupling			
3/8"-16	● B655-3/8"	NA	730 lbs.
1/2"-13	● B655-1/2"	NA	1350 lbs.

● Green = Fastest shipped items ● Black = Normal lead-time items ● Red = Normally long lead-time items

All dimensions in parentheses are millimeters unless otherwise specified.

Stainless Steel Cable Clamp

- Fits with series 2, 3, 4 & 5 standard steel rungs.
- Shipped flat. Field form around the cable at the time of installation.

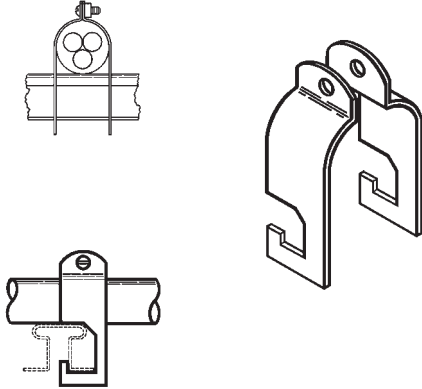

Refer to Section CF
Cable Fixing

Catalog No.	Cable Size	
	in.	mm
● 9SS4-4050	0.50 - 0.75	(13 - 19)
● 9SS4-4075	0.75 - 1.00	(19 - 25)
● 9SS4-4100	1.00 - 1.25	(25 - 32)
● 9SS4-4125	1.25 - 1.50	(32 - 38)
● 9SS4-4150	1.50 - 1.75	(38 - 45)
● 9SS4-4175	1.75 - 2.00	(45 - 51)
● 9SS4-4200	2.00 - 2.25	(51 - 57)
● 9SS4-4225	2.25 - 2.50	(57 - 64)
● 9SS4-4250	2.50 - 2.75	(64 - 70)
● 9SS4-4275	2.75 - 3.00	(70 - 76)
● 9SS4-4300	3.00 - 3.25	(76 - 82)
● 9SS4-4325	3.25 - 3.50	(82 - 89)
● 9SS4-4350	3.50 - 3.75	(89 - 95)
● 9SS4-4375	3.75 - 4.00	(95 - 100)
● 9SS4-4400	4.00 - 4.25	(100 - 106)
● 9SS4-4425	4.25 - 4.50	(106 - 113)
● 9SS4-4450	4.50 - 4.75	(113 - 121)
● 9SS4-4475	4.75 - 5.00	(121 - 125)

Hanger Rod Clamp

- For 1/2" ATR.
- Furnished in pairs.
- Order ATR and hex nuts separately.
- Two-piece "J"-hanger design.
- 1500 lbs./pair capacity safety factor 3.
- (*) Insert **ZN** or **G**

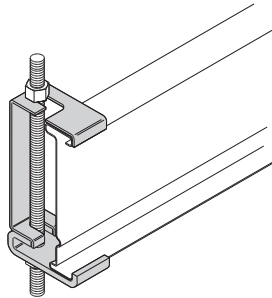

Catalog No.	Height	
	in.	mm
9(*)-5324	4	(101)
9(*)-5325	5	(127)
9(*)-5326	6	(152)
9(*)-5327	7	(178)

Cable Tray Clamp/Guide

- Features a no-twist design.
- Has four times the strength of the traditional design.
- Each side is labeled to ensure proper installation.
- Furnished in pairs, with or without hardware.
- Not recommended for vertical support.

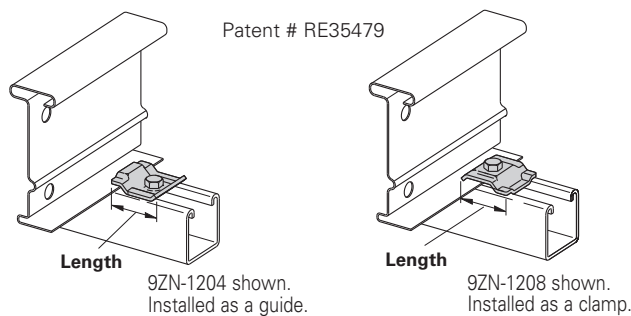

When installing this device as an expansion guide on the outside flange of *Steel Side Rail*, use the Catalog No. **B202** Square Washer in order to properly elevate the guide.

Note: For heavy duty or vertical applications see 9(*)-1241 or 9(*)-1242 page HAT-20

Catalog No.		Overall Length in. (mm)	Hardware Size in.	Finish
Without Hardware	With Hardware			
● 9ZN-1204	● 9ZN-1204NB	1 1/2 (38)	1/4"	G90
● 9ZN-1208	● 9ZN-1208NB	2 1/4 (57)	3/8"	G90
● 9A-1205	--	2 1/4 (57)	1/2"	Alum.
● 9G-1205	--	2 1/4 (57)	1/2"	HDGAF
● 9SS6-1205	--	2 1/4 (57)	1/2"	316SS
● 9ZN-1205	--	2 1/4 (57)	1/2"	G90

● Green = Fastest shipped items ● Black = Normal lead-time items ● Red = Normally long lead-time items

All dimensions in parentheses are millimeters unless otherwise specified.

Series 2, 3, 4, & 5 Steel - Accessories

Cable Tray Clamp

- Hold-down clamps for single or double cable tray runs.
- No drilling of support I-beam or channel is required.
- Sold in pieces - two clamps are required per tray.
- Maximum beam flange thickness 1 1/8" (28.58 mm).

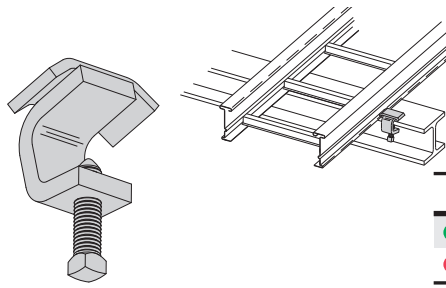

Catalog No.	Finish
● 9ZN-1249HD	Znplt
● 9G-1249HD	HDGAF

Cable Tray Guide

- Expansion guide for single or double cable tray runs.
- Guide allows for longitudinal movement of the cable tray.
- No field drilling of support I-beam or channel is required.
- Guides are required on both sides of cable tray to prevent lateral movement - can be placed on either the inside or outside flange of cable tray.
- Guides are sold in pieces - two guides are required per tray.
- Maximum flange thickness 1 1/8" (28.58 mm).

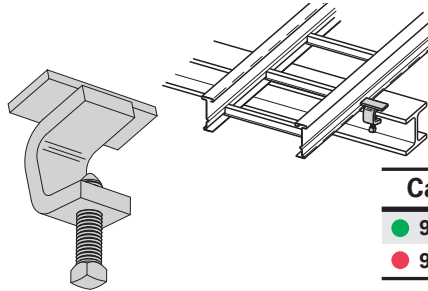

Catalog No.	Finish
● 9ZN-1249	Znplt
● 9G-1249	HDGAF

Nylon Pad

- Use for friction reduction.
- Hardness: Shore D80.
- Low friction coefficient.
- UV resistant.
- Excellent weatherability.
- UL - 94HB.

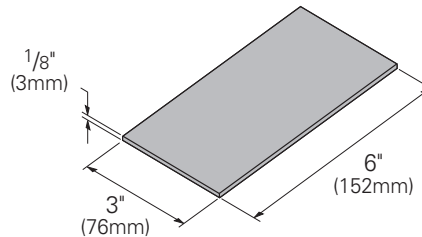

Catalog No.
● 99-PE36

Neoprene Roll

- Use for material isolation.
- 1/8" x 2" x 25' roll.
- Hardness: Shore A60.
- Good weatherability.

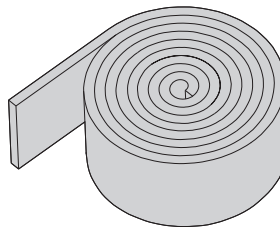

Catalog No.
● 99-NP300

DURA-BLOK™ Rooftop Support Bases with B22 Channel

- Designed as a superior rooftop support for cable tray.
- UV resistant and approved for most roofing material or other flat surfaces.
- Can be used with any of B-Line series cable tray clamps and guides.
- Ultimate Load Capacity: 1,000 lbs. (uniform load)



Catalog No.	Height x Width x Length in. (mm)
● DB10-28	5 5/8 x 6 x 28.0 (143 x 152 x 711)
● DB10-36	5 5/8 x 6 x 36.0 (143 x 152 x 914)
● DB10-42	5 5/8 x 6 x 42.0 (143 x 152 x 1067)
● DB10-50	5 5/8 x 6 x 50.0 (143 x 152 x 1270)
● DB10-60	5 5/8 x 6 x 60.0 (143 x 152 x 1524)



LEEDS credit available, base made from 100% recycled material.

General Note: Consult roofing manufacturer or engineer for roof load capacity. The weakest point may be the insulation board beneath the rubber membrane.

● Green = Fastest shipped items ● Black = Normal lead-time items ● Red = Normally long lead-time items

All dimensions in parentheses are millimeters unless otherwise specified.

Trapeze Support Kit

- Eaton's B-Line series trapeze kits provide the components required for a single trapeze support in one package. These kits are available in pre-galvanized steel with zinc-plated hardware, hot dip galvanized steel with 316 stainless steel hardware, or DURA GREEN™ painted steel with zinc-plated hardware.
- The SH channel provides the convenience of pre-punched slots, which eliminate the need for field drilling.
- The illustrated hardware is sealed in a plastic bag and boxed with the channel, which is pre-cut to the appropriate length as shown in the chart.
- Designed for use with 1/2" threaded rod. Order rod separately.

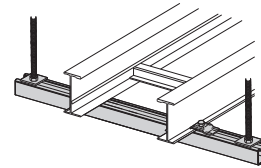
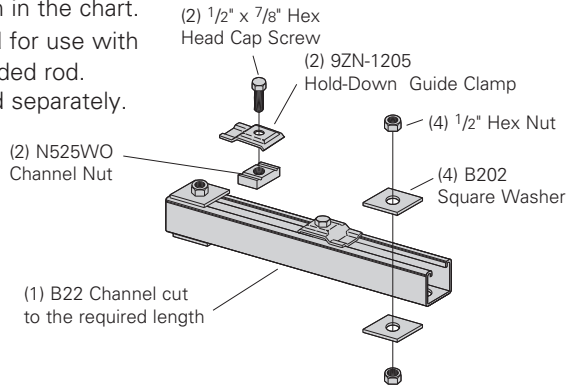

Catalog No.	Tray Width		Channel Length		Uniform Load	
	in.	mm	in.	mm	lbs	kN
● 9(*)-5506-22SH(†)	6	(152)	16	(406)	1350	(6.00)
● 9(*)-5509-22SH(†)	9	(229)	18	(457)	1250	(5.56)
● 9(*)-5512-22SH(†)	12	(305)	22	(559)	1125	(5.00)
● 9(*)-5518-22SH(†)	18	(457)	28	(711)	865	(3.85)
● 9(*)-5524-22SH(†)	24	(610)	34	(864)	700	(3.11)
● 9(*)-5530-22SH(†)	30	(762)	40	(1016)	590	(2.62)
● 9(*)-5536-22SH(†)	36	(914)	46	(1168)	510	(2.27)
● 9(*)-5542-22SH(†)	42	(1067)	52	(1321)	450	(2.00)

- (*) Insert **P** **G** or **GRN**
- (†) Insert 3/8 for 3/8" threaded rod hardware. Safety factor of 3.0 on all loads.

Heavy Duty Trapeze Support Kit

- Eaton's B-Line series trapeze kits provide the components required for a single trapeze support in one package. These kits are available in pre-galvanized steel with zinc-plated hardware, hot dip galvanized steel with 316 stainless steel hardware, or DURA GREEN™ painted steel with zinc-plated hardware.
- The SH channel provides the convenience of pre-punched slots, which eliminates the need for field drilling.
- The illustrated hardware is sealed in a plastic bag and boxed with the channel, which is pre-cut to the appropriate length as shown in the chart.
- Designed for use with 1/2" threaded rod. Order rod separately.

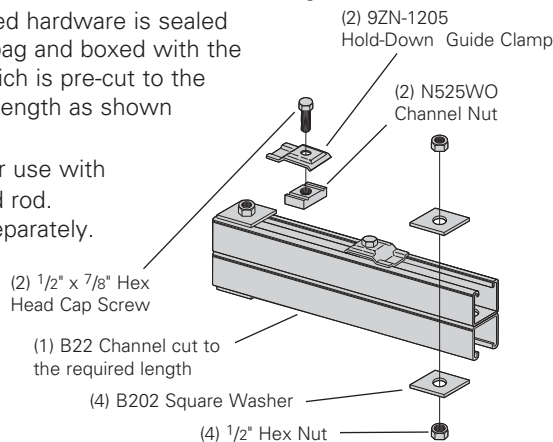

Catalog No.	Tray Width		Channel Length		Uniform Load	
	in.	mm	in.	mm	lbs	kN
● 9(*)-5506-22SHA	6	(152)	16	(406)	1350	(6.00)
● 9(*)-5509-22SHA	9	(229)	18	(457)	1350	(6.00)
● 9(*)-5512-22SHA	12	(305)	22	(559)	1350	(6.00)
● 9(*)-5518-22SHA	18	(457)	28	(711)	1350	(6.00)
● 9(*)-5524-22SHA	24	(610)	34	(864)	1350	(6.00)
● 9(*)-5530-22SHA	30	(762)	40	(1016)	1350	(6.00)
● 9(*)-5536-22SHA	36	(914)	46	(1168)	1350	(6.00)
● 9(*)-5542-22SHA	42	(1067)	52	(1321)	1350	(6.00)

- (*) Insert **P** **G** or **GRN**
- Safety factor of 3.0 on all loads.

Trapeze Hardware Kit

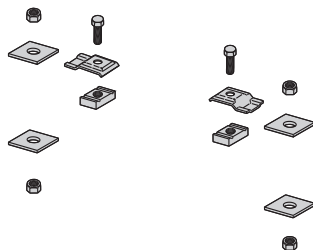

Catalog No.	● 9ZN-5500-1/2	● 9G-5500-1/2
In plastic bag	1 pr. 9ZN-1205 2 HHC Screw 1/2 x 7/8 ZN 2 N525 WO ZN 4 B202 ZN 1/2" sq washer 4 HN 1/2 ZN	1 pr. 9G-1205 2 HHC Screw 1/2 x 7/8 SS6 2 N525 WO SS6 4 B202 HDG 1/2" sq washer 4 HN 1/2 SS6

● Green = Fastest shipped items ● Black = Normal lead-time items ● Red = Normally long lead-time items

All dimensions in parentheses are millimeters unless otherwise specified.

Series 2, 3, 4, & 5 Steel - Accessories

Series 2, 3, 4, & 5 Steel

Center Hung Tray Support

- Center Hung Cable Tray Support allows cable to be laid-in from both sides.
- Eliminates costly cable pulling and field cutting of cable tray supports. Labor costs are dramatically reduced.
- Required hardware and threaded rod material for trapeze assemblies are reduced by up to 50%.
- Designed for use with 1/2" threaded rod. (Order rod separately)
- Use with all aluminum and steel cable trays through 24" width.
- Load capacity is 700 lbs. (311kN) per support. Safety factor of 3.0. Eccentric loading is not to exceed a 60% vs. 40% load differential.
- The maximum recommended unsupported span length is 144"/12 ft. (3.66 m).
- Hardware shown is furnished.
- Finish available: Zinc Plated

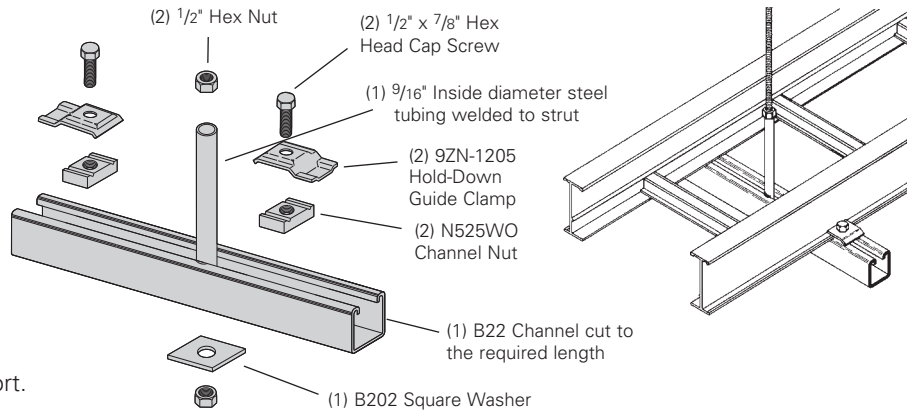

Catalog No.	Tray Width		Channel Length	
	in.	(mm)	in.	(mm)
● 9ZN-5212	6", 9", 12"	(152, 228, 305)	18"	(457)
● 9ZN-5224	18", 24"	(457, 609)	30"	(762)

Center Hung Support Hardware Kit

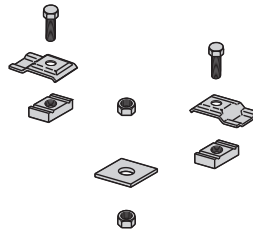

Catalog No.	● 9ZN-5200
In plastic bag	1 pr. 9ZN-1205 2 HHC Screw 1/2 x 7/8 ZN 2 N525 WO ZN 1 B202 ZN 1/2" sq washer 4 HN 1/2 ZN

Bracket (12" - 48")

- (*) Insert available finish: **ZN** **GRN** or **HDG**
- Safety Load Factor 2.5

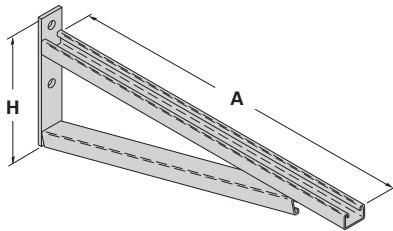

Bottom brace is B42 channel on B494-24 and smaller and B22 channel on B494-30 and larger

Catalog No.	Uniform Load lbs (kN)	Tray Width		'A'		'H'	
		in.	(mm)	in.	(mm)	in.	(mm)
● B494-12	2500 (11.12)	6 & 9	(152 & 229)	12	(305)	8 ³ / ₄	(222)
● B494-18	1700 (7.56)	12	(305)	18	(457)	8 ³ / ₄	(222)
● B494-24	1300 (5.78)	18	(457)	24	(610)	8 ³ / ₄	(222)
B494-30	1600 (7.11)	24	(610)	30	(762)	11 ¹ / ₄	(286)
B494-36	1100 (4.89)	30	(762)	36	(914)	11 ¹ / ₄	(286)
B494-42	980 (4.36)	36	(914)	42	(1067)	16	(406)
B494-48	980 (4.36)	42	(1067)	48	(1219)	16	(406)

For more dimensional data see Strut Systems catalog

Cantilever Bracket

- (*) Insert available finish: **ZN** **GRN** or **HDG**
- Safety Load Factor 2.5

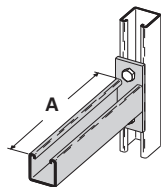

Catalog No.	Uniform Load lbs kN	Tray Width		'A'	
		in.	mm	in.	mm
B409-12	960 (4.27)	6 & 9	(152 & 229)	12	(305)
B409-18	640 (2.84)	12	(305)	18	(457)
B409-24	480 (2.13)	18	(457)	24	(610)

● Green = Fastest shipped items ● Black = Normal lead-time items ● Red = Normally long lead-time items

All dimensions in parentheses are millimeters unless otherwise specified.

Cantilever Bracket

- (*) Insert available finish: **ZN** **GRN** or **HDG**
- Safety Load Factor 2.5

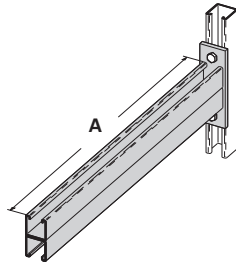

Catalog No.	Uniform Load		Tray Width		'A'	
	lbs	kN	in.	mm	in.	mm
B297-12	1660	(7.38)	6 & 9	(152 & 229)	12	(305)
B297-18	1100	(4.89)	12	(305)	18	(457)
B297-24	835	(3.71)	18	(457)	24	(610)
B297-30	665	(2.93)	24	(610)	30	(762)
B297-36	550	(2.44)	30	(762)	36	(914)
B297-42	465	(2.06)	36	(914)	42	(1067)

Underfloor Support (U-Bolts not included)

- Finishes available: **ZN**
- Safety Load Factor 2.5

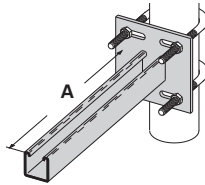

U-Bolt Size	Fits Pipe O.D.
B501-3/4	.841 - 1.050
B501-1	1.051 - 1.315
B501-1 1/4	1.316 - 1.660
B501-1 1/2	1.661 - 1.900
B501-2	1.901 - 2.375
B501-2 1/2	2.376 - 2.875

Catalog No.	Uniform Load		Tray Width		'A'	
	lbs	(kN)	in.	(mm)	in.	(mm)
B409UF-12	800	(3.56)	6 & 9	(152 & 229)	12	(305)
B409UF-21	450	(2.00)	12 & 18	(305 & 457)	21	(533)

Vertical Hanger Splice Plates

- Design load is 1500 lbs (6.67kN) per pair.
- Safety Factor of 2.5
- Furnished in pairs.
- Hole size: 9/16" (14mm) for 1/2" threaded rod.
- (*) Insert **ZN** or **G**

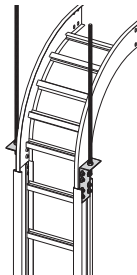
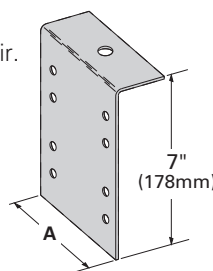

Catalog No.	Outside	'A'	
	Cable Tray Ht.	in.	(mm)
● 9(*)-8224	4"	3.84	(97.54)
● 9(*)-8225	5"	4.73	(120.14)
● 9(*)-8226	6"	5.84	(148.34)
● 9(*)-8227	7"	6.84	(173.74)

Heavy Duty Hold Down Bracket

- Design load is 2000 lbs (8.89kN) per pair.
- Two bolt design.
- Sold in pairs.
- 3/8" cable tray attachment hardware provided.
- 1/2" support attachment hardware **not** provided.
- (*) Insert **ZN** or **G**
- Recommended for support of vertical trays.

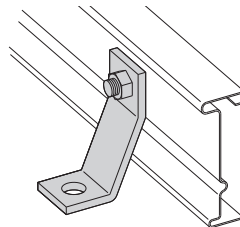

Catalog No.
9(*)-1241

Heavy Duty Hold Down Bracket

- Design load is 4000 lbs (17.79kN) per pair.
- Four bolt design.
- Sold in pairs.
- 3/8" cable tray attachment hardware provided
- 1/2" support attachment hardware **not** provided.
- (*) Insert **ZN** or **G**
- Recommended for support of vertical trays.

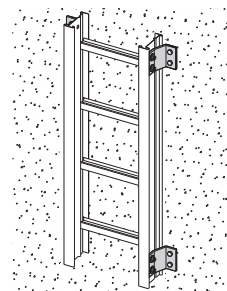
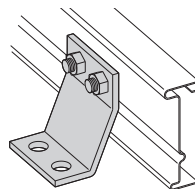

Catalog No.
9(*)-1242

Beam Clamp

- Finishes available: **ZN** **GRN** **HDG** or **SS4**
- Sold in pieces.
- Design load is 1200 lbs (5.34kN) per pair.
- Safety Load Factor 5.0.
- Order HHCS and Channel Nuts separately.

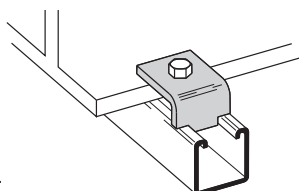

Catalog No.
B355

● Green = Fastest shipped items ● Black = Normal lead-time items ● Red = Normally long lead-time items

All dimensions in parentheses are millimeters unless otherwise specified.

Series 2, 3, 4, & 5 Steel - Accessories

Series 2, 3, 4, & 5 Steel

Beam Clamp

- Finishes available: **ZN** or **HDG**
- Sold in pieces.
- *Design load when used in pairs. Safety Load Factor 5.0

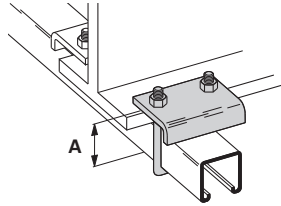

Catalog No.	Design Load lbs (kN)	'A' in. (mm)
B441-22	1200 (5.34)	3 ³ / ₈ (86)
B441-22A	1200 (5.34)	5 (127)

Beam Clamp

- Finishes available: **ZN** **GRN** or **HDG**
- Sold in pieces.
- *Design load when used in pairs. Safety Load Factor 5.0

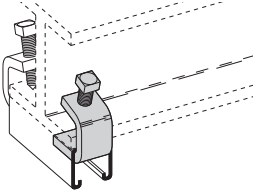

Catalog No.	B212-1/4	B212-3/8
Design Load *	600 lbs. (2.67kN)	1000 lbs. (4.45 kN)
Max. Flange Thick	3/4" (19 mm)	1 1/8" (28.6 mm)
Mat'l. Thickness	1/4" (6.3 mm)	3/8" (9.5 mm)

B305 Thru B308 & B321 Series Beam Clamps

- Finishes available: **ZN** or **HDG**
- Setscrew included.
- Safety Load Factor 5.0

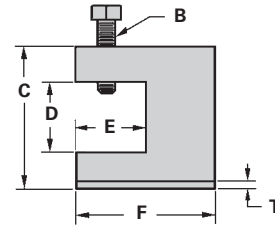
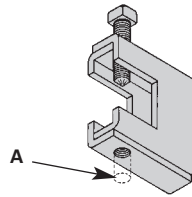

Catalog No.	Rod Size A	B	C		D		E		F		T		Design Load	
			in.	(mm)	in.	(mm)	in.	(mm)	in.	(mm)	in.	(mm)	lbs	(kN)
B305	3/8"-16	3/8"-16	2 ⁵ / ₁₆	(58.7)	7/8	(22.2)	1 1/8	(28.6)	2 1/2	(63.5)	11 Ga.	(3.0)	600	(2.67)
B306	3/8"-16	1/2"-13	2 ⁷ / ₁₆	(61.9)	7/8	(22.2)	1 1/8	(28.6)	2 1/2	(63.5)	7 Ga.	(4.5)	1100	(4.90)
B307	1/2"-13	1/2"-13	2 ⁷ / ₁₆	(61.9)	7/8	(22.2)	1 1/8	(28.6)	2 1/2	(63.5)	7 Ga.	(4.5)	1100	(4.90)
B308	1/2"-13	1/2"-13	2 ⁹ / ₁₆	(65.1)	7/8	(22.2)	1 1/8	(28.6)	2 1/2	(63.5)	1/4	(6.3)	1500	(6.68)
B321-1	3/8"-16	1/2"-13	3 ⁹ / ₁₆	(90.5)	1 11/16	(42.9)	1 ⁵ / ₈	(41.3)	3 1/4	(82.5)	1/4	(6.3)	1300	(5.79)
B321-2	1/2"-13	1/2"-13	3 ⁹ / ₁₆	(90.5)	1 11/16	(42.9)	1 ⁵ / ₈	(41.3)	3 1/4	(82.5)	1/4	(6.3)	1400	(6.23)

Anchor Strap - for B305 thru B308 & B321 Series

- Finish available: **ZN**
- For a maximum beam thickness of 3/4" (19mm).
- For thicker beams, step up one flange width size.

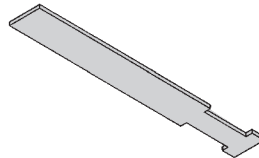

Catalog No.	Flange Width	
	in.	(mm)
B312-6	Up to 6	(Up to 152)
B312-9	6 - 9	(152 to 228)
B312-12	9 - 12	(228 to 305)

Beam Clamp

- Finish available: **ZN**
- Design Load 500 lbs. (2.22 kN)
- Safety Load Factor 5.0
- Recommended torque: 'J'-Hook Nut 125 In.-Lbs. (14.1 kN/m)
- Maximum flange thickness of 3/4" (19mm).

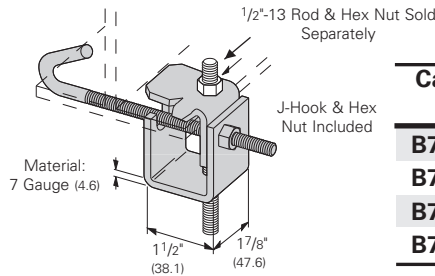

Catalog No.	For Flange Width		Wt./C	
	in.	(mm)	lbs	(kg)
B750-J4	3 - 6	(76.2 - 152.4)	109	(49.4)
B750-J6	5 - 9	(127.0 - 228.6)	124	(56.2)
B750-J9	8 - 12	(203.2 - 304.8)	135	(61.2)
B750-J12	11 - 15	(279.4 - 381.0)	147	(66.7)

'J'-Hook

- Finishes available: **ZN**
- Hex Nut included.

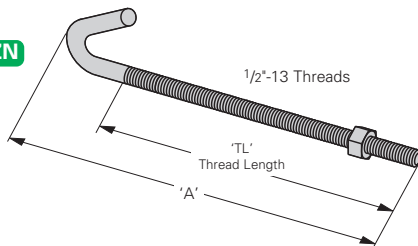

Catalog No.	'A'		'TL'		Wt./C	
	in.	(mm)	in.	(mm)	lbs	(kg)
B700-J4	8 1/2	(215.9)	5	(127.0)	44	(19.9)
B700-J6	11 1/2	(292.1)	6	(152.4)	53	(24.0)
B700-J9	12 1/4	(368.3)	6	(152.4)	63	(28.6)
B700-J12	17 1/2	(444.5)	6	(152.4)	78	(35.4)

● Green = Fastest shipped items ● Black = Normal lead-time items ● Red = Normally long lead-time items

All dimensions in parentheses are millimeters unless otherwise specified.