

Project		Catalog #		Type	
Prepared by		Notes		Date	



# Lumark

## Axcent

### Wall Mount Luminaire

#### Product Certifications & Features



#### Interactive Menu

- Ordering Information [page 2](#)
- Mounting Details [page 3](#)
- Product Specifications [page 4](#)
- Energy and Performance Data [page 4](#)
- Control Options [page 6](#)

#### Quick Facts

- Available in 12W - 116W (1,800 - 16,000 lumens) models
- Full cutoff and refractive lens models available
- Energy and maintenance savings up to 95% compared to HID
- Energy efficient illumination results in up to 177LPW
- Replaces 70W up to 450W HID equivalents

#### Connected Systems

- WaveLinx PRO Wireless
- WaveLinx LITE Wireless
- Enlighted

#### Dimensional Details

Full Cutoff

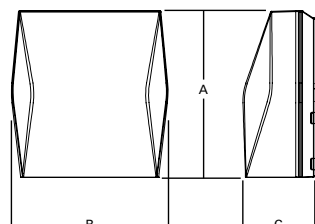

Refractive Lens

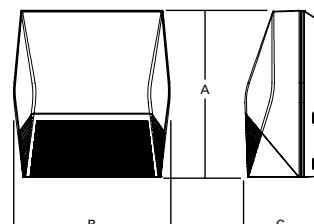

Deep Back Housing

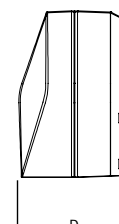

Dimensional Data

	AXCS Small	AXCL Large
A	8" [202mm]	11-1/2" [292mm]
B	7-1/2" [190mm]	10-3/4" [273mm]
C	3-5/8" [94mm]	4-7/8" [124mm]
D	6-1/8" [155mm]	7-1/8" [181mm]

## Ordering Information

SAMPLE NUMBER: **AXCS1A-AP-347V**

Domestic Preferences <sup>25</sup>	Model Series <sup>1</sup>	LED Color Temperature	Color	Options (Add as Suffix)
<b>[Blank]</b> =Standard <b>BAA</b> =Buy American Act <sup>25</sup> <b>TAA</b> =Trade Agreements Act <sup>25</sup> <b>BABAE</b> =Build America Buy America Act <sup>28</sup> <b>BABAF</b> =Build America Buy America Act <sup>28</sup>	<b>Full Cutoff</b> <b>AXCS1A</b> =12W <b>AXCS2A</b> =16W <b>AXCS3A</b> =23W <b>AXCS4A</b> =38W <b>AXCS5A</b> =45W <b>AXCL6A</b> =50W <b>AXCL8A</b> =66W <b>AXCL10A</b> =89W <b>AXCL12A</b> =116W  <b>Refractive Lens</b> <b>AXCS1ARL</b> =12W <b>AXCS2ARL</b> =16W <b>AXCS3ARL</b> =23W <b>AXCS4ARL</b> =38W <b>AXCS5ARL</b> =45W <b>AXCL6ARL</b> =50W <b>AXCL8ARL</b> =66W <b>AXCL10ARL</b> =89W <b>AXCL12ARL</b> =116W	<b>[Blank]</b> =4000K, Neutral <b>C</b> =5000K, Cool <b>W</b> =3000K, Warm	<b>[Blank]</b> =Carbon Bronze (Standard) <b>WT</b> =Summit White <b>BK</b> =Black <b>AP</b> =Grey <b>GM</b> =Graphite Metallic <b>DP</b> =Dark Platinum	<b>347V</b> =347V <sup>2</sup> <b>480V</b> =480V <sup>2</sup> <b>PC1</b> =Photocontrol 120V <sup>3,4,5</sup> <b>PC2</b> =Photocontrol 208-277V, 347V, 480V <sup>4,5,6</sup> <b>PC</b> =Photocontrol 120-277V, 347V, 480V <sup>4,7,8</sup> <b>KKIT</b> =Knuckle Floodlight Mount <sup>7</sup> <b>TRNKIT</b> =Trunnion Floodlight Mount <b>SFKIT</b> =Slipfitter Floodlight Mount <b>PMAKIT</b> =Pole Mount Arm <b>WPS2XX</b> =Wavelinx Pro, SR Driver, Dimming Motion and Daylight, WAC Programmable, 7' - 15' Mounting Height <sup>4,9,10,11,27</sup> <b>WPS4XX</b> =Wavelinx Pro, SR Driver, Dimming Motion and Daylight, WAC Programmable, 15' - 40' Mounting Height <sup>4,9,10,11,27</sup> <b>WLS2XX</b> =WaveLinx Lite, SR Driver, Dimming Motion and Daylight, Bluetooth Programmable, 7' - 15' Mounting <sup>4,9,10,11,27</sup> <b>WLS4XX</b> =WaveLinx Lite, SR Driver, Dimming Motion and Daylight, Bluetooth Programmable, 15' - 40' Mounting <sup>4,9,10,11,27</sup> <b>MSP/DIM-L12</b> =Integrated Sensor for Dimming Operation, 8' - 12' Mounting Height <sup>4,9,12</sup> <b>MSP/DIM-L30</b> =Integrated Sensor for Dimming Operation, 12' - 30' Mounting Height <sup>4,9,12</sup> <b>MSP-L12</b> =Integrated Sensor for ON/OFF Operation, 8' - 12' Mounting Height <sup>4,9,12</sup> <b>MSP-L30</b> =Integrated Sensor for ON/OFF Operation, 12' - 30' Mounting Height <sup>4,9,12</sup> <b>CBP</b> =Cold Weather Battery Pack <sup>3,13,14,15,16,27</sup> <b>CBP-CEC</b> =Cold Weather Battery Pack, CEC compliant <sup>3,13,14,15,16,27</sup> <b>10K</b> =10kV/10kA Surge Protection <b>HA</b> =50°C High Ambient <sup>14,17</sup> <b>GRF</b> =Glare Reducing Lens <sup>18</sup> <b>AHD145</b> =After Hours Dim, 5 Hours <sup>5,19</sup> <b>AHD245</b> =After Hours Dim, 6 Hours <sup>5,19</sup> <b>AHD255</b> =After Hours Dim, 7 Hours <sup>5,19</sup> <b>AHD355</b> =After Hours Dim, 8 Hours <sup>5,19</sup>
<b>Accessories (Order Separately) <sup>21,27</sup></b>				
<b>VS/AXCS-XX</b> =Vandal Shield Axcent Small <sup>7,21</sup> <b>VS/AXCS-MS</b> =Vandal Shield Axcent Small (With Motion Sensor) <sup>7,21</sup> <b>WG/AXCS</b> =Wire Guard Axcent Small <sup>7</sup> <b>WG/AXCS-MS</b> =Wire Guard Axcent Small (With Motion Sensor) <sup>7</sup> <b>VS/AXCL-XX</b> =Vandal Shield Axcent Large <sup>5,21</sup> <b>VS/AXCL-MS</b> =Vandal Shield Axcent (With Motion Sensor) <sup>5,21</sup> <b>WG/AXCL</b> =Wire Guard Axcent Large <sup>5</sup> <b>WG/AXCL-MS</b> =Wire Guard Axcent (With Motion Sensor) <sup>5</sup> <b>BB/AXC</b> =Axcent Lumen Select Back Box, Carbon Bronze <sup>22</sup> <b>BB/AXC-PC</b> =Axcent Lumen Select Back Box with PC, Carbon Bronze <sup>22,23</sup> <b>BB/AXC-WT</b> =Axcent Lumen Select Back Box, Summit White <sup>22</sup> <b>BB/AXC-WT-PC</b> =Axcent Lumen Select Back Box with PC, Summit White <sup>22,23</sup>  <b>KKIT/AXCS-XX</b> =Knuckle and Visor Floodlight Kit (For Axcent Small) <sup>7</sup> <b>SFKIT/AXCS-XX</b> =Slipfitter Floodlight Kit (For Axcent Small) <sup>7</sup> <b>TRNKIT/AXCS-XX</b> =Trunnion and Visor Floodlight Kit (For Axcent Small) <sup>7</sup> <b>TRNKIT-XX</b> =Trunnion Floodlight Kit (For Axcent Large) <sup>5</sup> <b>SFKIT-XX</b> =Slipfitter Floodlight Kit (For Axcent Large) <sup>5</sup> <b>PMAKIT-XX</b> =Pole Mount Kit <b>ISHH-01</b> =Integrated Sensor Programming Remote <sup>24</sup> <b>MA1010-XX</b> =Single Tenon Adapter for 3-1/2" O.D. Tenon <b>MA1011-XX</b> =2@180° Tenon Adapter for 3-1/2" O.D. Tenon <b>MA1017-XX</b> =Single Tenon Adapter for 2-3/8" O.D. Tenon <b>MA1018-XX</b> =2@180° Tenon Adapter for 2-3/8" O.D. Tenon				
<b>NOTES:</b> 1. DesignLights Consortium® Qualified. Refer to <a href="http://www.designlights.org">www.designlights.org</a> Qualified Products List under Family Models for details. 2. Transformer used only when ordered with motion sensor or AXCS1 through AXCS5 or AXCL6 fixture wattages. 3. Not available in 347 or 480 VAC. 4. Button photocontrol and any motion sensor (MSP or LWR) not offered together. 5. Only available on AXCL6-AXCL12 models. 6. Used with 277, 347, and 480 VAC options. 7. Only available on AXCS1-AXCS5 models. 8. This configuration may contain materials that are not RoHS compliant. Contact your lighting representative for more information. 9. Uses deep back housing. 10. Sensor passive infrared (PIR) may be overly sensitive when operating below -20°C (-4°F). For the device to be field-configurable, requires WAC Gateway components WAC-PoE and WPOE-120 in appropriate quantities. Only compatible with WaveLinx system and software and requires system components to be installed for operation. See website for more Wavelinx application information. 11. Replace XX with sensor color (WH, BZ, or BK). 12. The ISHH-01 accessory is required to adjust parameters. 13. Ambient operating temperature -20°C to 25°C for AXCL6 through AXCL10. Ambient operating temperature -20°C to 30°C on AXCS4 models. Ambient operating temperature -20°C to 40°C on AXCS1 through AXCS3 models. 14. Not available with AXCS5 or AXCL12 models. 15. Not to be mounted in upwards / inverted orientation. Downlight wall mount only for AXCS1 through AXCS4. 16. CBP cannot be used with PC and motion sensor (MSP or LWR). CBP can be used with PC or motion sensor (MSP or LWR). 17. Can not be ordered with CBP or PC options. 18. Use dedicated IES files on product website for lumen values and distributions. 19. Requires the use of PC1 or PC2 button photocontrol. See After Hours Dim supplemental guide for additional information. 20. Replace XX with color designation. 21. For use with full cutoff lens configurations only. 22. Lumen Select functionality not available in conjunction with any motion sensor option (MSP). Photocontrol back box not available with any photocontrol or motion sensor options (PC, MSP). 23. Photocontrol only operates at 120-277V input voltages. Not for use with 347 or 480V systems. 24. This tool enables adjustment to parameters including high and low modes, sensitivity, time delay, cutoff and more. Consult you lighting representative for more information. 25. Only product configurations with these designated prefixes are built to be compliant with the Buy American Act of 1933 (BAA) or Trade Agreements Act of 1979 (TAA), respectively. Please refer to <a href="#">DOMESTIC PREFERENCES</a> website for more information. Components shipped separately may be separately analyzed under domestic preference requirements. 26. Accessories sold separately will be separately analyzed under domestic preference requirements. Consult factory for further information. 27. In AXCL models, CBP cannot be used with Wavelinx sensors (WPS or WLS options). Only product configurations with these prefixes are built to be compliant with the Buy American Act of 1933 (BAA) or the Build America Buy America Act (BABA). BABA is the minimum Government compliance requirement for the Build America Buy America standards which is part of the Infrastructure and Investment Jobs Act (IIJA). Individual Government Agencies may have more stringent compliance standards. BABA designates the product will meet the standards set for FHWA. As noted these projects must receive Government Funding by October 1, 2025. BABA designates the product will meet the standards set for FHWA and FTA. As noted these projects must receive Government Funding by October 1, 2026. Please refer to the <a href="#">DOMESTIC PREFERENCES</a> website or consult the CLS Domestic Preferences team for more information. Components shipped separately may be separately analyzed under domestic preference requirements.				

## Stock Ordering Information

Model Series <sup>1</sup>			
Full Cutoff		Refractive Lens	
<b>AXCS1A</b> =12W	<b>AXCL10A</b> =102W	<b>AXCS1ARL</b> =12W	<b>AXCL10ARL</b> =89W
<b>AXCS2A</b> =16W	<b>AXCL12A</b> =123W	<b>AXCS2ARL</b> =16W	<b>AXCL12ARL</b> =116W
<b>AXCS3A</b> =23W	<b>AXCL6A-347V</b> =50W	<b>AXCS3ARL</b> =23W	<b>AXCL6ARL-347V</b> =50W
<b>AXCS4A</b> =38W	<b>AXCL8A-347V</b> =66W	<b>AXCS4ARL</b> =38W	<b>AXCL8ARL-347V</b> =66W
<b>AXCS5A</b> =45W	<b>AXCL10A-347V</b> =89W	<b>AXCS5ARL</b> =45W	<b>AXCL10ARL-347V</b> =89W
<b>AXCL6A</b> =56W	<b>AXCL12A-347V</b> =116W	<b>AXCL6ARL</b> =50W	<b>AXCL12ARL-347V</b> =116W
<b>AXCL8A</b> =72W		<b>AXCL8ARL</b> =66W	

**Note:** All stock configurations are 4000K color temperatures, standard Carbon Bronze finish, and wall mount configuration.

## Mounting Details

**Slipfitter Mount (Small)**  
Tenon OD: 2-3/8" | EPA: 0.60

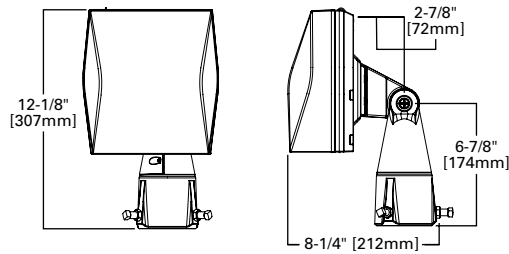

**Knuckle Mount (Small)**

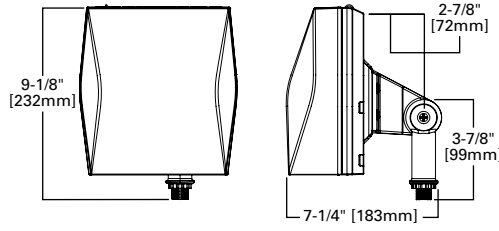

**Trunnion Mount Detail**

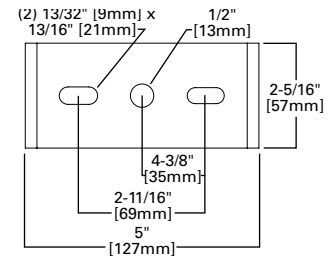

**Trunnion Mount (Small)**

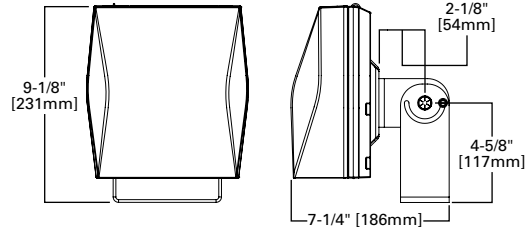

**Slipfitter Mount (Large)**  
Tenon OD: 2-3/8" to 2-7/8" | EPA: 1.10

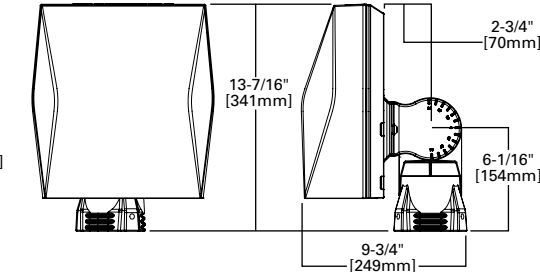

**Pole Mount Arm Drill Pattern**

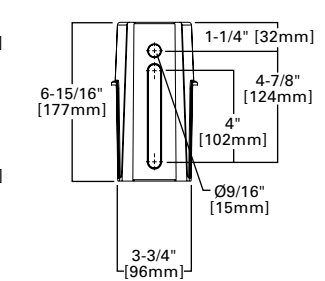

**Trunnion Mount (Large)**

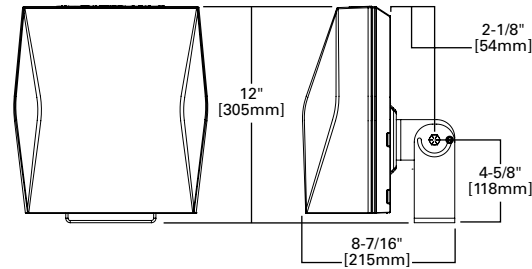

**Pole Mount Arm (Large)**  
EPA: 1.10

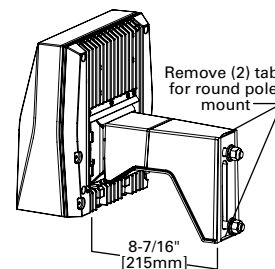

**Lumen Select Back Box**

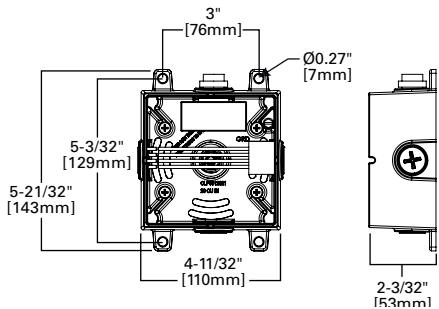

**Wall Mount Plate Detail (Large)**

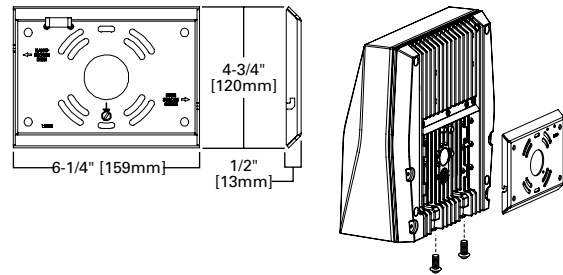

**Wall Mount Plate Detail (Small)**

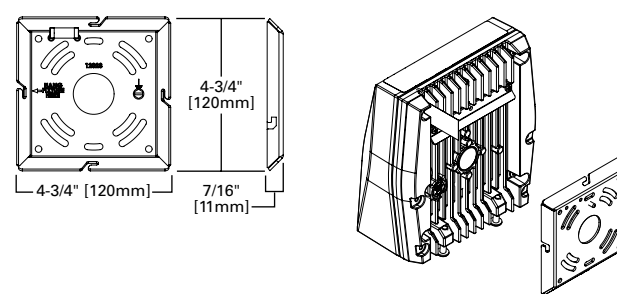

**Enlighted Sensor**

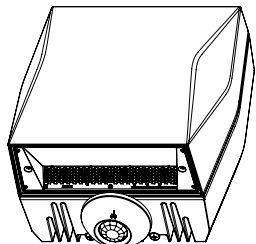

**Occupancy Sensor**

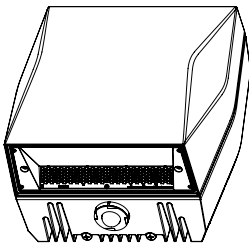

**Button Photocontrol**

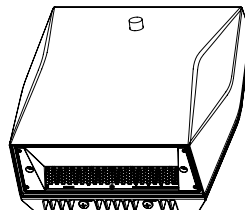

**Vandal Shield**

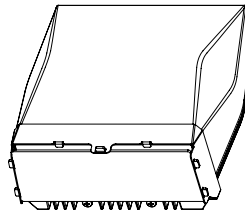

**Wire Guard**

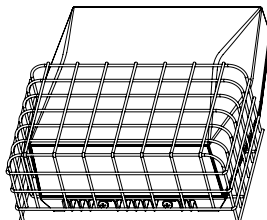

## Product Specifications

### Construction

- Die-cast aluminum housing
- External back fin design extracts heat from the surface to thermally optimize design for longer luminaire life

### Optics

- Dark Sky Approved (Fixed mount, Full cutoff, and 3000K CCT only)
- Silicone-sealed optical LED chamber
- Acrylic refractive or full cutoff lens options for Type IV distributions

### Electrical

- Standard universal voltage (120-277V, 50/60Hz)
- Driver incorporates 6kV surge protection
- -40°C minimum operating temperature
- 40°C maximum operating temperature
- <20% total harmonic distortion
- 0-10V dimming driver is standard with leads external to the fixture

### Mounting

- Steel wedge mounting plate fits directly to 4" standard j-box or directly to wall with the "Hook-N-Lock" mechanism
- Stainless steel set screws
- Lumen Select Back Box accessory offers four 1/2" NPT conduit entry wire ways. Resistor Pack combinations allow field-dimming of 75% or 50% when connected to luminaire dimming leads
- Not suitable for indoor use when installed in inverted/uplight orientation

### Emergency Egress

- Optional integral cold weather battery emergency egress includes emergency operation test switch, an AC-ON indicator light and a premium, maintenance-free battery pack
- The separate emergency lighting LEDs are wired to provide redundant emergency lighting. Listed to UL Standard 924, Emergency Lighting

### Finish

- Five-stage super TGIC polyester powder coat paint, 2.5 mil nominal thickness

### Compliance

- BAA domestic preference option meets BAA requirements
- Products that meet BABA through Exemption - Allows any product to satisfy BABA requirements regardless of domestic content manufacturing for projects funded by FHWA through Oct 1st 2025. See notes portion in Ordering Information section for more detail.
- Products that meet BABA through BAA Exemption - FHWA and FTA agencies are utilizing their BAA rules for BABA compliance. Cooper's products with a BAA designation are manufactured in the US and utilize a BAA COTS exemption rule for compliance. To verify a configured product with specific accessories and options meet BABA Domestic Preference Requirements; submit this catalog number to Cooper Lighting Quotation team for validation by our Engineering and Manufacturing teams. See notes portion in Ordering Information section for more detail.

- Please refer to the [DOMESTIC PREFERENCES](#) website or consult the CLS Domestic Preferences team for more information. Components shipped separately may be separately analyzed under domestic preference requirements.

### Shipping Data

- Small fixture=5 lbs. [2.36 kgs.]
- Small with sensor or CBP=10 lbs. [4.40 kgs.]
- Large fixture=12 lbs. [5.45 kgs.]
- Large with sensor or CBP=17 lbs. [7.73 kgs.]
- Large with sensor & CBP=21 lbs. [9.54 kgs.]

### Warranty

- Five year limited warranty, consult website for details. [www.cooperlighting.com/legal](http://www.cooperlighting.com/legal)

## Energy and Performance Data

### Power and Lumens (Axcent Small)

Light Engine	AXCS1A	AXCS2A	AXCS3A	AXCS4A	AXCS5A	
Power (Watts)	12	16	23	38	45	
Input Current @ 120V (A)	0.10	0.13	0.19	0.32	0.38	
Input Current @ 240V (A)	0.05	0.07	0.10	0.16	0.19	
Input Current @ 277V (A)	0.04	0.06	0.08	0.14	0.16	
Input Current @ 347V (A)	0.03	0.05	0.07	0.11	0.13	
Input Current @ 480V (A)	0.03	0.03	0.05	0.08	0.09	
<b>Configuration</b>						
<b>Full Cutoff</b>	4000K/5000K Lumens	1,786	2,589	3,551	5,500	6,348
	3000K Lumens	1,509	2,188	3,001	4,648	5,365
	BUG Rating	B1-U0-G0	B1-U0-G0	B1-U0-G0	B2-U0-G1	B2-U0-G1
<b>Refractive Lens</b>	4000K/5000K Lumens	1,894	2,745	3,765	5,832	6,731
	3000K Lumens	1,600	2,320	3,182	4,928	5,688
	BUG Rating	B1-U3-G2	B1-U3-G2	B1-U3-G2	B1-U4-G3	B1-U4-G3

Energy and Performance Data

Power and Lumens (Axcent Large)

Light Engine		AXCL6A	AXCL8A	AXCL10A	AXCL12A
Power (Watts)		50	66	89	115
Input Current @ 120V (A)		0.41	0.54	0.74	0.96
Input Current @ 240V (A)		0.21	0.27	0.37	0.48
Input Current @ 277V (A)		0.18	0.24	0.32	0.42
Input Current @ 347V (A)		0.14	0.19	0.26	0.33
Input Current @ 480V (A)		0.10	0.14	0.19	0.24
Configuration					
Full Cutoff	4000K Lumens	7,594	9,716	12,719	16,302
	5000K Rating	7,501	9,598	12,564	16,103
	3000K Lumens	6,502	8,319	10,890	13,958
	BUG Rating	B2-U0-G1	B2-U0-G2	B3-U0-G2	B3-U0-G2
Refractive Lens	4000K Lumens	7,809	10,331	13,665	16,637
	5000K Rating	7,714	10,205	13,498	16,434
	3000K Lumens	6,686	8,845	11,700	14,244
	BUG Rating	B1-U4-G4	B2-U5-G5	B2-U5-G5	B2-U5-G5

Power and Lumens (Small + CBP)

Light Engine		AXCS1A	AXCS2A	AXCS3A	AXCS4A
Power (Watts)		16	20	27	42
Input Current @ 120V (A)		0.13	0.17	0.23	0.35
Input Current @ 240V (A)		0.07	0.08	0.11	0.18
Input Current @ 277V (A)		0.06	0.07	0.10	0.15
Configuration					
Full Cutoff	4000K/5000K Lumens	742	792	789	644
	3000K Lumens	627	670	667	545
Refractive Lens	4000K/5000K Lumens	787	841	837	684
	3000K Lumens	664	710	708	655

Note: Power and current based on full power consumption while CBP is charging. Lumen outputs are while operating in emergency mode only.

Power and Lumens (Large + CBP)

Light Engine		AXCL6A	AXCL8A	AXCL10A
Power (Watts)		54	70	93
Input Current @ 120V (A)		0.45	0.58	0.77
Input Current @ 240V (A)		0.22	0.29	0.38
Input Current @ 277V (A)		0.19	0.25	0.33
Configuration				
Full Cutoff	4000K/5000K Lumens	141*10W=1410		
	3000K Lumens	122*10=1220		
Refractive Lens	4000K/5000K Lumens	151*10=1510		
	3000K Lumens	131*10=1310		

Note: Power and current based on full power consumption while CBP is charging. Lumen outputs are while operating in emergency mode only.

Power and Lumens Multipliers  
(Lumen Select Back Box + Axcent Small)

Configuration		~75% Nominal Output	~50% Nominal Output
Catalog Number	Material Number	Connect per Installation Instructions	
AXCS1A*	13109741 or 13109939 or Other	74%	50%
AXCS2A*	13109698 or 13109938 or Other	74%	50%
AXCS3A*	13109697 or 13109937 or Other	74%	50%
AXCS4A*	13109695 or 13109936	75%	40%
AXCS4A*	13495299 or 13495470 or Other	72%	50%
AXCS5A*	13109652 or 13109935	75%	40%
AXCS5A*	13495471 or 13495472 or Other	72%	50%

Power and Lumens Multipliers  
(Lumen Select Back Box + Axcent Large)

Configuration		~75% Nominal Output	~50% Nominal Output
Catalog Number	Material Number	Connect per Installation Instructions	
AXCL6A*	13645910 or 13645979	69%	47%
AXCL8A*	13645970 or 13645984	69%	47%
AXCL10A*	13645971 or 13645989	69%	47%
AXCL12A*	13645972 & 13645993	72%	49%

## Energy and Performance Data

### Lumen Maintenance (Axcent Small)

Ambient Temperature	TM-21 Lumen Maintenance (72,000 Hours)
<b>Up to 3A</b>	
25°C	88%
40°C	87%
50°C	87%
<b>Up to 4A</b>	
25°C	88%
40°C	87%
50°C	87%
<b>Up to 5A</b>	
25°C	87%
40°C	86%

### Lumen Maintenance (Axcent Large)

Ambient Temperature	TM-21 Lumen Maintenance (72,000 Hours)
<b>Up to 8A</b>	
25°C	89%
40°C	87%
50°C	85%
<b>Up to 10A</b>	
25°C	86%
40°C	86%
50°C	86%
<b>Up to 12A</b>	
25°C	86%
40°C	86%

### Lumen Multiplier

Ambient Temperature	Lumen Multiplier
10°C	1.02
15°C	1.01
25°C	1.00
40°C	0.97

Control Options

**0-10V** This fixture is offered standard with 0-10V dimming driver(s) for use with a lighting control panel or other control method.

**Photocontrol** (PC1, PC2 and PC) Optional button-type photocontrol provides a flexible solution to enable "dusk-to-dawn" lighting by sensing light levels.

**After Hours Dim** (AHD) This feature allows photocontrol-enabled luminaires to achieve additional energy savings by dimming during scheduled portions of the night. The dimming profile will automatically take effect after a "dusk-to-dawn" period has been calculated from the photocontrol input. Specify the desired dimming profile for a simple, factory-shipped dimming solution requiring no external control wiring. Reference the After Hours Dim supplemental guide for additional information.

**Dimming Occupancy Sensor** (MSP/DIM-LXX and MSP-LXX) These sensors are factory installed in the luminaire housing. When the MSP/DIM-LXX sensor option is selected, the occupancy sensor is connected to a dimming driver and the entire luminaire dims when there is no activity detected. When activity is detected, the luminaire returns to full light output. The MSP/DIM sensor is factory preset to dim down to approximately 50 percent power with a time delay of ten minutes. The MSP-LXX sensor is factory preset to turn the luminaire off after five minutes of no activity.

These occupancy sensors includes an integrated photocell that can be activated with the ISHH-01 accessory for "dusk-to-dawn" control or daylight harvesting - the factory preset is ON. The ISHH-01 is a wireless tool utilized for changing the dimming level, time delay, sensitivity and other parameters.

A variety of sensor lens are available to optimize the coverage pattern for mounting heights from 8'-30'.

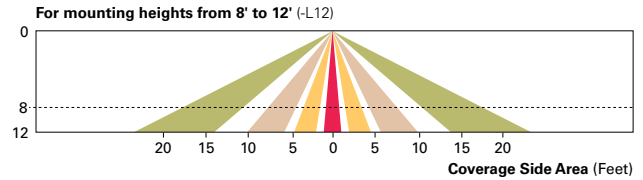
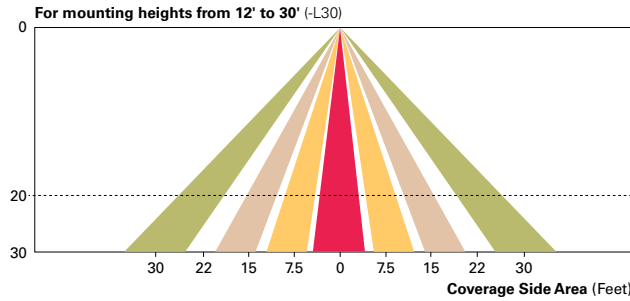

**WaveLinx Wireless Control and Monitoring System** The WaveLinx Outdoor control platform operates on a wireless mesh network based on IEEE 802.15.4 standards enabling wireless control of outdoor lighting. Use the WaveLinx Mobile application for set-up and configuration. At least one Wireless Area Controller (WAC) is required for full functionality and remote communication (including adjustment of any factory pre-sets).

**WaveLinx Wireless Sensor** (WPS2 and WPS4) These outdoor sensors offer passive infrared (PIR) occupancy and a photocell for closed loop daylight sensing. These sensors are factory preset to dim down to approximately 50 percent power after 15 minutes of no activity detected. These occupancy sensors include an integral photocell for "dusk-to-dawn" control or daylight harvesting that is factory-enabled. A variety of sensor lenses are available to optimize the coverage pattern for mounting heights from 7'-40'.

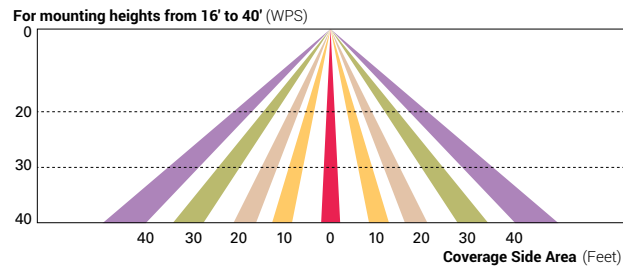

Project		Catalog #		Type	
Prepared by		Notes		Date	



# Lumark

## Axcent

### Wall Mount Luminaire

#### Product Certifications & Features



#### Interactive Menu

- Ordering Information page 2
- Mounting Details page 3
- Product Specifications page 4
- Energy and Performance Data page 4
- Control Options page 6

#### Quick Facts

- Available in 12W - 116W (1,800 - 16,000 lumens) models
- Full cutoff and refractive lens models available
- Energy and maintenance savings up to 95% compared to HID
- Energy efficient illumination results in up to 177LPW
- Replaces 70W up to 450W HID equivalents

#### Connected Systems

- WaveLinx PRO Wireless
- WaveLinx LITE Wireless
- Enlighted

#### Dimensional Details

Full Cutoff

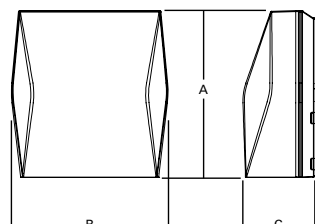

Refractive Lens

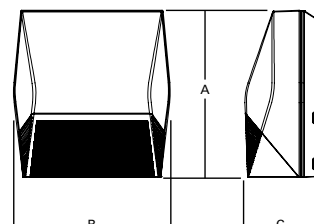

Deep Back Housing

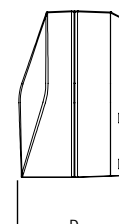

Dimensional Data

	AXCS Small	AXCL Large
A	8" [202mm]	11-1/2" [292mm]
B	7-1/2" [190mm]	10-3/4" [273mm]
C	3-5/8" [94mm]	4-7/8" [124mm]
D	6-1/8" [155mm]	7-1/8" [181mm]

Ordering Information

SAMPLE NUMBER: AXCS1A-AP-347V

Domestic Preferences <sup>25</sup>	Model Series <sup>1</sup>	LED Color Temperature	Color	Options (Add as Suffix)
<p>[Blank]=Standard  <b>BA</b>=Buy American Act <sup>25</sup>  <b>TAA</b>=Trade Agreements Act <sup>25</sup>  <b>BABAE</b>=Build America Buy America Act <sup>28</sup>  <b>BABAF</b>=Build America Buy America Act <sup>28</sup></p>	<p><b>Full Cutoff</b>  <b>AXCS1A</b>=12W  <b>AXCS2A</b>=16W  <b>AXCS3A</b>=23W  <b>AXCS4A</b>=38W  <b>AXCS5A</b>=45W  <b>AXCL6A</b>=50W  <b>AXCL8A</b>=66W  <b>AXCL10A</b>=89W  <b>AXCL12A</b>=116W</p> <p><b>Refractive Lens</b>  <b>AXCS1ARL</b>=12W  <b>AXCS2ARL</b>=16W  <b>AXCS3ARL</b>=23W  <b>AXCS4ARL</b>=38W  <b>AXCS5ARL</b>=45W  <b>AXCL6ARL</b>=50W  <b>AXCL8ARL</b>=66W  <b>AXCL10ARL</b>=89W  <b>AXCL12ARL</b>=116W</p>	<p>[Blank]=4000K, Neutral  <b>C</b>=5000K, Cool  <b>W</b>=3000K, Warm</p>	<p>[Blank]=Carbon Bronze (Standard)  <b>WT</b>=Summit White  <b>BK</b>=Black  <b>AP</b>=Grey  <b>GM</b>=Graphite Metallic  <b>DP</b>=Dark Platinum</p>	<p><b>347V</b>=347V<sup>2</sup>  <b>480V</b>=480V<sup>2</sup>  <b>PC1</b>=Photocontrol 120V<sup>3,4,5</sup>  <b>PC2</b>=Photocontrol 208-277V, 347V, 480V<sup>4,5,6</sup>  <b>PC</b>=Photocontrol 120-277V, 347V, 480V<sup>4,7,8</sup>  <b>KKIT</b>=Knuckle Floodlight Mount <sup>7</sup>  <b>TRNKIT</b>=Trunnion Floodlight Mount  <b>SFKIT</b>=Slipfitter Floodlight Mount  <b>PMAKIT</b>=Pole Mount Arm  <b>WPS2XX</b>=Wavelinx Pro, SR Driver, Dimming Motion and Daylight, WAC Programmable, 7' - 15' Mounting Height <sup>4,9,10,11,27</sup>  <b>WPS4XX</b>=Wavelinx Pro, SR Driver, Dimming Motion and Daylight, WAC Programmable, 15' - 40' Mounting Height <sup>4,9,10,11,27</sup>  <b>WLS2XX</b>=WaveLinx Lite, SR Driver, Dimming Motion and Daylight, Bluetooth Programmable, 7' - 15' Mounting <sup>4,9,10,11,27</sup>  <b>WLS4XX</b>=WaveLinx Lite, SR Driver, Dimming Motion and Daylight, Bluetooth Programmable, 15' - 40' Mounting <sup>4,9,10,11,27</sup>  <b>MSP/DIM-L12</b>=Integrated Sensor for Dimming Operation, 8' - 12' Mounting Height <sup>4,9,12</sup>  <b>MSP/DIM-L30</b>=Integrated Sensor for Dimming Operation, 12' - 30' Mounting Height <sup>4,9,12</sup>  <b>MSP-L12</b>=Integrated Sensor for ON/OFF Operation, 8' - 12' Mounting Height <sup>4,9,12</sup>  <b>MSP-L30</b>=Integrated Sensor for ON/OFF Operation, 12' - 30' Mounting Height <sup>4,9,12</sup>  <b>CBP</b>=Cold Weather Battery Pack <sup>3,13,14,15,16,27</sup>  <b>CBP-CEC</b>=Cold Weather Battery Pack, CEC compliant <sup>3,13,14,15,16,27</sup>  <b>10K</b>=10kV/10kA Surge Protection  <b>HA</b>=50°C High Ambient <sup>14,17</sup>  <b>GRF</b>=Glare Reducing Lens <sup>18</sup>  <b>AHD145</b>=After Hours Dim, 5 Hours <sup>5,19</sup>  <b>AHD245</b>=After Hours Dim, 6 Hours <sup>5,19</sup>  <b>AHD255</b>=After Hours Dim, 7 Hours <sup>5,19</sup>  <b>AHD355</b>=After Hours Dim, 8 Hours <sup>5,19</sup></p>
Accessories (Order Separately) <sup>21,27</sup>				
<p><b>VS/AXCS-XX</b>=Vandal Shield Axcent Small <sup>7,21</sup>  <b>VS/AXCS-MS</b>=Vandal Shield Axcent Small (With Motion Sensor) <sup>7,21</sup>  <b>WG/AXCS</b>=Wire Guard Axcent Small <sup>7</sup>  <b>WG/AXCS-MS</b>=Wire Guard Axcent Small (With Motion Sensor) <sup>7</sup>  <b>VS/AXCL-XX</b>=Vandal Shield Axcent Large <sup>5,21</sup>  <b>VS/AXCL-MS</b>=Vandal Shield Axcent (With Motion Sensor) <sup>5,21</sup>  <b>WG/AXCL</b>=Wire Guard Axcent Large <sup>5</sup>  <b>WG/AXCL-MS</b>=Wire Guard Axcent (With Motion Sensor) <sup>5</sup>  <b>BB/AXC</b>=Axcent Lumen Select Back Box, Carbon Bronze <sup>22</sup>  <b>BB/AXC-PC</b>=Axcent Lumen Select Back Box with PC, Carbon Bronze <sup>22,23</sup>  <b>BB/AXC-WT</b>=Axcent Lumen Select Back Box, Summit White <sup>22</sup>  <b>BB/AXC-WT-PC</b>=Axcent Lumen Select Back Box with PC, Summit White <sup>22,23</sup></p> <p><b>KKIT/AXCS-XX</b>=Knuckle and Visor Floodlight Kit (For Axcent Small) <sup>7</sup>  <b>SFKIT/AXCS-XX</b>=Slipfitter Floodlight Kit (For Axcent Small) <sup>7</sup>  <b>TRNKIT/AXCS-XX</b>=Trunnion and Visor Floodlight Kit (For Axcent Small) <sup>7</sup>  <b>TRNKIT-XX</b>=Trunnion Floodlight Kit (For Axcent Large) <sup>5</sup>  <b>SFKIT-XX</b>=Slipfitter Floodlight Kit (For Axcent Large) <sup>5</sup>  <b>PMAKIT-XX</b>=Pole Mount Kit  <b>ISHH-01</b>=Integrated Sensor Programming Remote <sup>24</sup>  <b>MA1010-XX</b>=Single Tenon Adapter for 3-1/2" O.D. Tenon  <b>MA1011-XX</b>=2@180° Tenon Adapter for 3-1/2" O.D. Tenon  <b>MA1017-XX</b>=Single Tenon Adapter for 2-3/8" O.D. Tenon  <b>MA1018-XX</b>=2@180° Tenon Adapter for 2-3/8" O.D. Tenon</p>				
<p><b>NOTES:</b></p> <ol style="list-style-type: none"> <li>DesignLights Consortium® Qualified. Refer to <a href="http://www.designlights.org">www.designlights.org</a> Qualified Products List under Family Models for details.</li> <li>Transformer used only when ordered with motion sensor or AXCS1 through AXCS5 or AXCL6 fixture wattages.</li> <li>Not available in 347 or 480 VAC.</li> <li>Button photocontrol and any motion sensor (MSP or LWR) not offered together.</li> <li>Only available on AXCL6-AXCL12 models.</li> <li>Used with 277, 347, and 480 VAC options.</li> <li>Only available on AXCS1-AXCS5 models.</li> <li>This configuration may contain materials that are not RoHS compliant. Contact your lighting representative for more information.</li> <li>Uses deep back housing.</li> <li>Sensor passive infrared (PIR) may be overly sensitive when operating below -20°C (-4°F). For the device to be field-configurable, requires WAC Gateway components WAC-PoE and WPOE-120 in appropriate quantities. Only compatible with WaveLinx system and software and requires system components to be installed for operation. See website for more Wavelinx application information.</li> <li>Replace XX with sensor color (WH, BZ, or BK).</li> <li>The ISHH-01 accessory is required to adjust parameters.</li> <li>Ambient operating temperature -20°C to 25°C for AXCL6 through AXCL10. Ambient operating temperature -20°C to 30°C on AXCS4 models. Ambient operating temperature -20°C to 40°C on AXCS1 through AXCS3 models.</li> <li>Not available with AXCS5 or AXCL12 models.</li> <li>Not to be mounted in upwards / inverted orientation. Downlight wall mount only for AXCS1 through AXCS4.</li> <li>CBP cannot be used with PC and motion sensor (MSP or LWR). CBP can be used with PC or motion sensor (MSP or LWR).</li> <li>Can not be ordered with CBP or PC options.</li> <li>Use dedicated IES files on product website for lumen values and distributions.</li> <li>Requires the use of PC1 or PC2 button photocontrol. See After Hours Dim supplemental guide for additional information.</li> <li>Replace XX with color designation.</li> <li>For use with full cutoff lens configurations only.</li> <li>Lumen Select functionality not available in conjunction with any motion sensor option (MSP).</li> <li>Photocontrol back box not available with any photocontrol or motion sensor options (PC, MSP).</li> <li>Photocontrol only operates at 120-277V input voltages. Not for use with 347 or 480V systems.</li> <li>This tool enables adjustment to parameters including high and low modes, sensitivity, time delay, cutoff and more. Consult you lighting representative for more information.</li> <li>Only product configurations with these designated prefixes are built to be compliant with the Buy American Act of 1933 (BAA) or Trade Agreements Act of 1979 (TAA), respectively. Please refer to <a href="#">DOMESTIC PREFERENCES</a> website for more information. Components shipped separately may be separately analyzed under domestic preference requirements.</li> <li>Accessories sold separately will be separately analyzed under domestic preference requirements. Consult factory for further information.</li> <li>In AXCL models, CBP cannot be used with Wavelinx sensors (WPS or WLS options).</li> <li>Only product configurations with these prefixes are built to be compliant with the Buy American Act of 1933 (BAA) or the Build America Buy America Act (BABA). BABA is the minimum Government compliance requirement for the Build America Buy America standards which is part of the Infrastructure and Investment Jobs Act (IIJA). Individual Government Agencies may have more stringent compliance standards. BABAEE designates the product will meet the standards set for FHWA. As noted these projects must receive Government Funding by October 1, 2025. BABAEE designates the product will meet the standards set for FHWA and FTA. As noted these projects must receive Government Funding by October 1, 2026. Please refer to the <a href="#">DOMESTIC PREFERENCES</a> website or consult the CLS Domestic Preferences team for more information. Components shipped separately may be separately analyzed under domestic preference requirements.</li> </ol>				

Stock Ordering Information

Model Series <sup>1</sup>			
Full Cutoff		Refractive Lens	
AXCS1A=12W	AXCL10A=102W	AXCS1ARL=12W	AXCL10ARL=89W
AXCS2A=16W	AXCL12A=123W	AXCS2ARL=16W	AXCL12ARL=116W
AXCS3A=23W	AXCL6A-347V=50W	AXCS3ARL=23W	AXCL6ARL-347V=50W
AXCS4A=38W	AXCL8A-347V=66W	AXCS4ARL=38W	AXCL8ARL-347V=66W
AXCS5A=45W	AXCL10A-347V=89W	AXCS5ARL=45W	AXCL10ARL-347V=89W
AXCL6A=56W	AXCL12A-347V=116W	AXCL6ARL=50W	AXCL12ARL-347V=116W
AXCL8A=72W		AXCL8ARL=66W	

Note: All stock configurations are 4000K color temperatures, standard Carbon Bronze finish, and wall mount configuration.

## Mounting Details

**Slipfitter Mount (Small)**  
Tenon OD: 2-3/8" | EPA: 0.60

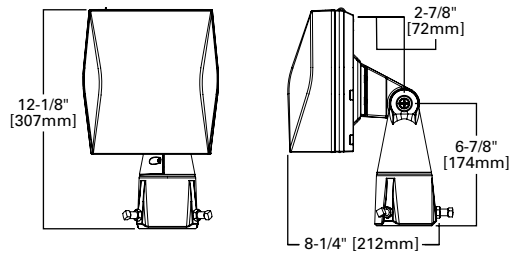

**Knuckle Mount (Small)**

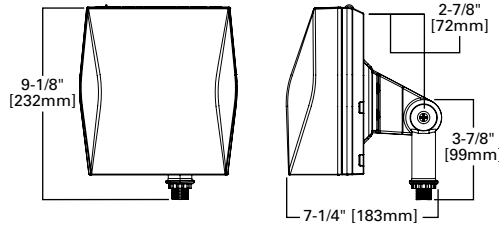

**Trunnion Mount Detail**

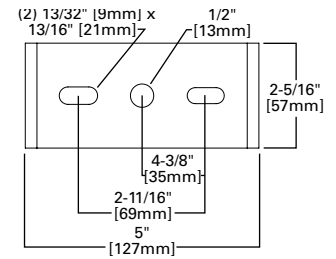

**Trunnion Mount (Small)**

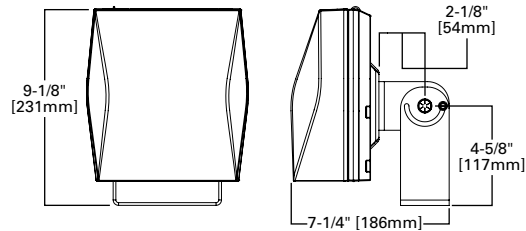

**Slipfitter Mount (Large)**  
Tenon OD: 2-3/8" to 2-7/8" | EPA: 1.10

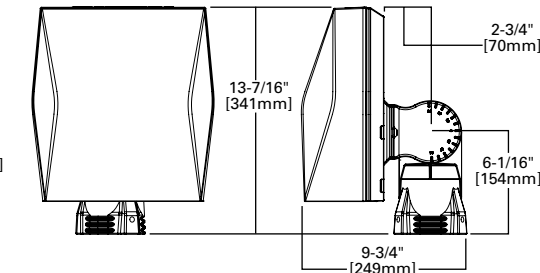

**Pole Mount Arm Drill Pattern**

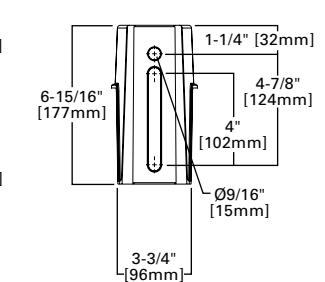

**Trunnion Mount (Large)**

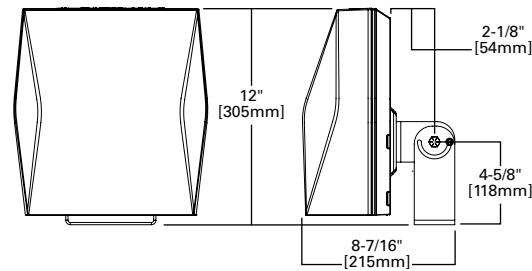

**Pole Mount Arm (Large)**  
EPA: 1.10

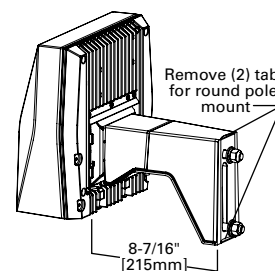

**Lumen Select Back Box**

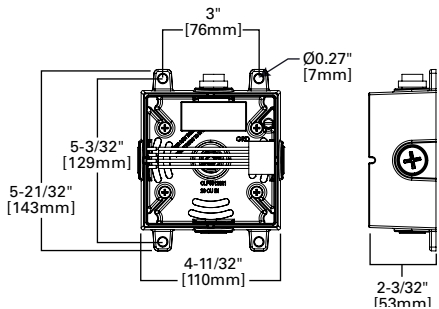

**Wall Mount Plate Detail (Large)**

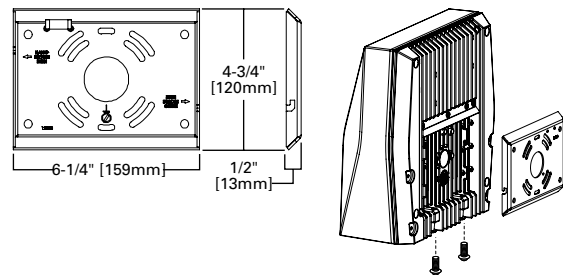

**Wall Mount Plate Detail (Small)**

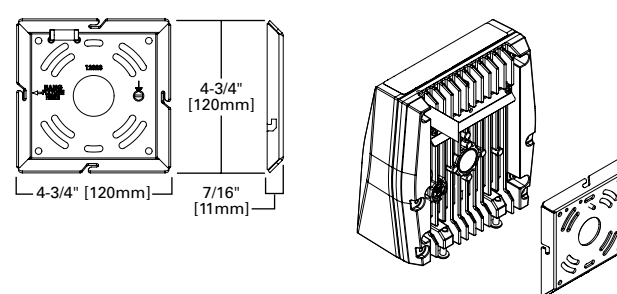

**Enlighted Sensor**

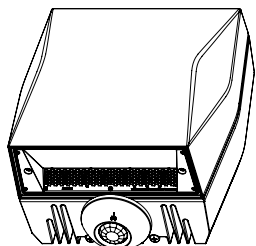

**Occupancy Sensor**

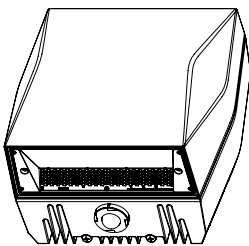

**Button Photocontrol**

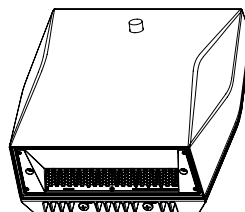

**Vandal Shield**

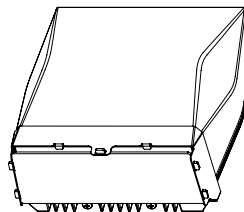

**Wire Guard**

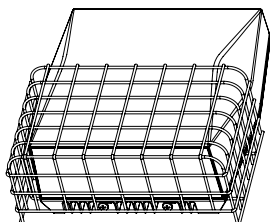

## Product Specifications

### Construction

- Die-cast aluminum housing
- External back fin design extracts heat from the surface to thermally optimize design for longer luminaire life

### Optics

- Dark Sky Approved (Fixed mount, Full cutoff, and 3000K CCT only)
- Silicone-sealed optical LED chamber
- Acrylic refractive or full cutoff lens options for Type IV distributions

### Electrical

- Standard universal voltage (120-277V, 50/60Hz)
- Driver incorporates 6kV surge protection
- -40°C minimum operating temperature
- 40°C maximum operating temperature
- <20% total harmonic distortion
- 0-10V dimming driver is standard with leads external to the fixture

### Mounting

- Steel wedge mounting plate fits directly to 4" standard j-box or directly to wall with the "Hook-N-Lock" mechanism
- Stainless steel set screws
- Lumen Select Back Box accessory offers four 1/2" NPT conduit entry wire ways. Resistor Pack combinations allow field-dimming of 75% or 50% when connected to luminaire dimming leads
- Not suitable for indoor use when installed in inverted/uplight orientation

### Emergency Egress

- Optional integral cold weather battery emergency egress includes emergency operation test switch, an AC-ON indicator light and a premium, maintenance-free battery pack
- The separate emergency lighting LEDs are wired to provide redundant emergency lighting. Listed to UL Standard 924, Emergency Lighting

### Finish

- Five-stage super TGIC polyester powder coat paint, 2.5 mil nominal thickness

### Compliance

- BAA domestic preference option meets BAA requirements
- Products that meet BABA through Exemption - Allows any product to satisfy BABA requirements regardless of domestic content manufacturing for projects funded by FHWA through Oct 1st 2025. See notes portion in Ordering Information section for more detail.
- Products that meet BABA through BAA Exemption - FHWA and FTA agencies are utilizing their BAA rules for BABA compliance. Cooper's products with a BAA designation are manufactured in the US and utilize a BAA COTS exemption rule for compliance. To verify a configured product with specific accessories and options meet BABA Domestic Preference Requirements; submit this catalog number to Cooper Lighting Quotation team for validation by our Engineering and Manufacturing teams. See notes portion in Ordering Information section for more detail.

- Please refer to the [DOMESTIC PREFERENCES](#) website or consult the CLS Domestic Preferences team for more information. Components shipped separately may be separately analyzed under domestic preference requirements.

### Shipping Data

- Small fixture=5 lbs. [2.36 kgs.]
- Small with sensor or CBP=10 lbs. [4.40 kgs.]
- Large fixture=12 lbs. [5.45 kgs.]
- Large with sensor or CBP=17 lbs. [7.73 kgs.]
- Large with sensor & CBP=21 lbs. [9.54 kgs.]

### Warranty

- Five year limited warranty, consult website for details. [www.cooperlighting.com/legal](http://www.cooperlighting.com/legal)

## Energy and Performance Data

### Power and Lumens (Axcent Small)

Light Engine	AXCS1A	AXCS2A	AXCS3A	AXCS4A	AXCS5A	
Power (Watts)	12	16	23	38	45	
Input Current @ 120V (A)	0.10	0.13	0.19	0.32	0.38	
Input Current @ 240V (A)	0.05	0.07	0.10	0.16	0.19	
Input Current @ 277V (A)	0.04	0.06	0.08	0.14	0.16	
Input Current @ 347V (A)	0.03	0.05	0.07	0.11	0.13	
Input Current @ 480V (A)	0.03	0.03	0.05	0.08	0.09	
Configuration						
Full Cutoff	4000K/5000K Lumens	1,786	2,589	3,551	5,500	6,348
	3000K Lumens	1,509	2,188	3,001	4,648	5,365
	BUG Rating	B1-U0-G0	B1-U0-G0	B1-U0-G0	B2-U0-G1	B2-U0-G1
Refractive Lens	4000K/5000K Lumens	1,894	2,745	3,765	5,832	6,731
	3000K Lumens	1,600	2,320	3,182	4,928	5,688
	BUG Rating	B1-U3-G2	B1-U3-G2	B1-U3-G2	B1-U4-G3	B1-U4-G3

Energy and Performance Data

Power and Lumens (Axcent Large)

Light Engine		AXCL6A	AXCL8A	AXCL10A	AXCL12A
Power (Watts)		50	66	89	115
Input Current @ 120V (A)		0.41	0.54	0.74	0.96
Input Current @ 240V (A)		0.21	0.27	0.37	0.48
Input Current @ 277V (A)		0.18	0.24	0.32	0.42
Input Current @ 347V (A)		0.14	0.19	0.26	0.33
Input Current @ 480V (A)		0.10	0.14	0.19	0.24
Configuration					
Full Cutoff	4000K Lumens	7,594	9,716	12,719	16,302
	5000K Rating	7,501	9,598	12,564	16,103
	3000K Lumens	6,502	8,319	10,890	13,958
	BUG Rating	B2-U0-G1	B2-U0-G2	B3-U0-G2	B3-U0-G2
Refractive Lens	4000K Lumens	7,809	10,331	13,665	16,637
	5000K Rating	7,714	10,205	13,498	16,434
	3000K Lumens	6,686	8,845	11,700	14,244
	BUG Rating	B1-U4-G4	B2-U5-G5	B2-U5-G5	B2-U5-G5

Power and Lumens (Small + CBP)

Light Engine		AXCS1A	AXCS2A	AXCS3A	AXCS4A
Power (Watts)		16	20	27	42
Input Current @ 120V (A)		0.13	0.17	0.23	0.35
Input Current @ 240V (A)		0.07	0.08	0.11	0.18
Input Current @ 277V (A)		0.06	0.07	0.10	0.15
Configuration					
Full Cutoff	4000K/5000K Lumens	742	792	789	644
	3000K Lumens	627	670	667	545
Refractive Lens	4000K/5000K Lumens	787	841	837	684
	3000K Lumens	664	710	708	655

Note: Power and current based on full power consumption while CBP is charging. Lumen outputs are while operating in emergency mode only.

Power and Lumens (Large + CBP)

Light Engine		AXCL6A	AXCL8A	AXCL10A
Power (Watts)		54	70	93
Input Current @ 120V (A)		0.45	0.58	0.77
Input Current @ 240V (A)		0.22	0.29	0.38
Input Current @ 277V (A)		0.19	0.25	0.33
Configuration				
Full Cutoff	4000K/5000K Lumens	141*10W=1410		
	3000K Lumens	122*10=1220		
Refractive Lens	4000K/5000K Lumens	151*10=1510		
	3000K Lumens	131*10=1310		

Note: Power and current based on full power consumption while CBP is charging. Lumen outputs are while operating in emergency mode only.

Power and Lumens Multipliers  
(Lumen Select Back Box + Axcent Small)

Configuration		~75% Nominal Output	~50% Nominal Output
Catalog Number	Material Number	Connect per Installation Instructions	
AXCS1A*	13109741 or 13109939 or Other	74%	50%
AXCS2A*	13109698 or 13109938 or Other	74%	50%
AXCS3A*	13109697 or 13109937 or Other	74%	50%
AXCS4A*	13109695 or 13109936	75%	40%
AXCS4A*	13495299 or 13495470 or Other	72%	50%
AXCS5A*	13109652 or 13109935	75%	40%
AXCS5A*	13495471 or 13495472 or Other	72%	50%

Power and Lumens Multipliers  
(Lumen Select Back Box + Axcent Large)

Configuration		~75% Nominal Output	~50% Nominal Output
Catalog Number	Material Number	Connect per Installation Instructions	
AXCL6A*	13645910 or 13645979	69%	47%
AXCL8A*	13645970 or 13645984	69%	47%
AXCL10A*	13645971 or 13645989	69%	47%
AXCL12A*	13645972 & 13645993	72%	49%

## Energy and Performance Data

### Lumen Maintenance (Axcent Small)

Ambient Temperature	TM-21 Lumen Maintenance (72,000 Hours)
<b>Up to 3A</b>	
25°C	88%
40°C	87%
50°C	87%
<b>Up to 4A</b>	
25°C	88%
40°C	87%
50°C	87%
<b>Up to 5A</b>	
25°C	87%
40°C	86%

### Lumen Maintenance (Axcent Large)

Ambient Temperature	TM-21 Lumen Maintenance (72,000 Hours)
<b>Up to 8A</b>	
25°C	89%
40°C	87%
50°C	85%
<b>Up to 10A</b>	
25°C	86%
40°C	86%
50°C	86%
<b>Up to 12A</b>	
25°C	86%
40°C	86%

### Lumen Multiplier

Ambient Temperature	Lumen Multiplier
10°C	1.02
15°C	1.01
25°C	1.00
40°C	0.97

Control Options

**0-10V** This fixture is offered standard with 0-10V dimming driver(s) for use with a lighting control panel or other control method.

**Photocontrol** (PC1, PC2 and PC) Optional button-type photocontrol provides a flexible solution to enable "dusk-to-dawn" lighting by sensing light levels.

**After Hours Dim** (AHD) This feature allows photocontrol-enabled luminaires to achieve additional energy savings by dimming during scheduled portions of the night. The dimming profile will automatically take effect after a "dusk-to-dawn" period has been calculated from the photocontrol input. Specify the desired dimming profile for a simple, factory-shipped dimming solution requiring no external control wiring. Reference the After Hours Dim supplemental guide for additional information.

**Dimming Occupancy Sensor** (MSP/DIM-LXX and MSP-LXX) These sensors are factory installed in the luminaire housing. When the MSP/DIM-LXX sensor option is selected, the occupancy sensor is connected to a dimming driver and the entire luminaire dims when there is no activity detected. When activity is detected, the luminaire returns to full light output. The MSP/DIM sensor is factory preset to dim down to approximately 50 percent power with a time delay of ten minutes. The MSP-LXX sensor is factory preset to turn the luminaire off after five minutes of no activity.

These occupancy sensors includes an integrated photocell that can be activated with the ISHH-01 accessory for "dusk-to-dawn" control or daylight harvesting - the factory preset is ON. The ISHH-01 is a wireless tool utilized for changing the dimming level, time delay, sensitivity and other parameters.

A variety of sensor lens are available to optimize the coverage pattern for mounting heights from 8'-30'.

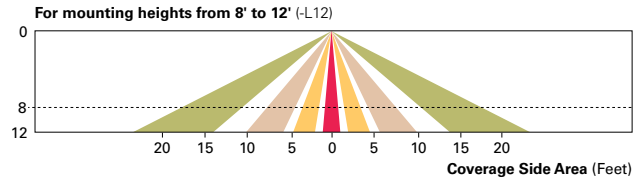
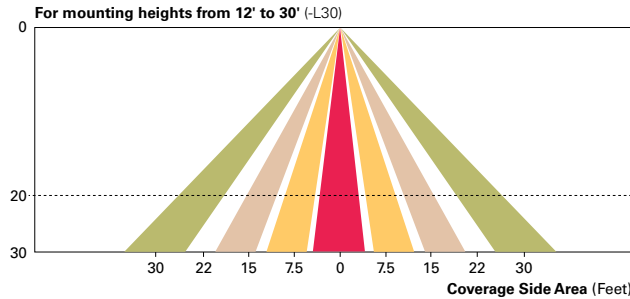

**WaveLinx Wireless Control and Monitoring System** The WaveLinx Outdoor control platform operates on a wireless mesh network based on IEEE 802.15.4 standards enabling wireless control of outdoor lighting. Use the WaveLinx Mobile application for set-up and configuration. At least one Wireless Area Controller (WAC) is required for full functionality and remote communication (including adjustment of any factory pre-sets).

**WaveLinx Wireless Sensor (WPS2 and WPS4)** These outdoor sensors offer passive infrared (PIR) occupancy and a photocell for closed loop daylight sensing. These sensors are factory preset to dim down to approximately 50 percent power after 15 minutes of no activity detected. These occupancy sensors include an integral photocell for "dusk-to-dawn" control or daylight harvesting that is factory-enabled. A variety of sensor lenses are available to optimize the coverage pattern for mounting heights from 7'-40'.

