



MILBANK[®]
ENERGY AT WORK



International Catalog

Metering Equipment



About Milbank

Energy at work since 1927

Milbank provides the tools that empower life. We enable the amazing in countless everyday ways through our thoughtfully designed products and collaborative ingenuity. More than a manufacturing company, we are an active and engaged contributor in the movement of energy. We are energy at work.

Milbank designs and builds solutions that move power for the residential, commercial, industrial, utility and transportation sectors. Milbank combines more than 85 years of expertise in electrical engineering and production with a commitment to develop and implement sustainable, integrated power solutions. A third-generation, family-owned business, Milbank is headquartered in Kansas City, Mo. For more information, please visit www.milbankworks.com.



METERING

Milbank meter sockets have set the standard for quality since 1927. With a 99.97% quality performance, thousands of active products to meet your utility's requirements and tens of millions of sockets installed across the globe, our products help keep energy at work. And with 22 stocking locations across the U.S., and our OneSERT program to help during emergency situations, our meter sockets are ready to go, wherever the job may be.



ENCLOSURES & ENCLOSED CONTROLS

When it comes to enclosures and enclosed control products, Milbank has it covered! We offer a complete line of junction boxes, telephone cabinet covers, transformer cabinets, wireways, pushbutton enclosures, consoles and thermal management products. We specialize in custom-built enclosures and are more than happy to design a solution for your specific project. Our commercial pedestals are easy to install, fast, safe and secure, and completely customizable.



GENERATORS & ENERGY MANAGEMENT

Milbank's standby and portable generators give you the peace of mind of living life uninterrupted during increasingly frequent power outages caused by severe weather, high demand and other situations. Our energy management systems give you reliable and sustainable ways to reduce both your energy costs and your impact on the environment.



Table of Contents

See back of catalog for index by catalog number

Single Position Meter Sockets

Economy socket, 4–6 terminals, ring type	4
100–125 amps, 4 & 5 terminals, ringless & ring type	5
200 amps, 4 & 5 terminals, ringless & ring type	6–7
100–200 amps, 7 terminals, ringless & ring type	8
200 amps, 7 terminals, ringless.....	9
Stainless steel meter sockets	10
320 amps, 4 & 5 terminals, lever bypass, ringless	11

Meter Mains

100–200 amps, 4 terminals, ringless.....	12
100–200 amps, with load center, 4 terminals, ringless & ring type	13
320 amps, 4 terminals, lever bypass, ringless.....	14
Cold squence, 4–7 terminals, ringless.....	15

Multi-Position

100 amps, 5 terminals, ringless.....	16
Meter mains, 125 & 200 amps, 4 terminals, ringless	17

Transformer Rated, Test Switches, Transformer Cabinets & Transockets

20 amps, 6–15 terminals, ringless & ring type	18–19
Test switches	20–22
Transformer cabinets	23–24
600 amp transockets, 6–14 terminals, ringless	25

Pedestals

100–200 amps, meter main pedestals, 4 terminals, ringless.....	26
100–200 amps, meter main with load center pedestals, 4 terminals, ringless.....	27

Power Outlets/RV Power

Surface mount power outlets.....	28
Power outlet pedestals.....	29

Miscellaneous

Terminal boxes	30–31
Commercial meter pedestals	32–33
Generators.....	34
Electric vehicle supply equipment	35
Accessories	36–39
Reference information	40–43



4

ECONOMY
SOCKET

Economy Socket

4–6 Terminals | 100 Amps | Ring Type

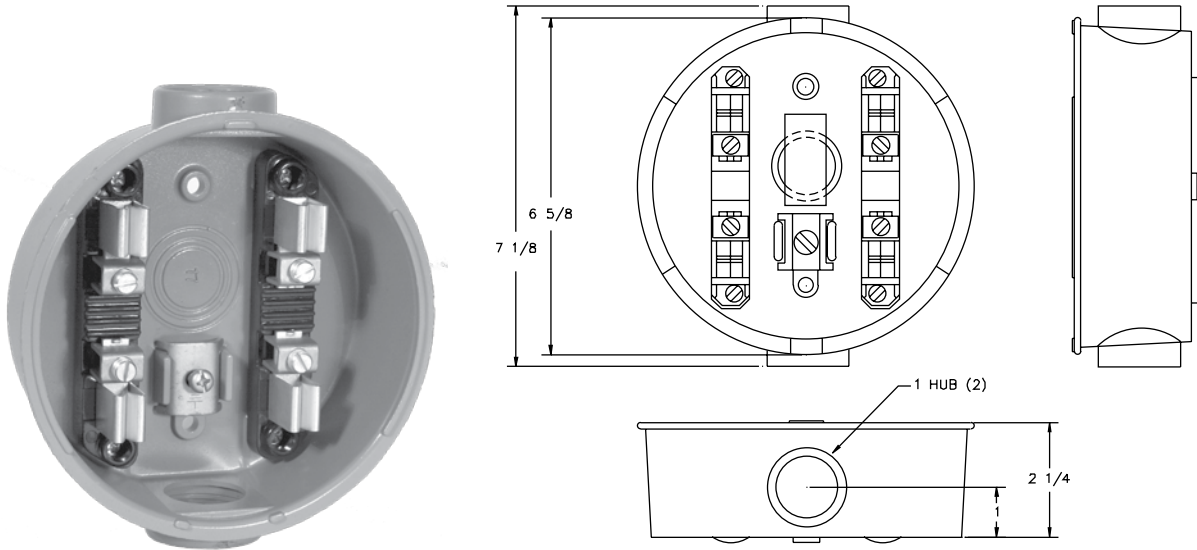

30-100 Amps | 4, 5 & 6 Terminals | Economy Cast Socket | Ring Type

Catalog Number	Terminals	Hub Location	Hub Size	Connectors CU/AL	Quantity per Package	Knockouts
AP2300-03	4	Top & Bottom	(2) 1"	#12-#1	12	¾", 1"
AP2300-04	4	Top & Bottom	(2) 1¼"	#12-#1	12	¾", 1"
AP2300-07	4	Top	1"	#12-#1	12	¾", 1"
AP2300-08	4	Top	1¼"	#12-#1	12	¾", 1"
AP2300-03-5T	5	Top & Bottom	(2) 1"	#12-#1	12	¾", 1"
AP2300-03-5T-AB	5	Top & Bottom	(2) 1"	#12-#1	12	¾", 1"
AP2300-03-6T	6	Top & Bottom	(2) 1"	#12-#1	12	¾", 1"

Notes

- **Non-UL Listed:** These units are not UL tested.
- **Fifth Terminal:** AP2300-03-5T and AP2300-03-5T-AB include factory-installed fifth terminal
- **Sixth Terminal:** AP2300-03-6T includes factory-installed sixth terminal.
- **Auto-Bypass:** -AB suffix indicates installed auto-bypass feature. Consult factory for more details.
- **Sealing Rings:** These units are supplied with an **MR-2** snap action sealing ring as standard.



Utility requirements for this equipment may vary. Always consult the serving utility for their requirements before ordering or installing equipment.

Single Position Sockets

100–125 Amps | Ringless & Ring Type | 600 VAC

5

100–125 AMP
SINGLE
POSITION
SOCKETS

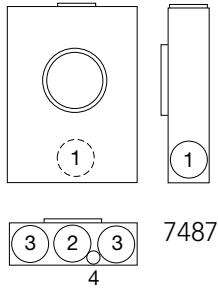

U7487-RL-TG

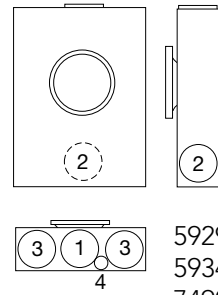

U5934-XL

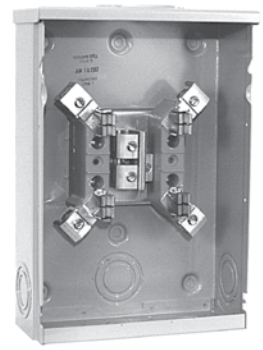

U7490-RL-TG

4 & 5 Terminals | Single Position | Ringless

Catalog Number	Amps	Terminals	Hub	Connectors CU/AL		Bypass	Dimensions			Knockouts			
				Line	Load		D"	W"	H"	1	2	3	4
U7487-RL-TG	125	4	H.O.	#6-2/0	#6-2/0	None	3 ⁵ / ₁₆	8	11 ¹ / ₂	2	1 ¹ / ₂	1 ¹ / ₄	1 ¹ / ₄
U5934-XL	100	4	C.P.	#6-2/0	#6-2/0	None	3 ⁵ / ₁₆	8	11 ¹ / ₂	2	1 ¹ / ₂	1 ¹ / ₄	1 ¹ / ₄
U7487-RL-TG-5T	125	5	H.O.	#12-1/0	#12-1/0	None	3 ⁵ / ₁₆	8	11 ¹ / ₂	2	1 ¹ / ₂	1 ¹ / ₄	1 ¹ / ₄

4 & 5 Terminals | Single Position | Ring Type

Catalog Number	Amps	Terminals	Hub	Connectors CU/AL		Bypass	Dimensions			Knockouts			
				Line	Load		D"	W"	H"	1	2	3	4
U7490-YL-TG	125	4	1 ¹ / ₄ "	#6-2/0	#6-2/0	None	3 ⁵ / ₁₆	8	11 ¹ / ₂	2	1 ¹ / ₂	1 ¹ / ₄	1 ¹ / ₄
U5929-XL	100	4	C.P.	#6-2/0	#6-2/0	None	3 ⁵ / ₁₆	8	11 ¹ / ₂	2	1 ¹ / ₂	1 ¹ / ₄	1 ¹ / ₄
U7490-YL-TG-5T	125	5	1 ¹ / ₄ "	#12-1/0	#12-1/0	None	3 ⁵ / ₁₆	8	11 ¹ / ₂	2	1 ¹ / ₂	1 ¹ / ₄	1 ¹ / ₄

Notes

- **Aluminum:** These units are also available in aluminum. Consult factory for more details.
- **Fifth Terminal:** For field mounted fifth terminal on the **U7487 & U7490** order catalog number **5T8K2** to fit into round opening at the 9 o'clock position. For factory-installed fifth terminal, add **-5T** to the catalog number.
- **Hubs:** For proper hub selection see the hub suffix chart on the accessory page.
- **Connectors:** Extruded aluminum connectors are tin plated.
- **Sealing Rings:** The **U7490** unit is supplied with an **MR-2** snap action sealing ring as standard.
- **Horn Bypass:** Horn bypass is available—contact factory for details.
- **Isolated Neutral:** **U5929** and **U5934** include isolated neutral option, ideal for solar applications.

Utility requirements for this equipment may vary. Always consult the serving utility for their requirements before ordering or installing equipment.



6

200 AMP
SINGLE
POSITION
SOCKETS

Single Position Sockets

200 Amps | 4 & 5 Terminals | Ringless | 600 VAC



U7021-RL-TG

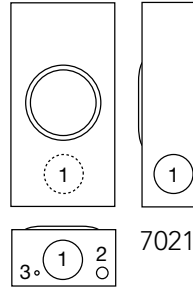

7021



U7040-RL-TG

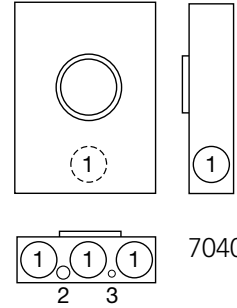

7040

200 Amps | 4 & 5 Terminals | Single Position | Ringless

Catalog Number	Terminals	Hub	Connectors CU/AL		Dimensions			Knockouts		
			Line	Load	D"	W"	H"	1	2	3
U7021-RL-TG	4	H.O.	#6-350	#6-350	4½	8	15½	2½	¼, ½	¼
U7021-DL-TG	4	2"	#6-350	#6-350	4½	8	15½	2½	¼, ½	¼
U7040-RL-TG	4	H.O.	#6-350	#6-350	4½	11	14¾	2½	¼, ½	¼
U7021-RL-TG-5T	5	H.O.	#6-350	#6-350	4½	8	15½	2½	¼, ½	¼

Notes

- **Other Options:** These units are also available in aluminum and horn bypass. Consult factory for more details.
- **Fifth Terminal:** For field mounted fifth terminal, order catalog number **K5T** to fit into square opening at the 9 o'clock position. For factory-installed fifth terminal, add suffix **-5T** to catalog number.
- **Triplex Ground (-TG):** Factory installed.
- **Connectors:** Extruded aluminum connectors are tin plated.



Utility requirements for this equipment may vary. Always consult the serving utility for their requirements before ordering or installing equipment.

Single Position Sockets

200 Amps | 4 & 5 Terminals | Ring Type | 600 VAC

7
200 AMP
SINGLE
POSITION
SOCKETS

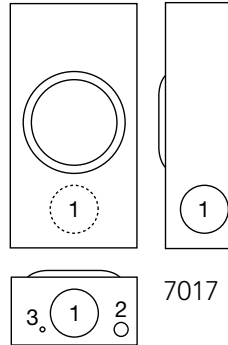

7017

U7017-RL-TG

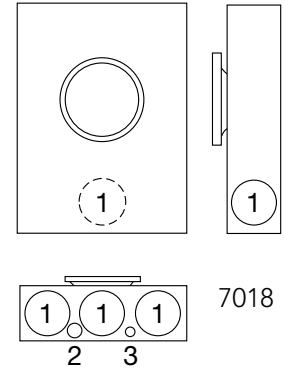

7018

U7018-XL-TG

200 Amps | 4 & 5 Terminals | Single Position | Ring Type

Catalog Number	Terminals	Hub	Connectors CU/AL		Dimensions			Knockouts		
			Line	Load	D"	W"	H"	1	2	3
U7017-RL-TG	4	H.O.	#6-350	#6-350	4 $\frac{1}{8}$	8	15 $\frac{1}{2}$	2 $\frac{1}{2}$	1 $\frac{1}{4}$, $\frac{1}{2}$	$\frac{1}{4}$
U7017-DL-TG	4	2"	#6-350	#6-350	4 $\frac{1}{8}$	8	15 $\frac{1}{2}$	2 $\frac{1}{2}$	1 $\frac{1}{4}$, $\frac{1}{2}$	$\frac{1}{4}$
U7018-XL-TG	4	C.P.	#6-350	#6-350	4 $\frac{3}{16}$	11 $\frac{1}{8}$	15 $\frac{1}{2}$	2 $\frac{1}{2}$	1 $\frac{1}{4}$, $\frac{1}{2}$	$\frac{1}{4}$
U7017-RL-TG-5T	5	H.O.	#6-350	#6-350	4 $\frac{1}{8}$	8	15 $\frac{1}{2}$	2 $\frac{1}{2}$	1 $\frac{1}{4}$, $\frac{1}{2}$	$\frac{1}{4}$

Notes

- **Other Options:** These units are also available in aluminum and horn bypass. Consult factory for more details.
- **Fifth Terminal:** For field mounted fifth terminal, order catalog number **K5T** to fit into square opening at the 9 o'clock position.
- **Triplex Ground (-TG):** Factory installed.
- **Connectors:** Extruded aluminum connectors are tin plated.
- **Sealing Rings:** Units on this page are supplied with an **MR-2** snap action sealing ring as standard.

Utility requirements for this equipment may vary. Always consult the serving utility for their requirements before ordering or installing equipment.



8

100-200 AMP
SINGLE
POSITION
SOCKETS

Single Position Sockets

100-200 Amps | 7 Terminals | Ringless | 600 VAC

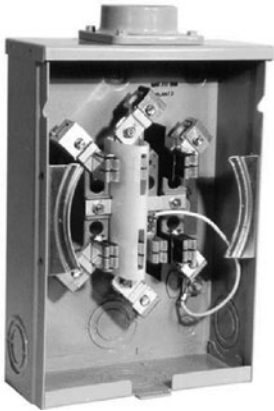

S1910-YL

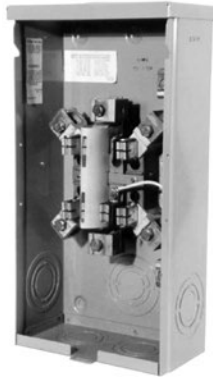
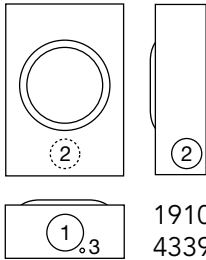

S2417-RL

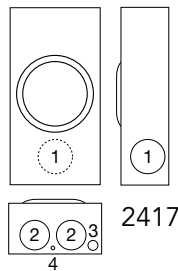

S4339-RL

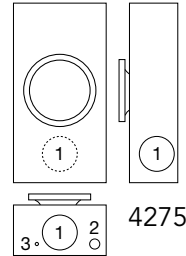

U3328-RXL

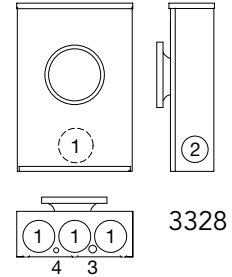

7 Terminals | Single Position | Ringless

Catalog Number	Amps	Hub	Connectors CU/AL		Bypass	Dimensions			Knockouts		
			Line	Load		D"	W"	H"	1	2	3
S1910-YL	100	1 1/4"	#6-2/0	#6-2/0	None	3 5/16	8	11 1/2	2	1 1/2	1/4
S2417-RL	200	H.O.	#6-350	#6-350	None	3 5/16	8	11 1/2	2	1 1/2	1/4
S2417-DL	200	2"	#6-350	#6-350	None	3 5/16	8	11 1/2	2	1 1/2	1/4

7 Terminals | Single Position | Ring Type

Catalog Number	Amps	Hub	Connectors CU/AL		Bypass	Dimensions			Knockouts			
			Line	Load		D"	W"	H"	1	2	3	4
S4339-RL	100	H.O.	#6-2/0	#6-2/0	None	3 5/16	8	11 1/2	2	1 1/2	1/4	—
S4275-DL	200	2"	#6-350	#6-350	None	4 1/8	8	15 1/2	2 1/2	1/4, 1/2	1/4	—
U3328-RXL	200	C.P.	#6-350	#6-350	None	4 7/8	13	19	3	2 1/2	1/4, 1/2	1/4

Notes

- **U3328-RXL:** For isolated neutral, order **K1047**.
- **Sealing Rings:** Ring type units are supplied with an **MR-2** snap action sealing ring as standard.
- **Aluminum Option:** Products on this page are available in aluminum shell construction. Contact Milbank for details.



Utility requirements for this equipment may vary. Always consult the serving utility for their requirements before ordering or installing equipment.

Single Position Sockets

200 Amps | 7 Terminals | Ringless | 600 VAC

9
200 AMP
SINGLE
POSITION
SOCKETS

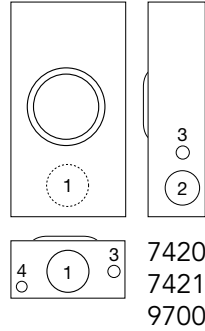
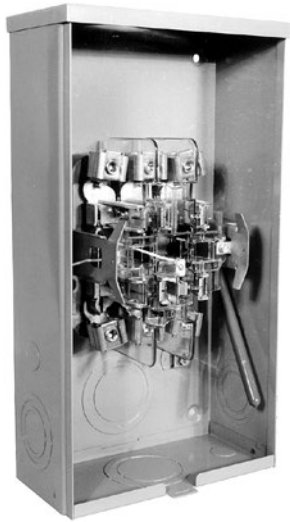

U7421-RL

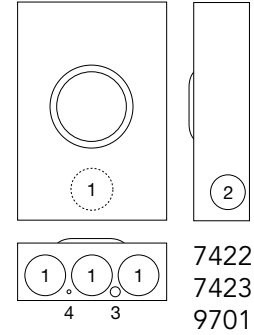

U9700-RRL

200 Amps | 7 Terminals | Single Position | Ringless

Catalog Number	Hub	Connectors CU/AL		Bypass	Dimensions			Knockouts			
		Line	Load		D"	W"	H"	1	2	3	4
U7420-RL	H.O.	#6-350	#6-350	None ¹	4 ⁷ / ₈	10	18 ¹ / ₂	3	2 ¹ / ₂	³ / ₄	¹ / ₄ , ¹ / ₂
U7421-RL	H.O.	#6-350	#6-350	Lever ²	4 ⁷ / ₈	10	18 ¹ / ₂	3	2 ¹ / ₂	³ / ₄	¹ / ₄ , ¹ / ₂
U7422-RXL†	C.P.	#6-350	#6-350	None ¹	4 ⁷ / ₈	13	19	3	2 ¹ / ₂	¹ / ₄ , ¹ / ₂	¹ / ₄
U7423-RXL†	C.P.	#6-350	#6-350	Lever ²	4 ⁷ / ₈	13	19	3	2 ¹ / ₂	¹ / ₄ , ¹ / ₂	¹ / ₄
U9700-RRL†	H.O.	#6-350	#6-350	Lever ³	4 ⁷ / ₈	10	18 ¹ / ₂	3	2 ¹ / ₂	³ / ₄	¹ / ₄ , ¹ / ₂
U9701-RXL†	C.P.	#6-350	#6-350	Lever ³	4 ⁷ / ₈	13	19	3	2 ¹ / ₂	¹ / ₄ , ¹ / ₂	¹ / ₄

Notes

†These units have a large hub opening with reducer plate to small hub opening.

- **Bypass:** ¹ Medium duty, no bypass. ² Medium duty lever bypass, non jaw-clamping. ³ Lever supplies clamping action on meter spades and also operates bypass device.
- **Aluminum Option:** Products on this page are available in aluminum.
- **4 & 5 Terminal Option:** These units are also available in 4 & 5 terminals.

Utility requirements for this equipment may vary. Always consult the serving utility for their requirements before ordering or installing equipment.



Stainless Steel Products

Build to endure extreme environments



USS4701-O

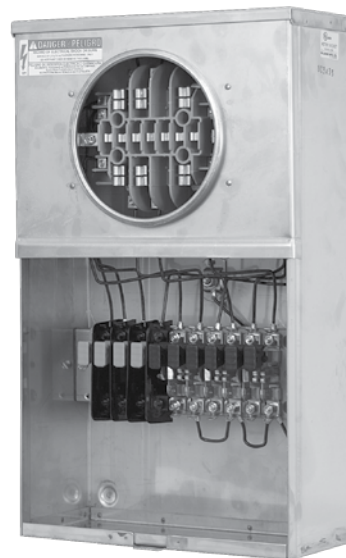

UCSS3433-O

200 Amps | Single Position | Stainless Steel | Ringless

Catalog Number	Terminals	Hub	Connectors CU/AL		Bypass	Dimensions		
			Line	Load		D"	W"	H"
USS3914-O	4	Blank	#6-350	#6-350	None	4 $\frac{7}{8}$	13	19
USS4801-O	4	Blank	#6-350	#6-350	Lever	4 $\frac{7}{8}$	13	19
USS4801-O-5T9	5	Blank	#6-350	#6-350	Lever	4 $\frac{7}{8}$	13	19
USS4701-O	7	Blank	#6-350	#6-350	Lever	4 $\frac{7}{8}$	13	19

Transformer Rated | With Provisions for Test Switch | Stainless Steel | Ring Type

Catalog Number	Terminals	Hub	Connectors CU	Bypass	Dimensions		
					D"	W"	H"
UCSS3436-O	6	Blank	#14 - 2	Test Switch*	5 $\frac{1}{2}$	12	20
UCSS3438-O	8	Blank	#14 - 2	Test Switch*	5 $\frac{1}{2}$	12	20
UCSS3433-O	13	Blank	#14 - 2	Test Switch*	5 $\frac{1}{2}$	12	20

Notes

- **Conduit Opening Applications:** All conduit openings have dimples provided to center location. Top conduit opening must have water-tight hub installed.
- ***Test Switch:** Test switch provisions. Test switch and wiring not included.
- **Contact Milbank for other units available in stainless steel.**



Utility requirements for this equipment may vary. Always consult the serving utility for their requirements before ordering or installing equipment.

Single Position Lever Bypass

320 Amp | 4 & 5 Terminal | Ringless | 600 VAC

1 1
320 AMP
SINGLE
POSITION
LEVER BYPASS



U4363-R

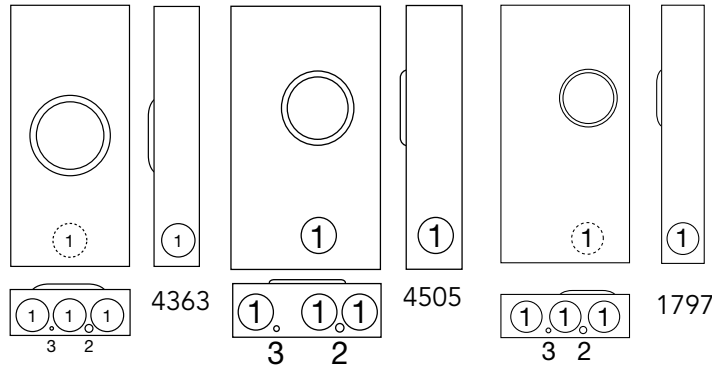

U1797-O-K2L-K3L

320 Amps | 4 & 5 Terminals | Single Position | Ringless

Catalog Number	Terminals	Hub	Connectors CU/AL		Bypass	Dimensions			Knockouts		
			Line	Load		D"	W"	H"	1	2	3
U4363-R*	4	H.O.	3/8" x 16 Stud	3/8" x 16 Stud	Lever	4 7/8	13	28 1/4	3	1/4, 1/2	1/4
U1797-O-K2L-K3L	4	Blank	(1) #4-600 or (2) 1/0-250	Twin #6-350	Lever	4 7/8	13	28 1/4	3	1/4, 1/2	1/4
U4505-X	5	C.P.	3/8" x 16 Stud	3/8" x 16 Stud	Lever	4 7/8	15	28 1/4	3	1/4, 1/2	1/4

Notes

- ***UL Listing:** This product is UL listed for parallel 250 conductors only. Use **K1450** with (2) 250 conductors.
- **Hubs:** For proper hub selection, refer to the hub suffix chart on the accessories page.
- **Connectors:** **U1797** includes lugs. **U4363** and **U4505** are supplied with 3/8"-16 hex head nuts with Belleville washers. For connector lug kits, order as extra from chart on accessories page. Separate lug kits are required for line and load.
- **Bypass:** Lever supplies clamping action on meter spades and also operates bypass device.
- **Fifth Terminal:** For field-installed fifth terminal for **U4363** and **U1797**, order **K3865**.

Utility requirements for this equipment may vary. Always consult the serving utility for their requirements before ordering or installing equipment.



100-200 Amps | 4 Terminals | Ringless | 120/240 VAC



U5842-RL-100

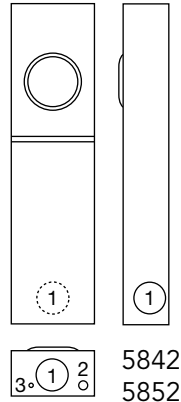

5842
5852

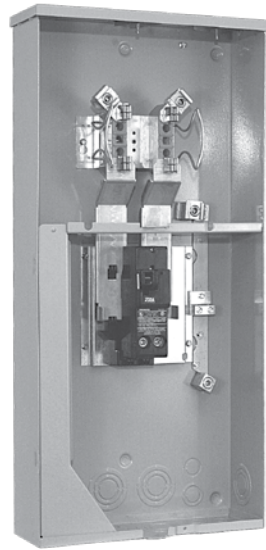

U5844-PXL-200

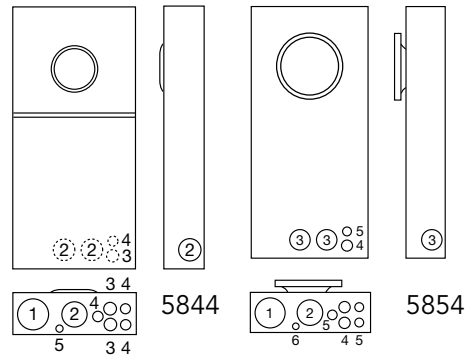

5844

5854

4 Terminals | Meter Mains | Ringless

Catalog Number	Service	Hub	Connectors CU/AL		Bypass	Dimensions			Knockouts				
			Line	Load		D"	W"	H"	1	2	3	4	5
U5842-RL	OH	H.O.	#6-350	—†	None	4½	8	30	2½	¼, ½	¼	—	—
U5842-RL-100	OH	H.O.	#6-350	CB - 100A	None	4½	8	30	2½	¼, ½	¼	—	—
U5842-PXL-200	OH	C.P.	#6-350	CB - 200A	None	4½	8	30	2½	¼, ½	¼	—	—
U5844-PXL-200	OH/UG	C.P.	#6-350	CB - 200A	None	4½	14	30	3	2½	1	½, ¾	¼, ½

4 Terminals | Meter Mains | Ring Type

Catalog Number	Service	Hub	Connectors CU/AL		Bypass	Dimensions			Knockouts					
			Line	Load		D"	W"	H"	1	2	3	4	5	6
U5852-RL	OH	H.O.	#6-350	—†	None	4½	8	30	2½	¼, ½	¼	—	—	—
U5852-RL-100	OH	H.O.	#6-350	CB - 100A	None	4½	8	30	2½	¼, ½	¼	—	—	—
U5852-RL-200	OH	H.O.	#6-350	CB - 200A	None	4½	14	30	2½	¼, ½	¼	—	—	—
U5854-RL-200	OH/UG	H.O.	#6-350	CB - 200A	None	4½	14¼	30	3	2½	2	1	½, ¾	¼, ½

Notes

† Breaker not included

- **AIC Rating:** All models are rated 22K AIC when using Siemens **QPH** (100A) or **QNH** (200A) breakers.
- **Hub:** -PXL versions supplied with one (1) closing plate packed inside. Order other hubs separately.
- **Fifth Terminal:** For field installable fifth terminal kit, order **K5T**.



Utility requirements for this equipment may vary. Always consult the serving utility for their requirements before ordering or installing equipment.

Meter Main with Load Center

100–200 Amps | 4 Terminals | 120/240 VAC

13
100–200 AMP
METER MAIN
W/ LOAD CENTER



U5168-XTL-200

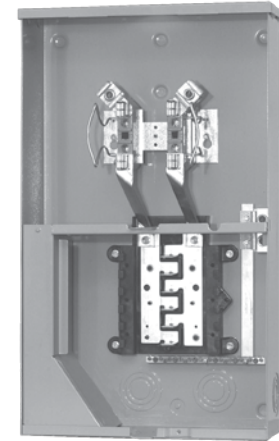
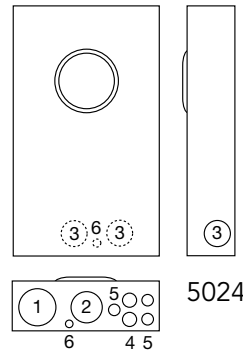
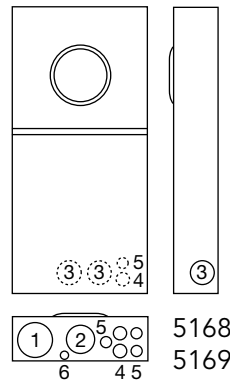

UAP5024-XL

4 Terminals | Meter Mains | Ringless

Catalog Number	Amps	Service	Circuits	Hub	Connectors CU/AL - Line	Dimensions			Knockouts					
						D"	W"	H"	1	2	3	4	5	6
U5168-XTL-100	100	OH/UG	10	C.P.	#6-350	4½	14⅞	30	3	2½	2	1	½,¾	¼,½
U5168-XTL-200	200	OH/UG	8	C.P.	#6-350	4½	14⅞	30	3	2½	2	1	½,¾	¼,½
UAP5024-XL	200	OH/UG	12	C.P.	#6-350	4½	14⅞	24	3	2½	2	1	½,¾	¼,½

4 Terminals | Meter Mains | Ring Type

Catalog Number	Amps	Service	Circuits	Hub	Connectors CU/AL - Line	Dimensions			Knockouts					
						D"	W"	H"	1	2	3	4	5	6
U5169-XTL-100	100	OH/UG	10	C.P.	#6-350	4½	14⅞	30	3	2½	2	1	½,¾	¼,½
U5169-XTL-200	200	OH/UG	8	C.P.	#6-350	4½	14⅞	30	3	2½	2	1	½,¾	¼,½

Notes

- **Hubs:** For proper hub selection, refer to the hub suffix chart on the accessories page.
- **Fifth Terminal:** For field installed fifth terminal, order **K5T**.
- **Interlock Kit:** For generator auxiliary circuit breaker interlock, order **K5815** for large **QN** with small frame **Q**; order **K5820** for large frame **QN** with large frame **QN**; order **K5830** for small frame **Q** to small frame **Q**. See accessories page for details.
- **UAP5024-XL:** This unit is painted aluminum. Breaker section has provision for six double pole "plug-in" type circuit breakers. All circuit breakers will be parallel. To comply with NEC wire bending space requirements, the maximum breaker amperage is 200 amps restricted to 3/0 copper conductor.

Plug-In Breaker Compatibility Chart

Amps	Cutler Hammer	Siemens	General Electric	Square D
150-200	BR, BRH, HQP, QPHW, QPGF, QPHGF	QP, QPH	THQL, THHQL, THQL-GF, THHQL-GF	Homeline
≤ 125	QP / BR	QP, QPH	THQ	Homeline

Utility requirements for this equipment may vary. Always consult the serving utility for their requirements before ordering or installing equipment.



14

320 AMP
LEVER BYPASS
METER MAIN

Lever Bypass Meter Mains

320 Amps | 4 Terminals | Ringless | 120/240 VAC



U5890-X-2/200

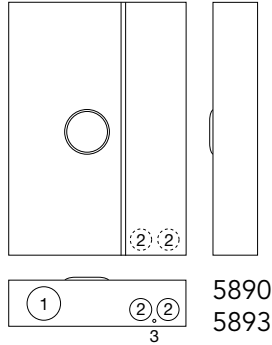

U5894-X-2/200

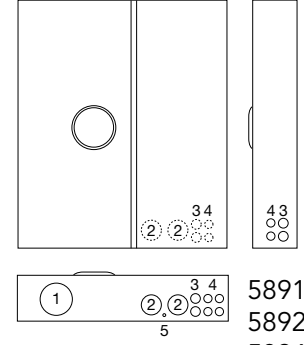

320 Amps | 4 Terminals | Meter Mains | Lever Bypass | Ringless

Catalog Number	Service	Hub	Side Wireway	Connectors CU/AL - Line	Branch Circuits	Dimensions			Knockouts				
						D"	W"	H"	1	2	3	4	5
U5890-X-2/200	OH/UG	C.P.	No	3/8" x 16 Studs	N/A	6	24½	35	4	2½	¼	—	—
U5891-X-2/200	OH/UG	C.P.	No	3/8" x 16 Studs	12	6	29½	35	4	2½	1	½, ¾	¼
U5892-X-2/200	OH/UG	C.P.	No	3/8" x 16 Studs	24	6	29½	35	4	2½	1	½, ¾	¼
U5893-X-2/200	OH/UG	C.P.	Yes	3/8" x 16 Studs	N/A	6	24½	35	4	2½	¼	—	—
U5894-X-2/200	OH/UG	C.P.	Yes	3/8" x 16 Studs	12	6	29½	35	4	2½	1	½, ¾	¼
U5895-X-2/200	OH/UG	C.P.	Yes	3/8" x 16 Studs	24	6	29½	35	4	2½	1	½, ¾	¼

Notes

- **Hubs:** For proper hub selection refer to the hub suffix chart on the accessory page.
- **Breakers:** All units come with two 200A main breakers.
- **Side Bussed Units:** U5893, U5894 and U5895.
- **-MLK:** Main Lug feed-through kit K3701 factory installed on U5891 and U5894.
- **Fifth Terminal:** For field mounted fifth terminal order catalog number K3865.
- **Connectors:** Socket is supplied with 3/8" - 16 hex head nuts with Belleville washers. For connector lug kits, order as extra from chart on accessories page. Separate lug kits are required for line side only.

Plug-In Breaker Compatibility Chart

Amps	Cutler Hammer	Siemens	General Electric	Square D
150-200	BR, BRH, HQP, QPHW, QPGF, QPHGF	QP, QPH	THQL, THHQL, THQL-GF, THHQL-GF	Homeline
≤ 125	QP / BR	QP, QPH	THQ	Homeline



Utility requirements for this equipment may vary. Always consult the serving utility for their requirements before ordering or installing equipment.

Cold Sequence Meter Mains

4, 5 & 7 Terminals | Ringless

15
COLD
SEQUENCE
METER MAINS



U5767-X-200-CB



U5787-O-200-CB

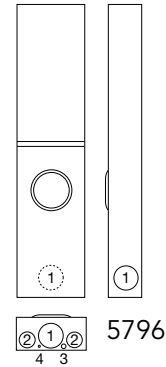

5796

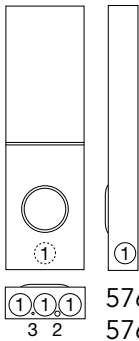

5764 5767
5765

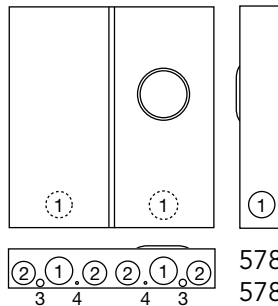

5784
5787

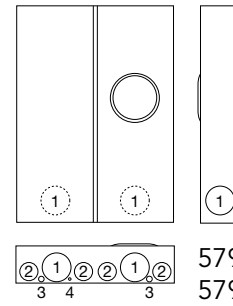

5797
5799

200 Amp Circuit Breaker Disconnect Ahead Of Meter Socket

Catalog Number	Terminals	Service	Hub	Connectors CU/AL		Bypass	Dimensions			Knockouts			
				Line & Load			D"	W"	H"	1	2	3	4
U5764-X-200-CB	4	OH/UG	C.P.	#6-350		Lever	4 ^{27/32}	13	43	4	2½	¼	—
U5765-X-200-CB	5	OH/UG	C.P.	#6-350		Lever	4 ^{27/32}	13	43	4	2½	1	½, ¾
U5784-O-200-CB	5	UG	Blank	#6-350		Lever	4 ^{27/32}	26	28	4	2½	¼	—
U5767-X-200-CB	7	OH/UG	C.P.	#6-350		Lever	4 ^{27/32}	13	43	4	2½	1	½, ¾
U5787-O-200-CB	7	UG	Blank	#6-350		Lever	6	26	28	4	2½	1	½, ¾

400 Amp (320 Amp Continuous) Circuit Breaker Disconnect Ahead Of Meter Socket

Catalog Number	Terminals	Service	Hub	Connectors CU/AL		Bypass	Dimensions			Knockouts			
				Line	Load		D"	W"	H"	1	2	3	4
U5797-O-400-CB	5	UG	Blank	3/0-500	3/0-500	Lever	6	26	36	4	2½	1	½, ¾
U5796-X-400-CB	7	OH/UG	C.P.	3/0-500	3/0-500	Lever	6	13	56	4	2½	¼	—
U5799-O-400-CB	7	UG	Blank	3/0-500	3/0-500	Lever	6	26	36	4	2½	1	½, ¾

Notes

- **Hubs:** For proper hub selection, refer to the hub suffix chart on the accessories page.

Utility requirements for this equipment may vary. Always consult the serving utility for their requirements before ordering or installing equipment.



Multi-Position Sockets

100 Amps | 4 Terminals | 300 VAC

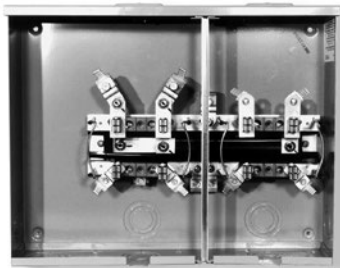

U8212-RL

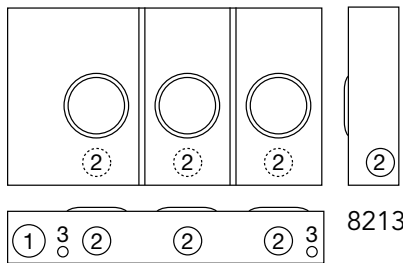
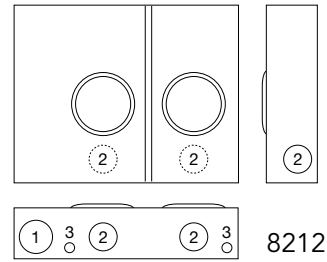

8213

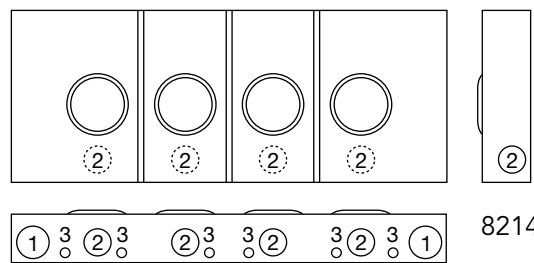

8214

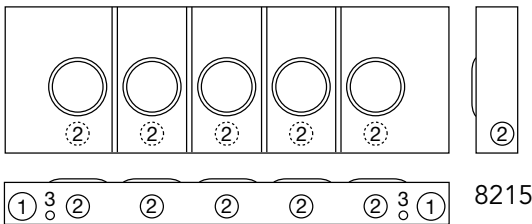

8215

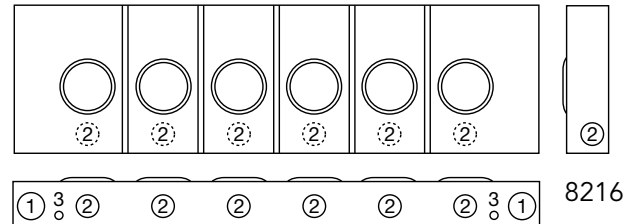

8216

100 Amps per Position | 4 Terminal | Multi-Position | Ringless

Catalog Number	Positions	Hub	Connectors CU/AL		Dimensions			Knockouts		
			Line	Load	D"	W"	H"	1	2	3
U8212-RL	2	H.O.	#6-350	#6-2/0	4½	20⅝	16	2½	2	¼, ½
U8213-RL	3	H.O.	#6-350	#6-2/0	4½	28½	16	2½	2	¼, ½
U8214-RL	4	H.O.	#6-350	#6-2/0	4½	40⅞	16	2½	2	¼, ½
U8215-RL	5	H.O.	#6-350	#6-2/0	4½	48⅞	16	2½	2	¼, ½
U8216-XL	6	C.P.	#6-350	#6-2/0	4½	57⅞	16	2½	2	¼, ½

Notes

- **Hub:** For proper hub selection refer to the hub suffix chart on the accessory page. A hub opening is supplied at each end and the extra opening is closed with a closing plate as standard.
- **Fifth Terminal Kit:** For field mounted fifth terminal, order **5T8K2** (6 o'clock position).
- **Connectors:** Extruded aluminum connectors are tin plated.
- **200 Amp Units:** 200 amp per position units available—consult factory.



Utility requirements for this equipment may vary. Always consult the serving utility for their requirements before ordering or installing equipment.

Multi-Position Meter Mains

125 & 200 Amp | 4 Terminals | Ringless | 120/240 VAC

17
125-200 AMP
MULTI-POSITION
METER MAINS



U5882-X



U5884-X

125 Amps per Position | 4 Terminal | Multi-Position Meter Mains | Ringless

Catalog Number	Amps	Positions	Service	Hub	Connectors CU/AL	Dimensions			Weight (lbs.)
					Line	D"	W"	H"	
U5902-X	125	2	OH/UG	C.P.	3/8" x 16 Stud	5 1/8	26 1/2	30	58
U5903-X	125	3	OH/UG	C.P.	3/8" x 16 Stud	5 1/8	34 3/8	30	88
U5904-X	125	4	OH/UG	C.P.	3/8" x 16 Stud	5 1/8	42 4/8	30	107
U5905-X	125	5	OH/UG	C.P.	3/8" x 16 Stud	5 1/8	51 1/20	30	128
U5906-X	125	6	OH/UG	C.P.	3/8" x 16 Stud	5 1/8	59 3/10	30	146

200 Amp / Position | 4 Terminal | Multi Position Meter Mains | Ringless

Catalog Number	Amps	Positions	Service	Hub	Connectors CU/AL	Dimensions			Weight (lbs.)
					Line	D"	W"	H"	
U5882-X	200	2	OH/UG	C.P.	3/8" x 16 Stud	5 1/8	26 1/2	30	58
U5883-X	200	3	OH/UG	C.P.	3/8" x 16 Stud	5 1/8	34 3/8	30	88
U5884-X	200	4	OH/UG	C.P.	3/8" x 16 Stud	5 1/8	42 4/8	30	107
U5885-X	200	5	OH/UG	C.P.	3/8" x 16 Stud	5 1/8	51 1/20	30	128
U5886-X	200	6	OH/UG	C.P.	3/8" x 16 Stud	5 1/8	59 3/10	30	146

Notes

- **Optional:** Factory installed breakers are available—consult factory.
- **AIC Rating:** All models are rated **22K AIC** with Siemens breakers.
- **Hub:** Units supplied with one (1) closing plate. Order hubs separately, see accessory page.
- **Fifth Terminal:** For field installed fifth terminal, order **K5T**.
- **Connectors:** Socket is supplied with 3/8" - 16 hex head nuts with Belleville washers. For connector lug kits, order as extra from chart on accessories page. Separate lug kits are required for line side only.

Utility requirements for this equipment may vary. Always consult the serving utility for their requirements before ordering or installing equipment.



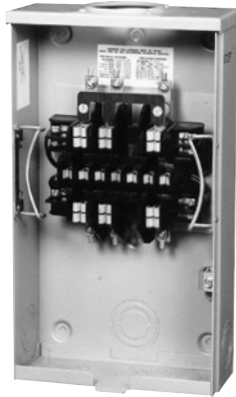

UC7237-RL

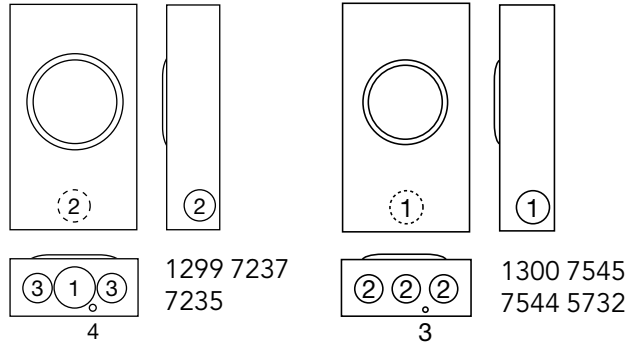

20 Amps | Ringless | Plunger Bypass | Overhead/Underground Service

Catalog Number	Terminals	Hub	Meter Form	Connectors CU	Bypass	Dimensions			Knockouts			
						D"	W"	H"	1	2	3	4
UC1299-RL	6	H.O.	4S	#14 - #10	Plunger	3 ⁵ / ₁₆	8	14	2	1 ¹ / ₂	1 ¹ / ₄	1 ¹ / ₄
UC7235-RL	8	H.O.	5S	#14 - #10	Plunger	3 ⁵ / ₁₆	8	14	2	1 ¹ / ₂	1 ¹ / ₄	1 ¹ / ₄
UC7237-RL	13	H.O.	6, 8, 9S & (ALT) 10S	#14 - #10	Plunger	3 ⁵ / ₁₆	8	14	2	1 ¹ / ₂	1 ¹ / ₄	1 ¹ / ₄

20 Amps | Ring Type | Overhead/Underground Service

Catalog Number	Terminals	Hub	Meter Form	Connectors CU	Bypass	Dimensions			Knockouts		
						D"	W"	H"	1	2	3
UC1300-XL	6	H.O.	4S	#14 - #4 Max	Plunger	3 ⁵ / ₁₆	8	14	1 ¹ / ₂	1 ¹ / ₄	1 ¹ / ₄
UC7544-XL	8	H.O.	3S	#14 - #4 Max	Plunger	3 ⁵ / ₁₆	8	14	1 ¹ / ₂	1 ¹ / ₄	1 ¹ / ₄
UC7545-XL	13	H.O.	6, 8, 9S & (ALT) 10S	#14 - #4 Max	Plunger	3 ⁵ / ₁₆	8	14	1 ¹ / ₂	1 ¹ / ₄	1 ¹ / ₄
UC5732-XL	15	H.O.	Special	#14 - #4 Max	None	3 ⁵ / ₁₆	8	14	1 ¹ / ₂	1 ¹ / ₄	1 ¹ / ₄

Notes

- **Hubs:** For proper hub selection, see the hub suffix chart on the accessories page.
- **Bypass:** Plunger type bypass automatically closes when meter is removed.
- **Connectors:** Units are supplied with mechanical type connectors (#4 max).



Utility requirements for this equipment may vary. Always consult the serving utility for their requirements before ordering or installing equipment.

Transformer Rated

20 Amps | 6-13 Terminals | Test Switch Provision

19
20 AMP
TRANSFORMER
RATED

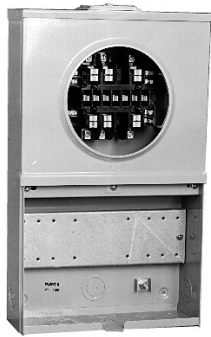

UC7449-XL



UC7478-YL

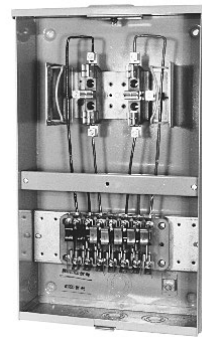

UC7532-RL
(shown prewired with
Milbank test switch)

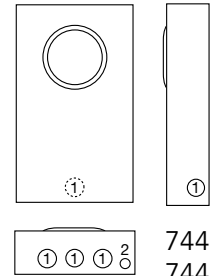

- 7444
- 7445
- 7446
- 7448
- 7449
- 7478
- 7532

1 Piece Cover | Ringless | Overhead/Underground | with test switch provision*

Catalog Number	Terminals	Hub	Meter Form	Connectors CU	Bypass	Dimensions			Knockouts	
						D"	W"	H"	1	2
UC7478-RL	6	H.O.	4S	#14 - #4 Max	None	4 $\frac{1}{8}$	12	20	1 $\frac{1}{4}$	1 $\frac{1}{4}$, 1 $\frac{1}{2}$
UC7444-RL	8	H.O.	5S	#14 - #4 Max	None	4 $\frac{1}{8}$	12	20	1 $\frac{1}{4}$	1 $\frac{1}{4}$, 1 $\frac{1}{2}$
UC7445-RL	13	H.O.	6, 8, 9 & (ALT) 10S	#14 - #4 Max	None	4 $\frac{1}{8}$	12	20	1 $\frac{1}{4}$	1 $\frac{1}{4}$, 1 $\frac{1}{2}$
UC5087-RL	13	H.O.	6, 8, 9 & (ALT) 10S	#14 - #4 Max	Plunger	4 $\frac{1}{8}$	12	20	1 $\frac{1}{4}$	1 $\frac{1}{4}$, 1 $\frac{1}{2}$

2 Piece Cover | Ringless | Overhead/Underground | with test switch provision*

Catalog Number	Terminals	Hub	Meter Form	Connectors CU	Bypass	Dimensions			Knockouts	
						D"	W"	H"	1	2
UC7532-RL	6	H.O.	4S	#14 - #4 Max	None	4 $\frac{1}{8}$	12	20	1 $\frac{1}{4}$	1 $\frac{1}{4}$, 1 $\frac{1}{2}$
UC7448-RL	8	H.O.	5S	#14 - #4 Max	None	4 $\frac{1}{8}$	12	20	1 $\frac{1}{4}$	1 $\frac{1}{4}$, 1 $\frac{1}{2}$
UC7449-RL	13	H.O.	6, 8, 9 & (ALT) 10S	#14 - #4 Max	None	4 $\frac{1}{8}$	12	20	1 $\frac{1}{4}$	1 $\frac{1}{4}$, 1 $\frac{1}{2}$

Notes

- **Hubs:** For proper hub selection see the hub suffix chart on the accessory page.
- **Prewiring:** If standard factory pre-wiring is required, refer to wiring diagrams in the general engineering section of this catalog. Determine appropriate diagram and send copy with order. If custom factory prewiring is required, specify on order. Be sure to include meter socket catalog number, test switch model and number, and meter form number. Please be sure to provide a copy of your wiring diagram. Catalog number will change to match wiring.
- **Connectors:** Units are supplied with mechanical type connectors (#4 max).
- ***Test Switch Cover:** Units on this page are not designed for use with test switch covers. Units are available in 5 $\frac{1}{2}$ " deep shell for test switch cover—contact factory for details. It is also possible to remove the test switch bridge and mount a test switch to the back of the enclosure.
- **Ring Type Option:** 2-piece cover units are available in ring type—contact factory for details.

Utility requirements for this equipment may vary. Always consult the serving utility for their requirements before ordering or installing equipment.



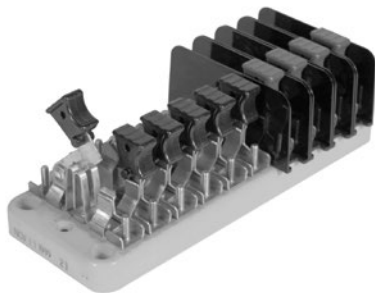

Switch Blades

Two dimples coined into one side of the switch blade ensure positive contact in corrosive, sooty environments—even after years of inactivity.

Test Switch Covers

Standard test switch covers are made from impact resistant clear thermal plastic which has excellent tracking and moisture resistant properties. If covers are required, add suffix **-WC** (with cover) to the catalog number or order separately catalog number **K3388**. Black flush mount covers are also available. Order catalog number **K3388-BLK-FL**. 10 pole base only.

Standard Cover



Test Switch Base

The base is molded from a high strength, fiberglass reinforced, thermoset polyester. This material is track resistant, flame retardant and has low water absorption qualities. Bases are available in 7 pole and 10 pole sizes.

Switch Jaws

The switch blade jaw clips are constructed from spring grade copper alloy. The material and design ensure excellent contact which prevents overheating.



Polarity Barrier

For maximum protection potential circuits are supplied with permanently mounted barriers made from high tensile strength polycarbonate.

Current Carrying Parts

Highly conductive copper and copper alloy materials are used on all current carrying parts. This ensures conductivity and deters corrosion. Spring grades are used where appropriate. Plating is available if required. Contact general offices to special order.

Flush Mount Cover (Black)



Socket shells must be 5/8" deep
-OR-
must not have test switch bridge
mounted on back
in order to support a cover.

Factory Installed: For cover installed add the suffix **-WC** or **-WCFL** to the catalog number of desired test switch.

Field Installed: For field installed cover order kit number **K3388** or **K3388-BLK-FL**.

The Milbank test switch is designed to meet the critical requirements of the electric utility industry. Not only do they meet EEI, ANSI C12.9, and UL standards but they combine several special features giving the Milbank test switch increased safety, durability and reliability. One such feature is our unique switch blade contact points which cut through residue that builds up after years of service. Another distinction is our polarity barrier which is designed to be flexible as well as offer exceptional insulating qualities. Our test switches are constructed from the latest materials available using modern fabricating and assembly methods.





Utility requirements for this equipment may vary. Always consult the serving utility for their requirements before ordering or installing equipment.

Test Switches

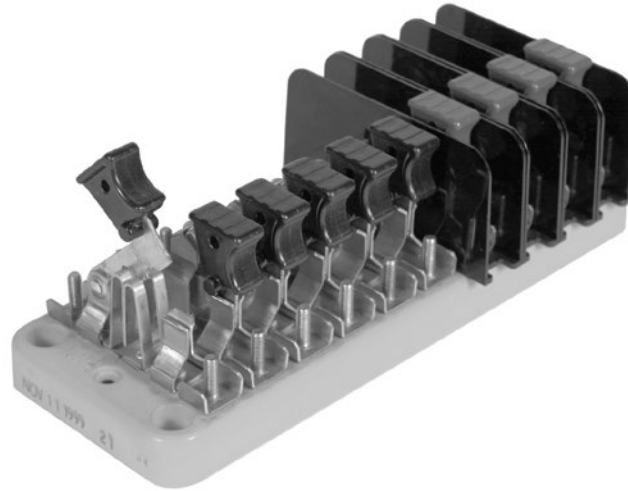
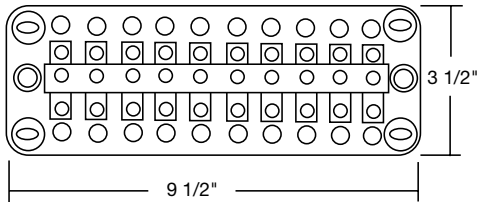
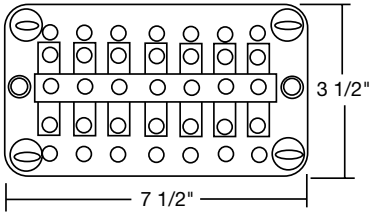





4, 7 & 10 Pole















Key	
P	Potential Switch
C+	Line side current switch with short circuit assembly
C	Load side current switch with test jack assembly
N	Neutral bar (no switch)
Pn	Neutral Potential Switch
X	Unused Position on base
	Insulating barrier, isolates both sides of switch

Catalog Number	4-Pole						
TS04-0101	X	P		X	C+	C	X
TS04-0104	X	C+	C	X		Pn	X

Catalog Number	7-Pole						
TS07-0105		P		C+	C	C+	C

Catalog Number	7-Pole on a 10-Pole Base									
TS07-0049		X		X		X	C+	C	C	C+
TS07-0106	X		C+	C		C+	C		X	X

Catalog Number	10-Pole									
TS10-0109	P		P		C+	C	C+	C	C+	C
TS10-0110		C+	C		C+	C		C+	C	
TS10-0111	P		P		C	C+	C	C+	C	C+
TS10-0112	C+	C	C+	C	C+	C		P		Pn
TS10-0016				Pn	C	C+	C	C+	C	C+

Custom Pole Arrangements:
The key may be used to diagram your own pole arrangement. Be sure to specify base size and whether all C+ line side, current switch / shunt circuit assemblies are to be bussed together. The catalog numbers shown above are connected in line-load pairs; therefore, if bussed is required, different catalog numbers will apply.

Utility requirements for this equipment may vary. Always consult the serving utility for their requirements before ordering or installing equipment.





Customer Name: _____

Address: _____

Phone / Fax #: _____

Handle Color Key

BK	Black	P	Purple	Y	Yellow	GN	Green
R	Red	BL	Blue	W	White	BKS	Black Stripe
BR	Brown	GR	Grey	O	Orange	WS	White Stripe

TEST SWITCH BASE

The base is molded from a high strength, fiberglass reinforced, thermoset polyester. This material is track-resistant, flame-retardant and has low water absorption qualities. Bases are available in two standard sizes following NEMA mounting classifications.



Pole Position Chart

1	2	3	4	5	6	7	8	9	10

Special Features

Feature	1	2	3	4	5	6	7	8	9	10
45° Angle Stops										
Ganged Handles (C)										
Bussing										
Colored Handles										

Engineering Information: _____

Key	
P	Potential Switch
C+	Line side current switch with short circuit assembly
C	Load side current switch with test jack assembly
N	Neutral bar (no switch)
Pn	Neutral Potential Switch
X	Unused Position on base
	Insulating barrier - one side
	Insulating barrier - two sides

Custom Pole Arrangements: The key may be used to diagram your own pole arrangement. Be sure to specify base size and whether all C+ line side, current switch / shunt circuit assemblies are to be bussed together. The catalog numbers shown above are connected in line-load pairs; therefore, if bussed is required, different catalog numbers will apply.

Number of Poles

- 4
- 7
- 10
- Other _____

Test Switch Cover (only available for 10-pole bases)

Yes | Clear ____ Black ____

No

Base Size

- 7-Pole
- 10-Pole



Utility requirements for this equipment may vary. Always consult the serving utility for their requirements before ordering or installing equipment.

Current Transformer Cabinet

Panel Enclosure | Type 3R



Application

- For use as a current transformer cabinet or panel enclosure.
- For outdoor use to provide protection against rain, sleet and snow, or indoor use to protect against dripping water.

Construction

- Enclosure and cover manufactured from 16 or 14 gauge G90U galvanized steel.
- The doors are overlapping with no center post.
- Continuous door hinge with stainless steel hinge pins.
- Three point pad-lockable handle.
- Panel mounting studs provided for optional back panels.
- Drip shield top and seam-free sides, front and back.

Finish

- ANSI 61 gray polyester powder coating over phosphatized G90U galvanized steel.

PT Cabinets

Catalog Number	Dimensions			Knockout
	D"	W"	H"	
PT48L	8	8	27½	2½" - right side
PT48AL	8	12	36	2½" - right side
PT48R	8	8	27½	2½" - left side
PT48AR	8	12	36	2½" - left side



PT48AR*



S7860

Current Transformer Cabinets | Panel Enclosure

Catalog Number	UPC # (7-84572)	Weight	Dimensions			Steel Panel Catalog #	Wood Panel Catalog #
			W"	H"	D"		
363010-CT3R	18823	99	36	30	10	A-36P30	A-36P30W
363016-CT3R	16181	121.5	36	30	16	A-36P30	A-36P30W
363610-CT3R	17368	113	36	36	10	A-36P36	A-36P36W
363612-CT3R	16185	118	36	36	12	A-36P36	A-36P36W
363616-CT3R	18819	139	36	36	16	A-36P36	A-36P36W
483616-CT3R	25707	163	48	36	16	A-48P36	A-48P36W
484812-CT3R	16184	210	48	48	12	A-48P48	A-48P48W
606013-CT3R	18252	274	60	60	13	A-60P60	A-60P60W

Notes

- ***PT48:** PT48L and PT48AL has mounting emboss on the right side to be mounted on left side of CT cabinet. PT48R and PT48AR have mounting emboss on left side to be mounted on right side of CT cabinet.
- **Wall or Pole Mount:** For wall or pole mount CT rack order **S7860**. This unit accomodates 3 donut style CTs. The removable cover makes wiring much easier.

Utility requirements for this equipment may vary. Always consult the serving utility for their requirements before ordering or installing equipment.





K4797 (studs)



K4798 (studs)

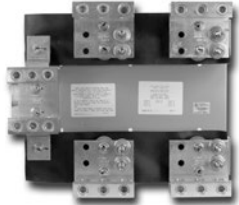

K4729 (with lugs)



K4722 (with lugs)



**CT364811-HC CT Cabinet
and K4722 CT Rack**

800 Amps | Transformer Cabinets

Catalog Number	C.T. Racks	Dimensions			Front Cover	Cover Type
		D"	W"	H"		
CT244811-SC	A	11	24	48	1 Piece	Screw
CT304811-SC	A, B, G, H	11	30	48	1 Piece	Screw
CT364811-SC	A, B, G, H	11	36	48	1 Piece	Screw
CT244811-HC	A	11	24	48	1 Piece	Hinge
CT304811-HC	A, B, G, H	11	30	48	1 Piece	Hinge
CT364811-HC	A, B, G, H	11	36	48	1 Piece	Hinge

CT Cabinet Mounting Racks

Code	Catalog Number	AIC Rating	Amps	Volts	Type of Service	Termination Type
A	K4797	50K	800	600	1Ø3W or 3Ø3W	½ - 13 studs on 1¾" centers
B	K4798	50K	800	600	3Ø4W	½ - 13 studs on 1¾" centers
G	K4729	50K	800	600	1Ø3W or 3Ø3W	6 lugs: (3) #4-600 or (6) #1-250
H	K4722	50K	800	600	3Ø4W	8 lugs: (3) #4-600 or (6) #1-250

Notes

- **Enclosure:** These units are rated Type 3R, powder coated and constructed of galvanized steel.
- **Mounting:** ¼ - 20 welded studs for use with CT mounting rack.



Utility requirements for this equipment may vary. Always consult the serving utility for their requirements before ordering or installing equipment.

Transockets

600 Amps | 6–14 Terminals | Donut or Bar Type CTs

25
600 AMP
TRANSOCKETS

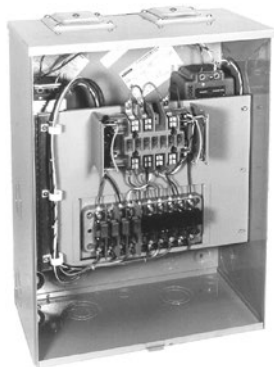

S1890-XT

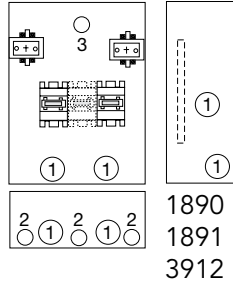

1890
1891
3912



S2690-XT

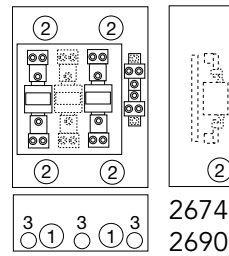

2674
2690
3831

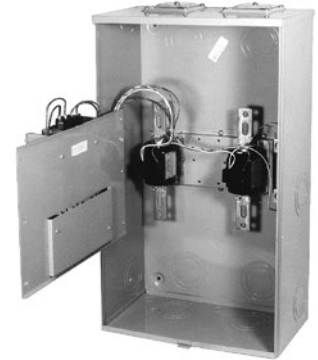

S2690-XT

600 Amps | 600 Volts | With PTs and Donut Type CTs | Ringless

Catalog Number	Terminals	Hub	Meter Form	PTs Quantity & Ratio	CTs Quantity & Ratio	Dimensions			Knockouts		
						D"	W"	H"	1	2	3
S1891-XT	8	(2) C.P.	5S	(2) 4:1	(2) 200/5	9½	18	24	2½	1	1¼/6
S3912-XT	13	(2) C.P.	6S	(2) 2.5:1	(3) 200/5	9½	18	24	2½	1	1¼/6
S1890-XT	14	(2) C.P.	6S	(2) 2.5:1	(3) 200/5	9½	18	24	2½	1	1¼/6

600 Amps | 600 Volts | Bar Type CTs Only | Ringless

Catalog Number	Terminals	Hub	Meter Form	CTs Quantity & Ratio	Dimensions			Knockouts		
					D"	W"	H"	1	2	3
S3831-XT	6	(2) C.P.	4S	(2) 200/5	11¼	18	30	4	3½	1
S2690-XT	8	(2) C.P.	5S	(2) 200/5	11¼	18	30	4	3½	1
S2674-XT	13	(2) C.P.	8S	(3) 200/5	11¼	18	30	4	3½	1

Notes

- **Hubs:** Units are supplied with two closing plates as standard. To order hubs as extra refer to the hub suffix chart on the accessory page.
- **Prewiring:** Units supplied prewired with test switch and transformers in place. Contact factory if wiring diagram is desired.
- **Pricing:** Contact general office for pricing information.
- **Other units available - contact factory for details.**

Utility requirements for this equipment may vary. Always consult the serving utility for their requirements before ordering or installing equipment.



26

100-200 AMP
METER MAIN
PEDESTAL

Meter Pedestal

100-200 Amps | 4 Terminals | Ringless | 120/240 VAC

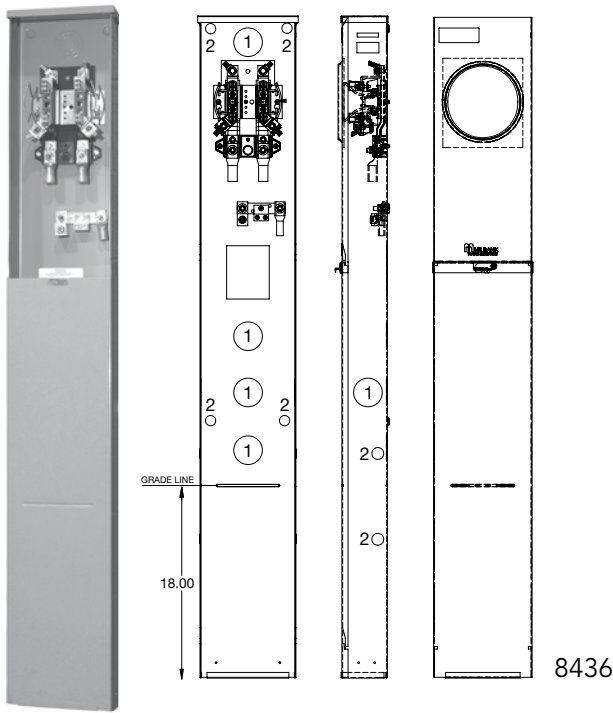

U8436-O

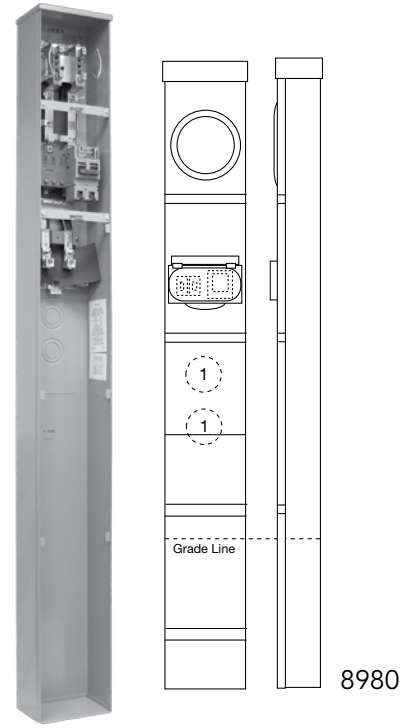

NU8980-O-KK

4 Terminals | Ringless | Underground Service

Catalog Number	Amps	Hub	Connectors CU/AL		Bypass	Dimensions			Knockouts	
			Line	Load		D"	W"	H"	1	2
U8436-O	200	Blank	4/0 (line) 2/0 (neutral)	#6-350	Horn	4 1/8	9	62	2	1/4, 1/2
NU8980-O	200	Blank	#6-350	CB ¹	None	6	9	79	2 1/2	—
NU8980-O-SF100	100	Blank	#6-350	CB	None	6	9	79	2 1/2	—
NU8980-O-200 ²	200	Blank	#6-350	CB	None	6	9	79	2 1/2	—

Notes

¹ Field Installed Circuit Breaker Required. ² Milbank main breaker.

- **Hanging Hook:** U8436 is supplied with keyhole hanger for easy mounting to building.
- **Extension Unit:** For U8436, order extension unit K5800 for 15" burial applications and two K5800 units for 30" burial applications.
- **Series Wired Main:** For series wired main order wire kit K4714 and UQFPH-M type circuit breaker.
- **Branch Circuit Breakers:** Branch interior accepts most manufacturers' small frame plug-in type circuit breakers (Milbank, GE, Siemens, Cutler-Hammer, Murray).
- **SF:** SF in catalog number has small frame plug-in type circuit breaker installed on middle stabs of 4-circuit interior. Only two single pole spaces available.
- **Fifth Terminal:** For field installed fifth terminal, order catalog number K5T.
- **Listing:** Listed for free standing or wall mount.



Utility requirements for this equipment may vary. Always consult the serving utility for their requirements before ordering or installing equipment.

Meter Main w/ Load Center Pedestal

100–200 Amps | 4 Terminals | Ringless

27

100-200 AMP
METER MAIN
W/ LOAD CENTER
PEDESTAL



U5136-O-200S

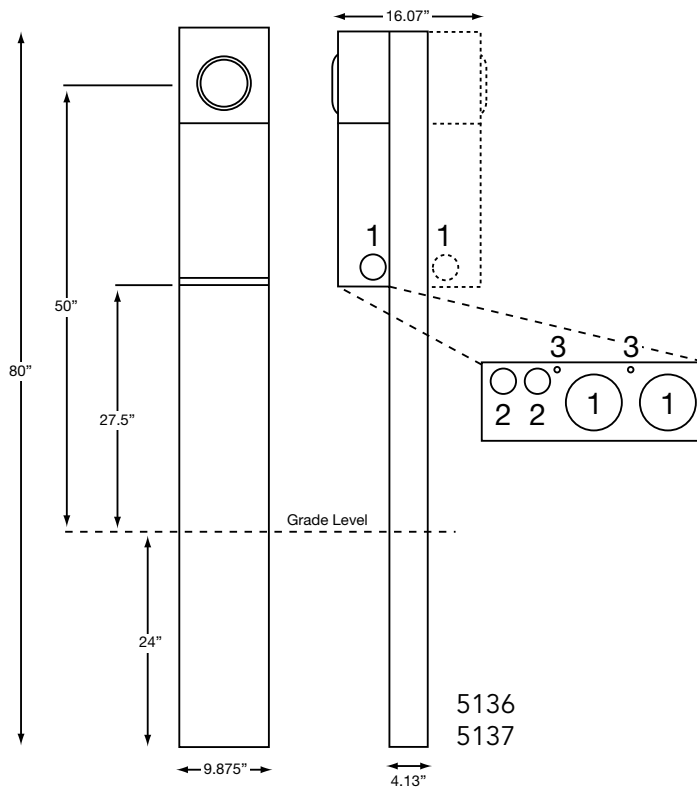

5136
5137

100-200 Amps | 4 Terminals | Meter Main Pedestal | Ringless

Catalog Number	Service	Meter Positions	Bypass	Connectors CU/AL		Knockouts		
				Line	Load	1	2	3
U5136-O-100S	UG	Single	Horn	#6-350	CB	2	1/2, 3/4	1/4
U5136-O-200S	UG	Single	Horn	#6-350	CB	2	1/2, 3/4	1/4
U5137-O-200S	UG	Double	Horn	#6-350	CB	2	1/2, 3/4	1/4

Notes

- **Parallel to Series Conversion:** For field converting from parallel wired to series wired order **K5194**.
- **Fifth Terminal:** For field installed fifth terminal, order **K5T**.
- **Stabilizer Foot:** For field installed stabilizer foot, order **K5415**.
- **Application:** Designed for free standing direct burial.
- **Receptacles:** Consult factory for installed receptacle assemblies.
- **Main Breaker:** Milbank UQFP-M-(AMP).
- **Ring Type Units:** Ring type units available—contact Milbank for details.

Utility requirements for this equipment may vary. Always consult the serving utility for their requirements before ordering or installing equipment.



Surface Mount Power Outlet

Millennium Series | Metered & Unmetered



U5000-XL-75

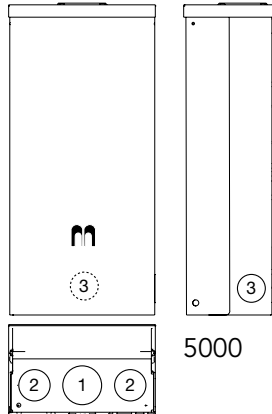

5000



U5100-XL-75

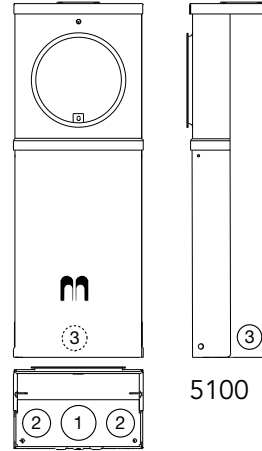

5100

125 Amps | Surface Mount Power Outlets

Catalog Number	Metered/ Unmetered	Receptacle Configuration	Circuit Breaker Configuration	Loop Feed Line	Dimensions			Knockouts		
					D"	W"	H"	1	2	3
U5000-XL	Unmetered	—	—	(2) 1/0-#12	5½	9⅞	19¼	2	1½	1¼
U5000-XL-41	Unmetered	A	X	(2) 1/0-#12	5½	9⅞	19¼	2	1½	1¼
U5000-XL-55	Unmetered	B	Y	(2) 1/0-#12	5½	9⅞	19¼	2	1½	1¼
U5000-XL-75	Unmetered	C	Z	(2) 1/0-#12	5½	9⅞	19¼	2	1½	1¼
U5100-XL	Metered	—	—	#6-250	5½	9⅞	25	2	1½	1¼
U5100-XL-41	Metered	A	X	#6-250	5½	9⅞	25	2	1½	1¼
U5100-XL-55	Metered	B	Y	#6-250	5½	9⅞	25	2	1½	1¼
U5100-XL-75	Metered	C	Z	#6-250	5½	9⅞	25	2	1½	1¼

Receptacle Configurations

A	B	C
(1) TT30R, (1) 5-20R GFI	(1) 14-50R, (1) 5-20R GFI	(1) 14-50R, (1) TT30R, (1) 5-20R GFI

Notes

- **Other Configurations:** Additional configurations are available—contact Milbank for details.
- **Metered Units:** Metered units are ring type.

Circuit Breaker Configurations

X	Y	Z
(1) 30A, 1P, 120V (1) 20A, 1P, 120V	(1) 50A, 2P, 120/240V (1) 20A, 1P, 120V	(1) 50A, 2P, 120/240V (1) 30A, 1P, 120V (1) 20A, 1P, 120V



Utility requirements for this equipment may vary. Always consult the serving utility for their requirements before ordering or installing equipment.

Power Outlet Pedestals

Millennium Series | Metered & Unmetered

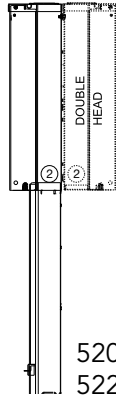
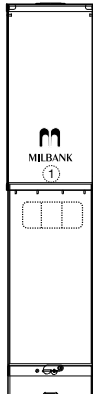

5200
5220

U5200-XL-75

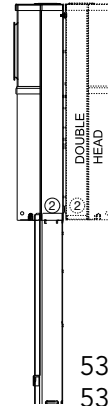

5300
5320

U5300-O-75

125 Amps | Power Outlet Pedestals

Catalog Number	Double Head Catalog Number	Receptacle Configuration	Circuit Breaker Configuration	Dimensions			Knockouts
				D"	W"	H"	1
U5200-XL	U5220-XL	—	—	5 ⁹ / ₁₆	9 ¹ / ₈	64 ¹ / ₂	1 ¹ / ₄
U5200-XL-41	U5220-XL-41	A	X	5 ⁹ / ₁₆	9 ¹ / ₈	64 ¹ / ₂	1 ¹ / ₄
U5200-XL-55	U5220-XL-55	B	Y	5 ⁹ / ₁₆	9 ¹ / ₈	64 ¹ / ₂	1 ¹ / ₄
U5200-XL-75	U5220-XL-75	C	Z	5 ⁹ / ₁₆	9 ¹ / ₈	64 ¹ / ₂	1 ¹ / ₄
U5300-O	U5320-O	—	—	5 ⁹ / ₁₆	9 ¹ / ₈	70 ¹ / ₄	1 ¹ / ₄
U5300-O-41	U5320-O-41	A	X	5 ⁹ / ₁₆	9 ¹ / ₈	70 ¹ / ₄	1 ¹ / ₄
U5300-O-55	U5320-O-55	B	Y	5 ⁹ / ₁₆	9 ¹ / ₈	70 ¹ / ₄	1 ¹ / ₄
U5300-O-75	U5320-O-75	C	Z	5 ⁹ / ₁₆	9 ¹ / ₈	70 ¹ / ₄	1 ¹ / ₄

Receptacle Configurations

A	B	C
(1) TT30R, (1) 5-20R GFI	(1) 14-50R, (1) 5-20R GFI	(1) 14-50R, (1) TT30R, (1) 5-20R GFI

Circuit Breaker Configurations

X	Y	Z
(1) 30A, 1P, 120V (1) 20A, 1P, 120V	(1) 50A, 2P, 120/240V (1) 20A, 1P, 120V	(1) 50A, 2P, 120/240V (1) 30A, 1P, 120V (1) 20A, 1P, 120V

Notes

- **Other Configurations:** Additional configurations are available—contact Milbank for details.
- **Metered Units:** Metered units are ring type.

Utility requirements for this equipment may vary. Always consult the serving utility for their requirements before ordering or installing equipment.





U4540-XL

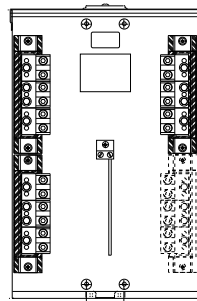

Shown with optional 3Ø Lug Kit

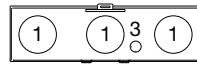

4540

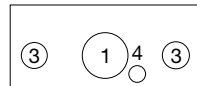

4542

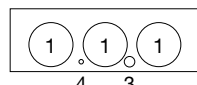

4544

4546

4548

4549



S9617-O

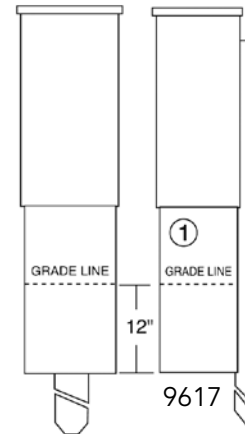

Terminal Boxes | 1Ø and 3Ø | 120/240 Volts

Catalog Number	Amps	Phase	Volts	Hub	Connectors CU7AL	1Ø to 3Ø Kit	Dimensions			Knockouts			
							D"	W"	H"	1	2	3	4
U4544-XL	100	1	120/240	C.P.	(6) #12-1/0	K4543	4 1/8	9 13/16	18	2	1	1/4, 1/2	—
U4546-XL	100	3	600	C.P.	(6) #12-1/0	N/A	4 1/8	9 13/16	18	2	1	1/4, 1/2	—
U4540-XL	200	1	120/240	C.P.	(6) #6-350	K4539	4 1/8	14 13/16	23	2 1/2	2 1/2	1 1/4	1 1/4, 1/2
U4542-XL	200	3	600	C.P.	(6) #6-350	N/A	4 1/8	14 13/16	23	2 1/2	2 1/2	1 1/4	1 1/4, 1/2
U4548-RXL	400	1	120/240	C.P.	(3) #6-350 or (2) #4-600	K4547	5	15 1/2	27	3	3	1/4, 1/2	1/4
U4549-RXL	400	3	600	C.P.	(3) #6-350 or (2) #4-600	N/A	5	15 1/2	27	3	3	1/4, 1/2	1/4

Notes

- **Hub:** Standard hub opening on top with closing plate attached.
- **Features:** UL-listed pad lockable Type 3R enclosure.
- **3Ø 120/240V Application:** Field installable 3Ø lug kit converts 1Ø unit to 3Ø unit.

Secondary Service Pedestal for Underground Use

Catalog Number	Pedestal Supplied With	Dimensions		
		D"	W"	H"
S9617-O	(3) 6 hole 350 MCM connector bars	10 11/32	10 3/8	45 11/16

Notes

- **Features:** Unit supplied with 3/8"-16 penta head bolt and pad-lockable latch.
- **Stake:** Catalog number **S9110** must be added to catalog number in order to ensure shipment of 72" stake for free standing installation (i.e. **S9617-O-S9110**).



Utility requirements for this equipment may vary. Always consult the serving utility for their requirements before ordering or installing equipment.

Terminal Box

Secondary

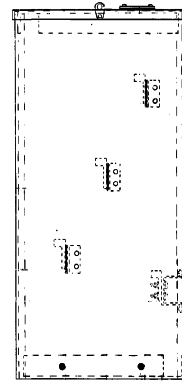
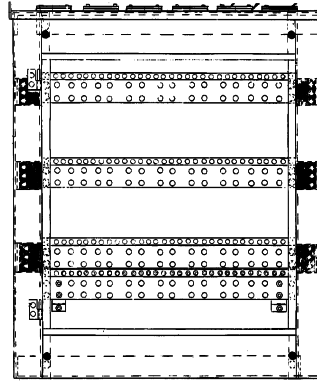
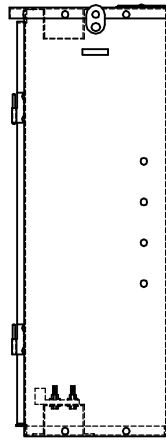
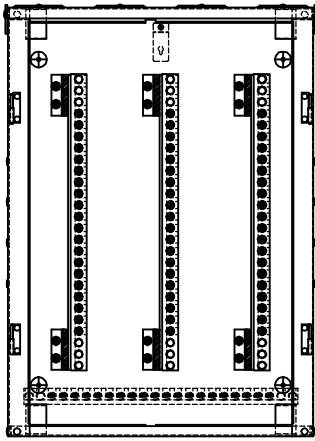

8333

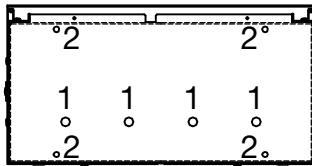

1787

Terminal Boxes

Catalog Number	Hub	Amps (End Connection)	Amps (Center Connection)		Dimensions			Knockouts	
			Each Way	Total	D"	W"	H"	1	2
S1787-4X	(4) C.P.	950	950	1900	14	30	42	7/8	5/16
S8333-6X	(6) C.P.	1500	1500	3000	24	44	52	—	—

Notes

- **Hot Bus Support:** Hot bus support and support ear available as kit for the S8333. Order kit K1822. Kit also includes hardware to mount bus.

Utility requirements for this equipment may vary. Always consult the serving utility for their requirements before ordering or installing equipment.



Commercial Pedestals

Attractive | Easy to Install | Secure | Cost-Effective

Milbank Commercial Pedestals are pad-mounted, weatherproof electrical enclosures consisting of a utility pull section with optional meter socket, and a customer section containing distribution and control equipment. Milbank Commercial Pedestals are an attractive, secure, easy to install and cost-effective solution when underground remote site power distribution and control equipment is required, replacing unsightly and inefficient strut and backboard structures.



Strut and backboard



Commercial pedestal

UL-listed as Industrial Control Equipment (File E113855)

Standard Features

- Type 3R rainproof, vandal-resistant cabinet of polyurethane powder-coated steel (aluminum or stainless steel also available)
- UL-listed as enclosed industrial control equipment (UL508)
- Isolated lockable & sealable utility metering and lug landing sections
- Lockable customer section for distribution and control equipment with internal deadfront
- Print pocket inside customer section door contains wiring schematics and installation instructions
- Most load centers are UL-listed for use with various manufacturers' circuit breakers
- All stainless steel external hardware (screws, bolts, hinges, handles, hasps and sealing screws)



Ringless socket



Ring type socket



Utility lug landing

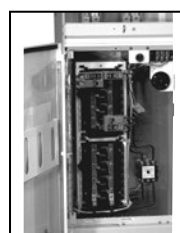

Customer interior



Utility requirements for this equipment may vary. Always consult the serving utility for their requirements before ordering or installing equipment.

Commercial Pedestals

Attractive | Easy to Install | Secure | Cost-Effective

33
COMMERCIAL
PEDESTALS

Applications

These units are ideal for controlling and metering:

- Traffic signals
- Street lighting
- Irrigation and sprinkler systems
- Cell towers and telephone vaults
- Pump stations
- Temporary power for fairgrounds, swap meets, outdoor markets, portable offices, holiday lights, etc.
- Outdoor lighting for athletic fields, tennis and basketball courts, parking lots, landscaping and subdivision entrances, etc.

Available Factory-Installed Options

- Meter sockets: ring type or ringless, up to 400 amp
- Main and branch breakers or T fuses
- Distribution: copper load centers and panel boards
- Clocks, timers and relays
- Photoelectric cells and controls
- Power receptacles: pin and sleeve, twist lock or straight blade
- Contactors: definite purpose, electrical or mechanically held, IEC and mercury types
- Surge protection and lightning arrestors
- Reserve inlet generator receptacle with interlocked circuit breakers
- Motor starters and relays
- Push button controls
- Thermostat controls, fans and heating strips
- Power blocks and terminal blocks
- Steel, aluminum and plywood backboards
- Transformers
- Interlock devices for circuit breakers
- Available in steel, aluminum (unpainted, painted or anodized) or stainless steel construction with powder-coated finish available in eight standard colors or special-ordered RAL colors
- Available for applications up to 400 amp, 120V, 208V, 240V, 277V, 480V - 1Ø or 3Ø



Utility requirements for this equipment may vary. Always consult the serving utility for their requirements before ordering or installing equipment.



Milbank | *Driving the Future of Power*

With over 85 years in the electrical distribution industry, Milbank is proud to offer quality home standby, portable, digital inverter and mobile & industrial generator systems.

Home Standby Generators

- Wide range of sizes for small to large luxury homes and businesses
- Liquid propane and natural gas options



Digital Inverter Generators

- Small footprint
- Lightweight
- Quiet operation
- Safe for sensitive electronics



Portable Generators

- Manual and electric start options
- EPA compliant



Transfer Switches

- Single- and three-phase options
- Whole house power management

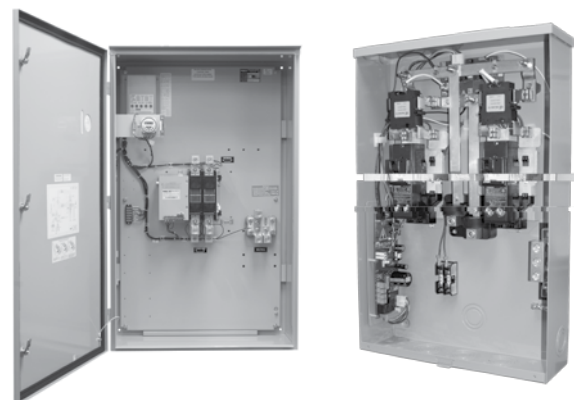

Utility requirements for this equipment may vary. Always consult the serving utility for their requirements before ordering or installing equipment.

Electric Vehicle Supply Equipment

Milbank | *Driving the Future of Power*

35
ELECTRIC
VEHICLE
SUPPLY
EQUIPMENT

From a wall-mounted single dock unit in a residential garage, to a citywide municipal integration, our scalable, flexible, reliable solution is designed for effectiveness in virtually any installation scenario.

Level II Models

MEVSE-RS—Residential, single wall mounted; overnight at-home charging.

MEVSE-RS Dual—Pedestal mounted with two ports; ideal for multi-family and high-traffic commercial parking lots.

MEVSE-RS+—Available in single, dual and quad configurations with the addition of programmable, smart charging capabilities; allows communication with the grid for charging when energy consumption is low; allows connectivity to GPRS.

Level III Models

DC Fast Charge — Stations feature JARI/TEPCO connectors and CHAdeMO certification; practical networking and payment options; available from 30-60kW models suitable for public and fleet usage; charges in 15-30 minutes.

Suitable EV Station Locations

- Shopping malls
- Theatres
- Municipal buildings
- Central business districts
- Entertainment districts
- Stadiums & arenas
- Rest areas
- Truck stops / travel plazas
- Camping / RV parks
- Restaurants
- Parking garages
- Public curbside parking
- Office buildings
- Single-family residences
- Multi-unit residences
- Airports
- Hotels
- Casinos
- Anywhere people park for extended periods of time



Utility requirements for this equipment may vary. Always consult the serving utility for their requirements before ordering or installing equipment.



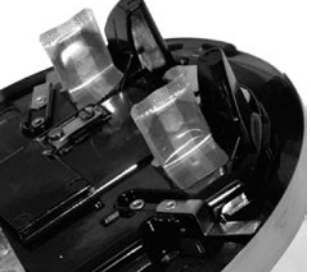

Disconnect/Out of Service Devices

Disconnect Sleeve

Application	Discretely disconnects service at the meter while leaving the meter in place.	 <p>M5-144 disconnect sleeves (above) shown installed on meter blades (below)</p> 
Features	<p>Mylar® polyester film — flexible, durable and stable even at extreme temperatures.</p> <p>Safe, reliable and easy to install</p> <p>Standard design fits most meter blades</p> <p>High dielectric strength</p> <p>Non-hygroscopic</p>	
Ordering	Order M5-144	
Installation Guidelines	<p>Turn off main switch or breaker before installation</p> <p>Remove meter from socket</p> <p>Place disconnect sleeve over load side blades</p> <p>Replace meter and reseal</p> <p>Do not use disconnect sleeves on lever bypass sockets.</p>	

Plug-In Out Of Service Device

Application	Disconnects service at the meter.	 <p>K4974 (above); meter with K4974 installed and service disconnected (below).</p> 
Features	<p>Meter stays in place to prevent tampering and to simplify power restoration</p> <p>Rotated meter shows that service has been disconnected</p> <p>Easily plugs into all new Milbank 200 amp blocks with square fifth terminal hole</p>	
Ordering	Order K4974	



Utility requirements for this equipment may vary. Always consult the serving utility for their requirements before ordering or installing equipment.

Accessories

Hubs and Closing Plates

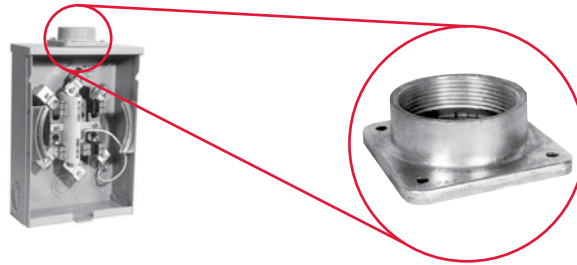
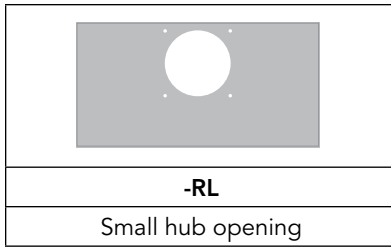

-WL A7514	-YL A7515	-ZL A7516	-DL A7517	-EL A7518	-XL A7551
1" hub	1¼" hub	1½" hub	2" hub	2½" hub	Small closing plate

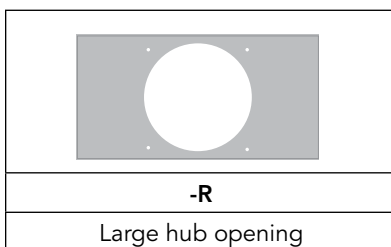

-F A8110	-G A8111	-H A8112	-X A9064	-RRL S8324
3" hub	3½" hub	4" hub	Large closing plate	Large hub opening adapted to small hub opening

Notes

- **Suffix:** Add to catalog number for factory installation of hub.
- **Packaging:** Individually packed units for field installation.
- **Abbreviations:** H.O. (hub opening), C.P. (closing plate).

Utility requirements for this equipment may vary. Always consult the serving utility for their requirements before ordering or installing equipment.



Connector Kits, Closing Covers & Sealing Rings

Connector Kits | For Use with 3/8"-16 Stud Type Units Only

Single			Twin		
Suffix	Part #	(3 per set) - 1Ø	Suffix	Part #	(3 per set) - 1Ø
K1	K1539	6-350	K2	K1350	6-350
K3	K1540	6-350 (non rotating)	K2L	K1350L	6-350 (non rotating)
K3L	K1540L	4-600 or (2) 1/0-250 (non rotating)	K4	K1541	4-600
Suffix	Part #	(4 per set) - 3Ø	Suffix	Part #	(4 per set) - 3Ø
K5	K3082	6-350	K6	K3442	6-350
K7	K3441	4-600 or (2) 1/0-250	K8	K3083	4-600

Bypass Link



K8180 (sold in pairs)

Closing Covers

Meter Closing Plate (Ring Type / Ringless)	Metal Closing Plate (For Ringless Sockets)
6003 - Grey Plastic	CP-21
6116 - Clear Plastic	



Generator Interlock

	Allows only one breaker to be in the "on" position when back-feeding with a standby power generator.
K5815 - large QN with small frame Q	
K5820 - large frame QN with large frame QN	
K5830 - small frame Q to small frame Q	

Sealing Rings

MR-2 - Snap Action	MR-4 - Screw Type (Stainless Steel)
MR2-SS - Stainless Steel	

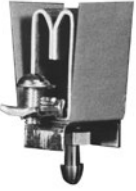
Fifth Terminals

		
5T8K2 - 100-200 Amp "Plug-In"	K5T - 200 Amp (Block with Square Hole)	K3865 - Heavy Duty Jaw Clamping (K3866 without Neutral Wire)

Triplex Ground

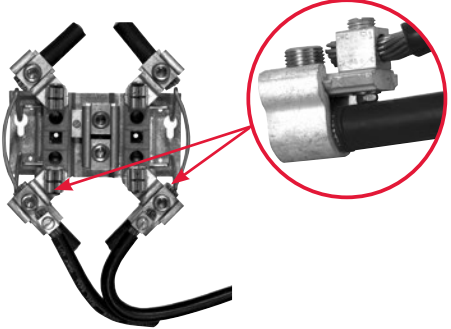

K1190 (For factory installed triplex ground, add suffix -TG to catalog number)

Tap Connectors (3 per set)

	Replaces the load or line side slide-in nut assembly on Milbank 200 amp sockets. Allows for a 100 amp tap location in addition to the #6-350 kcmil load-side connector. K5022 includes safety barrier extensions for applications over 300 VAC. Three lugs per kit.
K4977-INT - Internal Hex (set of 3)	
K4977-EXT - External Hex (set of 3)	
K5022-INT - Internal Hex (set of 4 w/ barrier)	

Locknut Clearances

Clearance for Locknuts on Knockouts

	<i>"D" in nearest practical dimension)</i>
Knockout Size	"D"
1/2	1 1/8
3/4	1 3/8
1	1 3/4
1 1/4	2 1/4
1 1/2	2 5/8
2	3 1/8
2 1/2	3 1/2
3	4 1/4
3 1/2	4 3/4
4	5 3/8

Knockout Actual Sizes

Conduit to Knockout Reference Chart

Conduit Size	Milbank Knockout	Actual Size Milbank Knockout
1/2	1/2	7/8
3/4	3/4	1 1/8
1	1	1 3/8
1 1/4	1 1/4	1 3/4
1 1/2	1 1/2	2
2	2	2 1/2
2 1/2	2 1/2	3
3	3	3 5/8
3 1/2	3 1/2	4 1/8
4	4	4 41/64

Utility requirements for this equipment may vary. Always consult the serving utility for their requirements before ordering or installing equipment.



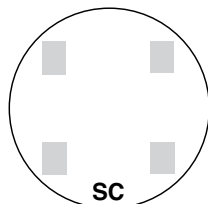

SC
2 and 3-WIRE FORMS
1S & 2S

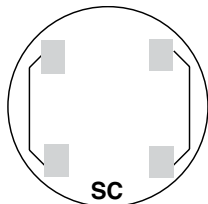

SC
2 and 3-WIRE FORMS
1S & 2S with BYPASS

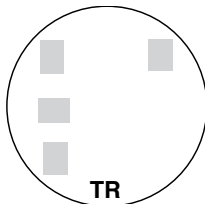

TR
2-WIRE FORM 3S
5th Term. 9 o'clock

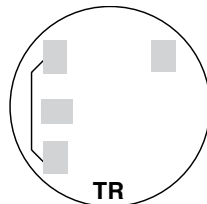

TR
2-WIRE FORM 3S
with BYPASS

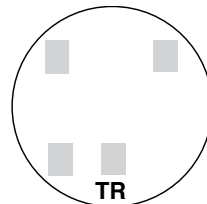

TR
2-WIRE FORM 3S
5th Term. 6 o'clock

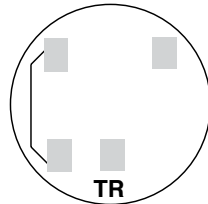

TR
2-WIRE FORM 3S
with BYPASS

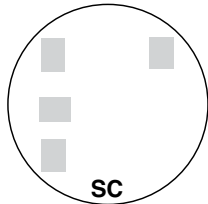

SC
2 ELEMENT
3-WIRE NETWORK
FORM 12S 5th
TERM. 9 o'clock

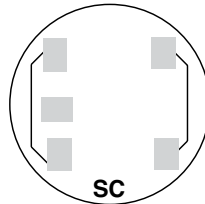

SC
2 ELEMENT 3-WIRE
NETWORK FORM 12S
with BYPASS
5th Term. 9 o'clock

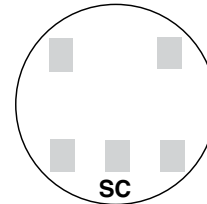

SC
2 ELEMENT
3-WIRE NETWORK
FORM 12S 5th
TERM. 6 o'clock

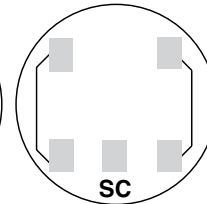

SC
2 ELEMENT 3-WIRE
NETWORK FORM 12S
with BYPASS
5th Term. 6 o'clock

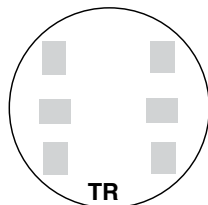

TR
3-WIRE FORM 4S

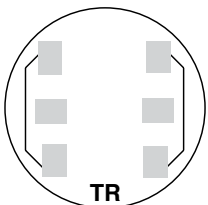

TR
3-WIRE FORM 4S
WITH BYPASS

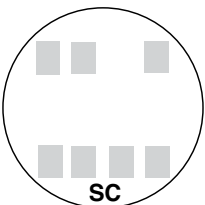

SC
2 or 3 ELEMENT
3Ø4W Y or Δ
Y FORM 14S
Δ FORM 15S

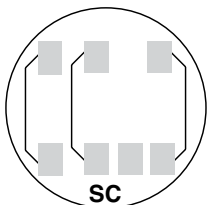

SC
2 or 3 ELEMENT
3Ø4W Y or Δ
FORMS 14S & 15S
with BYPASS

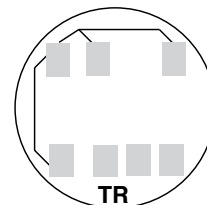

TR
2 ELEMENT
3Ø4W Y or Δ
Y FORM 7S
Δ FORM 24S
with BYPASS

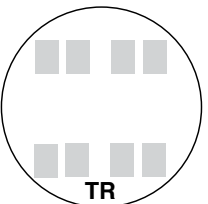

TR
2 ELEMENT
2Ø3W, 2Ø4W, 3Ø3W
FORM 5S

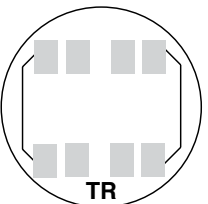

TR
2 ELEMENT 2Ø3W,
2Ø4W, 3Ø3W
FORM 5S with
BYPASS

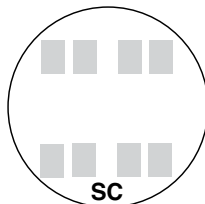

SC
2 ELEMENT
2Ø3W, 2Ø4W, 3Ø3W
FORM 13S

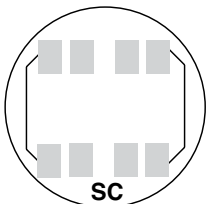

SC
2 or 3 ELEMENT
2Ø3W, 2Ø4W, 3Ø3W
FORM 13S with
BYPASS

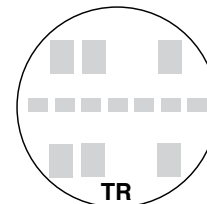

TR
2 or 3 ELEMENT
3Ø4W Y or Δ
Y FORM 9S
Δ FORM 8S

TR = TRANSFORMER RATED
SC = SELF CONTAINED

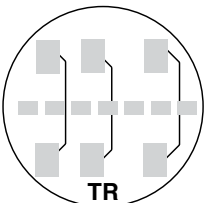

TR
2 or 3 ELEMENT
3Ø4W Y or Δ
FORMS 8S & 9S
with BYPASS

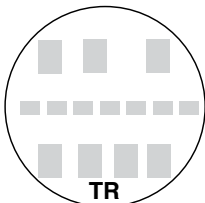

TR
2 ELEMENT
3Ø4W Y
FORM 6S

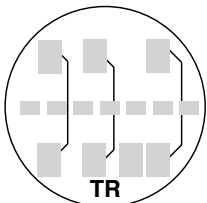

TR
2 ELEMENT
3Ø4W Y
FORM 6S
with BYPASS

Meter Forms

Reference Information

DIAGRAM A

1 \emptyset 2W with 1 P.T. & 1 C.T.
Single Stator Meter (2W1 \emptyset) - Form 35
5T Socket, Test Switch #TS04-0101

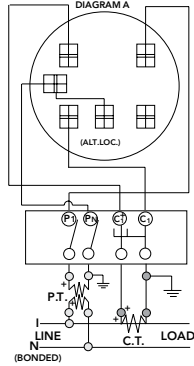

DIAGRAM B

1 \emptyset 3W with 1 C.T.
Single Stator Meter (2W1 \emptyset) - Form 35
5T Socket, Test Switch #TS04-0101

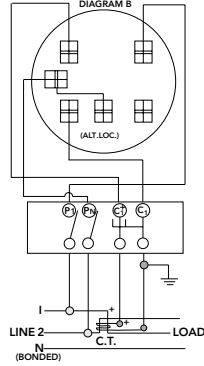

DIAGRAM C

1 \emptyset 3W with 2 C.T.'s
Single Stator Meter (3W1 \emptyset) - Form 45
6T Socket, Test Switch #TS07-0105

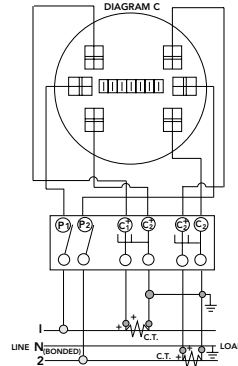

DIAGRAM D

1 \emptyset 3W or 3W Network with 2 C.T.'s
2 Stator Meter - Form 55
8T Socket, Test Switch #TS07-0105

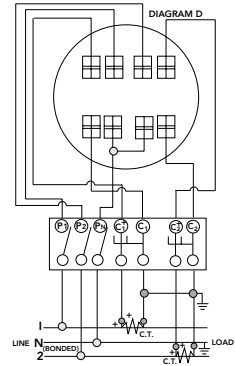

DIAGRAM E

3 \emptyset 3W "A" with 2 P.T.'s & 2 C.T.'s
2 Stator Meter - Form 55
8T Socket, Test Switch #TS07-0105

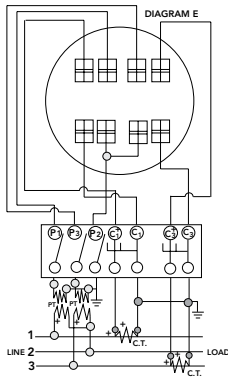

DIAGRAM F

3 \emptyset 3W "A" with 2 C.T.'s
2 Stator Meter - Form 55
8T Socket, Test Switch #TS07-0105

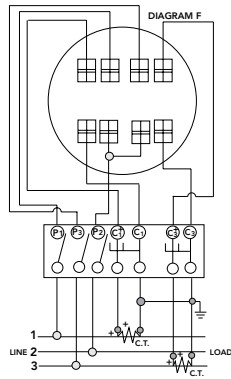

DIAGRAM G

3 \emptyset 4W "Y" with 3 C.T.'s
2 1/2 Stator Meter - Form 65
13T Socket, Test Switch #TS10-0109

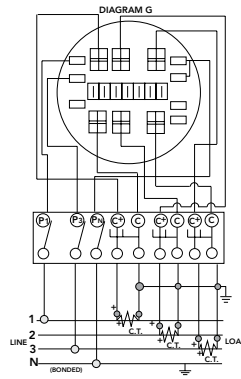

DIAGRAM H

3 \emptyset 4W "Y" with 2 P.T.'s & 3 C.T.'s
2 1/2 Stator Meter - Form 65
13T Socket, Test Switch #TS10-0109

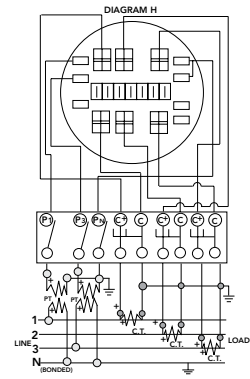

DIAGRAM I

3 \emptyset 4W "Y" or "A" with 3 C.T.'s
"Y" 3 Stator Meter - Form 95
"A" 2 Stator Meter - Form 85
13T Socket, Test Switch #TS10-0109

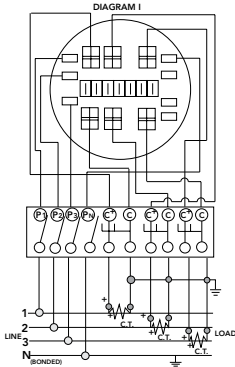
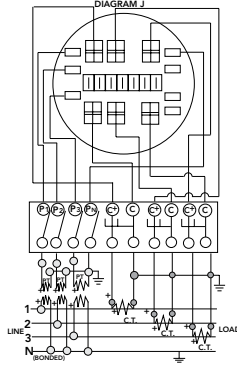

DIAGRAM J

3 \emptyset 4W "Y" with 3 P.T.'s & 3 C.T.'s
3 Stator Meter - Form 95
13T Socket, Test Switch #TS10-0109



Prewiring: If standard factory prewiring is required, refer to wiring diagrams on this page. Determine appropriate diagram and send a copy with order. If custom factory prewiring is required, specify on order. Be sure to include meter socket catalog number, test switch make and catalog number, meter form number and provide a copy of your wiring diagram.

Utility requirements for this equipment may vary. Always consult the serving utility for their requirements before ordering or installing equipment.



Materials

Steel Quality

The meter equipment listed in this catalog is made of galvanized steel (AISI* G90) to afford the best possible weather proofing.
*American Iron and Steel Institute.

Steel Sheet

16 gauge, galvanized, sheet: 1 1/4 oz./ sq.ft. class zinc-coated. (AISI G90)
14 gauge, galvanized, sheet: 1 1/4 oz./ sq.ft. class zinc-coated.

Aluminum Extrusion

Wire-Terminals: Alloy; 6061-T6, Tin-plated for CU/AL wire.
Bus Bar: Alloy; 6101-O & 6063-O

Aluminum Sheet

3000 series aluminum sheet, H14, or 5052 series aluminum sheet, H32. Where applicable thicknesses range from .064-.125

Copper Sheet & Bus

Electrolytic copper with tin plating in most applications.

Insulating Materials

- In most units, support bases for current-carrying components are molded from fiberglass reinforced high-strength, track resistant, thermoset polyester molding compounds.
- Clear or black safety shields and polarity barriers are molded from high-strength, track resistant, polycarbonate molding compounds.
- Various sheet insulating materials, as appropriate for the application are utilized in the fabrication of flat, formed and punched component parts and barriers.

Finish

Process

Light gray state-of-the-art electrostatically applied powder paint offers a durable, non-fading finish. For further information concerning the chemical analysis of the weather resistant finish, please contact the factory.

Metal Fastners

Zinc-coated with a chromate dip.

Ratings & Compliance

Ratings & Compliance

All Milbank electrical enclosures in this catalog are rated "Type 3R Enclosure" unless specified otherwise on the product's page. All enclosures with a UL designation are constructed per the appropriate UL Standard and may be installed per the National Electric Code. UL procedure files associated with the UL Standards are listed as follows: Meter Sockets (UL 414, File E30202), Test Switches (UL 414, File E62531), Power Outlets (UL 231, File E90945), Panelboards (UL 67, File E32628) and Pullout Switches (UL 1429, File E133062). Additional standards are utilized as applicable: Meter Sockets (ANSI C12.7), Test Switches (ANSI C12.9) and Panelboards (NEMA PB-1).



Utility requirements for this equipment may vary. Always consult the serving utility for their requirements before ordering or installing equipment.

Enclosure Information

Milbank Electrical Meter Enclosures Specification Note

All Milbank electrical enclosures in this catalog are rated "Type 3R Electrical Enclosure" unless specified otherwise. All enclosures with a UL designation are constructed per the appropriate UL standard and may be installed per the National Electric Code. Meter sockets are constructed per "UL 414, Meter Sockets", file #E30202 and per "ANSI C12.7-1993-Meter Sockets". All test switches are constructed per "UL 414, Meter Sockets", file #E30302 and per "ANSI C12.9-1993-Test Switches". Power outlets are constructed per "UL 231, Power Outlets", file #E90945. Panelboards are constructed per "UL 67, Panelboards", file #E32628 and "NEMA PB-1-1984-Panelboards". Pullout switches are constructed per "UL 1429, Pullout Switches", file #133062.

Definitions Pertaining to Nonhazardous Locations | Indoor Use

Type 1 Enclosure

Type 1 enclosures are intended for indoor use primarily to provide a degree of protection against limited amounts of falling dirt.

Type 12 Enclosure

Type 12 enclosures are intended for indoor use primarily to provide a degree of protection against circulating dust, falling dirt and dripping noncorrosive liquids.

Type 13 Enclosure

Type 13 enclosures are intended for indoor use primarily to provide a degree of protection against dust, spraying of water, oil and noncorrosive coolant.

Definitions Pertaining to Nonhazardous Locations | Outdoor Use

Type 3 Enclosure

Type 3 enclosures are intended for outdoor use primarily to provide a degree of protection against rain, sleet, windblown dust and damage from external ice formation.

Type 3R Enclosure

Type 3R enclosures are intended for outdoor use primarily to provide a degree of protection against rain, sleet and damage from external ice formation.

Type 4 Enclosure

Type 4 enclosures are intended for indoor or outdoor use primarily to provide a degree of protection against windblown dust and rain, splashing water, hose-directed water and damage from external ice formation.

Type 4X Enclosure

Type 4X enclosures are intended for indoor or outdoor use primarily to provide a degree of protection against corrosion, windblown dust and rain, splashing water, hose-directed water and damage from external ice formation.

Utility requirements for this equipment may vary. Always consult the serving utility for their requirements before ordering or installing equipment.



6003.....	38	K4722	24	U1797-O-K2L-K3L	11
6116.....	38	K4729	24	U3328-RXL.....	8
363010-CT3R.....	22	K4797	24	U4363-R.....	11
363016-CT3R.....	22	K4798	24	U4505-X.....	11
363610-CT3R.....	22	K4974	36	U4540-XL.....	30
363612-CT3R.....	22	K4977-EXT.....	39	U4542-XL.....	30
363616-CT3R.....	22	K4977-INT.....	39	U4544-XL.....	30
483616-CT3R.....	22	K5022-INT.....	39	U4546-XL.....	30
484812-CT3R.....	22	K5815	38	U4548-RXL.....	30
5T8K2.....	39	K5820	38	U4549-RXL.....	30
606013-CT3R.....	22	K5830	38	U5000-XL.....	28
A7514.....	37	K5T.....	39	U5000-XL-41.....	28
A7515.....	37	K8180	38	U5000-XL-55.....	28
A7516.....	37	M5-144	36	U5000-XL-75.....	28
A7517.....	37	MR-2.....	38	U5100-XL.....	28
A7518.....	37	MR2-SS.....	38	U5100-XL-41.....	28
A7551.....	37	MR-4.....	38	U5100-XL-55.....	28
A8110.....	37	NU8980-O.....	26	U5100-XL-75.....	28
A8111.....	37	NU8980-O-2002.....	26	U5136-O-100S.....	27
A8112.....	37	NU8980-O-SF100.....	26	U5136-O-200S.....	27
A9064.....	37	PT48AL.....	22	U5137-O-200S.....	27
AP2300-03.....	4	PT48AR.....	22	U5168-XTL-100.....	13
AP2300-03-5T.....	4	PT48L.....	22	U5168-XTL-200.....	13
AP2300-03-5T-AB.....	4	PT48R.....	22	U5169-XTL-100.....	13
AP2300-03-6T.....	4	S1787-4X.....	31	U5169-XTL-200.....	13
AP2300-04.....	4	S1890-XT.....	25	U5200-XL.....	29
AP2300-07.....	4	S1891-XT.....	25	U5200-XL-41.....	29
AP2300-08.....	4	S1910-YL.....	8	U5200-XL-55.....	29
CP-21.....	38	S2417-DL.....	8	U5200-XL-75.....	29
CT244811-HC.....	24	S2417-RL.....	8	U5220-XL.....	29
CT244811-SC.....	24	S2674-XT.....	25	U5220-XL-41.....	29
CT304811-HC.....	24	S2690-XT.....	25	U5220-XL-55.....	29
CT304811-SC.....	24	S3831-XT.....	25	U5220-XL-75.....	29
CT364811-HC.....	24	S3912-XT.....	25	U5300-O.....	29
CT364811-SC.....	24	S4275-DL.....	8	U5300-O-41.....	29
K1190.....	39	S4339-RL.....	8	U5300-O-55.....	29
K1350.....	38	S8324.....	37	U5300-O-75.....	29
K1350L.....	38	S8333-6X.....	31	U5320-O.....	29
K1539.....	38	TS04-0101.....	21	U5320-O-41.....	29
K1540.....	38	TS04-0104.....	21	U5320-O-55.....	29
K1540L.....	38	TS07-0049.....	21	U5320-O-75.....	29
K1541.....	38	TS07-0105.....	21	U5764-X-200-CB.....	15
K3082.....	38	TS07-0106.....	21	U5765-X-200-CB.....	15
K3083.....	38	TS10-0016.....	21	U5767-X-200-CB.....	15
K3441.....	38	TS10-0109.....	21	U5784-O-200-CB.....	15
K3442.....	38	TS10-0110.....	21	U5787-O-200-CB.....	15
K3865.....	39	TS10-0111.....	21	U5796-X-400-CB.....	15
K3866.....	39	TS10-0112.....	21	U5797-O-400-CB.....	15



Utility requirements for this equipment may vary. Always consult the serving utility for their requirements before ordering or installing equipment.

U5799-O-400-CB.....	15	U5929-XL.....	5	U9701-RXL.....	9
U5842-PXL-200.....	12	U5934-XL.....	5	UAP5024-XL.....	13
U5842-RL.....	12	U7017-DL-TG.....	7	UC1299-RL.....	18
U5842-RL-100.....	12	U7017-RL-TG.....	7	UC1300-XL.....	18
U5844-PXL-200.....	12	U7017-RL-TG-5T.....	7	UC5087-RL.....	19
U5852-RL.....	12	U7018-XL-TG.....	7	UC5732-XL.....	18
U5852-RL-100.....	12	U7021-DL-TG.....	6	UC7235-RL.....	18
U5852-RL-200.....	12	U7021-RL-TG.....	6	UC7237-RL.....	18
U5854-RL-200.....	12	U7021-RL-TG-5T.....	6	UC7444-RL.....	19
U5882-X.....	17	U7040-RL-TG.....	6	UC7445-RL.....	19
U5883-X.....	17	U7420-RL.....	9	UC7448-RL.....	19
U5884-X.....	17	U7421-RL.....	9	UC7449-RL.....	19
U5885-X.....	17	U7422-RXL.....	9	UC7478-RL.....	19
U5886-X.....	17	U7423-RXL.....	9	UC7532-RL.....	19
U5890-X-2/200.....	14	U7487-RL-TG.....	5	UC7544-XL.....	18
U5891-X-2/200.....	14	U7487-RL-TG-5T.....	5	UC7545-XL.....	18
U5892-X-2/200.....	14	U7490-YL-TG.....	5	UCSS3433-O.....	10
U5893-X-2/200.....	14	U7490-YL-TG-5T.....	5	UCSS3436-O.....	10
U5894-X-2/200.....	14	U8212-RL.....	16	UCSS3438-O.....	10
U5895-X-2/200.....	14	U8213-RL.....	16	USS3914-O.....	10
U5902-X.....	17	U8214-RL.....	16	USS4701-O.....	10
U5903-X.....	17	U8215-RL.....	16	USS4801-O.....	10
U5904-X.....	17	U8216-XL.....	16	USS4801-O-5T9.....	10
U5905-X.....	17	U8436-O.....	26		
U5906-X.....	17	U9700-RRL.....	9		

Utility requirements for this equipment may vary. Always consult the serving utility for their requirements before ordering or installing equipment.







MILBANK[®]

ENERGY AT WORK

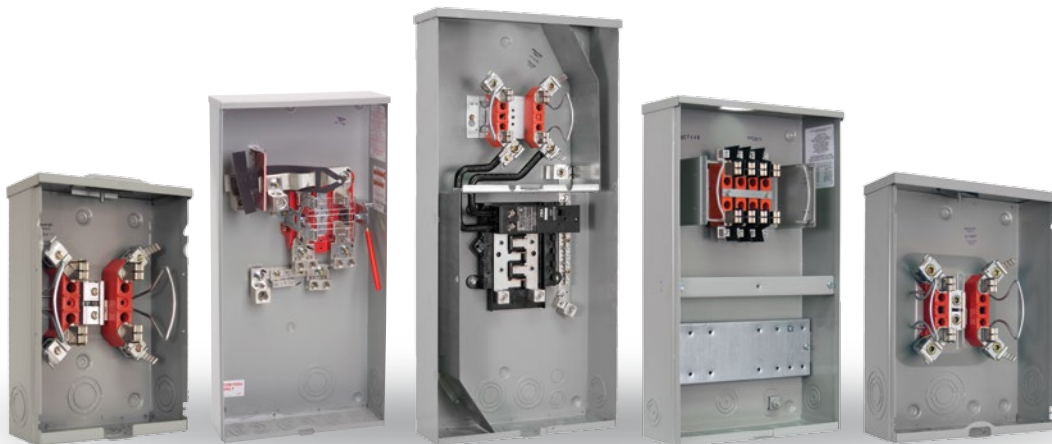



MILBANK[®]
ENERGY AT WORK



International Catalog

Metering Equipment



About Milbank

Energy at work since 1927

Milbank provides the tools that empower life. We enable the amazing in countless everyday ways through our thoughtfully designed products and collaborative ingenuity. More than a manufacturing company, we are an active and engaged contributor in the movement of energy. We are energy at work.

Milbank designs and builds solutions that move power for the residential, commercial, industrial, utility and transportation sectors. Milbank combines more than 85 years of expertise in electrical engineering and production with a commitment to develop and implement sustainable, integrated power solutions. A third-generation, family-owned business, Milbank is headquartered in Kansas City, Mo. For more information, please visit www.milbankworks.com.



METERING

Milbank meter sockets have set the standard for quality since 1927. With a 99.97% quality performance, thousands of active products to meet your utility's requirements and tens of millions of sockets installed across the globe, our products help keep energy at work. And with 22 stocking locations across the U.S., and our OneSERT program to help during emergency situations, our meter sockets are ready to go, wherever the job may be.



ENCLOSURES & ENCLOSED CONTROLS

When it comes to enclosures and enclosed control products, Milbank has it covered! We offer a complete line of junction boxes, telephone cabinet covers, transformer cabinets, wireways, pushbutton enclosures, consoles and thermal management products. We specialize in custom-built enclosures and are more than happy to design a solution for your specific project. Our commercial pedestals are easy to install, fast, safe and secure, and completely customizable.



GENERATORS & ENERGY MANAGEMENT

Milbank's standby and portable generators give you the peace of mind of living life uninterrupted during increasingly frequent power outages caused by severe weather, high demand and other situations. Our energy management systems give you reliable and sustainable ways to reduce both your energy costs and your impact on the environment.



Table of Contents

See back of catalog for index by catalog number

Single Position Meter Sockets

Economy socket, 4–6 terminals, ring type	4
100–125 amps, 4 & 5 terminals, ringless & ring type	5
200 amps, 4 & 5 terminals, ringless & ring type	6–7
100–200 amps, 7 terminals, ringless & ring type	8
200 amps, 7 terminals, ringless.....	9
Stainless steel meter sockets	10
320 amps, 4 & 5 terminals, lever bypass, ringless	11

Meter Mains

100–200 amps, 4 terminals, ringless.....	12
100–200 amps, with load center, 4 terminals, ringless & ring type	13
320 amps, 4 terminals, lever bypass, ringless.....	14
Cold squence, 4–7 terminals, ringless.....	15

Multi-Position

100 amps, 5 terminals, ringless.....	16
Meter mains, 125 & 200 amps, 4 terminals, ringless	17

Transformer Rated, Test Switches, Transformer Cabinets & Transockets

20 amps, 6–15 terminals, ringless & ring type	18–19
Test switches	20–22
Transformer cabinets	23–24
600 amp transockets, 6–14 terminals, ringless	25

Pedestals

100–200 amps, meter main pedestals, 4 terminals, ringless.....	26
100–200 amps, meter main with load center pedestals, 4 terminals, ringless.....	27

Power Outlets/RV Power

Surface mount power outlets.....	28
Power outlet pedestals.....	29

Miscellaneous

Terminal boxes	30–31
Commercial meter pedestals	32–33
Generators.....	34
Electric vehicle supply equipment	35
Accessories	36–39
Reference information	40–43



4

ECONOMY
SOCKET

Economy Socket

4–6 Terminals | 100 Amps | Ring Type

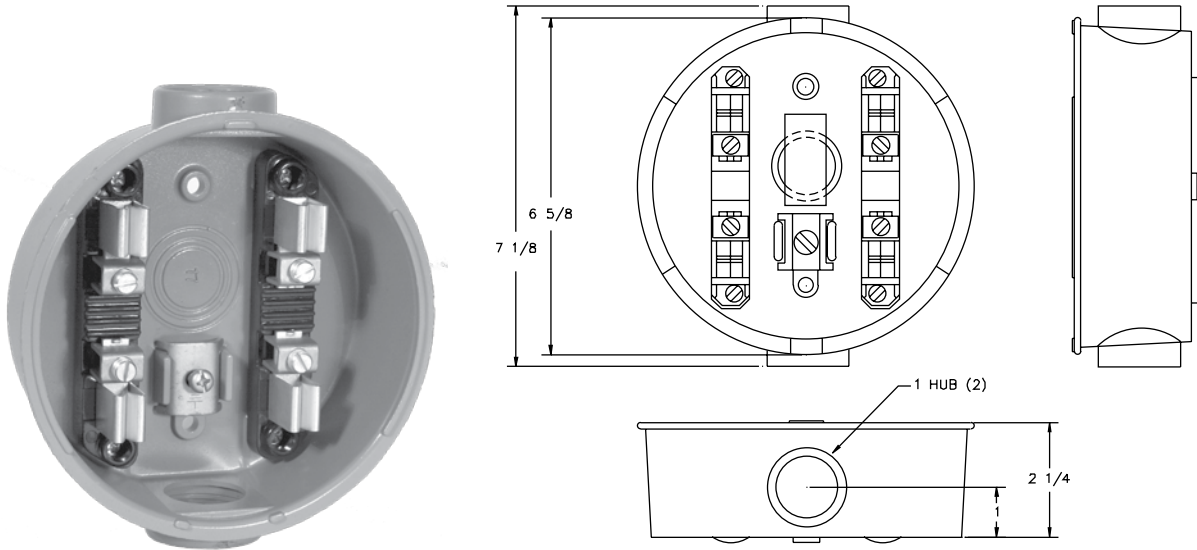

30-100 Amps | 4, 5 & 6 Terminals | Economy Cast Socket | Ring Type

Catalog Number	Terminals	Hub Location	Hub Size	Connectors CU/AL	Quantity per Package	Knockouts
AP2300-03	4	Top & Bottom	(2) 1"	#12-#1	12	¾", 1"
AP2300-04	4	Top & Bottom	(2) 1¼"	#12-#1	12	¾", 1"
AP2300-07	4	Top	1"	#12-#1	12	¾", 1"
AP2300-08	4	Top	1¼"	#12-#1	12	¾", 1"
AP2300-03-5T	5	Top & Bottom	(2) 1"	#12-#1	12	¾", 1"
AP2300-03-5T-AB	5	Top & Bottom	(2) 1"	#12-#1	12	¾", 1"
AP2300-03-6T	6	Top & Bottom	(2) 1"	#12-#1	12	¾", 1"

Notes

- **Non-UL Listed:** These units are not UL tested.
- **Fifth Terminal:** AP2300-03-5T and AP2300-03-5T-AB include factory-installed fifth terminal
- **Sixth Terminal:** AP2300-03-6T includes factory-installed sixth terminal.
- **Auto-Bypass:** -AB suffix indicates installed auto-bypass feature. Consult factory for more details.
- **Sealing Rings:** These units are supplied with an **MR-2** snap action sealing ring as standard.



Utility requirements for this equipment may vary. Always consult the serving utility for their requirements before ordering or installing equipment.

Single Position Sockets

100–125 Amps | Ringless & Ring Type | 600 VAC

5

100-125 AMP
SINGLE
POSITION
SOCKETS

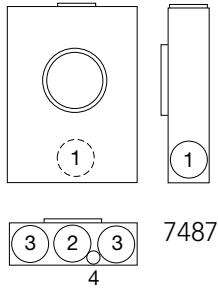

U7487-RL-TG

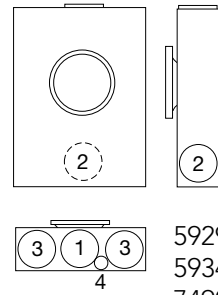

U5934-XL

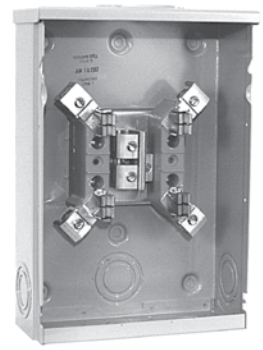

U7490-RL-TG

4 & 5 Terminals | Single Position | Ringless

Catalog Number	Amps	Terminals	Hub	Connectors CU/AL		Bypass	Dimensions			Knockouts			
				Line	Load		D"	W"	H"	1	2	3	4
U7487-RL-TG	125	4	H.O.	#6-2/0	#6-2/0	None	3 ⁵ / ₁₆	8	11 ¹ / ₂	2	1 ¹ / ₂	1 ¹ / ₄	1 ¹ / ₄
U5934-XL	100	4	C.P.	#6-2/0	#6-2/0	None	3 ⁵ / ₁₆	8	11 ¹ / ₂	2	1 ¹ / ₂	1 ¹ / ₄	1 ¹ / ₄
U7487-RL-TG-5T	125	5	H.O.	#12-1/0	#12-1/0	None	3 ⁵ / ₁₆	8	11 ¹ / ₂	2	1 ¹ / ₂	1 ¹ / ₄	1 ¹ / ₄

4 & 5 Terminals | Single Position | Ring Type

Catalog Number	Amps	Terminals	Hub	Connectors CU/AL		Bypass	Dimensions			Knockouts			
				Line	Load		D"	W"	H"	1	2	3	4
U7490-YL-TG	125	4	1 ¹ / ₄ "	#6-2/0	#6-2/0	None	3 ⁵ / ₁₆	8	11 ¹ / ₂	2	1 ¹ / ₂	1 ¹ / ₄	1 ¹ / ₄
U5929-XL	100	4	C.P.	#6-2/0	#6-2/0	None	3 ⁵ / ₁₆	8	11 ¹ / ₂	2	1 ¹ / ₂	1 ¹ / ₄	1 ¹ / ₄
U7490-YL-TG-5T	125	5	1 ¹ / ₄ "	#12-1/0	#12-1/0	None	3 ⁵ / ₁₆	8	11 ¹ / ₂	2	1 ¹ / ₂	1 ¹ / ₄	1 ¹ / ₄

Notes

- **Aluminum:** These units are also available in aluminum. Consult factory for more details.
- **Fifth Terminal:** For field mounted fifth terminal on the **U7487 & U7490** order catalog number **5T8K2** to fit into round opening at the 9 o'clock position. For factory-installed fifth terminal, add **-5T** to the catalog number.
- **Hubs:** For proper hub selection see the hub suffix chart on the accessory page.
- **Connectors:** Extruded aluminum connectors are tin plated.
- **Sealing Rings:** The **U7490** unit is supplied with an **MR-2** snap action sealing ring as standard.
- **Horn Bypass:** Horn bypass is available—contact factory for details.
- **Isolated Neutral:** **U5929** and **U5934** include isolated neutral option, ideal for solar applications.

Utility requirements for this equipment may vary. Always consult the serving utility for their requirements before ordering or installing equipment.



6

200 AMP
SINGLE
POSITION
SOCKETS

Single Position Sockets

200 Amps | 4 & 5 Terminals | Ringless | 600 VAC



U7021-RL-TG

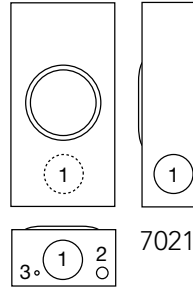

7021



U7040-RL-TG

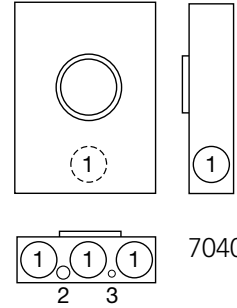

7040

200 Amps | 4 & 5 Terminals | Single Position | Ringless

Catalog Number	Terminals	Hub	Connectors CU/AL		Dimensions			Knockouts		
			Line	Load	D"	W"	H"	1	2	3
U7021-RL-TG	4	H.O.	#6-350	#6-350	4 $\frac{1}{8}$	8	15 $\frac{1}{2}$	2 $\frac{1}{2}$	1 $\frac{1}{4}$, $\frac{1}{2}$	1 $\frac{1}{4}$
U7021-DL-TG	4	2"	#6-350	#6-350	4 $\frac{1}{8}$	8	15 $\frac{1}{2}$	2 $\frac{1}{2}$	1 $\frac{1}{4}$, $\frac{1}{2}$	1 $\frac{1}{4}$
U7040-RL-TG	4	H.O.	#6-350	#6-350	4 $\frac{1}{8}$	11	14 $\frac{5}{8}$	2 $\frac{1}{2}$	1 $\frac{1}{4}$, $\frac{1}{2}$	1 $\frac{1}{4}$
U7021-RL-TG-5T	5	H.O.	#6-350	#6-350	4 $\frac{1}{8}$	8	15 $\frac{1}{2}$	2 $\frac{1}{2}$	1 $\frac{1}{4}$, $\frac{1}{2}$	1 $\frac{1}{4}$

Notes

- **Other Options:** These units are also available in aluminum and horn bypass. Consult factory for more details.
- **Fifth Terminal:** For field mounted fifth terminal, order catalog number **K5T** to fit into square opening at the 9 o'clock position. For factory-installed fifth terminal, add suffix **-5T** to catalog number.
- **Triplex Ground (-TG):** Factory installed.
- **Connectors:** Extruded aluminum connectors are tin plated.



Utility requirements for this equipment may vary. Always consult the serving utility for their requirements before ordering or installing equipment.

Single Position Sockets

200 Amps | 4 & 5 Terminals | Ring Type | 600 VAC

7
200 AMP
SINGLE
POSITION
SOCKETS

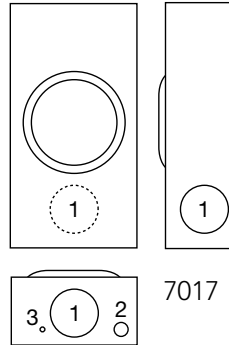

7017

U7017-RL-TG

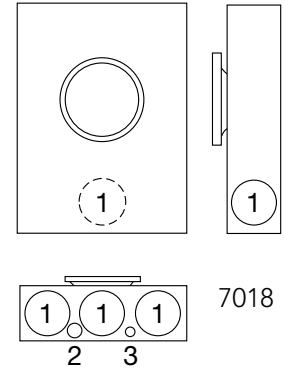

7018

U7018-XL-TG

200 Amps | 4 & 5 Terminals | Single Position | Ring Type

Catalog Number	Terminals	Hub	Connectors CU/AL		Dimensions			Knockouts		
			Line	Load	D"	W"	H"	1	2	3
U7017-RL-TG	4	H.O.	#6-350	#6-350	4 $\frac{1}{8}$	8	15 $\frac{1}{2}$	2 $\frac{1}{2}$	1 $\frac{1}{4}$, $\frac{1}{2}$	$\frac{1}{4}$
U7017-DL-TG	4	2"	#6-350	#6-350	4 $\frac{1}{8}$	8	15 $\frac{1}{2}$	2 $\frac{1}{2}$	1 $\frac{1}{4}$, $\frac{1}{2}$	$\frac{1}{4}$
U7018-XL-TG	4	C.P.	#6-350	#6-350	4 $\frac{3}{16}$	11 $\frac{1}{8}$	15 $\frac{1}{2}$	2 $\frac{1}{2}$	1 $\frac{1}{4}$, $\frac{1}{2}$	$\frac{1}{4}$
U7017-RL-TG-5T	5	H.O.	#6-350	#6-350	4 $\frac{1}{8}$	8	15 $\frac{1}{2}$	2 $\frac{1}{2}$	1 $\frac{1}{4}$, $\frac{1}{2}$	$\frac{1}{4}$

Notes

- **Other Options:** These units are also available in aluminum and horn bypass. Consult factory for more details.
- **Fifth Terminal:** For field mounted fifth terminal, order catalog number **K5T** to fit into square opening at the 9 o'clock position.
- **Triplex Ground (-TG):** Factory installed.
- **Connectors:** Extruded aluminum connectors are tin plated.
- **Sealing Rings:** Units on this page are supplied with an **MR-2** snap action sealing ring as standard.

Utility requirements for this equipment may vary. Always consult the serving utility for their requirements before ordering or installing equipment.



8

100-200 AMP
SINGLE
POSITION
SOCKETS

Single Position Sockets

100-200 Amps | 7 Terminals | Ringless | 600 VAC

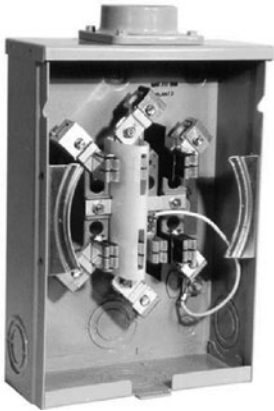

S1910-YL

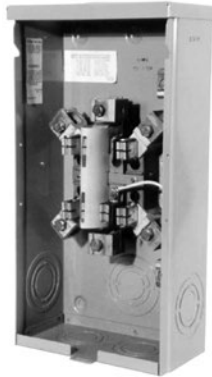
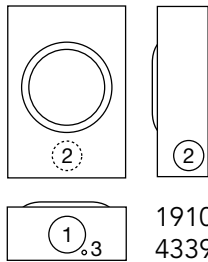

S2417-RL

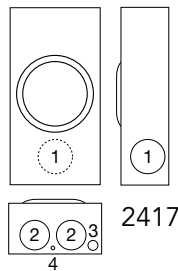

S4339-RL

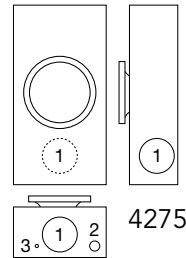

U3328-RXL

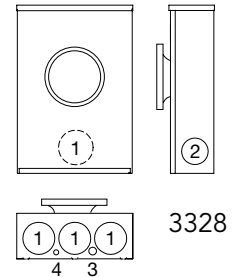

7 Terminals | Single Position | Ringless

Catalog Number	Amps	Hub	Connectors CU/AL		Bypass	Dimensions			Knockouts		
			Line	Load		D"	W"	H"	1	2	3
S1910-YL	100	1 1/4"	#6-2/0	#6-2/0	None	3 5/16	8	11 1/2	2	1 1/2	1/4
S2417-RL	200	H.O.	#6-350	#6-350	None	3 5/16	8	11 1/2	2	1 1/2	1/4
S2417-DL	200	2"	#6-350	#6-350	None	3 5/16	8	11 1/2	2	1 1/2	1/4

7 Terminals | Single Position | Ring Type

Catalog Number	Amps	Hub	Connectors CU/AL		Bypass	Dimensions			Knockouts			
			Line	Load		D"	W"	H"	1	2	3	4
S4339-RL	100	H.O.	#6-2/0	#6-2/0	None	3 5/16	8	11 1/2	2	1 1/2	1/4	—
S4275-DL	200	2"	#6-350	#6-350	None	4 1/8	8	15 1/2	2 1/2	1/4, 1/2	1/4	—
U3328-RXL	200	C.P.	#6-350	#6-350	None	4 7/8	13	19	3	2 1/2	1/4, 1/2	1/4

Notes

- **U3328-RXL:** For isolated neutral, order **K1047**.
- **Sealing Rings:** Ring type units are supplied with an **MR-2** snap action sealing ring as standard.
- **Aluminum Option:** Products on this page are available in aluminum shell construction. Contact Milbank for details.



Utility requirements for this equipment may vary. Always consult the serving utility for their requirements before ordering or installing equipment.

Single Position Sockets

200 Amps | 7 Terminals | Ringless | 600 VAC

9
200 AMP
SINGLE
POSITION
SOCKETS

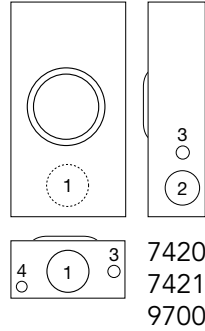
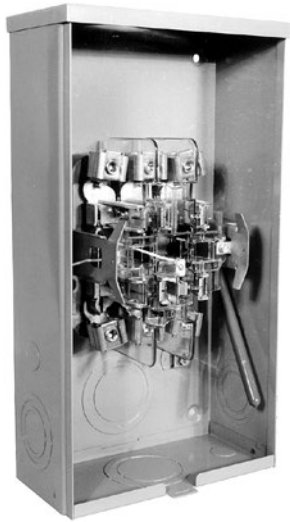

U7421-RL

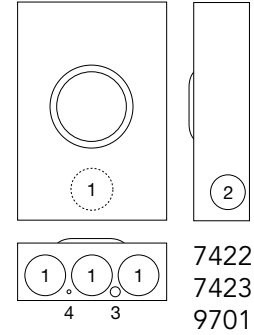

U9700-RRL

200 Amps | 7 Terminals | Single Position | Ringless

Catalog Number	Hub	Connectors CU/AL		Bypass	Dimensions			Knockouts			
		Line	Load		D"	W"	H"	1	2	3	4
U7420-RL	H.O.	#6-350	#6-350	None ¹	4 ⁷ / ₈	10	18 ¹ / ₂	3	2 ¹ / ₂	³ / ₄	¹ / ₄ , ¹ / ₂
U7421-RL	H.O.	#6-350	#6-350	Lever ²	4 ⁷ / ₈	10	18 ¹ / ₂	3	2 ¹ / ₂	³ / ₄	¹ / ₄ , ¹ / ₂
U7422-RXL†	C.P.	#6-350	#6-350	None ¹	4 ⁷ / ₈	13	19	3	2 ¹ / ₂	¹ / ₄ , ¹ / ₂	¹ / ₄
U7423-RXL†	C.P.	#6-350	#6-350	Lever ²	4 ⁷ / ₈	13	19	3	2 ¹ / ₂	¹ / ₄ , ¹ / ₂	¹ / ₄
U9700-RRL†	H.O.	#6-350	#6-350	Lever ³	4 ⁷ / ₈	10	18 ¹ / ₂	3	2 ¹ / ₂	³ / ₄	¹ / ₄ , ¹ / ₂
U9701-RXL†	C.P.	#6-350	#6-350	Lever ³	4 ⁷ / ₈	13	19	3	2 ¹ / ₂	¹ / ₄ , ¹ / ₂	¹ / ₄

Notes

†These units have a large hub opening with reducer plate to small hub opening.

- **Bypass:** ¹ Medium duty, no bypass. ² Medium duty lever bypass, non jaw-clamping. ³ Lever supplies clamping action on meter spades and also operates bypass device.
- **Aluminum Option:** Products on this page are available in aluminum.
- **4 & 5 Terminal Option:** These units are also available in 4 & 5 terminals.

Utility requirements for this equipment may vary. Always consult the serving utility for their requirements before ordering or installing equipment.



Stainless Steel Products

Build to endure extreme environments



USS4701-O

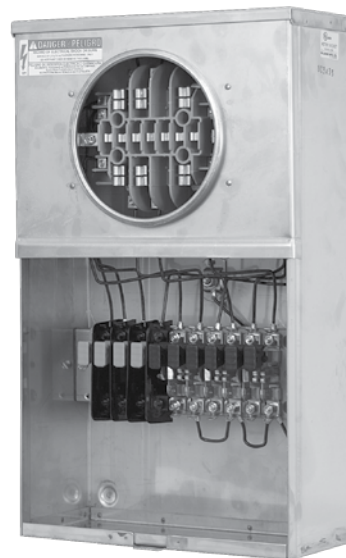

UCSS3433-O

200 Amps | Single Position | Stainless Steel | Ringless

Catalog Number	Terminals	Hub	Connectors CU/AL		Bypass	Dimensions		
			Line	Load		D"	W"	H"
USS3914-O	4	Blank	#6-350	#6-350	None	4 $\frac{7}{8}$	13	19
USS4801-O	4	Blank	#6-350	#6-350	Lever	4 $\frac{7}{8}$	13	19
USS4801-O-5T9	5	Blank	#6-350	#6-350	Lever	4 $\frac{7}{8}$	13	19
USS4701-O	7	Blank	#6-350	#6-350	Lever	4 $\frac{7}{8}$	13	19

Transformer Rated | With Provisions for Test Switch | Stainless Steel | Ring Type

Catalog Number	Terminals	Hub	Connectors CU	Bypass	Dimensions		
					D"	W"	H"
UCSS3436-O	6	Blank	#14 - 2	Test Switch*	5 $\frac{1}{2}$	12	20
UCSS3438-O	8	Blank	#14 - 2	Test Switch*	5 $\frac{1}{2}$	12	20
UCSS3433-O	13	Blank	#14 - 2	Test Switch*	5 $\frac{1}{2}$	12	20

Notes

- **Conduit Opening Applications:** All conduit openings have dimples provided to center location. Top conduit opening must have water-tight hub installed.
- ***Test Switch:** Test switch provisions. Test switch and wiring not included.
- **Contact Milbank for other units available in stainless steel.**



Utility requirements for this equipment may vary. Always consult the serving utility for their requirements before ordering or installing equipment.

Single Position Lever Bypass

320 Amp | 4 & 5 Terminal | Ringless | 600 VAC

1 1
320 AMP
SINGLE
POSITION
LEVER BYPASS



U4363-R

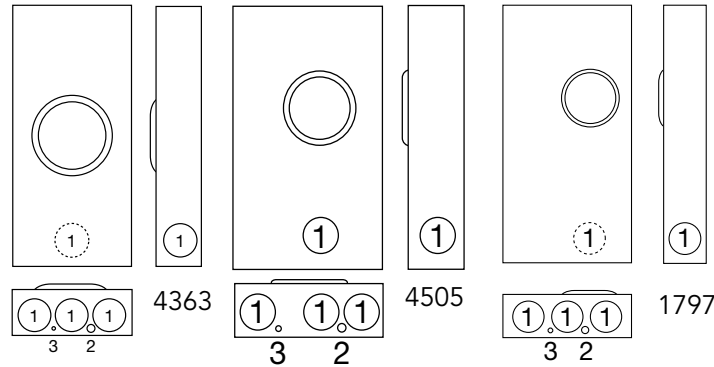

U1797-O-K2L-K3L

320 Amps | 4 & 5 Terminals | Single Position | Ringless

Catalog Number	Terminals	Hub	Connectors CU/AL		Bypass	Dimensions			Knockouts		
			Line	Load		D"	W"	H"	1	2	3
U4363-R*	4	H.O.	3/8" x 16 Stud	3/8" x 16 Stud	Lever	4 7/8	13	28 1/4	3	1/4, 1/2	1/4
U1797-O-K2L-K3L	4	Blank	(1) #4-600 or (2) 1/0-250	Twin #6-350	Lever	4 7/8	13	28 1/4	3	1/4, 1/2	1/4
U4505-X	5	C.P.	3/8" x 16 Stud	3/8" x 16 Stud	Lever	4 7/8	15	28 1/4	3	1/4, 1/2	1/4

Notes

- ***UL Listing:** This product is UL listed for parallel 250 conductors only. Use **K1450** with (2) 250 conductors.
- **Hubs:** For proper hub selection, refer to the hub suffix chart on the accessories page.
- **Connectors:** **U1797** includes lugs. **U4363** and **U4505** are supplied with 3/8"-16 hex head nuts with Belleville washers. For connector lug kits, order as extra from chart on accessories page. Separate lug kits are required for line and load.
- **Bypass:** Lever supplies clamping action on meter spades and also operates bypass device.
- **Fifth Terminal:** For field-installed fifth terminal for **U4363** and **U1797**, order **K3865**.

Utility requirements for this equipment may vary. Always consult the serving utility for their requirements before ordering or installing equipment.



100-200 Amps | 4 Terminals | Ringless | 120/240 VAC



U5842-RL-100

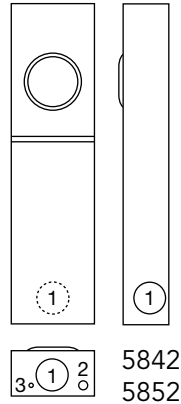

5842
5852

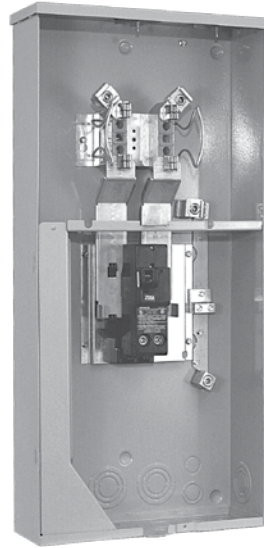

U5844-PXL-200

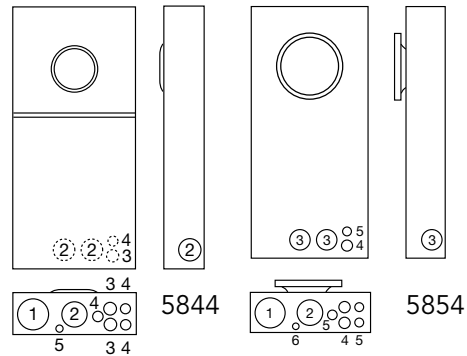

5844

5854

4 Terminals | Meter Mains | Ringless

Catalog Number	Service	Hub	Connectors CU/AL		Bypass	Dimensions			Knockouts				
			Line	Load		D"	W"	H"	1	2	3	4	5
U5842-RL	OH	H.O.	#6-350	—†	None	4½	8	30	2½	¼, ½	¼	—	—
U5842-RL-100	OH	H.O.	#6-350	CB - 100A	None	4½	8	30	2½	¼, ½	¼	—	—
U5842-PXL-200	OH	C.P.	#6-350	CB - 200A	None	4½	8	30	2½	¼, ½	¼	—	—
U5844-PXL-200	OH/UG	C.P.	#6-350	CB - 200A	None	4½	14	30	3	2½	1	½, ¾	¼, ½

4 Terminals | Meter Mains | Ring Type

Catalog Number	Service	Hub	Connectors CU/AL		Bypass	Dimensions			Knockouts					
			Line	Load		D"	W"	H"	1	2	3	4	5	6
U5852-RL	OH	H.O.	#6-350	—†	None	4½	8	30	2½	¼, ½	¼	—	—	—
U5852-RL-100	OH	H.O.	#6-350	CB - 100A	None	4½	8	30	2½	¼, ½	¼	—	—	—
U5852-RL-200	OH	H.O.	#6-350	CB - 200A	None	4½	14	30	2½	¼, ½	¼	—	—	—
U5854-RL-200	OH/UG	H.O.	#6-350	CB - 200A	None	4½	14¼	30	3	2½	2	1	½, ¾	¼, ½

Notes

† Breaker not included

- **AIC Rating:** All models are rated 22K AIC when using Siemens **QPH** (100A) or **QNH** (200A) breakers.
- **Hub:** -PXL versions supplied with one (1) closing plate packed inside. Order other hubs separately.
- **Fifth Terminal:** For field installable fifth terminal kit, order **K5T**.



Utility requirements for this equipment may vary. Always consult the serving utility for their requirements before ordering or installing equipment.

Meter Main with Load Center

100–200 Amps | 4 Terminals | 120/240 VAC

13
100–200 AMP
METER MAIN
W/ LOAD CENTER



U5168-XTL-200

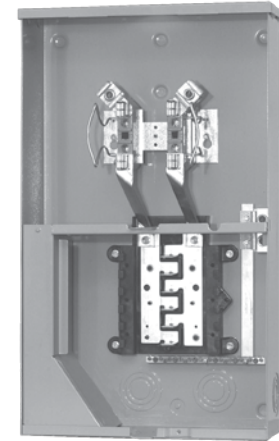
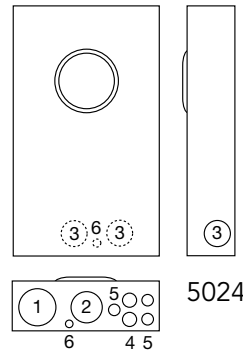
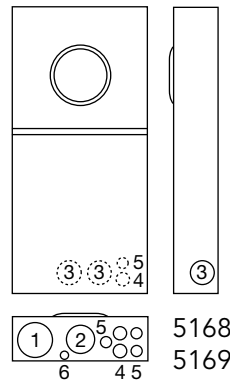

UAP5024-XL

4 Terminals | Meter Mains | Ringless

Catalog Number	Amps	Service	Circuits	Hub	Connectors CU/AL - Line	Dimensions			Knockouts					
						D"	W"	H"	1	2	3	4	5	6
U5168-XTL-100	100	OH/UG	10	C.P.	#6-350	4½	14⅞	30	3	2½	2	1	½,¾	¼,½
U5168-XTL-200	200	OH/UG	8	C.P.	#6-350	4½	14⅞	30	3	2½	2	1	½,¾	¼,½
UAP5024-XL	200	OH/UG	12	C.P.	#6-350	4½	14⅞	24	3	2½	2	1	½,¾	¼,½

4 Terminals | Meter Mains | Ring Type

Catalog Number	Amps	Service	Circuits	Hub	Connectors CU/AL - Line	Dimensions			Knockouts					
						D"	W"	H"	1	2	3	4	5	6
U5169-XTL-100	100	OH/UG	10	C.P.	#6-350	4½	14⅞	30	3	2½	2	1	½,¾	¼,½
U5169-XTL-200	200	OH/UG	8	C.P.	#6-350	4½	14⅞	30	3	2½	2	1	½,¾	¼,½

Notes

- **Hubs:** For proper hub selection, refer to the hub suffix chart on the accessories page.
- **Fifth Terminal:** For field installed fifth terminal, order **K5T**.
- **Interlock Kit:** For generator auxiliary circuit breaker interlock, order **K5815** for large **QN** with small frame **Q**; order **K5820** for large frame **QN** with large frame **QN**; order **K5830** for small frame **Q** to small frame **Q**. See accessories page for details.
- **UAP5024-XL:** This unit is painted aluminum. Breaker section has provision for six double pole "plug-in" type circuit breakers. All circuit breakers will be parallel. To comply with NEC wire bending space requirements, the maximum breaker amperage is 200 amps restricted to 3/0 copper conductor.

Plug-In Breaker Compatibility Chart

Amps	Cutler Hammer	Siemens	General Electric	Square D
150-200	BR, BRH, HQP, QPHW, QPGF, QPHGF	QP, QPH	THQL, THHQL, THQL-GF, THHQL-GF	Homeline
≤ 125	QP / BR	QP, QPH	THQ	Homeline

Utility requirements for this equipment may vary. Always consult the serving utility for their requirements before ordering or installing equipment.



14

320 AMP
LEVER BYPASS
METER MAIN

Lever Bypass Meter Mains

320 Amps | 4 Terminals | Ringless | 120/240 VAC



U5890-X-2/200

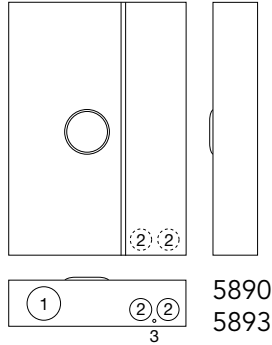

U5894-X-2/200

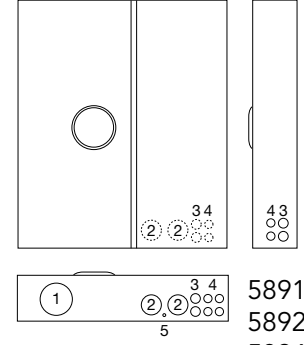

320 Amps | 4 Terminals | Meter Mains | Lever Bypass | Ringless

Catalog Number	Service	Hub	Side Wireway	Connectors CU/AL - Line	Branch Circuits	Dimensions			Knockouts				
						D"	W"	H"	1	2	3	4	5
U5890-X-2/200	OH/UG	C.P.	No	3/8" x 16 Studs	N/A	6	24½	35	4	2½	¼	—	—
U5891-X-2/200	OH/UG	C.P.	No	3/8" x 16 Studs	12	6	29½	35	4	2½	1	½, ¾	¼
U5892-X-2/200	OH/UG	C.P.	No	3/8" x 16 Studs	24	6	29½	35	4	2½	1	½, ¾	¼
U5893-X-2/200	OH/UG	C.P.	Yes	3/8" x 16 Studs	N/A	6	24½	35	4	2½	¼	—	—
U5894-X-2/200	OH/UG	C.P.	Yes	3/8" x 16 Studs	12	6	29½	35	4	2½	1	½, ¾	¼
U5895-X-2/200	OH/UG	C.P.	Yes	3/8" x 16 Studs	24	6	29½	35	4	2½	1	½, ¾	¼

Notes

- **Hubs:** For proper hub selection refer to the hub suffix chart on the accessory page.
- **Breakers:** All units come with two 200A main breakers.
- **Side Bussed Units:** U5893, U5894 and U5895.
- **-MLK:** Main Lug feed-through kit K3701 factory installed on U5891 and U5894.
- **Fifth Terminal:** For field mounted fifth terminal order catalog number K3865.
- **Connectors:** Socket is supplied with 3/8" - 16 hex head nuts with Belleville washers. For connector lug kits, order as extra from chart on accessories page. Separate lug kits are required for line side only.

Plug-In Breaker Compatibility Chart

Amps	Cutler Hammer	Siemens	General Electric	Square D
150-200	BR, BRH, HQP, QPHW, QPGF, QPHGF	QP, QPH	THQL, THHQL, THQL-GF, THHQL-GF	Homeline
≤ 125	QP / BR	QP, QPH	THQ	Homeline



Utility requirements for this equipment may vary. Always consult the serving utility for their requirements before ordering or installing equipment.

Cold Sequence Meter Mains

4, 5 & 7 Terminals | Ringless

15
COLD
SEQUENCE
METER MAINS



U5767-X-200-CB



U5787-O-200-CB

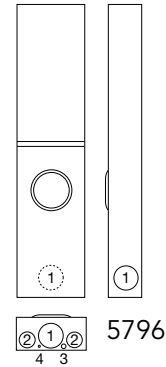

5796

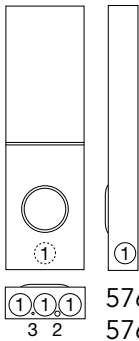

5764 5767
5765

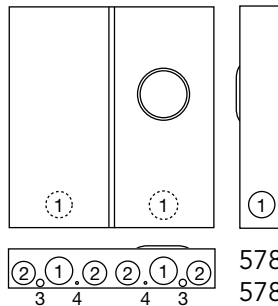

5784
5787

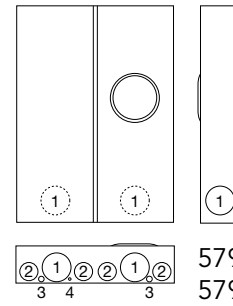

5797
5799

200 Amp Circuit Breaker Disconnect Ahead Of Meter Socket

Catalog Number	Terminals	Service	Hub	Connectors CU/AL		Bypass	Dimensions			Knockouts			
				Line & Load			D"	W"	H"	1	2	3	4
U5764-X-200-CB	4	OH/UG	C.P.	#6-350		Lever	4 ^{27/32}	13	43	4	2½	¼	—
U5765-X-200-CB	5	OH/UG	C.P.	#6-350		Lever	4 ^{27/32}	13	43	4	2½	1	½, ¾
U5784-O-200-CB	5	UG	Blank	#6-350		Lever	4 ^{27/32}	26	28	4	2½	¼	—
U5767-X-200-CB	7	OH/UG	C.P.	#6-350		Lever	4 ^{27/32}	13	43	4	2½	1	½, ¾
U5787-O-200-CB	7	UG	Blank	#6-350		Lever	6	26	28	4	2½	1	½, ¾

400 Amp (320 Amp Continuous) Circuit Breaker Disconnect Ahead Of Meter Socket

Catalog Number	Terminals	Service	Hub	Connectors CU/AL		Bypass	Dimensions			Knockouts			
				Line	Load		D"	W"	H"	1	2	3	4
U5797-O-400-CB	5	UG	Blank	3/0-500	3/0-500	Lever	6	26	36	4	2½	1	½, ¾
U5796-X-400-CB	7	OH/UG	C.P.	3/0-500	3/0-500	Lever	6	13	56	4	2½	¼	—
U5799-O-400-CB	7	UG	Blank	3/0-500	3/0-500	Lever	6	26	36	4	2½	1	½, ¾

Notes

- **Hubs:** For proper hub selection, refer to the hub suffix chart on the accessories page.

Utility requirements for this equipment may vary. Always consult the serving utility for their requirements before ordering or installing equipment.



Multi-Position Sockets

100 Amps | 4 Terminals | 300 VAC

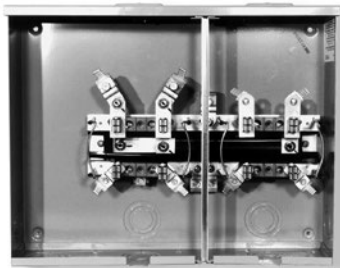

U8212-RL

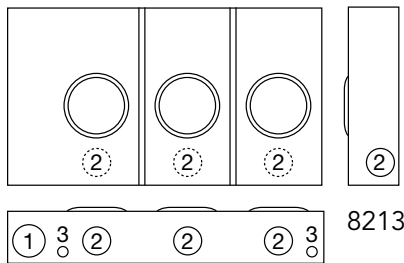
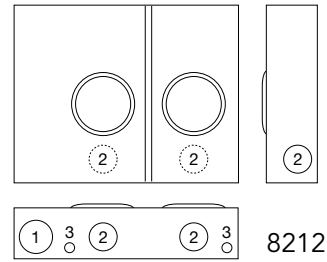

8213

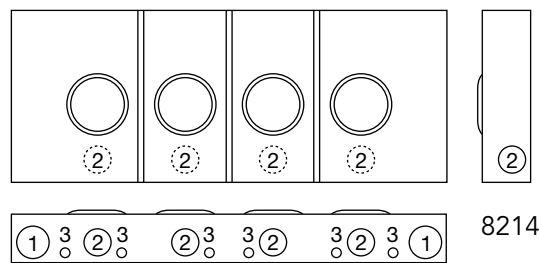

8214

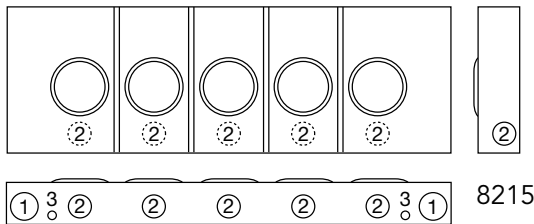

8215

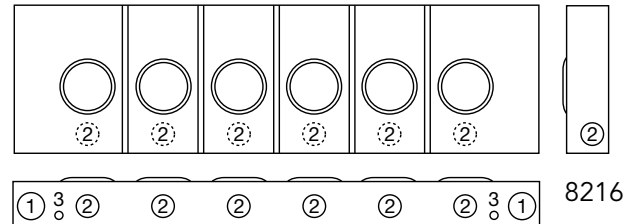

8216

100 Amps per Position | 4 Terminal | Multi-Position | Ringless

Catalog Number	Positions	Hub	Connectors CU/AL		Dimensions			Knockouts		
			Line	Load	D"	W"	H"	1	2	3
U8212-RL	2	H.O.	#6-350	#6-2/0	4½	20⅝	16	2½	2	¼, ½
U8213-RL	3	H.O.	#6-350	#6-2/0	4½	28½	16	2½	2	¼, ½
U8214-RL	4	H.O.	#6-350	#6-2/0	4½	40⅞	16	2½	2	¼, ½
U8215-RL	5	H.O.	#6-350	#6-2/0	4½	48⅞	16	2½	2	¼, ½
U8216-XL	6	C.P.	#6-350	#6-2/0	4½	57⅞	16	2½	2	¼, ½

Notes

- **Hub:** For proper hub selection refer to the hub suffix chart on the accessory page. A hub opening is supplied at each end and the extra opening is closed with a closing plate as standard.
- **Fifth Terminal Kit:** For field mounted fifth terminal, order **5T8K2** (6 o'clock position).
- **Connectors:** Extruded aluminum connectors are tin plated.
- **200 Amp Units:** 200 amp per position units available—consult factory.



Utility requirements for this equipment may vary. Always consult the serving utility for their requirements before ordering or installing equipment.

Multi-Position Meter Mains

125 & 200 Amp | 4 Terminals | Ringless | 120/240 VAC

17
125-200 AMP
MULTI-POSITION
METER MAINS



U5882-X



U5884-X

125 Amps per Position | 4 Terminal | Multi-Position Meter Mains | Ringless

Catalog Number	Amps	Positions	Service	Hub	Connectors CU/AL	Dimensions			Weight (lbs.)
					Line	D"	W"	H"	
U5902-X	125	2	OH/UG	C.P.	3/8" x 16 Stud	5 1/8	26 1/2	30	58
U5903-X	125	3	OH/UG	C.P.	3/8" x 16 Stud	5 1/8	34 3/8	30	88
U5904-X	125	4	OH/UG	C.P.	3/8" x 16 Stud	5 1/8	42 4/8	30	107
U5905-X	125	5	OH/UG	C.P.	3/8" x 16 Stud	5 1/8	51 1/20	30	128
U5906-X	125	6	OH/UG	C.P.	3/8" x 16 Stud	5 1/8	59 3/10	30	146

200 Amp / Position | 4 Terminal | Multi Position Meter Mains | Ringless

Catalog Number	Amps	Positions	Service	Hub	Connectors CU/AL	Dimensions			Weight (lbs.)
					Line	D"	W"	H"	
U5882-X	200	2	OH/UG	C.P.	3/8" x 16 Stud	5 1/8	26 1/2	30	58
U5883-X	200	3	OH/UG	C.P.	3/8" x 16 Stud	5 1/8	34 3/8	30	88
U5884-X	200	4	OH/UG	C.P.	3/8" x 16 Stud	5 1/8	42 4/8	30	107
U5885-X	200	5	OH/UG	C.P.	3/8" x 16 Stud	5 1/8	51 1/20	30	128
U5886-X	200	6	OH/UG	C.P.	3/8" x 16 Stud	5 1/8	59 3/10	30	146

Notes

- **Optional:** Factory installed breakers are available—consult factory.
- **AIC Rating:** All models are rated **22K AIC** with Siemens breakers.
- **Hub:** Units supplied with one (1) closing plate. Order hubs separately, see accessory page.
- **Fifth Terminal:** For field installed fifth terminal, order **K5T**.
- **Connectors:** Socket is supplied with 3/8" - 16 hex head nuts with Belleville washers. For connector lug kits, order as extra from chart on accessories page. Separate lug kits are required for line side only.

Utility requirements for this equipment may vary. Always consult the serving utility for their requirements before ordering or installing equipment.



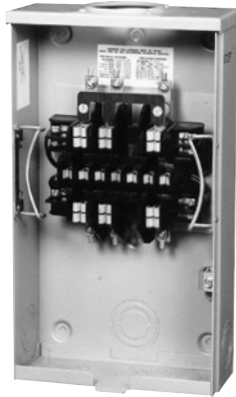

UC7237-RL

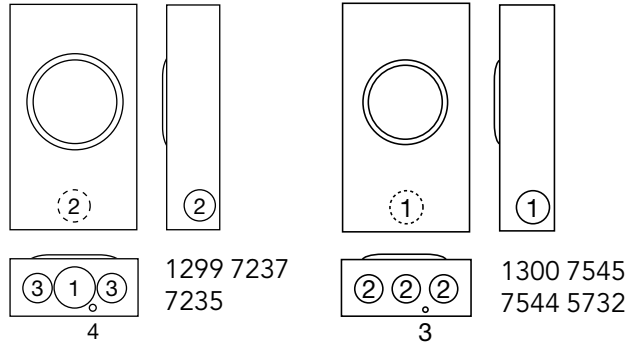

20 Amps | Ringless | Plunger Bypass | Overhead/Underground Service

Catalog Number	Terminals	Hub	Meter Form	Connectors CU	Bypass	Dimensions			Knockouts			
						D"	W"	H"	1	2	3	4
UC1299-RL	6	H.O.	4S	#14 - #10	Plunger	3 ⁵ / ₁₆	8	14	2	1 ¹ / ₂	1 ¹ / ₄	1 ¹ / ₄
UC7235-RL	8	H.O.	5S	#14 - #10	Plunger	3 ⁵ / ₁₆	8	14	2	1 ¹ / ₂	1 ¹ / ₄	1 ¹ / ₄
UC7237-RL	13	H.O.	6, 8, 9S & (ALT) 10S	#14 - #10	Plunger	3 ⁵ / ₁₆	8	14	2	1 ¹ / ₂	1 ¹ / ₄	1 ¹ / ₄

20 Amps | Ring Type | Overhead/Underground Service

Catalog Number	Terminals	Hub	Meter Form	Connectors CU	Bypass	Dimensions			Knockouts		
						D"	W"	H"	1	2	3
UC1300-XL	6	H.O.	4S	#14 - #4 Max	Plunger	3 ⁵ / ₁₆	8	14	1 ¹ / ₂	1 ¹ / ₄	1 ¹ / ₄
UC7544-XL	8	H.O.	3S	#14 - #4 Max	Plunger	3 ⁵ / ₁₆	8	14	1 ¹ / ₂	1 ¹ / ₄	1 ¹ / ₄
UC7545-XL	13	H.O.	6, 8, 9S & (ALT) 10S	#14 - #4 Max	Plunger	3 ⁵ / ₁₆	8	14	1 ¹ / ₂	1 ¹ / ₄	1 ¹ / ₄
UC5732-XL	15	H.O.	Special	#14 - #4 Max	None	3 ⁵ / ₁₆	8	14	1 ¹ / ₂	1 ¹ / ₄	1 ¹ / ₄

Notes

- **Hubs:** For proper hub selection, see the hub suffix chart on the accessories page.
- **Bypass:** Plunger type bypass automatically closes when meter is removed.
- **Connectors:** Units are supplied with mechanical type connectors (#4 max).



Utility requirements for this equipment may vary. Always consult the serving utility for their requirements before ordering or installing equipment.

Transformer Rated

20 Amps | 6-13 Terminals | Test Switch Provision

19
20 AMP
TRANSFORMER
RATED

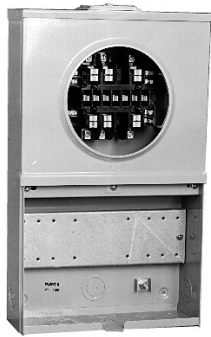

UC7449-XL



UC7478-YL

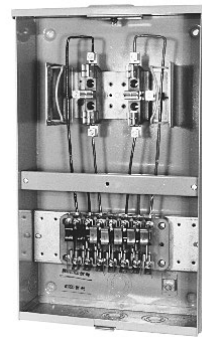

UC7532-RL
(shown prewired with
Milbank test switch)

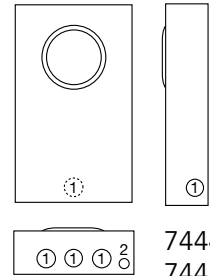

- 7444
- 7445
- 7446
- 7448
- 7449
- 7478
- 7532

1 Piece Cover | Ringless | Overhead/Underground | with test switch provision*

Catalog Number	Terminals	Hub	Meter Form	Connectors CU	Bypass	Dimensions			Knockouts	
						D"	W"	H"	1	2
UC7478-RL	6	H.O.	4S	#14 - #4 Max	None	4 $\frac{1}{8}$	12	20	1 $\frac{1}{4}$	1 $\frac{1}{4}$, 1 $\frac{1}{2}$
UC7444-RL	8	H.O.	5S	#14 - #4 Max	None	4 $\frac{1}{8}$	12	20	1 $\frac{1}{4}$	1 $\frac{1}{4}$, 1 $\frac{1}{2}$
UC7445-RL	13	H.O.	6, 8, 9 & (ALT) 10S	#14 - #4 Max	None	4 $\frac{1}{8}$	12	20	1 $\frac{1}{4}$	1 $\frac{1}{4}$, 1 $\frac{1}{2}$
UC5087-RL	13	H.O.	6, 8, 9 & (ALT) 10S	#14 - #4 Max	Plunger	4 $\frac{1}{8}$	12	20	1 $\frac{1}{4}$	1 $\frac{1}{4}$, 1 $\frac{1}{2}$

2 Piece Cover | Ringless | Overhead/Underground | with test switch provision*

Catalog Number	Terminals	Hub	Meter Form	Connectors CU	Bypass	Dimensions			Knockouts	
						D"	W"	H"	1	2
UC7532-RL	6	H.O.	4S	#14 - #4 Max	None	4 $\frac{1}{8}$	12	20	1 $\frac{1}{4}$	1 $\frac{1}{4}$, 1 $\frac{1}{2}$
UC7448-RL	8	H.O.	5S	#14 - #4 Max	None	4 $\frac{1}{8}$	12	20	1 $\frac{1}{4}$	1 $\frac{1}{4}$, 1 $\frac{1}{2}$
UC7449-RL	13	H.O.	6, 8, 9 & (ALT) 10S	#14 - #4 Max	None	4 $\frac{1}{8}$	12	20	1 $\frac{1}{4}$	1 $\frac{1}{4}$, 1 $\frac{1}{2}$

Notes

- **Hubs:** For proper hub selection see the hub suffix chart on the accessory page.
- **Prewiring:** If standard factory pre-wiring is required, refer to wiring diagrams in the general engineering section of this catalog. Determine appropriate diagram and send copy with order. If custom factory prewiring is required, specify on order. Be sure to include meter socket catalog number, test switch model and number, and meter form number. Please be sure to provide a copy of your wiring diagram. Catalog number will change to match wiring.
- **Connectors:** Units are supplied with mechanical type connectors (#4 max).
- ***Test Switch Cover:** Units on this page are not designed for use with test switch covers. Units are available in 5 $\frac{1}{2}$ " deep shell for test switch cover—contact factory for details. It is also possible to remove the test switch bridge and mount a test switch to the back of the enclosure.
- **Ring Type Option:** 2-piece cover units are available in ring type—contact factory for details.

Utility requirements for this equipment may vary. Always consult the serving utility for their requirements before ordering or installing equipment.



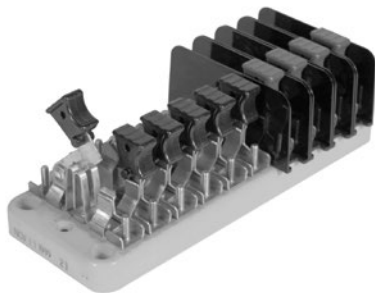

Switch Blades

Two dimples coined into one side of the switch blade ensure positive contact in corrosive, sooty environments—even after years of inactivity.

Test Switch Covers

Standard test switch covers are made from impact resistant clear thermal plastic which has excellent tracking and moisture resistant properties. If covers are required, add suffix **-WC** (with cover) to the catalog number or order separately catalog number **K3388**. Black flush mount covers are also available. Order catalog number **K3388-BLK-FL**. 10 pole base only.

Standard Cover



Test Switch Base

The base is molded from a high strength, fiberglass reinforced, thermoset polyester. This material is track resistant, flame retardant and has low water absorption qualities. Bases are available in 7 pole and 10 pole sizes.

Switch Jaws

The switch blade jaw clips are constructed from spring grade copper alloy. The material and design ensure excellent contact which prevents overheating.



Polarity Barrier

For maximum protection potential circuits are supplied with permanently mounted barriers made from high tensile strength polycarbonate.

Current Carrying Parts

Highly conductive copper and copper alloy materials are used on all current carrying parts. This ensures conductivity and deters corrosion. Spring grades are used where appropriate. Plating is available if required. Contact general offices to special order.

Flush Mount Cover (Black)



Socket shells must be 5/8" deep
-OR-
must not have test switch bridge
mounted on back
in order to support a cover.

Factory Installed: For cover installed add the suffix **-WC** or **-WCFL** to the catalog number of desired test switch.

Field Installed: For field installed cover order kit number **K3388** or **K3388-BLK-FL**.

The Milbank test switch is designed to meet the critical requirements of the electric utility industry. Not only do they meet EEI, ANSI C12.9, and UL standards but they combine several special features giving the Milbank test switch increased safety, durability and reliability. One such feature is our unique switch blade contact points which cut through residue that builds up after years of service. Another distinction is our polarity barrier which is designed to be flexible as well as offer exceptional insulating qualities. Our test switches are constructed from the latest materials available using modern fabricating and assembly methods.





Utility requirements for this equipment may vary. Always consult the serving utility for their requirements before ordering or installing equipment.

Test Switches

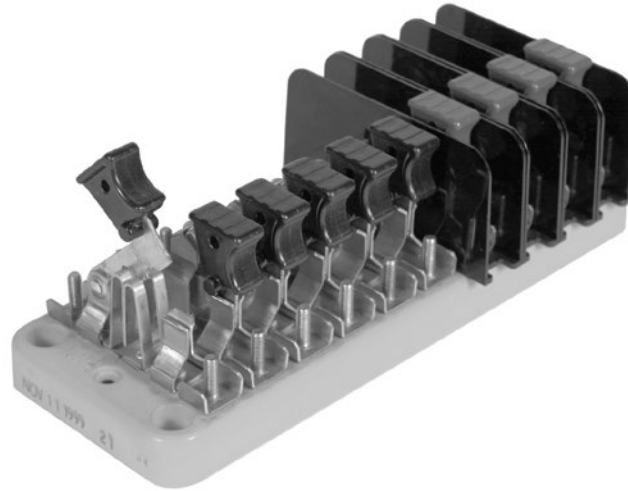
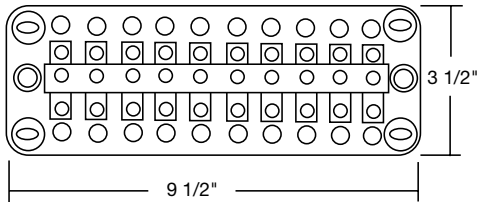
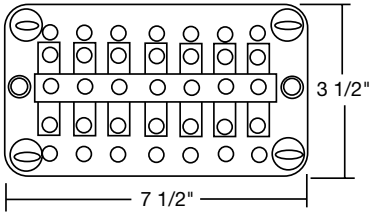
4, 7 & 10 Pole





















Key	
P	Potential Switch
C+	Line side current switch with short circuit assembly
C	Load side current switch with test jack assembly
N	Neutral bar (no switch)
Pn	Neutral Potential Switch
X	Unused Position on base
	Insulating barrier, isolates both sides of switch

Catalog Number	4-Pole						
TS04-0101	X	P		X	C+	C	X
TS04-0104	X	C+	C	X		Pn	X

Catalog Number	7-Pole						
TS07-0105		P		C+	C	C+	C

Custom Pole Arrangements:
The key may be used to diagram your own pole arrangement. Be sure to specify base size and whether all C+ line side, current switch / shunt circuit assemblies are to be bussed together. The catalog numbers shown above are connected in line-load pairs; therefore, if bussed is required, different catalog numbers will apply.

Catalog Number	7-Pole on a 10-Pole Base									
TS07-0049		X		X		X	C+	C	C	C+
TS07-0106	X		C+	C		C+	C		X	X

Catalog Number	10-Pole									
TS10-0109	P		P		C+	C	C+	C	C+	C
TS10-0110		C+	C		C+	C		C+	C	
TS10-0111	P		P		C	C+	C	C+	C	C+
TS10-0112	C+	C	C+	C	C+	C		P		Pn
TS10-0016				Pn	C	C+	C	C+	C	C+

Utility requirements for this equipment may vary. Always consult the serving utility for their requirements before ordering or installing equipment.





Customer Name: _____

Address: _____

Phone / Fax #: _____

Handle Color Key							
BK	Black	P	Purple	Y	Yellow	GN	Green
R	Red	BL	Blue	W	White	BKS	Black Stripe
BR	Brown	GR	Grey	O	Orange	WS	White Stripe

TEST SWITCH BASE

The base is molded from a high strength, fiberglass reinforced, thermoset polyester. This material is track-resistant, flame-retardant and has low water absorption qualities. Bases are available in two standard sizes following NEMA mounting classifications.

Pole Position Chart

1	2	3	4	5	6	7	8	9	10

Special Features

Feature	1	2	3	4	5	6	7	8	9	10
45° Angle Stops										
Ganged Handles (C)										
Bussing										
Colored Handles										

Engineering Information: _____

Key	
P	Potential Switch
C+	Line side current switch with short circuit assembly
C	Load side current switch with test jack assembly
N	Neutral bar (no switch)
Pn	Neutral Potential Switch
X	Unused Position on base
L	Insulating barrier - one side
□	Insulating barrier - two sides

Custom Pole Arrangements: The key may be used to diagram your own pole arrangement. Be sure to specify base size and whether all C+ line side, current switch / shunt circuit assemblies are to be bussed together. The catalog numbers shown above are connected in line-load pairs; therefore, if bussed is required, different catalog numbers will apply.

Number of Poles

- 4
- 7
- 10
- Other _____

Test Switch Cover (only available for 10-pole bases)

- Yes | Clear ____ Black ____
- No

Base Size

- 7-Pole
- 10-Pole



Utility requirements for this equipment may vary. Always consult the serving utility for their requirements before ordering or installing equipment.

Current Transformer Cabinet

Panel Enclosure | Type 3R



Application

- For use as a current transformer cabinet or panel enclosure.
- For outdoor use to provide protection against rain, sleet and snow, or indoor use to protect against dripping water.

Construction

- Enclosure and cover manufactured from 16 or 14 gauge G90U galvanized steel.
- The doors are overlapping with no center post.
- Continuous door hinge with stainless steel hinge pins.
- Three point pad-lockable handle.
- Panel mounting studs provided for optional back panels.
- Drip shield top and seam-free sides, front and back.

Finish

- ANSI 61 gray polyester powder coating over phosphatized G90U galvanized steel.

PT Cabinets

Catalog Number	Dimensions			Knockout
	D"	W"	H"	
PT48L	8	8	27½	2½" - right side
PT48AL	8	12	36	2½" - right side
PT48R	8	8	27½	2½" - left side
PT48AR	8	12	36	2½" - left side



PT48AR*



S7860

Current Transformer Cabinets | Panel Enclosure

Catalog Number	UPC # (7-84572)	Weight	Dimensions			Steel Panel Catalog #	Wood Panel Catalog #
			W"	H"	D"		
363010-CT3R	18823	99	36	30	10	A-36P30	A-36P30W
363016-CT3R	16181	121.5	36	30	16	A-36P30	A-36P30W
363610-CT3R	17368	113	36	36	10	A-36P36	A-36P36W
363612-CT3R	16185	118	36	36	12	A-36P36	A-36P36W
363616-CT3R	18819	139	36	36	16	A-36P36	A-36P36W
483616-CT3R	25707	163	48	36	16	A-48P36	A-48P36W
484812-CT3R	16184	210	48	48	12	A-48P48	A-48P48W
606013-CT3R	18252	274	60	60	13	A-60P60	A-60P60W

Notes

- ***PT48:** PT48L and PT48AL has mounting emboss on the right side to be mounted on left side of CT cabinet. PT48R and PT48AR have mounting emboss on left side to be mounted on right side of CT cabinet.
- **Wall or Pole Mount:** For wall or pole mount CT rack order **S7860**. This unit accomodates 3 donut style CTs. The removable cover makes wiring much easier.

Utility requirements for this equipment may vary. Always consult the serving utility for their requirements before ordering or installing equipment.





K4797 (studs)



K4798 (studs)



K4729 (with lugs)



K4722 (with lugs)



**CT364811-HC CT Cabinet
and K4722 CT Rack**

800 Amps | Transformer Cabinets

Catalog Number	C.T. Racks	Dimensions			Front Cover	Cover Type
		D"	W"	H"		
CT244811-SC	A	11	24	48	1 Piece	Screw
CT304811-SC	A, B, G, H	11	30	48	1 Piece	Screw
CT364811-SC	A, B, G, H	11	36	48	1 Piece	Screw
CT244811-HC	A	11	24	48	1 Piece	Hinge
CT304811-HC	A, B, G, H	11	30	48	1 Piece	Hinge
CT364811-HC	A, B, G, H	11	36	48	1 Piece	Hinge

CT Cabinet Mounting Racks

Code	Catalog Number	AIC Rating	Amps	Volts	Type of Service	Termination Type
A	K4797	50K	800	600	1Ø3W or 3Ø3W	½ - 13 studs on 1¾" centers
B	K4798	50K	800	600	3Ø4W	½ - 13 studs on 1¾" centers
G	K4729	50K	800	600	1Ø3W or 3Ø3W	6 lugs: (3) #4-600 or (6) #1-250
H	K4722	50K	800	600	3Ø4W	8 lugs: (3) #4-600 or (6) #1-250

Notes

- **Enclosure:** These units are rated Type 3R, powder coated and constructed of galvanized steel.
- **Mounting:** ¼ - 20 welded studs for use with CT mounting rack.



Utility requirements for this equipment may vary. Always consult the serving utility for their requirements before ordering or installing equipment.

Transockets

600 Amps | 6–14 Terminals | Donut or Bar Type CTs

25
600 AMP
TRANSOCKETS

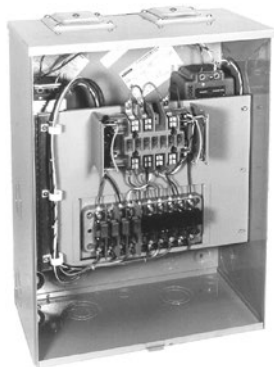

S1890-XT

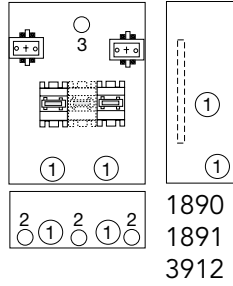

S2690-XT

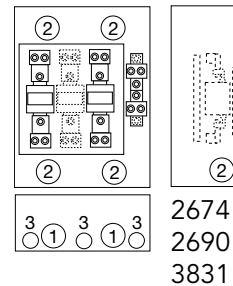

S2690-XT

600 Amps | 600 Volts | With PTs and Donut Type CTs | Ringless

Catalog Number	Terminals	Hub	Meter Form	PTs Quantity & Ratio	CTs Quantity & Ratio	Dimensions			Knockouts		
						D"	W"	H"	1	2	3
S1891-XT	8	(2) C.P.	5S	(2) 4:1	(2) 200/5	9½	18	24	2½	1	1¼/6
S3912-XT	13	(2) C.P.	6S	(2) 2.5:1	(3) 200/5	9½	18	24	2½	1	1¼/6
S1890-XT	14	(2) C.P.	6S	(2) 2.5:1	(3) 200/5	9½	18	24	2½	1	1¼/6

600 Amps | 600 Volts | Bar Type CTs Only | Ringless

Catalog Number	Terminals	Hub	Meter Form	CTs Quantity & Ratio	Dimensions			Knockouts		
					D"	W"	H"	1	2	3
S3831-XT	6	(2) C.P.	4S	(2) 200/5	11¼	18	30	4	3½	1
S2690-XT	8	(2) C.P.	5S	(2) 200/5	11¼	18	30	4	3½	1
S2674-XT	13	(2) C.P.	8S	(3) 200/5	11¼	18	30	4	3½	1

Notes

- **Hubs:** Units are supplied with two closing plates as standard. To order hubs as extra refer to the hub suffix chart on the accessory page.
- **Prewiring:** Units supplied prewired with test switch and transformers in place. Contact factory if wiring diagram is desired.
- **Pricing:** Contact general office for pricing information.
- **Other units available - contact factory for details.**

Utility requirements for this equipment may vary. Always consult the serving utility for their requirements before ordering or installing equipment.



26

100-200 AMP
METER MAIN
PEDESTAL

Meter Pedestal

100-200 Amps | 4 Terminals | Ringless | 120/240 VAC

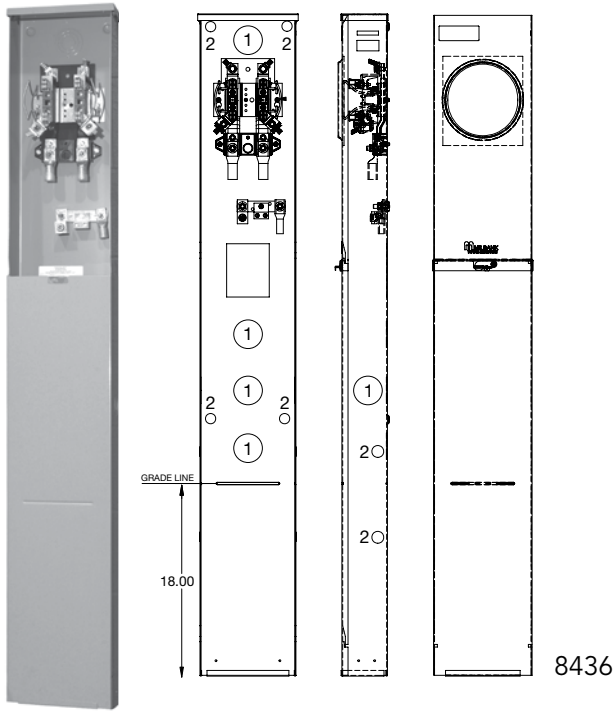

U8436-O

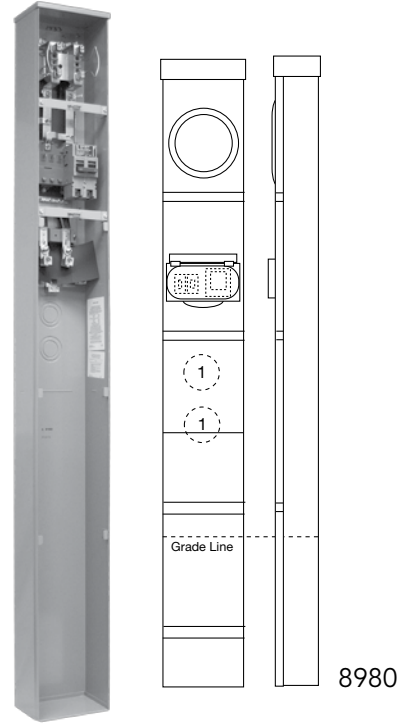

NU8980-O-KK

4 Terminals | Ringless | Underground Service

Catalog Number	Amps	Hub	Connectors CU/AL		Bypass	Dimensions			Knockouts	
			Line	Load		D"	W"	H"	1	2
U8436-O	200	Blank	4/0 (line) 2/0 (neutral)	#6-350	Horn	4 $\frac{1}{8}$	9	62	2	1 $\frac{1}{4}$, 1 $\frac{1}{2}$
NU8980-O	200	Blank	#6-350	CB ¹	None	6	9	79	2 $\frac{1}{2}$	—
NU8980-O-SF100	100	Blank	#6-350	CB	None	6	9	79	2 $\frac{1}{2}$	—
NU8980-O-200 ²	200	Blank	#6-350	CB	None	6	9	79	2 $\frac{1}{2}$	—

Notes

¹ Field Installed Circuit Breaker Required. ² Milbank main breaker.

- **Hanging Hook:** U8436 is supplied with keyhole hanger for easy mounting to building.
- **Extension Unit:** For U8436, order extension unit K5800 for 15" burial applications and two K5800 units for 30" burial applications.
- **Series Wired Main:** For series wired main order wire kit K4714 and UQFPH-M type circuit breaker.
- **Branch Circuit Breakers:** Branch interior accepts most manufacturers' small frame plug-in type circuit breakers (Milbank, GE, Siemens, Cutler-Hammer, Murray).
- **SF:** SF in catalog number has small frame plug-in type circuit breaker installed on middle stabs of 4-circuit interior. Only two single pole spaces available.
- **Fifth Terminal:** For field installed fifth terminal, order catalog number K5T.
- **Listing:** Listed for free standing or wall mount.



Utility requirements for this equipment may vary. Always consult the serving utility for their requirements before ordering or installing equipment.

Meter Main w/ Load Center Pedestal

100–200 Amps | 4 Terminals | Ringless

27

100-200 AMP
METER MAIN
W/ LOAD CENTER
PEDESTAL



U5136-O-200S

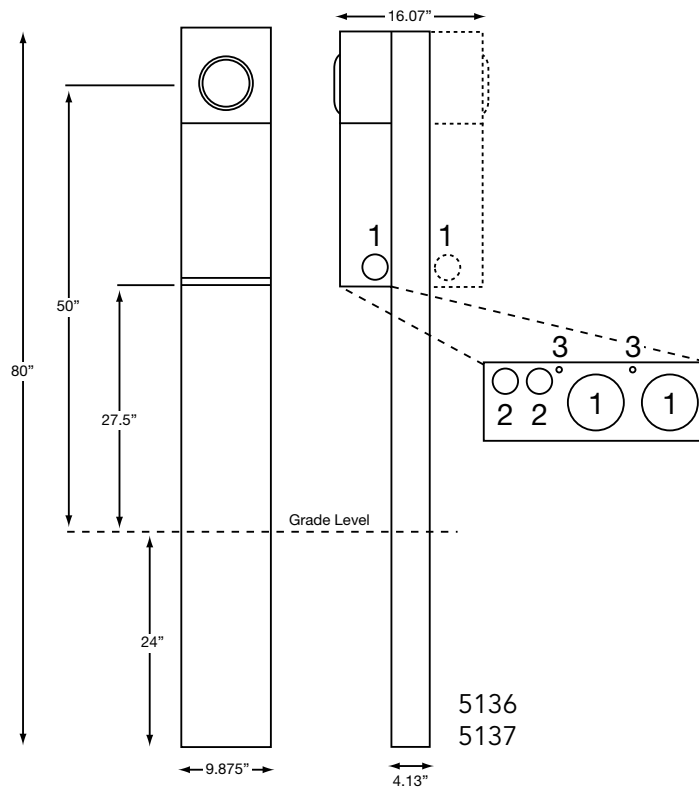

5136
5137

100-200 Amps | 4 Terminals | Meter Main Pedestal | Ringless

Catalog Number	Service	Meter Positions	Bypass	Connectors CU/AL		Knockouts		
				Line	Load	1	2	3
U5136-O-100S	UG	Single	Horn	#6-350	CB	2	1/2, 3/4	1/4
U5136-O-200S	UG	Single	Horn	#6-350	CB	2	1/2, 3/4	1/4
U5137-O-200S	UG	Double	Horn	#6-350	CB	2	1/2, 3/4	1/4

Notes

- **Parallel to Series Conversion:** For field converting from parallel wired to series wired order **K5194**.
- **Fifth Terminal:** For field installed fifth terminal, order **K5T**.
- **Stabilizer Foot:** For field installed stabilizer foot, order **K5415**.
- **Application:** Designed for free standing direct burial.
- **Receptacles:** Consult factory for installed receptacle assemblies.
- **Main Breaker:** Milbank UQFP-M-(AMP).
- **Ring Type Units:** Ring type units available—contact Milbank for details.

Utility requirements for this equipment may vary. Always consult the serving utility for their requirements before ordering or installing equipment.



Surface Mount Power Outlet

Millennium Series | Metered & Unmetered



U5000-XL-75

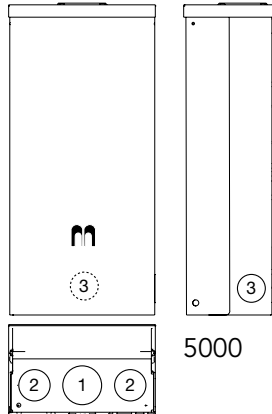

5000



U5100-XL-75

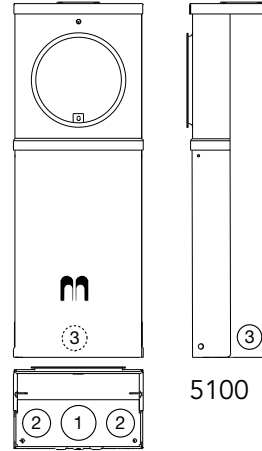

5100

125 Amps | Surface Mount Power Outlets

Catalog Number	Metered/ Unmetered	Receptacle Configuration	Circuit Breaker Configuration	Loop Feed Line	Dimensions			Knockouts		
					D"	W"	H"	1	2	3
U5000-XL	Unmetered	—	—	(2) 1/0-#12	5½	9⅞	19¼	2	1½	1¼
U5000-XL-41	Unmetered	A	X	(2) 1/0-#12	5½	9⅞	19¼	2	1½	1¼
U5000-XL-55	Unmetered	B	Y	(2) 1/0-#12	5½	9⅞	19¼	2	1½	1¼
U5000-XL-75	Unmetered	C	Z	(2) 1/0-#12	5½	9⅞	19¼	2	1½	1¼
U5100-XL	Metered	—	—	#6-250	5½	9⅞	25	2	1½	1¼
U5100-XL-41	Metered	A	X	#6-250	5½	9⅞	25	2	1½	1¼
U5100-XL-55	Metered	B	Y	#6-250	5½	9⅞	25	2	1½	1¼
U5100-XL-75	Metered	C	Z	#6-250	5½	9⅞	25	2	1½	1¼

Receptacle Configurations

A	B	C
(1) TT30R, (1) 5-20R GFI	(1) 14-50R, (1) 5-20R GFI	(1) 14-50R, (1) TT30R, (1) 5-20R GFI

Notes

- **Other Configurations:** Additional configurations are available—contact Milbank for details.
- **Metered Units:** Metered units are ring type.

Circuit Breaker Configurations

X	Y	Z
(1) 30A, 1P, 120V (1) 20A, 1P, 120V	(1) 50A, 2P, 120/240V (1) 20A, 1P, 120V	(1) 50A, 2P, 120/240V (1) 30A, 1P, 120V (1) 20A, 1P, 120V



Utility requirements for this equipment may vary. Always consult the serving utility for their requirements before ordering or installing equipment.

Power Outlet Pedestals

Millennium Series | Metered & Unmetered

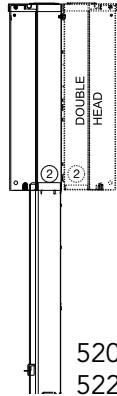
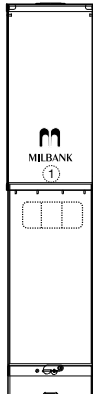

5200
5220

U5200-XL-75

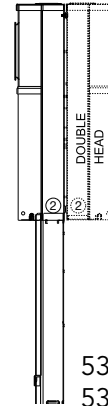

5300
5320

U5300-O-75

125 Amps | Power Outlet Pedestals

Catalog Number	Double Head Catalog Number	Receptacle Configuration	Circuit Breaker Configuration	Dimensions			Knockouts
				D"	W"	H"	1
U5200-XL	U5220-XL	—	—	5 ⁹ / ₁₆	9 ¹ / ₈	64 ¹ / ₂	1 ¹ / ₄
U5200-XL-41	U5220-XL-41	A	X	5 ⁹ / ₁₆	9 ¹ / ₈	64 ¹ / ₂	1 ¹ / ₄
U5200-XL-55	U5220-XL-55	B	Y	5 ⁹ / ₁₆	9 ¹ / ₈	64 ¹ / ₂	1 ¹ / ₄
U5200-XL-75	U5220-XL-75	C	Z	5 ⁹ / ₁₆	9 ¹ / ₈	64 ¹ / ₂	1 ¹ / ₄
U5300-O	U5320-O	—	—	5 ⁹ / ₁₆	9 ¹ / ₈	70 ¹ / ₄	1 ¹ / ₄
U5300-O-41	U5320-O-41	A	X	5 ⁹ / ₁₆	9 ¹ / ₈	70 ¹ / ₄	1 ¹ / ₄
U5300-O-55	U5320-O-55	B	Y	5 ⁹ / ₁₆	9 ¹ / ₈	70 ¹ / ₄	1 ¹ / ₄
U5300-O-75	U5320-O-75	C	Z	5 ⁹ / ₁₆	9 ¹ / ₈	70 ¹ / ₄	1 ¹ / ₄

Receptacle Configurations

A	B	C
(1) TT30R, (1) 5-20R GFI	(1) 14-50R, (1) 5-20R GFI	(1) 14-50R, (1) TT30R, (1) 5-20R GFI

Notes

- **Other Configurations:** Additional configurations are available—contact Milbank for details.
- **Metered Units:** Metered units are ring type.

Circuit Breaker Configurations

X	Y	Z
(1) 30A, 1P, 120V (1) 20A, 1P, 120V	(1) 50A, 2P, 120/240V (1) 20A, 1P, 120V	(1) 50A, 2P, 120/240V (1) 30A, 1P, 120V (1) 20A, 1P, 120V

Utility requirements for this equipment may vary. Always consult the serving utility for their requirements before ordering or installing equipment.





U4540-XL

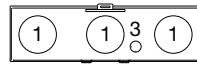
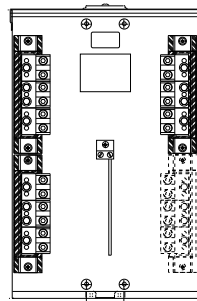

4540
4542



4544
4546

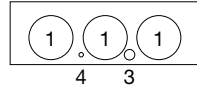

4548
4549

4 3

Shown with optional 3Ø Lug Kit



S9617-O

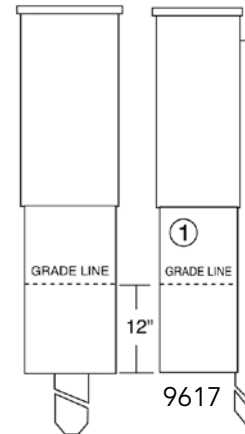

Terminal Boxes | 1Ø and 3Ø | 120/240 Volts

Catalog Number	Amps	Phase	Volts	Hub	Connectors CU7AL	1Ø to 3Ø Kit	Dimensions			Knockouts			
							D"	W"	H"	1	2	3	4
U4544-XL	100	1	120/240	C.P.	(6) #12-1/0	K4543	4 1/8	9 13/16	18	2	1	1/4, 1/2	—
U4546-XL	100	3	600	C.P.	(6) #12-1/0	N/A	4 1/8	9 13/16	18	2	1	1/4, 1/2	—
U4540-XL	200	1	120/240	C.P.	(6) #6-350	K4539	4 1/8	14 13/16	23	2 1/2	2 1/2	1 1/4	1 1/4, 1/2
U4542-XL	200	3	600	C.P.	(6) #6-350	N/A	4 1/8	14 13/16	23	2 1/2	2 1/2	1 1/4	1 1/4, 1/2
U4548-RXL	400	1	120/240	C.P.	(3) #6-350 or (2) #4-600	K4547	5	15 1/2	27	3	3	1 1/4, 1/2	1 1/4
U4549-RXL	400	3	600	C.P.	(3) #6-350 or (2) #4-600	N/A	5	15 1/2	27	3	3	1 1/4, 1/2	1 1/4

Notes

- **Hub:** Standard hub opening on top with closing plate attached.
- **Features:** UL-listed pad lockable Type 3R enclosure.
- **3Ø 120/240V Application:** Field installable 3Ø lug kit converts 1Ø unit to 3Ø unit.

Secondary Service Pedestal for Underground Use

Catalog Number	Pedestal Supplied With	Dimensions		
		D"	W"	H"
S9617-O	(3) 6 hole 350 MCM connector bars	10 11/32	10 3/8	45 11/16

Notes

- **Features:** Unit supplied with 3/8"-16 penta head bolt and pad-lockable latch.
- **Stake:** Catalog number **S9110** must be added to catalog number in order to ensure shipment of 72" stake for free standing installation (i.e. **S9617-O-S9110**).



Utility requirements for this equipment may vary. Always consult the serving utility for their requirements before ordering or installing equipment.

Terminal Box

Secondary

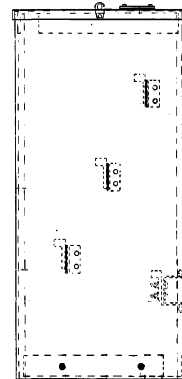
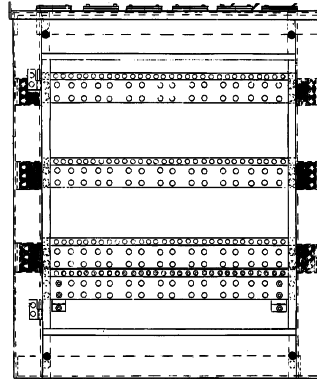
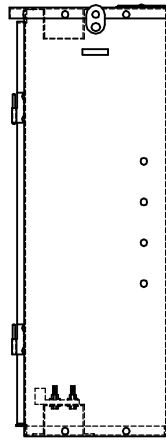
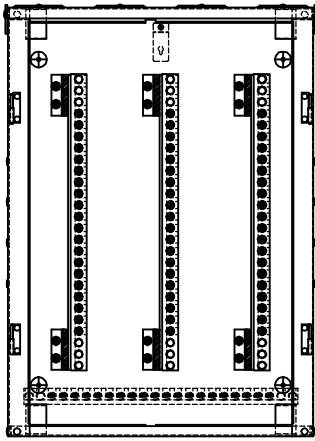

8333

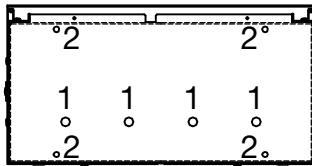

1787

Terminal Boxes

Catalog Number	Hub	Amps (End Connection)	Amps (Center Connection)		Dimensions			Knockouts	
			Each Way	Total	D"	W"	H"	1	2
S1787-4X	(4) C.P.	950	950	1900	14	30	42	7/8	5/16
S8333-6X	(6) C.P.	1500	1500	3000	24	44	52	—	—

Notes

- **Hot Bus Support:** Hot bus support and support ear available as kit for the **S8333**. Order kit **K1822**. Kit also includes hardware to mount bus.

Utility requirements for this equipment may vary. Always consult the serving utility for their requirements before ordering or installing equipment.



Commercial Pedestals

Attractive | Easy to Install | Secure | Cost-Effective

Milbank Commercial Pedestals are pad-mounted, weatherproof electrical enclosures consisting of a utility pull section with optional meter socket, and a customer section containing distribution and control equipment. Milbank Commercial Pedestals are an attractive, secure, easy to install and cost-effective solution when underground remote site power distribution and control equipment is required, replacing unsightly and inefficient strut and backboard structures.



Strut and backboard



Commercial pedestal

UL-listed as Industrial Control Equipment (File E113855)

Standard Features

- Type 3R rainproof, vandal-resistant cabinet of polyurethane powder-coated steel (aluminum or stainless steel also available)
- UL-listed as enclosed industrial control equipment (UL508)
- Isolated lockable & sealable utility metering and lug landing sections
- Lockable customer section for distribution and control equipment with internal deadfront
- Print pocket inside customer section door contains wiring schematics and installation instructions
- Most load centers are UL-listed for use with various manufacturers' circuit breakers
- All stainless steel external hardware (screws, bolts, hinges, handles, hasps and sealing screws)



Ringless socket



Ring type socket



Utility lug landing

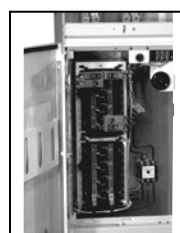

Customer interior



Utility requirements for this equipment may vary. Always consult the serving utility for their requirements before ordering or installing equipment.

Commercial Pedestals

Attractive | Easy to Install | Secure | Cost-Effective

33
COMMERCIAL
PEDESTALS

Applications

These units are ideal for controlling and metering:

- Traffic signals
- Street lighting
- Irrigation and sprinkler systems
- Cell towers and telephone vaults
- Pump stations
- Temporary power for fairgrounds, swap meets, outdoor markets, portable offices, holiday lights, etc.
- Outdoor lighting for athletic fields, tennis and basketball courts, parking lots, landscaping and subdivision entrances, etc.

Available Factory-Installed Options

- Meter sockets: ring type or ringless, up to 400 amp
- Main and branch breakers or T fuses
- Distribution: copper load centers and panel boards
- Clocks, timers and relays
- Photoelectric cells and controls
- Power receptacles: pin and sleeve, twist lock or straight blade
- Contactors: definite purpose, electrical or mechanically held, IEC and mercury types
- Surge protection and lightning arrestors
- Reserve inlet generator receptacle with interlocked circuit breakers
- Motor starters and relays
- Push button controls
- Thermostat controls, fans and heating strips
- Power blocks and terminal blocks
- Steel, aluminum and plywood backboards
- Transformers
- Interlock devices for circuit breakers
- Available in steel, aluminum (unpainted, painted or anodized) or stainless steel construction with powder-coated finish available in eight standard colors or special-ordered RAL colors
- Available for applications up to 400 amp, 120V, 208V, 240V, 277V, 480V - 1Ø or 3Ø



Utility requirements for this equipment may vary. Always consult the serving utility for their requirements before ordering or installing equipment.



With over 85 years in the electrical distribution industry, Milbank is proud to offer quality home standby, portable, digital inverter and mobile & industrial generator systems.

Home Standby Generators

- Wide range of sizes for small to large luxury homes and businesses
- Liquid propane and natural gas options



Digital Inverter Generators

- Small footprint
- Lightweight
- Quiet operation
- Safe for sensitive electronics



Portable Generators

- Manual and electric start options
- EPA compliant



Transfer Switches

- Single- and three-phase options
- Whole house power management

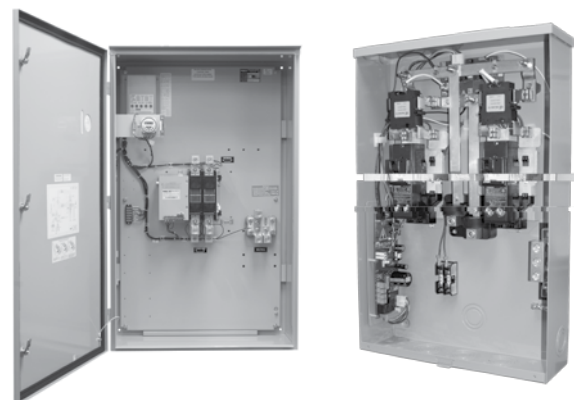

Utility requirements for this equipment may vary. Always consult the serving utility for their requirements before ordering or installing equipment.

Electric Vehicle Supply Equipment

Milbank | *Driving the Future of Power*

35
ELECTRIC
VEHICLE
SUPPLY
EQUIPMENT

From a wall-mounted single dock unit in a residential garage, to a citywide municipal integration, our scalable, flexible, reliable solution is designed for effectiveness in virtually any installation scenario.

Level II Models

MEVSE-RS—Residential, single wall mounted; overnight at-home charging.

MEVSE-RS Dual—Pedestal mounted with two ports; ideal for multi-family and high-traffic commercial parking lots.

MEVSE-RS+—Available in single, dual and quad configurations with the addition of programmable, smart charging capabilities; allows communication with the grid for charging when energy consumption is low; allows connectivity to GPRS.

Level III Models

DC Fast Charge — Stations feature JARI/TEPCO connectors and CHAdeMO certification; practical networking and payment options; available from 30-60kW models suitable for public and fleet usage; charges in 15-30 minutes.

Suitable EV Station Locations

- Shopping malls
- Theatres
- Municipal buildings
- Central business districts
- Entertainment districts
- Stadiums & arenas
- Rest areas
- Truck stops / travel plazas
- Camping / RV parks
- Restaurants
- Parking garages
- Public curbside parking
- Office buildings
- Single-family residences
- Multi-unit residences
- Airports
- Hotels
- Casinos
- Anywhere people park for extended periods of time



Utility requirements for this equipment may vary. Always consult the serving utility for their requirements before ordering or installing equipment.



Disconnect/Out of Service Devices

Disconnect Sleeve

Application	Discretely disconnects service at the meter while leaving the meter in place.	 <p>M5-144 disconnect sleeves (above) shown installed on meter blades (below)</p>
Features	<p>Mylar® polyester film — flexible, durable and stable even at extreme temperatures.</p> <p>Safe, reliable and easy to install</p> <p>Standard design fits most meter blades</p> <p>High dielectric strength</p> <p>Non-hygroscopic</p>	
Ordering	Order M5-144	
Installation Guidelines	<p>Turn off main switch or breaker before installation</p> <p>Remove meter from socket</p> <p>Place disconnect sleeve over load side blades</p> <p>Replace meter and reseal</p> <p>Do not use disconnect sleeves on lever bypass sockets.</p>	

Plug-In Out Of Service Device

Application	Disconnects service at the meter.	 <p>K4974 (above); meter with K4974 installed and service disconnected (below).</p>
Features	<p>Meter stays in place to prevent tampering and to simplify power restoration</p> <p>Rotated meter shows that service has been disconnected</p> <p>Easily plugs into all new Milbank 200 amp blocks with square fifth terminal hole</p>	
Ordering	Order K4974	



Utility requirements for this equipment may vary. Always consult the serving utility for their requirements before ordering or installing equipment.

Accessories

Hubs and Closing Plates

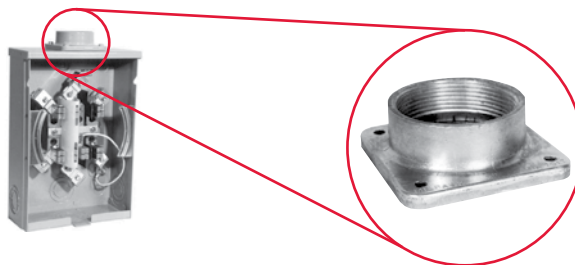
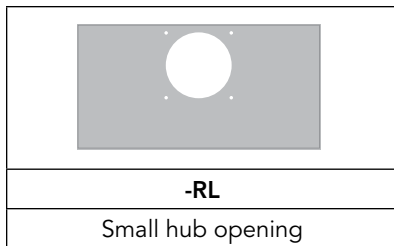

-WL A7514	-YL A7515	-ZL A7516	-DL A7517	-EL A7518	-XL A7551
1" hub	1¼" hub	1½" hub	2" hub	2½" hub	Small closing plate

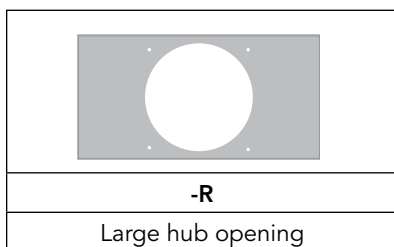

-F A8110	-G A8111	-H A8112	-X A9064	-RRL S8324
3" hub	3½" hub	4" hub	Large closing plate	Large hub opening adapted to small hub opening

Notes

- **Suffix:** Add to catalog number for factory installation of hub.
- **Packaging:** Individually packed units for field installation.
- **Abbreviations:** H.O. (hub opening), C.P. (closing plate).

Utility requirements for this equipment may vary. Always consult the serving utility for their requirements before ordering or installing equipment.



Connector Kits, Closing Covers & Sealing Rings

Connector Kits | For Use with 3/8"-16 Stud Type Units Only

Single			Twin		
Suffix	Part #	(3 per set) - 1Ø	Suffix	Part #	(3 per set) - 1Ø
K1	K1539	6-350	K2	K1350	6-350
K3	K1540	6-350 (non rotating)	K2L	K1350L	6-350 (non rotating)
K3L	K1540L	4-600 or (2) 1/0-250 (non rotating)	K4	K1541	4-600
Suffix	Part #	(4 per set) - 3Ø	Suffix	Part #	(4 per set) - 3Ø
K5	K3082	6-350	K6	K3442	6-350
K7	K3441	4-600 or (2) 1/0-250	K8	K3083	4-600

Bypass Link



K8180 (sold in pairs)

Closing Covers

Meter Closing Plate (Ring Type / Ringless)	Metal Closing Plate (For Ringless Sockets)
6003 - Grey Plastic	CP-21
6116 - Clear Plastic	



Generator Interlock

	Allows only one breaker to be in the "on" position when back-feeding with a standby power generator.
K5815 - large QN with small frame Q	
K5820 - large frame QN with large frame QN	
K5830 - small frame Q to small frame Q	

Sealing Rings

MR-2 - Snap Action	MR-4 - Screw Type (Stainless Steel)
MR2-SS - Stainless Steel	

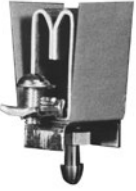
Fifth Terminals

		
5T8K2 - 100-200 Amp "Plug-In"	K5T - 200 Amp (Block with Square Hole)	K3865 - Heavy Duty Jaw Clamping (K3866 without Neutral Wire)

Triplex Ground

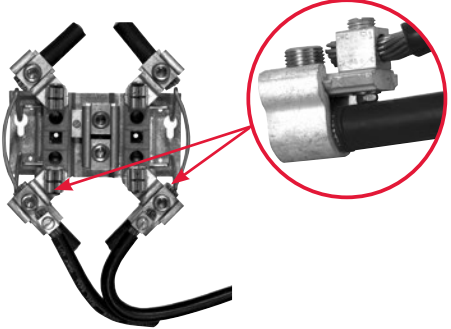

K1190 (For factory installed triplex ground, add suffix -TG to catalog number)

Tap Connectors (3 per set)

	Replaces the load or line side slide-in nut assembly on Milbank 200 amp sockets. Allows for a 100 amp tap location in addition to the #6-350 kcmil load-side connector. K5022 includes safety barrier extensions for applications over 300 VAC. Three lugs per kit.
K4977-INT - Internal Hex (set of 3)	
K4977-EXT - External Hex (set of 3)	
K5022-INT - Internal Hex (set of 4 w/ barrier)	

Locknut Clearances

Clearance for Locknuts on Knockouts

	<i>"D" in nearest practical dimension)</i>
Knockout Size	"D"
1/2	1 1/8
3/4	1 3/8
1	1 3/4
1 1/4	2 1/4
1 1/2	2 5/8
2	3 1/8
2 1/2	3 1/2
3	4 1/4
3 1/2	4 3/4
4	5 3/8

Knockout Actual Sizes

Conduit to Knockout Reference Chart

Conduit Size	Milbank Knockout	Actual Size Milbank Knockout
1/2	1/2	7/8
3/4	3/4	1 1/8
1	1	1 3/8
1 1/4	1 1/4	1 3/4
1 1/2	1 1/2	2
2	2	2 1/2
2 1/2	2 1/2	3
3	3	3 5/8
3 1/2	3 1/2	4 1/8
4	4	4 41/64

Utility requirements for this equipment may vary. Always consult the serving utility for their requirements before ordering or installing equipment.



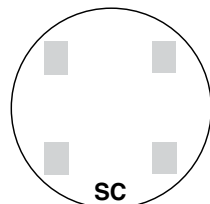

SC
2 and 3-WIRE FORMS
1S & 2S

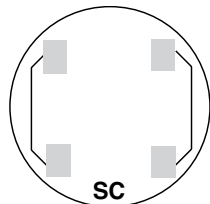

SC
2 and 3-WIRE FORMS
1S & 2S with BYPASS

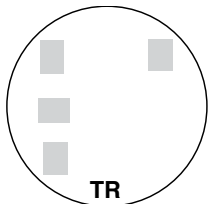

TR
2-WIRE FORM 3S
5th Term. 9 o'clock

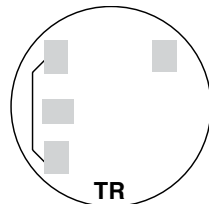

TR
2-WIRE FORM 3S
with BYPASS

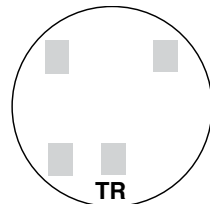

TR
2-WIRE FORM 3S
5th Term. 6 o'clock

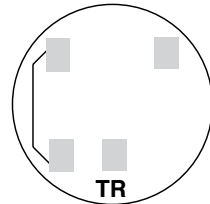

TR
2-WIRE FORM 3S
with BYPASS

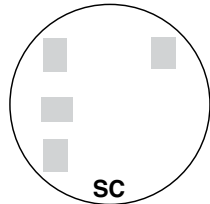

SC
2 ELEMENT
3-WIRE NETWORK
FORM 12S 5th
TERM. 9 o'clock

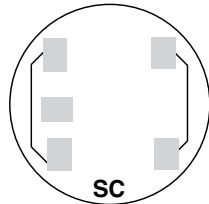

SC
2 ELEMENT 3-WIRE
NETWORK FORM 12S
with BYPASS
5th Term. 9 o'clock

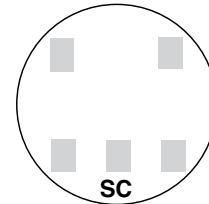

SC
2 ELEMENT
3-WIRE NETWORK
FORM 12S 5th
TERM. 6 o'clock

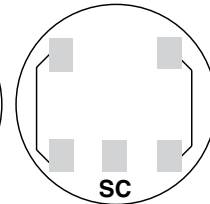

SC
2 ELEMENT 3-WIRE
NETWORK FORM 12S
with BYPASS
5th Term. 6 o'clock

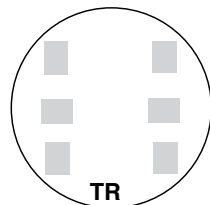

TR
3-WIRE FORM 4S

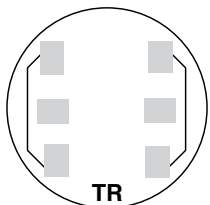

TR
3-WIRE FORM 4S
WITH BYPASS

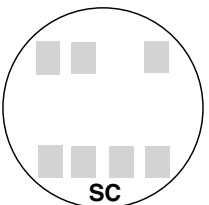

SC
2 or 3 ELEMENT
3Ø4W Y or Δ
Y FORM 14S
Δ FORM 15S

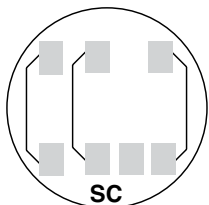

SC
2 or 3 ELEMENT
3Ø4W Y or Δ
FORMS 14S & 15S
with BYPASS

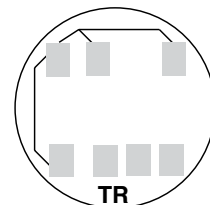

TR
2 ELEMENT
3Ø4W Y or Δ
Y FORM 7S
Δ FORM 24S
with BYPASS

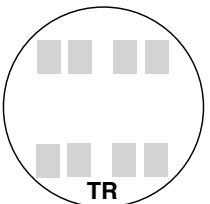

TR
2 ELEMENT
2Ø3W, 2Ø4W, 3Ø3W
FORM 5S

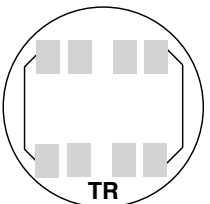

TR
2 ELEMENT 2Ø3W,
2Ø4W, 3Ø3W
FORM 5S with
BYPASS

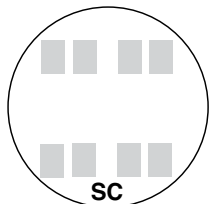

SC
2 ELEMENT
2Ø3W, 2Ø4W, 3Ø3W
FORM 13S

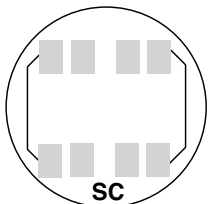

SC
2 or 3 ELEMENT
2Ø3W, 2Ø4W, 3Ø3W
FORM 13S with
BYPASS

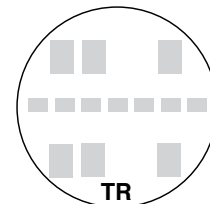

TR
2 or 3 ELEMENT
3Ø4W Y or Δ
Y FORM 9S
Δ FORM 8S

TR = TRANSFORMER RATED
SC = SELF CONTAINED

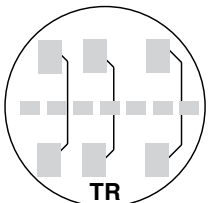

TR
2 or 3 ELEMENT
3Ø4W Y or Δ
FORMS 8S & 9S
with BYPASS

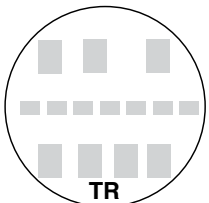

TR
2 ELEMENT
3Ø4W Y
FORM 6S

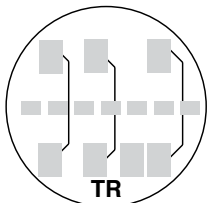

TR
2 ELEMENT
3Ø4W Y
FORM 6S
with BYPASS



Utility requirements for this equipment may vary. Always consult the serving utility for their requirements before ordering or installing equipment.

Meter Forms

Reference Information

DIAGRAM A

1 \emptyset 2W with 1 P.T. & 1 C.T.
Single Stator Meter (2W1 \emptyset) - Form 35
5T Socket, Test Switch #TS04-0101

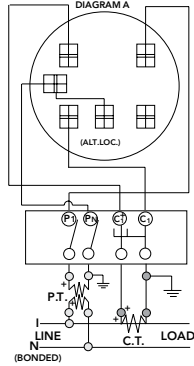

DIAGRAM B

1 \emptyset 3W with 1 C.T.
Single Stator Meter (2W1 \emptyset) - Form 35
5T Socket, Test Switch #TS04-0101

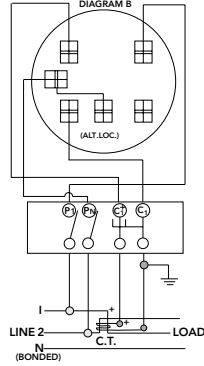

DIAGRAM C

1 \emptyset 3W with 2 C.T.'s
Single Stator Meter (3W1 \emptyset) - Form 45
6T Socket, Test Switch #TS07-0105

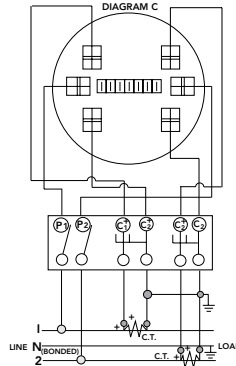

DIAGRAM D

1 \emptyset 3W or 3W Network with 2 C.T.'s
2 Stator Meter - Form 55
8T Socket, Test Switch #TS07-0105

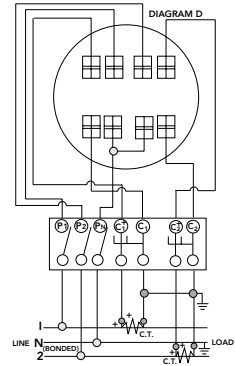

DIAGRAM E

3 \emptyset 3W "A" with 2 P.T.'s & 2 C.T.'s
2 Stator Meter - Form 55
8T Socket, Test Switch #TS07-0105

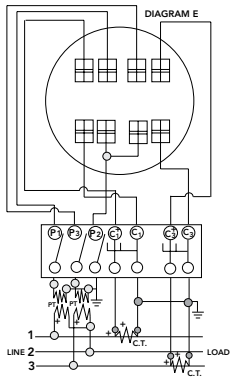

DIAGRAM F

3 \emptyset 3W "A" with 2 C.T.'s
2 Stator Meter - Form 55
8T Socket, Test Switch #TS07-0105

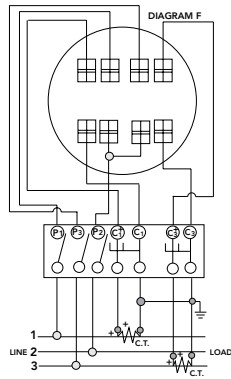

DIAGRAM G

3 \emptyset 4W "Y" with 3 C.T.'s
2 1/2 Stator Meter - Form 65
13T Socket, Test Switch #TS10-0109

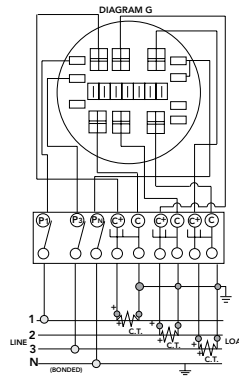

DIAGRAM H

3 \emptyset 4W "Y" with 2 P.T.'s & 3 C.T.'s
2 1/2 Stator Meter - Form 65
13T Socket, Test Switch #TS10-0109

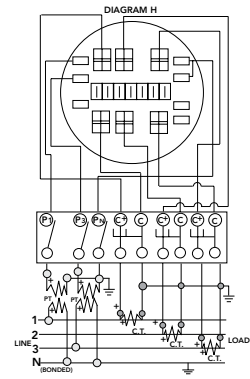

DIAGRAM I

3 \emptyset 4W "Y" or "A" with 3 C.T.'s
"Y" 3 Stator Meter - Form 95
"A" 2 Stator Meter - Form 85
13T Socket, Test Switch #TS10-0109

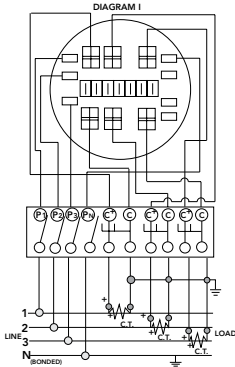
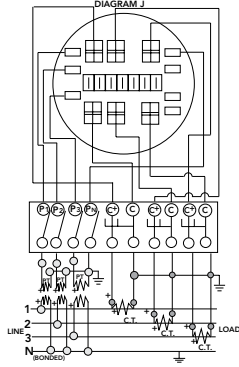

DIAGRAM J

3 \emptyset 4W "Y" with 3 P.T.'s & 3 C.T.'s
3 Stator Meter - Form 95
13T Socket, Test Switch #TS10-0109



Prewiring: If standard factory prewiring is required, refer to wiring diagrams on this page. Determine appropriate diagram and send a copy with order. If custom factory prewiring is required, specify on order. Be sure to include meter socket catalog number, test switch make and catalog number, meter form number and provide a copy of your wiring diagram.

Utility requirements for this equipment may vary. Always consult the serving utility for their requirements before ordering or installing equipment.



Materials

Steel Quality

The meter equipment listed in this catalog is made of galvanized steel (AISI* G90) to afford the best possible weather proofing.
*American Iron and Steel Institute.

Steel Sheet

16 gauge, galvanized, sheet: 1 1/4 oz./ sq.ft. class zinc-coated. (AISI G90)
14 gauge, galvanized, sheet: 1 1/4 oz./ sq.ft. class zinc-coated.

Aluminum Extrusion

Wire-Terminals: Alloy; 6061-T6, Tin-plated for CU/AL wire.
Bus Bar: Alloy; 6101-O & 6063-O

Aluminum Sheet

3000 series aluminum sheet, H14, or 5052 series aluminum sheet, H32. Where applicable thicknesses range from .064–.125

Copper Sheet & Bus

Electrolytic copper with tin plating in most applications.

Insulating Materials

- In most units, support bases for current-carrying components are molded from fiberglass reinforced high-strength, track resistant, thermoset polyester molding compounds.
- Clear or black safety shields and polarity barriers are molded from high-strength, track resistant, polycarbonate molding compounds.
- Various sheet insulating materials, as appropriate for the application are utilized in the fabrication of flat, formed and punched component parts and barriers.

Finish

Process

Light gray state-of-the-art electrostatically applied powder paint offers a durable, non-fading finish. For further information concerning the chemical analysis of the weather resistant finish, please contact the factory.

Metal Fastners

Zinc-coated with a chromate dip.

Ratings & Compliance

Ratings & Compliance

All Milbank electrical enclosures in this catalog are rated "Type 3R Enclosure" unless specified otherwise on the product's page. All enclosures with a UL designation are constructed per the appropriate UL Standard and may be installed per the National Electric Code. UL procedure files associated with the UL Standards are listed as follows: Meter Sockets (UL 414, File E30202), Test Switches (UL 414, File E62531), Power Outlets (UL 231, File E90945), Panelboards (UL 67, File E32628) and Pullout Switches (UL 1429, File E133062). Additional standards are utilized as applicable: Meter Sockets (ANSI C12.7), Test Switches (ANSI C12.9) and Panelboards (NEMA PB-1).



Utility requirements for this equipment may vary. Always consult the serving utility for their requirements before ordering or installing equipment.

Enclosure Information

Milbank Electrical Meter Enclosures Specification Note

All Milbank electrical enclosures in this catalog are rated "Type 3R Electrical Enclosure" unless specified otherwise. All enclosures with a UL designation are constructed per the appropriate UL standard and may be installed per the National Electric Code. Meter sockets are constructed per "UL 414, Meter Sockets", file #E30202 and per "ANSI C12.7-1993-Meter Sockets". All test switches are constructed per "UL 414, Meter Sockets", file #E30302 and per "ANSI C12.9-1993-Test Switches". Power outlets are constructed per "UL 231, Power Outlets", file #E90945. Panelboards are constructed per "UL 67, Panelboards", file #E32628 and "NEMA PB-1-1984-Panelboards". Pullout switches are constructed per "UL 1429, Pullout Switches", file #133062.

Definitions Pertaining to Nonhazardous Locations | Indoor Use

Type 1 Enclosure

Type 1 enclosures are intended for indoor use primarily to provide a degree of protection against limited amounts of falling dirt.

Type 12 Enclosure

Type 12 enclosures are intended for indoor use primarily to provide a degree of protection against circulating dust, falling dirt and dripping noncorrosive liquids.

Type 13 Enclosure

Type 13 enclosures are intended for indoor use primarily to provide a degree of protection against dust, spraying of water, oil and noncorrosive coolant.

Definitions Pertaining to Nonhazardous Locations | Outdoor Use

Type 3 Enclosure

Type 3 enclosures are intended for outdoor use primarily to provide a degree of protection against rain, sleet, windblown dust and damage from external ice formation.

Type 3R Enclosure

Type 3R enclosures are intended for outdoor use primarily to provide a degree of protection against rain, sleet and damage from external ice formation.

Type 4 Enclosure

Type 4 enclosures are intended for indoor or outdoor use primarily to provide a degree of protection against windblown dust and rain, splashing water, hose-directed water and damage from external ice formation.

Type 4X Enclosure

Type 4X enclosures are intended for indoor or outdoor use primarily to provide a degree of protection against corrosion, windblown dust and rain, splashing water, hose-directed water and damage from external ice formation.

Utility requirements for this equipment may vary. Always consult the serving utility for their requirements before ordering or installing equipment.



6003.....	38	K4722	24	U1797-O-K2L-K3L	11
6116.....	38	K4729	24	U3328-RXL.....	8
363010-CT3R.....	22	K4797	24	U4363-R.....	11
363016-CT3R.....	22	K4798	24	U4505-X.....	11
363610-CT3R.....	22	K4974	36	U4540-XL.....	30
363612-CT3R.....	22	K4977-EXT.....	39	U4542-XL.....	30
363616-CT3R.....	22	K4977-INT.....	39	U4544-XL.....	30
483616-CT3R.....	22	K5022-INT.....	39	U4546-XL.....	30
484812-CT3R.....	22	K5815	38	U4548-RXL.....	30
5T8K2.....	39	K5820	38	U4549-RXL.....	30
606013-CT3R.....	22	K5830	38	U5000-XL.....	28
A7514.....	37	K5T.....	39	U5000-XL-41.....	28
A7515.....	37	K8180	38	U5000-XL-55.....	28
A7516.....	37	M5-144	36	U5000-XL-75.....	28
A7517.....	37	MR-2.....	38	U5100-XL.....	28
A7518.....	37	MR2-SS.....	38	U5100-XL-41.....	28
A7551.....	37	MR-4.....	38	U5100-XL-55.....	28
A8110.....	37	NU8980-O.....	26	U5100-XL-75.....	28
A8111.....	37	NU8980-O-2002.....	26	U5136-O-100S.....	27
A8112.....	37	NU8980-O-SF100.....	26	U5136-O-200S.....	27
A9064.....	37	PT48AL.....	22	U5137-O-200S.....	27
AP2300-03.....	4	PT48AR.....	22	U5168-XTL-100.....	13
AP2300-03-5T.....	4	PT48L.....	22	U5168-XTL-200.....	13
AP2300-03-5T-AB.....	4	PT48R.....	22	U5169-XTL-100.....	13
AP2300-03-6T.....	4	S1787-4X.....	31	U5169-XTL-200.....	13
AP2300-04.....	4	S1890-XT.....	25	U5200-XL.....	29
AP2300-07.....	4	S1891-XT.....	25	U5200-XL-41.....	29
AP2300-08.....	4	S1910-YL.....	8	U5200-XL-55.....	29
CP-21.....	38	S2417-DL.....	8	U5200-XL-75.....	29
CT244811-HC.....	24	S2417-RL.....	8	U5220-XL.....	29
CT244811-SC.....	24	S2674-XT.....	25	U5220-XL-41.....	29
CT304811-HC.....	24	S2690-XT.....	25	U5220-XL-55.....	29
CT304811-SC.....	24	S3831-XT.....	25	U5220-XL-75.....	29
CT364811-HC.....	24	S3912-XT.....	25	U5300-O.....	29
CT364811-SC.....	24	S4275-DL.....	8	U5300-O-41.....	29
K1190.....	39	S4339-RL.....	8	U5300-O-55.....	29
K1350.....	38	S8324.....	37	U5300-O-75.....	29
K1350L.....	38	S8333-6X.....	31	U5320-O.....	29
K1539.....	38	TS04-0101.....	21	U5320-O-41.....	29
K1540.....	38	TS04-0104.....	21	U5320-O-55.....	29
K1540L.....	38	TS07-0049.....	21	U5320-O-75.....	29
K1541.....	38	TS07-0105.....	21	U5764-X-200-CB.....	15
K3082.....	38	TS07-0106.....	21	U5765-X-200-CB.....	15
K3083.....	38	TS10-0016.....	21	U5767-X-200-CB.....	15
K3441.....	38	TS10-0109.....	21	U5784-O-200-CB.....	15
K3442.....	38	TS10-0110.....	21	U5787-O-200-CB.....	15
K3865.....	39	TS10-0111.....	21	U5796-X-400-CB.....	15
K3866.....	39	TS10-0112.....	21	U5797-O-400-CB.....	15



Utility requirements for this equipment may vary. Always consult the serving utility for their requirements before ordering or installing equipment.

U5799-O-400-CB.....	15	U5929-XL.....	5	U9701-RXL.....	9
U5842-PXL-200.....	12	U5934-XL.....	5	UAP5024-XL.....	13
U5842-RL.....	12	U7017-DL-TG.....	7	UC1299-RL.....	18
U5842-RL-100.....	12	U7017-RL-TG.....	7	UC1300-XL.....	18
U5844-PXL-200.....	12	U7017-RL-TG-5T.....	7	UC5087-RL.....	19
U5852-RL.....	12	U7018-XL-TG.....	7	UC5732-XL.....	18
U5852-RL-100.....	12	U7021-DL-TG.....	6	UC7235-RL.....	18
U5852-RL-200.....	12	U7021-RL-TG.....	6	UC7237-RL.....	18
U5854-RL-200.....	12	U7021-RL-TG-5T.....	6	UC7444-RL.....	19
U5882-X.....	17	U7040-RL-TG.....	6	UC7445-RL.....	19
U5883-X.....	17	U7420-RL.....	9	UC7448-RL.....	19
U5884-X.....	17	U7421-RL.....	9	UC7449-RL.....	19
U5885-X.....	17	U7422-RXL.....	9	UC7478-RL.....	19
U5886-X.....	17	U7423-RXL.....	9	UC7532-RL.....	19
U5890-X-2/200.....	14	U7487-RL-TG.....	5	UC7544-XL.....	18
U5891-X-2/200.....	14	U7487-RL-TG-5T.....	5	UC7545-XL.....	18
U5892-X-2/200.....	14	U7490-YL-TG.....	5	UCSS3433-O.....	10
U5893-X-2/200.....	14	U7490-YL-TG-5T.....	5	UCSS3436-O.....	10
U5894-X-2/200.....	14	U8212-RL.....	16	UCSS3438-O.....	10
U5895-X-2/200.....	14	U8213-RL.....	16	USS3914-O.....	10
U5902-X.....	17	U8214-RL.....	16	USS4701-O.....	10
U5903-X.....	17	U8215-RL.....	16	USS4801-O.....	10
U5904-X.....	17	U8216-XL.....	16	USS4801-O-5T9.....	10
U5905-X.....	17	U8436-O.....	26		
U5906-X.....	17	U9700-RRL.....	9		

Utility requirements for this equipment may vary. Always consult the serving utility for their requirements before ordering or installing equipment.







MILBANK[®]

ENERGY AT WORK

