



Catalog Number: A-36P30W  
Item Description: PLYWOOD PNL MOUNT HOLES  
UPC Code: 784572182905

Brand Name: Milbank  
Type: Panel for Mounting Electronic Controls  
Application: Enclosure Accessory  
Material: 3/4 Inch 7-Ply Plywood  
Shape: Rectangle  
Color: Unpainted  
Mounting: Stud Mount



*Utility requirements may vary. Always consult the serving utility for their requirements prior to ordering or installing this equipment. This product must always be installed by a licensed electrician. Installation of this equipment may require local electrical inspector approval.*

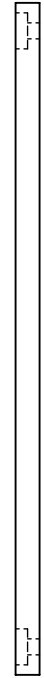
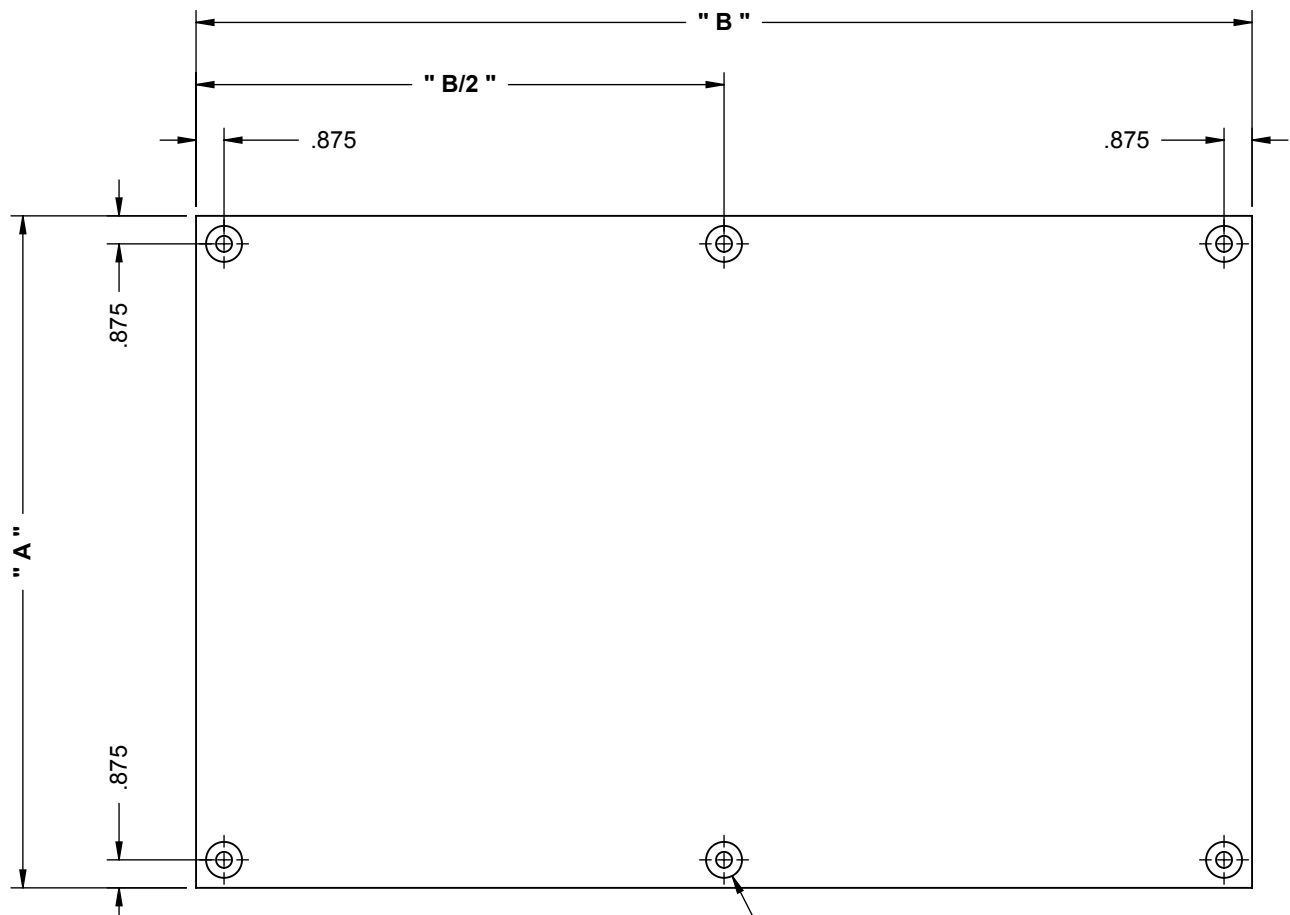

$\phi$  .500 THRU ALL  
 $\square$   $\phi$  1.125  $\nabla$  .375

LPN: #813590-WO

E2	5-9-03	REDRAWN & REVISED DRAWING - PDR 3582	DR			
E3	8/6/12	UPDATE TO M2K (ECO #22756)	D.F.			

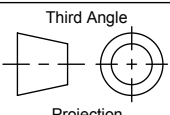
Material:	SEE CHART FOR TYPE		 General Offices: Kansas City, MO	
Finish:			Title:	PANEL, WOOD AP SERIES
Tolerances: Unless Specified Otherwise X.X ±.1 X.XX ±.03 X.XXX ±.015 X° ±2°		 Third Angle Projection		Catalog No.:
				Ref:
				Drawing No.:
				<b>1107029</b>
Scale:	NTS	Checked By:		Date:
Drawn By:		Approved By:		5-9-03
			Sheet	1 of 2

CATALOG NUMBER	FINISHED GOODS P/N	MATERIAL	MANUFACTURED P/N W/ HOLES	PURCHASED P/N W/O HOLES	DIM " A "	DIM " B "
A-36P24W	1006661	MDO ONE SIDE	813590-WO	705496-WO	21.000	33.000
A-36P24W-CCA		CCA TREATED	813590-WT	705496-WT	21.000	33.000
A-36P24W-V		2 COATS CLEAR POLY VARNISH	813590-WV	705496-WV	21.000	33.000
A-36P30W	1008800	MDO ONE SIDE	813591-WO	705497-WO	27.000	33.000
A-36P30W-CCA		CCA TREATED	813591-WT	705497-WT	27.000	33.000
A-36P30W-V		2 COATS CLEAR POLY VARNISH	813591-WV	705497-WV	27.000	33.000
A-24P42W		MDO ONE SIDE	813593-WO	705498-WO	21.000	39.000
A-24P42W-CCA		CCA TREATED	813593-WT	705498-WT	21.000	39.000
A-24P42W-V		2 COATS CLEAR POLY VARNISH	813593-WV	705498-WV	21.000	39.000
A-42P30W	1008802	MDO ONE SIDE	813594-WO	705499-WO	27.000	39.000
A-42P30W-CCA		CCA TREATED	813594-WT	705499-WT	27.000	39.000
A-42P30W-V		2 COATS CLEAR POLY VARNISH	813594-WV	705499-WV	27.000	39.000
A-48P24W	1097132	MDO ONE SIDE	813596-WO	705500-WO	21.000	45.000
A-48P24W-CCA		CCA TREATED	813596-WT	705500-WT	21.000	45.000
A-48P24W-V		2 COATS CLEAR POLY VARNISH	813596-WV	705500-WV	21.000	45.000
A-48P30W		MDO ONE SIDE	813597-WO	705501-WO	27.000	45.000
A-48P30W-CCA		CCA TREATED	813597-WT	705501-WT	27.000	45.000
A-48P30W-V		2 COATS CLEAR POLY VARNISH	813597-WV	705501-WV	27.000	45.000
A-30P60W		MDO ONE SIDE	813601-WO	705502-WO	27.000	57.000
A-30P60W-CCA		CCA TREATED	813601-WT	705502-WT	27.000	57.000
A-30P60W-V		2 COATS CLEAR POLY VARNISH	813601-WV	705502-WV	27.000	57.000
A-72P30W		MDO ONE SIDE	813606-WO	705503-WO	27.000	69.000
A-72P30W-CCA		CCA TREATED	813606-WT	705503-WT	27.000	69.000
A-72P30W-V		2 COATS CLEAR POLY VARNISH	813606-WV	705503-WV	27.000	69.000
A-32P36W	1006618	MDO ONE SIDE	814448-WO	705504-WO	29.000	33.000
A-32P36W-CCA		CCA TREATED	814448-WT	705504-WT	29.000	33.000
A-32P36W-V		2 COATS CLEAR POLY VARNISH	814448-WV	705504-WV	29.000	33.000
A-30P40W		MDO ONE SIDE	814452-WO	705505-WO	27.000	37.000
A-30P40W-CCA		CCA TREATED	814452-WT	705505-WT	27.000	37.000
A-30P40W-V		2 COATS CLEAR POLY VARNISH	814452-WV	705505-WV	27.000	37.000
A-30P44W		MDO ONE SIDE	814453-WO	705506-WO	27.000	41.000
A-30P44W-CCA		CCA TREATED	814453-WT	705506-WT	27.000	41.000
A-30P44W-V		2 COATS CLEAR POLY VARNISH	814453-WV	705506-WV	27.000	41.000
A-36P18W	1096002	MDO ONE SIDE	1098285 / 817839-WO	1098286 / 707916-WO	15.000	33.000
A-36P18W-CCA		CCA TREATED	817839-WT	707916-WT	15.000	33.000
A-36P18W-V		2 COATS CLEAR POLY VARNISH	817839-WV	707916-WV	15.000	33.000
A-60P32W		MDO ONE SIDE	814441-WO	708396-WO	29.000	57.000
A-60P32W-CCA		CCA TREATED	814441-WT	708396-WT	29.000	57.000
A-60P32W-V		2 COATS CLEAR POLY VARNISH	814441-WV	708396-WV	29.000	57.000

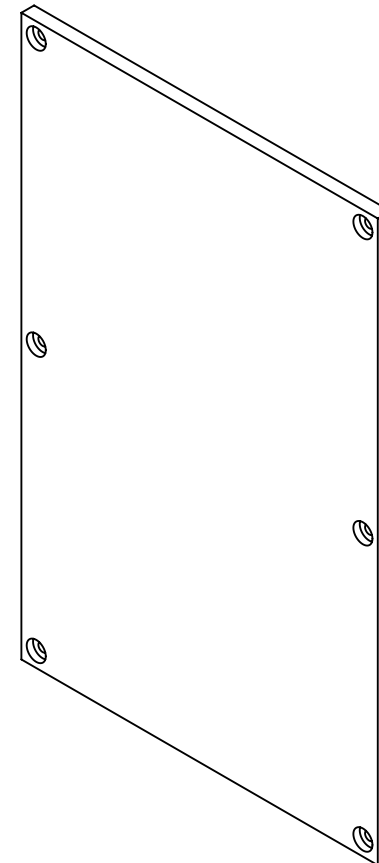

LPN: #813590-WO

E2	5-9-03	REDRAWN & REVISED DRAWING - PDR 3582	DR		
E3	8/6/12	UPDATE TO M2K (ECO #22756)	D.F.		

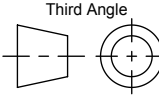
Material:	SEE CHART FOR TYPE		 General Offices: Kansas City, MO
Finish:			
Tolerances: Unless Specified Otherwise X.X ±.1 X.XX ±.03 X.XXX ±.015 X° ±2°		Third Angle  Projection	Title: PANEL, WOOD AP SERIES
			Catalog No.:
			Ref:
			Drawing No.:
			<b>1107029</b>
Scale:	NTS	Checked By:	Date:
Drawn By:		Approved By:	5-9-03 Sheet 2 of 2



Catalog Number: A-36P30W  
Item Description: PLYWOOD PNL MOUNT HOLES  
UPC Code: 784572182905

Brand Name: Milbank  
Type: Panel for Mounting Electronic Controls  
Application: Enclosure Accessory  
Material: 3/4 Inch 7-Ply Plywood  
Shape: Rectangle  
Color: Unpainted  
Mounting: Stud Mount



*Utility requirements may vary. Always consult the serving utility for their requirements prior to ordering or installing this equipment. This product must always be installed by a licensed electrician. Installation of this equipment may require local electrical inspector approval.*

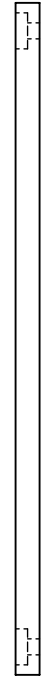
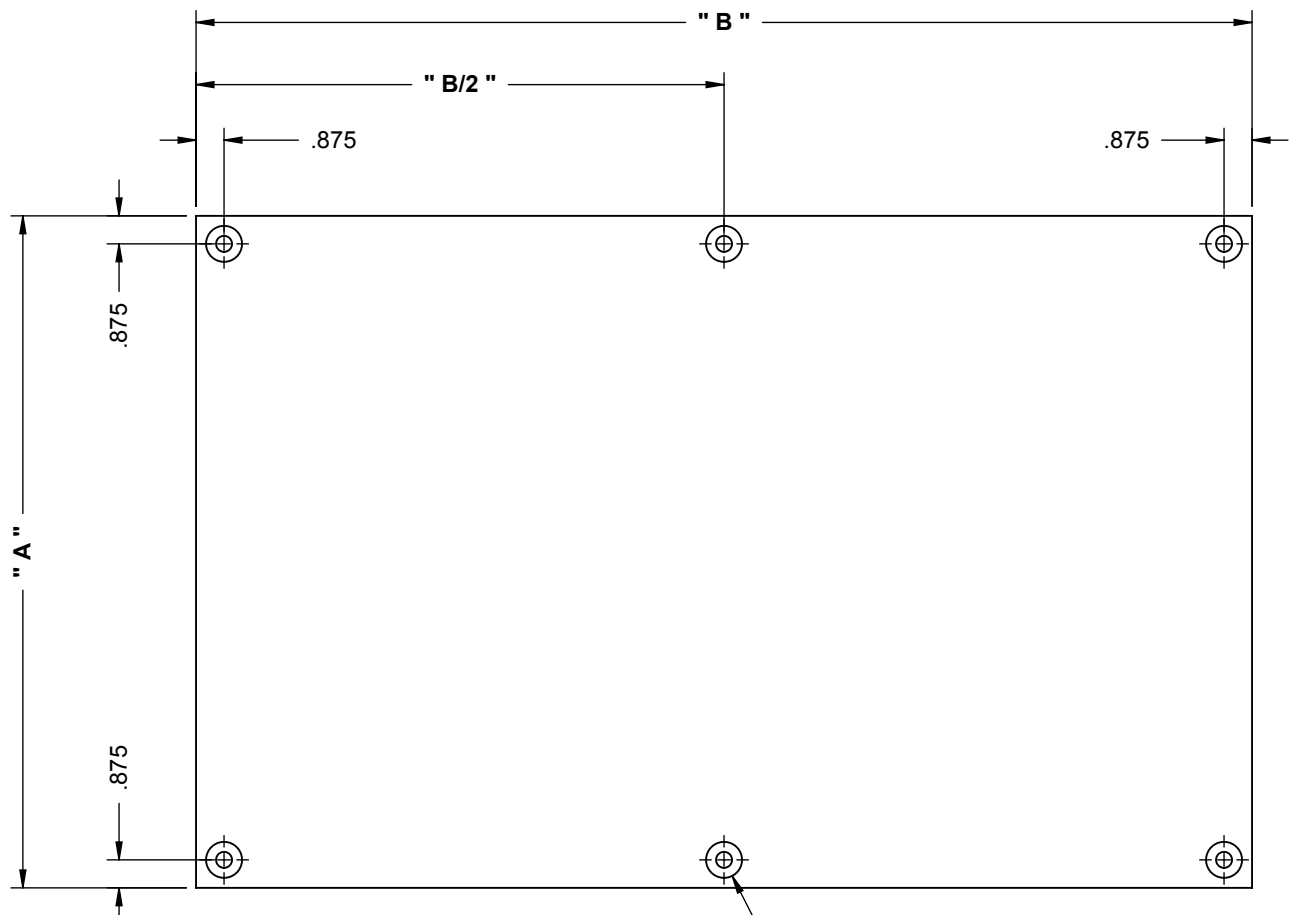

Ø .500 THRU ALL  
 □ Ø 1.125 ▽ .375

LPN: #813590-WO

E2	5-9-03	REDRAWN & REVISED DRAWING - PDR 3582	DR			
E3	8/6/12	UPDATE TO M2K (ECO #22756)	D.F.			

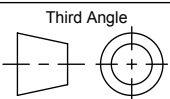
Material:	SEE CHART FOR TYPE		 General Offices: Kansas City, MO	
Finish:				
Tolerances: Unless Specified Otherwise X.X ±.1 X.XX ±.03 X.XXX ±.015 X° ±2°		Third Angle  Projection	Title:	PANEL, WOOD AP SERIES
			Catalog No.:	
			Ref:	
			Drawing No.:	<b>1107029</b>
Scale:	NTS	Checked By:	Date:	5-9-03
Drawn By:		Approved By:	Sheet	1 of 2

CATALOG NUMBER	FINISHED GOODS P/N	MATERIAL	MANUFACTURED P/N W/ HOLES	PURCHASED P/N W/O HOLES	DIM " A "	DIM " B "
A-36P24W	1006661	MDO ONE SIDE	813590-WO	705496-WO	21.000	33.000
A-36P24W-CCA		CCA TREATED	813590-WT	705496-WT	21.000	33.000
A-36P24W-V		2 COATS CLEAR POLY VARNISH	813590-WV	705496-WV	21.000	33.000
A-36P30W	1008800	MDO ONE SIDE	813591-WO	705497-WO	27.000	33.000
A-36P30W-CCA		CCA TREATED	813591-WT	705497-WT	27.000	33.000
A-36P30W-V		2 COATS CLEAR POLY VARNISH	813591-WV	705497-WV	27.000	33.000
A-24P42W		MDO ONE SIDE	813593-WO	705498-WO	21.000	39.000
A-24P42W-CCA		CCA TREATED	813593-WT	705498-WT	21.000	39.000
A-24P42W-V		2 COATS CLEAR POLY VARNISH	813593-WV	705498-WV	21.000	39.000
A-42P30W	1008802	MDO ONE SIDE	813594-WO	705499-WO	27.000	39.000
A-42P30W-CCA		CCA TREATED	813594-WT	705499-WT	27.000	39.000
A-42P30W-V		2 COATS CLEAR POLY VARNISH	813594-WV	705499-WV	27.000	39.000
A-48P24W	1097132	MDO ONE SIDE	813596-WO	705500-WO	21.000	45.000
A-48P24W-CCA		CCA TREATED	813596-WT	705500-WT	21.000	45.000
A-48P24W-V		2 COATS CLEAR POLY VARNISH	813596-WV	705500-WV	21.000	45.000
A-48P30W		MDO ONE SIDE	813597-WO	705501-WO	27.000	45.000
A-48P30W-CCA		CCA TREATED	813597-WT	705501-WT	27.000	45.000
A-48P30W-V		2 COATS CLEAR POLY VARNISH	813597-WV	705501-WV	27.000	45.000
A-30P60W		MDO ONE SIDE	813601-WO	705502-WO	27.000	57.000
A-30P60W-CCA		CCA TREATED	813601-WT	705502-WT	27.000	57.000
A-30P60W-V		2 COATS CLEAR POLY VARNISH	813601-WV	705502-WV	27.000	57.000
A-72P30W		MDO ONE SIDE	813606-WO	705503-WO	27.000	69.000
A-72P30W-CCA		CCA TREATED	813606-WT	705503-WT	27.000	69.000
A-72P30W-V		2 COATS CLEAR POLY VARNISH	813606-WV	705503-WV	27.000	69.000
A-32P36W	1006618	MDO ONE SIDE	814448-WO	705504-WO	29.000	33.000
A-32P36W-CCA		CCA TREATED	814448-WT	705504-WT	29.000	33.000
A-32P36W-V		2 COATS CLEAR POLY VARNISH	814448-WV	705504-WV	29.000	33.000
A-30P40W		MDO ONE SIDE	814452-WO	705505-WO	27.000	37.000
A-30P40W-CCA		CCA TREATED	814452-WT	705505-WT	27.000	37.000
A-30P40W-V		2 COATS CLEAR POLY VARNISH	814452-WV	705505-WV	27.000	37.000
A-30P44W		MDO ONE SIDE	814453-WO	705506-WO	27.000	41.000
A-30P44W-CCA		CCA TREATED	814453-WT	705506-WT	27.000	41.000
A-30P44W-V		2 COATS CLEAR POLY VARNISH	814453-WV	705506-WV	27.000	41.000
A-36P18W	1096002	MDO ONE SIDE	1098285 / 817839-WO	1098286 / 707916-WO	15.000	33.000
A-36P18W-CCA		CCA TREATED	817839-WT	707916-WT	15.000	33.000
A-36P18W-V		2 COATS CLEAR POLY VARNISH	817839-WV	707916-WV	15.000	33.000
A-60P32W		MDO ONE SIDE	814441-WO	708396-WO	29.000	57.000
A-60P32W-CCA		CCA TREATED	814441-WT	708396-WT	29.000	57.000
A-60P32W-V		2 COATS CLEAR POLY VARNISH	814441-WV	708396-WV	29.000	57.000

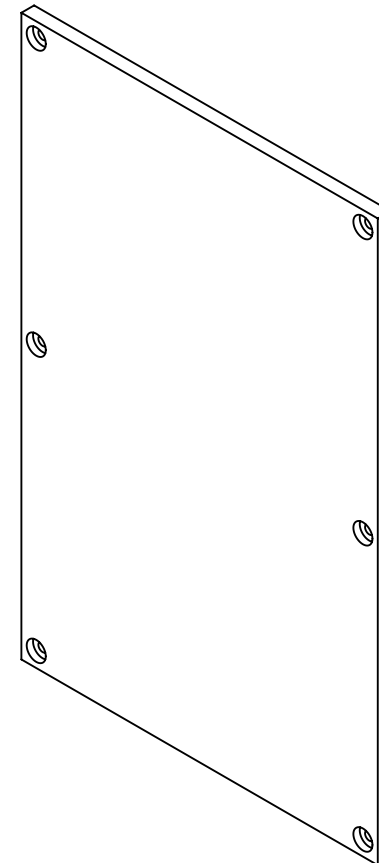

LPN: #813590-WO

E2	5-9-03	REDRAWN & REVISED DRAWING - PDR 3582	DR		
E3	8/6/12	UPDATE TO M2K (ECO #22756)	D.F.		

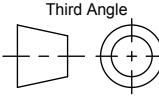
Material:	SEE CHART FOR TYPE		 General Offices: Kansas City, MO
Finish:			
Tolerances: Unless Specified Otherwise X.X ±.1 X.XX ±.03 X.XXX ±.015 X° ±2°		Third Angle  Projection	Title: PANEL, WOOD AP SERIES
			Catalog No.:
			Ref:
			Drawing No.:
			<b>1107029</b>
Scale:	NTS	Checked By:	Date:
Drawn By:		Approved By:	5-9-03 Sheet 2 of 2