

# Terminal Blocks - Single Row

## Series A3000, LP3000 & CB3000 Single Row Terminal Blocks

### SPECIFICATIONS

**Rating:** A3: 30A, 600V\* #12-22 AWG  
 LP3: 30A, 150V #12-22 AWG  
 CB3: 30A, 600V #12-22 AWG

**Wire Range:** #12-22 AWG CU

**Center Spacing:** 0.437" or 7/16" (11.10mm)

**Screw Size:** #6-32 zinc-plated phillips screws.

**Torque Rating:** 9 lb-in.

**Base:** Standoffs standard for easy flux washing.

**Distance Between Barriers:** 0.32" (8.1mm)

**Recommended PCB Hole Diameter:** 0.076" (1.93mm)

**Operating Temperature:** 105°C (221°F) max., -40°C

(-40°F) min.

**Molded Material:** Black, UL Rated 94V0 Thermoplastic

**Breakdown Voltage:** 3500V (A3 & LP3); 8200V (CB3)

**Agency Information:** UL File E62622, CSA 47235;

IEC Compliance, CE Certified

\*30A Rating achieved with a #10 copper wire crimped to a ring terminal;  
 20 Rating without ring terminal.

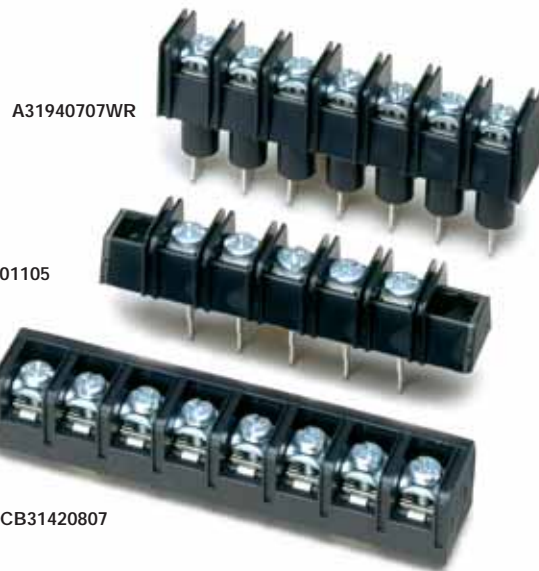

### Dimensions - in (mm)

#### A3000 & LP3000 Series

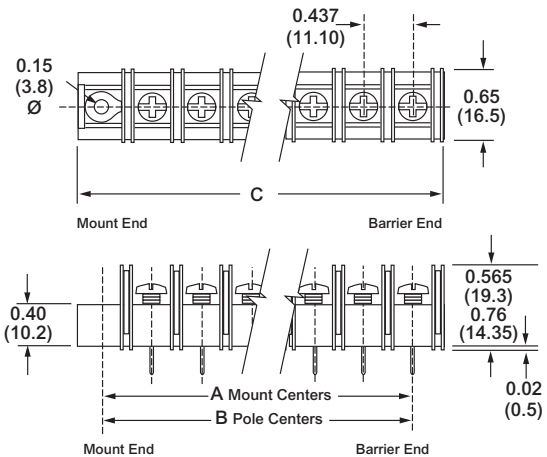

#### CB3000 Series

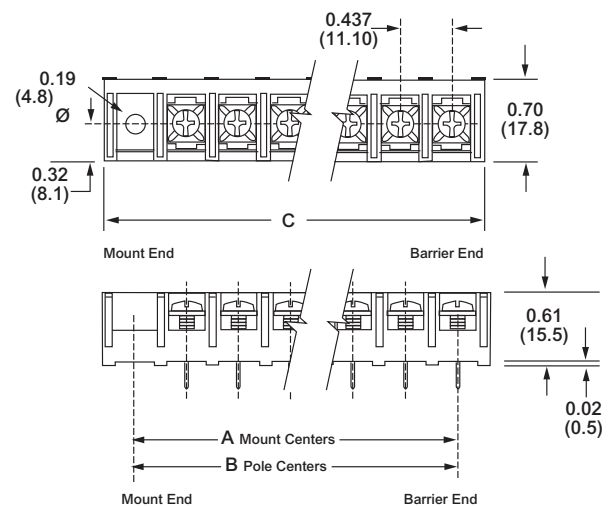

Poles	MOUNTING ENDS ONLY		BARRIER & MOUNTING ENDS B Pole Ctrs.	BARRIER ENDS ONLY C Length
	A Mount Ctrs.	C Length		
02	1.31	1.73	0.43	0.98
03	1.75	2.17	0.87	1.43
04	2.18	2.61	1.31	1.87
05	2.62	3.05	1.75	2.31
06	3.06	3.48	2.18	2.75
07	3.50	3.92	2.62	3.18
08	3.93	4.36	3.06	3.62
09	4.37	4.80	3.50	4.06
10	4.81	5.23	3.93	4.50
11	5.25	5.67	4.37	4.93
12	5.68	6.11	4.81	5.37
13	6.12	6.55	5.25	5.81
14	6.56	6.98	5.68	6.25
15	7.00	7.42	6.12	6.68
16	7.43	7.86	6.56	7.12
17	7.87	8.30	7.00	7.56
18	8.31	8.73	7.43	8.00
19	8.75	9.17	7.87	8.43
20	9.18	9.60	8.31	8.87
21	9.62	10.05	8.50	9.31
22	10.06	10.48	9.18	9.75
23	10.50	10.92	9.62	10.18
24	10.93	11.36	10.06	10.62
25	11.37	11.80	10.50	11.06
26	11.81	12.23	10.93	11.50
27	-	-	11.37	11.93
28	-	-	11.81	12.37

Dimensions in inches. To convert to millimeters, multiply by 25.4.

## Series A3000 & LP3000 Single Row Terminal Blocks

### Part Numbering System

Series	Terminal Style	Base/End (Views pg. 15)	Poles	Screw Options	Options
<b>A3</b> <b>LP3</b>					
<b>A3</b> - standard barrier <b>LP3</b> - low profile barrier	<b>01</b> - handwired <b>02</b> - printed circuit <b>03</b> - non feed-thru <b>04</b> - wire wrap tail <b>05</b> - extended handwired <b>06</b> - handwired <b>07</b> - extended pin <b>08</b> - printed circuit <b>09</b> - 0.250 QC short <b>10</b> - 0.187 QC <b>14</b> - printed circuit <b>19</b> - 0.250 QC long	<b>1</b> - flat base/mnt. end <b>2</b> - flat base/barrier end <b>3</b> - insulator base/mnt. end <b>4</b> - insulator base/barrier end <b>*5</b> - closed base/mount end	<b>02 to 28</b> <b>02 to 26</b> on mount end base	Blank - std. screw <b>00</b> - screws shipped bulk <b>03</b> - stainless steel <b>04</b> - brass nickel-plated <b>07</b> - steel SEMS zinc-plated (not available with hardware options) <b>09</b> - brass SEMS nickel-plated (not available with hardware options) <b>07WR</b> - steel SEMS wire ready (A3 only) <b>CA</b> - captive screw	<b>AB</b> - angle mnt. options (pg 15) <b>A1 to A9</b> - 0.250" QC <b>B1 to B9</b> - 0.187" QC <b>DR</b> - drilled right angle (pg 15) <b>†J201</b> - flat slip-on jumper <b>L1 to L6</b> marking options (pg 22) <b>MP, MP8 &amp; MT</b> mounting plates (pg 15) <b>†OJ3, OJ5 &amp; OJ7</b> - over barrier jumpers <b>RC</b> - retaining clips (pg 15) <b>R30 to R77</b> - right angle bends (pg 15) <b>SO</b> - stand off insulators (pg 15) <b>S1</b> - solder lug/flat

\*Base/End Note: 5 Style only available with 03 terminals.

ready (A3 only)

†Contact factory for configuration.

### Terminal Styles

Inches (Millimeters)

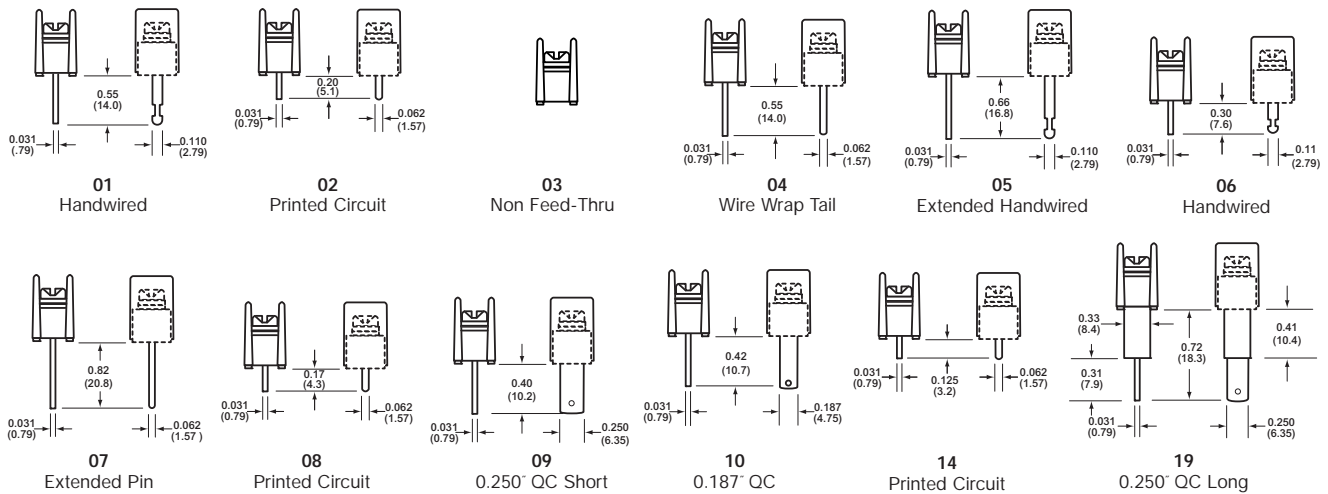

### Screw Options

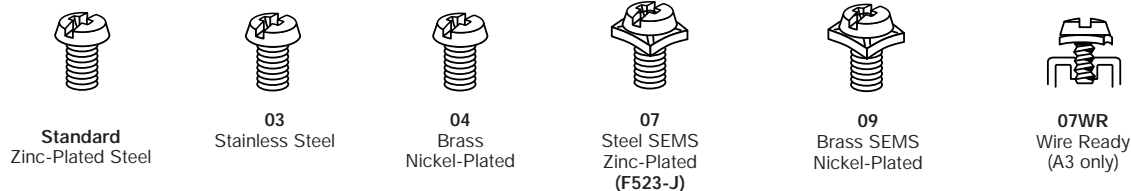

# Terminal Blocks - Single Row

## Series A3000 & LP3000 Single Row Terminal Blocks *Continued*

### Hardware Options (Bulk ordering part numbers are in parentheses.)

Inches (Millimeters)

#### Solder Lugs

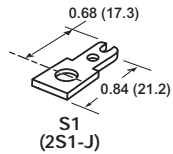

#### Jumpers

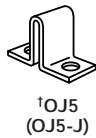
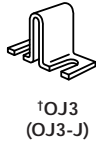

#### Quick Connects

Blade Width A = 0.250" Blade Width B = 0.187"

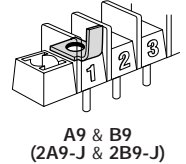
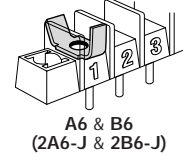
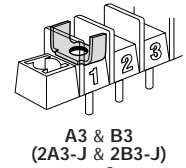
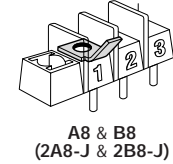
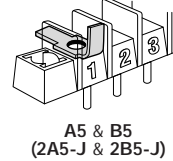
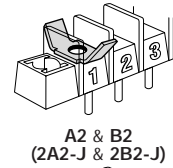
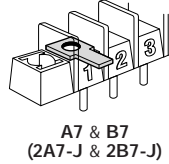
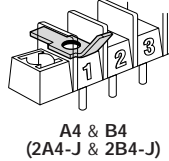
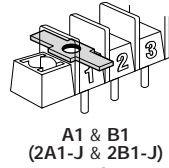

†Contact factory for pole configuration.

### Base/End Options

Inches (Millimeters)

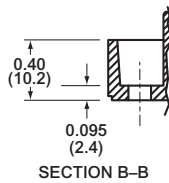
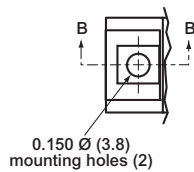

1, 3 & 5 Mount End

## Series A3000 & LP3000 Single Row Terminal Blocks *Continued*

### Mounting Options

Inches (Millimeters)

#### Right Angle Bends (A3, LP3 only)

Right angle terminals are offered on the A3000 & LP3000 Series. Configurations are defined in these dimensions: X = pin extension beyond the block base; Z = length from block base to centerline of the terminal tip. Standard bends consist of the X and Z dimensions shown in the chart. Specify by adding the selected Bend Option Code to the terminal part number.

#### 04 Terminal Bend Configurations

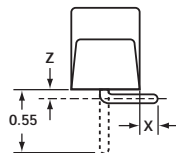

Bend Option Code	X (minimum)	Z	Available w/insulator base
R30	0.04	0.28	No
R35	0.01	0.23	No
R36	0.02	0.22	No
R39	0.05	0.19	No
R42	0.08	0.16	No
R46	0.12	0.12	No
R48	0.14	0.10	No
R50	0.16	0.08	No

#### 07 Terminal Bend Configurations

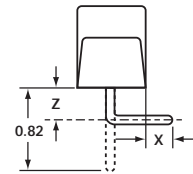

Bend Option Code	X (minimum)	Z	Available w/insulator base
R30	0.04	0.55	Yes
R35	0.01	0.50	Yes
R36	0.02	0.49	Yes
R50	0.16	0.35	No
R53	0.19	0.32	No
R66	0.32	0.19	No
R69	0.35	0.16	No
R75	0.41	0.10	No
R77	0.43	0.08	No

Dimensions in inches. To convert to millimeters, multiply by 25.4.

#### Angle Brackets (A3, LP3 only)

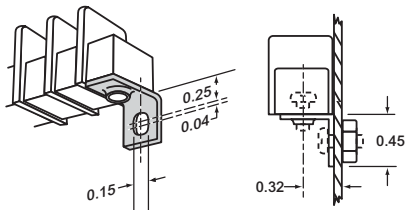

#### Option AB

Angle brackets enable block to be fastened at right angles to normal mount position. Bulk part number **2AB-J**.

#### Drilled Right Angle (A3, LP3 only)

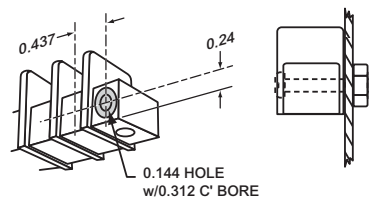

#### Option DR

Counterbored holes across mount ends of block enable fastening with two screws at right angles to normal mount position.

#### Mounting Plates

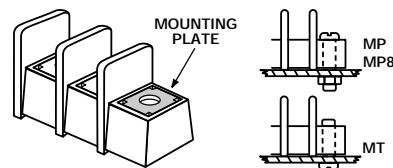

#### Options MP, MP8 & MT

MP Metal inserts with 0.150" dia. hole accept #6 screw. MP8 Metal inserts with 0.187" dia. hole accept #8-32 screw. MT Metal inserts with tapped hole accept #6-32 screw.

#### Standoffs

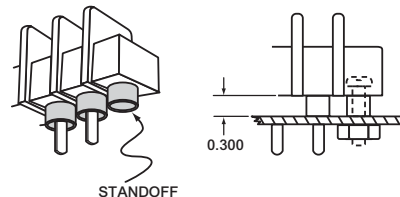

#### Option SO

Standoff mounts are tubes molded to the mounting positions. Available with insulator bases only.

#### Retaining Clip

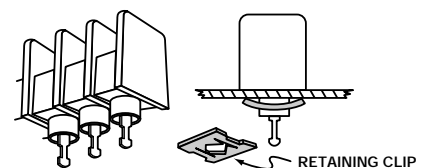

#### Option RC

Use on standoff tubes. Fit panels up to 0.125" thick. Two clips for every five positions. Supplied unassembled. Bulk part number **H541-J**.

# Terminal Blocks - Single Row

## Series CB3000

### Single Row Terminal Blocks

#### Part Numbering System

Series	Terminal Style	Base/End	Poles	Screws	Options
<b>CB3</b>					
<b>CB3</b> - closed back	<b>01</b> - handwired #6-32 screw <b>02</b> - printed circuit #6-32 screw <b>03</b> - non feed-thru #6-32 screw <b>07</b> - extended pin #6-32 screw <b>14</b> - printed circuit #6-32 screw <b>51</b> - handwired #8-32* <b>52</b> - printed circuit #8-32* <b>53</b> - non feed-thru #8-32* <b>57</b> - extended pin #8-32* <b>64</b> - printed circuit #8-32* *Note: #8-32 screw is a special with #6-32 head.	<b>1</b> - mount end <b>2</b> - barrier end <b>5</b> - closed base/mount end	<b>02 to 28</b> <b>02 to 26</b> on mount end base	<b>07</b> - steel SEMS (standard) <b>09</b> - brass SEMS nickel-plated <b>CA</b> - SEMS captive	<b>AB</b> - angle mounting brackets (pg 17) <b>A7 to A9</b> - 0.250" QC <b>B7 to B9</b> - 0.187" QC <b>EB</b> - exit back terminals <b>L1 to L6</b> marking options (pg 22) <b>LT1 to LT6</b> marking options (pg 22) † <b>OJ3 &amp; OJ7</b> - over barrier jumpers <b>MP, MP8, MT &amp; MT8</b> mtg. plates (pg 17) <b>S1</b> - solder lug/flat <b>Covers</b> - (pg 23)
		Base/End Note: 5 Style only available with 03 terminals.			†Contact factory for configuration.

#### Terminal Styles

Inches (Millimeters)

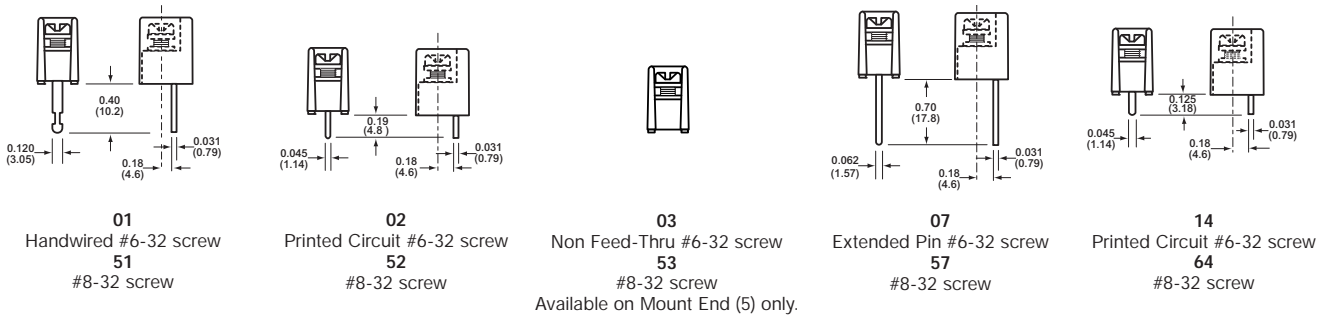

#### Screw Options



**07**  
Steel SEMS  
Zinc-Plated  
(standard)



**09**  
Brass SEMS  
Nickel-Plated

\* NOTE: Wire ready screws standard on all terminal styles.

#### CB3 Terminal Exit Options

Inches (Millimeters)

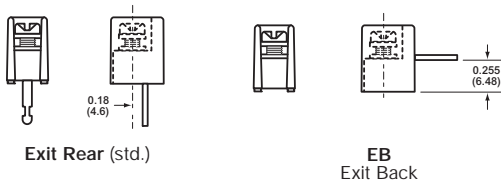

## Series CB3000

### Single Row Terminal Blocks *Continued*

## Hardware Options (Bulk ordering part numbers are in parentheses.) Inches (Millimeters)

### Solder Lugs

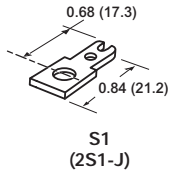

### Jumpers

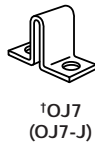
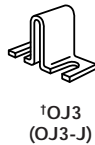

### Quick Connects

Blade Width A = 0.250". Blade Width B = 0.187".

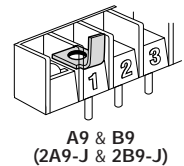
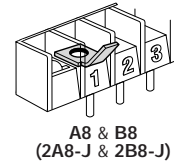
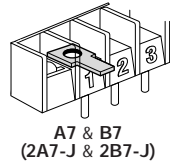

<sup>†</sup>Contact factory for pole configuration.

## Mounting Options Inches (Millimeters)

### Right Angle Mounting Bracket

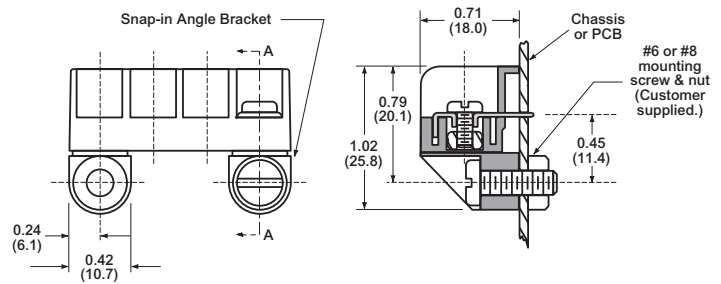
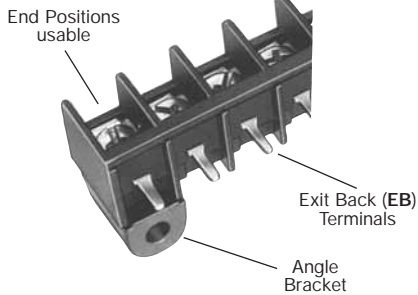

Option AB

Mounts blocks on PC boards at a right angle.

- Protects solder joints.
- Recommended for all EB (Exit Back) PCB terminal blocks.
- Bracket snaps securely on block (no hardware required).
- Minimum strip length (end positions are usable).
- Mount with #6-32 or #8-32 screws (not supplied).

### Mounting Plates

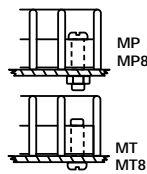
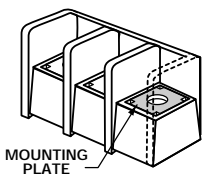

#### Options MP, MP8, MT & MT8

- MP Metal inserts with 0.150" dia. hole accept #6 screw.
- MP8 Metal inserts with 0.187" dia. hole accept #8-32 screw.
- MT Metal inserts with tapped hole accept #6-32 screw.
- MT8 Metal inserts with tapped hole accept #8-32 screw.

# Terminal Blocks - Single Row

## Series A38 / B38

### Single Row Terminal Blocks

#### SPECIFICATIONS

Rating: A38: 30A, 600V

B38: 50A, 300V

Center Spacing: 0.437" (11.10mm)

Wire Range: A38: #10-22 AWG CU; B38: #8-16 AWG

Screw Size: #8-32 zinc-plated steel

Torque Rating: A38: 9 lb-in; B38: 15 lb-in for #8, 9 lb-in for #6

Base: A38 Only: Standoffs standard for easy flux washing

Distance Between Barriers: 0.378" (9.60mm)

Recommended PCB Hole Diameter (A38): 0.076" (1.93mm)

Operating Temperature: 221°F (105°C)

Molded Material: Black, UL Rated 94V0 Thermoplastic

Breakdown Voltage: 5000V

Agency Information: UL File E62622, CSA File 47235;

CE Certified



A382208



B384904

TABLE A

Poles	MOUNTING ENDS ONLY		BARRIER ENDS ONLY
	B Mount Ctrs.	"A" Dim. Length	"A" Dim. Length
02	1.31	1.67	0.93
03	1.75	2.10	1.37
04	2.19	2.54	1.81
05	2.62	2.98	2.25
06	3.06	3.41	2.68
07	3.50	3.85	3.12
08	3.93	4.29	3.56
09	4.37	4.72	3.99
10	4.81	5.16	4.43
11	5.24	5.60	4.87
12	5.68	6.04	5.30
13	6.12	6.47	5.74
14	6.56	6.91	6.18
15	6.99	7.35	6.61
16	7.43	7.78	7.05

\* Dimensions in inches. To convert to millimeters, multiply by 25.4.

#### Dimensions - in (mm)

##### Series A38

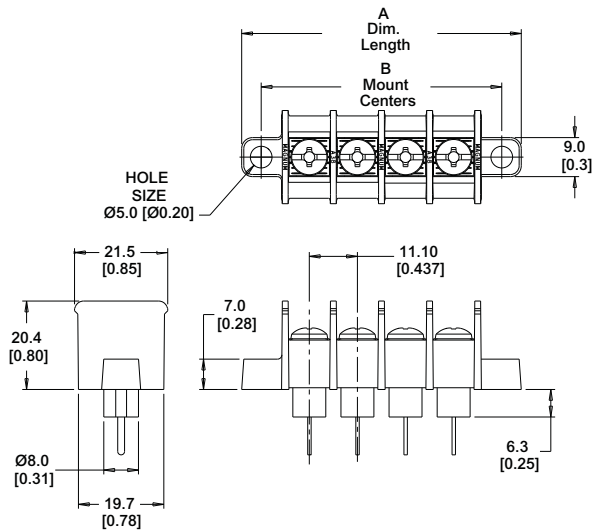

##### Series B38

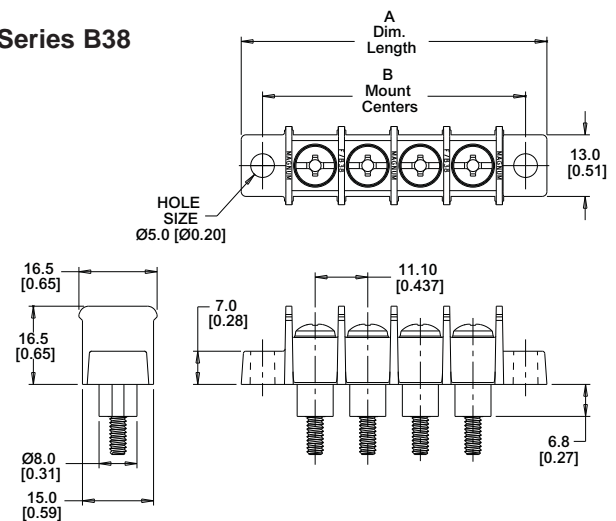

## Part Numbering System

Series	Terminal Style	Base/End	# of Poles	Screw Options	Options
<b>A3B</b>					
	0 - 0.187" QC 1 - hand wired 2 - printed circuit 7 - extended wire wrap 9 - 0.250" QC	1 - flat base, mount end 2 - flat base, barrier end 3 - insulator base* mount end 4 - insulator base* barrier end  *N/A on 2 terminal style.	02 to 16	Blank - standard screw (steel zinc-plated, philslot BHMS) 04 - brass, nickel-plated, philslot BHMS 07 - steel, SEMS zinc-plated philslot screw 92 - steel, zinc-plated slotted BHMS 94 - brass, nickel-plated slotted BHMS (Binding Hard Machine Screw)	L1 to L6 marking options (pg 22) RC - retaining clips (pg 15) Covers - (pg 23)
<b>B3B</b>					
	1 - long turret 2 - short turret 3 - screw terminal #6-32 screw top & bottom 4 - stud (#8-32 screw top, #6-32 stud bottom) 15 - double stud (#6-32 stud top & bottom) 1C360 Copper alloy (bright tin plate)	0 - flat base, mount ends 4 - insulator base, barrier ends 9 - insulator base mount ends	02 to 16	Blank - standard screw steel zinc-plated philslot BHMS 04 - brass, nickel-plated, philslot BHMS #8-32 *34 - #6-32 nickel-plated brass philslot BHMS  *Note: 34 screws only *available with 3 terminal style.	L1 to L6 marking options (pg 23) RC - retaining clips (pg 16)

## A38 Terminal Styles Wire ready screws standard

Inches (Millimeters)

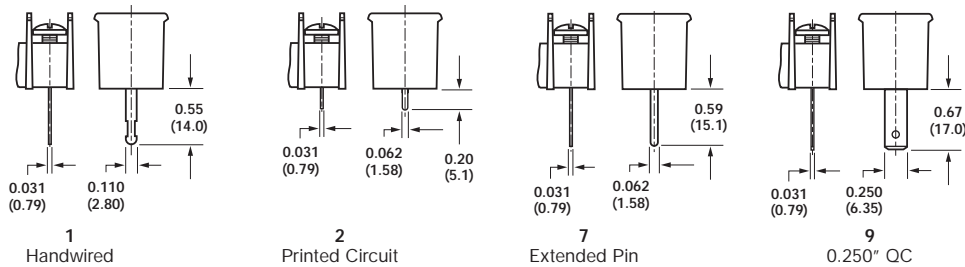

## B38 Terminal Styles

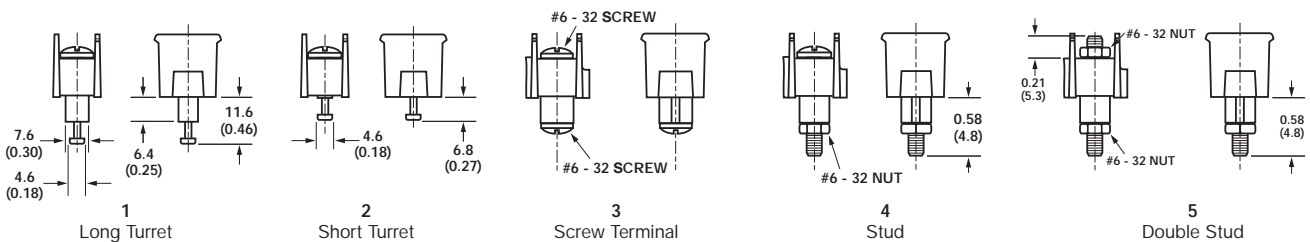

## Screw Options





# Terminal Blocks - Single Row

## Series A3000, LP3000 & CB3000 Single Row Terminal Blocks

### SPECIFICATIONS

**Rating:** A3: 30A, 600V\* #12-22 AWG  
 LP3: 30A, 150V #12-22 AWG  
 CB3: 30A, 600V #12-22 AWG

**Wire Range:** #12-22 AWG CU

**Center Spacing:** 0.437" or 7/16" (11.10mm)

**Screw Size:** #6-32 zinc-plated phillips screws.

**Torque Rating:** 9 lb-in.

**Base:** Standoffs standard for easy flux washing.

**Distance Between Barriers:** 0.32" (8.1mm)

**Recommended PCB Hole Diameter:** 0.076" (1.93mm)

**Operating Temperature:** 105°C (221°F) max., -40°C

(-40°F) min.

**Molded Material:** Black, UL Rated 94V0 Thermoplastic

**Breakdown Voltage:** 3500V (A3 & LP3); 8200V (CB3)

**Agency Information:** UL File E62622, CSA 47235;

IEC Compliance, CE Certified

\*30A Rating achieved with a #10 copper wire crimped to a ring terminal;  
 20 Rating without ring terminal.

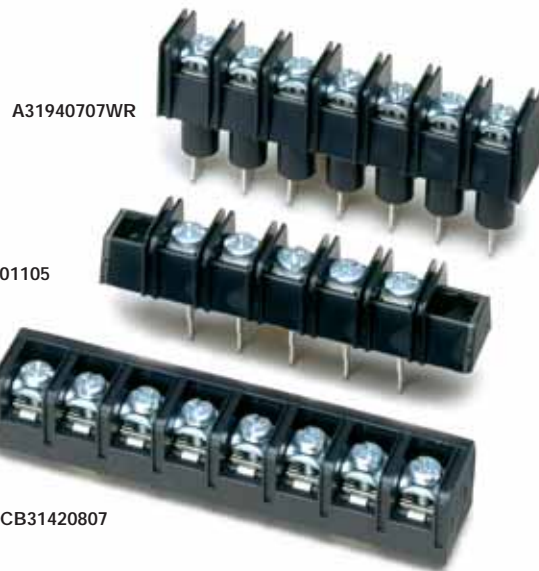

### Dimensions - in (mm)

#### A3000 & LP3000 Series

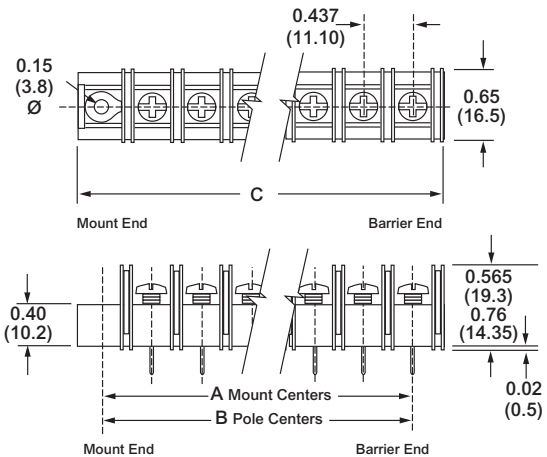

#### CB3000 Series

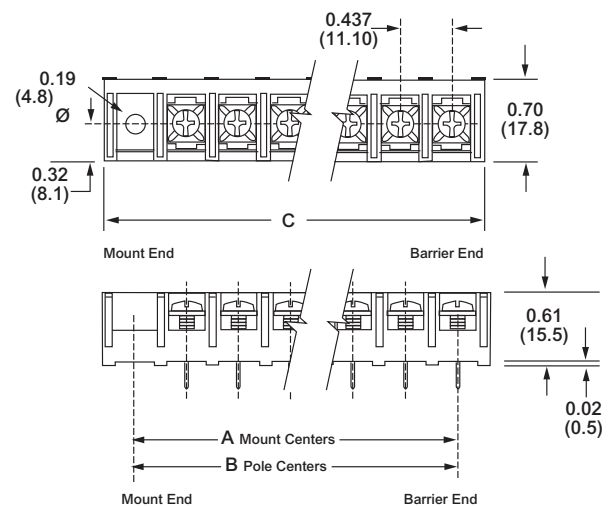

Poles	MOUNTING ENDS ONLY		BARRIER & MOUNTING ENDS B Pole Ctrs.	BARRIER ENDS ONLY C Length
	A Mount Ctrs.	C Length		
02	1.31	1.73	0.43	0.98
03	1.75	2.17	0.87	1.43
04	2.18	2.61	1.31	1.87
05	2.62	3.05	1.75	2.31
06	3.06	3.48	2.18	2.75
07	3.50	3.92	2.62	3.18
08	3.93	4.36	3.06	3.62
09	4.37	4.80	3.50	4.06
10	4.81	5.23	3.93	4.50
11	5.25	5.67	4.37	4.93
12	5.68	6.11	4.81	5.37
13	6.12	6.55	5.25	5.81
14	6.56	6.98	5.68	6.25
15	7.00	7.42	6.12	6.68
16	7.43	7.86	6.56	7.12
17	7.87	8.30	7.00	7.56
18	8.31	8.73	7.43	8.00
19	8.75	9.17	7.87	8.43
20	9.18	9.60	8.31	8.87
21	9.62	10.05	8.50	9.31
22	10.06	10.48	9.18	9.75
23	10.50	10.92	9.62	10.18
24	10.93	11.36	10.06	10.62
25	11.37	11.80	10.50	11.06
26	11.81	12.23	10.93	11.50
27	-	-	11.37	11.93
28	-	-	11.81	12.37

Dimensions in inches. To convert to millimeters, multiply by 25.4.

## Series A3000 & LP3000 Single Row Terminal Blocks

### Part Numbering System

Series	Terminal Style	Base/End (Views pg. 15)	Poles	Screw Options	Options
<b>A3</b> <b>LP3</b>					
<b>A3</b> - standard barrier <b>LP3</b> - low profile barrier	<b>01</b> - handwired <b>02</b> - printed circuit <b>03</b> - non feed-thru <b>04</b> - wire wrap tail <b>05</b> - extended handwired <b>06</b> - handwired <b>07</b> - extended pin <b>08</b> - printed circuit <b>09</b> - 0.250 QC short <b>10</b> - 0.187 QC <b>14</b> - printed circuit <b>19</b> - 0.250 QC long	<b>1</b> - flat base/mnt. end <b>2</b> - flat base/barrier end <b>3</b> - insulator base/mnt. end <b>4</b> - insulator base/barrier end <b>*5</b> - closed base/mount end	<b>02 to 28</b> <b>02 to 26</b> on mount end base	Blank - std. screw <b>00</b> - screws shipped bulk <b>03</b> - stainless steel <b>04</b> - brass nickel-plated <b>07</b> - steel SEMS zinc-plated (not available with hardware options) <b>09</b> - brass SEMS nickel-plated (not available with hardware options) <b>07WR</b> - steel SEMS wire ready (A3 only) <b>CA</b> - captive screw	<b>AB</b> - angle mnt. options (pg 15) <b>A1 to A9</b> - 0.250" QC <b>B1 to B9</b> - 0.187" QC <b>DR</b> - drilled right angle (pg 15) <b>†J201</b> - flat slip-on jumper <b>L1 to L6</b> marking options (pg 22) <b>MP, MP8 &amp; MT</b> mounting plates (pg 15) <b>†OJ3, OJ5 &amp; OJ7</b> - over barrier jumpers <b>RC</b> - retaining clips (pg 15) <b>R30 to R77</b> - right angle bends (pg 15) <b>SO</b> - stand off insulators (pg 15) <b>S1</b> - solder lug/flat

\*Base/End Note: 5 Style only available with 03 terminals.

ready (A3 only)

†Contact factory for configuration.

### Terminal Styles

Inches (Millimeters)

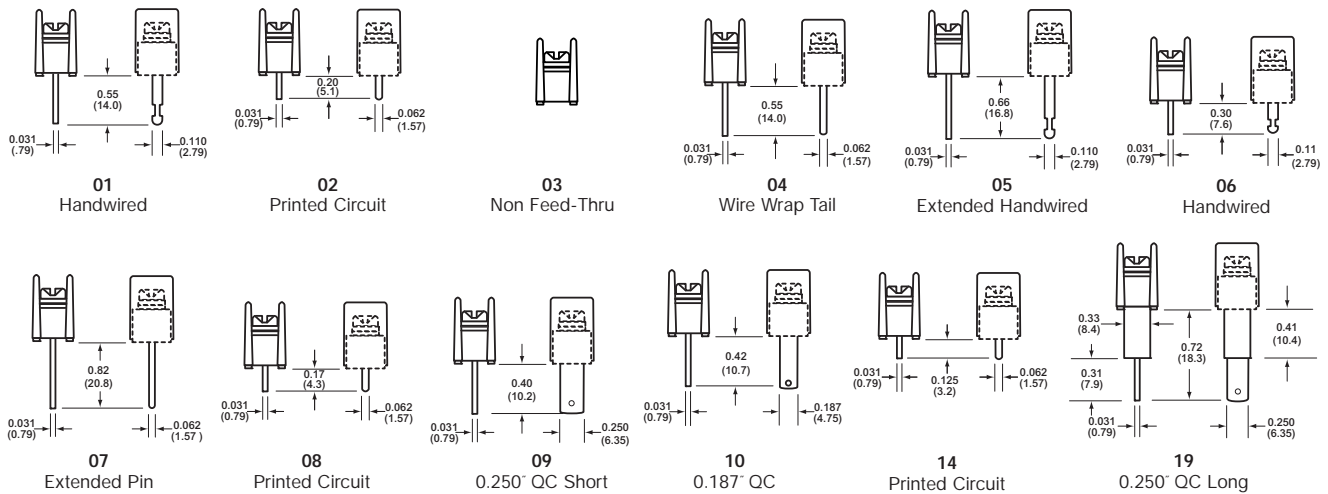

### Screw Options

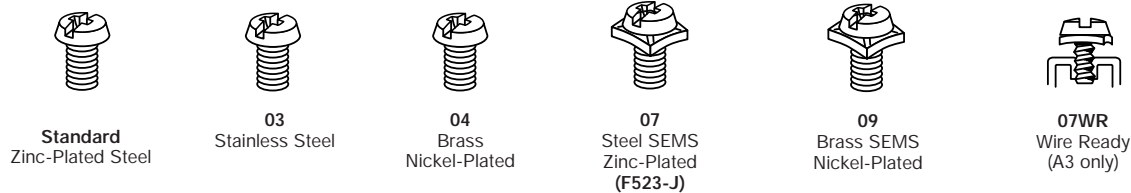

# Terminal Blocks - Single Row

## Series A3000 & LP3000 Single Row Terminal Blocks *Continued*

### Hardware Options (Bulk ordering part numbers are in parentheses.)

Inches (Millimeters)

#### Solder Lugs

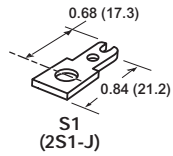

#### Jumpers

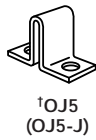
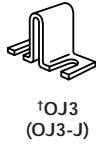

#### Quick Connects

Blade Width A = 0.250" Blade Width B = 0.187"

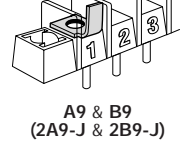
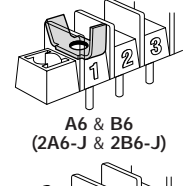
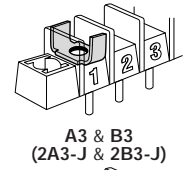
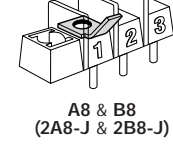
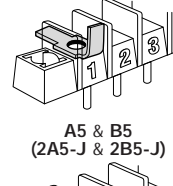
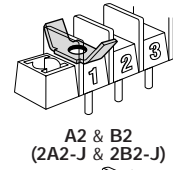
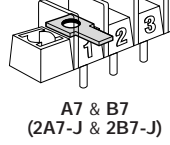
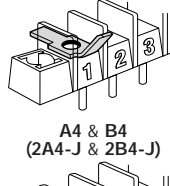
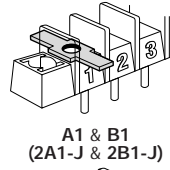

†Contact factory for pole configuration.

### Base/End Options

Inches (Millimeters)

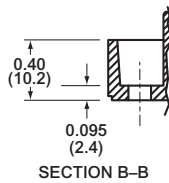
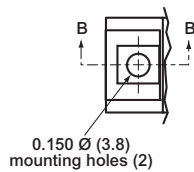

1, 3 & 5 Mount End

## Series A3000 & LP3000 Single Row Terminal Blocks *Continued*

### Mounting Options

Inches (Millimeters)

#### Right Angle Bends (A3, LP3 only)

Right angle terminals are offered on the A3000 & LP3000 Series. Configurations are defined in these dimensions: X = pin extension beyond the block base; Z = length from block base to centerline of the terminal tip. Standard bends consist of the X and Z dimensions shown in the chart. Specify by adding the selected Bend Option Code to the terminal part number.

#### 04 Terminal Bend Configurations

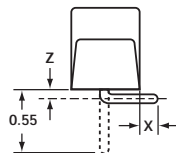

Bend Option Code	X (minimum)	Z	Available w/insulator base
R30	0.04	0.28	No
R35	0.01	0.23	No
R36	0.02	0.22	No
R39	0.05	0.19	No
R42	0.08	0.16	No
R46	0.12	0.12	No
R48	0.14	0.10	No
R50	0.16	0.08	No

#### 07 Terminal Bend Configurations

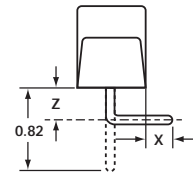

Bend Option Code	X (minimum)	Z	Available w/insulator base
R30	0.04	0.55	Yes
R35	0.01	0.50	Yes
R36	0.02	0.49	Yes
R50	0.16	0.35	No
R53	0.19	0.32	No
R66	0.32	0.19	No
R69	0.35	0.16	No
R75	0.41	0.10	No
R77	0.43	0.08	No

Dimensions in inches. To convert to millimeters, multiply by 25.4.

#### Angle Brackets (A3, LP3 only)

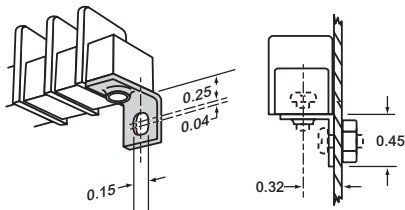

#### Option AB

Angle brackets enable block to be fastened at right angles to normal mount position. Bulk part number **2AB-J**.

#### Drilled Right Angle (A3, LP3 only)

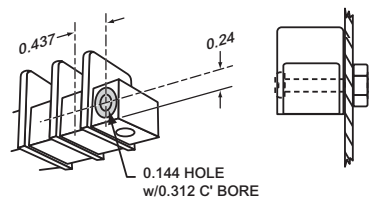

#### Option DR

Counterbored holes across mount ends of block enable fastening with two screws at right angles to normal mount position.

#### Mounting Plates

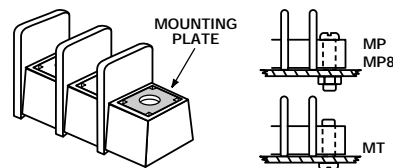

#### Options MP, MP8 & MT

MP Metal inserts with 0.150" dia. hole accept #6 screw. MP8 Metal inserts with 0.187" dia. hole accept #8-32 screw. MT Metal inserts with tapped hole accept #6-32 screw.

#### Standoffs

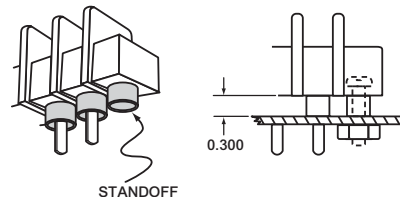

#### Option SO

Standoff mounts are tubes molded to the mounting positions. Available with insulator bases only.

#### Retaining Clip

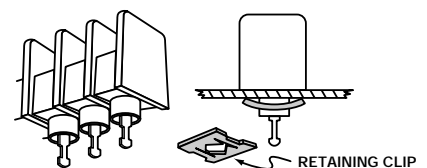

#### Option RC

Use on standoff tubes. Fit panels up to 0.125" thick. Two clips for every five positions. Supplied unassembled. Bulk part number **H541-J**.

# Terminal Blocks - Single Row

## Series CB3000

### Single Row Terminal Blocks

#### Part Numbering System

Series	Terminal Style	Base/End	Poles	Screws	Options
<b>CB3</b>					
<b>CB3</b> - closed back	<b>01</b> - handwired #6-32 screw <b>02</b> - printed circuit #6-32 screw <b>03</b> - non feed-thru #6-32 screw <b>07</b> - extended pin #6-32 screw <b>14</b> - printed circuit #6-32 screw <b>51</b> - handwired #8-32* <b>52</b> - printed circuit #8-32* <b>53</b> - non feed-thru #8-32* <b>57</b> - extended pin #8-32* <b>64</b> - printed circuit #8-32* *Note: #8-32 screw is a special with #6-32 head.	<b>1</b> - mount end <b>2</b> - barrier end <b>5</b> - closed base/ mount end	<b>02 to 28</b> <b>02 to 26</b> on mount end base	<b>07</b> - steel SEMS (standard) <b>09</b> - brass SEMS nickel-plated <b>CA</b> - SEMS captive	<b>AB</b> - angle mounting brackets (pg 17) <b>A7 to A9</b> - 0.250" QC <b>B7 to B9</b> - 0.187" QC <b>EB</b> - exit back terminals <b>L1 to L6</b> marking options (pg 22) <b>LT1 to LT6</b> marking options (pg 22) † <b>OJ3 &amp; OJ7</b> - over barrier jumpers <b>MP, MP8, MT &amp; MT8</b> mtg. plates (pg 17) <b>S1</b> - solder lug/flat <b>Covers</b> - (pg 23)
		Base/End Note: 5 Style only available with 03 terminals.			†Contact factory for configuration.

#### Terminal Styles

Inches (Millimeters)

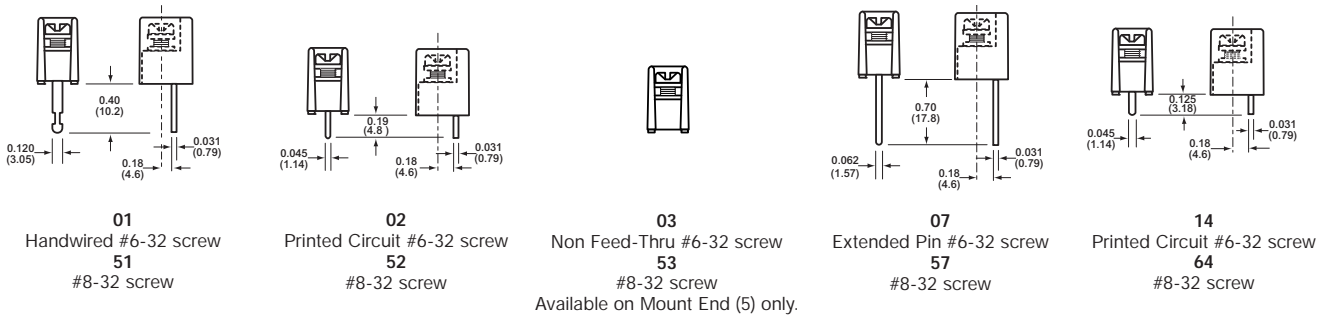

#### Screw Options



**07**  
Steel SEMS  
Zinc-Plated  
(standard)



**09**  
Brass SEMS  
Nickel-Plated

\* NOTE: Wire ready screws standard on all terminal styles.

#### CB3 Terminal Exit Options

Inches (Millimeters)

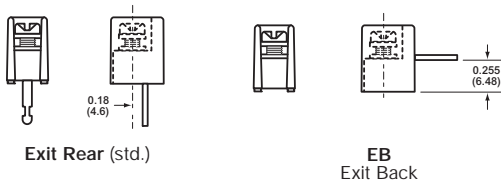

## Series CB3000

### Single Row Terminal Blocks *Continued*

## Hardware Options (Bulk ordering part numbers are in parentheses.) Inches (Millimeters)

### Solder Lugs

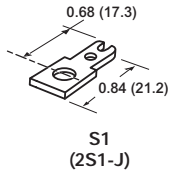

### Jumpers

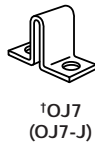
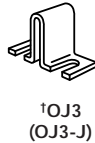

### Quick Connects

Blade Width A = 0.250". Blade Width B = 0.187".

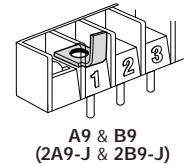
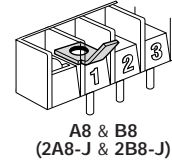
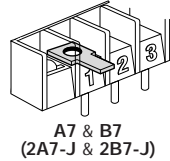

<sup>†</sup>Contact factory for pole configuration.

## Mounting Options Inches (Millimeters)

### Right Angle Mounting Bracket

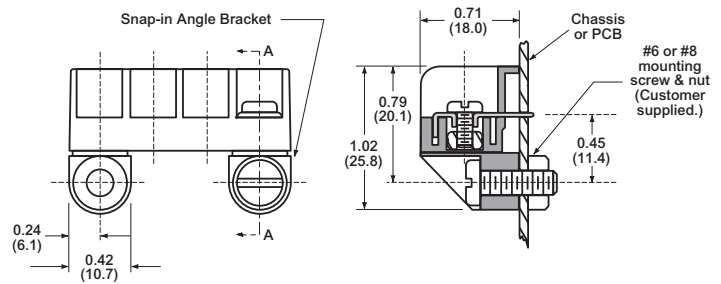
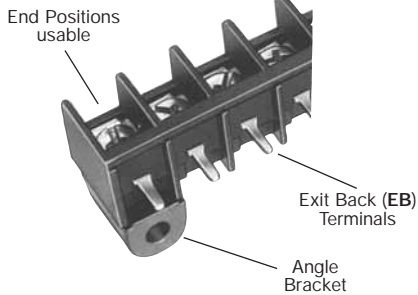

**Option AB**

Mounts blocks on PC boards at a right angle.

- Protects solder joints.
- Recommended for all EB (Exit Back) PCB terminal blocks.
- Bracket snaps securely on block (no hardware required).
- Minimum strip length (end positions are usable).
- Mount with #6-32 or #8-32 screws (not supplied).

### Mounting Plates

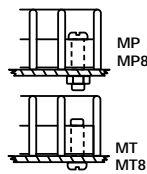
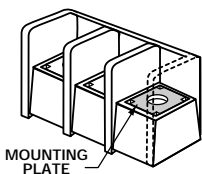

#### Options MP, MP8, MT & MT8

- MP Metal inserts with 0.150" dia. hole accept #6 screw.
- MP8 Metal inserts with 0.187" dia. hole accept #8-32 screw.
- MT Metal inserts with tapped hole accept #6-32 screw.
- MT8 Metal inserts with tapped hole accept #8-32 screw.

# Terminal Blocks - Single Row

## Series A38 / B38

### Single Row Terminal Blocks

#### SPECIFICATIONS

Rating: A38: 30A, 600V

B38: 50A, 300V

Center Spacing: 0.437" (11.10mm)

Wire Range: A38: #10-22 AWG CU; B38: #8-16 AWG

Screw Size: #8-32 zinc-plated steel

Torque Rating: A38: 9 lb-in; B38: 15 lb-in for #8, 9 lb-in for #6

Base: A38 Only: Standoffs standard for easy flux washing

Distance Between Barriers: 0.378" (9.60mm)

Recommended PCB Hole Diameter (A38): 0.076" (1.93mm)

Operating Temperature: 221°F (105°C)

Molded Material: Black, UL Rated 94V0 Thermoplastic

Breakdown Voltage: 5000V

Agency Information: UL File E62622, CSA File 47235;

CE Certified



A382208



B384904

TABLE A

Poles	MOUNTING ENDS ONLY		BARRIER ENDS ONLY
	B Mount Ctrs.	"A" Dim. Length	"A" Dim. Length
02	1.31	1.67	0.93
03	1.75	2.10	1.37
04	2.19	2.54	1.81
05	2.62	2.98	2.25
06	3.06	3.41	2.68
07	3.50	3.85	3.12
08	3.93	4.29	3.56
09	4.37	4.72	3.99
10	4.81	5.16	4.43
11	5.24	5.60	4.87
12	5.68	6.04	5.30
13	6.12	6.47	5.74
14	6.56	6.91	6.18
15	6.99	7.35	6.61
16	7.43	7.78	7.05

\* Dimensions in inches. To convert to millimeters, multiply by 25.4.

### Dimensions - in (mm)

#### Series A38

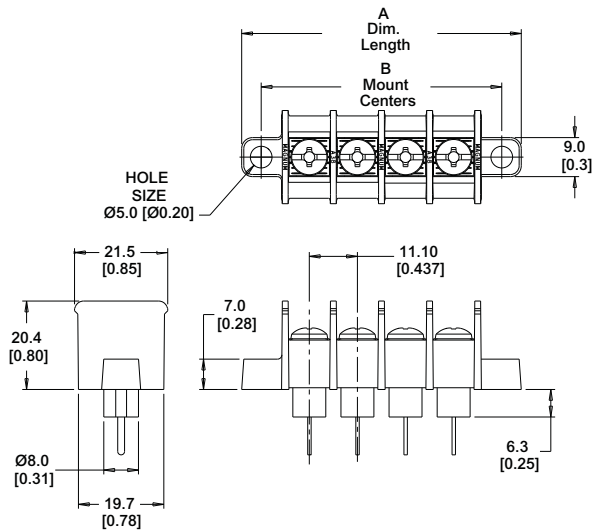

#### Series B38

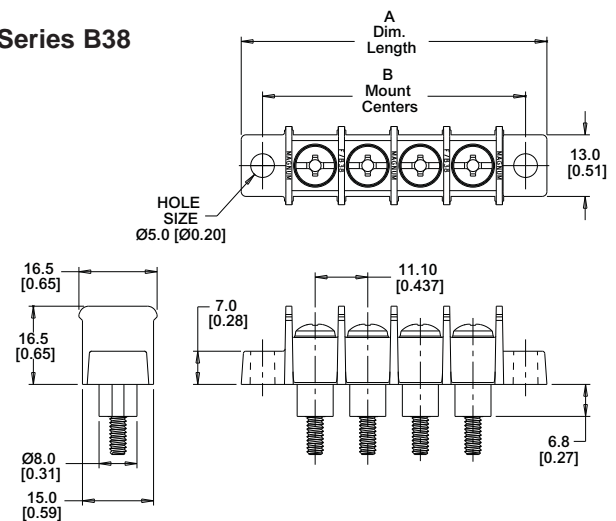

## Part Numbering System

Series	Terminal Style	Base/End	# of Poles	Screw Options	Options
<b>A3B</b>					
	0 - 0.187" QC 1 - hand wired 2 - printed circuit 7 - extended wire wrap 9 - 0.250" QC	1 - flat base, mount end 2 - flat base, barrier end 3 - insulator base* mount end 4 - insulator base* barrier end  *N/A on 2 terminal style.	02 to 16	Blank - standard screw (steel zinc-plated, philslot BHMS) 04 - brass, nickel-plated, philslot BHMS 07 - steel, SEMS zinc-plated philslot screw 92 - steel, zinc-plated slotted BHMS 94 - brass, nickel-plated slotted BHMS (Binding Hard Machine Screw)	L1 to L6 marking options (pg 22) RC - retaining clips (pg 15) Covers - (pg 23)
<b>B3B</b>					
	1 - long turret 2 - short turret 3 - screw terminal #6-32 screw top & bottom 4 - stud (#8-32 screw top, #6-32 stud bottom) 15 - double stud (#6-32 stud top & bottom) 1C360 Copper alloy (bright tin plate)	0 - flat base, mount ends 4 - insulator base, barrier ends 9 - insulator base mount ends	02 to 16	Blank - standard screw steel zinc-plated philslot BHMS 04 - brass, nickel-plated, philslot BHMS #8-32 *34 - #6-32 nickel-plated brass philslot BHMS  *Note: 34 screws only *available with 3 terminal style.	L1 to L6 marking options (pg 23) RC - retaining clips (pg 16)

## A38 Terminal Styles Wire ready screws standard

Inches (Millimeters)

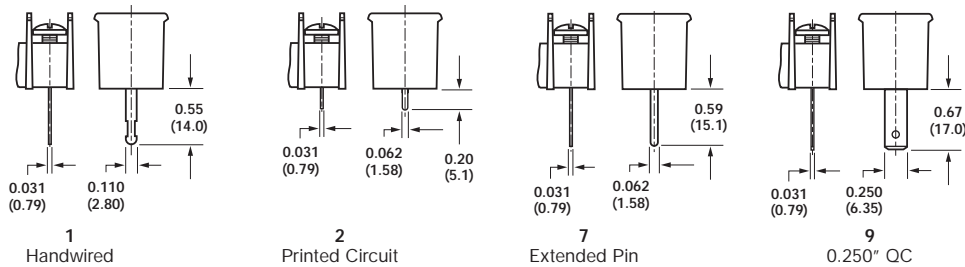

## B38 Terminal Styles

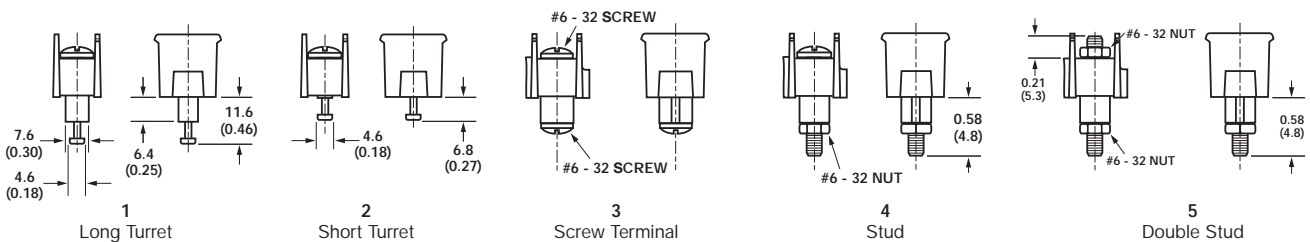

## Screw Options

