

Series 1 Steel - Accessories

Standard (L-Shaped) Splice Plates

- One pair including hardware provided with each section. (Expansion splice quantity subtracted)
- Furnished in pairs with hardware.
- Prepackaged in pairs in a plastic bag, with hardware.
- 4-hole pattern L-shaped splice plates.
- L-shaped lay-in design.
- (*) Insert **ZN** or **G**

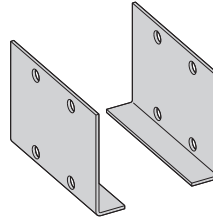

Tray Series	Catalog No.
148	9(*)-4004
156	9(*)-4005
166	9(*)-4006
176	9(*)-4007

Expansion (L-Shaped) Splice Plates

- Expansion plates allow for one inch expansion or contraction of the cable tray, or where expansion joints occur in the supporting structure.
- Bonding Jumpers are required on each side rail. Order Separately.
- L-shaped lay-in design.
- Furnished in pairs with hardware.
- (*) Insert **ZN** or **G**

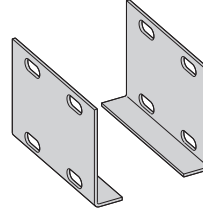

Tray Series	Catalog No.
148	9(*)-4014
156	9(*)-4015
166	9(*)-4016
176	9(*)-4017

Universal Splice Plates

- Used to splice to existing cable tray systems.
- Furnished in pairs with hardware.
- (*) Insert **P** or **G**

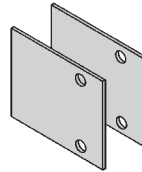

Tray Series	Catalog No.
148	9(*)-2004-1/2
156	9(*)-2005-1/2
166	9(*)-2006-1/2
176	9(*)-2007-1/2

Step Down Splice Plates

- These splice plates are offered for connecting cable tray sections having side rails of different heights.
- Furnished in pairs with hardware.
- (*) Insert **ZN** or **G**

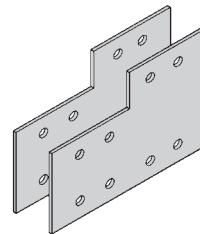

Tray Series	Catalog No.
156 to 148	9(*)-8044
166 to 156 or 148	9(*)-8045
176 to 156 or 148	9(*)-8046
176 to 166	9(*)-8060

Vertical Adjustable Splice Plates

- These plates provide for changes in elevation that do not conform to standard vertical fittings.
- Bonding jumpers not required.
- Furnished in pairs with hardware.
- (*) Insert **ZN** or **G**
- (***) Insert **P** or **G**

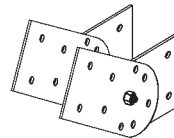

Requires supports within 24" on both sides, per NEMA VE 2.

Tray Series	Catalog No.
148	9(**)-7024
156	9(*)-8024
166	9(*)-8025
176	9(*)-8026

Horizontal Adjustable Splice Plates

- Offered to adjust a cable tray run for changes in direction in a horizontal plane that do not conform to standard horizontal fittings.
- Furnished in pairs with hardware.
- Bonding jumpers not required.
- (*) Insert **ZN** or **G**
- (X) Insert 4 for series 148 or 156, 5 for series 166, or 6 for series 176

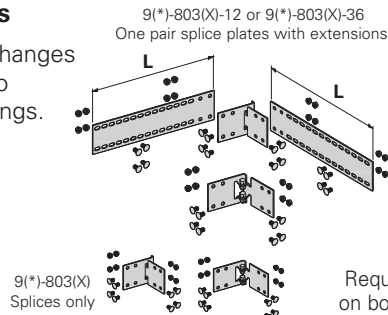

Catalog No.	Cable Tray End Cut	Tray Width	'L'
9(*)-803(X)	Mitered	Thru 36"	N/A
9(*)-803(X)-12	Not mitered	Thru 12"	16"
9(*)-803(X)-36	Not mitered	Thru 36"	41"

Requires supports within 24" on both sides, per NEMA VE 2.

● Green = Fastest shipped items ● Black = Normal lead-time items ● Red = Normally long lead-time items

All dimensions in parentheses are millimeters unless otherwise specified.

Branch Pivot Connectors

- Branch from existing cable tray runs at any point.
- Pivot to any required angle.
- UL Classified for grounding (bonding jumpers are not required).
- Furnished in pairs with hardware.
- (*) Insert **ZN** or **G**

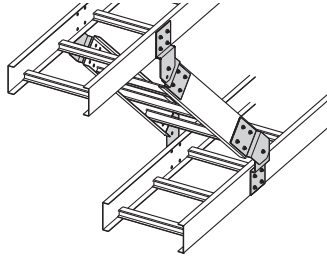

Tray Series	Catalog No.
156 to 148	9(*)-8244
166	9(*)-8245
176	9(*)-8246

Offset Reducing Splice Plate

- This plate is used for joining cable trays having different widths. When used in pairs they form a straight reduction; when used singly with a standard splice plate they form an offset reduction.
- Furnished as one plate with hardware.
- (‡) Insert reduction
- (*) Insert **P** or **G**

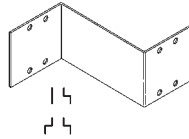

Tray Series	Catalog No.
148	9(*)-8064-(‡)
156	9(*)-8064-(‡)
166	9(*)-8065-(‡)
176	9(*)-8066-(‡)

Tray to Box Splice Plates

- Used to attach the end of a cable tray run to a distribution box or control panel.
- Furnished in pairs with hardware.
- (*) Insert **P** or **G**

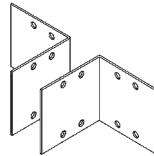

Tray Series	Catalog No.
148	9(*)-8054
156	9(*)-8054
166	9(*)-8055
176	9(*)-8056

Frame Type Box Connector

- Designed to attach the end of a cable tray run to a distribution cabinet or control center to help reinforce the box at the point of entry.
- Furnished with tray connection hardware.
- (‡) Insert tray width
- (*) Insert **ZN** or **G**

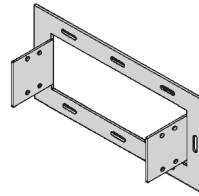

Tray Series	Catalog No.
148	9(*)-8074-(‡)
156	9(*)-8074-(‡)
166	9(*)-8075-(‡)
176	9(*)-8076-(‡)

Blind End

- This plate forms a closure for a dead end cable tray.
- Furnished as one plate with hardware.
- (‡) Insert tray width
- (*) Insert **P** or **G**

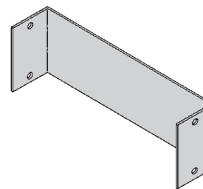

Tray Series	Catalog No.
148	9(*)-8084-(‡)
156	9(*)-8084-(‡)
166	9(*)-8085-(‡)
176	9(*)-8086-(‡)

Tray Hardware

Pre-Galvanized Tray Hardware

Catalog No. ● **RNCB 3/8"-16 x 3/4" Znplt**
Ribbed Neck Carriage Bolt ASTM A307 Grade A

Catalog No. ● **SFHN 3/8"-16 Znplt**
Serrated Flange Hex Nut ASTM A563 Grade A

Finish: Zinc Plated ASTM B633, SC1

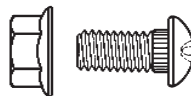

Hot Dip Galvanized Tray Hardware

Catalog No. ● **RNCB 3/8"-16 x 3/4" CZ** Ribbed Neck Carriage Bolt Chromium Zinc ASTM F-1136-88

Catalog No. ● **SFHN 3/8"-16 CZ** Serrated Flange Hex Nut Chromium Zinc ASTM F-1136-88

● Green = Fastest shipped items ● Black = Normal lead-time items ● Red = Normally long lead-time items

All dimensions in parentheses are millimeters unless otherwise specified.

Series 1 Steel - Accessories

Conduit to Tray Adaptor

- For easy attachment of conduit terminating at a cable tray.
- Use on aluminum or steel cable trays.

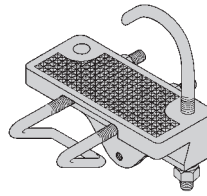
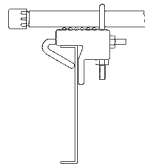

Conduit Size		Catalog No.
in.	(mm)	
1/2, 3/4	(15, 20)	9G-1159-1/2, 3/4
1, 1 1/4	(25, 32)	9G-1159-1, 1 1/4
1 1/2, 2	(40, 50)	9G-1159-1 1/2, 2
2 1/2, 3	(65, 80)	9G-1159-2 1/2, 3
3 1/2, 4	(90, 100)	9G-1159-3 1/2, 4

Conduit to Tray Adaptor

- Assembly required.
- Mounting hardware included.
- Conduit clamp included
- (‡) = Conduit size (1/2" thru 4").

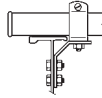

Catalog No.
9ZN-1150-(‡)

Cable Tie (Ladder Tray)

- Nylon ties provide easy attachment of cable to ladder rungs; maximum cable O.D. of 3" (76 mm).

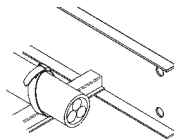

Catalog No.
99-2125-15

Cable Tray Clamp/Guide

- Features a no-twist design.
- Has four times the strength of the traditional design.
- Each side is labeled to ensure proper installation.
- Furnished in pairs, with or without hardware.

Patent # RE35479

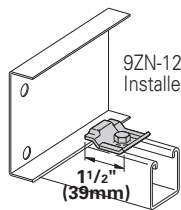

9ZN-1204 shown. Installed as a guide.

1 1/2" (39mm)

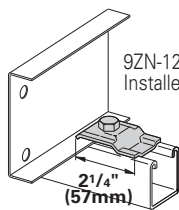

9ZN-1208 shown. Installed as a clamp.

2 1/4" (57mm)

Catalog No.		Overall Length in. (mm)	Hardware Size	Finish
Without Hardware	With Hardware			
9ZN-1204	9ZN-1204NB	1 1/2 38	1/4"	G90
9ZN-1208	9ZN-1208NB	2 1/4 57	3/8"	G90

Bonding Jumper

Use at each expansion splice and where the cable tray is not mechanically/electrically continuous to ground.

Sold individually.

- Hardware included.
- See table 392.7(B)(2) on page C-9 for amperage ratings required to match the UL cross-sectional area of the tray.
- 600 amp rating.
- Bonding jumper is 14 1/2" (368mm) long.

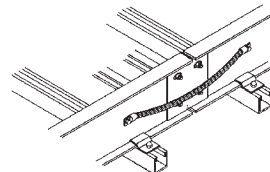

Catalog No.	Copper Wire Size
99-N1	#1

Grounding Clamp

Eaton's B-Line series cable tray is UL® classified as to its suitability as an equipment grounding conductor. If a separate conductor for additional grounding capability is desired, we offer this clamp for bolting the conductor at least once to each tray section.

- Tin plated Aluminum clamp accepts #6 AWG to 250 MCM.

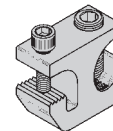

Catalog No.
9A-2130

Ground Wire Clamp

- Mechanically attaches grounding cables to cable tray.
- Hardware included.
- (*) Insert **ZN** or **SS4**

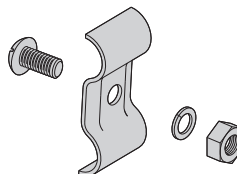

Catalog No.	Cable Size
9(*)-2351	#1 thru 2/0
9(*)-2352	3/0 thru 250 MCM

● Green = Fastest shipped items ● Black = Normal lead-time items ● Red = Normally long lead-time items

All dimensions in parentheses are millimeters unless otherwise specified.

Threaded Rod (ATR) & Rod Coupling

- Loading based on safety factor 5.
- Standard Finish: Zinc plated

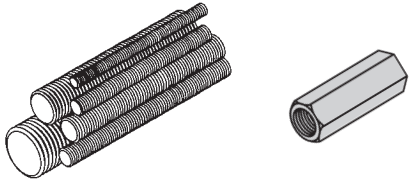

Size	Loading lbs. (kN)	Threaded Rod Catalog No.	Available Lengths in. (mm)	Coupling Cat. No.
3/8-16	730 (3.25)	● ATR 3/8 x Length	36, 72, 120, 144 (914, 1829, 3048, 3657)	● B655-3/8
1/2-13	1350 (6.00)	● ATR 3/8 x Length	36, 72, 120, 144 (914, 1829, 3048, 3657)	● B655-1/2

See B-Line series Strut Systems Catalog for other sizes and finishes.

Hanger Rod Clamp

- For 1/2" ATR.
- Furnished in pairs.
- Order ATR and hex nuts separately.
- Two piece "J"-hanger design.
- 9ZN-1113 has 275 lbs./pair safety factor 3.
- 9ZN-532(X) has 1500 lbs./pair safety factor 3.

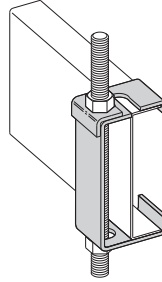

Tray Series	Catalog No.
148	● 9ZN-1113
156	● 9ZN-5324
166	● 9ZN-5325
176	● 9ZN-5326

Support Bracket

- Designed for center hung or trapeze supports.
- Used with ladder or vented bottom tray only.
- Can be purchased as a wall mounted bracket.
- Load capacity is 600 lbs. (272.1 kg), safety factor 3.
- All components are zinc plated.
- 1/2" threaded rod and 1/2" hex nuts not included.

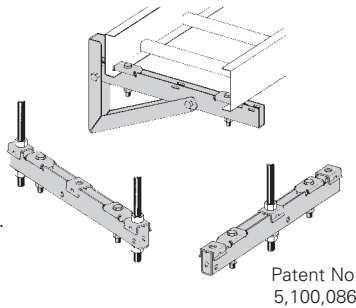

Patent No.
5,100,086

Catalog No.		For Cable Tray Width in. (mm)
Center Hung or Trapeze	Wall Mount	
● 9ZN-5106	● 9ZN-5106-WB	6 (152)
● 9ZN-5109	● 9ZN-5109-WB	9 (226)
● 9ZN-5112	● 9ZN-5112-WB	12 (305)
● 9ZN-5118	● 9ZN-5118-WB	18 (452)
● 9ZN-5124	● 9ZN-5124-WB	24 (609)

Cantilever Bracket (12" - 42")

- Finishes available:
● ZN ● GRN or ● HDG
- Safety Load Factor 2.5

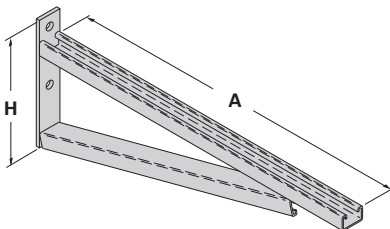

Bottom brace is B42 channel on B494-24 and smaller and B22 channel on B494-30 and larger

Catalog No.	Uniform Load lbs (kN)	Tray Width in. (mm)	'A' in. (mm)	'H' in. (mm)
● B494-12	2500 (11.12)	6 & 9 (152 & 229)	12 (305)	8 ³ / ₄ (222)
● B494-18	1700 (7.56)	12 (305)	18 (457)	8 ³ / ₄ (222)
● B494-24	1300 (5.78)	18 (457)	24 (610)	8 ³ / ₄ (222)
B494-30	1600 (7.11)	24 (610)	30 (762)	11 ¹ / ₄ (286)
B494-36	1100 (4.89)	30 (762)	36 (914)	11 ¹ / ₄ (286)
B494-42	980 (4.36)	36 (914)	42 (1067)	16 (406)

For more dimensional data see Strut Systems catalog

● Green = Fastest shipped items ● Black = Normal lead-time items ● Red = Normally long lead-time items

All dimensions in parentheses are millimeters unless otherwise specified.

Series 1 Steel - Accessories

Cantilever Bracket

- Finishes available: **ZN** **GRN** **HDG** **SS4** or **SS6**
- Safety Load Factor 2.5

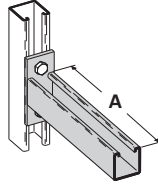

Catalog No.	Uniform Load		Tray Width		'A'	
	lbs	(kN)	in.	(mm)	in.	(mm)
B409-12	960	(4.27)	6 & 9	(152 & 229)	12	(304.8)
B409-18	640	(2.84)	12	(305)	18	(457.2)
B409-24	480	(2.13)	18	(457)	24	(609.6)

Cantilever Bracket

- Finishes available: **ZN** **GRN** **HDG** or **SS4**
- Safety Load Factor 2.5

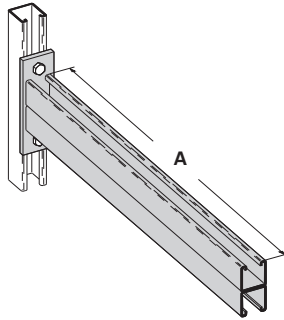

Catalog No.	Uniform Load		Tray Width		'A'	
	lbs	(kN)	in.	(mm)	in.	(mm)
B297-30	665	(2.95)	24	(609.6)	30	(762.0)
B297-36	550	(2.44)	30	(762.0)	36	(914.4)
B297-42	465	(2.06)	36	(914.4)	42	(1066.8)

Underfloor Support (U-Bolts not included)

- Finishes available: **ZN**
- Safety Load Factor 2.5
- Order properly sized U-Bolts separately.

U-Bolt Size	Fits Pipe O.D.
B501-3/4	.841 - 1.050
B501-1	1.051 - 1.315
B501-1 1/4	1.316 - 1.660
B501-1 1/2	1.661 - 1.900
B501-2	1.901 - 2.375
B501-2 1/2	2.376 - 2.875

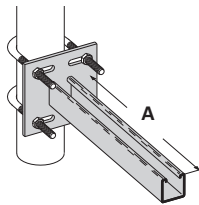

Catalog No.	Uniform Load		Tray Width		'A'	
	lbs	(kN)	in.	(mm)	in.	(mm)
B409UF-12	800	(3.55)	6 & 9	(152 & 229)	12	(304.8)
B409UF-21	450	(2.00)	12 & 18	(305 & 457)	21	(533.4)

Beam Clamp

- Finishes available: **ZN** or **HDG**
- Sold in pieces with hardware.
- Design load when used in pairs.
Safety Load Factor 5.0

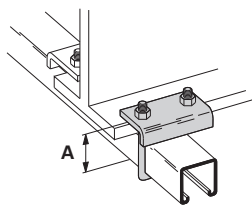

Catalog No.	Design Load*		'A'	
	lbs	(kN)	in.	(mm)
B441-22	1200	(5.34)	3 3/8	(86)
B441-22A	1200	(5.34)	5	(127)

Steel C-Clamp With Locknut

- Finishes available:
 - ZN** for 3/8 & 1/2
 - ZN** for 5/8 & 3/4
 - SS4** all sizes
- Safety Load Factor 5.0

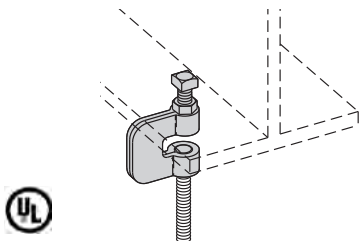

Catalog Number	Rod Size	Design Load	
		lbs	(kN)
B351L-3/8	3/8"-16	300	(0.89)
B351L-1/2	1/2"-13	380	(1.69)
B351L-5/8	5/8"-11	550	(2.44)
B351L-3/4	3/4"-10	630	(2.80)

● Green = Fastest shipped items ● Black = Normal lead-time items ● Red = Normally long lead-time items

All dimensions in parentheses are millimeters unless otherwise specified.

Beam Clamp

- Finishes available: **ZN** **GRN** or **HDG**
- Setscrew included.
- Sold in pieces.
- Design load when used in pairs.
Safety Load Factor 5.0

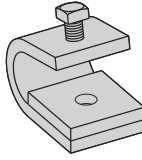

Cat. No.	B210	B210A
Design Load	800 lbs. (3.56kN)	300 lbs. (1.33kN)
Tap Size	1/2"-13	3/8"-16
Mat'l. Thickness	3/8" (9.5mm)	1/4" (6.4mm)

Beam Clamp

- Finishes available: **ZN** **GRN** or **HDG**
- Setscrew included.
- Sold in pieces.
- Design load when used in pairs.
Safety Load Factor 5.0

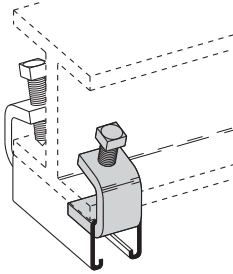

Cat. No.	B212-1/4	B212-3/8
Design Load	800 lbs. (3.56kN)	1000 lbs. (4.45kN)
Max. Flange Thick.	3/4" (19.0mm)	1 1/8" (28.6mm)
Mat'l. Thickness	1/4" (6.4mm)	3/8" (9.5mm)

B305 Thru B308 & B321 Series Beam Clamps

- Finishes available: **ZN** or **HDG**
- Setscrew included.
- Safety Load Factor 5.0

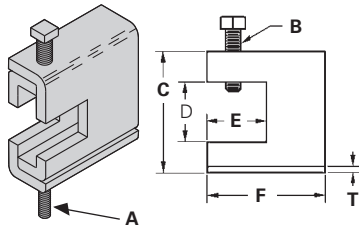

Cat. No.	A	B	C	D	E	F	T	Design Load
			in. (mm)	in. (mm)	in. (mm)	in. (mm)	in. (mm)	lbs (kN)
B305	3/8"-16	3/8"-16	2 5/16 (58.7)	7/8 (22.2)	1 1/8 (28.6)	2 1/2 (63.5)	11 Ga. (3.0)	600 (2.67)
B306	3/8"-16	1/2"-13	2 7/16 (61.9)	7/8 (22.2)	1 1/8 (28.6)	2 1/2 (63.5)	7 Ga. (4.5)	1100 (4.90)
B307	1/2"-13	1/2"-13	2 7/16 (61.9)	7/8 (22.2)	1 1/8 (28.6)	2 1/2 (63.5)	7 Ga. (4.5)	1100 (4.90)
B308	1/2"-13	1/2"-13	2 9/16 (65.1)	7/8 (22.2)	1 1/8 (28.6)	2 1/2 (63.5)	1/4 (6.3)	1500 (6.68)
B321-1	3/8"-16	1/2"-13	3 9/16 (90.5)	1 11/16 (42.8)	1 5/8 (41.3)	3 1/4 (82.5)	1/4 (6.3)	1300 (5.79)
B321-2	1/2"-13	1/2"-13	3 9/16 (90.5)	1 11/16 (42.8)	1 5/8 (41.3)	3 1/4 (82.5)	1/4 (6.3)	1400 (6.23)

B312 Anchor Strap

- Finishes available: **ZN** or **HDG**
- For a maximum beam thickness of 3/4".
- For thicker beams, step up one flange width size.

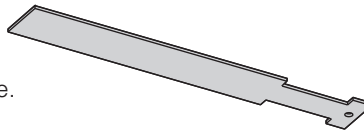

Cat. No.	Flange Width
	in. (mm)
B312-6	Up to 6 (up to 152.4)
B312-9	6 - 9 (152.4 to 228.6)
B312-12	9 - 12 (228.6 to 304.8)

B751 Bottom Beam Clamp and Accessories

- Setscrew included.
- Finish available: ZN

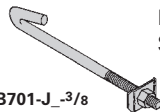

Loading position A - 500 lbs.
Loading position B - 300 lbs.
Safety Load Factor 5.0

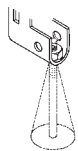
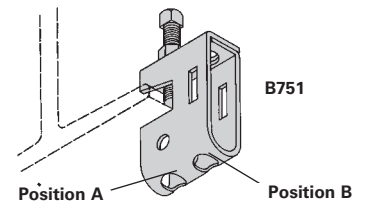
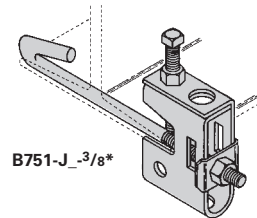

B753

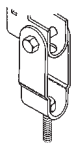

B752

Provides a full 15° swivel in any direction. (State the desired rod size.)

Assembly No.	B751	B701J_	B752	B753
Fits Flange Sizes	Clamp, Setscrew & J-Hook	J-Hook, Clip & Square Nut	Swivel & Bolt Only	Swivel Nut Only
in. (mm)				
4 - 5 7/8 (101 - 149)	● B751-J4-3/8*	● B701-J4-3/8	● B752	● B753-**
6 - 8 7/8 (152 - 225)	● B751-J6-3/8*	● B701-J6-3/8	● B752	● B753-**
9 - 11 7/8 (228 - 301)	● B751-J9-3/8*	● B701-J9-3/8	● B752	● B753-**

* Clamp Assembly complete with J-Hook Assembly. Setscrew included.

** Insert 1/4, 3/8 or 1/2 for the desired rod size.

● Green = Fastest shipped items ● Black = Normal lead-time items ● Red = Normally long lead-time items

All dimensions in parentheses are millimeters unless otherwise specified.

Series 1 Steel - Accessories

Trapeze Support Kit

Trapeze kits provide the components required for a single trapeze support in one package. These kits are available in pre-galvanized steel with zinc-plated hardware or hot dip galvanized steel with 316 stainless steel hardware.

The SH channel provides the convenience of pre-punched slots, which eliminate the need for field drilling.

The illustrated hardware is sealed in a plastic bag and boxed with the channel, which is pre-cut to the appropriate length as shown in the chart.

Designed for use with 1/2" threaded rod. (order separately)

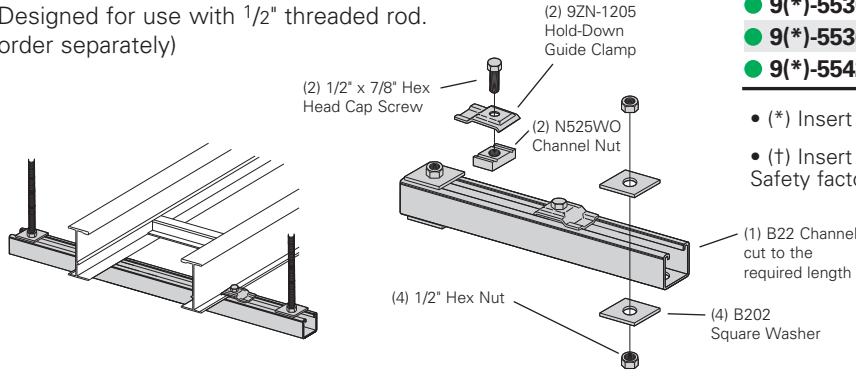

Catalog No.	Tray Width in. (mm)	Channel Length in. (mm)	Uniform Load lbs (kN)
● 9(*)-5506-22SH(+)	6 (152)	16 (406)	1600 (7.11)
● 9(*)-5509-22SH(+)	9 (229)	18 (457)	1250 (5.56)
● 9(*)-5512-22SH(+)	12 (305)	22 (559)	1125 (5.00)
● 9(*)-5518-22SH(+)	18 (457)	28 (711)	865 (3.85)
● 9(*)-5524-22SH(+)	24 (610)	34 (864)	700 (3.11)
● 9(*)-5530-22SH(+)	30 (762)	40 (1016)	590 (2.62)
● 9(*)-5536-22SH(+)	36 (914)	46 (1168)	510 (2.27)
● 9(*)-5542-22SH(+)	42 (1067)	52 (1321)	450 (2.00)

- (*) Insert **P** or **G**
- (+) Insert 3/8 for 3/8" threaded rod hardware. Safety factor of 3.0 on all loads.

Heavy Duty Trapeze Support Kit

Trapeze kits provide the components required for a single trapeze support in one package. These kits are available in Dura Green™ epoxy coated steel with zinc-plated hardware or hot dip galvanized steel with 316 stainless steel hardware.

The SH channel provides the convenience of pre-punched slots, which eliminates the need for field drilling.

The illustrated hardware is sealed in a plastic bag and boxed with the channel, which is pre-cut to the appropriate length as shown in the chart.

Designed for use with 1/2" threaded rod. (order rod separately)

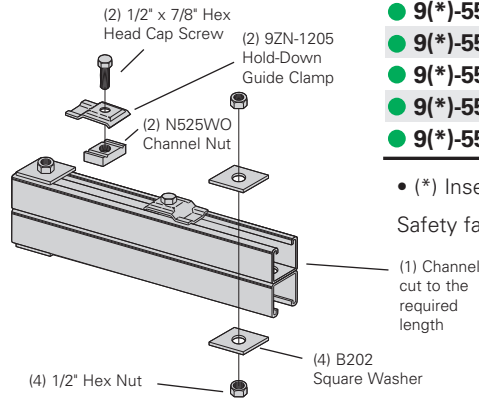

Catalog No.	Tray Width in. (mm)	Channel Length in. (mm)	Uniform Load lbs (kN)
● 9(*)-5506-22SHA	6 (152)	16 (406)	1350 (6.01)
● 9(*)-5509-22SHA	9 (229)	18 (457)	1350 (6.01)
● 9(*)-5512-22SHA	12 (305)	22 (559)	1350 (6.01)
● 9(*)-5518-22SHA	18 (457)	28 (711)	1350 (6.01)
● 9(*)-5524-22SHA	24 (610)	34 (864)	1350 (6.01)
● 9(*)-5530-22SHA	30 (762)	40 (1016)	1350 (6.01)
● 9(*)-5536-22SHA	36 (914)	46 (1168)	1350 (6.01)
● 9(*)-5542-22SHA	42 (1067)	52 (1321)	1350 (6.01)

- (*) Insert **G** or **GRN**
- Safety factor of 3.0 on all loads.

Trapeze Hardware Kit

- Kit sold in plastic bag.

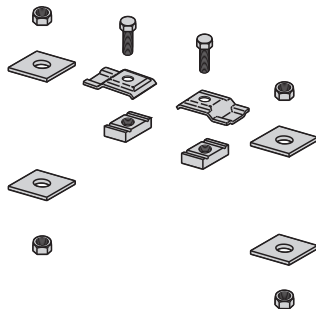

Catalog No.	
● 9ZN-5500-1/2	● 9G-5500-1/2
(1) pr. 9ZN-1205	(1) pr. 9G-1205
(2) HHC Screw 1/2 x 7/8" ZN	(2) HHC Screw 1/2" x 7/8" SS6
(2) N525 WO ZN	(2) N525 WO SS6
(4) B202 ZN 1/2" sq washer	(4) B202 HDG 1/2" sq washer
(4) HN 1/2" ZN	(4) HN 1/2" SS6

● Green = Fastest shipped items ● Black = Normal lead-time items ● Red = Normally long lead-time items

All dimensions in parentheses are millimeters unless otherwise specified.

Ladder Drop-Out

- This special designed, easy to install drop-out provides a 4" (101.6 mm) radius to protect cables exiting the cable tray from damage.
- Attaches to a ladder rung.
- Hardware included.
- (*) Insert **P** or **G**
- (‡) Insert tray width

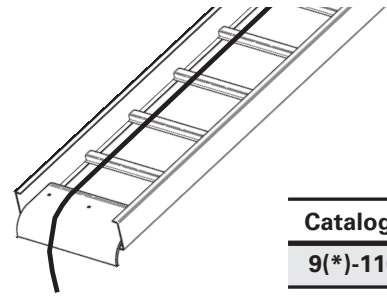
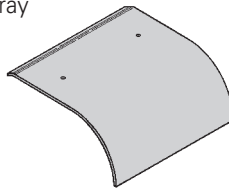

Catalog No.
9(*)-1104T-(‡)

Straight Section

- Standard length: 120" (3 m) 144" (12 ft.).
- Order catalog number based on loading depth.
- Furnished with four #10 x 1/2" plated self-drilling screws and a 99-9982 splice.
- (*) Insert **P** or **G**

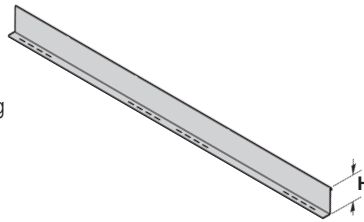

Length =
144 for 12' or 120 for 10'



Tray Series	Catalog No.	H	
		in.	(mm)
148	72(*)-Length	2.8	(58)
156	737(*)-Length	3.4	(70)
166	747(*)-Length	4.4	(91)
176	757(*)-Length	5.4	(112)

Horizontal Bend

- Horizontal Bend Barriers are flexible in order to conform to any horizontal fitting radius. Cut to length.
- Order catalog number based on loading depth.
- Furnished with three #10 x 1/2" zinc plated self-drilling screws and a 99-9982 Barrier Strip Splice.
- Standard length is 72" [6 ft.] (1829mm), sold individually.
- (*) Insert **P** or **G**

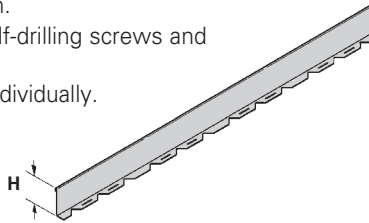

Tray Series	Catalog No.	H	
		in.	(mm)
148	72(*)-90HBFL	2.8	(58)
156	737(*)-90HBFL	3.4	(70)
166	747(*)-90HBFL	4.4	(91)
176	757(*)-90HBFL	5.4	(112)

Vertical Bend Barriers

- Vertical Bend Barriers are preformed to conform to a specific vertical fitting.
- Furnished with three #10 x 1/2" plated self-drilling screws and a 99-9982 Barrier Strip Splice.
- (*) Insert **P** or **G**
- (***) Insert 30, 45, 60 or 90 for degrees
- (t) Insert 12, 24, or 36 for radius

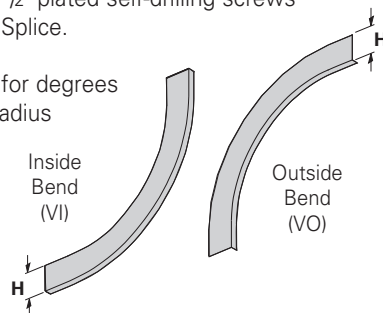

Tray Series	Catalog No.		H	
	Inside Bend	Outside Bend	in.	(mm)
148	72(*)-(***)VI(t)	72(*)-(***)VO(t)	2.8	(58)
156	737(*)-(***)VI(t)	737(*)-(***)VO(t)	3.4	(70)
166	747(*)-(***)VI(t)	747(*)-(***)VO(t)	4.4	(91)
176	757(*)-(***)VI(t)	757(*)-(***)VO(t)	5.4	(112)

Barrier Strip Splice

- Plastic splice holds adjoining barrier strips in straight alignment.
- 3" (76.2mm) long

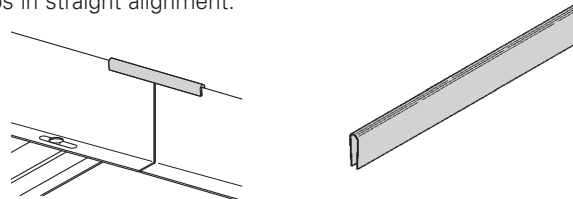

Catalog No.
● 99-9982

● Green = Fastest shipped items ● Black = Normal lead-time items ● Red = Normally long lead-time items

All dimensions in parentheses are millimeters unless otherwise specified.

Series 1 Steel - Accessories

Standard (L-Shaped) Splice Plates

- One pair including hardware provided with each section. (Expansion splice quantity subtracted)
- Furnished in pairs with hardware.
- Prepackaged in pairs in a plastic bag, with hardware.
- 4-hole pattern L-shaped splice plates.
- L-shaped lay-in design.
- (*) Insert **ZN** or **G**

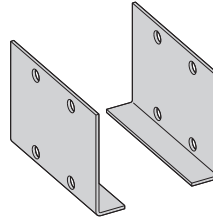

Tray Series	Catalog No.
148	9(*)-4004
156	9(*)-4005
166	9(*)-4006
176	9(*)-4007

Expansion (L-Shaped) Splice Plates

- Expansion plates allow for one inch expansion or contraction of the cable tray, or where expansion joints occur in the supporting structure.
- Bonding Jumpers are required on each side rail. Order Separately.
- L-shaped lay-in design.
- Furnished in pairs with hardware.
- (*) Insert **ZN** or **G**

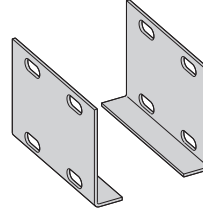

Tray Series	Catalog No.
148	9(*)-4014
156	9(*)-4015
166	9(*)-4016
176	9(*)-4017

Universal Splice Plates

- Used to splice to existing cable tray systems.
- Furnished in pairs with hardware.
- (*) Insert **P** or **G**

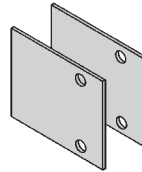

Tray Series	Catalog No.
148	9(*)-2004-1/2
156	9(*)-2005-1/2
166	9(*)-2006-1/2
176	9(*)-2007-1/2

Step Down Splice Plates

- These splice plates are offered for connecting cable tray sections having side rails of different heights.
- Furnished in pairs with hardware.
- (*) Insert **ZN** or **G**

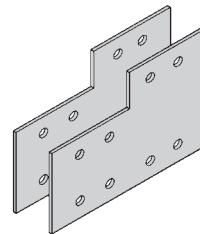

Tray Series	Catalog No.
156 to 148	9(*)-8044
166 to 156 or 148	9(*)-8045
176 to 156 or 148	9(*)-8046
176 to 166	9(*)-8060

Vertical Adjustable Splice Plates

- These plates provide for changes in elevation that do not conform to standard vertical fittings.
- Bonding jumpers not required.
- Furnished in pairs with hardware.
- (*) Insert **ZN** or **G**
- (***) Insert **P** or **G**

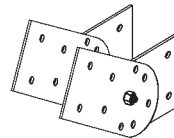

Requires supports within 24" on both sides, per NEMA VE 2.

Tray Series	Catalog No.
148	9(**)-7024
156	9(*)-8024
166	9(*)-8025
176	9(*)-8026

Horizontal Adjustable Splice Plates

- Offered to adjust a cable tray run for changes in direction in a horizontal plane that do not conform to standard horizontal fittings.
- Furnished in pairs with hardware.
- Bonding jumpers not required.
- (*) Insert **ZN** or **G**
- (X) Insert 4 for series 148 or 156, 5 for series 166, or 6 for series 176

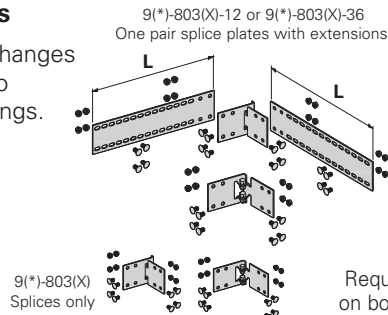

Catalog No.	Cable Tray End Cut	Tray Width	'L'
9(*)-803(X)	Mitered	Thru 36"	N/A
9(*)-803(X)-12	Not mitered	Thru 12"	16"
9(*)-803(X)-36	Not mitered	Thru 36"	41"

Requires supports within 24" on both sides, per NEMA VE 2.

● Green = Fastest shipped items ● Black = Normal lead-time items ● Red = Normally long lead-time items

All dimensions in parentheses are millimeters unless otherwise specified.

Branch Pivot Connectors

- Branch from existing cable tray runs at any point.
- Pivot to any required angle.
- UL Classified for grounding (bonding jumpers are not required).
- Furnished in pairs with hardware.
- (*) Insert **ZN** or **G**

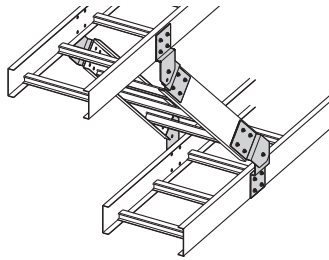

Tray Series	Catalog No.
156 to 148	9(*)-8244
166	9(*)-8245
176	9(*)-8246

Offset Reducing Splice Plate

- This plate is used for joining cable trays having different widths. When used in pairs they form a straight reduction; when used singly with a standard splice plate they form an offset reduction.
- Furnished as one plate with hardware.
- (‡) Insert reduction
- (*) Insert **P** or **G**

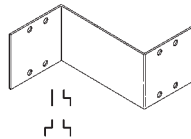

Tray Series	Catalog No.
148	9(*)-8064-(‡)
156	9(*)-8064-(‡)
166	9(*)-8065-(‡)
176	9(*)-8066-(‡)

Tray to Box Splice Plates

- Used to attach the end of a cable tray run to a distribution box or control panel.
- Furnished in pairs with hardware.
- (*) Insert **P** or **G**

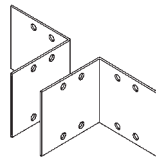

Tray Series	Catalog No.
148	9(*)-8054
156	9(*)-8054
166	9(*)-8055
176	9(*)-8056

Frame Type Box Connector

- Designed to attach the end of a cable tray run to a distribution cabinet or control center to help reinforce the box at the point of entry.
- Furnished with tray connection hardware.
- (‡) Insert tray width
- (*) Insert **ZN** or **G**

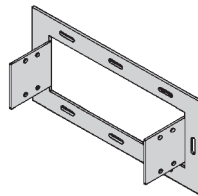

Tray Series	Catalog No.
148	9(*)-8074-(‡)
156	9(*)-8074-(‡)
166	9(*)-8075-(‡)
176	9(*)-8076-(‡)

Blind End

- This plate forms a closure for a dead end cable tray.
- Furnished as one plate with hardware.
- (‡) Insert tray width
- (*) Insert **P** or **G**

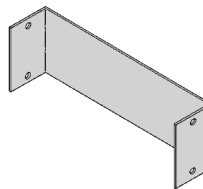

Tray Series	Catalog No.
148	9(*)-8084-(‡)
156	9(*)-8084-(‡)
166	9(*)-8085-(‡)
176	9(*)-8086-(‡)

Tray Hardware

Pre-Galvanized Tray Hardware

Catalog No. ● **RNCB 3/8"-16 x 3/4" Znplt**
Ribbed Neck Carriage Bolt ASTM A307 Grade A

Catalog No. ● **SFHN 3/8"-16 Znplt**
Serrated Flange Hex Nut ASTM A563 Grade A

Finish: Zinc Plated ASTM B633, SC1

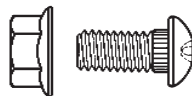

Hot Dip Galvanized Tray Hardware

Catalog No. ● **RNCB 3/8"-16 x 3/4" CZ** Ribbed Neck Carriage Bolt Chromium Zinc ASTM F-1136-88

Catalog No. ● **SFHN 3/8"-16 CZ** Serrated Flange Hex Nut Chromium Zinc ASTM F-1136-88

● Green = Fastest shipped items ● Black = Normal lead-time items ● Red = Normally long lead-time items

All dimensions in parentheses are millimeters unless otherwise specified.

Series 1 Steel - Accessories

Conduit to Tray Adaptor

- For easy attachment of conduit terminating at a cable tray.
- Use on aluminum or steel cable trays.

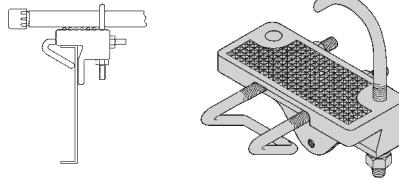

Conduit Size		Catalog No.
in.	(mm)	
1/2, 3/4	(15, 20)	9G-1159-1/2, 3/4
1, 1 1/4	(25, 32)	9G-1159-1, 1 1/4
1 1/2, 2	(40, 50)	9G-1159-1 1/2, 2
2 1/2, 3	(65, 80)	9G-1159-2 1/2, 3
3 1/2, 4	(90, 100)	9G-1159-3 1/2, 4

Conduit to Tray Adaptor

- Assembly required.
- Mounting hardware included.
- Conduit clamp included
- (‡) = Conduit size (1/2" thru 4").

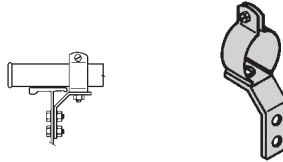

Catalog No.
9ZN-1150-(‡)

Cable Tie (Ladder Tray)

- Nylon ties provide easy attachment of cable to ladder rungs; maximum cable O.D. of 3" (76 mm).

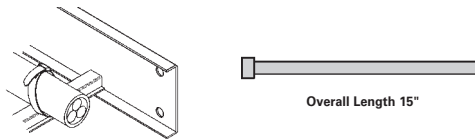

Catalog No.
99-2125-15

Cable Tray Clamp/Guide

- Features a no-twist design.
- Has four times the strength of the traditional design.
- Each side is labeled to ensure proper installation.
- Furnished in pairs, with or without hardware.

Patent # RE35479

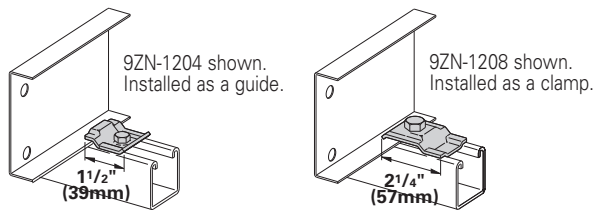

Catalog No.		Overall Length in. (mm)	Hardware Size	Finish
Without Hardware	With Hardware			
9ZN-1204	9ZN-1204NB	1 1/2 38	1/4"	G90
9ZN-1208	9ZN-1208NB	2 1/4 57	3/8"	G90

Bonding Jumper

Use at each expansion splice and where the cable tray is not mechanically/electrically continuous to ground.

Sold individually.

- Hardware included.
- See table 392.7(B)(2) on page C-9 for amperage ratings required to match the UL cross-sectional area of the tray.
- 600 amp rating.
- Bonding jumper is 14 1/2" (368mm) long.

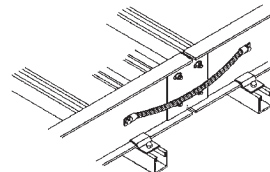

Catalog No.	Copper Wire Size
99-N1	#1

Grounding Clamp

Eaton's B-Line series cable tray is UL® classified as to its suitability as an equipment grounding conductor. If a separate conductor for additional grounding capability is desired, we offer this clamp for bolting the conductor at least once to each tray section.

- Tin plated Aluminum clamp accepts #6 AWG to 250 MCM.

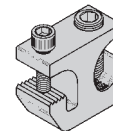

Catalog No.
9A-2130

Ground Wire Clamp

- Mechanically attaches grounding cables to cable tray.
- Hardware included.
- (*) Insert **ZN** or **SS4**

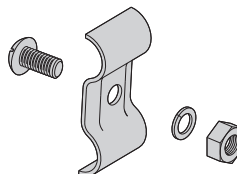

Catalog No.	Cable Size
9(*)-2351	#1 thru 2/0
9(*)-2352	3/0 thru 250 MCM

● Green = Fastest shipped items ● Black = Normal lead-time items ● Red = Normally long lead-time items

All dimensions in parentheses are millimeters unless otherwise specified.

Threaded Rod (ATR) & Rod Coupling

- Loading based on safety factor 5.
- Standard Finish: Zinc plated

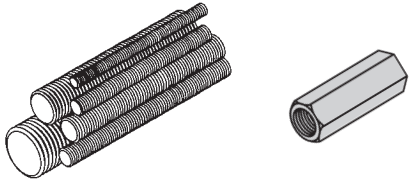

Size	Loading lbs. (kN)	Threaded Rod Catalog No.	Available Lengths in. (mm)	Coupling Cat. No.
3/8-16	730 (3.25)	● ATR 3/8 x Length	36, 72, 120, 144 (914, 1829, 3048, 3657)	● B655-3/8
1/2-13	1350 (6.00)	● ATR 3/8 x Length	36, 72, 120, 144 (914, 1829, 3048, 3657)	● B655-1/2

See B-Line series Strut Systems Catalog for other sizes and finishes.

Hanger Rod Clamp

- For 1/2" ATR.
- Furnished in pairs.
- Order ATR and hex nuts separately.
- Two piece "J"-hanger design.
- 9ZN-1113 has 275 lbs./pair safety factor 3.
- 9ZN-532(X) has 1500 lbs./pair safety factor 3.

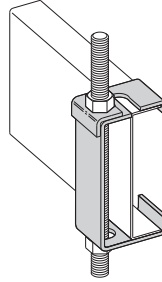

Tray Series	Catalog No.
148	● 9ZN-1113
156	● 9ZN-5324
166	● 9ZN-5325
176	● 9ZN-5326

Support Bracket

- Designed for center hung or trapeze supports.
- Used with ladder or vented bottom tray only.
- Can be purchased as a wall mounted bracket.
- Load capacity is 600 lbs. (272.1 kg), safety factor 3.
- All components are zinc plated.
- 1/2" threaded rod and 1/2" hex nuts not included.

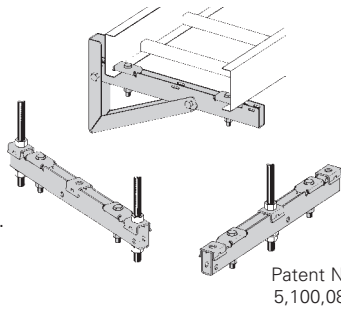

Patent No.
5,100,086

Catalog No.		For Cable Tray Width in. (mm)
Center Hung or Trapeze	Wall Mount	
● 9ZN-5106	● 9ZN-5106-WB	6 (152)
● 9ZN-5109	● 9ZN-5109-WB	9 (226)
● 9ZN-5112	● 9ZN-5112-WB	12 (305)
● 9ZN-5118	● 9ZN-5118-WB	18 (452)
● 9ZN-5124	● 9ZN-5124-WB	24 (609)

Cantilever Bracket (12" - 42")

- Finishes available:
● ZN ● GRN or ● HDG
- Safety Load Factor 2.5

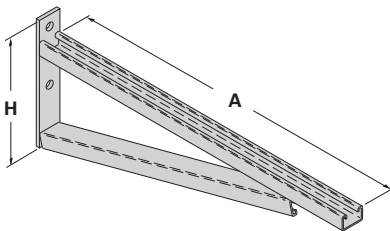

Bottom brace is B42 channel on B494-24 and smaller and B22 channel on B494-30 and larger

Catalog No.	Uniform Load lbs (kN)	Tray Width in. (mm)	'A' in. (mm)	'H' in. (mm)
● B494-12	2500 (11.12)	6 & 9 (152 & 229)	12 (305)	8 ³ / ₄ (222)
● B494-18	1700 (7.56)	12 (305)	18 (457)	8 ³ / ₄ (222)
● B494-24	1300 (5.78)	18 (457)	24 (610)	8 ³ / ₄ (222)
B494-30	1600 (7.11)	24 (610)	30 (762)	11 ¹ / ₄ (286)
B494-36	1100 (4.89)	30 (762)	36 (914)	11 ¹ / ₄ (286)
B494-42	980 (4.36)	36 (914)	42 (1067)	16 (406)

For more dimensional data see Strut Systems catalog

● Green = Fastest shipped items ● Black = Normal lead-time items ● Red = Normally long lead-time items

All dimensions in parentheses are millimeters unless otherwise specified.

Series 1 Steel - Accessories

Cantilever Bracket

- Finishes available: **ZN** **GRN** **HDG** **SS4** or **SS6**
- Safety Load Factor 2.5

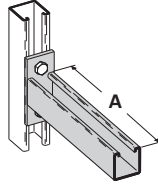

Catalog No.	Uniform Load		Tray Width		'A'	
	lbs	(kN)	in.	(mm)	in.	(mm)
B409-12	960	(4.27)	6 & 9	(152 & 229)	12	(304.8)
B409-18	640	(2.84)	12	(305)	18	(457.2)
B409-24	480	(2.13)	18	(457)	24	(609.6)

Cantilever Bracket

- Finishes available: **ZN** **GRN** **HDG** or **SS4**
- Safety Load Factor 2.5

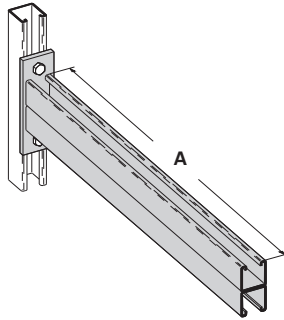

Catalog No.	Uniform Load		Tray Width		'A'	
	lbs	(kN)	in.	(mm)	in.	(mm)
B297-30	665	(2.95)	24	(609.6)	30	(762.0)
B297-36	550	(2.44)	30	(762.0)	36	(914.4)
B297-42	465	(2.06)	36	(914.4)	42	(1066.8)

Underfloor Support (U-Bolts not included)

- Finishes available: **ZN**
- Safety Load Factor 2.5
- Order properly sized U-Bolts separately.

U-Bolt Size	Fits Pipe O.D.
B501-3/4	.841 - 1.050
B501-1	1.051 - 1.315
B501-1 1/4	1.316 - 1.660
B501-1 1/2	1.661 - 1.900
B501-2	1.901 - 2.375
B501-2 1/2	2.376 - 2.875

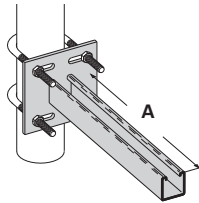

Catalog No.	Uniform Load		Tray Width		'A'	
	lbs	(kN)	in.	(mm)	in.	(mm)
B409UF-12	800	(3.55)	6 & 9	(152 & 229)	12	(304.8)
B409UF-21	450	(2.00)	12 & 18	(305 & 457)	21	(533.4)

Beam Clamp

- Finishes available: **ZN** or **HDG**
- Sold in pieces with hardware.
- Design load when used in pairs. Safety Load Factor 5.0

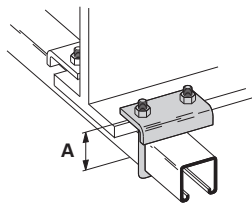

Catalog No.	Design Load*		'A'	
	lbs	(kN)	in.	(mm)
B441-22	1200	(5.34)	3 3/8	(86)
B441-22A	1200	(5.34)	5	(127)

Steel C-Clamp With Locknut

- Finishes available:
 - ZN** for 3/8 & 1/2
 - ZN** for 5/8 & 3/4
 - SS4** all sizes
- Safety Load Factor 5.0

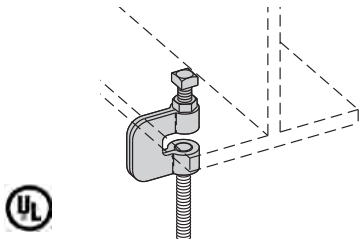

Catalog Number	Rod Size	Design Load	
		lbs	(kN)
B351L-3/8	3/8"-16	300	(0.89)
B351L-1/2	1/2"-13	380	(1.69)
B351L-5/8	5/8"-11	550	(2.44)
B351L-3/4	3/4"-10	630	(2.80)

● Green = Fastest shipped items ● Black = Normal lead-time items ● Red = Normally long lead-time items

All dimensions in parentheses are millimeters unless otherwise specified.

Beam Clamp

- Finishes available: **ZN** **GRN** or **HDG**
- Setscrew included.
- Sold in pieces.
- Design load when used in pairs.
Safety Load Factor 5.0

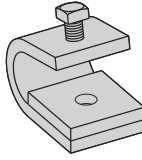

Cat. No.	B210	B210A
Design Load	800 lbs. (3.56kN)	300 lbs. (1.33kN)
Tap Size	1/2"-13	3/8"-16
Mat'l. Thickness	3/8" (9.5mm)	1/4" (6.4mm)

Beam Clamp

- Finishes available: **ZN** **GRN** or **HDG**
- Setscrew included.
- Sold in pieces.
- Design load when used in pairs.
Safety Load Factor 5.0

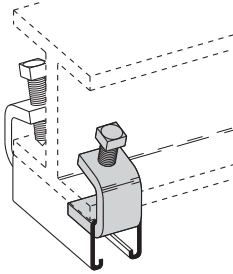

Cat. No.	B212-1/4	B212-3/8
Design Load	800 lbs. (3.56kN)	1000 lbs. (4.45kN)
Max. Flange Thick.	3/4" (19.0mm)	1 1/8" (28.6mm)
Mat'l. Thickness	1/4" (6.4mm)	3/8" (9.5mm)

B305 Thru B308 & B321 Series Beam Clamps

- Finishes available: **ZN** or **HDG**
- Setscrew included.
- Safety Load Factor 5.0

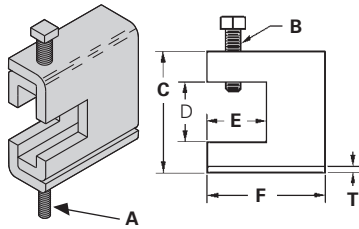

Cat. No.	A	B	C	D	E	F	T	Design Load
			in. (mm)	in. (mm)	in. (mm)	in. (mm)	in. (mm)	lbs (kN)
B305	3/8"-16	3/8"-16	2 5/16 (58.7)	7/8 (22.2)	1 1/8 (28.6)	2 1/2 (63.5)	11 Ga. (3.0)	600 (2.67)
B306	3/8"-16	1/2"-13	2 7/16 (61.9)	7/8 (22.2)	1 1/8 (28.6)	2 1/2 (63.5)	7 Ga. (4.5)	1100 (4.90)
B307	1/2"-13	1/2"-13	2 7/16 (61.9)	7/8 (22.2)	1 1/8 (28.6)	2 1/2 (63.5)	7 Ga. (4.5)	1100 (4.90)
B308	1/2"-13	1/2"-13	2 9/16 (65.1)	7/8 (22.2)	1 1/8 (28.6)	2 1/2 (63.5)	1/4 (6.3)	1500 (6.68)
B321-1	3/8"-16	1/2"-13	3 9/16 (90.5)	1 11/16 (42.8)	1 5/8 (41.3)	3 1/4 (82.5)	1/4 (6.3)	1300 (5.79)
B321-2	1/2"-13	1/2"-13	3 9/16 (90.5)	1 11/16 (42.8)	1 5/8 (41.3)	3 1/4 (82.5)	1/4 (6.3)	1400 (6.23)

B312 Anchor Strap

- Finishes available: **ZN** or **HDG**
- For a maximum beam thickness of 3/4".
- For thicker beams, step up one flange width size.

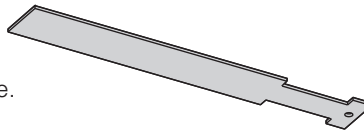

Cat. No.	Flange Width
	in. (mm)
B312-6	Up to 6 (up to 152.4)
B312-9	6 - 9 (152.4 to 228.6)
B312-12	9 - 12 (228.6 to 304.8)

B751 Bottom Beam Clamp and Accessories

- Setscrew included.
- Finish available: ZN

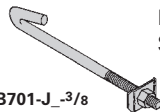

Loading position A - 500 lbs.
Loading position B - 300 lbs.
Safety Load Factor 5.0

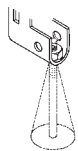
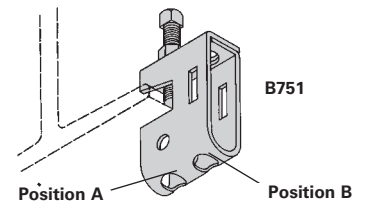
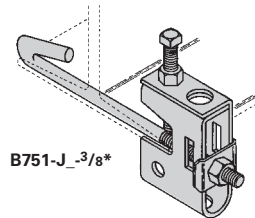

B753

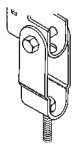

B752

Provides a full 15° swivel in any direction. (State the desired rod size.)

Assembly No.	B751	B701J_	B752	B753
Fits Flange Sizes	Clamp, Setscrew & J-Hook	J-Hook, Clip & Square Nut	Swivel & Bolt Only	Swivel Nut Only
in. (mm)				
4 - 5 7/8 (101 - 149)	● B751-J4-3/8*	● B701-J4-3/8	● B752	● B753-**
6 - 8 7/8 (152 - 225)	● B751-J6-3/8*	● B701-J6-3/8	● B752	● B753-**
9 - 11 7/8 (228 - 301)	● B751-J9-3/8*	● B701-J9-3/8	● B752	● B753-**

* Clamp Assembly complete with J-Hook Assembly. Setscrew included.

** Insert 1/4, 3/8 or 1/2 for the desired rod size.

● Green = Fastest shipped items ● Black = Normal lead-time items ● Red = Normally long lead-time items

All dimensions in parentheses are millimeters unless otherwise specified.

Series 1 Steel - Accessories

Trapeze Support Kit

Trapeze kits provide the components required for a single trapeze support in one package. These kits are available in pre-galvanized steel with zinc-plated hardware or hot dip galvanized steel with 316 stainless steel hardware.

The SH channel provides the convenience of pre-punched slots, which eliminate the need for field drilling.

The illustrated hardware is sealed in a plastic bag and boxed with the channel, which is pre-cut to the appropriate length as shown in the chart.

Designed for use with 1/2" threaded rod. (order separately)

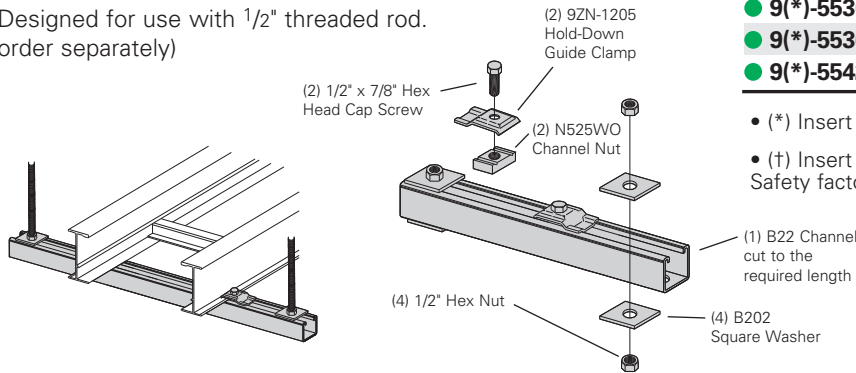

Catalog No.	Tray Width in. (mm)	Channel Length in. (mm)	Uniform Load lbs (kN)
● 9(*)-5506-22SH(+)	6 (152)	16 (406)	1600 (7.11)
● 9(*)-5509-22SH(+)	9 (229)	18 (457)	1250 (5.56)
● 9(*)-5512-22SH(+)	12 (305)	22 (559)	1125 (5.00)
● 9(*)-5518-22SH(+)	18 (457)	28 (711)	865 (3.85)
● 9(*)-5524-22SH(+)	24 (610)	34 (864)	700 (3.11)
● 9(*)-5530-22SH(+)	30 (762)	40 (1016)	590 (2.62)
● 9(*)-5536-22SH(+)	36 (914)	46 (1168)	510 (2.27)
● 9(*)-5542-22SH(+)	42 (1067)	52 (1321)	450 (2.00)

- (*) Insert **P** or **G**
- (+) Insert 3/8 for 3/8" threaded rod hardware. Safety factor of 3.0 on all loads.

Heavy Duty Trapeze Support Kit

Trapeze kits provide the components required for a single trapeze support in one package. These kits are available in Dura Green™ epoxy coated steel with zinc-plated hardware or hot dip galvanized steel with 316 stainless steel hardware.

The SH channel provides the convenience of pre-punched slots, which eliminates the need for field drilling.

The illustrated hardware is sealed in a plastic bag and boxed with the channel, which is pre-cut to the appropriate length as shown in the chart.

Designed for use with 1/2" threaded rod. (order rod separately)

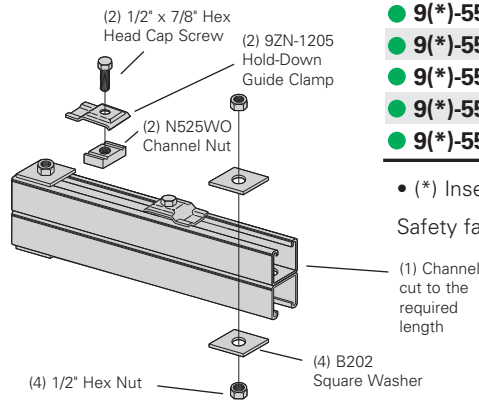

Catalog No.	Tray Width in. (mm)	Channel Length in. (mm)	Uniform Load lbs (kN)
● 9(*)-5506-22SHA	6 (152)	16 (406)	1350 (6.01)
● 9(*)-5509-22SHA	9 (229)	18 (457)	1350 (6.01)
● 9(*)-5512-22SHA	12 (305)	22 (559)	1350 (6.01)
● 9(*)-5518-22SHA	18 (457)	28 (711)	1350 (6.01)
● 9(*)-5524-22SHA	24 (610)	34 (864)	1350 (6.01)
● 9(*)-5530-22SHA	30 (762)	40 (1016)	1350 (6.01)
● 9(*)-5536-22SHA	36 (914)	46 (1168)	1350 (6.01)
● 9(*)-5542-22SHA	42 (1067)	52 (1321)	1350 (6.01)

- (*) Insert **G** or **GRN**
- Safety factor of 3.0 on all loads.

Trapeze Hardware Kit

- Kit sold in plastic bag.

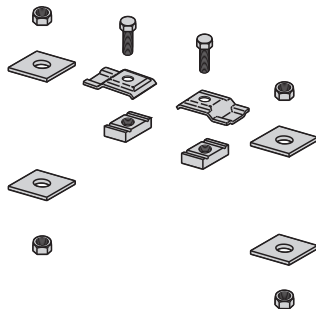

Catalog No.	
● 9ZN-5500-1/2	● 9G-5500-1/2
(1) pr. 9ZN-1205	(1) pr. 9G-1205
(2) HHC Screw 1/2 x 7/8" ZN	(2) HHC Screw 1/2" x 7/8" SS6
(2) N525 WO ZN	(2) N525 WO SS6
(4) B202 ZN 1/2" sq washer	(4) B202 HDG 1/2" sq washer
(4) HN 1/2" ZN	(4) HN 1/2" SS6

● Green = Fastest shipped items ● Black = Normal lead-time items ● Red = Normally long lead-time items

All dimensions in parentheses are millimeters unless otherwise specified.

Ladder Drop-Out

- This special designed, easy to install drop-out provides a 4" (101.6 mm) radius to protect cables exiting the cable tray from damage.
- Attaches to a ladder rung.
- Hardware included.
- (*) Insert P or G
- (‡) Insert tray width

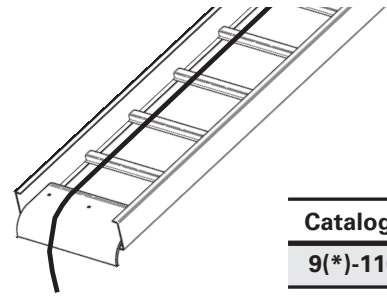
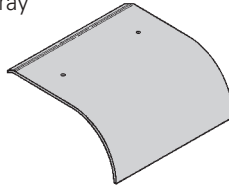

Catalog No.
9(*)-1104T-(‡)

Straight Section

- Standard length: 120" (3 m) 144" (12 ft.).
- Order catalog number based on loading depth.
- Furnished with four #10 x 1/2" plated self-drilling screws and a 99-9982 splice.
- (*) Insert P or G

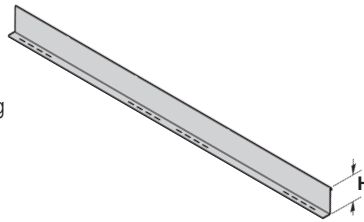

Length =
144 for 12' or 120 for 10'



Tray Series	Catalog No.	H	
		in.	(mm)
148	72(*)-Length	2.8	(58)
156	737(*)-Length	3.4	(70)
166	747(*)-Length	4.4	(91)
176	757(*)-Length	5.4	(112)

Horizontal Bend

- Horizontal Bend Barriers are flexible in order to conform to any horizontal fitting radius. Cut to length.
- Order catalog number based on loading depth.
- Furnished with three #10 x 1/2" zinc plated self-drilling screws and a 99-9982 Barrier Strip Splice.
- Standard length is 72" [6 ft.] (1829mm), sold individually.
- (*) Insert P or G

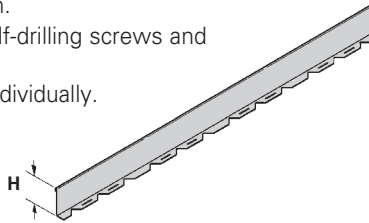

Tray Series	Catalog No.	H	
		in.	(mm)
148	72(*)-90HBFL	2.8	(58)
156	737(*)-90HBFL	3.4	(70)
166	747(*)-90HBFL	4.4	(91)
176	757(*)-90HBFL	5.4	(112)

Vertical Bend Barriers

- Vertical Bend Barriers are preformed to conform to a specific vertical fitting.
- Furnished with three #10 x 1/2" plated self-drilling screws and a 99-9982 Barrier Strip Splice.
- (*) Insert P or G
- (**) Insert 30, 45, 60 or 90 for degrees
- (t) Insert 12, 24, or 36 for radius

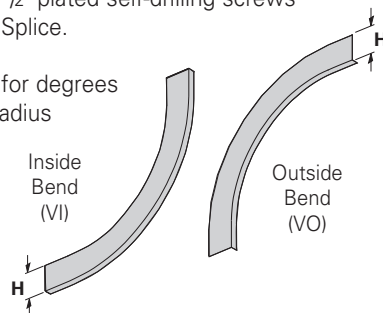

Tray Series	Catalog No.		H	
	Inside Bend	Outside Bend	in.	(mm)
148	72(*)-(**)(t)VI(t)	72(*)-(**)(t)VO(t)	2.8	(58)
156	737(*)-(**)(t)VI(t)	737(*)-(**)(t)VO(t)	3.4	(70)
166	747(*)-(**)(t)VI(t)	747(*)-(**)(t)VO(t)	4.4	(91)
176	757(*)-(**)(t)VI(t)	757(*)-(**)(t)VO(t)	5.4	(112)

Barrier Strip Splice

- Plastic splice holds adjoining barrier strips in straight alignment.
- 3" (76.2mm) long

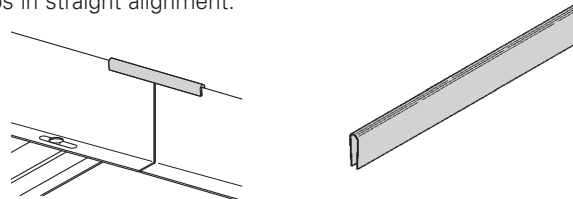

Catalog No.
● 99-9982

● Green = Fastest shipped items ● Black = Normal lead-time items ● Red = Normally long lead-time items

All dimensions in parentheses are millimeters unless otherwise specified.