



Kellems Pulling Grips are reusable tools for pulling electrical cable, bare conductor or rope. They are easy and fast to install, providing the user with a smooth, slim profile that allows for easy passage through ducts and conduit. Kellems Pulling Grips are made of the highest quality galvanized steel strand which assures the user of a long lasting grip. There is a Kellems Pulling Grip for every pulling job.

CAUTION: It is very important to comply with all of the following precautions. Failure to do so may result in property damage, personal injury or death.

1. Pulling grips are to be installed by a qualified individual in accordance with all applicable national and local safety, electrical and rigging codes.
2. Ensure that the correct grip is selected for your specific needs.
3. Do not use a pulling grip for any application other than pulling cable.
4. Thoroughly examine the grip for damage. Do not use a damaged grip.
5. Ensure that the recommended work load of the grip is suitable for the application. Never use grips at their approximated rated breaking strength. A safety factor of 5 is recommended for pulling grips.
6. Do not alter grips in any way. For example, do not modify pulling eyes, shoulders, fittings or lugs.
7. Do not attach any type of pulling hardware to any point on the grip other than the pulling eye. The pulling eye is the only acceptable means of attachment to external hardware.
8. Always apply 2 bands at 1" and 2" respectively, from the tail end of the mesh to guard against accidental release of the grip. Accidental release can occur if an object contracts and pushes against the tail end of the mesh, thereby expanding and releasing its hold.

Select The Correct Pulling Grip

Each Kellems Grip is designed to work on a specific range of cable diameters.

Step 1 Refer to the chart below to determine the style of grip best suited for your application.

Step 2 Determine your cable outside diameter.

Step 3 Find the grip size that encompasses your cable diameter.

Step 4 Estimate the tension to be put on the grip, establish the working load you require and compare this to the listed approximate breaking strength of the grip to insure that the grip will be strong enough. Refer to page V-18 for safety and working load factors.

Pulling Grip Selection Chart

Grip Style	Application	Page Number
DUA-PULL®, flexible eye	Extra high strength overhead transmission line stringing for bare or insulated conductor and synthetic rope.	V-6
Multiple strength, flexible eye	Normal overhead transmission and distribution line stringing for bare or insulated conductor.	V-7
Multiple strength, rotating eye	Normal overhead transmission and distribution line stringing for bare or insulated conductor.	V-7
K-type grip, rotating eye	Underground power cables and communication lines. Service lines into factories.	V-8
T-type grip, flexible eye	Underground power cables and communication lines. Service lines into factories.	V-9
Non-conductive, flexible eye	Pull insulated distribution cable into place.	V-10
Slack pulling, closed mesh	Remove underground cable. For pulling slack in final placement of new cable when end of cable is available.	V-10
Slack pulling, split mesh,	Remove underground cable. For pulling slack in final placement of new cable rawhide lace closing when end of cable is not available.	V-11
Slack pulling, split mesh,	Remove underground cable. For pulling slack in final placement of new cable rod closing when end of cable is not available, with rod closing for quick installation.	V-11
Light duty, flexible eye	Light pulling, underground electrical construction. Industrial plant wiring and rewiring jobs.	V-12
Junior, flexible eye	Connect bundled insulated building wire to a pulling tape. Pull wire through conduit.	V-12
Regular and rotating wire rope	Restraining wire rope in cranes and oil rigs.	V-13
Splicing	Temporary splice for cable or wire rope.	V-14
Pulling Grip Accessories	Tools, bands, swivels.	V-15, V-16
Fiber Optic Cable Pulling Grips	Pull fiber optic cable into place overhead, underground or through duct and conduit.	V-47, V-48, V-49



Safety And Working Load Factors For Wire Mesh Grips

The broad application of Kellems grips on a wide variety of objects requires that adequate safety factors be used to establish working loads. The approximate breaking strength of a Kellems grip represents an average calculation based on data established from actual direct tension testing done in our engineering laboratories.

It is impossible to catalog or guarantee a safety factor suitable for all applications as operating conditions are never the same. The tension, diameter, movement, number of objects gripped, gripping surface, and the attachments used are just some of the factors which vary with each application. These factors, together with the effects of abrasion, corrosion, prior use or abuse and any other variables of a specific application, must be considered by the user and

the grip replaced as appropriate. Where the conditions of the application are not well defined or known, or where risk of injury to persons or property is involved, a greater safety factor should be utilized.

Under normal conditions, Kellems' recommended factor of safety is five for catalog listed pulling grips, and ten for catalog listed support grips.

Any warranty as to quality, performance or fitness for use of grips is always premised on the condition that the published breaking strengths apply only to new, unused grips, and that such products are properly stored, handled, used, maintained and inspected by the user at a frequency appropriate for the use and condition of the grip.

Examples

Grip Style	Approx. Breaking Strength Lbs. (N)	Safety Factor	Max. Recommended Load Lbs. (N)	Catalog Number
Pulling Grips	27,200 (120,986)	5	5,440 (24,197)	03301027
Support Grips	1,610 (7,161)	10	161 (716)	02201018

The maximum recommended working load then is the tension to be exerted on the grip in application with a margin of safety to take care of unforeseen and unusual circumstances.

It is the end-user's decision to determine how much of a safety factor is acceptable for the application.

The metric unit of measure (force) for breaking strength and load is newtons (N). To convert from newtons to the metric unit of weight (kilograms) the conversion factor is 9.808 newtons/kilogram.

Pulling Grip Materials

Material	Features	Product Group
Galvanized steel wire	<ul style="list-style-type: none"> • High strength • Not subject to continuous outside environment 	<ul style="list-style-type: none"> • Pulling grips • Wire rope grips • Splicing grips
Non-metallic strand	<ul style="list-style-type: none"> • Superior flex life • Non-conductive • Corrosion resistant • Moderate strength 	<ul style="list-style-type: none"> • Non-conductive pulling grips

Approvals

UL and CSA Certification is indicated on appropriate product catalog pages.



Overhead Pulling DUA-PULL® Grips

DUA-PULL Pulling Grips are the highest strength pulling grips manufactured for overhead transmission line stringing applications. They have a dual function of working with both bare and insulated conductors and synthetic rope, not provided by any other grip. Kellems' patented two-over, two-under weave design gives exceptional strength and gripping ability by putting more steel mesh in contact with the cable or rope surfaces.

THIS IS THE ONLY PULLING GRIP RECOMMENDED FOR USE ON SYNTHETIC ROPE.

Application

The DUA-PULL Grips are primarily used in overhead transmission line construction where loads and safety considerations require an extra high strength grip. They are most commonly used for attaching pulling lines to conductors, conductors to running boards and "double socking" for conductor-to-conductor connections. The DUA-PULL line accommodates ACSR, ACAR, all aluminum and copper conductors. Also, the grips accommodate ground wires, messenger strands, wire ropes and synthetic ropes.

Benefits

- Made of high strength galvanized steel strand.
- Recommended for pulling bare or insulated conductor, wire rope and synthetic rope.
- DUA-PULL mesh design offers the greatest holding power for all pulling applications.
- Each grip size is color coded for fast and accurate identification and selection.
- Will mate with swivels. See page V-16.

Feed Tubes

The Kellems Feed Tube is used when assembling synthetic rope into the DUA-PULL Grip. It is required on the largest two sizes of DUA-PULL Grips. Feed Tubes are available for use on all size DUA-PULL Grips.

Benefits

- Saves time, allowing fast, easy assembly.
- Can be reused if not damaged.

Note: 1. Do not run grips or swivels over bullwheels while under tension.

2. Two Punch-Lok® bands should be firmly attached approximately 1" and 2" (2.54cm and 5.08cm) from the grip's tail. Banding is required to ensure maximum reliability and guard against accidental release. See page V-15.

3. Double braided rope, such as 2-in-1 type, should be back spliced for approximately 2/3 of the mesh length for best gripping results. Grip size should be selected by diameter of back splice.

Components

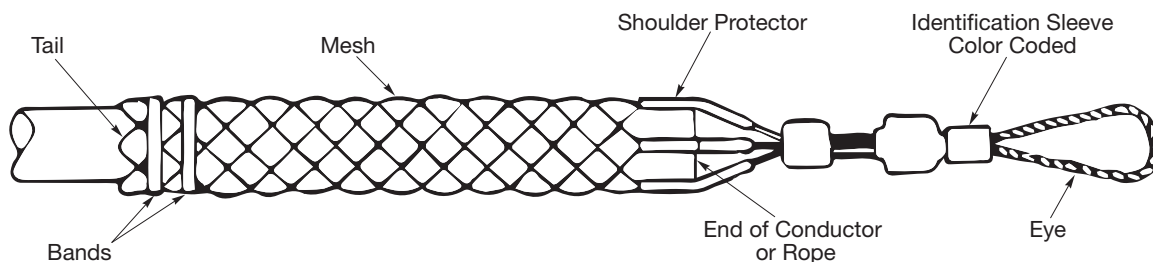



Overhead Pulling Multiple Strength Grips

Multiple Strength Pulling Grips are designed for pulling aluminum or copper bare conductor, ground wires, messenger strands, wire rope and insulated cables. They are made of high strength galvanized steel strand and feature a multi-weave mesh construction of single, double and triple weave for firm holding power.

Application

Kellems Multiple Strength Grips are ideal for overhead transmission and distribution line stringing where moderate loading is anticipated. They are economical tools for attaching conductors to pulling lines and double socking for conductor-to-conductor connections.

Rotating Eye Feature

Multiple Strength Grips are available with a forged steel rotating eye which can be attached to a swivel. The forged eye is durable, compact and streamlined and will thread through blocks and sheaves without binding. The rotating eye is not a swivel and will not turn while under tension; it can turn to relieve pulling torque when tension is relaxed. If constant swivel action is required, a swivel should be used. For swivel dimensions, see page V-16. For rotating eye dimensions, see page V-21.

Flexible Eye Feature

Multiple Strength Grips are also available with a flexible, patented wire rope eye. This compact eye will mate with a swivel, and pass through blocks and sheaves without binding.

Benefits

- Economical, high strength pulling tool.
- Multi-weave construction provides greater strength and holding power.
- Endless Weave Grip end lies flat on the cable and will not snag.

Note: 1. Do not run grips or swivels over bullwheels while under tension.

2. Two Punch-Lok® bands should be firmly attached approximately 1" and 2" (2.54cm and 5.08cm) from the grip's tail. Banding is required to ensure maximum reliability and guard against accidental release. See page V-15.

Components

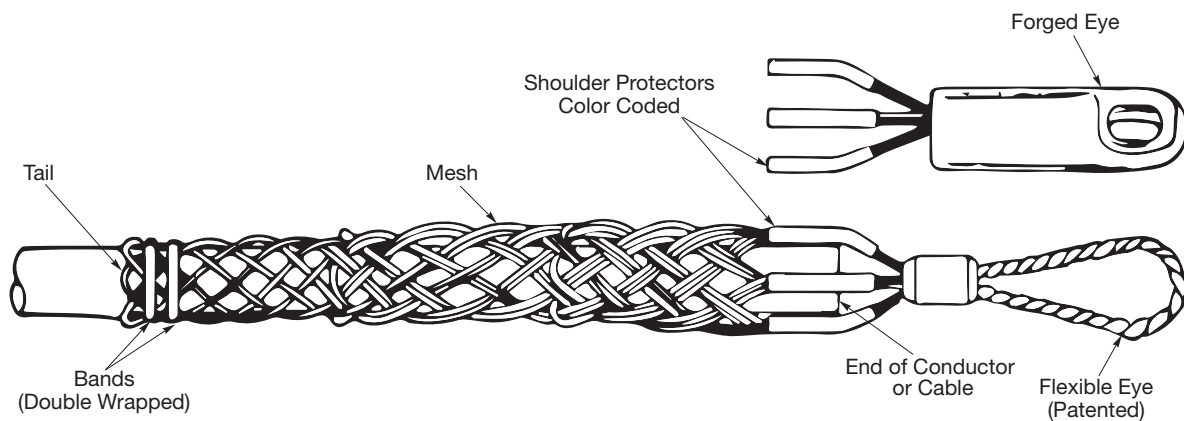



Underground Pulling K-Type and T-Type Grips

K-Type Application

Rotating Eye, K-Type Pulling Grips are specially designed for use in the installation of underground power cables, communication lines and service lines into factories, shopping centers, construction projects and general underground electrical construction.

Rotating Eye Feature

K-Type Grips come equipped with a forged steel rotating eye which can be attached to a swivel. The forged eye is durable, compact and streamlined, and will thread through blocks and sheaves without binding.

The rotating eye is not a swivel and will not turn while under tension; it can turn to relieve pulling torque when the tension is relaxed. If constant swivel action is required, a swivel should be used. For swivel dimensions, see page V-16.

Benefits

- An economical tool for pulling cable.
- Safe, rugged and dependable.
- Equipped with a rotating eye for spin out of pulling torque after load release.
- Easily installed and removed.

Rotating Eye Dimensions

Rotating Eye Dimensions Inches (cm)	A	B	C	D	F
7/8" (2.22)	7/8" (2.22)	9/32" (.71)	1/2" (1.27)	7/8" (2.22)	2 5/8" (6.67)
1" (2.54)	1" (2.54)	1/2" (1.27)	9/16" (1.43)	1 3/16" (2.06)	3 1/2" (8.89)
1 1/8" (3.49)	1 1/8" (3.49)	1/2" (1.27)	1 1/16" (1.75)	1" (2.54)	4 1/2" (11.43)
1 5/8" (4.13)	1 5/8" (4.13)	5/8" (1.59)	7/8" (2.22)	1 3/16" (3.02)	5 5/16" (13.49)
1 7/8" (4.76)	1 7/8" (4.76)	2 1/32" (1.67)	1" (2.54)	1 3/8" (3.49)	6 1/8" (15.56)

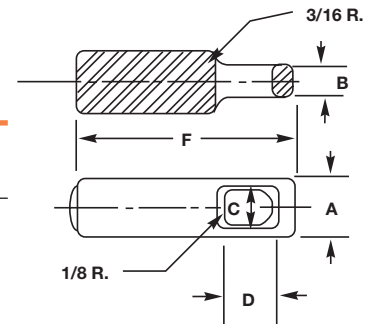

T-Type

Kellems Flexible T-Type Pulling Grips are made of high strength galvanized steel strand. They feature double weave mesh for positive holding power in medium to heavy pulling jobs. The grip eye will easily attach to a swivel.

Application

T-Type Pulling Grips are used for the installation of underground power cables, communication lines and service lines into factories, construction projects and for general underground electrical construction. Available in two mesh lengths, short for medium pulls, and standard for general purpose pulling.

Benefits

- Will pull a single cable or cable bundles.
- Patented flexible eye design provides flexibility to follow line of pull.
- A dependable, reusable pulling tool.
- Easily installed and removed.
- Mates easily with a swivel. See page V-16.



Special Purpose Grips

Non-Conductive Pulling Grips

Kellems Non-Conductive Pulling Grips, made of a high strength, non-conductive aramid fiber, are available for pulling single cable or cable bundles. Their braided double weave design adds strength and positive holding power.

Application

Kellems Non-Conductive Pulling Grips were developed for use by utilities for pulling overhead distribution lines in close proximity to energized lines and hardware.

Benefits

- Color coded for fast on-site selection.
- Extra flexibility for easy installation.
- Non-metallic mesh provides for safe pulls over "hot" areas.
- Pellethane jacketed aramid fiber mesh resists abrasion.
- Grips are corrosion resistant.

Note: Taping is required to guard against accidental release and to insure maximum reliability. Apply vinyl plastic electrical tape starting 2" to 3" (5.08cm to 7.62cm) from the tail of the grip onto 2" to 3" (5.08cm to 7.62cm) of cable.

Slack Pulling Grips

Slack Pulling Grips are offered in three styles made of galvanized steel. The closed type is used when the cable end is accessible. When not, there are split lace and split rod closing styles. All grips feature single offset eye for easy attachment to a pulling line.

Application

Slack Grips are widely used in pulling slack for final placement of under ground cable after it has been pulled in. They are also used for removing cable. Standard mesh lengths are generally used in restricted space for short pulls. Longer lengths are used for higher pulling loads where space is not restricted.

Benefits

- Easy attachment to pulling lines.
- Reusable rawhide lace for lace closure.
- Galvanized steel for strength.

*Note: 1. Replacement rawhide lace. Catalog number 20920002.
2. See page V-43 for lace and rod closing instructions.*



Commercial Construction/Light Duty Grips

Light Duty Pulling Grips

Light Duty Pulling Grips are made of galvanized steel in a single weave construction. They feature a flexible eye for easy attachment to a pulling line.

Application

Light Duty Grips are used in general underground electrical construction where pulling tensions are low. They are easy tools to use in wiring industrial plants and commercial buildings.

Benefits

- Perfect tools for light pulling jobs.
- Installs easily on cable.
- Strong, galvanized steel construction.

Junior Duty Pulling Grips

Junior Pulling Grips feature a strong galvanized steel, single weave mesh. A flexible eye easily attaches to a pulling line, snake or fish tape.

Application

Designed to pull building wire, Junior grips are safe tools to use in pulling wire at low tension through conduit during electrical construction.

Benefits

- Installs easily over building wire.
- Strong secure grip.
- Reusable.
- Pulls single cable or cable bundles.

Junior Grip Kit

Junior Grip Kit contains 6 grips, one of each size. Catalog number **033051114**. See page V-12.

Note: See page V-26 for building wire selection chart.



Splicing Grips

Wire Rope Splicing

Kellems Wire Rope Grips are made of high strength galvanized steel strand in a construction of triple, double and single weave for superior gripping ability. They are available with or without a rotating barrel which will help eliminate twist in the old rope from being transferred to the new rope.

Application

Wire Rope Grips are used for changing wire rope on oil derricks, large cranes, overhead cranes and drag lines. It provides a quick, safe, inexpensive temporary splice. By installing the used wire rope in one end and the new rope in the other, the new wire rope can be pulled in as the old one is pulled out.

Benefits

- High strength for secure pulling.
- Easy installation.
- Flexible to pass through sheaves and blocks.

Note: 1. During installation each end of the grip should be banded and taped down securely over the rope to insure smooth passage through sheaves and to guard against accidental release. See page V-15 for end bands.

2. The rotating barrel is not a swivel and will not turn while under tension. It can turn to relieve pulling torque when tension is relaxed.

Cable Splicing

Splicing Grips are made of galvanized steel in double or single weave mesh construction. They are available in various lengths and sizes to suit most applications.

Application

Splicing Grips are used as a temporary splice for rope, cable or wire rope. They can also be used as cable reinforcement, and can act as a shield to protect cables and hoses from abrasion.

Benefits

- Easily installed or removed.
- Galvanized steel construction for strength.
- Flexible to follow cable path.

Note: 1. During installation, each end of the splicing grip should be banded and taped down securely to the cable to insure smooth passage with the cable and guard against accidental release.

2. See page V-15 for end bands.



Multiple Cable Selection Charts for Cables and Wires of Unequal Diameters

How to choose the correct grip size:

1. Find the Grip Circumference Range by measuring the circumference of the bundle of different diameter cables to be gripped (see illustration).
2. Divide the bundle circumference by 3.14 to determine the diameter.
3. Choose a grip offering a range of cable diameters the same as the cable diameter.

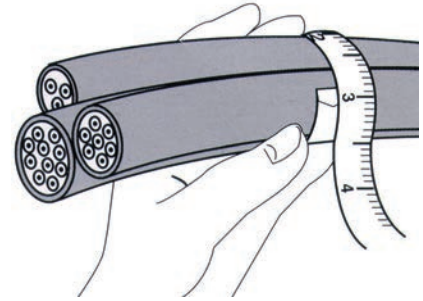

For Pulling Grips*

CAUTION: When a grip is used on multiple cables, the tail end of the grip should be banded after positioning on the cables.

For Cables of Equal Diameters

Under "Number of Cables in One Grip", find the diameter of your single cable in vertical column. Read the grip diameter range to the right.

If your diameter is the maximum of the range shown, go to the next larger size for Split Grips, stay with the same size for Closed Grips.

Example: Three cables, each with .89" (2.26cm) diameter, for a Closed Grip select the 1.50"-1.74" (3.81cm-4.42cm) range, for a Split Grip select the 1.75"-1.99" (4.44cm-5.05cm) range.

Number of Cables in One Grip

2	3	4	5	6 and 7	8	9	Grip Dia. Range Inches (cm)
.30-.38 (.76-.97)	.25-.31 (.63-.79)	.22-.27 (.56-.69)	.19-.24 (.48-.60)	.17-.22 (.43-.56)	.15-.19 (.38-.48)	.14-.18 (.36-.46)	.50-.61 (1.27-1.55)
.38-.44 (.97-1.12)	.31-.36 (.79-.91)	.27-.31 (.69-.79)	.24-.29 (.61-.74)	.22-.26 (.56-.66)	.19-.23 (.48-.58)	.18-.21 (.46-.53)	.62-.74 (1.57-1.88)
.44-.59 (1.12-1.50)	.36-.49 (.91-1.24)	.31-.42 (.79-1.07)	.29-.38 (.74-.97)	.26-.34 (.66-.86)	.23-.31 (.58-.79)	.21-.28 (.53-.71)	.75-.99 (1.90-2.51)
.59-.75 (1.50-1.90)	.49-.63 (1.24-1.60)	.42-.54 (1.07-1.37)	.38-.48 (.97-1.22)	.34-.43 (.86-1.09)	.31-.39 (.79-.99)	.28-.35 (.71-.89)	1.00-1.24 (2.54-3.15)
.75-.90 (1.90-2.29)	.63-.76 (1.60-1.93)	.54-.65 (1.37-1.65)	.48-.58 (1.22-1.47)	.43-.52 (1.09-1.32)	.39-.46 (.99-1.17)	.35-.42 (.89-1.07)	1.25-1.49 (3.17-3.78)
.90-1.07 (2.29-2.72)	.76-.89 (1.93-2.26)	.65-.77 (1.65-1.96)	.58-.67 (1.47-1.70)	.52-.60 (1.32-1.52)	.46-.54 (1.17-1.37)	.42-.49 (1.07-1.24)	1.50-1.74 (3.81-4.42)
1.07-1.22 (2.72-3.10)	.89-1.02 (2.26-2.59)	.77-.88 (1.96-2.24)	.67-.77 (1.70-1.96)	.60-.69 (1.52-1.75)	.54-.62 (1.37-1.57)	.49-.56 (1.24-1.42)	1.75-1.99 (4.44-5.05)
1.22-1.53 (3.10-3.89)	1.02-1.28 (2.59-3.25)	.88-1.10 (2.24-2.79)	.77-.96 (1.96-2.44)	.69-.86 (1.75-2.18)	.62-.77 (1.57-1.96)	.56-.71 (1.42-1.80)	2.00-2.49 (5.08-6.32)
1.53-1.83 (3.89-4.65)	1.28-1.53 (3.25-3.89)	1.10-1.32 (2.79-3.35)	.96-1.16 (2.44-2.95)	.86-1.03 (2.18-2.62)	.77-.93 (1.96-2.36)	.71-.85 (1.80-2.16)	2.50-2.99 (6.35-7.59)
1.83-2.14 (4.65-5.44)	1.53-1.79 (3.89-4.55)	1.32-1.54 (3.35-3.91)	1.16-1.35 (2.95-3.43)	1.03-1.20 (2.62-3.05)	.93-1.08 (2.36-2.74)	.85-.99 (2.16-2.51)	3.00-3.49 (7.62-8.86)
2.14-2.44 (5.44-6.20)	1.79-2.05 (4.55-5.21)	1.54-1.76 (3.91-4.47)	1.35-1.54 (3.43-3.91)	1.20-1.37 (3.05-3.48)	1.08-1.24 (2.74-3.15)	.99-1.13 (2.51-2.87)	3.50-3.99 (8.89-10.13)
2.44-2.75 (6.20-6.98)	2.05-2.30 (5.21-5.84)	1.76-1.98 (4.47-5.03)	1.54-1.74 (3.91-4.42)	1.37-1.55 (3.48-3.94)	1.24-1.39 (3.15-3.53)	1.13-1.27 (2.87-3.23)	4.00-4.49 (10.16-11.40)
2.75-3.06 (6.98-7.77)	2.30-2.56 (5.84-6.50)	1.98-2.20 (5.03-5.59)	1.74-1.93 (4.42-4.90)	1.55-1.72 (3.94-4.37)	1.39-1.55 (3.53-3.94)	1.27-1.41 (3.23-3.58)	4.50-4.99 (11.43-12.67)

Note: *This chart is not to be used for Conduit Riser Grips. Refer to the chart for Conduit Riser multiple cable section. It is always recommended that, when multiple cables are installed in a pulling grip, the tail end be banded and tightly taped after installation on the cable bundle. See page V-15 for end bands.



Junior Pulling Grip Selection Chart

These charts are a general guide to assist in the selection of the correct Junior Pulling Grip for pulling various groupings of building wire. It is not intended to be restrictive inasmuch as the use of "dummy" wires (short pieces of wire used to fill out the Grip) or the tight taping of the wires into a compact bundle may increase or decrease the number of wires per Grip.

T.H.W.N., T.H.H.N. and X.H.H.W. Building Wire

Cable Diameter Range In. (cm)	Approx. Breaking Strength Lbs. (N)	Approximate Number Of Wires In One Grip										Model	Catalog Number
		#14 19 Strand	#12 19 Strand	#10 19 Strand	#8 19 Strand	#6 19 Strand	#4 19 Strand	#3 19 Strand	#2 19 Strand	#1 37 Strand	#1/0 37 Strand		
.25-.36 (.63-.91)	450 (2,002)	4-8	3-6	2-3	2	1	1	1	—	—	—	J 25	03305001
.37-.49 (.94-1.24)	900 (4,003)	9-16	6-11	4-6	3	2	—	—	1	1	1	J 37	03305002
.50-.61 (1.27-1.55)	1,300 (5,782)	16-25	11-17	7-10	4-5	3-4	2	2	—	—	—	J 50	03305003
.62-.74 (1.57-1.88)	1,950 (8,674)	26-37	18-25	11-14	6-8	5-6	3	3	2	2	—	J 62	03305004
.75-.99 (1.90-2.51)	2,800 (12,454)	37-66	26-47	15-27	9-16	6-11	4-7	4-5	3-4	3	2-3	J 75	03305005
1.00-1.24 (2.54-3.15)	3,900 (17,347)	66-104	47-74	28-43	16-24	11-17	8-10	6-8	5-7	4-5	4	J 100	03305006

R.H.H., R.H., R.W. and R.H.W. Building Wire

Cable Diameter Range In. (cm)	Approx. Breaking Strength Lbs. (N)	Approximate Number Of Wires In One Grip										Model	Catalog Number
		#14 7 Strand	#12 7 Strand	#10 7 Strand	#8 7 Strand	#6 7 Strand	#4 7 Strand	#2 7 Strand	#1 7 Strand	#1/0 19 Strand			
.25-.36 (.63-.91)	450 (2,002)	2	2	1	1	—	—	—	—	—	—	J 25	03305001
.37-.49 (.94-1.24)	900 (4,003)	3	2-3	2	—	1	1	1	—	—	—	J 37	03305002
.50-.61 (1.27-1.55)	1,300 (5,782)	4-5	4-5	3-4	2	—	—	—	1	—	—	J 50	03305003
.62-.74 (1.57-1.88)	1,950 (8,674)	6-8	6-7	4-5	3	2	2	—	—	1	—	J 62	03305004
.75-.99 (1.90-2.51)	2,800 (12,454)	9-16	8-14	6-10	4-6	3-4	3-4	2-3	2	—	—	J 75	03305005
1.00-1.24 (2.54-3.15)	3,900 (17,347)	16-24	15-22	11-16	7-10	5-7	4-6	4	3	3	2-3	J 100	03305006

T.H.W. Building Wire

Cable Diameter Range In. (cm)	Approx. Breaking Strength Lbs. (N)	Approximate Number Of Wires In One Grip										Model	Catalog Number
		#14 7 Strand	#12 7 Strand	#10 7 Strand	#8 7 Strand	#6 7 Strand	#4 7 Strand	#2 7 Strand	#1 7 Strand	#1/0 19 Strand			
.25-.36 (.63-.91)	450 (2,002)	2-4	2-3	2	1	1	1	—	—	—	—	J 25	03305001
.37-.49 (.94-1.24)	900 (4,003)	5-7	4-5	3-4	2	—	—	1	—	—	—	J 37	03305002
.50-.61 (1.27-1.55)	1,300 (5,782)	8-11	6-8	5-7	3-4	2	2	—	1	1	—	J 50	03305003
.62-.74 (1.57-1.88)	1,950 (8,674)	12-16	9-12	8-10	5-6	3-4	3	2	—	—	—	J 62	03305004
.75-.99 (1.90-2.51)	2,800 (12,454)	17-30	13-24	11-19	7-10	5-7	4-5	3-4	2	2	—	J 75	03305005
1.00-1.24 (2.54-3.15)	3,900 (17,347)	31-48	25-37	20-30	11-17	8-11	6-8	5-6	3-4	3	—	J 100	03305006



Solid eye assemblies provide eye reinforcement at support hardware

Four eye styles available: single (shown), double, universal, and offset

Identification tag shows: catalog number, diameter range, agency approval, and bar code

The strand equalizer positions wires for equal loading throughout the entire grip length

The positive action mesh grip is designed for light duty up to heavy duty. Closed grips fit over the cable end, split grips wrap around the cable mid-span. The standard material is nonmagnetic, tin-coated bronze. Selected items are available in stainless steel. For exceptional immunity to rust and corrosion with superior strength and flexibility for heavy duty support application in harsh environments; contact the factory

The endless weave provides easy installation onto cable and can be easily repositioned

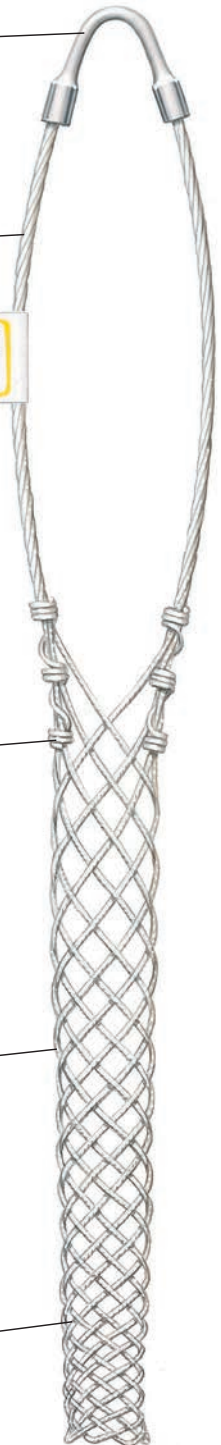



IMPORTANT
 Read all breaking strength, safety and technical data relating to this product. Pages V-41 to V-45.



Safety Spring

Maximum Deflection Inches/Lbs (cm/N)	Approx. Breaking Strength Lbs. (N)	Length* Inches (cm)	Diameter Inches (cm)	Model Lbs. (N)	Catalog Number
2¾" at 40 lbs. (6.98 at 178)	500 (2,224)	8.25" (20.95)	.75" (1.90)	40 lb. spring (178)	20302001
3½" at 80 lbs. (7.94 at 356)	850 (3,781)	8.25" (20.95)	1" (2.54)	80 lb. spring (356)	20302002

Note: Springs can be used with single eye grips by disassembling drawbar from coil, placing through eye and replacing drawbar.
 *No load.



Single Eye, Wide Range

Cable Diameter Range Inches (cm)	Approx. Breaking Strength Lbs. (N)	E Inches (cm)	M Inches (cm)	Catalog Number
.24"- .32" (.61-.81)	350 (1,557)	3" (7.62)	3.5" (8.89)	073041276**
.32"- .43" (.81-1.09)	450 (2,002)	4" (10.16)	4" (10.16)	073041277
.43"- .56" (1.09-1.42)	550 (2,446)	6" (15.24)	4.75" (12.06)	073041278
.56"- .73" (1.42-1.85)	1,000 (4,448)	7" (17.78)	6" (15.24)	073041279
.73"- .85" (1.85-2.16)	1,400 (6,227)	7" (17.78)	6.75" (17.14)	073041280
.85"-1.00" (2.16-2.54)	1,400 (6,227)	8" (20.32)	8" (20.32)	073041281
1.00"-1.25" (2.54-3.17)	1,500 (6,672)	9" (22.86)	9.5" (24.13)	073041282

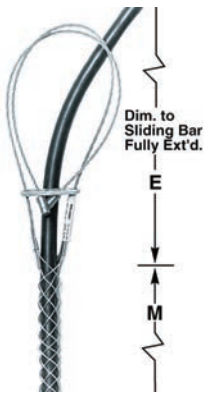

Universal Eye, Wide Range

Cable Diameter Range Inches (cm)	Approx. Breaking Strength Lbs. (N)	E Inches (cm)	M Inches (cm)	Catalog Number
.32"- .43" (.81-1.09)	450 (2,002)	10" (25.40)	4" (10.16)	073041284
.43"- .56" (1.09-1.42)	550 (2,446)	12" (30.48)	4.75" (12.06)	073041285
.56"- .73" (1.42-1.85)	1,000 (4,448)	13" (33.02)	6" (15.24)	073041286
.73"- .85" (1.85-2.16)	1,400 (6,227)	13" (33.02)	6.75" (17.14)	073041287
.85"-1.00" (2.16-2.54)	1,400 (6,227)	14" (35.56)	8" (20.32)	073041288
1.00"-1.25" (2.54-3.17)	1,500 (6,672)	15" (38.10)	9.5" (24.13)	073041289

Note: E-Eye length. M-Mesh length at nominal diameter.
 **Item indicated is not UL listed.

Bus Drop Grips and Safety Springs

Kellems Bus Drop Grips are offered with either a single eye or universal bale attachment. The mesh is single weave galvanized steel with the patented wide range construction. They are suitable for indoor use only. Consult Technical Service for Stainless Steel Grips.

Application

Bus Drop Grips provide a safe, easy and economical method to support flexible cord or bus drop cable at bus duct and other industrial areas.

Benefits

- Easily installed.
- Absorb tension, vibration and pull with no cable damage.
- Patented mesh construction.

Safety Spring

Springs can be used with single eye grips by disassembling drawbar from coil, placing through eye and replacing drawbar.

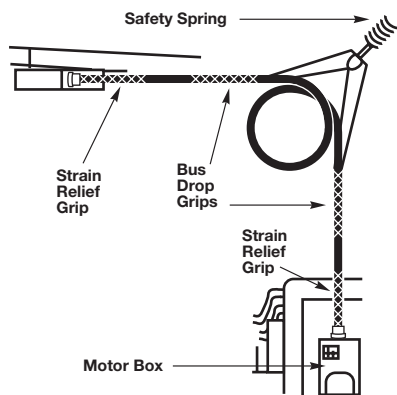



Kellems® Support Grips

Kellems Support Grips are used to hold the weight of electrical cable as it hangs in a vertical, sloping or horizontal position. Electrical cable must be supported, or its dead weight can cause excessive strain or pullout at the connections resulting in power failure. Support grips also absorb additional strain from flexure, vibration, expansion and contraction. Kellems Support Grips listed in this catalog are made of high grade, non-magnetic tin-coated bronze strand. Stainless steel grips, made of alloy 302-304 SST for severe service or unusual environmental conditions, are available on request.

Select the Correct Support Grip

Each Kellems grip is designed to work on a specific range of cable diameters.

- Step 1** Refer to the Kellems chart below to determine the grip style best suited for your application.
- Step 2** Determine your cable outside diameter.
- Step 3** Find the grip size that encompasses your cable diameter.
- Step 4** Whenever possible, use a closed mesh that assembles over the cable end. If the cable end is not available, use a split mesh.
- Step 5** Where available, select an eye style that suits your needs.
- Step 6** Select the proper material—tinned bronze or stainless steel*.
- Step 7** Estimate the tension to be put on the grip, establish the working load you require and compare this to the listed approximate breaking strength of the grip to insure that the grip will be strong enough. Refer to page V-42 for safety and working load considerations.

CAUTION: It is very important to comply with all of the following precautions.

1. Support grips are to be installed by a qualified individual in accordance with all applicable national and local safety, electrical and rigging codes.
2. Ensure that the correct grip is selected for your specific needs.
3. Do not use a support grip for any application other than supporting cable.
4. Thoroughly examine the grip for damage. Do not use a damaged grip.
5. Ensure that the recommended work load of the grip is suitable for the application. Never use grips at their approximated rated breaking strength. A safety factor of 10 is recommended for support grips.
6. Do not alter grips in any way. For example, do not flatten, straighten, bend or otherwise modify eye tubes, hooks, and strand equalizers.
7. Do not attach any type of hook, clamp or other hardware directly to the stranded bale of a “U” eye support grip. The formed eye tube is the only acceptable means of attachment to external hardware.
8. Always apply 2 bands at 1" and 2" respectively, from the tail end of the mesh to guard against accidental release of the grip. Accidental release can occur if an object contracts and pushes against the tail end of the mesh, thereby expanding and releasing it's hold.

Support Grip Selection Chart

Grip Styles	Application	Page
Closed mesh	Standard, permanent support, cable end available.	V-28 to V-36
Split lace closing	Standard, permanent support, cable end unavailable.	V-28 to V-33
Split rod closing	Standard, temporary support, cable end unavailable. Tape or band tail end of wire mesh grip after positioning for permanent support.	V-28 to V-31
Material*	Tin-coated bronze standard or stainless steel by special request.	V-28 to V-34
Standard support grips	Support vertical runs to 99 ft. loads to 600 lbs.	V-28 to V-31
Heavy duty grips	Support vertical runs over 100 ft. loads over 600 lbs.	V-32, V-33
Service drop	Light duty to support service entrance cable.	V-34, V-35
Bus drop	Light duty support, indoors only, on Bus drop cable.	V-36
Conduit riser	Support cable runs in rigid (Schedule 40) conduit.	V-37 to V-39
Fiber optic cable support grips	Support fiber optic cable.	V-50

*Note: *Most catalog listed support grips are made of tin-coated bronze strand. To order stainless steel support grips, change the first three catalog number digits from 022-0x-xxx to 024-0x-xxx. Consult Technical Service for details.*

Eye Styles



Single



Double



Universal



Offset



Safety And Working Load Factors For Wire Mesh Grips

The broad application of Kellems grips on a wide variety of objects requires that adequate safety factors be used to establish working loads. The approximate breaking strength of a Kellems grip represents an average calculation based on data established from actual direct tension testing done in our engineering laboratories.

It is impossible to catalog or guarantee a safety factor suitable for all applications as operating conditions are never the same. The tension, diameter, movement, number of objects gripped, gripping surface, and the attachments used are just some of the factors which vary with each application. These factors, together with the effects of abrasion, corrosion, prior use or abuse and any other variables of a specific application, must be considered by the user and

the grip replaced as appropriate. Where the conditions of the application are not well defined or known, or where risk of injury to persons or property is involved, a greater safety factor should be utilized.

Under normal conditions, Kellems' recommended factor of safety is five for catalog listed pulling grips, and ten for catalog listed support grips.

Any warranty as to quality, performance or fitness for use of grips is always premised on the condition that the published breaking strengths apply only to new, unused grips, and that such products are properly stored, handled, used, maintained, and inspected by the user at a frequency appropriate for the use and condition of the grip.

Examples

Grip Style	Approx. Breaking Strength Lbs. (N)	Safety Factor	Max. Recommended Load Lbs. (N)	Catalog Number
Pulling Grips	27,200 (120,986)	5	5,440 (24,197)	03301027
Support Grips	1,610 (7,161)	10	161 (716)	02202019

The maximum recommended working load is the tension to be exerted on the grip in application with a margin of safety to take care of unforeseen and unusual circumstances.

It is the end-user's decision to determine how much of a safety factor is acceptable for the application.

The metric unit of measure (force) for breaking strength and load is newtons (N). To convert from newtons to the metric unit of weight (kilograms) the conversion factor is 9.808 newtons/kilogram.

Support Grip Materials

Material	Features	Grip Type
Tin-coated bronze wire	<ul style="list-style-type: none"> • Corrosion resistant for normal outside areas • Non-magnetic • Moderate strength 	<ul style="list-style-type: none"> • Support grips • Service drop grips • Conduit riser grips
Stainless steel wire (302-304)	<ul style="list-style-type: none"> • High strength • Corrosion resistant 	<ul style="list-style-type: none"> • Support grips • Hose containment grips
Galvanized steel wire	<ul style="list-style-type: none"> • Slightly magnetic • Not subject to continuous outside environment 	<ul style="list-style-type: none"> • Bus drop grips

Approvals

CSA Certifications are indicated on appropriate product catalog pages.

Note: It is always recommended that the tail end of the grip be banded after the installation on the cable to prevent accidental release of the mesh. See page V-15 for end bands.



Split Support Grip Lace Closing Instructions

Single Weave Grips should be laced with single strand lacing; double weave with double strand. Lacing strands should be the same material as the grip. Kellems supplies the appropriate lacing with each grip.

1. Start the lacing at the lead or anchoring end of the grip. Thread the lacings through the first two loops of the split and pull through until the lacings are centered at this point. Lace as you would your shoe, crossing the lacings before lacing the next two loops.
2. Don't pull lacing too tight. Leave a space between adjoining loops approximately equal to the width of one diamond of the mesh.
3. Twist the lacing strands tightly together at the tail end of the grip.
4. Wrap the ends of the lacings once or twice tightly around the tail of the grip, twisting the ends together securely. Excess lace can be cut off.



Split Support Grip Rod Closing Instructions

The stainless steel rod is a precise built-in feature which makes threading easy and fast. The strands of the mesh pass around the rod and match up with the strands from the opposite direction. The rod does not touch the cable at any point and therefore cannot cut the cable. Rod Closing Grips are reusable. They may be removed and reused as many times as desired.

1. Fast to install

Wrap the grip around the cable and thread the rod through the pre-formed loops with a corkscrew motion, using the curved end of the rod to engage the loops.

2. The action required is a steady push and twist simultaneously. The fingers of the left hand are used to bring the loops together just ahead of the hook on the end of the rod.
3. To remove, simply pull the rod out.





For Support Grips Only*

Multiple Cable Selection Charts for Cables and Wires of Unequal Diameters

How to choose the correct grip size:

1. Find the Grip Circumference Range by measuring the circumference of the bundle of different diameter cables to be gripped (see illustration).
2. Divide the bundle circumference by 3.14 to determine the diameter.
3. Choose a grip offering a range of cable diameters the same as the cable diameter.

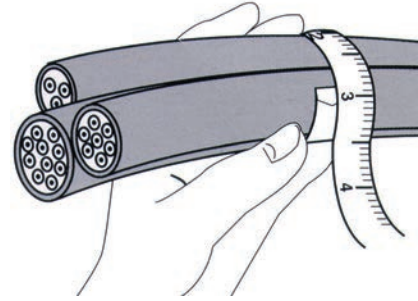

For Cables of Equal Diameters

Under "Number of Cables in One Grip", find the diameter of your single cable in vertical column. Read the grip diameter range to the right.

If your diameter is the maximum of the range shown, go to the next larger size for Split Grips, stay with the same size for Closed Grips.

Example: 3 cables, each with .89" (2.26) diameter, for a Closed Grip select the 1.50"-1.74" (3.81-4.42) range, for a Split Grip select the 1.75"-1.99" (4.44-5.05) range.

Number of Cables in One Grip

2	3	4	5	6 and 7	8	9	Grip Dia. Range Inches (cm)
.30-.38 (.76-.97)	.25-.31 (.63-.79)	.22-.27 (.56-.69)	.19-.24 (.48-.61)	.17-.22 (.43-.56)	.15-.19 (.38-.48)	.14-.18 (.36-.46)	.50-.61 (1.27-1.55)
.38-.44 (.97-1.12)	.31-.36 (.79-.91)	.27-.31 (.69-.79)	.24-.29 (.61-.74)	.22-.26 (.56-.66)	.19-.23 (.48-.58)	.18-.21 (.46-.53)	.62-.74 (1.57-1.88)
.44-.59 (1.12-1.50)	.36-.49 (.91-1.24)	.31-.42 (.79-1.07)	.29-.38 (.74-.97)	.26-.34 (.66-.86)	.23-.31 (.58-.79)	.21-.28 (.53-.71)	.75-.99 (1.90-2.51)
.59-.75 (1.50-1.90)	.49-.63 (1.24-1.60)	.42-.54 (1.07-1.37)	.38-.48 (.97-1.22)	.34-.43 (.86-1.09)	.31-.39 (.79-.99)	.28-.35 (.71-.89)	1.00-1.24 (2.54-3.15)
.75-.90 (1.90-2.29)	.63-.76 (1.60-1.93)	.54-.65 (1.37-1.65)	.48-.58 (1.22-1.47)	.43-.52 (1.09-1.32)	.39-.46 (.99-1.17)	.35-.42 (.89-1.07)	1.25-1.49 (3.17-3.78)
.90-1.07 (2.29-2.72)	.76-.89 (1.93-2.26)	.65-.77 (1.65-1.96)	.58-.67 (1.47-1.70)	.52-.60 (1.32-1.52)	.46-.54 (1.17-1.37)	.42-.49 (1.07-1.24)	1.50-1.74 (3.81-4.42)
1.07-1.22 (2.72-3.10)	.89-1.02 (2.26-2.59)	.77-.88 (1.96-2.24)	.67-.77 (1.70-1.96)	.60-.69 (1.52-1.75)	.54-.62 (1.37-1.57)	.49-.56 (1.24-1.42)	1.75-1.99 (4.44-5.05)
1.22-1.53 (3.10-3.89)	1.02-1.28 (2.59-3.25)	.88-1.10 (2.24-2.79)	.77-.96 (1.96-2.44)	.69-.86 (1.75-2.18)	.62-.77 (1.57-1.96)	.56-.71 (1.42-1.80)	2.00-2.49 (5.08-6.32)
1.53-1.83 (3.89-4.65)	1.28-1.53 (3.25-3.89)	1.10-1.32 (2.79-3.35)	.96-1.16 (2.44-2.95)	.86-1.03 (2.18-2.62)	.77-.93 (1.96-2.36)	.71-.85 (1.80-2.16)	2.50-2.99 (6.35-7.59)
1.83-2.14 (4.65-5.44)	1.53-1.79 (3.89-4.55)	1.32-1.54 (3.35-3.91)	1.16-1.35 (2.95-3.43)	1.03-1.20 (2.62-3.05)	.93-1.08 (2.36-2.74)	.85-.99 (2.16-2.51)	3.00-3.49 (7.62-8.86)
2.14-2.44 (5.44-6.20)	1.79-2.05 (4.55-5.21)	1.54-1.76 (3.91-4.47)	1.35-1.54 (3.43-3.91)	1.20-1.37 (3.05-3.48)	1.08-1.24 (2.74-3.15)	.99-1.13 (2.51-2.87)	3.50-3.99 (8.89-10.13)
2.44-2.75 (6.20-6.98)	2.05-2.30 (5.21-5.84)	1.76-1.98 (4.47-5.03)	1.54-1.74 (3.91-4.42)	1.37-1.55 (3.48-3.94)	1.24-1.39 (3.15-3.53)	1.13-1.27 (2.87-3.23)	4.00-4.49 (10.16-11.40)
2.75-3.06 (6.98-7.77)	2.30-2.56 (5.84-6.50)	1.98-2.20 (5.03-5.59)	1.74-1.93 (4.42-4.90)	1.55-1.72 (3.94-4.37)	1.39-1.55 (3.53-3.94)	1.27-1.41 (3.23-3.58)	4.50-4.99 (11.43-12.67)

Note: *This chart is to be used for determining grip size when multiple cables are held in a single Support Grip. For Conduit Riser multiple cable selection, see page V-45. It is always recommended that, when multiple cables are installed in a Support Grip, the tail end of the grip be banded after installation on the cable bundle. See page Tech-23 for cable and wire charts.



For Conduit Riser Grips Only*

Multiple Cable Selection Charts for Cables and Wires of Unequal Diameters

How to choose the correct grip size:

1. Find the Grip Circumference Range by measuring the circumference of the bundle of different diameter cables to be gripped (see illustration).
2. Divide the bundle circumference by 3.14 to determine the diameter.
3. Choose a grip offering a range of cable diameters the same as the cable diameter.

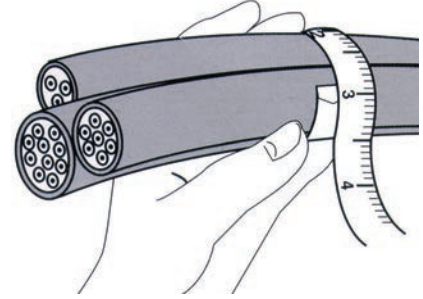

For Cables of Equal Diameters

Under "Number of Cables in One Grip", find the diameter of your single cable in vertical column. Read the grip diameter range to the right.

If your diameter is the maximum of the range shown, go to the next larger size for Split Grips, stay with the same size for Closed Grips.

Example: 3 cables, each with .85" (2.16) diameter, for a Closed Grip select the 1.50"-1.74" (3.81-4.42) range, for a Split Grip select the 1.75"-1.99" (4.44-5.05) range.

Number of Equal Diameter Cables in One Grip

2	3	4	5	6 and 7	8	9	Grip Dia. Range Inches (cm)
.29-.36 (.74-.91)	.24-.30 (.61-.76)	.21-.25 (.53-.63)	.18-.22 (.46-.56)	.16-.20 (.41-.51)	.15-.18 (.38-.46)	.14-.17 (.36-.43)	.50-.62 (1.27-1.57)
.37-.43 (.94-1.09)	.31-.36 (.79-.91)	.26-.30 (.66-.76)	.23-.27 (.58-.69)	.21-.24 (.53-.61)	.19-.22 (.48-.56)	.18-.20 (.46-.51)	.63-.74 (1.60-1.88)
.44-.58 (1.12-1.47)	.37-.48 (.94-1.22)	.31-.41 (.79-1.04)	.28-.36 (.71-.91)	.25-.32 (.63-.81)	.23-.29 (.58-.74)	.21-.27 (.53-.69)	.75-.99 (1.90-2.51)
.59-.72 (1.50-1.83)	.49-.60 (1.24-1.52)	.42-.51 (1.07-1.30)	.37-.45 (.94-1.14)	.33-.40 (.84-1.02)	.30-.36 (.76-.91)	.28-.34 (.71-.86)	1.00-1.24 (2.54-3.15)
.73-.87 (1.85-2.21)	.61-.72 (1.55-1.83)	.52-.61 (1.32-1.55)	.46-.54 (1.17-1.37)	.41-.48 (1.04-1.22)	.37-.43 (.94-1.09)	.35-.40 (.89-1.02)	1.25-1.49 (3.17-3.78)
.88-1.01 (2.24-2.57)	.73-.85 (1.85-2.16)	.62-.71 (1.57-1.80)	.55-.63 (1.40-1.60)	.49-.56 (1.24-1.42)	.44-.51 (1.12-1.30)	.41-.47 (1.04-1.19)	1.50-1.74 (3.81-4.42)
1.02-1.16 (2.59-2.95)	.86-.96 (2.18-2.44)	.72-.81 (1.83-2.06)	.64-.72 (1.63-1.83)	.57-.64 (1.45-1.63)	.52-.58 (1.32-1.49)	.48-.54 (1.22-1.37)	1.75-1.99 (4.44-5.05)
1.17-1.44 (2.97-3.66)	.97-1.20 (2.46-3.05)	.82-1.02 (2.08-2.59)	.73-.90 (1.85-2.29)	.65-.80 (1.65-2.03)	.59-.72 (1.50-1.83)	.55-.67 (1.40-1.70)	2.00-2.49 (5.08-6.32)
1.45-1.73 (3.68-4.39)	1.21-1.45 (3.07-3.68)	1.03-1.22 (2.62-3.10)	.91-1.08 (2.31-2.74)	.81-.96 (2.06-2.44)	.73-.87 (1.85-2.21)	.68-.81 (1.73-2.06)	2.50-2.99 (6.35-7.59)
1.74-2.02 (4.42-5.13)	1.46-1.69 (3.71-4.29)	1.23-1.43 (3.12-3.63)	1.09-1.26 (2.77-3.20)	.97-1.11 (2.46-2.82)	.83-1.01 (2.11-2.57)	.82-.94 (2.08-2.39)	3.00-3.49 (7.62-8.86)
2.03-2.31 (5.16-5.87)	1.70-1.93 (4.32-4.90)	1.44-1.63 (3.66-4.14)	1.27-1.44 (3.23-3.66)	1.12-1.27 (2.84-3.23)	1.02-1.15 (2.59-2.92)	.95-1.08 (2.41-2.74)	3.50-3.99 (8.89-10.13)

Note: *This chart is to be used for determining grip size when multiple cables are held in a single Conduit Riser Grip. For Support Grip multiple cable selection, see page V-44. It is always recommended that, when multiple cables are installed in a Conduit Riser Grip, the tail end of the grip be banded after installation on the cable bundle. See page Tech-23 for cable and wire charts.



Kellems Pulling Grips are reusable tools for pulling electrical cable, bare conductor or rope. They are easy and fast to install, providing the user with a smooth, slim profile that allows for easy passage through ducts and conduit. Kellems Pulling Grips are made of the highest quality galvanized steel strand which assures the user of a long lasting grip. There is a Kellems Pulling Grip for every pulling job.

CAUTION: It is very important to comply with all of the following precautions. Failure to do so may result in property damage, personal injury or death.

1. Pulling grips are to be installed by a qualified individual in accordance with all applicable national and local safety, electrical and rigging codes.
2. Ensure that the correct grip is selected for your specific needs.
3. Do not use a pulling grip for any application other than pulling cable.
4. Thoroughly examine the grip for damage. Do not use a damaged grip.
5. Ensure that the recommended work load of the grip is suitable for the application. Never use grips at their approximated rated breaking strength. A safety factor of 5 is recommended for pulling grips.
6. Do not alter grips in any way. For example, do not modify pulling eyes, shoulders, fittings or lugs.
7. Do not attach any type of pulling hardware to any point on the grip other than the pulling eye. The pulling eye is the only acceptable means of attachment to external hardware.
8. Always apply 2 bands at 1" and 2" respectively, from the tail end of the mesh to guard against accidental release of the grip. Accidental release can occur if an object contracts and pushes against the tail end of the mesh, thereby expanding and releasing its hold.

Select The Correct Pulling Grip

Each Kellems Grip is designed to work on a specific range of cable diameters.

Step 1 Refer to the chart below to determine the style of grip best suited for your application.

Step 2 Determine your cable outside diameter.

Step 3 Find the grip size that encompasses your cable diameter.

Step 4 Estimate the tension to be put on the grip, establish the working load you require and compare this to the listed approximate breaking strength of the grip to insure that the grip will be strong enough. Refer to page V-18 for safety and working load factors.

Pulling Grip Selection Chart

Grip Style	Application	Page Number
DUA-PULL®, flexible eye	Extra high strength overhead transmission line stringing for bare or insulated conductor and synthetic rope.	V-6
Multiple strength, flexible eye	Normal overhead transmission and distribution line stringing for bare or insulated conductor.	V-7
Multiple strength, rotating eye	Normal overhead transmission and distribution line stringing for bare or insulated conductor.	V-7
K-type grip, rotating eye	Underground power cables and communication lines. Service lines into factories.	V-8
T-type grip, flexible eye	Underground power cables and communication lines. Service lines into factories.	V-9
Non-conductive, flexible eye	Pull insulated distribution cable into place.	V-10
Slack pulling, closed mesh	Remove underground cable. For pulling slack in final placement of new cable when end of cable is available.	V-10
Slack pulling, split mesh,	Remove underground cable. For pulling slack in final placement of new cable rawhide lace closing when end of cable is not available.	V-11
Slack pulling, split mesh,	Remove underground cable. For pulling slack in final placement of new cable rod closing when end of cable is not available, with rod closing for quick installation.	V-11
Light duty, flexible eye	Light pulling, underground electrical construction. Industrial plant wiring and rewiring jobs.	V-12
Junior, flexible eye	Connect bundled insulated building wire to a pulling tape. Pull wire through conduit.	V-12
Regular and rotating wire rope	Restraining wire rope in cranes and oil rigs.	V-13
Splicing	Temporary splice for cable or wire rope.	V-14
Pulling Grip Accessories	Tools, bands, swivels.	V-15, V-16
Fiber Optic Cable Pulling Grips	Pull fiber optic cable into place overhead, underground or through duct and conduit.	V-47, V-48, V-49



Safety And Working Load Factors For Wire Mesh Grips

The broad application of Kellems grips on a wide variety of objects requires that adequate safety factors be used to establish working loads. The approximate breaking strength of a Kellems grip represents an average calculation based on data established from actual direct tension testing done in our engineering laboratories.

It is impossible to catalog or guarantee a safety factor suitable for all applications as operating conditions are never the same. The tension, diameter, movement, number of objects gripped, gripping surface, and the attachments used are just some of the factors which vary with each application. These factors, together with the effects of abrasion, corrosion, prior use or abuse and any other variables of a specific application, must be considered by the user and

the grip replaced as appropriate. Where the conditions of the application are not well defined or known, or where risk of injury to persons or property is involved, a greater safety factor should be utilized.

Under normal conditions, Kellems' recommended factor of safety is five for catalog listed pulling grips, and ten for catalog listed support grips.

Any warranty as to quality, performance or fitness for use of grips is always premised on the condition that the published breaking strengths apply only to new, unused grips, and that such products are properly stored, handled, used, maintained and inspected by the user at a frequency appropriate for the use and condition of the grip.

Examples

Grip Style	Approx. Breaking Strength Lbs. (N)	Safety Factor	Max. Recommended Load Lbs. (N)	Catalog Number
Pulling Grips	27,200 (120,986)	5	5,440 (24,197)	03301027
Support Grips	1,610 (7,161)	10	161 (716)	02201018

The maximum recommended working load then is the tension to be exerted on the grip in application with a margin of safety to take care of unforeseen and unusual circumstances.

It is the end-user's decision to determine how much of a safety factor is acceptable for the application.

The metric unit of measure (force) for breaking strength and load is newtons (N). To convert from newtons to the metric unit of weight (kilograms) the conversion factor is 9.808 newtons/kilogram.

Pulling Grip Materials

Material	Features	Product Group
Galvanized steel wire	<ul style="list-style-type: none"> • High strength • Not subject to continuous outside environment 	<ul style="list-style-type: none"> • Pulling grips • Wire rope grips • Splicing grips
Non-metallic strand	<ul style="list-style-type: none"> • Superior flex life • Non-conductive • Corrosion resistant • Moderate strength 	<ul style="list-style-type: none"> • Non-conductive pulling grips

Approvals

UL and CSA Certification is indicated on appropriate product catalog pages.



Overhead Pulling DUA-PULL® Grips

DUA-PULL Pulling Grips are the highest strength pulling grips manufactured for overhead transmission line stringing applications. They have a dual function of working with both bare and insulated conductors and synthetic rope, not provided by any other grip. Kellems' patented two-over, two-under weave design gives exceptional strength and gripping ability by putting more steel mesh in contact with the cable or rope surfaces.

THIS IS THE ONLY PULLING GRIP RECOMMENDED FOR USE ON SYNTHETIC ROPE.

Application

The DUA-PULL Grips are primarily used in overhead transmission line construction where loads and safety considerations require an extra high strength grip. They are most commonly used for attaching pulling lines to conductors, conductors to running boards and "double socking" for conductor-to-conductor connections. The DUA-PULL line accommodates ACSR, ACAR, all aluminum and copper conductors. Also, the grips accommodate ground wires, messenger strands, wire ropes and synthetic ropes.

Benefits

- Made of high strength galvanized steel strand.
- Recommended for pulling bare or insulated conductor, wire rope and synthetic rope.
- DUA-PULL mesh design offers the greatest holding power for all pulling applications.
- Each grip size is color coded for fast and accurate identification and selection.
- Will mate with swivels. See page V-16.

Feed Tubes

The Kellems Feed Tube is used when assembling synthetic rope into the DUA-PULL Grip. It is required on the largest two sizes of DUA-PULL Grips. Feed Tubes are available for use on all size DUA-PULL Grips.

Benefits

- Saves time, allowing fast, easy assembly.
- Can be reused if not damaged.

Note: 1. Do not run grips or swivels over bullwheels while under tension.

2. Two Punch-Lok® bands should be firmly attached approximately 1" and 2" (2.54cm and 5.08cm) from the grip's tail. Banding is required to ensure maximum reliability and guard against accidental release. See page V-15.

3. Double braided rope, such as 2-in-1 type, should be back spliced for approximately 2/3 of the mesh length for best gripping results. Grip size should be selected by diameter of back splice.

Components

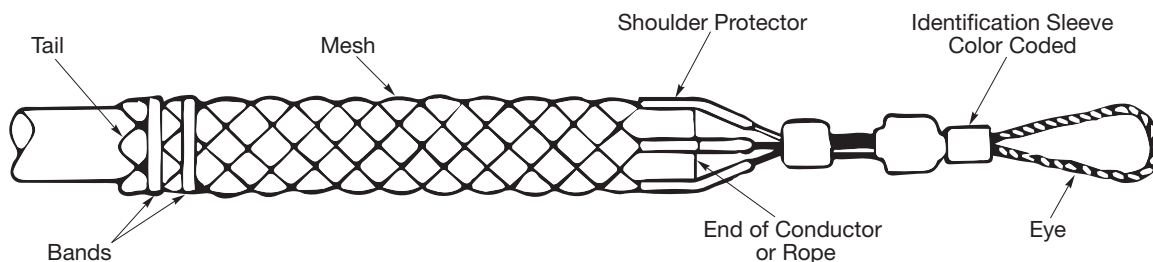



Overhead Pulling Multiple Strength Grips

Multiple Strength Pulling Grips are designed for pulling aluminum or copper bare conductor, ground wires, messenger strands, wire rope and insulated cables. They are made of high strength galvanized steel strand and feature a multi-weave mesh construction of single, double and triple weave for firm holding power.

Application

Kellems Multiple Strength Grips are ideal for overhead transmission and distribution line stringing where moderate loading is anticipated. They are economical tools for attaching conductors to pulling lines and double socking for conductor-to-conductor connections.

Rotating Eye Feature

Multiple Strength Grips are available with a forged steel rotating eye which can be attached to a swivel. The forged eye is durable, compact and streamlined and will thread through blocks and sheaves without binding. The rotating eye is not a swivel and will not turn while under tension; it can turn to relieve pulling torque when tension is relaxed. If constant swivel action is required, a swivel should be used. For swivel dimensions, see page V-16. For rotating eye dimensions, see page V-21.

Flexible Eye Feature

Multiple Strength Grips are also available with a flexible, patented wire rope eye. This compact eye will mate with a swivel, and pass through blocks and sheaves without binding.

Benefits

- Economical, high strength pulling tool.
- Multi-weave construction provides greater strength and holding power.
- Endless Weave Grip end lies flat on the cable and will not snag.

Note: 1. Do not run grips or swivels over bullwheels while under tension.

2. Two Punch-Lok® bands should be firmly attached approximately 1" and 2" (2.54cm and 5.08cm) from the grip's tail. Banding is required to ensure maximum reliability and guard against accidental release. See page V-15.

Components

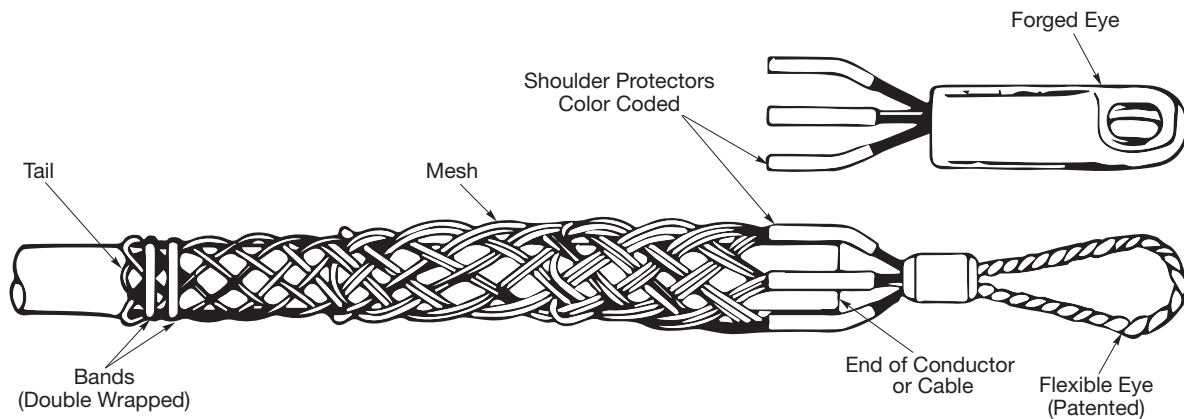



Underground Pulling K-Type and T-Type Grips

K-Type Application

Rotating Eye, K-Type Pulling Grips are specially designed for use in the installation of underground power cables, communication lines and service lines into factories, shopping centers, construction projects and general underground electrical construction.

Rotating Eye Feature

K-Type Grips come equipped with a forged steel rotating eye which can be attached to a swivel. The forged eye is durable, compact and streamlined, and will thread through blocks and sheaves without binding.

The rotating eye is not a swivel and will not turn while under tension; it can turn to relieve pulling torque when the tension is relaxed. If constant swivel action is required, a swivel should be used. For swivel dimensions, see page V-16.

Benefits

- An economical tool for pulling cable.
- Safe, rugged and dependable.
- Equipped with a rotating eye for spin out of pulling torque after load release.
- Easily installed and removed.

Rotating Eye Dimensions

Rotating Eye Dimensions Inches (cm)	A	B	C	D	F
7/8" (2.22)	7/8" (2.22)	9/32" (.71)	1/2" (1.27)	7/8" (2.22)	2 5/8" (6.67)
1" (2.54)	1" (2.54)	1/2" (1.27)	9/16" (1.43)	1 3/16" (2.06)	3 1/2" (8.89)
1 1/8" (3.49)	1 1/8" (3.49)	1/2" (1.27)	1 1/16" (1.75)	1" (2.54)	4 1/2" (11.43)
1 5/8" (4.13)	1 5/8" (4.13)	5/8" (1.59)	7/8" (2.22)	1 3/16" (3.02)	5 5/16" (13.49)
1 7/8" (4.76)	1 7/8" (4.76)	2 1/32" (1.67)	1" (2.54)	1 3/8" (3.49)	6 1/8" (15.56)

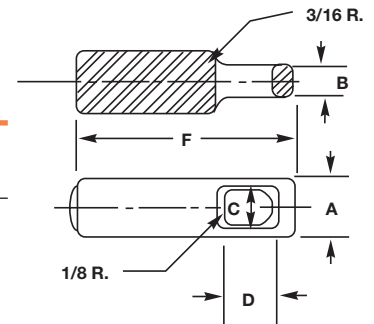

T-Type

Kellems Flexible T-Type Pulling Grips are made of high strength galvanized steel strand. They feature double weave mesh for positive holding power in medium to heavy pulling jobs. The grip eye will easily attach to a swivel.

Application

T-Type Pulling Grips are used for the installation of underground power cables, communication lines and service lines into factories, construction projects and for general underground electrical construction. Available in two mesh lengths, short for medium pulls, and standard for general purpose pulling.

Benefits

- Will pull a single cable or cable bundles.
- Patented flexible eye design provides flexibility to follow line of pull.
- A dependable, reusable pulling tool.
- Easily installed and removed.
- Mates easily with a swivel. See page V-16.



Special Purpose Grips

Non-Conductive Pulling Grips

Kellems Non-Conductive Pulling Grips, made of a high strength, non-conductive aramid fiber, are available for pulling single cable or cable bundles. Their braided double weave design adds strength and positive holding power.

Application

Kellems Non-Conductive Pulling Grips were developed for use by utilities for pulling overhead distribution lines in close proximity to energized lines and hardware.

Benefits

- Color coded for fast on-site selection.
- Extra flexibility for easy installation.
- Non-metallic mesh provides for safe pulls over "hot" areas.
- Pellethane jacketed aramid fiber mesh resists abrasion.
- Grips are corrosion resistant.

Note: Taping is required to guard against accidental release and to insure maximum reliability. Apply vinyl plastic electrical tape starting 2" to 3" (5.08cm to 7.62cm) from the tail of the grip onto 2" to 3" (5.08cm to 7.62cm) of cable.

Slack Pulling Grips

Slack Pulling Grips are offered in three styles made of galvanized steel. The closed type is used when the cable end is accessible. When not, there are split lace and split rod closing styles. All grips feature single offset eye for easy attachment to a pulling line.

Application

Slack Grips are widely used in pulling slack for final placement of under ground cable after it has been pulled in. They are also used for removing cable. Standard mesh lengths are generally used in restricted space for short pulls. Longer lengths are used for higher pulling loads where space is not restricted.

Benefits

- Easy attachment to pulling lines.
- Reusable rawhide lace for lace closure.
- Galvanized steel for strength.

*Note: 1. Replacement rawhide lace. Catalog number 20920002.
2. See page V-43 for lace and rod closing instructions.*



Commercial Construction/Light Duty Grips

Light Duty Pulling Grips

Light Duty Pulling Grips are made of galvanized steel in a single weave construction. They feature a flexible eye for easy attachment to a pulling line.

Application

Light Duty Grips are used in general underground electrical construction where pulling tensions are low. They are easy tools to use in wiring industrial plants and commercial buildings.

Benefits

- Perfect tools for light pulling jobs.
- Installs easily on cable.
- Strong, galvanized steel construction.

Junior Duty Pulling Grips

Junior Pulling Grips feature a strong galvanized steel, single weave mesh. A flexible eye easily attaches to a pulling line, snake or fish tape.

Application

Designed to pull building wire, Junior grips are safe tools to use in pulling wire at low tension through conduit during electrical construction.

Benefits

- Installs easily over building wire.
- Strong secure grip.
- Reusable.
- Pulls single cable or cable bundles.

Junior Grip Kit

Junior Grip Kit contains 6 grips, one of each size. Catalog number **033051114**. See page V-12.

Note: See page V-26 for building wire selection chart.



Splicing Grips

Wire Rope Splicing

Kellems Wire Rope Grips are made of high strength galvanized steel strand in a construction of triple, double and single weave for superior gripping ability. They are available with or without a rotating barrel which will help eliminate twist in the old rope from being transferred to the new rope.

Application

Wire Rope Grips are used for changing wire rope on oil derricks, large cranes, overhead cranes and drag lines. It provides a quick, safe, inexpensive temporary splice. By installing the used wire rope in one end and the new rope in the other, the new wire rope can be pulled in as the old one is pulled out.

Benefits

- High strength for secure pulling.
- Easy installation.
- Flexible to pass through sheaves and blocks.

Note: 1. During installation each end of the grip should be banded and taped down securely over the rope to insure smooth passage through sheaves and to guard against accidental release. See page V-15 for end bands.

2. The rotating barrel is not a swivel and will not turn while under tension. It can turn to relieve pulling torque when tension is relaxed.

Cable Splicing

Splicing Grips are made of galvanized steel in double or single weave mesh construction. They are available in various lengths and sizes to suit most applications.

Application

Splicing Grips are used as a temporary splice for rope, cable or wire rope. They can also be used as cable reinforcement, and can act as a shield to protect cables and hoses from abrasion.

Benefits

- Easily installed or removed.
- Galvanized steel construction for strength.
- Flexible to follow cable path.

Note: 1. During installation, each end of the splicing grip should be banded and taped down securely to the cable to insure smooth passage with the cable and guard against accidental release.

2. See page V-15 for end bands.



Multiple Cable Selection Charts for Cables and Wires of Unequal Diameters

How to choose the correct grip size:

1. Find the Grip Circumference Range by measuring the circumference of the bundle of different diameter cables to be gripped (see illustration).
2. Divide the bundle circumference by 3.14 to determine the diameter.
3. Choose a grip offering a range of cable diameters the same as the cable diameter.

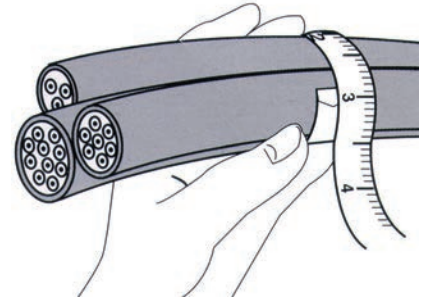

For Pulling Grips*

CAUTION: When a grip is used on multiple cables, the tail end of the grip should be banded after positioning on the cables.

For Cables of Equal Diameters

Under "Number of Cables in One Grip", find the diameter of your single cable in vertical column. Read the grip diameter range to the right.

If your diameter is the maximum of the range shown, go to the next larger size for Split Grips, stay with the same size for Closed Grips.

Example: Three cables, each with .89" (2.26cm) diameter, for a Closed Grip select the 1.50"-1.74" (3.81cm-4.42cm) range, for a Split Grip select the 1.75"-1.99" (4.44cm-5.05cm) range.

Number of Cables in One Grip

2	3	4	5	6 and 7	8	9	Grip Dia. Range Inches (cm)
.30-.38 (.76-.97)	.25-.31 (.63-.79)	.22-.27 (.56-.69)	.19-.24 (.48-.60)	.17-.22 (.43-.56)	.15-.19 (.38-.48)	.14-.18 (.36-.46)	.50-.61 (1.27-1.55)
.38-.44 (.97-1.12)	.31-.36 (.79-.91)	.27-.31 (.69-.79)	.24-.29 (.61-.74)	.22-.26 (.56-.66)	.19-.23 (.48-.58)	.18-.21 (.46-.53)	.62-.74 (1.57-1.88)
.44-.59 (1.12-1.50)	.36-.49 (.91-1.24)	.31-.42 (.79-1.07)	.29-.38 (.74-.97)	.26-.34 (.66-.86)	.23-.31 (.58-.79)	.21-.28 (.53-.71)	.75-.99 (1.90-2.51)
.59-.75 (1.50-1.90)	.49-.63 (1.24-1.60)	.42-.54 (1.07-1.37)	.38-.48 (.97-1.22)	.34-.43 (.86-1.09)	.31-.39 (.79-.99)	.28-.35 (.71-.89)	1.00-1.24 (2.54-3.15)
.75-.90 (1.90-2.29)	.63-.76 (1.60-1.93)	.54-.65 (1.37-1.65)	.48-.58 (1.22-1.47)	.43-.52 (1.09-1.32)	.39-.46 (.99-1.17)	.35-.42 (.89-1.07)	1.25-1.49 (3.17-3.78)
.90-1.07 (2.29-2.72)	.76-.89 (1.93-2.26)	.65-.77 (1.65-1.96)	.58-.67 (1.47-1.70)	.52-.60 (1.32-1.52)	.46-.54 (1.17-1.37)	.42-.49 (1.07-1.24)	1.50-1.74 (3.81-4.42)
1.07-1.22 (2.72-3.10)	.89-1.02 (2.26-2.59)	.77-.88 (1.96-2.24)	.67-.77 (1.70-1.96)	.60-.69 (1.52-1.75)	.54-.62 (1.37-1.57)	.49-.56 (1.24-1.42)	1.75-1.99 (4.44-5.05)
1.22-1.53 (3.10-3.89)	1.02-1.28 (2.59-3.25)	.88-1.10 (2.24-2.79)	.77-.96 (1.96-2.44)	.69-.86 (1.75-2.18)	.62-.77 (1.57-1.96)	.56-.71 (1.42-1.80)	2.00-2.49 (5.08-6.32)
1.53-1.83 (3.89-4.65)	1.28-1.53 (3.25-3.89)	1.10-1.32 (2.79-3.35)	.96-1.16 (2.44-2.95)	.86-1.03 (2.18-2.62)	.77-.93 (1.96-2.36)	.71-.85 (1.80-2.16)	2.50-2.99 (6.35-7.59)
1.83-2.14 (4.65-5.44)	1.53-1.79 (3.89-4.55)	1.32-1.54 (3.35-3.91)	1.16-1.35 (2.95-3.43)	1.03-1.20 (2.62-3.05)	.93-1.08 (2.36-2.74)	.85-.99 (2.16-2.51)	3.00-3.49 (7.62-8.86)
2.14-2.44 (5.44-6.20)	1.79-2.05 (4.55-5.21)	1.54-1.76 (3.91-4.47)	1.35-1.54 (3.43-3.91)	1.20-1.37 (3.05-3.48)	1.08-1.24 (2.74-3.15)	.99-1.13 (2.51-2.87)	3.50-3.99 (8.89-10.13)
2.44-2.75 (6.20-6.98)	2.05-2.30 (5.21-5.84)	1.76-1.98 (4.47-5.03)	1.54-1.74 (3.91-4.42)	1.37-1.55 (3.48-3.94)	1.24-1.39 (3.15-3.53)	1.13-1.27 (2.87-3.23)	4.00-4.49 (10.16-11.40)
2.75-3.06 (6.98-7.77)	2.30-2.56 (5.84-6.50)	1.98-2.20 (5.03-5.59)	1.74-1.93 (4.42-4.90)	1.55-1.72 (3.94-4.37)	1.39-1.55 (3.53-3.94)	1.27-1.41 (3.23-3.58)	4.50-4.99 (11.43-12.67)

Note: *This chart is not to be used for Conduit Riser Grips. Refer to the chart for Conduit Riser multiple cable section. It is always recommended that, when multiple cables are installed in a pulling grip, the tail end be banded and tightly taped after installation on the cable bundle. See page V-15 for end bands.



Junior Pulling Grip Selection Chart

These charts are a general guide to assist in the selection of the correct Junior Pulling Grip for pulling various groupings of building wire. It is not intended to be restrictive inasmuch as the use of "dummy" wires (short pieces of wire used to fill out the Grip) or the tight taping of the wires into a compact bundle may increase or decrease the number of wires per Grip.

T.H.W.N., T.H.H.N. and X.H.H.W. Building Wire

Cable Diameter Range In. (cm)	Approx. Breaking Strength Lbs. (N)	Approximate Number Of Wires In One Grip											Model	Catalog Number
		#14 19 Strand	#12 19 Strand	#10 19 Strand	#8 19 Strand	#6 19 Strand	#4 19 Strand	#3 19 Strand	#2 19 Strand	#1 37 Strand	#1/0 37 Strand			
.25-.36 (.63-.91)	450 (2,002)	4-8	3-6	2-3	2	1	1	1	—	—	—	J 25	03305001	
.37-.49 (.94-1.24)	900 (4,003)	9-16	6-11	4-6	3	2	—	—	1	1	1	J 37	03305002	
.50-.61 (1.27-1.55)	1,300 (5,782)	16-25	11-17	7-10	4-5	3-4	2	2	—	—	—	J 50	03305003	
.62-.74 (1.57-1.88)	1,950 (8,674)	26-37	18-25	11-14	6-8	5-6	3	3	2	2	—	J 62	03305004	
.75-.99 (1.90-2.51)	2,800 (12,454)	37-66	26-47	15-27	9-16	6-11	4-7	4-5	3-4	3	2-3	J 75	03305005	
1.00-1.24 (2.54-3.15)	3,900 (17,347)	66-104	47-74	28-43	16-24	11-17	8-10	6-8	5-7	4-5	4	J 100	03305006	

R.H.H., R.H., R.W. and R.H.W. Building Wire

Cable Diameter Range In. (cm)	Approx. Breaking Strength Lbs. (N)	Approximate Number Of Wires In One Grip										Model	Catalog Number
		#14 7 Strand	#12 7 Strand	#10 7 Strand	#8 7 Strand	#6 7 Strand	#4 7 Strand	#2 7 Strand	#1 7 Strand	#1/0 19 Strand			
.25-.36 (.63-.91)	450 (2,002)	2	2	1	1	—	—	—	—	—	J 25	03305001	
.37-.49 (.94-1.24)	900 (4,003)	3	2-3	2	—	1	1	1	—	—	J 37	03305002	
.50-.61 (1.27-1.55)	1,300 (5,782)	4-5	4-5	3-4	2	—	—	—	1	—	J 50	03305003	
.62-.74 (1.57-1.88)	1,950 (8,674)	6-8	6-7	4-5	3	2	2	—	—	1	J 62	03305004	
.75-.99 (1.90-2.51)	2,800 (12,454)	9-16	8-14	6-10	4-6	3-4	3-4	2-3	2	—	J 75	03305005	
1.00-1.24 (2.54-3.15)	3,900 (17,347)	16-24	15-22	11-16	7-10	5-7	4-6	4	3	2-3	J 100	03305006	

T.H.W. Building Wire

Cable Diameter Range In. (cm)	Approx. Breaking Strength Lbs. (N)	Approximate Number Of Wires In One Grip										Model	Catalog Number
		#14 7 Strand	#12 7 Strand	#10 7 Strand	#8 7 Strand	#6 7 Strand	#4 7 Strand	#2 7 Strand	#1 7 Strand	#1/0 19 Strand			
.25-.36 (.63-.91)	450 (2,002)	2-4	2-3	2	1	1	1	—	—	—	J 25	03305001	
.37-.49 (.94-1.24)	900 (4,003)	5-7	4-5	3-4	2	—	—	1	—	—	J 37	03305002	
.50-.61 (1.27-1.55)	1,300 (5,782)	8-11	6-8	5-7	3-4	2	2	—	1	1	J 50	03305003	
.62-.74 (1.57-1.88)	1,950 (8,674)	12-16	9-12	8-10	5-6	3-4	3	2	—	—	J 62	03305004	
.75-.99 (1.90-2.51)	2,800 (12,454)	17-30	13-24	11-19	7-10	5-7	4-5	3-4	2	2	J 75	03305005	
1.00-1.24 (2.54-3.15)	3,900 (17,347)	31-48	25-37	20-30	11-17	8-11	6-8	5-6	3-4	3	J 100	03305006	

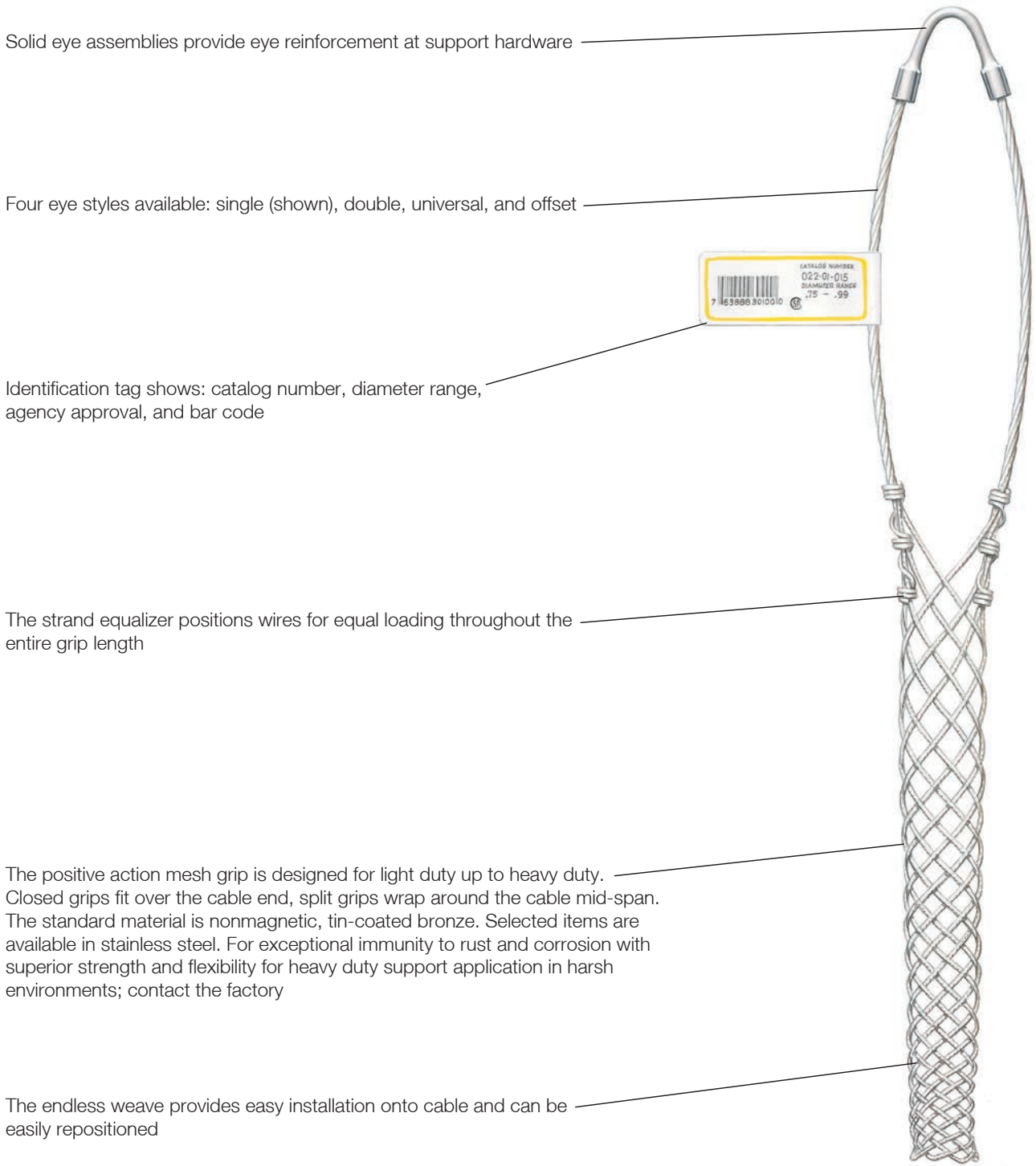

Solid eye assemblies provide eye reinforcement at support hardware

Four eye styles available: single (shown), double, universal, and offset

Identification tag shows: catalog number, diameter range, agency approval, and bar code

The strand equalizer positions wires for equal loading throughout the entire grip length

The positive action mesh grip is designed for light duty up to heavy duty. Closed grips fit over the cable end, split grips wrap around the cable mid-span. The standard material is nonmagnetic, tin-coated bronze. Selected items are available in stainless steel. For exceptional immunity to rust and corrosion with superior strength and flexibility for heavy duty support application in harsh environments; contact the factory

The endless weave provides easy installation onto cable and can be easily repositioned



IMPORTANT
Read all breaking strength, safety and technical data relating to this product. Pages V-41 to V-45.



Safety Spring

Maximum Deflection Inches/Lbs (cm/N)	Approx. Breaking Strength Lbs. (N)	Length* Inches (cm)	Diameter Inches (cm)	Model Lbs. (N)	Catalog Number
2¾" at 40 lbs. (6.98 at 178)	500 (2,224)	8.25" (20.95)	.75" (1.90)	40 lb. spring (178)	20302001
3½" at 80 lbs. (7.94 at 356)	850 (3,781)	8.25" (20.95)	1" (2.54)	80 lb. spring (356)	20302002

Note: Springs can be used with single eye grips by disassembling drawbar from coil, placing through eye and replacing drawbar. *No load.

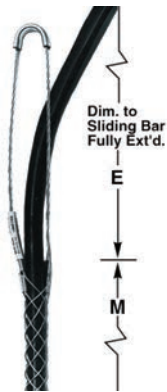

Single Eye, Wide Range

Cable Diameter Range Inches (cm)	Approx. Breaking Strength Lbs. (N)	E Inches (cm)	M Inches (cm)	Catalog Number
.24"- .32" (.61-.81)	350 (1,557)	3" (7.62)	3.5" (8.89)	073041276**
.32"- .43" (.81-1.09)	450 (2,002)	4" (10.16)	4" (10.16)	073041277
.43"- .56" (1.09-1.42)	550 (2,446)	6" (15.24)	4.75" (12.06)	073041278
.56"- .73" (1.42-1.85)	1,000 (4,448)	7" (17.78)	6" (15.24)	073041279
.73"- .85" (1.85-2.16)	1,400 (6,227)	7" (17.78)	6.75" (17.14)	073041280
.85"-1.00" (2.16-2.54)	1,400 (6,227)	8" (20.32)	8" (20.32)	073041281
1.00"-1.25" (2.54-3.17)	1,500 (6,672)	9" (22.86)	9.5" (24.13)	073041282

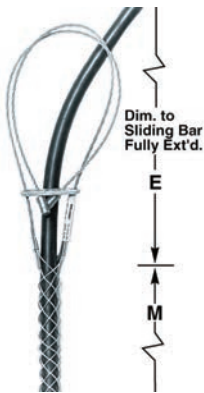

Universal Eye, Wide Range

Cable Diameter Range Inches (cm)	Approx. Breaking Strength Lbs. (N)	E Inches (cm)	M Inches (cm)	Catalog Number
.32"- .43" (.81-1.09)	450 (2,002)	10" (25.40)	4" (10.16)	073041284
.43"- .56" (1.09-1.42)	550 (2,446)	12" (30.48)	4.75" (12.06)	073041285
.56"- .73" (1.42-1.85)	1,000 (4,448)	13" (33.02)	6" (15.24)	073041286
.73"- .85" (1.85-2.16)	1,400 (6,227)	13" (33.02)	6.75" (17.14)	073041287
.85"-1.00" (2.16-2.54)	1,400 (6,227)	14" (35.56)	8" (20.32)	073041288
1.00"-1.25" (2.54-3.17)	1,500 (6,672)	15" (38.10)	9.5" (24.13)	073041289

Note: E-Eye length. M-Mesh length at nominal diameter. **Item indicated is not UL listed.

Bus Drop Grips and Safety Springs

Kellems Bus Drop Grips are offered with either a single eye or universal bale attachment. The mesh is single weave galvanized steel with the patented wide range construction. They are suitable for indoor use only. Consult Technical Service for Stainless Steel Grips.

Application

Bus Drop Grips provide a safe, easy and economical method to support flexible cord or bus drop cable at bus duct and other industrial areas.

Benefits

- Easily installed.
- Absorb tension, vibration and pull with no cable damage.
- Patented mesh construction.

Safety Spring

Springs can be used with single eye grips by disassembling drawbar from coil, placing through eye and replacing drawbar.

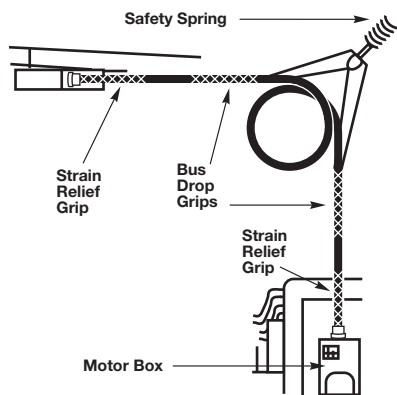



Kellems® Support Grips

Kellems Support Grips are used to hold the weight of electrical cable as it hangs in a vertical, sloping or horizontal position. Electrical cable must be supported, or its dead weight can cause excessive strain or pullout at the connections resulting in power failure. Support grips also absorb additional strain from flexure, vibration, expansion and contraction. Kellems Support Grips listed in this catalog are made of high grade, non-magnetic tin-coated bronze strand. Stainless steel grips, made of alloy 302-304 SST for severe service or unusual environmental conditions, are available on request.

Select the Correct Support Grip

Each Kellems grip is designed to work on a specific range of cable diameters.

- Step 1** Refer to the Kellems chart below to determine the grip style best suited for your application.

- Step 2** Determine your cable outside diameter.

- Step 3** Find the grip size that encompasses your cable diameter.

- Step 4** Whenever possible, use a closed mesh that assembles over the cable end. If the cable end is not available, use a split mesh.

- Step 5** Where available, select an eye style that suits your needs.

- Step 6** Select the proper material—tinned bronze or stainless steel*.

- Step 7** Estimate the tension to be put on the grip, establish the working load you require and compare this to the listed approximate breaking strength of the grip to insure that the grip will be strong enough. Refer to page V-42 for safety and working load considerations.

CAUTION: It is very important to comply with all of the following precautions.

1. Support grips are to be installed by a qualified individual in accordance with all applicable national and local safety, electrical and rigging codes.
2. Ensure that the correct grip is selected for your specific needs.
3. Do not use a support grip for any application other than supporting cable.
4. Thoroughly examine the grip for damage. Do not use a damaged grip.
5. Ensure that the recommended work load of the grip is suitable for the application. Never use grips at their approximated rated breaking strength. A safety factor of 10 is recommended for support grips.
6. Do not alter grips in any way. For example, do not flatten, straighten, bend or otherwise modify eye tubes, hooks, and strand equalizers.
7. Do not attach any type of hook, clamp or other hardware directly to the stranded bale of a “U” eye support grip. The formed eye tube is the only acceptable means of attachment to external hardware.
8. Always apply 2 bands at 1" and 2" respectively, from the tail end of the mesh to guard against accidental release of the grip. Accidental release can occur if an object contracts and pushes against the tail end of the mesh, thereby expanding and releasing it's hold.

Support Grip Selection Chart

Grip Styles	Application	Page
Closed mesh	Standard, permanent support, cable end available.	V-28 to V-36
Split lace closing	Standard, permanent support, cable end unavailable.	V-28 to V-33
Split rod closing	Standard, temporary support, cable end unavailable. Tape or band tail end of wire mesh grip after positioning for permanent support.	V-28 to V-31
Material*	Tin-coated bronze standard or stainless steel by special request.	V-28 to V-34
Standard support grips	Support vertical runs to 99 ft. loads to 600 lbs.	V-28 to V-31
Heavy duty grips	Support vertical runs over 100 ft. loads over 600 lbs.	V-32, V-33
Service drop	Light duty to support service entrance cable.	V-34, V-35
Bus drop	Light duty support, indoors only, on Bus drop cable.	V-36
Conduit riser	Support cable runs in rigid (Schedule 40) conduit.	V-37 to V-39
Fiber optic cable support grips	Support fiber optic cable.	V-50

*Note: *Most catalog listed support grips are made of tin-coated bronze strand. To order stainless steel support grips, change the first three catalog number digits from 022-0x-xxx to 024-0x-xxx. Consult Technical Service for details.*

Eye Styles



Single



Double



Universal



Offset



Safety And Working Load Factors For Wire Mesh Grips

The broad application of Kellems grips on a wide variety of objects requires that adequate safety factors be used to establish working loads. The approximate breaking strength of a Kellems grip represents an average calculation based on data established from actual direct tension testing done in our engineering laboratories.

It is impossible to catalog or guarantee a safety factor suitable for all applications as operating conditions are never the same. The tension, diameter, movement, number of objects gripped, gripping surface, and the attachments used are just some of the factors which vary with each application. These factors, together with the effects of abrasion, corrosion, prior use or abuse and any other variables of a specific application, must be considered by the user and

the grip replaced as appropriate. Where the conditions of the application are not well defined or known, or where risk of injury to persons or property is involved, a greater safety factor should be utilized.

Under normal conditions, Kellems' recommended factor of safety is five for catalog listed pulling grips, and ten for catalog listed support grips.

Any warranty as to quality, performance or fitness for use of grips is always premised on the condition that the published breaking strengths apply only to new, unused grips, and that such products are properly stored, handled, used, maintained, and inspected by the user at a frequency appropriate for the use and condition of the grip.

Examples

Grip Style	Approx. Breaking Strength Lbs. (N)	Safety Factor	Max. Recommended Load Lbs. (N)	Catalog Number
Pulling Grips	27,200 (120,986)	5	5,440 (24,197)	03301027
Support Grips	1,610 (7,161)	10	161 (716)	02202019

The maximum recommended working load is the tension to be exerted on the grip in application with a margin of safety to take care of unforeseen and unusual circumstances.

It is the end-user's decision to determine how much of a safety factor is acceptable for the application.

The metric unit of measure (force) for breaking strength and load is newtons (N). To convert from newtons to the metric unit of weight (kilograms) the conversion factor is 9.808 newtons/kilogram.

Support Grip Materials

Material	Features	Grip Type
Tin-coated bronze wire	<ul style="list-style-type: none"> • Corrosion resistant for normal outside areas • Non-magnetic • Moderate strength 	<ul style="list-style-type: none"> • Support grips • Service drop grips • Conduit riser grips
Stainless steel wire (302-304)	<ul style="list-style-type: none"> • High strength • Corrosion resistant 	<ul style="list-style-type: none"> • Support grips • Hose containment grips
Galvanized steel wire	<ul style="list-style-type: none"> • Slightly magnetic • Not subject to continuous outside environment 	<ul style="list-style-type: none"> • Bus drop grips

Approvals

CSA Certifications are indicated on appropriate product catalog pages.

Note: It is always recommended that the tail end of the grip be banded after the installation on the cable to prevent accidental release of the mesh. See page V-15 for end bands.



Split Support Grip Lace Closing Instructions

Single Weave Grips should be laced with single strand lacing; double weave with double strand. Lacing strands should be the same material as the grip. Kellems supplies the appropriate lacing with each grip.

1. Start the lacing at the lead or anchoring end of the grip. Thread the lacings through the first two loops of the split and pull through until the lacings are centered at this point. Lace as you would your shoe, crossing the lacings before lacing the next two loops.
2. Don't pull lacing too tight. Leave a space between adjoining loops approximately equal to the width of one diamond of the mesh.
3. Twist the lacing strands tightly together at the tail end of the grip.
4. Wrap the ends of the lacings once or twice tightly around the tail of the grip, twisting the ends together securely. Excess lace can be cut off.



Split Support Grip Rod Closing Instructions

The stainless steel rod is a precise built-in feature which makes threading easy and fast. The strands of the mesh pass around the rod and match up with the strands from the opposite direction. The rod does not touch the cable at any point and therefore cannot cut the cable. Rod Closing Grips are reusable. They may be removed and reused as many times as desired.

1. Fast to install

Wrap the grip around the cable and thread the rod through the pre-formed loops with a corkscrew motion, using the curved end of the rod to engage the loops.

2. The action required is a steady push and twist simultaneously. The fingers of the left hand are used to bring the loops together just ahead of the hook on the end of the rod.
3. To remove, simply pull the rod out.





For Support Grips Only*

Multiple Cable Selection Charts for Cables and Wires of Unequal Diameters

How to choose the correct grip size:

1. Find the Grip Circumference Range by measuring the circumference of the bundle of different diameter cables to be gripped (see illustration).
2. Divide the bundle circumference by 3.14 to determine the diameter.
3. Choose a grip offering a range of cable diameters the same as the cable diameter.

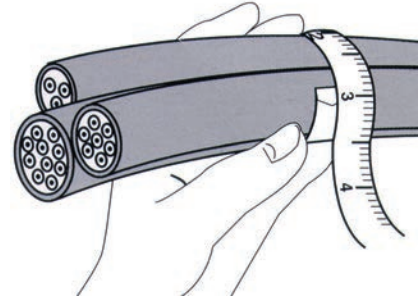

For Cables of Equal Diameters

Under "Number of Cables in One Grip", find the diameter of your single cable in vertical column. Read the grip diameter range to the right.

If your diameter is the maximum of the range shown, go to the next larger size for Split Grips, stay with the same size for Closed Grips.

Example: 3 cables, each with .89" (2.26) diameter, for a Closed Grip select the 1.50"-1.74" (3.81-4.42) range, for a Split Grip select the 1.75"-1.99" (4.44-5.05) range.

Number of Cables in One Grip

2	3	4	5	6 and 7	8	9	Grip Dia. Range Inches (cm)
.30-.38 (.76-.97)	.25-.31 (.63-.79)	.22-.27 (.56-.69)	.19-.24 (.48-.61)	.17-.22 (.43-.56)	.15-.19 (.38-.48)	.14-.18 (.36-.46)	.50-.61 (1.27-1.55)
.38-.44 (.97-1.12)	.31-.36 (.79-.91)	.27-.31 (.69-.79)	.24-.29 (.61-.74)	.22-.26 (.56-.66)	.19-.23 (.48-.58)	.18-.21 (.46-.53)	.62-.74 (1.57-1.88)
.44-.59 (1.12-1.50)	.36-.49 (.91-1.24)	.31-.42 (.79-1.07)	.29-.38 (.74-.97)	.26-.34 (.66-.86)	.23-.31 (.58-.79)	.21-.28 (.53-.71)	.75-.99 (1.90-2.51)
.59-.75 (1.50-1.90)	.49-.63 (1.24-1.60)	.42-.54 (1.07-1.37)	.38-.48 (.97-1.22)	.34-.43 (.86-1.09)	.31-.39 (.79-.99)	.28-.35 (.71-.89)	1.00-1.24 (2.54-3.15)
.75-.90 (1.90-2.29)	.63-.76 (1.60-1.93)	.54-.65 (1.37-1.65)	.48-.58 (1.22-1.47)	.43-.52 (1.09-1.32)	.39-.46 (.99-1.17)	.35-.42 (.89-1.07)	1.25-1.49 (3.17-3.78)
.90-1.07 (2.29-2.72)	.76-.89 (1.93-2.26)	.65-.77 (1.65-1.96)	.58-.67 (1.47-1.70)	.52-.60 (1.32-1.52)	.46-.54 (1.17-1.37)	.42-.49 (1.07-1.24)	1.50-1.74 (3.81-4.42)
1.07-1.22 (2.72-3.10)	.89-1.02 (2.26-2.59)	.77-.88 (1.96-2.24)	.67-.77 (1.70-1.96)	.60-.69 (1.52-1.75)	.54-.62 (1.37-1.57)	.49-.56 (1.24-1.42)	1.75-1.99 (4.44-5.05)
1.22-1.53 (3.10-3.89)	1.02-1.28 (2.59-3.25)	.88-1.10 (2.24-2.79)	.77-.96 (1.96-2.44)	.69-.86 (1.75-2.18)	.62-.77 (1.57-1.96)	.56-.71 (1.42-1.80)	2.00-2.49 (5.08-6.32)
1.53-1.83 (3.89-4.65)	1.28-1.53 (3.25-3.89)	1.10-1.32 (2.79-3.35)	.96-1.16 (2.44-2.95)	.86-1.03 (2.18-2.62)	.77-.93 (1.96-2.36)	.71-.85 (1.80-2.16)	2.50-2.99 (6.35-7.59)
1.83-2.14 (4.65-5.44)	1.53-1.79 (3.89-4.55)	1.32-1.54 (3.35-3.91)	1.16-1.35 (2.95-3.43)	1.03-1.20 (2.62-3.05)	.93-1.08 (2.36-2.74)	.85-.99 (2.16-2.51)	3.00-3.49 (7.62-8.86)
2.14-2.44 (5.44-6.20)	1.79-2.05 (4.55-5.21)	1.54-1.76 (3.91-4.47)	1.35-1.54 (3.43-3.91)	1.20-1.37 (3.05-3.48)	1.08-1.24 (2.74-3.15)	.99-1.13 (2.51-2.87)	3.50-3.99 (8.89-10.13)
2.44-2.75 (6.20-6.98)	2.05-2.30 (5.21-5.84)	1.76-1.98 (4.47-5.03)	1.54-1.74 (3.91-4.42)	1.37-1.55 (3.48-3.94)	1.24-1.39 (3.15-3.53)	1.13-1.27 (2.87-3.23)	4.00-4.49 (10.16-11.40)
2.75-3.06 (6.98-7.77)	2.30-2.56 (5.84-6.50)	1.98-2.20 (5.03-5.59)	1.74-1.93 (4.42-4.90)	1.55-1.72 (3.94-4.37)	1.39-1.55 (3.53-3.94)	1.27-1.41 (3.23-3.58)	4.50-4.99 (11.43-12.67)

Note: *This chart is to be used for determining grip size when multiple cables are held in a single Support Grip. For Conduit Riser multiple cable selection, see page V-45. It is always recommended that, when multiple cables are installed in a Support Grip, the tail end of the grip be banded after installation on the cable bundle. See page Tech-23 for cable and wire charts.



For Conduit Riser Grips Only*

Multiple Cable Selection Charts for Cables and Wires of Unequal Diameters

How to choose the correct grip size:

1. Find the Grip Circumference Range by measuring the circumference of the bundle of different diameter cables to be gripped (see illustration).
2. Divide the bundle circumference by 3.14 to determine the diameter.
3. Choose a grip offering a range of cable diameters the same as the cable diameter.

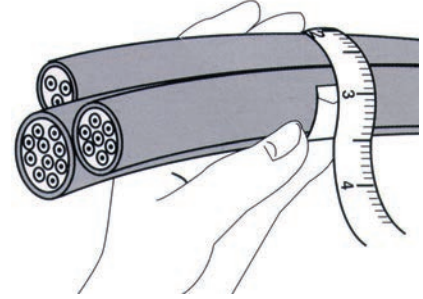

For Cables of Equal Diameters

Under "Number of Cables in One Grip", find the diameter of your single cable in vertical column. Read the grip diameter range to the right.

If your diameter is the maximum of the range shown, go to the next larger size for Split Grips, stay with the same size for Closed Grips.

Example: 3 cables, each with .85" (2.16) diameter, for a Closed Grip select the 1.50"-1.74" (3.81-4.42) range, for a Split Grip select the 1.75"-1.99" (4.44-5.05) range.

Number of Equal Diameter Cables in One Grip

2	3	4	5	6 and 7	8	9	Grip Dia. Range Inches (cm)
.29-.36 (.74-.91)	.24-.30 (.61-.76)	.21-.25 (.53-.63)	.18-.22 (.46-.56)	.16-.20 (.41-.51)	.15-.18 (.38-.46)	.14-.17 (.36-.43)	.50-.62 (1.27-1.57)
.37-.43 (.94-1.09)	.31-.36 (.79-.91)	.26-.30 (.66-.76)	.23-.27 (.58-.69)	.21-.24 (.53-.61)	.19-.22 (.48-.56)	.18-.20 (.46-.51)	.63-.74 (1.60-1.88)
.44-.58 (1.12-1.47)	.37-.48 (.94-1.22)	.31-.41 (.79-1.04)	.28-.36 (.71-.91)	.25-.32 (.63-.81)	.23-.29 (.58-.74)	.21-.27 (.53-.69)	.75-.99 (1.90-2.51)
.59-.72 (1.50-1.83)	.49-.60 (1.24-1.52)	.42-.51 (1.07-1.30)	.37-.45 (.94-1.14)	.33-.40 (.84-1.02)	.30-.36 (.76-.91)	.28-.34 (.71-.86)	1.00-1.24 (2.54-3.15)
.73-.87 (1.85-2.21)	.61-.72 (1.55-1.83)	.52-.61 (1.32-1.55)	.46-.54 (1.17-1.37)	.41-.48 (1.04-1.22)	.37-.43 (.94-1.09)	.35-.40 (.89-1.02)	1.25-1.49 (3.17-3.78)
.88-1.01 (2.24-2.57)	.73-.85 (1.85-2.16)	.62-.71 (1.57-1.80)	.55-.63 (1.40-1.60)	.49-.56 (1.24-1.42)	.44-.51 (1.12-1.30)	.41-.47 (1.04-1.19)	1.50-1.74 (3.81-4.42)
1.02-1.16 (2.59-2.95)	.86-.96 (2.18-2.44)	.72-.81 (1.83-2.06)	.64-.72 (1.63-1.83)	.57-.64 (1.45-1.63)	.52-.58 (1.32-1.49)	.48-.54 (1.22-1.37)	1.75-1.99 (4.44-5.05)
1.17-1.44 (2.97-3.66)	.97-1.20 (2.46-3.05)	.82-1.02 (2.08-2.59)	.73-.90 (1.85-2.29)	.65-.80 (1.65-2.03)	.59-.72 (1.50-1.83)	.55-.67 (1.40-1.70)	2.00-2.49 (5.08-6.32)
1.45-1.73 (3.68-4.39)	1.21-1.45 (3.07-3.68)	1.03-1.22 (2.62-3.10)	.91-1.08 (2.31-2.74)	.81-.96 (2.06-2.44)	.73-.87 (1.85-2.21)	.68-.81 (1.73-2.06)	2.50-2.99 (6.35-7.59)
1.74-2.02 (4.42-5.13)	1.46-1.69 (3.71-4.29)	1.23-1.43 (3.12-3.63)	1.09-1.26 (2.77-3.20)	.97-1.11 (2.46-2.82)	.83-1.01 (2.11-2.57)	.82-.94 (2.08-2.39)	3.00-3.49 (7.62-8.86)
2.03-2.31 (5.16-5.87)	1.70-1.93 (4.32-4.90)	1.44-1.63 (3.66-4.14)	1.27-1.44 (3.23-3.66)	1.12-1.27 (2.84-3.23)	1.02-1.15 (2.59-2.92)	.95-1.08 (2.41-2.74)	3.50-3.99 (8.89-10.13)

Note: *This chart is to be used for determining grip size when multiple cables are held in a single Conduit Riser Grip. For Support Grip multiple cable selection, see page V-44. It is always recommended that, when multiple cables are installed in a Conduit Riser Grip, the tail end of the grip be banded after installation on the cable bundle. See page Tech-23 for cable and wire charts.