



BROAN[®]

- Attic Ventilation
- Range Hoods
- Ventilation Fans
- Whole House Mechanical Ventilation

Customer Service 1-800-558-1711
 Technical Support 1-800-637-1453

www.Broan.com

2017 LIST PRICES / FULL LINE PRODUCTS



NuTone[®]

- Central Vacuum Systems
- Door Chimes
- Heaters
- Intercom Systems
- Ironing Centers
- Ventilation Fans

Customer Service 1-888-336-3948
 Technical Support 1-888-336-6151

www.NuTone.com

Effective Date: April 1, 2017
 Supersedes all previous pricing

Download a copy of this price book at
www.broan.com/catalogs or www.nutone.com/catalogs

All sales are governed by the Terms and Conditions available at <http://salesterms.broan-nutone.com>. Buyer's additional or different terms are hereby rejected.

BROAN[®]

Broan 926 W. State Street Hartford, WI 53027

99850822T



Accessories	1	Range Hoods	26	Ventilation Fans	66
Dampers	5	Accessories	51	Bath Fan Upgrade Kit	73
Ducting	6	Blowers	37	Combination Units	78
Elbows	6	Chimney Hoods	26	Decorative Fan/Light	71
Hanger Bars	6	Downdraft Hoods	30	Duct Free	73
Replacement Parts	1	Energy Star Hoods	42	Economy	73
Roof Caps	4	High Performance Hoods	34	Heavy Duty Series	72
Transitions	4	Power Packs	31	High Capacity	81
Wall Caps	5	Under Cabinet Hoods	38	InVent	69
Wall Controls	7			LED	71
Attic Ventilators	8	Trash Compactors	52	LoProfile	72
Parts & Accessories	9	Accessories	52	Project Packs	74
Roof Mount Powered	8			Recessed Fan/Light	71
Gable Mount Powered	9			Remote In-Line	77
Solar Powered	8			Room-to-Room	79
				Sensing	69
				Sensonic™	55 & 68
				SmartSense®	55 & 68
				QT Series™	55 & 68
				ULTRA™	66
				Utility Ventilators	80
				Vertical Discharge	80
				Whole House Mechanical Ventilation	85
				Accessories	87
				Fresh Air Systems	85
				ULTRA™	88
				SmartSense®	85



Accessories	1	Heaters	20	Ventilation Fans	53
Dampers	5	Accessories	22	Basic	59
Ducting	6	Bulb	79	Bath Fan Upgrade Kit	60
Elbows	6	Ceiling	20	Bulb Heaters	65
Hanger Bars	6	Fan-Forced	21	Combination Units	64
Replacement Parts	1	Kickspace	21	Duct Free	60
Roof Caps	4	Portable	21	EZFit	59
Transitions	4	Project Packs	22	In-Line Fans	63
Wall Caps	5	Register	22	InVent	57
		Wall	21	LED	57
Central Vacuum Systems	13	Intercom Systems	23	LoProfile	58
Accessory Kits	14	NM100	23	LunAura	56
Power Units	13	NM200	24	Project Packs	60
Door Chimes	17	Electronic Door Release	25	Recessed Fan/Light	58
Accessories	20	Ironing Centers	25	Sensing	54
Chime Kits	18	Accessories	25	QT Series™	56 & 64
College Pride	19	Cabinets	25	ULTRA™	53 & 89
Hard-Wired Chimes	17	Doors	25	Utility	65
Wireless Chimes	18	Paddle/Ceiling Fans	10		
Wired Pushbuttons	19	Accessories	12		
Wireless Pushbuttons	20	Ceiling Hugger	10		
Haven™		Commercial	11		
Haven™ and Accessories	20	Controls	13		
		Standard Five Blades	10		
		Light Kits	11		
		Outdoor	10		
				Full Line Index	i
				Carton/UPC Directory	90

Full Line Index

Model No.	List Price	Code	Page Number(s)
1006	\$19.46	CP	52
100HFL	\$366.52	LV	78
100HL	\$304.68	LV	78
103023	\$512.70	DH	32
103123	\$64.98	DH	32
110RDF	\$114.96	HV	72
112	\$280.60	HT	21
114	\$249.74	HT	21
120	\$172.30	HT	22
124	\$180.78	HT	22
128	\$186.26	HT	22
12C	\$466.80	HV	80
153001	\$980.66	DH	45
153004	\$1,019.04	DH	45
153023	\$980.66	DH	45
153601	\$1,060.24	DH	45
153604	\$1,099.60	DH	45
153623	\$1,060.24	DH	45
157	\$133.90	HT	20
15TCBB	\$163.56	CP	52
15TCBL	\$24.94	CP	52
15TCOD	\$53.30	CP	52
15TCTK	\$23.58	CP	52
161	\$51.72	HV	79
162	\$107.80	HV	79
162F	\$20.72	HV	76
162H	\$87.08	HV	76
163	\$86.04	HV	79
164	\$143.84	HV	79
165F	\$127.04	HT	22
165FT	\$137.70	HT	22
1667H	\$9.98	LV	76
1667HMTL	\$23.66	LV	76
1670F	\$55.04	LV	76
1671F	\$49.48	LV	76
167F	\$127.04	HT	22
167FT	\$137.70	HT	22
1688F	\$35.20	LV	76
1689F	\$46.28	LV	76
170	\$172.30	HT	21
171H	\$34.56	HT	22
174	\$180.78	HT	21
174F	\$135.52	HT	22
174FT	\$146.20	HT	22
178	\$193.80	HT	21
192	\$422.78	HT	21
194	\$445.58	HT	21
198	\$466.80	HT	21
2677H	\$16.40	LV	75
2678F	\$80.90	LV	75
269VL	\$47.28	AC	7
269WL	\$47.28	AC	7
273001C	\$83.62	HA	30, 31
273002C	\$83.62	HA	30, 31
273003	\$1,047.58	DH	30
273023C	\$83.62	HA	30, 31
273601C	\$83.62	HA	30, 31
273602C	\$83.62	HA	30, 31
273603	\$1,047.58	DH	30
273623C	\$83.62	HA	30, 31
277V	\$91.60	AC	7, 84
283003	\$727.64	DH	31
283603	\$727.64	DH	31
326N	\$68.50	CA	14
330ALM	\$8.76	CA	14
330W	\$8.76	CA	14

Model No.	List Price	Code	Page Number(s)
331H	\$643.02	DH	37
332H	\$835.62	DH	37
332KR	\$110.28	HA	37
335	\$1,113.90	DH	37
336	\$1,390.56	DH	37
345CSOBK	\$562.28	SO	8
345CSOWW	\$562.28	SO	8
345GOBK	\$562.28	SO	8
345GOWW	\$562.28	SO	8
345RSOBK	\$598.34	SO	8
345RSOWW	\$598.34	SO	8
345SOBK	\$562.28	SO	8
345SOWW	\$562.28	SO	8
349BR	\$257.54	HV	8
35	\$30.14	AC	52
350BK	\$222.86	HV	8
350BR	\$229.14	HV	8
353	\$152.26	HV	9
35316	\$230.24	HV	9
355BK	\$236.16	HV	8
355BR	\$242.44	HV	8
356BK	\$307.68	HV	8
356BR	\$313.98	HV	8
356NDK	\$114.86	HA	33
357NDK	\$140.68	HA	33
358	\$273.48	HV	8
359NDK	\$140.68	AC	32
360ALM	\$20.60	CA	14
360IV	\$20.60	CA	14
360W	\$20.60	CA	14
3677H	\$21.04	LV	75
372	\$114.34	CA	14
372401	\$79.94	LL	50
372408	\$79.94	LL	50
373001	\$75.54	LL	50
373002	\$75.54	LL	50
373004	\$134.30	LL	50
373008	\$75.54	LL	50
373601	\$79.94	LL	50
373604	\$138.70	LL	50
376UL	\$73.64	CA	14
378	\$4.12	CA	14
3808	\$9.78	CA	14
3808B	\$9.78	CA	14
3810	\$11.84	CA	14
391	\$11.84	CA	14
392	\$28.84	CA	14
393	\$31.94	CA	14
394	\$20.08	CA	14
395	\$85.50	CA	14
3964	\$111.76	CA	14
402101	\$157.52	LL	50
402102	\$157.52	LL	50
402108	\$157.52	LL	50
402401	\$132.56	LL	50
402402	\$132.56	LL	50
402404	\$191.36	LL	50
402408	\$132.56	LL	50
403001	\$128.14	LL	50
403002	\$128.14	LL	50
403004	\$186.92	LL	50
403008	\$128.14	LL	50
403023	\$128.14	LL	50
403601	\$132.56	LL	50
403602	\$132.56	LL	50
403604	\$191.36	LL	50

Model No.	List Price	Code	Page Number(s)
403608	\$132.56	LL	50
403623	\$132.56	LL	50
404201	\$136.92	LL	50
404202	\$136.92	LL	50
404208	\$136.92	LL	50
406	\$23.10	AC	6
407	\$23.84	AC	6
408	\$26.00	AC	6
410	\$30.78	AC	6
411	\$28.00	AC	4
412101	\$160.74	LL	51
412102	\$160.74	LL	51
412108	\$160.74	LL	51
412123	\$160.74	LL	51
412401	\$135.78	LL	51
412402	\$135.78	LL	51
412404	\$194.56	LL	51
412408	\$135.78	LL	51
412H	\$30.14	AC	4
413	\$34.24	AC	4
413001	\$131.36	LL	51
413002	\$131.36	LL	51
413004	\$190.16	LL	51
413008	\$131.36	LL	51
413023	\$131.36	LL	51
413601	\$135.78	LL	51
413602	\$135.78	LL	51
413604	\$194.56	LL	51
413608	\$135.78	LL	51
413623	\$135.78	LL	51
414	\$50.98	AC	4
414201	\$140.20	LL	51
414202	\$140.20	LL	51
414204	\$198.98	LL	51
414208	\$140.20	LL	51
415	\$17.90	AC	6
418	\$43.28	AC	4, 6
419	\$18.92	AC	6
41F	\$17.42	AC	3, 46, 48, 51
421	\$47.82	AC	5
422401	\$125.04	LL	49
422401D	\$135.34	LL	49
422402	\$125.04	LL	49
422404	\$183.84	LL	49
422408	\$125.04	LL	49
423	\$70.56	AC	4, 82, 83, 84
423001	\$120.68	LL	49
423001D	\$130.62	LL	49
423002	\$120.68	LL	49
423004	\$179.44	LL	49
423008	\$120.68	LL	49
423008D	\$130.62	LL	49
423023	\$120.68	LL	49
423601	\$125.04	LL	49
423601D	\$135.34	LL	49
423602	\$125.04	LL	49
423604	\$183.84	LL	49
423608	\$125.04	LL	49
423608D	\$135.34	LL	49
423623	\$125.04	LL	49
424	\$87.86	AC	4
424201	\$129.48	LL	49
424201D	\$139.80	LL	49
424202	\$129.48	LL	49
424204	\$188.22	LL	49
424208	\$129.48	LL	49

Model No.	List Price	Code	Page Number(s)
427	\$76.34	AC	4
428	\$35.64	AC	6
429	\$47.82	AC	6
430	\$62.18	AC	6
431	\$62.40	AC	6
432	\$31.30	AC	6
433	\$82.22	AC	9
433004	\$205.14	LL	47
433011	\$143.36	LL	47
433018	\$143.36	LL	47
433022	\$143.36	LL	47
433023	\$143.36	LL	47
433604	\$212.20	LL	47
433611	\$152.80	LL	47
433618	\$152.80	LL	47
433622	\$152.80	LL	47
433623	\$152.80	LL	47
437	\$192.06	AC	4
438	\$41.22	AC	5
441	\$102.12	AC	5
453	\$103.26	AC	4
454	\$103.26	AC	4
459	\$46.52	AC	4
462401	\$200.12	RH	46
462404	\$258.92	RH	46
462423	\$200.12	RH	46
463001	\$190.58	RH	46
463002	\$190.58	RH	46
463004	\$249.36	RH	46
463008	\$190.58	RH	46
463011	\$190.58	RH	46
463023	\$190.58	RH	46
463601	\$200.12	RH	46
463602	\$200.12	RH	46
463604	\$258.92	RH	46
463608	\$200.12	RH	46
463623	\$200.12	RH	46
464201	\$209.72	RH	46
464202	\$209.72	RH	46
464204	\$268.48	RH	46
464208	\$209.72	RH	46
472	\$50.60	AC	5
475	\$10.40	AC	4
475B	\$7.64	AC	4
502	\$232.20	HV	80
503	\$154.18	HV	80
504	\$182.92	HV	80
505	\$131.38	HV	80
506	\$231.94	HV	80
507	\$188.64	HV	80
508	\$231.94	HV	80
509	\$154.34	HV	80
509S	\$163.20	HV	80
510	\$208.34	HV	79
511	\$166.92	HV	79
512	\$73.74	HV	79
512M	\$105.30	HV	79
57V	\$46.64	AC	7
57W	\$46.64	AC	7
59V	\$60.34	AC	7, 87
59W	\$60.34	AC	7, 87
605RP	\$216.56	LV	65
610FA	\$135.80	AC	5
611	\$90.64	AC	4
611CM	\$120.12	AC	4
612	\$155.42	AC	4

Model No.	List Price	Code	Page Number(s)
612CM	\$169.90	AC	4
613	\$98.62	AC	5
613004	\$2,227.84	DH	26
614804	\$2,518.80	DH	26
614804EX	\$1,917.40	DH	26
619004	\$2,256.94	DH	26
619004EX	\$1,648.56	DH	26
61V	\$60.34	AC	7, 87
61W	\$60.34	AC	7, 87
6201	\$105.72	PH	21
62W	\$89.52	AC	7
634	\$51.74	AC	4
634M	\$60.34	AC	4, 87
636	\$29.62	AC	4
636AL	\$38.36	AC	4
637004	\$4,310.06	DH	26
637004EX	\$3,891.40	DH	26
639	\$34.86	AC	5
63V	\$79.94	AC	7
63W	\$79.94	AC	7
641	\$71.04	AC	5, 87
641FA	\$57.22	AC	5
642	\$27.04	AC	5
643	\$89.52	AC	5
643FA	\$84.10	AC	5
644	\$66.92	AC	4
646	\$48.14	AC	5
647	\$80.22	AC	5
649	\$45.08	AC	5
64V	\$115.84	AC	7
64W	\$115.84	AC	7
654H	\$26.66	LV	76
655	\$218.42	LV	78
655F	\$191.76	LV	76
656	\$190.46	LV	78
656F	\$163.82	LV	76
657	\$144.00	LV	78
657F	\$117.34	LV	76
658	\$211.26	LV	78
658F	\$184.60	LV	76
659	\$215.38	LV	78
659F	\$188.72	LV	76
665RP	\$218.42	LV	65
668RP	\$141.06	LV	59
66V	\$38.22	AC	7
66W	\$38.22	AC	7
670	\$65.02	LV	73
671	\$59.46	LV	73
673	\$59.34	LV	80
678	\$97.30	LV	73
67W	\$41.40	AC	7
682	\$67.62	LV	73
682NT	\$67.62	LV	60
685WL	\$68.16	AC	7
688	\$45.18	LV	73
689	\$56.26	LV	73
68V	\$31.04	AC	7
68W	\$31.04	AC	7
690	\$59.74	UK	73
690NT	\$59.74	UK	60
690RA	\$9.98	LV	62
690RMTLA	\$23.24	LV	62
695	\$59.46	LV	59
695RB	\$49.48	LV	62
696	\$197.84	LV	78
696N	\$45.18	LV	59

Model No.	List Price	Code	Page Number(s)
696RNB	\$35.20	LV	62
69W	\$12.84	AC	7, 9
70TW	\$66.14	AC	7
71V	\$63.56	AC	7, 9
72V	\$84.92	AC	7, 37
72W	\$84.92	AC	7, 37
73	\$44.84	AC	9
741SN	\$173.40	HV	71
744	\$171.96	NF	71
744FL	\$238.46	NF	71
744FLNT	\$238.46	NF	58
744LED	\$307.98	NF	71
744LEDNT	\$307.98	NF	58
744NT	\$171.96	NF	58
744SFL	\$342.68	NF	71
744SFLNT	\$342.68	NF	58
750	\$244.08	HV	72
751	\$220.04	HV	72
754RB	\$176.20	HV	71
75V	\$86.52	AC	7
761BN	\$189.40	HV	71
761RB	\$189.40	HV	71
761WHA	\$189.40	HV	71
763	\$94.46	LV	59
763F	\$78.06	LV	62
763H	\$16.40	LV	62
765HFL	\$366.52	LV	64
765HL	\$304.68	LV	64
77DV	\$44.60	AC	7, 64, 78
77DW	\$44.60	AC	7, 64, 78
78V	\$49.76	PA	13
78W	\$49.76	PA	13
791LEDM	\$252.36	HM	71
79V	\$70.42	PA	13
79W	\$70.42	PA	13
804DD	\$17.20	AC	5
804DU	\$71.62	AC	6
804QDD	\$18.22	AC	61, 75
80L	\$50.98	AC	84
80RDF	\$109.24	HV	72
8210	\$169.88	HV	65
82W	\$101.30	AC	7, 87
83	\$21.52	AC	22
8310	\$208.24	HV	65
834	\$19.50	AC	1
84	\$44.00	AC	22
843BL	\$54.50	AC	5
85	\$97.60	AC	22
854	\$23.52	AC	1
8663RP	\$244.08	HV	59
8664RP	\$220.04	HV	59
877	\$32.14	AC	4
87W	\$31.14	AC	22
883001	\$505.36	RH	44
883002	\$505.36	RH	44
883004	\$569.32	RH	44
883008	\$505.36	RH	44
883011	\$505.36	RH	44
883023	\$505.36	RH	44
883601	\$555.90	RH	44
883604	\$624.38	RH	44
883608	\$555.90	RH	44
883623	\$555.90	RH	44
883901	\$618.26	RH	44
883904	\$701.82	RH	44
884201	\$609.80	RH	44

Model No.	List Price	Code	Page Number(s)
884204	\$737.90	RH	44
884223	\$609.80	RH	44
884801	\$636.12	RH	44
884804	\$668.48	RH	44
884823	\$636.12	RH	44
885AL	\$39.60	AC	5
885BL	\$31.28	AC	5
885NS	\$30.94	AC	5
889	\$29.32	AC	6
88F	\$32.30	AC	3, 43, 44
893001	\$657.16	RH	44
893004	\$738.36	RH	44
893011	\$657.16	RH	44
893023	\$657.16	RH	44
893601	\$680.60	RH	44
893604	\$761.82	RH	44
893623	\$680.60	RH	44
893901	\$719.62	RH	44
893904	\$800.82	RH	44
894201	\$704.02	RH	44
894204	\$785.22	RH	44
894223	\$704.02	RH	44
894801	\$727.44	RH	44
894804	\$808.68	RH	44
90	\$57.84	AC	7, 21, 22
9093WH	\$414.70	HV	64
9412D	\$51.72	HV	65
9417DN	\$107.80	HV	65
9422P	\$86.04	HV	65
9427P	\$143.84	HV	65
961L	\$31.28	AC	84
97	\$37.08	AC	5
9810WH	\$266.46	HT	21
9815WH	\$273.74	HT	21
981L	\$31.28	AC	84
982L	\$39.80	AC	84
983L	\$42.64	AC	84
9905	\$346.34	HV	64
9960	\$313.24	HV	64
9965	\$364.42	HV	64
A000HF	\$23.34	HM	74
A000HFS	\$103.34	HM	69
A000HL	\$23.34	HM	74
A110	\$166.68	HM	70
A110F	\$143.34	HM	74
A110L	\$383.34	HM	70
A50L	\$145.00	HM	70
A70L	\$146.68	HM	70
A70LF	\$123.34	HM	74
A80	\$150.00	HM	70
A80F	\$126.68	HM	74
A80HD	\$193.34	HM	70
A80HDF	\$170.00	HM	74
A80L	\$350.00	HM	70
ACCGSEF2	\$39.80	GA	87
ACCGSFF2	\$39.78	GA	87
ACCGSFH	\$168.70	GA	87
ACCGSFHP10	\$1,881.00	GA	87
ACCGSFHP2	\$198.50	GA	87
ACCGSFP2	\$36.68	GA	87
ACCGSFP20	\$353.44	GA	87
ACCGSUHD	\$56.98	GA	87
ACCGSUP5	\$71.52	GA	87
ACCHEPAPFK	\$36.20	AQ	87
ACCHEPARF	\$98.04	AQ	87
ACCWMK	\$70.02	AQ	87

Model No.	List Price	Code	Page Number(s)
AE110	\$266.68	HM	70
AE110F	\$243.34	HM	74
AE110L	\$433.34	HM	70
AE110LF	\$337.84	HM	74
AE110S	\$353.98	HM	69
AE110SL	\$489.30	HM	69
AE50	\$166.68	HM	70
AE50F	\$143.34	HM	74
AE60	\$809.40	AQ	85
AE80	\$240.00	HM	70
AE80B	\$116.68	HM	70
AE80BF	\$93.34	HM	74
AE80BL	\$216.66	HM	70
AE80BLF	\$193.32	HM	74
AE80F	\$216.68	HM	74
AE80L	\$400.00	HM	70
AE80LF	\$376.68	HM	74
AE80S	\$326.50	HM	69
AE80SL	\$429.10	HM	69
AEE60302SS	\$299.76	HA	34
AEE60362SS	\$311.34	HA	34
AEE60422SS	\$322.98	HA	34
AEE60482SS	\$334.62	HA	34
AEPD18SS	\$318.28	OH	35
AEPD18SSE	\$335.24	OH	35
AEPD2445SS	\$843.42	OH	35
AEPD2445SSE	\$875.26	OH	35
AEPD30SS	\$420.12	OH	35
AEPD30SSE	\$437.10	OH	35
AEPD6SS	\$182.48	OH	35
AEPD6SSE	\$199.44	OH	35
AEN110	\$266.68	HM	57
AEN110F	\$243.34	HM	60
AEN110L	\$433.34	HM	57
AEN50	\$166.68	HM	57
AEN50F	\$143.34	HM	60
AEN80	\$240.00	HM	57
AEN80B	\$116.68	HM	57
AEN80BF	\$93.34	HM	60
AEN80BL	\$216.66	HM	57
AEN80BLF	\$193.32	HM	60
AEN80F	\$216.68	HM	60
AEN80L	\$400.00	HM	57
AEN80LF	\$376.68	HM	60
AN000HF	\$23.34	HM	60
AN000HL	\$23.34	HM	60
AN110	\$166.68	HM	57
AN110F	\$143.34	HM	60
AN110L	\$383.34	HM	57
AN70L	\$146.68	HM	57
AN70LF	\$123.34	HM	60
AN80HDF	\$170.00	HM	60
AN80L	\$350.00	HM	57
ANKE60302SS	\$346.48	HA	34, 35
ANKE60362SS	\$358.98	HA	34, 35
ANKE60422SS	\$448.02	HA	34, 35
ANKE60482SS	\$453.52	HA	34, 35
AP130BL	\$658.18	RH	43
AP130SS	\$709.82	RH	43
AP130WW	\$658.18	RH	43
AP136BL	\$678.82	RH	43
AP136SS	\$730.44	RH	43
AP136WW	\$678.82	RH	43
APE130SS	\$752.48	RH	43
ARP310	\$49.18	AC	30, 31, 34, 35, 41
ARP314	\$49.18	AC	36

Model No.	List Price	Code	Page Number(s)
ARP6	\$49.18	AC	26, 28, 29, 31, 33
AVDOFPN	\$146.42	IB	25
AVDORPN	\$174.44	IB	25
AVDSMN	\$85.84	IB	25
AVDWRPN	\$183.60	IB	25
AWEPD36SS	\$387.24	OH	35
AWEPD48SS	\$437.10	OH	35
AWEPD60SS	\$469.00	OH	35
B12LCDARNW	\$7,585.16	AQ	85
B12LCDASNW	\$7,585.16	AQ	85
B12LCDPRNC	\$7,973.92	AQ	85
B12LCDPRNW	\$6,880.80	AQ	85
B12LCDPSNC	\$7,973.92	AQ	85
B12LCDPSNW	\$6,880.80	AQ	85
B12LCEARNW	\$7,131.32	AQ	85
B12LCEASNW	\$7,131.32	AQ	85
B12LCEPRNC	\$7,520.08	AQ	85
B12LCEPRNW	\$6,426.96	AQ	85
B12LCEPSNC	\$7,520.08	AQ	85
B12LCEPSNW	\$6,426.96	AQ	85
B1600705	\$7,180.10	AQ	87
B6LCDARN	\$6,285.44	AQ	85
B6LCDASN	\$6,285.44	AQ	85
B6LCDPRN	\$5,846.24	AQ	86
B6LCDPSN	\$5,846.24	AQ	86
B6LCEARN	\$5,021.52	AQ	86
B6LCEASN	\$5,021.52	AQ	86
B6LCEPRN	\$4,582.32	AQ	86
B6LCEPSN	\$4,582.32	AQ	86
BCR1	\$88.64	QA	27, 38
BD4	\$83.98	AQ	6, 87
BD6	\$83.98	AQ	6, 87
BK105	\$24.22	DC	18
BK110NBWH	\$32.14	DC	18
BK115LWH	\$35.28	DC	18
BK120NBWH	\$34.08	DC	18
BK125LWH	\$37.70	DC	18
BK131LPB	\$37.82	DC	18
BK131LRBZ	\$37.82	DC	18
BK131LSN	\$37.82	DC	18
BK131LWH	\$37.82	DC	18
BK140LWH	\$38.82	DC	18
BK140SLPB	\$41.46	DC	18
BK142LWH	\$41.46	DC	18
BK144LCL	\$32.14	DC	18
BK147LWH	\$54.30	DC	18
BP1	\$17.14	AC	2
BP10	\$15.30	AC	2
BP11	\$17.14	AC	2
BP17	\$43.42	AC	2
BP18	\$43.42	AC	2
BP19	\$43.42	AC	2
BP2	\$17.14	AC	2
BP20	\$7.60	AC	1
BP24	\$17.22	AC	1
BP25	\$11.02	AC	1
BP27	\$35.70	AC	1
BP28	\$36.44	AC	1
BP29	\$9.34	AC	2, 46, 48, 49, 50
BP33	\$11.54	AC	1
BP34	\$11.54	AC	1
BP35	\$15.10	AC	1
BP36	\$14.46	AC	1
BP38	\$15.10	AC	1
BP4	\$9.34	AC	2
BP43	\$7.02	AC	2

Model No.	List Price	Code	Page Number(s)
BP436	\$7.02	AC	2
BP46	\$6.12	AC	1
BP5	\$9.44	AC	2
BP50	\$25.94	AC	1
BP51	\$36.44	AC	1
BP52	\$47.66	AC	2
BP55	\$9.34	AC	2
BP56	\$17.14	AC	2
BP57	\$16.50	AC	2, 47
BP58	\$11.58	AC	2, 47
BP7	\$9.44	AC	2
BP87	\$11.46	AC	2, 5, 38, 39, 40, 41, 42, 46
BP87Q	\$18.42	AC	5, 48, 49
BP90	\$8.68	AC	1
BP91	\$18.66	AC	1
BPAPFA	\$51.62	AC	2, 43
BPP2FA30	\$56.82	QA	2, 39
BPP2FA36	\$68.18	QA	2, 39
BPP2FA42	\$85.26	QA	2, 39
BPP3FA30	\$71.60	QA	2, 38
BPP3FA36	\$82.96	QA	2, 38
BPP3FA42	\$100.00	QA	2, 38
BPPF30	\$29.82	QA	2, 38, 39
BPPF36	\$32.24	QA	2, 38, 39
BPPF42	\$38.92	QA	2, 38, 39
BPPFA30	\$53.70	QA	2, 39
BPPFA36	\$60.86	QA	2, 39
BPPFA42	\$68.18	QA	2, 39
BPODE30	\$57.82	AC	2, 42
BPQTAF	\$9.40	AC	2, 45, 46
BPQTF	\$11.80	AC	2, 45, 46
BPRPFA	\$23.24	AC	2, 43
BPS1FA30	\$27.60	AC	3, 42
BPS1FA36	\$30.22	AC	3, 42
BPS2FA30	\$40.44	AC	3, 41
BPS2FA36	\$44.88	AC	3, 41
BPS3FA30	\$61.84	AC	3, 40
BPS3FA36	\$69.20	AC	3, 40
BPSF30	\$31.52	AC	3, 40, 41, 42
BPSF36	\$33.70	AC	3, 40, 41, 42
BPSF42	\$36.22	AC	3, 40, 41, 42
C350BN	\$35.30	AC	1
C350GN	\$10.48	AC	1
C370BN	\$50.44	AC	1
C905	\$17.10	DA	20
C907	\$27.10	DA	20
C909	\$30.18	DA	20
C915	\$27.10	DA	20
CA130	\$61.80	CA	14
CF328	\$2.58	CA	14
CF329	\$6.18	CA	14
CF361	\$14.42	CA	14
CF361F	\$20.08	CA	14
CF362	\$3.10	CA	14
CF363	\$4.64	CA	14
CF364	\$4.64	CA	14
CF365	\$4.64	CA	14
CF366	\$2.58	CA	15
CF367	\$13.90	CA	15
CF368	\$1.76	CA	15
CF369	\$1.76	CA	15
CF372	\$6.18	CA	15
CF377	\$1.76	CA	15
CF380	\$1.04	CA	15
CF382	\$1.64	CA	15
CF382S	\$1.64	CA	15

Model No.	List Price	Code	Page Number(s)
CF382XS	\$2.58	CA	15
CF383	\$2.26	CA	15
CF384	\$3.60	CA	15
CF385	\$1.54	CA	15
CF386	\$2.06	CA	15
CF387	\$3.10	CA	15
CF388	\$1.04	CA	15
CF389	\$2.06	CA	15
CF3918	\$19.58	CA	15
CFC56BR	\$194.20	PF	11
CFC56WH	\$194.20	PF	11
CFH52BS	\$173.78	PF	10
CFH52RB	\$173.78	PF	10
CFH52WH	\$167.14	PF	10
CFO52BQ	\$207.42	PF	10
CFO52WB	\$189.76	PF	10
CFO52WH	\$196.40	PF	10
CFS52BS	\$138.20	PF	10
CFS52RB	\$139.96	PF	10
CFS52WH	\$133.70	PF	10
CFSABR	\$15.32	PA	12
CFSABS	\$15.76	PA	12
CFSARB	\$16.64	PA	12
CFSAWH	\$15.32	PA	12
CFT12WH	\$69.40	AC	7
CH230L	\$184.88	CA	15
CH235	\$149.86	CA	15
CH515	\$353.80	CA	15
CH615	\$353.80	CA	15
CI319	\$2.06	CA	15
CI324	\$2.06	CA	15
CI330	\$6.18	CA	15
CI3301RK	\$88.06	CA	15
CI3303RK	\$120.52	CA	15
CI358W	\$23.70	CA	15
CI365W	\$82.40	CA	15
CI366W	\$7.22	CA	15
CI367IV	\$72.10	CA	15
CI367W	\$72.10	CA	15
CI390W	\$10.30	CA	15
CI395RK	\$29.88	CA	15
CI399ALM	\$10.30	CA	15
CI399EB	\$21.26	CA	15
CI399RK	\$29.88	CA	15
CI399W	\$10.30	CA	15
CK110	\$52.36	CA	15
CK135	\$27.82	CA	16
CS100	\$128.76	CA	16
CS200	\$138.02	CA	16
CS300	\$396.56	CA	16
CS400	\$473.80	CA	16
CS500	\$854.90	CA	16
CS600	\$854.90	CA	16
CT105	\$4.64	CA	16
CT106G	\$6.70	CA	16
CT109	\$3.60	CA	16
CT110	\$3.60	CA	16
CT132	\$26.26	CA	16
CT140G	\$28.84	CA	16
CT143B	\$17.00	CA	16
CT150B	\$24.20	CA	16
CT156B	\$26.26	CA	16
CT157B	\$37.08	CA	16
CT158	\$43.26	CA	16
CT170	\$54.08	CA	16
CT175	\$54.08	CA	16

Model No.	List Price	Code	Page Number(s)
CT350B	\$40.18	CA	16
CT700	\$292.00	CA	16
CVG4	\$35.38	AC	1, 63, 77
CVG6	\$47.56	AC	1, 63, 77
CVL4	\$32.94	AC	1
CVL5	\$20.60	AC	1
CVL6	\$30.82	AC	1
CVLD4	\$47.84	AC	1, 63
CVLD6	\$57.12	AC	1, 63
CWT45	\$42.44	SO	8
D100	\$31.82	AC	84
D101	\$33.46	AC	84
DC4	\$7.52	AC	4
DH100W	\$47.54	AC	9
DR12OBQ	\$15.66	PA	12
DR12OWB	\$15.66	PA	12
DR12OWH	\$15.66	PA	12
DR12RB	\$15.66	PA	12
DR12WH	\$9.04	PA	12
DR18OBQ	\$21.74	PA	12
DR18OWB	\$21.86	PA	12
DR18RB	\$21.74	PA	12
DR18WH	\$11.04	PA	12
DR1BA	\$84.56	IA	25
DR1SA	\$99.98	IA	25
DR24BR	\$24.82	PA	12
DR24OBQ	\$24.82	PA	12
DR24OWB	\$24.82	PA	12
DR24RB	\$24.82	PA	12
DR24WH	\$14.24	PA	12
DR2SA	\$177.64	IA	25
DR36BR	\$32.54	PA	12
DR36BS	\$32.54	PA	12
DR36OBQ	\$32.54	PA	12
DR36OWB	\$32.54	PA	12
DR36RB	\$32.54	PA	12
DR36WH	\$19.10	PA	12
DR48BR	\$39.62	PA	12
DR48BS	\$39.16	PA	12
DR48RB	\$39.16	PA	12
DR48WH	\$26.36	PA	12
DT4C	\$49.36	AC	87
DT4W	\$71.72	AC	87
DT6C	\$64.64	AC	87
DT6W	\$100.32	AC	6, 87
E5490SS	\$2,787.48	DH	28
E6030SS	\$1,907.64	DH	34
E6036SS	\$1,983.58	DH	34
E6042TSS	\$2,332.70	DH	34
E6048TSS	\$2,409.66	DH	34
E60E30SS	\$1,616.48	DH	34
E60E36SS	\$1,709.88	DH	34
E60E42SS	\$1,754.42	DH	34
E60E48SS	\$1,842.56	DH	34
E6430SS	\$1,268.42	DH	35
E6436SS	\$1,295.24	DH	35, 45
E6442SS	\$1,393.08	DH	35
E6448SS	\$1,449.34	DH	35
E6448TSS	\$1,717.36	DH	35
E64E30SS	\$1,027.70	DH	35
E64E36SS	\$1,078.44	DH	35
E64E42SS	\$1,181.82	DH	35
E64E48SS	\$1,246.02	DH	35
E66130BL	\$1,131.78	RH	36
E66130SS	\$1,215.28	RH	36
E66130WH	\$1,131.78	RH	36

Model No.	List Price	Code	Page Number(s)
E66136BL	\$1,167.52	RH	36
E66136SS	\$1,253.66	RH	36
E66136WH	\$1,167.52	RH	36
E66142SS	\$1,293.20	RH	36
EH6	\$76.70	AQ	87
EI5936SS	\$1,651.62	DH	27
EP300108	\$35.60	AC	51
EP300223	\$35.60	AC	51
EPD6136SS	\$2,440.08	OH	35
EPD6148SS	\$2,758.34	OH	35
EPD6160SS	\$3,639.00	OH	35
ERV100S	\$1,371.56	AQ	86
ERV100SP	\$1,496.36	AQ	86
ERV110S	\$1,366.56	AQ	86
ERV110T	\$1,366.56	AQ	86
ERV120S	\$1,433.96	AQ	86
ERV120T	\$1,433.96	AQ	86
ERV140TE	\$2,494.76	AQ	86
ERV180S	\$1,870.76	AQ	86
ERV200TE	\$3,549.86	AQ	86
ERV250TE	\$2,995.20	AQ	86
ERV70S	\$1,246.76	AQ	86
ERV70T	\$1,246.76	AQ	86
ERVH100S	\$1,995.56	AQ	86
ERVS100S	\$1,064.00	AQ	86
EW5630SS	\$1,096.88	DH	27
EW5636SS	\$1,147.96	DH	27
EW5830SS	\$1,096.88	DH	27
EW5836SS	\$1,147.96	DH	27
EZ80N	\$236.60	HV	59
F402401	\$141.00	LL	48
F402402	\$141.00	LL	48
F402404	\$200.46	LL	48
F402408	\$141.00	LL	48
F402411	\$141.00	LL	48
F402422	\$141.00	LL	48
F402423	\$141.00	LL	48
F403001	\$135.24	LL	48
F403002	\$135.24	LL	48
F403004	\$192.26	LL	48
F403008	\$135.24	LL	48
F403011	\$135.24	LL	48
F403022	\$135.24	LL	48
F403023	\$135.24	LL	48
F403601	\$148.76	LL	48
F403602	\$148.76	LL	48
F403604	\$211.48	LL	48
F403608	\$148.76	LL	48
F403611	\$148.76	LL	48
F403622	\$148.76	LL	48
F403623	\$148.76	LL	48
F404201	\$163.62	LL	48
F404202	\$163.62	LL	48
F404204	\$232.64	LL	48
F404208	\$163.62	LL	48
F404211	\$163.62	LL	48
F404222	\$163.62	LL	48
F404223	\$163.62	LL	48
FILTERE56	\$57.56	AC	3, 27
FILTERE56FL	\$73.22	AC	27
FILTEREB40	\$93.42	HA	3, 29, 31
FILTER SQUARE	\$59.44	HA	3, 28, 29
FX54SS	\$929.16	HA	28
FXN54SS	\$929.16	HA	28
FXNE56SS	\$397.74	AC	27
FXNE58SS	\$284.86	AC	27

Model No.	List Price	Code	Page Number(s)
FXNE59SS	\$682.76	AC	27
FY6	\$46.20	AC	63
FY86	\$35.56	AC	63
G102	\$149.58	AC	84
G103	\$192.74	AC	84
G686N	\$12.68	AC	1
GU10	\$17.06	AC	31, 34, 35, 36, 38, 39, 43, 52
GU1035	\$15.92	AC	27, 39, 45, 52
HCK44	\$21.74	AC	52
HCK44D	\$14.30	AC	52
HD50RDF	\$120.88	HV	72
HD80L	\$154.68	HV	72
HLB11	\$1,146.88	DH	37
HLB3	\$424.78	DH	37
HLB6	\$716.78	DH	37
HLB9	\$961.04	DH	37
HRV120S	\$1,246.76	AQ	86
HRV120T	\$1,246.76	AQ	86
HRV150S	\$1,616.16	AQ	86
HRV150TE	\$1,643.12	AQ	86
HRV160T	\$1,553.76	AQ	86
HRV160TE	\$1,870.76	AQ	86
HRV190S	\$1,870.76	AQ	86
HRV200TE	\$2,745.60	AQ	86
HRV250TE	\$2,884.28	AQ	86
HRV80S	\$1,026.34	AQ	86
HRV80T	\$1,026.34	AQ	86
HRV90S	\$1,154.40	AQ	86
HRV90T	\$1,154.40	AQ	86
HRVH100S	\$1,496.36	AQ	86
HRVH100SE	\$1,773.82	AQ	86
HVDCT	\$78.00	ML	20
HVLFABL	\$200.00	ML	20
HVLFABR	\$200.00	ML	20
HVPFBL	\$9.00	ML	20
HVPFBR	\$9.00	ML	20
HVRC1	\$67.00	ML	20
HVRC4	\$206.00	ML	20
HVRFABL	\$165.00	ML	20
HVRFABR	\$165.00	ML	20
ICAB	\$36.16	IB	25
ICAK	\$134.62	IB	25
ICDFUW	\$116.68	IB	25
ICDM	\$151.68	IB	25
ICDRUW	\$116.68	IB	25
ICUDWHX	\$306.68	IB	25
ICUNUWX	\$285.18	IB	25
ILF120	\$320.94	HV	63
ILF130	\$336.22	HV	63
ILF250	\$351.50	HV	63
ILF360	\$482.02	HV	63
ILF530	\$631.14	HV	63
ILFK120	\$351.50	HV	63
ILFK130	\$366.80	HV	63
ILFK250	\$397.32	HV	63
ILFK2502	\$458.50	HV	63
ILRF	\$310.64	HV	63
L100	\$243.56	HV	81
L100L	\$262.80	HV	83
L100MG	\$269.92	HV	81
L150	\$251.76	HV	81
L1500	\$815.80	HV	82
L1500L	\$851.58	HV	83
L150L	\$271.08	HV	83
L150MG	\$278.20	HV	81

Model No.	List Price	Code	Page Number(s)
L200	\$277.48	HV	81
L2000L	\$1,221.78	HV	84
L200L	\$297.30	HV	83
L200MG	\$303.88	HV	81
L250	\$293.92	HV	81
L250L	\$313.70	HV	83
L250MG	\$320.28	HV	81
L300	\$300.28	HV	81
L300KMG	\$346.68	HV	81
L300L	\$320.12	HV	83
L300MG	\$326.68	HV	81
L3500EXL	\$1,691.26	HV	84
L400	\$406.90	HV	82
L400K	\$442.58	HV	82
L400KL	\$472.96	HV	83
L400L	\$437.22	HV	83
L500	\$492.50	HV	82
L500K	\$528.14	HV	82
L500KL	\$558.54	HV	83
L500L	\$522.86	HV	83
L700	\$578.10	HV	82
L700L	\$608.44	HV	83
L900	\$730.16	HV	82
L900L	\$766.00	HV	83
LA100WH	\$36.60	DC	17
LA107WH	\$96.38	DC	17
LA11BG	\$42.26	DC	17
LA11WH	\$42.26	DC	17
LA126WH	\$34.36	DC	17
LA130WH	\$62.70	DC	17
LA139WH	\$34.36	DC	17
LA140WH	\$34.36	DC	17
LA14WH	\$61.42	DC	17
LA164WH	\$166.60	DC	17
LA165SA	\$166.60	DC	17
LA174WH	\$133.60	DC	17
LA18WH	\$78.46	DC	17
LA202WH	\$53.10	DC	17
LA223WH	\$48.18	DC	18
LA224RWH	\$78.72	DC	18
LA224WH	\$88.18	DC	18
LA225WH	\$42.54	DC	18
LA226WH	\$65.18	DC	18
LA301WH	\$41.42	DC	17
LA305WL	\$351.62	DC	17
LA310CY	\$403.22	DC	17
LA39WH	\$162.84	DC	17
LA501CY	\$653.24	DC	17
LA542WH	\$66.46	DC	18
LA552RW	\$82.38	DC	18
LA553WH	\$53.82	DC	18
LA600WH	\$98.86	DC	17, 18
LA70MA	\$315.30	DC	17
LAF1	\$15.40	AC	84
LAF2	\$26.56	AC	84
LB30	\$99.56	HA	32, 33
LB36	\$110.18	HA	32, 33
LK20ASRB	\$92.12	PA	11
LK20FWBS	\$93.44	PA	11
LK20FWWH	\$92.68	PA	11
LK30ABS	\$93.44	PA	11
LK30ARB	\$94.32	PA	11
LK30AWH	\$92.68	PA	11
LK50DBQ	\$61.78	PA	11
LK50DWB	\$61.78	PA	11
LK50DWH	\$61.78	PA	11

Model No.	List Price	Code	Page Number(s)
LP80	\$148.96	HV	72
LP80F	\$120.92	HV	74
LP80H	\$28.04	HV	61, 74
LPN80	\$148.96	HV	58
LPN80F	\$120.92	HV	61
LT30	\$99.56	HA	32, 33
LT36	\$110.18	HA	32, 33
MCB2	\$14.94	AC	59, 71, 72, 73
MCV309NWHGL	\$60.14	DC	17
MD10S	\$297.06	HA	5
MD10T	\$307.66	HA	5, 35
MD10TU	\$350.10	HA	5
MD6S	\$171.86	HA	5
MD6T	\$174.86	HA	5, 27, 34, 35, 38
MD6TU	\$244.00	HA	5
MD8S	\$193.08	HA	5
MD8T	\$188.30	HA	5, 27, 34, 35, 38
MD8TU	\$265.22	HA	5
MG1	\$36.96	AC	84
MHB4	\$20.00	AC	57, 70
MMDC4	\$25.00	AC	57, 70
MMG	\$43.34	AC	57, 70
MP100	\$317.08	HV	77
MP140	\$367.88	HV	77
MP200	\$437.82	HV	77
MP280	\$507.50	HV	77
MQF4	\$20.00	AC	57, 70
NA200TA	\$60.26	NM	23, 24
NA3003C	\$67.62	NM	23, 24
NA3008C	\$133.98	NM	23, 24
NA300MCWH	\$24.60	NM	23, 24
NA300TA	\$77.42	NM	23, 24
NDB300AB	\$73.74	NM	23, 24
NDB300BB	\$79.62	NM	23, 24
NDB300N	\$76.34	NM	23, 24
NDB300WH	\$49.18	NM	23, 24
NDK35830BL	\$153.66	HA	43
NDK35830SS	\$165.96	HA	43
NDK35830WW	\$153.66	HA	43
NDK35836BL	\$165.96	HA	43
NDK35836SS	\$178.22	HA	43
NDK35836WW	\$165.96	HA	43
NES300DBL	\$27.04	NM	23, 24
NES300DWH	\$27.04	NM	23, 24
NF100CWH	\$95.90	NM	24
NF100MWH	\$63.90	NM	23, 24
NF200MWH	\$40.68	NM	23, 24
NF300DWH	\$25.84	NM	23, 24
NF300PWH	\$61.44	NM	23, 24
NF300RWH	\$38.12	NM	23, 24
NM100WH	\$889.84	NM	23
NM200AL	\$946.36	NM	24
NM200K	\$1,354.42	NM	24
NM200WH	\$860.36	NM	24
NPS103WH	\$126.58	NM	23
NPS104WH	\$126.58	NM	23
NPS200WH	\$121.70	NM	24
NR380WH	\$119.24	NM	23
NRKF200P	\$27.04	NM	23, 24
NRKR200R	\$50.40	NM	23, 24
NRKR300D	\$14.74	NM	23, 24
NRKRWH300	\$209.00	NM	23, 24
NRKS200PWH	\$39.32	NM	23, 24
NRKS300R	\$51.62	NM	23
NRS103WH	\$84.84	NM	23
NRS104WH	\$84.84	NM	23

Model No.	List Price	Code	Page Number(s)
NRS200AL	\$90.96	NM	24
NRS200WH	\$82.36	NM	24
NW4S	\$37.20	NM	23, 24
NWH300	\$182.44	NM	23, 24
P5	\$504.92	RH	37
P57W	\$48.72	AC	8
P59V	\$78.12	AC	8
P59W	\$78.12	AC	8
P66V	\$40.70	AC	8
P66W	\$40.70	AC	8
P685WL	\$71.24	AC	8
P68W	\$33.48	AC	8
P8	\$920.68	RH	37
PAR20	\$23.20	AC	31, 40, 41, 42, 52
PB10LGL	\$11.64	DA	19
PB15LBR	\$26.62	DA	19
PB15LPB	\$23.58	DA	19
PB15LSN	\$26.62	DA	19
PB18LWHCL	\$7.86	DA	19
PB18WHCL	\$5.00	DA	19
PB19LGL	\$20.20	DA	19
PB27LBR	\$26.62	DA	19
PB27LSN	\$26.62	DA	19
PB29LR	\$22.08	DA	19
PB29LSN	\$22.08	DA	19
PB41APB41LA	\$3.46	DA	19
PB41BGL	\$7.24	DA	19
PB41LBGL	\$10.08	DA	19
PB41LBR	\$11.96	DA	19
PB41LSN	\$11.96	DA	19
PB4LBL	\$22.78	DA	19
PB4LBR	\$26.62	DA	19
PB4LSN	\$26.62	DA	19
PB53LWH	\$22.78	DA	19
PB59LPB	\$20.50	DA	19
PB61LPB	\$24.96	DA	19
PB64LAB	\$21.22	DA	19
PB67AB	\$7.92	DA	19
PB69LBL	\$8.04	DA	19
PB69LPC	\$8.04	DA	19
PB69LSN	\$10.16	DA	19
PB69LWH	\$8.04	DA	19
PB78LWHCL	\$27.58	DA	20
PB7LBL	\$7.58	DA	19
PB7LPB	\$7.58	DA	19
PB7LSN	\$7.58	DA	19
PB7LWH	\$7.58	DA	19
PB7WH	\$7.58	DA	19
PB82WH	\$21.22	DC	20
PB85BR	\$36.82	DC	20
PB85SN	\$36.82	DC	20
PBL2	\$5.78	DA	20
PM250	\$193.60	RH	33
PM390	\$436.20	RH	33
PM500SS	\$762.20	DH	32
PME300	\$606.84	RH	33
PP500	\$638.60	CX	13
PP600	\$870.36	CX	13
PP650	\$1,158.76	CX	13
QDE30SS	\$743.34	RH	42
QDE30WW	\$708.50	RH	42
QML30BL	\$272.90	QP	45
QML30SS	\$309.54	QP	45
QML30WW	\$272.90	QP	45
QP130BL	\$348.44	QP	39
QP130SS	\$405.72	QP	39

Model No.	List Price	Code	Page Number(s)
QP130WW	\$348.44	QP	39
QP136BL	\$361.56	QP	39
QP136SS	\$418.84	QP	39
QP136WW	\$361.56	QP	39
QP142BL	\$392.90	QP	39
QP142SS	\$453.86	QP	39
QP142WW	\$392.90	QP	39
QP230BC	\$529.58	QP	39
QP230BL	\$529.58	QP	39
QP230SS	\$589.82	QP	39
QP230WW	\$529.58	QP	39
QP236BC	\$542.08	QP	39
QP236BL	\$542.08	QP	39
QP236SS	\$602.32	QP	39
QP236WW	\$542.08	QP	39
QP242BC	\$555.72	QP	39
QP242BL	\$555.72	QP	39
QP242SS	\$615.96	QP	39
QP242WW	\$555.72	QP	39
QP330BL	\$714.84	QP	38
QP330SS	\$776.18	QP	38
QP330WW	\$714.84	QP	38
QP336BL	\$728.46	QP	38
QP336SS	\$789.84	QP	38
QP336WW	\$728.46	QP	38
QP342BL	\$740.96	QP	38
QP342SS	\$802.30	QP	38
QP342WW	\$740.96	QP	38
QP430SS	\$960.24	QP	38
QP436SS	\$974.90	QP	38
QP442SS	\$987.38	QP	38
QS130AA	\$283.14	AH	42
QS130BC	\$283.14	AH	42
QS130BL	\$283.14	AH	42
QS130SS	\$343.82	AH	42
QS130WW	\$283.14	AH	42
QS136AA	\$296.62	AH	42
QS136BC	\$296.62	AH	42
QS136BL	\$296.62	AH	42
QS136SS	\$364.08	AH	42
QS136WW	\$296.62	AH	42
QS142AA	\$320.52	AH	42
QS142BC	\$320.52	AH	42
QS142BL	\$320.52	AH	42
QS142SS	\$384.26	AH	42
QS142WW	\$320.52	AH	42
QS230AA	\$502.56	AH	41
QS230BC	\$502.56	AH	41
QS230BL	\$502.56	AH	41
QS230SS	\$566.26	AH	41
QS230WW	\$502.56	AH	41
QS236AA	\$520.28	AH	41
QS236BC	\$520.28	AH	41
QS236BL	\$520.28	AH	41
QS236SS	\$591.00	AH	41
QS236WW	\$520.28	AH	41
QS242AA	\$534.40	AH	41
QS242BC	\$534.40	AH	41
QS242BL	\$534.40	AH	41
QS242SS	\$612.28	AH	41
QS242WW	\$534.40	AH	41
QS330AA	\$672.46	AH	40
QS330BC	\$672.46	AH	40
QS330BL	\$672.46	AH	40
QS330SS	\$736.12	AH	40
QS330WW	\$672.46	AH	40

Model No.	List Price	Code	Page Number(s)
QS336AA	\$686.62	AH	40
QS336BC	\$686.62	AH	40
QS336BL	\$686.62	AH	40
QS336SS	\$757.40	AH	40
QS336WW	\$686.62	AH	40
QS342AA	\$700.76	AH	40
QS342BC	\$700.76	AH	40
QS342BL	\$700.76	AH	40
QS342SS	\$778.62	AH	40
QS342WW	\$700.76	AH	40
QSE130BL	\$375.12	AH	42
QSE130SS	\$430.30	AH	42
QSE130WW	\$375.12	AH	42
QT230AA	\$246.34	AH	46
QT230BC	\$246.34	AH	46
QT230BL	\$246.34	AH	46
QT230SS	\$325.60	AH	46
QT230WW	\$246.34	AH	46
QT236AA	\$254.82	AH	46
QT236BC	\$254.82	AH	46
QT236BL	\$254.82	AH	46
QT236SS	\$334.10	AH	46
QT236WW	\$254.82	AH	46
QT242AA	\$260.48	AH	46
QT242BC	\$260.48	AH	46
QT242BL	\$260.48	AH	46
QT242SS	\$339.72	AH	46
QT242WW	\$260.48	AH	46
QT9093WH	\$507.64	HV	64
QTHB1	\$18.70	AC	6
QTNLEDA	\$423.30	NF	56
QTNLEDB	\$423.30	NF	56
QTX110HFLT	\$610.34	HV	78
QTX110HL	\$548.52	HV	78
QTXE080	\$252.68	HV	69
QTXE080FLT	\$372.34	HV	69
QTXE110	\$285.90	HV	69
QTXE110FLT	\$412.22	HV	69
QTXE110S	\$400.62	HV	69
QTXE150	\$342.46	HV	69
QTXE150FLT	\$482.08	HV	69
QTXEN080	\$252.68	HV	56
QTXEN080FLT	\$372.34	HV	56
QTXEN110	\$285.90	HV	56
QTXEN110FLT	\$412.22	HV	56
QTXEN150	\$342.46	HV	56
QTXEN150FLT	\$482.08	HV	56
QTXN110HFLT	\$610.34	HV	64
QTXN110HL	\$548.52	HV	64
RB110	\$290.68	HP	68
RB110L	\$408.46	HP	68
RB80	\$262.06	HP	68
RB80L	\$383.00	HP	68
RBFIP33	\$220.72	AC	31
RBFIP45	\$272.22	AC	31
RCK01	\$52.96	PA	10, 13
RD1	\$171.06	AC	84
RD2	\$182.48	AC	84
RD3	\$228.14	AC	84
RDF1	\$121.24	HP	61, 75
RDFQF	\$121.24	HV	61, 75
RDFQL	\$121.24	HV	61, 75
RDFU	\$121.24	HP	61, 75
RDFUWT	\$121.24	HP	61, 75
RDH	\$138.76	HV	72
RDJ1	\$141.36	HV	61, 75

Model No.	List Price	Code	Page Number(s)
RDJUMPQ	\$8.44	AC	61, 75
RDJUMPU	\$16.90	AC	61, 75
RDM1	\$166.68	HM	57, 70
RDMWT	\$166.68	HM	57, 70
RFTH95	\$22.30	AC	9
RFX5001	\$283.04	HA	29
RFX5004	\$283.04	HA	29
RFX5023	\$283.04	HA	29
RFX5104	\$283.04	HA	29
RFX5204	\$283.04	HA	28
RFX5304	\$291.50	HA	28
RFX6104	\$509.40	HA	26
RFX6104EX	\$566.00	HA	26
RFX6304EX	\$1,386.76	HA	26
RFX6504	\$509.40	HA	26
RFXN5004	\$283.04	HA	29
RFXN5204	\$283.04	HA	28
RFXN5304	\$291.50	HA	28
RG4	\$35.64	AC	1
RK54	\$199.12	HA	28
RKE56	\$223.48	AC	27
RKE58	\$223.48	AC	27
RKE59	\$223.48	AC	27
RM503001	\$976.40	DH	29
RM503004	\$976.40	DH	29
RM503023	\$976.40	DH	29
RM503601	\$1,066.96	DH	29
RM503604	\$1,066.96	DH	29
RM503623	\$1,066.96	DH	29
RM519004	\$1,287.68	DH	29
RM523004	\$1,208.48	DH	28
RM523604	\$1,287.68	DH	28
RM524204	\$1,454.68	DH	28
RM533004	\$1,208.48	DH	28
RM533604	\$1,287.68	DH	28
RM534204	\$1,454.68	DH	28
RM659004	\$2,971.64	DH	26
RMDD3004	\$1,715.08	DH	30
RMDD3004EX	\$1,372.60	DH	30
RMDD3604	\$1,763.16	DH	30
RMDD3604EX	\$1,409.36	DH	30
RMDD4804	\$1,938.60	DH	30
RMDD4804EX	\$1,599.06	DH	30
RMDDRKBK	\$70.74	HA	30
RME5030SS	\$1,052.58	RH	29
RMIP33	\$776.58	DH	31
RMIP45	\$855.82	DH	31
RMIPWC	\$138.68	HA	31
RML3336S	\$313.80	HA	32
RML3342S	\$321.10	HA	32
RML4548S	\$339.30	HA	32
RML4554S	\$370.88	HA	32
RML4560S	\$375.96	HA	32
RML5230S	\$265.92	HA	32
RML7030L	\$284.22	HA	32
RML7030S	\$265.92	HA	32
RML7036L	\$321.10	HA	32
RML7036S	\$313.80	HA	32
RML7048L	\$393.44	HA	32
RML7048S	\$339.30	HA	32
RMP17004	\$1,075.46	DH	31
RMP3004	\$537.06	HA	36
RMP3604	\$574.82	HA	36
RMP4204	\$612.48	HA	36
RMP4804	\$650.20	HA	36
RMP5404	\$688.00	HA	36

Model No.	List Price	Code	Page Number(s)
RMP6004	\$725.66	HA	36
RMPE7004	\$764.12	DH	31
RN110	\$290.68	HP	55
RN110L	\$408.46	HP	55
RN80	\$262.06	HP	55
RN80L	\$383.00	HP	55
ROUNDFILTER	\$97.14	HA	3, 26
RP130BL	\$567.82	RH	43
RP130SS	\$619.46	RH	43
RP130WW	\$567.82	RH	43
RP136BL	\$588.48	RH	43
RP136SS	\$640.08	RH	43
RP136WW	\$588.48	RH	43
RRK51	\$147.16	HA	28, 29
RVK1A	\$71.72	AC	4
S97011308	\$45.60	PT	72
S97013825	\$42.48	PT	81
S97013826	\$35.46	PT	81
S97013827	\$51.44	PT	81
S99010042	\$10.46	PT	81
S99010271	\$13.04	PT	81
S990712044	\$0.64	PT	7
SMD6	\$281.36	HA	5, 85
SMD8	\$296.16	HA	5, 85
SMSCPLR	\$45.90	AR	55, 68, 85
SP100	\$285.40	HV	77
SP140	\$301.24	HV	77
SP200	\$317.08	HV	77
SP240108	\$39.28	AC	51
SP240223	\$38.28	AC	51
SP2404	\$99.80	AC	51
SP300108	\$39.28	AC	51
SP300223	\$39.28	AC	51
SP3004	\$99.80	AC	51
SP360108	\$45.74	AC	51
SP360223	\$45.74	AC	51
SP3604	\$106.04	AC	51
SP420108	\$53.14	AC	51
SP420223	\$53.14	AC	51
SP4204	\$123.02	AC	51
SPB18LWHCL	\$7.96	PT	20
SPK110	\$394.84	HV	55, 68
SPKACC	\$181.98	AC	55, 68
SSQTXE080	\$287.06	HV	55, 68, 85
SSQTXE110	\$318.84	HV	55, 68, 85
T457	\$26.00	AC	4, 49
T460	\$34.90	AC	4, 36, 38
T461	\$45.24	AC	4, 36, 38
T486	\$31.30	AC	4
T487	\$33.32	AC	4
T81212	\$71.60	AC	4, 82, 83, 84
TF40BS	\$63.44	PA	11
TF40GAP	\$76.68	PA	11
TF40GCL	\$61.24	PA	11
TF40GFW	\$62.90	PA	11
TF40RB	\$63.44	PA	11
TF40WH	\$62.34	PA	11
TYIK1	\$125.48	AQ	87
V104	\$23.88	AC	84

Model No.	List Price	Code	Page Number(s)
VB20W	\$31.66	AQ	87
VB60W	\$45.96	AQ	87
VS63WH	\$68.00	AC	7
VS66WH	\$86.88	AC	7
VS67WH	\$125.72	AC	7
VS68WH	\$86.88	AC	7
VS69WH	\$125.72	AC	7
VT10W	\$698.68	AQ	87
VT1W	\$61.16	AQ	87
VT4W	\$84.98	AQ	87
VT5W	\$96.16	AQ	87
VT6W	\$57.12	AQ	87
VT7W	\$167.82	AQ	87
VT8W	\$271.96	AQ	87
VT9W	\$208.00	AQ	87
VX1000	\$1493.50	CX	13
VX1000C	\$1,493.50	CX	13
VX3916	\$18.52	XH	16
VX3918	\$74.42	XH	16
VX3918STD	\$18.98	XH	16
WC638	\$95.00	AC	6, 36, 38
WC650	\$20.78	AC	6
WVK2A	\$34.94	AC	6
XB110	\$301.50	HP	66
XB110H	\$404.48	HP	67
XB110HL	\$523.64	HP	67
XB110L	\$416.52	HP	66
XB50	\$264.80	HP	66
XB50L	\$373.90	HP	66
XB80	\$281.14	HP	66
XB80L	\$403.14	HP	66
XN110	\$301.50	HP	53
XN110H	\$404.48	HP	54
XN110HL	\$523.64	HP	54
XN110L	\$416.52	HP	53
XN50	\$264.80	HP	53
XN50L	\$373.90	HP	53
XN80	\$281.14	HP	53
XN80L	\$403.14	HP	53
ZB110	\$337.68	HP	66, 88
ZB110H	\$448.82	HP	67, 88
ZB110HL	\$570.70	HP	67, 88
ZB110L	\$454.76	HP	66, 88
ZB110M	\$383.74	HP	67, 88
ZB110ML	\$511.80	HP	67, 88
ZB80	\$308.94	HP	66, 88
ZB80L	\$423.68	HP	66, 88
ZB80M	\$356.76	HP	67, 88
ZB80ML	\$478.38	HP	67, 88
ZN110	\$337.68	HP	53, 89
ZN110H	\$448.82	HP	54, 89
ZN110HL	\$570.70	HP	54, 89
ZN110L	\$454.76	HP	53, 89
ZN110M	\$383.74	HP	54, 89
ZN110ML	\$511.80	HP	54, 89
ZN80	\$308.94	HP	53, 89
ZN80L	\$423.68	HP	53, 89
ZN80M	\$356.76	HP	54, 89
ZN80ML	\$478.38	HP	54, 89

Broan – NuTone Hood Replacement Parts

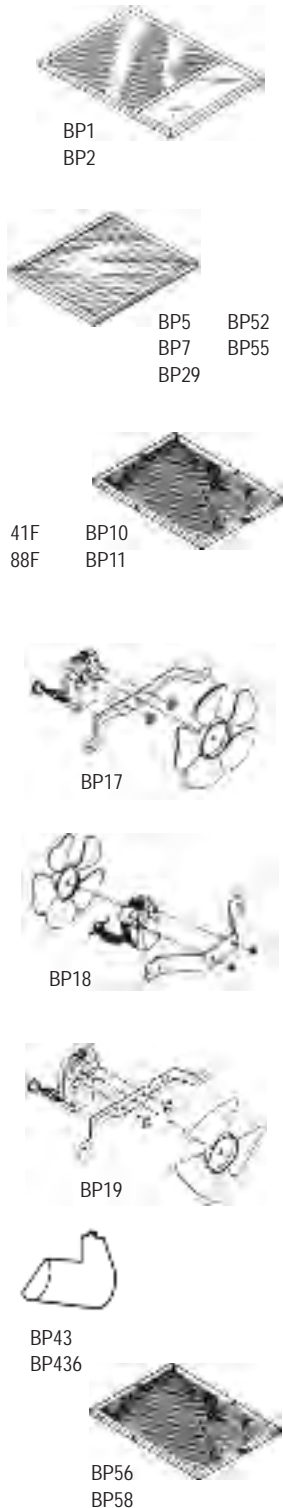

Model No.	Description	Std. Pk.	List Price	Code
BP1	Aluminum Filter with Light Lens (11-3/4" x 13-7/16")	15 *	\$17.14	AC
BP2	Aluminum Filter with Light Lens (10-1/8" x 16-9/16")	12 *	\$17.14	AC
BP4	Aluminum Filter (10-1/2" Diameter)	12 *	\$9.34	AC
BP5	Aluminum Filter (8-5/8" x 11")	4 *	\$9.44	AC
BP7	Aluminum Filter (10-3/8" x 11-3/8")	8 *	\$9.44	AC
BP10	Non-ducted Filter (8" x 9-1/2")	8 *	\$15.30	AC
BP11	Non-ducted Filter (8-5/8" x 10")	8 *	\$17.14	AC
BP17	Fan Assembly — Hood (40000 Series)	4 *	\$43.42	AC
BP18	Fan Assembly — Hood (42000 Series)	4 *	\$43.42	AC
BP19	Fan Assembly — Hood (41000 Series)	4 *	\$43.42	AC
BP29	Aluminum Filter (8-3/4" x 10-1/2")	6 *	\$9.34	AC
BP43	Light Lens — Hood (40000, 41000, 42000 and others) in display box	12 *	\$7.02	AC
BP436	Light Lens — Hood (40000, 41000, 42000 and others) in standard carton	6 *	\$7.02	AC
BP52	Motor/Blade (M2T, MK2T, M4T, V20, V25, V26 and V26N)	4 *	\$47.66	AC
BP55	Aluminum Filter (8" x 9-1/2")	8 *	\$9.34	AC
BP56	Non-ducted Filter (8" x 9-1/2")	8 *	\$17.14	AC
BP57	11-3/8" x 11-3/4" Washable Aluminum and Charcoal Filter with light lens. Master pack contains 8 filters. (SR610050 — Single Pack.)	8 *	\$16.50	AC
BP58	Replacement Charcoal Filter Pack. Each pack contains three 7-3/4" x 10-1/2" pads. Master pack contains 8 filter packs. (SR610051 — Single Pack)	8 *	\$11.58	AC
BP87	7" Damper for round discharge range hood. (S97010792 — Single Pack)	3 *	\$11.46	AC
BPAPFA	Replacement grease filters with antimicrobial protection (3 Pack/2 Filters per Pack)	3 *	\$51.62	AC
BPPF30	Non-duct Filters for QP130, QP230 and QP330	6 *	\$29.82	QA
BPPF36	Non-duct Filters for QP136, QP236 and QP336	3 *	\$32.24	QA
BPPF42	Non-duct Filter for QP142, QP242 and QP342	1	\$38.92	QA
BPPFA30	Replacement QP130 aluminum grease filters	3 *	\$53.70	QA
BPPFA36	Replacement QP136 aluminum grease filters	3 *	\$60.86	QA
BPPFA42	Replacement QP142 aluminum grease filter	1	\$68.18	QA
BPP2FA30	Replacement QP230 aluminum grease filter	1	\$56.82	QA
BPP2FA36	Replacement QP236 aluminum grease filter	1	\$68.18	QA
BPP2FA42	Replacement QP242 aluminum grease filter	1	\$85.26	QA
BPP3FA30	Replacement QP330 aluminum grease filter	1	\$71.60	QA
BPP3FA36	Replacement QP336 aluminum grease filter	1	\$82.96	QA
BPP3FA42	Replacement QP342 aluminum grease filter	1	\$100.00	QA
BQDE30	Aluminum replacement grease filters for QDE30 Series (3 Pack)	3 *	\$57.82	AC
BPQTAF	Aluminum Grease Filters (99010316 — Single Pack)	4 *	\$9.40	AC
BPQTF	Non-ducted Filters (99010317 — Single Pack)	4 *	\$11.80	AC
BPRPFA	Replacement grease filters (3 Pack/2 Filters per Pack) (S97017455 — Single Pack)	3 *	\$23.24	AC

- Item too large to ship via UPS/FedEx. Item shipped common carrier at minimum rates.
- * All pricing reflects the individual item cost. You must order in multiples as indicated.
- ◆ UL listed for use over bathtubs and showers when connected to a GFCI protected branch circuit.

Broan – NuTone Hood Replacement Parts CONTINUED

Model No.	Description	Std. Pk.	List Price	Code
BPS1FA30	Aluminum Replacement Range Hood Filters for use with 30" QS I and WS I Series Allure Hoods. Each pack contains 2 filters.	3 *	\$27.60	AC
BPS1FA36	Aluminum Replacement Range Hood Filters for use with 36" QS I and WS I Series Allure Hoods. Each pack contains 2 filters.	3 *	\$30.22	AC
BPS2FA30	Aluminum Replacement Range Hood Filters for use with 30" QS II and WS II Series Allure Hoods. Each pack contains 2 filters.	6 *	\$40.44	AC
BPS2FA36	Aluminum Replacement Range Hood Filters for use with 36" QS II and WS II Series Allure Hoods. Each pack contains 2 filters.	6 *	\$44.88	AC
BPS3FA30	Aluminum Replacement Range Hood Filters for use with 30" QS III and WS III Series Allure Hoods. Each pack contains 2 filters.	6 *	\$61.84	AC
BPS3FA36	Aluminum Replacement Range Hood Filters for use with 36" QS III and WS III Series Allure Hoods. Each pack contains 2 filters.	6 *	\$69.20	AC
BPSF30	Range Hood Filters for non-duct 30" QS and WS Series Allure Hoods. Each pack contains 2 filters.	4 *	\$31.52	AC
BPSF36	Range Hood Filters for non-duct 36" QS and WS Series Allure Hoods. Each pack contains 2 filters.	4 *	\$33.70	AC
BPSF42	Range Hood Filters for non-duct 42" QS and WS Series Allure Hoods. Each pack contains 2 filters.	8 *	\$36.22	AC
FILTERE56	Non-ducted Filter	1	\$57.56	AC
FILTEREB40	Replacement non-ducted charcoal filter for RMP17004 and RM50000	1	\$93.42	HA
FILTER SQUARE	Replacement non-ducted charcoal filter	1	\$59.44	HA
ROUND FILTER	Replacement non-ducted charcoal filter (for 613004 and 619004)	1	\$97.14	HA
41F	Replacement non-ducted filters for 11000, 41000, 46000, ACS, F40000, RL6200, RL6200FH, SL6200H and SM6500R	6 *	\$17.42	AC
88F	Replacement non-ducted filter for 88000, AP1 and RP2 Series. Master Pack contains 6 pairs of filters (S97007662 — Single Pack).	6 *	\$32.30	AC

● Item too large to ship via UPS/FedEx. Item shipped common carrier at minimum rates.

* All pricing reflects the individual item cost. You must order in multiples as indicated.

◆ UL listed for use over bathtubs and showers when connected to a GFCI protected branch circuit.

Accessories — Hood and Fan

Broan – NuTone Roof Caps

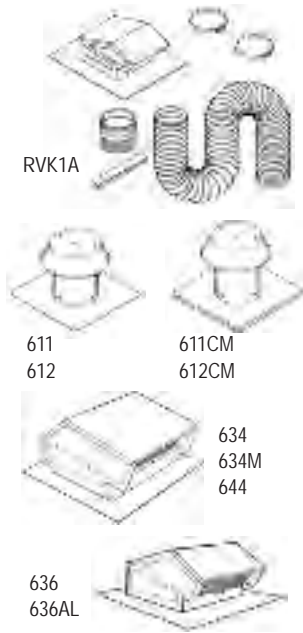

Model No.	Description	Std. Pk.	List Price	Code
437	High Capacity Roof Cap — up to 1200 CFM. Black.	1	\$192.06	AC
611	Aluminum Roof Cap for flat roofs. Up to 8" round duct. Natural finish.	1	\$90.64	AC
611CM	Aluminum Roof Cap for flat roofs. For curb mount installation. Up to 8" round duct. Natural finish.	1	\$120.12	AC
612	Aluminum Roof Cap for flat roofs. Up to 12" round duct. Natural finish.	1	\$155.42	AC
612CM	Aluminum Roof Cap for flat roofs. For curb mount installation. Up to 12" round duct. Natural finish.	1	\$169.90	AC
634	Steel Roof Cap for 3-1/4" x 10" or up to 8" round duct. Black.	1	\$51.74	AC
634M	Steel Roof Cap for 6" round duct. Includes damper and birdscreen. Black. (Not recommended for range hoods.)	1	\$60.34	AC
636	Steel Roof Cap for 3" or 4" round duct. Black.	1	\$29.62	AC
636AL	Same as Model 636 except aluminum. Natural finish.	1	\$38.36	AC
644	Same as Model 634 except aluminum. Natural finish.	1	\$66.92	AC
DC4	4" Duct Collar. For use with Models 636/636AL for easy attachment of 4" round duct.	6 *	\$7.52	AC
RVK1A	Roof Vent Kit, 8' of 4" flexible aluminum duct. Model 636 Roof Cap, 4" to 3" reducer, 4" dia. connector, (2) 4" dia. clamps.	1	\$71.72	AC

Broan – NuTone Transitions

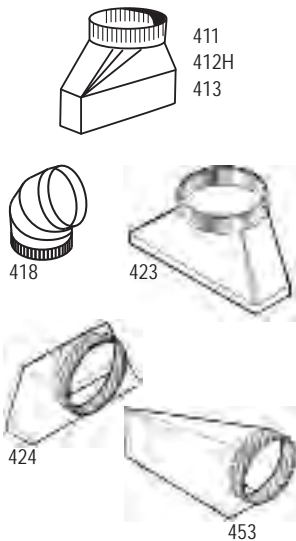

Model No.	Description	Std. Pk.	List Price	Code
411	3-1/4" x 10" to 6" Round Transition	1	\$28.00	AC
412H	3-1/4" x 10" to 7" Round Transition	1	\$30.14	AC
413	3-1/4" x 10" to 8" Round Transition	1	\$34.24	AC
414	8" to 10" Expander	1	\$50.98	AC
418	10" Adjustable Elbow	1	\$43.28	AC
423	Vertical Transition — 4-1/2" x 18-1/2" to 10" round	1	\$70.56	AC
424	Rear Transition — 4-1/2" x 18-1/2" to 10" round	1	\$87.86	AC
427	4-1/2" x 18-1/2" to 10" Round Transition (thin wall)	1	\$76.34	AC
453	■ Horizontal Left Transition — 4-1/2" x 18-1/2" to 10" round (right end boot)	1	\$103.26	AC
454	■ Horizontal Right Transition — 4-1/2" x 18-1/2" to 10" round (left end boot)	1	\$103.26	AC
459	■ 3-1/4" x 14" to 8" Round Transition	1	\$46.52	AC
475	6" to 4" duct reducer (Single pack)	1	\$10.40	AC
475B	6" to 4" duct reducer (6 pack)	6 *	\$7.64	AC
877	6" to 3-1/4" x 10"	1	\$32.14	AC
T457	7" to 5" duct reducer	1	\$26.00	AC
T460	Transition; 3-1/4" x 14" to 7" Round	1	\$34.90	AC
T461	Adapter, 3-1/4" x 14" to 3-1/4" x 10"	1	\$45.24	AC
T486	8" to 6" duct reducer	1	\$31.30	AC
T487	8" to 7" duct reducer	1	\$33.32	AC
T81212	Duct Transition — 8" x 12" to 12" rd. for 900 & 1500 CFM models	1	\$71.60	AC

■ Limited quantities available.

- Item too large to ship via UPS/FedEx. Item shipped common carrier at minimum rates.
- * All pricing reflects the individual item cost. You must order in multiples as indicated.
- ◆ UL listed for use over bathtubs and showers when connected to a GFCI protected branch circuit.

Accessories — Hood and Fan

Broan – NuTone Dampers

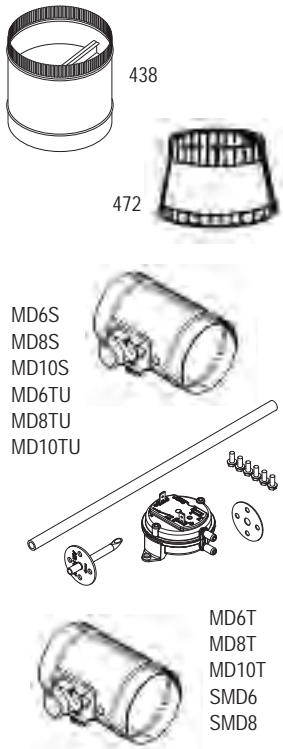

Model No.	Description	Std. Pk.	List Price	Code
97	7" Spring-loaded Damper	1	\$37.08	AC
421	10" Vertical discharge in-line damper	1	\$47.82	AC
438	8" Horizontal or vertical discharge in-line damper	1	\$41.22	AC
472	10" to 8" Reducer-damper, use with Model 504 (includes damper)	1	\$50.60	AC
804DD	■ 4" Diameter Galvanized Metal Duct Collar with Damper	1	\$17.20	AC
BP87	■ 7" Damper for round discharge range hood. (S97010792 — Single Pack)	3 *	\$11.46	AC
BP87Q	7" Damper for round discharge range hood. (S97018803 — Single Pack)	3 *	\$18.42	AC
MD6S	6" Make-up air slave damper (Damper Only)	1	\$171.86	HA
MD6T	6" Automatic make-up air damper	1	\$174.86	HA
MD6TU	6" Universal automatic make-up air damper with pressure sensor kit. Also works with ULTRA and QT Series fans if at least 80 CFM and used with 6" rigid duct.	1	\$244.00	HA
MD8S	8" Make-up air slave damper (Damper Only)	1	\$193.08	HA
MD8T	8" Automatic make-up air damper	1	\$188.30	HA
MD8TU	8" Universal automatic make-up air damper with pressure sensor kit	1	\$265.22	HA
MD10S	10" Make-up air slave damper (Damper Only)	1	\$297.06	HA
MD10T	10" Automatic make-up air damper	1	\$307.66	HA
MD10TU	10" Universal automatic make-up air damper with pressure sensor kit	1	\$350.10	HA
SMD6	6" LinkLogic automatic make-up air damper	1	\$281.36	HA
SMD8	8" LinkLogic automatic make-up air damper	1	\$296.16	HA

■ Limited quantities available.

Broan – NuTone Wall Caps

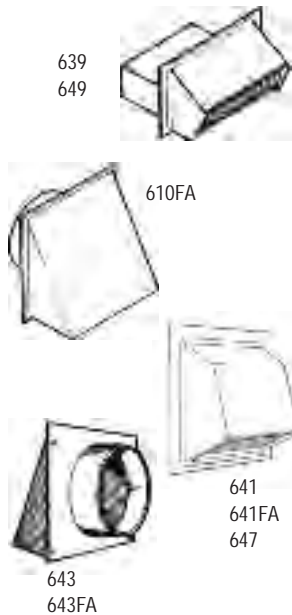

Model No.	Description	Std. Pk.	List Price	Code
441	Aluminum Wall Cap with gravity damper for 10" round duct	1	\$102.12	AC
610FA	10" Aluminum Fresh Air Inlet Wall Cap	1	\$135.80	AC
613	Aluminum Wall Cap for 12" round duct. Natural finish.	1	\$98.62	AC
639	Steel Wall Cap for 3-1/4" x 10" duct. Black.	1	\$34.86	AC
641	Aluminum Wall Cap for 6" round duct (includes damper and birdscreen). Natural finish.	1	\$71.04	AC
641FA	Aluminum Fresh Air Inlet Wall Cap for 6" round duct	1	\$57.22	AC
642	4" Round Aluminum Wall Cap	4 *	\$27.04	AC
643	Aluminum Wall Cap for 8" round duct. Natural finish.	1	\$89.52	AC
643FA	Aluminum Fresh Air Inlet Wall Cap for 8" round duct	1	\$84.10	AC
646	Plastic Louvered Wall Cap for 6" duct. White.	1	\$48.14	AC
647	Wall Cap. Same as Model 641 except for 7" round duct.	1	\$80.22	AC
649	Wall Cap. Same as Model 639 except aluminum. Natural finish.	1	\$45.08	AC
843BL	Wall Cap (black) for 6" round duct	1	\$54.50	AC
885AL	Wall Cap (aluminum) for 3" and 4" round duct	6 *	\$39.60	AC
885BL	Wall Cap (steel — black finish) for 3" and 4" round duct	6 *	\$31.28	AC
885NS	Wall Cap for 3" and 4" round duct (no birdscreen). Steel - black finish.	6 *	\$30.94	AC

● Item too large to ship via UPS/FedEx. Item shipped common carrier at minimum rates.

* All pricing reflects the individual item cost. You must order in multiples as indicated.

◆ UL listed for use over bathtubs and showers when connected to a GFCI protected branch circuit.

Accessories — Hood and Fan

Broan – NuTone Wall Caps CONTINUED

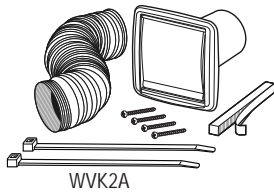

Model No.	Description	Std. Pk.	List Price	Code
BD4	Pressure Relief Damper with Wall Cap and 4" collar.	1	\$83.98	AQ
BD6	Pressure Relief Damper with Wall Cap and 6" collar.	1	\$83.98	AQ
WC638	Wall Cap — 3-1/4" x 14", Black.	1	\$95.00	AC
WC650	4" Wall Cap for 4" round duct. Includes 4" diameter metal duct connector and four mounting screws.	4 *	\$20.78	AC
WVK2A	Wall Ducting Kit — 5' of 4" diameter flexible foil duct, white wall cap for 4" round duct, 3" to 4" duct adapter, 2 nylon zip ties and mounting screws.	1	\$34.94	AC

Broan – NuTone 24" Duct Sections

Prices shown are for one complete 2' section.

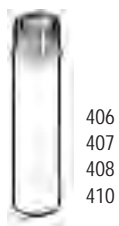

Model No.	Description	Std. Pk.	List Price	Code
406	6" Round Duct	5 *	\$23.10	AC
407	7" Round Duct	5 *	\$23.84	AC
408	8" Round Duct	1	\$26.00	AC
410	10" Round Duct	5 *	\$30.78	AC
804DU	4" Insulated Flexible Duct (25 ft.)	1	\$71.62	AC
889	3-1/4" x 10" Duct (5 Pieces)	5 *	\$29.32	AC
DT6W	6" Insulated Duct (25 ft.)	1	\$100.32	AC

Broan – NuTone Elbows

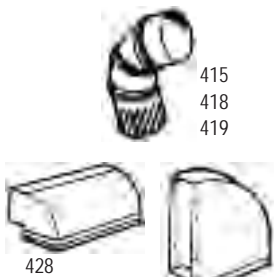

Model No.	Description	Std. Pk.	List Price	Code
415	7" Adjustable Elbow	4 *	\$17.90	AC
418	10" Adjustable Elbow	1	\$43.28	AC
419	6" Adjustable Elbow	1	\$18.92	AC
428	3-1/4" x 10" Vertical Elbow	1	\$35.64	AC
429	3-1/4" x 10" Horizontal Elbow	1	\$47.82	AC
430	Short Eave Elbow for 3-1/4" x 10" duct with backdraft damper and grille	1	\$62.18	AC
431	Long Eave Elbow for 3-1/4" x 10" duct with backdraft damper and grille	1	\$62.40	AC
432	8" Round Elbow	1	\$31.30	AC

Broan – NuTone Hanger Bars

Model No.	Description	Std. Pk.	List Price	Code
QTHB1	One set of hanger bars for QTR Series	1	\$18.70	AC

- Item too large to ship via UPS/FedEx. Item shipped common carrier at minimum rates.
- * All pricing reflects the individual item cost. You must order in multiples as indicated.
- ◆ UL listed for use over bathtubs and showers when connected to a GFCI protected branch circuit.

Accessories — Decorator Wall Mounted Controls

Broan® Decorator Wall Mounted Controls

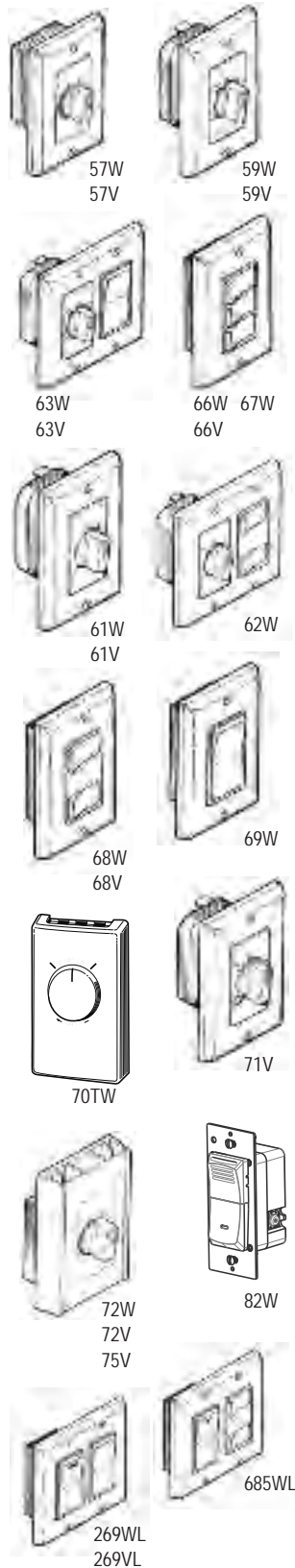

Model No.	Description	Std. Pk.	List Price	Code
57V / 57W	Electronic Variable Speed Control, 3 amp capacity. 120V. Fits single gang box.	1	\$46.64	AC
59V / 59W	60 Minute Time Control, with "continuous on" feature. Fits single gang box.	1	\$60.34	AC
61V / 61W	15 Minute Time Control, no "continuous on" feature. Fits single gang box.	1	\$60.34	AC
62W	60 Minute Time Control with two rocker switches. Fits two-gang box.	1	\$89.52	AC
63V / 63W	60 Minute Time Control with one rocker switch. Fits two-gang box.	1	\$79.94	AC
64V / 64W	Fan/Light Control with off delay. Requires hot and neutral wires in switch box. Fits single gang box.	1	\$115.84	AC
66V / 66W	Three-Function Control. Fits single gang opening.	1	\$38.22	AC
67W	Three-Function Control with polished chrome finish metal wall plate. Fits single gang opening.	1	\$41.40	AC
68V / 68W	Two-Function Control. Fits single gang box.	1	\$31.04	AC
69W	Single Gang Control. One smooth action on/off rocker switch. Fits single gang box.	1	\$12.84	AC
70TW	Fan Thermostat, 22 amp capacity; 120, 250 and 277 VAC	1	\$66.14	AC
71V	12 hour timer automatically turns the ventilator off at a time selected within a 12 hour period. Ivory.	1	\$63.56	AC
72V / 72W	Electronic Variable Speed Control, 6 amp capacity. 120V. Fits single gang box. Suitable for use with 331H, 332H, 335, 336, HLB3, HLB6, HLB9 and HLB11.	1	\$84.92	AC
75V	Electronic Variable Speed Control. Same as 72W/V, except 240V.	1	\$86.52	AC
82W	Premium Humidity Control with Sensaire technology that senses rapid rise in humidity. Also includes duty cycle timer. Fits in single gang box. (White)	1	\$101.30	AC
90	Thermostat Kit. Used to install built-in thermostat in Model 114 kickspace heater. Snap action, bi-metallic, effective temperature range of 40 – 130° F.	1	\$57.84	AC
277V	Electronic Variable Speed Control, 277V, 6A — Ivory. For models with "C" suffix.	1	\$91.60	AC
77DV / 77DW	Three-Function Control for use with sensing Fan/Lights (top switch provides three settings for sensor On/Auto/Off), remaining switches control light, night light and QT Heater/Fan/Light/Night Light (top switch controls light and night light, remaining switches control fan and heater).	1	\$44.60	AC
269VL / 269WL	Two-Function, Two-Gang Control. Two separate smooth action on/off rocker switches — one with pilot light which glows when power is on.	1	\$47.28	AC
685WL	Three-Function, Two-Gang Control. One smooth action on/off rocker switch with pilot light which glows when power is on — one two-function control with separate on/off switches.	1	\$68.16	AC
CFT12WH	12-Hour Timer (White)	1	\$69.40	AC
VS63WH	15 Min. Timer Switch (White)	1	\$68.00	AC
VS66WH	60 Min. Timer/1 On/Off Switch (White)	1	\$86.88	AC
VS67WH	60 Min. Timer/2 On/Off Switches (White)	1	\$125.72	AC
VS68WH	15 Min. Timer/1 On/Off Switch (White)	1	\$86.88	AC
VS69WH	15 Min. Timer/2 On/Off Switches (White)	1	\$125.72	AC
S990712044	Function Labels for two-, three- and four-function wall decorator controls. Easily applied peel-off labels cover HEAT/VENT/LIGHT/NIGHT LIGHT ON/OFF/AUTO functions.	1	\$0.64	PT

W = WHITE decorator style; V = IVORY decorator style.

- Item too large to ship via UPS/FedEx. Item shipped common carrier at minimum rates.
- * All pricing reflects the individual item cost. You must order in multiples as indicated.
- ◆ UL listed for use over bathtubs and showers when connected to a GFCI protected branch circuit.

Accessories — Decorator Wall Mounted Controls

Broan® Decorator Wall Controls / “Blister Packs”

Packaged in see-through “blister packs” for pegboard mounting. Ideal for displays in showrooms to help stimulate sales.



P57W



P59W
P59V

Model No.	Description	Std. Pk.	List Price	Code
P57W	Electronic Variable Speed Control, 3 amp capacity. Fits single gang box.	4 *	\$48.72	AC
P59V / P59W	60 Minute Time Control with “continuous on” feature. Fits single gang box.	4 *	\$78.12	AC
P66V / P66W	Three-Function Control. Fits single gang opening.	4 *	\$40.70	AC
P68W	Two-Function Control. Fits single gang box.	4 *	\$33.48	AC
P685WL	Two-Gang Control. One smooth action on/off rocker switch with pilot light which glows when power is on — one two-function control with separate on/off switches. Fits two-gang box.	4 *	\$71.24	AC

W = WHITE decorator style; V = IVORY decorator style.

Attic Ventilators — Powered

Broan® 28W Solar Powered Attic Ventilators

Remove heat from the attic in summer, help prevent moisture and ice dams in the winter without using any electricity! Energy saving solar powered attic ventilators also reduce energy costs by reducing running time of air conditioners. Easy retrofit can easily replace standard powered attic ventilators.

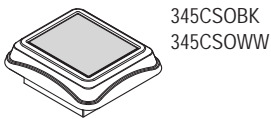

345CSOBK
345CSOWW



345GOBK
345GOWW

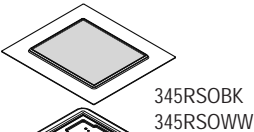

345RSOBK
345RSOWW

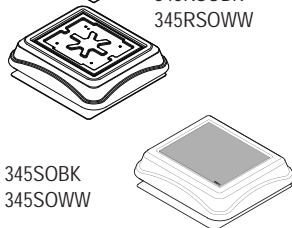

345SOBK
345SOWW

Model No.	Description	Std. Pk.	List Price	Code
345CSOBK	Solar PAV, curb mount, black	1	\$562.28	SO
345CSOWW	Solar PAV, curb mount, weathered wood	1	\$562.28	SO
345GOBK	Solar PAV, gable mount, black	1	\$562.28	SO
345GOWW	Solar PAV, gable mount, weathered wood	1	\$562.28	SO
345RSOBK	Solar PAV, remote mount, black	1	\$598.34	SO
345RSOWW	Solar PAV, remote mount, weathered wood	1	\$598.34	SO
345SOBK	Solar PAV, surface mount, black	1	\$562.28	SO
345SOWW	Solar PAV, surface mount, weathered wood	1	\$562.28	SO
CWT45	Thermostat for Solar PAVs	1	\$42.44	SO

Broan® Roof Mount Powered Attic Ventilators

High performance 14" wing blade. Thermally protected motor. Includes wiring box with a built-in adjustable thermostat. Easy to install.



Model No.	Description	Std. Pk.	List Price	Code
349BR	1000 CFM, Brown Powder-Coated Steel Dome	1	\$257.54	HV
350BK	1050 CFM Attic Ventilator with black PVC dome	1	\$222.86	HV
350BR	1050 CFM Attic Ventilator with brown PVC dome	1	\$229.14	HV
355BK	1000 CFM Attic Ventilator with black PVC dome	1	\$236.16	HV
355BR	1000 CFM Attic Ventilator with brown PVC dome	1	\$242.44	HV
356BK	1600 CFM Attic Ventilator with black PVC dome	1	\$307.68	HV
356BR	1600 CFM Attic Ventilator with brown PVC dome	1	\$313.98	HV
358	1000 CFM Attic Ventilator with aluminum dome	1	\$273.48	HV

- Item too large to ship via UPS/FedEx. Item shipped common carrier at minimum rates.
- * All pricing reflects the individual item cost. You must order in multiples as indicated.
- ◆ UL listed for use over bathtubs and showers when connected to a GFCI protected branch circuit.

Attic Ventilators — Powered

Broan® Gable Mount Powered Attic Ventilator



Outstanding performance from an inside-the-attic gable mounted unit. Designed to discharge hot attic air through existing 14" x 14" minimum or comparable louver in gable wall. High performance 14" wing blade. Thermally protected motor. Includes wiring box with a built-in adjustable thermostat. Easy to install.

Model No.	Description	Std. Pk.	List Price	Code
353	1020 CFM Gable Mount Ventilator (use with Broan Model 433 shutter — Sold separately, see below)	1	\$152.26	HV
35316	1600 CFM Gable Mount Ventilator (use with Broan Model 433 shutter — Sold separately, see below)	1	\$230.24	HV

Broan® Automatic Shutter for Gable Mount Attic Ventilators



Precision built automatic wall shutter. Designed to be used with Broan Models 353 and 35316 Gable Mount Powered Attic Ventilators or Broan Models 345GOBK and 345GOWW Gable Mount Solar Powered Attic Ventilators. Aluminum vanes automatically open when ventilator turns on and are counter-balanced for easy opening; close when air flow ceases. Steel reinforced for strength, weather-tight closure. Easy to install.

Model No.	Description	Std. Pk.	List Price	Code
433	Automatic Shutter	1	\$82.22	AC

Broan® Powered Attic Ventilator Accessories

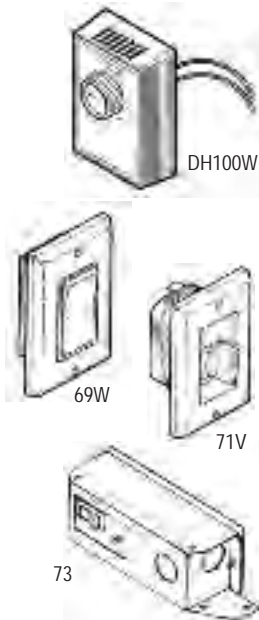

Model No.	Description	Std. Pk.	List Price	Code
DH100W	Dehumidistat, 24V/120V. (For use with all Broan powered attic ventilators — sold separately.)	1	\$47.54	AC
69W	Single Gang Control. One smooth action on/off rocker switch. Fits single gang box.	1	\$12.84	AC
71V	12 hour timer automatically turns the ventilator off at a time selected within a 12 hour period. Ivory.	1	\$63.56	AC
73	High temperature cut-off control automatically shuts off the PAV in the event of a high temperature condition (above 204° F.) Also includes a safety on/off switch to prevent fan from starting when cleaning or servicing.	1	\$44.84	AC

Broan® Powered Attic Ventilator Replacement Accessories

Model No.	Description	Std. Pk.	List Price	Code
RFTH95	Automatic, adjustable thermostat replacement part for NuTone powered attic ventilators.	1	\$22.30	AC

- Item too large to ship via UPS/FedEx. Item shipped common carrier at minimum rates.
- * All pricing reflects the individual item cost. You must order in multiples as indicated.
- ◆ UL listed for use over bathtubs and showers when connected to a GFCI protected branch circuit.

Ceiling Fans

NuTone® Standard Series Ceiling Fans — For Indoor Use Only

Accepts all NuTone light kits. Includes 4" and 6" downrods — additional lengths sold separately. ENERGY STAR certified with 30 year limited warranty. Pull chain operation. Wall and remote control sold separately.

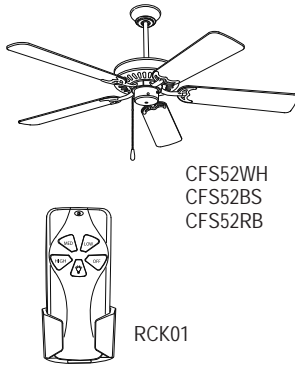

Model No.	Description	Std. Pk.	List Price	Code
CFS52WH	■ 52" Ceiling Fan — Standard Series, White. Dual Finish Blades; Polished White/White Oak.	1	\$133.70	PF
CFS52BS	■ 52" Ceiling Fan — Standard Series, Brushed Steel. Dual Finish Blades; Dark Cherry/Light Oak.	1	\$138.20	PF
CFS52RB	■ 52" Ceiling Fan — Standard Series, Oil Rubbed Bronze. Dual Finish Blades; Dark Cherry/Medium Cherry.	1	\$139.96	PF
RCK01	■ Hand Held Remote Control Transmitter and Receiver. Works with Standard Series only.	1	\$52.96	PA

■ Limited quantities available.



All models are ENERGY STAR certified products.

NuTone® Hugger Series Ceiling Fans — For Indoor Use Only

Accepts NuTone light kits. Designed to mount flush with ceiling; only 7" between ceiling and blades. Pull chain operation. Wall control sold separately.

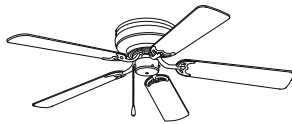

Model No.	Description	Std. Pk.	List Price	Code
CFH52WH	■ 52" Ceiling Fan — Hugger Series, White. Dual Finish Blades; Polished White/White Oak.	1	\$167.14	PF
CFH52BS	■ 52" Ceiling Fan — Hugger Series, Brushed Steel. Dual Finish Blades; Dark Cherry/Light Oak.	1	\$173.78	PF
CFH52RB	■ 52" Ceiling Fan — Hugger Series, Oil Rubbed Bronze. Dual Finish Blades; Dark Cherry/Medium Cherry.	1	\$173.78	PF

■ Limited quantities available.

NuTone® Outdoor Series Ceiling Fans

Wet rated for outdoor use. Accepts NuTone light kits damp rated for outside use. Includes 4" and 6" downrods. Additional lengths sold separately. ENERGY STAR certified with 30 year limited warranty. Pull chain operation. Wall control sold separately.

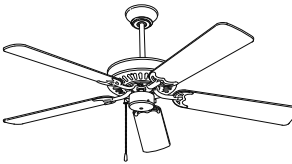

Model No.	Description	Std. Pk.	List Price	Code
CFO52WH	■ 52" Ceiling Fan — Outdoor Wet Rated, White. Dual Finish, All Weather Blades; Polished White/White Oak.	1	\$196.40	PF
CFO52BQ	■ 52" Ceiling Fan — Outdoor Wet Rated, Barbeque Black. Single Finish, All Weather Blades; Dark Ash.	1	\$207.42	PF
CFO52WB	■ 52" Ceiling Fan — Outdoor Wet Rated, Weathered Bronze. Dual Finish, All Weather Blades; Light Oak/Dark Cherry.	1	\$189.76	PF

■ Limited quantities available.



All models are ENERGY STAR certified products.

- Item too large to ship via UPS/FedEx. Item shipped common carrier at minimum rates.
- * All pricing reflects the individual item cost. You must order in multiples as indicated.
- ◆ UL listed for use over bathtubs and showers when connected to a GFCI protected branch circuit.

Ceiling Fans

NuTone® Commercial Series Ceiling Fans

Engineered to withstand harsh warehouse applications. Designed for year-round energy efficiency. In winter, fans help lower costs by recirculating trapped heat at the ceiling. In summer, specially designed contoured blades provide maximum air flow for improved comfort.

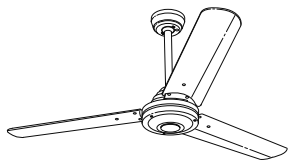

Model No.	Description	Std. Pk.	List Price	Code
CFC56WH	■ 56" Commercial Ceiling Fan — White. Single Finish Commercial Grade Contoured White Blades.	1	\$194.20	PF
CFC56BR	■ 56" Commercial Ceiling Fan — Brown. Single Finish Commercial Grade Contoured Brown Blades.	1	\$194.20	PF

■ Limited quantities available.

NuTone® Light Kits

For the greatest energy savings, 13W CFL bulbs are included. Each NuTone light kit also accepts 40W incandescent bulbs (sold separately).



LK20FWWH
LK20FWBS
LK20ASRB

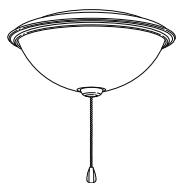

LK30AWH
LK30ABS
LK30ARB

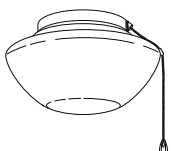

LK50DWH
LK50DWB
LK50DBQ

FOR OUTDOOR USE

Model No.	Description	Std. Pk.	List Price	Code
LK20FWWH	■ Light Kit, Traditional Bowl, Frosted White Glass, White Trim, (2) 13W CFL bulbs included	1	\$92.68	PA
LK20FWBS	■ Light Kit, Traditional Bowl, Frosted White Glass, Brushed Steel Trim, (2) 13W CFL bulbs included	1	\$93.44	PA
LK20ASRB	■ Light Kit, Traditional Bowl, Amber Scavo Glass, Oil-Rubbed Bronze Trim, (2) 13W CFL bulbs included	1	\$92.12	PA
LK30AWH	■ Light Kit, Contemporary Bowl, Alabaster Glass, White Trim, (2) 13W CFL bulbs included	1	\$92.68	PA
LK30ABS	■ Light Kit, Contemporary Bowl, Alabaster Glass, Brushed Steel Trim, (2) 13W CFL bulbs included	1	\$93.44	PA
LK30ARB	■ Light Kit, Contemporary Bowl, Alabaster Glass, Oil-Rubbed Bronze Trim, (2) 13W CFL bulbs included	1	\$94.32	PA
LK50DWH	■ Light Kit, Outdoor, Damp-Rated, White Trim, (1) 13W CFL bulb included	1	\$61.78	PA
LK50DWB	■ Light Kit, Outdoor, Damp-Rated, Weathered Bronze Trim, (1) 13W CFL bulb included	1	\$61.78	PA
LK50DBQ	■ Light Kit, Outdoor, Damp-Rated, BBQ Black Trim, (1) 13W CFL bulb included	1	\$61.78	PA

■ Limited quantities available.

NuTone® Turtle Fitters and Glass

Four arm fitters let you personalize your fan with your choice of 2-1/4" decorative glass. For the greatest energy savings, 13W CFL bulbs are included. Each NuTone fitter also accepts 40W medium base candelabra bulbs (sold separately).

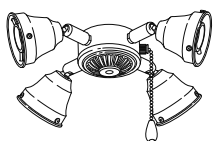

TF40WH
TF40BS
TF40RB

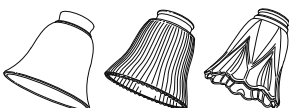

TF40GAP TF40GFW TF40GCL

Model No.	Description	Std. Pk.	List Price	Code
TF40WH	■ Turtle Fitter, White. Includes (4) 13W Compact Fluorescent Bulbs.	1	\$62.34	PA
TF40BS	■ Turtle Fitter, Brushed Steel. Includes (4) 13W Compact Fluorescent Bulbs.	1	\$63.44	PA
TF40RB	■ Turtle Fitter, Oil Rubbed Bronze. Includes (4) 13W Compact Fluorescent Bulbs.	1	\$63.44	PA
TF40GAP	■ Glass for Turtle Fitter, Amber Parchment (Set of 4)	1	\$76.68	PA
TF40GFW	■ Glass for Turtle Fitter, Frosted White (Set of 4)	1	\$62.90	PA
TF40GCL	■ Glass for Turtle Fitter, Clear Cut Glass (Set of 4)	1	\$61.24	PA

■ Limited quantities available.

- Item too large to ship via UPS/FedEx. Item shipped common carrier at minimum rates.
- * All pricing reflects the individual item cost. You must order in multiples as indicated.
- ◆ UL listed for use over bathtubs and showers when connected to a GFCI protected branch circuit.

NuTone® Slope Adapters

Model No.	Description	Std. Pk.	List Price	Code
CFSABR ■	Brown	1	\$15.32	PA
CFSABS ■	Brushed Steel	1	\$15.76	PA
CFSARB ■	Oil-Rubbed Bronze	1	\$16.64	PA
CFSAWH ■	White	1	\$15.32	PA

■ Limited quantities available.

NuTone® Downrods

NuTone ceiling fans include both a 4" and 6" downrod*. Choose from an assortment of 12" to 48" lengths, all 13/16" diameter.

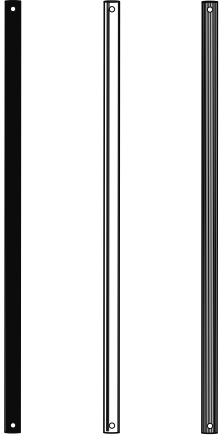

Model No.	Description	Std. Pk.	List Price	Code
DR12WH ■	12" Downrod, White	1	\$9.04	PA
DR18WH ■	18" Downrod, White	1	\$11.04	PA
DR24WH ■	24" Downrod, White	1	\$14.24	PA
DR36WH ■	36" Downrod, White	1	\$19.10	PA
DR48WH ■	48" Downrod, White	1	\$26.36	PA
DR36BS ■	36" Downrod, Brushed Steel	1	\$32.54	PA
DR48BS ■	48" Downrod, Brushed Steel	1	\$39.16	PA
DR12RB ■	12" Downrod, Oil-Rubbed Bronze	1	\$15.66	PA
DR18RB ■	18" Downrod, Oil-Rubbed Bronze	1	\$21.74	PA
DR24RB ■	24" Downrod, Oil-Rubbed Bronze	1	\$24.82	PA
DR36RB ■	36" Downrod, Oil-Rubbed Bronze	1	\$32.54	PA
DR48RB ■	48" Downrod, Oil-Rubbed Bronze	1	\$39.16	PA
DR24BR ■	24" Downrod, Brown	1	\$24.82	PA
DR36BR ■	36" Downrod, Brown	1	\$32.54	PA
DR48BR ■	48" Downrod, Brown	1	\$39.62	PA
DR12OWH ■	12" Downrod, Outdoor White	1	\$15.66	PA
DR12OBQ ■	12" Downrod, Outdoor Barbeque Black	1	\$15.66	PA
DR18OBQ ■	18" Downrod, Outdoor Barbeque Black	1	\$21.74	PA
DR24OBQ ■	24" Downrod, Outdoor Barbeque Black	1	\$24.82	PA
DR36OBQ ■	36" Downrod, Outdoor Barbeque Black	1	\$32.54	PA
DR12OWB ■	12" Downrod, Outdoor Weathered Bronze	1	\$15.66	PA
DR18OWB ■	18" Downrod, Outdoor Weathered Bronze	1	\$21.86	PA
DR24OWB ■	24" Downrod, Outdoor Weathered Bronze	1	\$24.82	PA
DR36OWB ■	36" Downrod, Outdoor Weathered Bronze	1	\$32.54	PA

* Excludes Hugger Series. Commercial fan contains 6" downrod only.

■ Limited quantities available.

- Item too large to ship via UPS/FedEx. Item shipped common carrier at minimum rates.
- * All pricing reflects the individual item cost. You must order in multiples as indicated.
- ◆ UL listed for use over bathtubs and showers when connected to a GFCI protected branch circuit.

Ceiling Fans

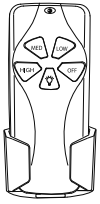

RCK01

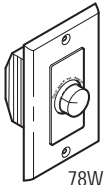

78W
78V

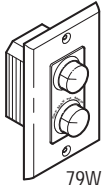

79W
79V

W = WHITE decorator style
V = IVORY decorator style

NuTone® Controls

Each NuTone fan is designed to operate with a pull chain. For added convenience, choose from our assortment of remote and wall controls*.

Model No.	Description	Std. Pk.	List Price	Code
RCK01 ■	Hand Held Remote Control Transmitter and Receiver	1	\$52.96	PA
78V / 78W ■	Four-Speed Control, 1.5 amps	1	\$49.76	PA
79V / 79W ■	Four-Speed Fan/Hi-Off-Low Light Control. For 1.5 amp Fan, 300 Watt Incandescent Light.	1	\$70.42	PA

* Commercial series does not contain pull chain and must be operated with a wall control. Remote control available for standard series only.

■ Limited quantities available.

Central Vacuum Systems

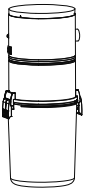

PP500

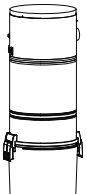

PP600



PP650

NuTone® PurePower Series Power Units

Model No.	Description	Std. Pk.	List Price	Code
PP500	NuTone PurePower 500 AW Power Unit	1	\$638.60	CX
PP600	NuTone PurePower 600 AW Power Unit	1	\$870.36	CX
PP650	NuTone PurePower 650 AW Power Unit	1	\$1,158.76	CX



NuTone® Power Units — VX Series

Model No.	Description	Std. Pk.	List Price	Code
VX1000	Power Unit — Two, Two-Stage Universal Bypass Motors, Bag Filtration	1	\$1,493.50	CX
VX1000C	Power Unit — Two, Two-Stage Universal Bypass Motors, Cyclonic	1	\$1,493.50	CX

- Item too large to ship via UPS/FedEx. Item shipped common carrier at minimum rates.
- * All pricing reflects the individual item cost. You must order in multiples as indicated.
- ◆ UL listed for use over bathtubs and showers when connected to a GFCI protected branch circuit.

Central Vacuum Systems

NuTone® Tools, Hoses, Inlets, Tubing and Fittings

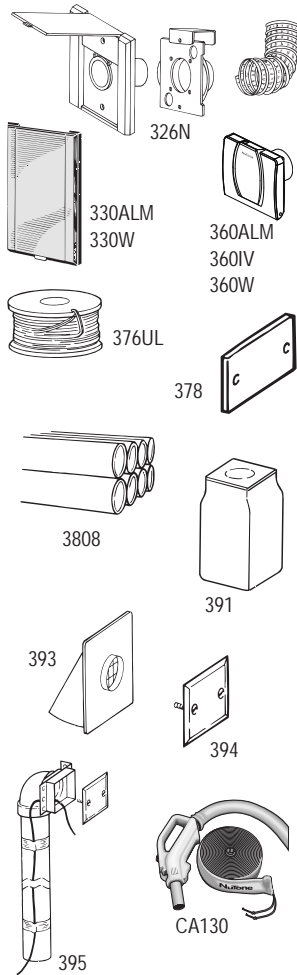

Model No.	Description	Std. Pk.	List Price	Code
326N	Existing Home Inlet Kit	1	\$68.50	CA
330ALM	Standard Inlet — Almond	1	\$8.76	CA
330W	Wall Inlet — White	1	\$8.76	CA
360ALM	Automatic Wall Inlet — Almond	1	\$20.60	CA
360IV	■ Wall Inlet — Ivory	1	\$20.60	CA
360W	Wall Inlet — White	1	\$20.60	CA
372	Standard Hose — 32' wire-reinforced vinyl	1	\$114.34	CA
376UL	Wire — 100' 18/2, UL approved	1	\$73.64	CA
378	Nail Plate	1	\$4.12	CA
3808	● 8' PVC Tubing	8 *	\$9.78	CA
3808B	● 8' PVC Tubing	440 *	\$9.78	CA
3810	10' PVC Tubing	10 *	\$11.84	CA
391	Bags — pack of three (3)	1	\$11.84	CA
392	Muffler	1	\$28.84	CA
393	Metal Wall Cap	1	\$31.94	CA
394	Blank Cover Plate — White	1	\$20.08	CA
395	Inlet Rough-In Assembly Package — for new construction	1	\$85.50	CA
3964	Three-Inlet Installation Rough-In Package	1	\$111.76	CA
CA130	Hose Sock — fits 30' - 32' hoses (comes with assembly tube)	1	\$61.80	CA
CF328	Plaster Guard — for use with Model CF329 mounting plate	1	\$2.58	CA
CF329	Inlet Mounting Plate	1	\$6.18	CA
CF361	Mounting Bracket with Plastic Guard	1	\$14.42	CA
CF361F	Mount Plate w/Flanged Spigot — for any CF382 Series elbow	1	\$20.08	CA
CF362	Flanged Ell — 90°	1	\$3.10	CA
CF363	Flanged Ell, 90° — Special for 3" walls	1	\$4.64	CA
CF364	Flanged Tee	1	\$4.64	CA
CF365	Double Flanged Tee	1	\$4.64	CA

■ Limited quantities available.

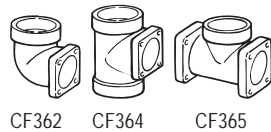
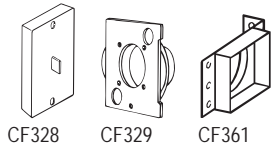

- Item too large to ship via UPS/FedEx. Item shipped common carrier at minimum rates.
- * All pricing reflects the individual item cost. You must order in multiples as indicated.
- ◆ UL listed for use over bathtubs and showers when connected to a GFCI protected branch circuit.

Central Vacuum Systems

NuTone® Tools, Hoses, Inlets, Tubing and Fittings CONTINUED

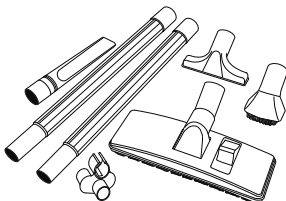
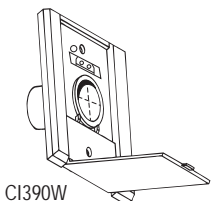
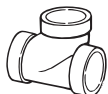
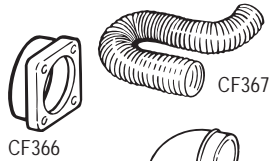

Model No.	Description	Std. Pk.	List Price	Code
CF366	Straight Flange	1	\$2.58	CA
CF367	Flexible Tubing — 36" Length	6 *	\$13.90	CA
CF368	90° Street Ell	1	\$1.76	CA
CF369	45° Street Ell	1	\$1.76	CA
CF372	Utility Inlet — White	1	\$6.18	CA
CF377	90° Sweep Ell — Long	1	\$1.76	CA
CF380	Pipe Support with Wire Clip	1	\$1.04	CA
CF382	90° Sweep Ell	1	\$1.64	CA
CF382S	90° Short Ell — for use with Model CF329 only	1	\$1.64	CA
CF382XS	90° Short Socket Ell for VacPan™	1	\$2.58	CA
CF383	90° Tee	1	\$2.26	CA
CF384	Three-Way Ell	1	\$3.60	CA
CF385	45° Ell	1	\$1.54	CA
CF386	30° Ell	1	\$2.06	CA
CF387	45° Wye	1	\$3.10	CA
CF388	Stop Coupling	1	\$1.04	CA
CF389	End Cap	1	\$2.06	CA
CF3918	Filter Bags — Set of 3, 8 gallon capacity	1	\$19.58	CA
CH230L	High Performance Hose — 42' wire-reinforced vinyl with ON/OFF Switch	1	\$184.88	CA
CH235	Low Voltage Crushproof Hose — 30' features swivel handle	1	\$149.86	CA
CH515	Current-Carrying Crushproof Hose — 30'	1	\$353.80	CA
CH615	Current-Carrying Hose — 30', compatible with CI358, CI390 and CI395 Series Electrified Inlets	1	\$353.80	CA
CI319	Face Plate Extension	1	\$2.06	CA
CI324	Hose Clamp — 2"	10 *	\$2.06	CA
CI330	Exhaust Vent	1	\$6.18	CA
CI3301RK	Rough-In Kit for one inlet add-on. Use with 330 and CI335 Series Inlets.	1	\$88.06	CA
CI3303RK	Rough-In Kit for three inlet installations. Use with 330 and CI335 Series Inlets.	1	\$120.52	CA
CI358W	Direct Connect Wall Valve (Electrified) — White	10 *	\$23.70	CA
CI365W	VacPan™ Automatic Dustpan Inlet — White	1	\$82.40	CA
CI366W	QuickTrim Finish Trim Plate. White. For use with CI-365W.	1	\$7.22	CA
CI367IV	■ VacuSweep Auto Dust Pan — Ivory	1	\$72.10	CA
CI367W	VacuSweep Auto Dust Pan — White	1	\$72.10	CA
CI390W	Electrified Inlet — White, 12AWG, 6' Cord. Use CH620 and CH615 hoses.	1	\$10.30	CA
CI395RK	Rough-In Kit for CI390 and CI395 Electrified Inlets	1	\$29.88	CA
CI399ALM	ElectraValve® Electrified Inlet — Almond	1	\$10.30	CA
CI399EB	E-Box Only for ElectraValve® Electrified Inlet	1	\$21.26	CA
CI399RK	Electrified Inlet Rough-In Kit	1	\$29.88	CA
CI399W	ElectraValve® Electrified Inlet — White	1	\$10.30	CA
CK110	■ Basic Tool Set	1	\$52.36	CA

■ Limited quantities available.

- Item too large to ship via UPS/FedEx. Item shipped common carrier at minimum rates.
- * All pricing reflects the individual item cost. You must order in multiples as indicated.
- ◆ UL listed for use over bathtubs and showers when connected to a GFCI protected branch circuit.

NuTone® Tools, Hoses, Inlets, Tubing and Fittings CONTINUED

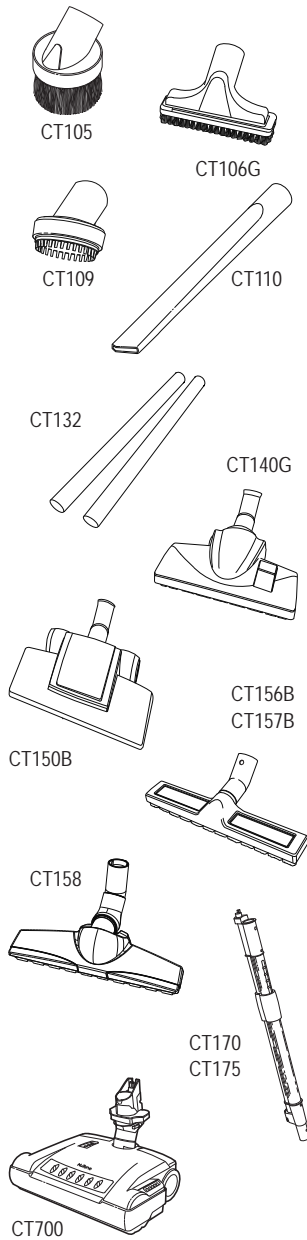

Model No.	Description	Std. Pk.	List Price	Code
CK135	Ratcheting Wand	1	\$27.82	CA
CS100	Car care attachment set	1	\$128.76	CA
CS200	Carpet & bare floor combination attachment set	1	\$138.02	CA
CS300	Bare floor attachment set	1	\$396.56	CA
CS400	Carpet & bare floor combination air turbine pet care attachment set	1	\$473.80	CA
CS500	Carpet & bare floor combination electric pigtail attachment set	1	\$854.90	CA
CS600	Carpet & bare floor combination electric direct connect attachment set	1	\$854.90	CA
CT105	Natural hair dusting brush	1	\$4.64	CA
CT106G	Upholstery Tool with Removable Brush. Natural Hair Bristles.	1	\$6.70	CA
CT109	Pet brush	1	\$3.60	CA
CT110	Long crevice tool	1	\$3.60	CA
CT132	Chrome Wands — set of two	1	\$26.26	CA
CT140G	Standard Combination Floor/Rug Tool	1	\$28.84	CA
CT143B	Universal Dusting Brush (elongated)	1	\$17.00	CA
CT150B	Deluxe Combination Floor/Rug Tool	1	\$24.20	CA
CT156B	Hardwood Floor Tool with Natural Hair Brush	1	\$26.26	CA
CT157B	Extra Wide Hardwood Floor Tool with Natural Hair Brush	1	\$37.08	CA
CT158	Premium twist and turn floor brush	1	\$43.26	CA
CT170	Adjustable wand for 20 Series hoses	1	\$54.08	CA
CT175	Adjustable wand for 15 Series hoses	1	\$54.08	CA
CT350B	Deluxe Air Turbine Brush	1	\$40.18	CA
CT700	Deluxe Power Brush	1	\$292.00	CA
VX3916	Standard Filter Media bags for VX475 Series (three bags per pack)	1	\$18.52	XH
VX3918	Premium Replacement bags for VX550 and VX1000 Series (three bags per pack)	1	\$74.42	XH
VX3918STD	Standard Filter Media bags for VX550 and VX1000 Series (three bags per pack)	1	\$18.98	XH

● Item too large to ship via UPS/FedEx. Item shipped common carrier at minimum rates.
 * All pricing reflects the individual item cost. You must order in multiples as indicated.
 ◆ UL listed for use over bathtubs and showers when connected to a GFCI protected branch circuit.

Door Chimes

NuTone® Hard-Wired Door Chimes



LA11BG
LA11WH



LA70MA



LA18WH
LB18WH

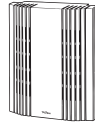

LA107WH



LA126WH



LA130WH

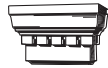

LA139WH



LA140WH



LA164WH

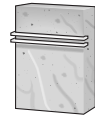

LA165SA



LA174WH



LA301WH

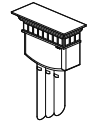

LA310CY



LA501CY

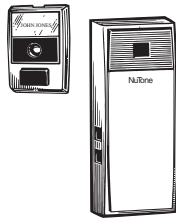

MCV309NWHGL

Model No.	Description	Std. Pk.	List Price	Code
LA11BG	Beige 2 Note	6 *	\$42.26	DC
LA11WH	White 2 Note	6 *	\$42.26	DC
LA14WH	White 2 Note Built-In	6 *	\$61.42	DC
LA18WH	White 2 Note	6 *	\$78.46	DC
LA39WH	White 2 Note Chord Tone	1	\$162.84	DC
LA70MA	Natural Maple Finish Wood Case — 4 – 8 Note	1	\$315.30	DC
LA100WH	Molded white finish, recessed grooves	3 *	\$36.60	DC
LA107WH	White 2 Note; Wired or Wireless	1	\$96.38	DC
LA126WH	White 2 Note	1	\$34.36	DC
LA130WH	White 2 Note	1	\$62.70	DC
LA139WH	Traditional White 2 Note	1	\$34.36	DC
LA140WH	Classic Arched Top 2 Note	1	\$34.36	DC
LA164WH	White Lighted 2 Note	1	\$166.60	DC
LA165SA	Neutral Lighted 2 Note	1	\$166.60	DC
LA174WH	White 8 Note Electronic Built-In Chime (May be used with Intercom Systems)	1	\$133.60	DC
LA202WH	White with rounded corners	3 *	\$53.10	DC
LA301WH	White Shield Design Cover (Two-note Front and Single-note Second Door)	6 *	\$41.42	DC
LA305WL	Walnut finish real wood, brass insert, 3 brass finish tubes	1	\$351.62	DC
LA310CY	Cherry Cover with Satin Nickel Chambers (Eight-note, Four-note and Single-note Chimes)	1	\$403.22	DC
LA501CY	Cherry, beveled mirror, 4 real brass tubes	1	\$653.24	DC
LA600WH	White MP3 Customizable Wired/Wireless Chime	1	\$98.86	DC
MCV309NWHGL	White & Gold 2 Note Mechanical Chime With Viewer	6 *	\$60.14	DC

- Item too large to ship via UPS/FedEx. Item shipped common carrier at minimum rates.
- * All pricing reflects the individual item cost. You must order in multiples as indicated.
- ◆ UL listed for use over bathtubs and showers when connected to a GFCI protected branch circuit.

Door Chimes

NuTone® Wireless Door Chimes

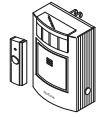

LA224RWH
LA224WH



LA223WH



LA225WH

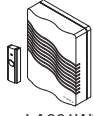

LA226WH



LA542WH

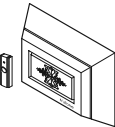

LA552RW

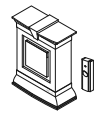

LA553WH

Model No.	Description	Std. Pk.	List Price	Code
LA223WH	White Wireless Plug-In Door Chime — 1, 2 or 8 notes	1	\$48.18	DC
LA224RWH	Visual Wireless Plug-In Door Chime Receiver — 1, 2 or 8 notes	1	\$78.72	DC
LA224WH	Visual Wireless Plug-In Door Chime — 1, 2 or 8 notes. Includes Receiver, Pushbutton and Pushbutton Battery.	1	\$88.18	DC
LA225WH	White Wireless Door Chime — 2 notes. Includes Receiver, Pushbutton and Pushbutton Battery.	1	\$42.54	DC
LA226WH	White Wireless Door Chime — 1, 2 or 8 notes. Includes Receiver.	1	\$65.18	DC
LA542WH	Front/back wireless with two buttons	3 *	\$66.46	DC
LA552RW	Americana wireless chime	1	\$82.38	DC
LA553WH	Pilot wireless chime	3 *	\$53.82	DC
LA600WH	White MP3 Customizable Wired/Wireless Chime	1	\$98.86	DC

NuTone® Chime Kits (CHIME, TRANSFORMER, BUTTON(S))



BK105
BK115LWH

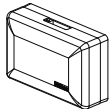

BK140LWH
BK140SLPB
BK142LWH



BK147LWH

Model No.	Description	Std. Pk.	List Price	Code
BK105	Chime only, 2-note / 1-note	24 *	\$24.22	DC
BK110NBWH	Chime, 1 unlighted pushbutton, 1 std. transformer	24 *	\$32.14	DC
BK115LWH	Chime, 1 lighted pushbutton, 1 std. transformer	24 *	\$35.28	DC
BK120NBWH	Chime, 2 unlighted pushbutton, 1 std. transformer	24 *	\$34.08	DC
BK125LWH	Chime, 2 lighted pushbutton, 1 std. transformer	24 *	\$37.70	DC
BK131LPB	Chime, 1 lighted stucco pushbutton in polished brass, 1 std. transformer	24 *	\$37.82	DC
BK131LSN	Chime, 1 lighted stucco pushbutton in satin nickel, 1 std. transformer	6 *	\$37.82	DC
BK131LRBZ	Chime, 1 lighted stucco pushbutton in oil-rubbed bronze, 1 std. transformer	6 *	\$37.82	DC
BK131LWH	Chime, 1 lighted stucco pushbutton in white, 1 std. transformer	6 *	\$37.82	DC
BK140LWH	Chime, 1 lighted pushbutton, 1 j-box transformer	24 *	\$38.82	DC
BK140SLPB	Chime, 1 lighted stucco pushbutton in polished brass, 1 j-box transformer	24 *	\$41.46	DC
BK142LWH	Chime, 2 lighted pushbutton, 1 j-box transformer	24 *	\$41.46	DC
BK144LCL	Chime, 1 lighted pushbutton round, 1 std. transformer	24 *	\$32.14	DC
BK147LWH	Recessed Chime, 1 lighted pushbutton, 1 std. transformer	24 *	\$54.30	DC

- Item too large to ship via UPS/FedEx. Item shipped common carrier at minimum rates.
- * All pricing reflects the individual item cost. You must order in multiples as indicated.
- ◆ UL listed for use over bathtubs and showers when connected to a GFCI protected branch circuit.

NuTone® Wired Pushbuttons

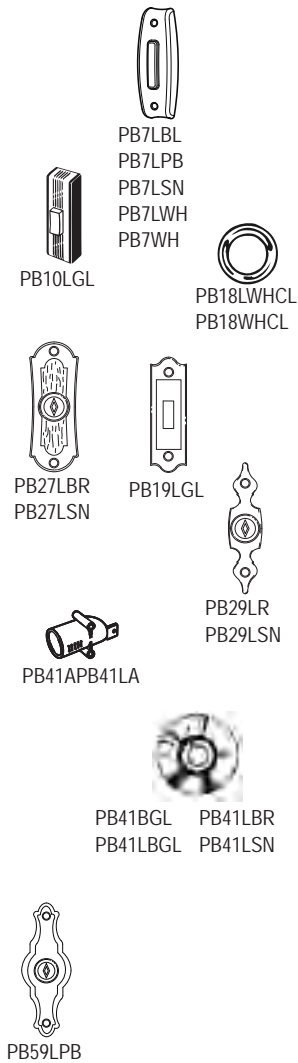

Model No.	Description	Std. Pk.	List Price	Code
PB4LBL	Pushbutton, lighted in black	3 *	\$22.78	DA
PB4LBR	Pushbutton, lighted in oil-rubbed bronze	3 *	\$26.62	DA
PB4LSN	Pushbutton, lighted in satin nickel	3 *	\$26.62	DA
PB7LBL	Pushbutton, lighted in black	12 *	\$7.58	DA
PB7LPB	Pushbutton, lighted in polished brass	12 *	\$7.58	DA
PB7LSN	Pushbutton, lighted in satin nickel	12 *	\$7.58	DA
PB7LWH	Pushbutton, lighted in white	12 *	\$7.58	DA
PB7WH	Pushbutton, unlighted in white	12 *	\$7.58	DA
PB10LGL	Pushbutton, gold and black — lighted	12 *	\$11.64	DA
PB15LBR	Pushbutton, lighted in oil-rubbed bronze	3 *	\$26.62	DA
PB15LPB	Pushbutton, lighted in polished brass	3 *	\$23.58	DA
PB15LSN	Pushbutton, lighted in satin nickel	3 *	\$26.62	DA
PB18LWHCL	Pushbutton, clear with white cap — lighted	12 *	\$7.86	DA
PB18WHCL	Pushbutton, clear with white cap — unlighted	12 *	\$5.00	DA
PB19LGL	Pushbutton, polished brass — lighted	12 *	\$20.20	DA
PB27LBR	Pushbutton, lighted in oil-rubbed bronze	3 *	\$26.62	DA
PB27LSN	Pushbutton, satin nickel — lighted	6 *	\$26.62	DA
PB29LR	Pushbutton, oil-rubbed bronze — lighted	6 *	\$22.08	DA
PB29LSN	Pushbutton, satin nickel — lighted	6 *	\$22.08	DA
PB41APB41LA	Plastic Stucco Sleeves	24 *	\$3.46	DA
PB41BGL	Pushbutton, polished brass stucco — unlighted	24 *	\$7.24	DA
PB41LBGL	Pushbutton, polished brass stucco — lighted	24 *	\$10.08	DA
PB41LBR	Pushbutton, oil-rubbed bronze stucco — lighted	24 *	\$11.96	DA
PB41LSN	Pushbutton, satin nickel stucco — lighted	24 *	\$11.96	DA
PB53LWH	Pushbutton, lighted in white	3 *	\$22.78	DA
PB59LPB	Pushbutton, lighted in polished brass	3 *	\$20.50	DA
PB61LPB	Pushbutton, lighted in polished brass	3 *	\$24.96	DA
PB64LAB	Pushbutton, lighted in antique brass	3 *	\$21.22	DA
PB67AB	Pushbutton, unlighted in antique brass	3 *	\$7.92	DA
PB69LBL	Pushbutton, lighted in black	6 *	\$8.04	DA
PB69LPB	Pushbutton, lighted in polished brass	6 *	\$8.04	DA
PB69LPC	Pushbutton, lighted in polished chrome	6 *	\$8.04	DA
PB69LSN	Pushbutton, lighted in satin nickel	6 *	\$10.16	DA
PB69LWH	Pushbutton, lighted in white	6 *	\$8.04	DA

Note: The diamond symbol on the pushbuttons is currently being replaced with the NuTone Logo.

- Item too large to ship via UPS/FedEx. Item shipped common carrier at minimum rates.
- * All pricing reflects the individual item cost. You must order in multiples as indicated.
- ◆ UL listed for use over bathtubs and showers when connected to a GFCI protected branch circuit.

Door Chimes

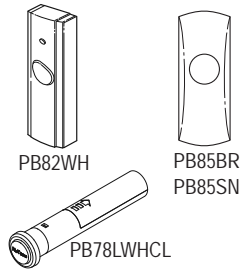

NuTone® Wireless Pushbuttons

Model No.	Description	Std. Pk.	List Price	Code
PB82WH	Unlighted, White	6 *	\$21.22	DC
PB85BR	Unlighted, Oil-Rubbed Bronze	6 *	\$36.82	DC
PB85SN	Unlighted, Satin Nickel	6 *	\$36.82	DC
PB78LWHCL	Wireless — White Lighted	1	\$27.58	DA

NuTone® Chime Accessories



Model No.	Description	Std. Pk.	List Price	Code
C905	16v, 10va Transformer	6 *	\$17.10	DA
C907	16v, 30va Transformer	6 *	\$27.10	DA
C909	Tri-volt 8, 16, 24 Volt 20 VA Transformer	6 *	\$30.18	DA
C915	16v, 10va J-Box Transformer	6 *	\$27.10	DA
PBL2	Replacement bulbs for all lighted pushbuttons — Visu-Pack	12 *	\$5.78	DA
SPB18LWHCL	Replacement Bulb for round button	1	\$7.96	PT

Haven™



HVDCT



HVLFABL
HVLFABR

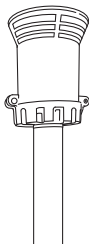

HVRFABL
HVRFABR

NuTone® Haven™ Backyard Lighting & Mosquito Repellent System features innovative landscape fixtures that provide season-long*, effective protection from biting mosquitoes. Don't let biting mosquitoes keep you from enjoying time outdoors with family and friends! Haven's patented mosquito protection system provides protection within 15 minutes of use and is effective against all types of mosquitoes. Four haven fixtures protect a typical deck or patio for over 440 square feet of coverage. They're easy to install and designed to mount on a deck post, railing or stake in the ground. Plus, you can add Haven to an existing low voltage lighting system or install with a transformer and cable for convenient protection from biting mosquitoes.

* 90 days of mosquito protection when used an average of 2.4 hours/day.

Model No.	Description	Std. Pk.	List Price	Code
HVDCT	Dual Controller/Timer	1	\$78.00	ML
HVLFABL	Light & Repellent Fixture — Black	1	\$200.00	ML
HVLFABR	Light & Repellent Fixture — Bronze	1	\$200.00	ML
HVPFBL	Post/Rail Mount Flange — Black	1	\$9.00	ML
HVPFBR	Post/Rail Mount Flange — Bronze	1	\$9.00	ML
HVRC1	Repellent Refill	1	\$67.00	ML
HVRC4	Repellent Refill (4 Pack)	1	\$206.00	ML
HVRFABL	Repellent Fixture — Black	1	\$165.00	ML
HVRFABR	Repellent Fixture — Bronze	1	\$165.00	ML

Heaters

NuTone® Surface Mount Ceiling Heater



Enjoy the comfort of 1250 watts of instant heat in a bathroom, laundry room or any area where you want extra heat without using the central heating system. Easy to install ... fits standard 3-1/4" and 4" octagon, as well as 3-1/2" round electrical boxes. 11" diameter.

Model No.	Description	Std. Pk.	List Price	Code
157	Low-Profile Ceiling Heater — Same as Model 154 except with exclusive totally enclosed, sheathed element. 1250W, 120VAC.	1	\$133.90	HT

- Item too large to ship via UPS/FedEx. Item shipped common carrier at minimum rates.
- * All pricing reflects the individual item cost. You must order in multiples as indicated.
- ◆ UL listed for use over bathtubs and showers when connected to a GFCI protected branch circuit.

Heaters

NuTone® High Capacity Wall Heaters

Large capacity fan-forced heaters for high heat loss areas such as lobbies, entranceways and vestibules. Easily convert to half-wattage. Totally enclosed, sheathed elements. Model 85 surface mount kit for Models 192, 194 and 198 available separately (see Page 22).

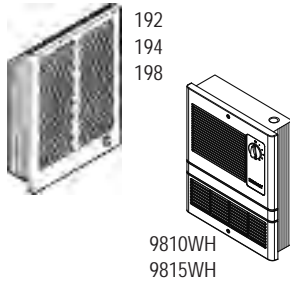

Model No.	Description	Std. Pk.	List Price	Code
192	Wall Heater, 1000/2000W+ 240VAC +, 750/1500W 208VAC. White painted grille.	1	\$422.78	HT
194	Wall Heater, 1500/3000W+ 240VAC +, 1125/2250W 208VAC. White painted grille.	1	\$445.58	HT
198	Wall Heater, 2000/4000W+ 240VAC +, 1500/3000W 208VAC. White painted grille.	1	\$466.80	HT
9810WH	1000W Fan-Forced Wall Heater, White polymeric grille, 120/240 volts.	1	\$266.46	HT
9815WH	1500W Fan-Forced Wall Heater, White polymeric grille, 120/240 volts.	1	\$273.74	HT

+ Factory wired wattage/voltage. Field convertible to other options listed.

NuTone® Kickspace Heaters

Slim and trim ... designed for permanent installation into any cabinet kickspace, vanity base or other area where wall space is limited. Perfect for stairway installation, ticket/toll booths, checkout counters, etc.



Model No.	Description	Std. Pk.	List Price	Code
112	Kickspace Heater. 1500W+ 240VAC +, 750/1500W 120VAC, with built-in thermostat. White.	1	\$280.60	HT
114	Kickspace Heater. Same as Model 112 except w/o built-in thermostat. White.	1	\$249.74	HT
90	Thermostat Kit — Used to install thermostat in Model 114 kickspace heater. Snap action, bi-metallic, effective temperature range of 40 – 130° F.	1	\$57.84	AC

+ Factory wired wattage/voltage. Field convertible to other options listed.

NuTone® Fan-Forced Wall Heaters

Perfect for the bathroom or other areas where fan-forced heat is needed quickly. Easily converts to half-wattage. Attractive white grille finish standard. Housing measures 10-1/4" W x 7-3/4" H x 3-3/4" D. Sturdy steel grille measures 12" W x 9-1/4" H x 1/2" D. Model 84 surface mount kit available separately (see Page 22).



Model No.	Description	Std. Pk.	List Price	Code
170	Wall Heater. 500/1000W+ 120VAC +, 750W 208VAC, 1000W 240 VAC. White painted grille.	1	\$172.30	HT
174	Wall Heater. 750/1500W+ 120VAC +, 1125W 208VAC, 1500W 240 VAC. White painted grille.	1	\$180.78	HT
178	Wall Heater. 1000/2000W+ 240VAC +, 750W/1500W 208 VAC. White painted grille.	1	\$193.80	HT

+ Factory wired wattage/voltage. Field convertible to other options listed.

Broan® Big Heat® Portable Heater

Effective two-level 120V (1500 and 1200 watts) portable heater is compact with easy to use controls. The built-in thermostat will keep you comfortable in nearly any situation. 6' power cord has a polarized plug. Overheat protection shuts off the heater and activates the "caution" light if excess heat is detected. A safety switch instantly shuts off the heater if it is tipped over.



Model No.	Description	Std. Pk.	List Price	Code
6201	Efficient Two-Level Heater, 1500 or 1200 watts. Built-in adjustable thermostat. Steel, 6' cord. Safety tipover switch and overload protector.	6 *	\$105.72	PH

■ Limited quantities available.

- Item too large to ship via UPS/FedEx. Item shipped common carrier at minimum rates.
- * All pricing reflects the individual item cost. You must order in multiples as indicated.
- ◆ UL listed for use over bathtubs and showers when connected to a GFCI protected branch circuit.

Heaters

NuTone® Heater Project Packs

Broan's project packs offer housings packed and sold separately from heater assemblies and grilles. You can buy housings for rough-in ... buy heater/motor assemblies and grilles later for finishing. Order Broan Model 83 Built-in Thermostat available separately — if required for "F" models (see below).



Grille

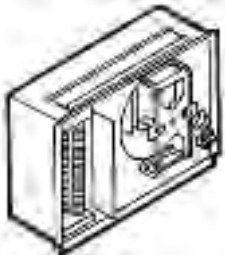

Project Pack Housing and Finish Unit

Model No.	Description	Std. Pk.	List Price	Code
171H	Project Pack Housing Unit. Use with all Finish Units.	4 *	\$34.56	HT
165F	Project Pack Finish Unit. Use 171H Project pack housing for rough-in. 500W+ 120/240VAC +, 375W 208VAC. White grille.	1	\$127.04	HT
165FT	Project Pack. Same as 165F, except includes built-in thermostat.	1	\$137.70	HT
167F	Project Pack Finish Unit. Use 171H Project pack housing for rough-in. 750 +/1500W 240VAC +, 562/1125W 208VAC. White grille.	1	\$127.04	HT
167FT	Project Pack. Same as 167F, except includes built-in thermostat.	1	\$137.70	HT
174F	Project Pack Finish Unit. Use 171H Project pack housing for rough-in. 750/1500W+ 120VAC +, 1125W 208VAC, 1500W 240VAC. White grille.	1	\$135.52	HT
174FT	Project Pack. Same as 174F except includes built-in thermostat.	1	\$146.20	HT

+ Factory wired wattage/voltage. Field convertible to other options listed.

NuTone® Register Heaters

Fan-forced heat for instant warmth from an attractive "register" type heater. Specially designed nickel-chrome element heats in seconds. Use convenient wall-mounted line-voltage thermostat (Broan Model 86W available separately — see below). Housing size 10-1/4" W x 7-3/4" H x 3-3/4" D. Sturdy steel grille size 14-1/4" W x 9-1/4" H x 7/8" D.

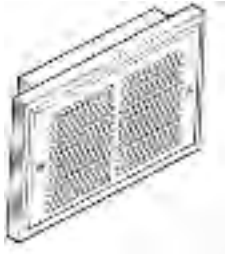

Model No.	Description	Std. Pk.	List Price	Code
120	Heater. 500/1000W+ 120VAC +, 750W 208VAC, 1000W 240VAC. White grille.	1	\$172.30	HT
124	Heater. 750/1500W+ 120VAC +, 1125W 208VAC, 1500W 240VAC. White grille.	1	\$180.78	HT
128	Heater. 1000/2000W+ 240VAC +, 750/1500W 208VAC. White grille.	1	\$186.26	HT

+ Factory wired wattage/voltage. Field convertible to other options listed.

NuTone® Heater Accessories

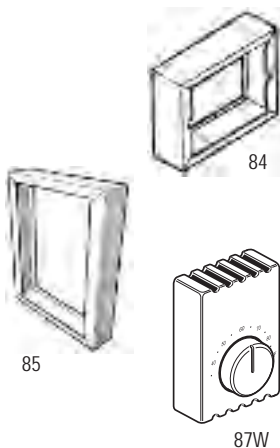

84

85

87W

Model No.	Description	Std. Pk.	List Price	Code
83	Thermostat Kit. Used to install thermostat in Models 165F, 167F, 170F, 174F and 178F Wall Heaters. Snap action, bi-metallic. Rated 120/240VAC, 12.5 amps. Temperature range 40 – 125° F.	1	\$21.52	AC
84	Surface Mount Kit. White enameled steel. For use with Models 165F, 165FT, 167F, 167FT, 170, 170F, 170FT, 174, 174F, 174FT, 178, 178F and 178FT Wall Heaters.	1	\$44.00	AC
85	Surface Mount Kit. White enameled steel. For use with Models 192, 194 and 198 High Capacity Wall Heaters.	1	\$97.60	AC
87W	Line Voltage Wall Thermostat. Snap action bi-metallic, single pole — rated 120/240VAC, 22 amps. Temperature range 50 – 85° F. Decorator white finish.	1	\$31.14	AC
90	Thermostat Kit. Used to install built-in thermostat in Model 114 kickspace heater. Snap action, bi-metallic, effective temperature range of 40 – 130° F.	1	\$57.84	AC

● Item too large to ship via UPS/FedEx. Item shipped common carrier at minimum rates.

* All pricing reflects the individual item cost. You must order in multiples as indicated.

◆ UL listed for use over bathtubs and showers when connected to a GFCI protected branch circuit.

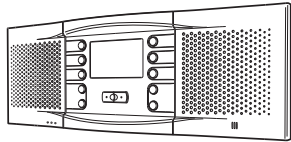

NM100WH

NuTone® NM100 Master Station

Model No.	Description	Std. Pk.	List Price	Code
NM100WH	Master Station, White	1	\$889.84	NM

NuTone® NM100 Speakers and Accessories

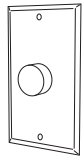

NA300MCWH

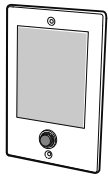

NDB300AB
NDB300BB
NDB300N

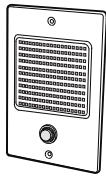

NDB300WH

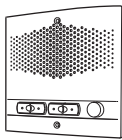

NPS103WH
NPS104WH
NRS103WH
NRS104WH

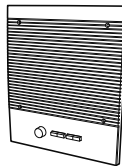

NR380WH

Model No.	Description	Std. Pk.	List Price	Code
NA200TA	Transformer	1	\$60.26	NM
NA3003C	3-Note Chime Module	1	\$67.62	NM
NA3008C	8-Note Chime Module	1	\$133.98	NM
NA300MCWH	Volume Control — White	1	\$24.60	NM
NA300TA	Transformer	1	\$77.42	NM
NDB300AB	Door Speaker — Antique Brass	1	\$73.74	NM
NDB300BB	Door Speaker — Bright Brass	1	\$79.62	NM
NDB300N	Door Speaker — Nickel	1	\$76.34	NM
NDB300WH	Door Speaker — White	1	\$49.18	NM
NES300DBL	Plastic Door Speaker Surface Mount Frame — Black	1	\$27.04	NM
NES300DWH	Plastic Door Speaker Surface Mount Frame — White	1	\$27.04	NM
NF100MWH	Master Retrofit Frame — White	1	\$63.90	NM
NF200MWH	Master Frame — White	1	\$40.68	NM
NF300DWH	Door Speaker Retrofit Frame — White	1	\$25.84	NM
NF300PWH	Outdoor Remote Station Retrofit Frame — White	1	\$61.44	NM
NF300RWH	Indoor Remote Station Retrofit Frame — White	1	\$38.12	NM
NPS103WH	Outdoor Remote Station (3-wire) — White	1	\$126.58	NM
NPS104WH	Outdoor Remote Station (4-wire) — White	1	\$126.58	NM
NR380WH	Indoor 8" Remote Station — White	1	\$119.24	NM
NRKF200P	Outdoor Remote Station Rough-In	1	\$27.04	NM
NRKR200R	Indoor Remote Station Rough-In (Pack of 5)	1	\$50.40	NM
NRKR300D	Door Speaker Rough-In	1	\$14.74	NM
NRKRWH300	Rough-In Kit	1	\$209.00	NM
NRKS200PWH	Outdoor Remote Station Surface Mount Frame — White	1	\$39.32	NM
NRKS300R	Indoor Remote Station Surface Mount Rough-In — White	1	\$51.62	NM
NRS103WH	Indoor Remote Station (3-wire) — White	1	\$84.84	NM
NRS104WH	Indoor Remote Station (4-wire) — White	1	\$84.84	NM
NW4S	Shielded Cable, 22 gauge, 75'	1	\$37.20	NM
NWH300	Master Station Rough-In	1	\$182.44	NM

- Item too large to ship via UPS/FedEx. Item shipped common carrier at minimum rates.
- * All pricing reflects the individual item cost. You must order in multiples as indicated.
- ◆ UL listed for use over bathtubs and showers when connected to a GFCI protected branch circuit.

Intercom Systems

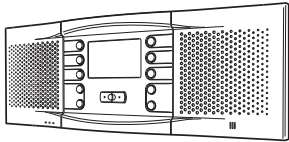

NM200AL
NM200WH

NuTone® NM200 Master Station

Model No.	Description	Std. Pk.	List Price	Code
NM200AL	Master Station — Almond	1	\$946.36	NM
NM200WH	Master Station — White	1	\$860.36	NM

NuTone® NM200 Speakers and Accessories

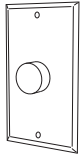

NA300MCWH



NDB300AB
NDB300BB
NDB300N



NDB300WH

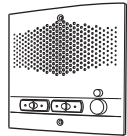

NPS200WH
NRS200AL
NRS200WH

Model No.	Description	Std. Pk.	List Price	Code
NA200TA	Transformer	1	\$60.26	NM
NA3003C	3-Note Chime Module	1	\$67.62	NM
NA3008C	8-Note Chime Module	1	\$133.98	NM
NA300MCWH	Volume Control — White	1	\$24.60	NM
NA300TA	Transformer	1	\$77.42	NM
NDB300AB	Door Speaker — Antique Brass	1	\$73.74	NM
NDB300BB	Door Speaker — Bright Brass	1	\$79.62	NM
NDB300N	Door Speaker — Nickel	1	\$76.34	NM
NDB300WH	Door Speaker — White	1	\$49.18	NM
NES300DBL	Plastic Door Speaker Surface Mount Frame — Black	1	\$27.04	NM
NES300DWH	Plastic Door Speaker Surface Mount Frame — White	1	\$27.04	NM
NF100CWH	■ Master and CD Combination Retrofit Frame — White	1	\$95.90	NM
NF100MWH	Master Retrofit Frame — White	1	\$63.90	NM
NF200MWH	Master Frame — White	1	\$40.68	NM
NF300DWH	Door Speaker Retrofit Frame — White	1	\$25.84	NM
NF300PWH	Outdoor Remote Station Retrofit Frame — White	1	\$61.44	NM
NF300RWH	Indoor Remote Station Retrofit Frame — White	1	\$38.12	NM
NM200K	Music Intercom Kit	1	\$1,354.42	NM
NPS200WH	Outdoor Remote Station — White	1	\$121.70	NM
NRKF200P	Outdoor Remote Station Rough-In	1	\$27.04	NM
NRKR200R	Indoor Remote Station Rough-In (Pack of 5)	1	\$50.40	NM
NRKR300D	Door Speaker Rough-In	1	\$14.74	NM
NRKRWH300	Rough-In Kit	1	\$209.00	NM
NRKS200PWH	Outdoor Remote Station Surface Mount Frame — White	1	\$39.32	NM
NRS200AL	Indoor Remote Station — Almond	1	\$90.96	NM
NRS200WH	Indoor Remote Station — White	1	\$82.36	NM
NW4S	Shielded Cable, 22 gauge, 75'	1	\$37.20	NM
NWH300	Master Station Rough-In	1	\$182.44	NM

■ Limited quantities available.

- Item too large to ship via UPS/FedEx. Item shipped common carrier at minimum rates.
- * All pricing reflects the individual item cost. You must order in multiples as indicated.
- ◆ UL listed for use over bathtubs and showers when connected to a GFCI protected branch circuit.

Intercom Systems

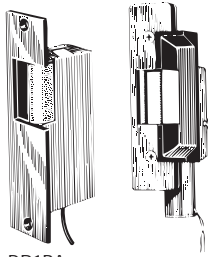

DR1BA
DR1SA

DR2SA

NuTone® Electronic Door Release

Model No.	Description	Std. Pk.	List Price	Code
DR1BA	Door Release, Electric, Wood Door Frame, Brass Anodized	1	\$84.56	IA
DR1SA	Door Release, Electric, Wood Door Frame, Silver Anodized	1	\$99.98	IA
DR2SA	Door Release, Electric, Metal Door Frame, Silver Anodized	1	\$177.64	IA

Ironing Centers — Built-In

NuTone® Ironing Centers



ICUDWH
ICUNUW

Model No.	Description	Std. Pk.	List Price	Code
<u>Ironing Centers</u>				
ICUDWHX	Built-In Ironing Center — White with White Raised Panel Door - Over Packed (includes hinges and ironing board cover)	1	\$306.68	IB
ICUNUWX	Built-In Ironing Center — Unfinished Birch, No Door - Over Packed (includes hinges and ironing board covers)	1	\$285.18	IB
<u>Custom Doors</u>				
ICDM	Custom Door — Mirror	1	\$151.68	IB
ICDFUW	Custom Door — Birch Flat Panel (Unfinished)	1	\$116.68	IB
ICDRUW	Custom Door — Birch Raised Panel (Unfinished)	1	\$116.68	IB
<u>Accessories</u>				
ICAK	Deluxe Accessory — LED Light, Electrical Outlet, Timer	1	\$134.62	IB
ICAB	Accessory — Replacement Ironing Board Cover	1	\$36.16	IB

NuTone® Ironing Centers

Model No.	Description	Std. Pk.	List Price	Code
<u>Custom Doors</u>				
AVDOFPN	■ Custom Door — Birch Flat Panel (Unfinished). Fits AVD40N and AVD50N.	1	\$146.42	IB
AVDORPN	■ Custom Door — Oak Raised Panel (Unfinished). Fits AVD40N and AVD50N.	1	\$174.44	IB
AVDWRPN	■ Custom Door — White Raised Panel. Fits AVD40N and AVD50N.	1	\$183.60	IB
<u>Accessories</u>				
AVDSMN	■ Surface Mount Collar. Fits AVD40N and AVD50N.	1	\$85.84	IB

■ Limited quantities available.

- Item too large to ship via UPS/FedEx. Item shipped common carrier at minimum rates.
- * All pricing reflects the individual item cost. You must order in multiples as indicated.
- ◆ UL listed for use over bathtubs and showers when connected to a GFCI protected branch circuit.

Range Hoods — Chimney



619004

6" Round Duct — Internal Blower
450 CFM, 9.0 Sones

614804

8" Round Duct — Internal Blower
900 CFM, 9.5 Sones

8" Round Duct — External Blower
280 – 1500 CFM

Broan® Elite 61000 Series

Wall-mounted hood with telescopic flue that accommodates 8' to 9' ceilings. Seamless corners provide stylish, easy cleaning surface. Three-speed blower with Heat Sentry™ and light control. Available in 30", 35-7/16" (90cm) and 48" widths in stainless. Two (30" & 35-7/16") or four (48") 20-watt halogen bulbs (included) provide bright cooktop lighting. Internal and external blower capability.

Model No.	Description	Std. Pk.	List Price	Code
30" 613004	Stainless Steel Range Hood	1	\$2,227.84	DH
90cm 619004	35-7/16" (90cm) Stainless Steel Range Hood	1	\$2,256.94	DH
619004EX	35-7/16" (90cm) Stainless Steel Range Hood, External Blower. Blowers are ordered separately. Select from Models 331H, 332H, 335, 336, HLB3, HLB6, HLB9 and HLB11 on Page 37.	1	\$1,648.56	DH
48" 614804	● Stainless Steel Range Hood	1	\$2,518.80	DH
614804EX	● Stainless Steel Range Hood, External Blower. Blowers are ordered separately. Select from Models 331H, 332H, 335, 336, HLB3, HLB6, HLB9 and HLB11 on Page 37.	1	\$1,917.40	DH
RFX6104	Ducted Flue Extension for 61000 Series with Internal Blower (not for Model 614804)	1	\$509.40	HA
RFX6104EX	Flue Extension for 61000EX Series with External Blower and Model 614804	1	\$566.00	HA
ROUNDFILTER	Replacement Non-ducted Charcoal Filter (for 613004 and 619004)	1	\$97.14	HA
ARP6	CFM Reducer Kit. Reduces CFM to less than 300 CFM, 6" round when used with 613004 and 619004.	5 *	\$49.18	AC

Range hoods work with make-up dampers (MD6TU, MD8TU and MD10TU) and fresh air inlets (641FA, 643FA and 610FA) — see accessories on Page 5.



8" Round Duct — Internal Blower
900 CFM, 9.5 Sones

8" Round Duct — External Blower
280 – 1500 CFM

Broan® Elite 63000 Series

Island-mounted hood with telescopic flue accommodates 8' to 9' ceilings. Seamless corners provide stylish, easy cleaning surface. Three-speed blower with Heat Sentry™. 27-9/16" x 39-3/8" (70cm x 100cm) in stainless. Four 20-watt halogen bulbs (included) provide bright cooktop lighting.

Model No.	Description	Std. Pk.	List Price	Code
637004	● 27-9/16" x 39-3/8" (70cm x 100cm) Stainless Steel Range Hood	1	\$4,310.06	DH
637004EX	● 27-9/16" x 39-3/8" (70cm x 100cm) Stainless Steel Range Hood, External Blower. Blowers are ordered separately. Select from Models 331H, 332H, 335, 336, HLB3, HLB6, HLB9 and HLB11 on Page 37.	1	\$3,891.40	DH
RFX6304EX	Flue Extension for 9' to 10' ceilings	1	\$1,386.76	HA

Range hoods work with make-up dampers (MD6TU, MD8TU and MD10TU) and fresh air inlets (641FA, 643FA and 610FA) — see accessories on Page 5.

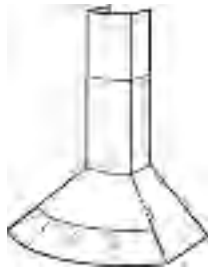

6" Round Duct — Internal Blower
450 CFM, 9.0 Sones

Broan® Elite RM65000 Series

This delightful, hand-crafted design blends curved and angular surfaces to form a stunning union of stainless steel and glass. The 65000 Series' 450 CFM centrifugal blower is combined with an advanced, multi-speed electronic control featuring a convenient 10-minute delay shut-off and Heat Sentry™. Two 20-watt halogen bulbs (included), two level brightness.

Model No.	Description	Std. Pk.	List Price	Code
RM659004	● 35-7/16" (90cm) Stainless Steel Range Hood	1	\$2,971.64	DH
RFX6504	Flue Extension for 9' to 10' ceilings	1	\$509.40	HA
ARP6	CFM Reducer Kit. Reduces CFM to less than 300 CFM, 6" round.	5 *	\$49.18	AC

Range hoods work with make-up dampers (MD6TU, MD8TU and MD10TU) and fresh air inlets (641FA, 643FA and 610FA) — see accessories on Page 5.

- Item too large to ship via UPS/FedEx. Item shipped common carrier at minimum rates.
- * All pricing reflects the individual item cost. You must order in multiples as indicated.
- ◆ UL listed for use over bathtubs and showers when connected to a GFCI protected branch circuit.

Range Hoods — Chimney

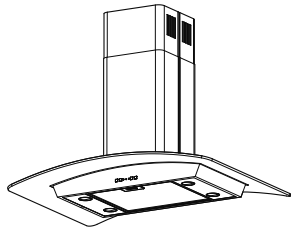

6" Round Duct — Internal Blower
High — 500 CFM, 10.5 Sones
Low — 200 CFM, 2.5 Sones

Compatible with Broan make-up air dampers.

Broan® Elite EI59 Series

Beautiful contemporary European glass island design. The curved glass canopy provides a stunning focal point without blocking the view of your surroundings. Electronic pushbutton control and halogen lighting (bulbs included).

Model No.	Description	Std. Pk.	List Price	Code
36" EI5936SS ●	Stainless Steel Range Hood	1	\$1,651.62	DH
FXNE59SS	Ducted or Non-ducted Flue Extension for 10' ceilings	1	\$682.76	AC
RKE59	Non-ducted Kit	1	\$223.48	AC
FILTERE56	Non-ducted Filter	1	\$57.56	AC
GU1035	Halogen Bulb; 120V, 35W	10 *	\$15.92	AC
MD6T Ø	6" Automatic Make-Up Air Damper	1	\$174.86	HA
MD8T Ø	8" Automatic Make-Up Air Damper	1	\$188.30	HA
MD10T Ø	10" Automatic Make-Up Air Damper	1	\$307.66	HA
BCR1	RF Remote Control	1	\$88.64	QA

Ø Work with fresh air inlets (641FA, 643FA and 610FA) — see accessories on Page 5.

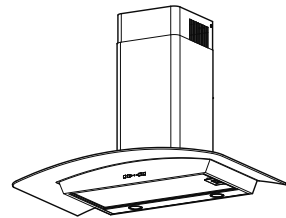

6" Round Duct — Internal Blower
High — 500 CFM, 10.5 Sones
Low — 200 CFM, 2.5 Sones

Compatible with Broan make-up air dampers.

Broan® Elite EW56 Series

Elegant European curved glass design that is both beautiful and functional. The airy design is a stunning focal point that complements its surrounding perfectly. Electronic pushbutton control and halogen lighting (bulbs included).

Model No.	Description	Std. Pk.	List Price	Code
30" EW5630SS ●	Stainless Steel Range Hood	1	\$1,096.88	DH
36" EW5636SS ●	Stainless Steel Range Hood	1	\$1,147.96	DH
FXNE56SS	Ducted or Non-ducted Flue Extension for 10' ceilings	1	\$397.74	AC
RKE56	Non-ducted Kit	1	\$223.48	AC
FILTERE56FL	Non-ducted Filter — Flat	1	\$73.22	AC
GU1035	Halogen Bulb; 120V, 35W	10 *	\$15.92	AC
MD6T Ø	6" Automatic Make-Up Air Damper	1	\$174.86	HA
MD8T Ø	8" Automatic Make-Up Air Damper	1	\$188.30	HA
MD10T Ø	10" Automatic Make-Up Air Damper	1	\$307.66	HA
BCR1	RF Remote Control	1	\$88.64	QA

Ø Work with fresh air inlets (641FA, 643FA and 610FA) — see accessories on Page 5.

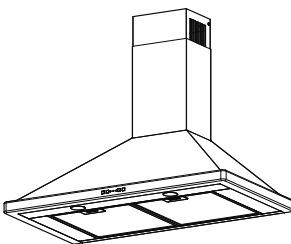

6" Round Duct — Internal Blower
High — 500 CFM, 10.5 Sones
Low — 200 CFM, 2.5 Sones

Compatible with Broan make-up air dampers.

Broan® Elite EW58 Series

Inspiring traditional European design. This wonderful design is executed to meet today's needs so that everyone can achieve their dream. Electronic pushbutton control and halogen lighting (bulbs included).

Model No.	Description	Std. Pk.	List Price	Code
30" EW5830SS ●	Stainless Steel Range Hood	1	\$1,096.88	DH
36" EW5836SS ●	Stainless Steel Range Hood	1	\$1,147.96	DH
FXNE58SS	Ducted or Non-ducted Flue Extension for 10' ceilings	1	\$284.86	AC
RKE58	Non-ducted Kit	1	\$223.48	AC
FILTERE56	Non-ducted Filter	1	\$57.56	AC
GU1035	Halogen Bulb; 120V, 35W	10 *	\$15.92	AC
MD6T Ø	6" Automatic Make-Up Air Damper	1	\$174.86	HA
MD8T Ø	8" Automatic Make-Up Air Damper	1	\$188.30	HA
MD10T Ø	10" Automatic Make-Up Air Damper	1	\$307.66	HA
BCR1	RF Remote Control	1	\$88.64	QA

Ø Work with fresh air inlets (641FA, 643FA and 610FA) — see accessories on Page 5.

- Item too large to ship via UPS/FedEx. Item shipped common carrier at minimum rates.
- * All pricing reflects the individual item cost. You must order in multiples as indicated.
- ◆ UL listed for use over bathtubs and showers when connected to a GFCI protected branch circuit.

Range Hoods — Chimney

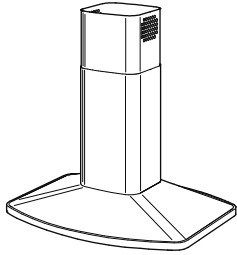

6" Round Duct — Internal Blower
High — 480 CFM, 9.5 Sones
Low — 230 CFM, 3.0 Sones

Broan® Elite E54000 Series

The E54000 Series island hood offers a clean and contemporary style with a soft touch. Engineered to meet today's conventional cooking appliances. 480 CFM multi-speed blower, large dishwasher-safe filters and four halogen lights (bulbs included) provide effective performance and brilliant task lighting.

Model No.	Description	Std. Pk.	List Price	Code
E5490SS ●	27-9/16" x 35-7/16" Stainless Steel Range Hood	1	\$2,787.48	DH
FX54SS	Ducted Flue Extension for 10' ceilings	1	\$929.16	HA
FXN54SS	Non-ducted Flue Extension for 10' ceilings	1	\$929.16	HA
RK54	Non-ducted Recirculation Kit	1	\$199.12	HA
FILTERSQUARE	Replacement Non-ducted Charcoal Filter	1	\$59.44	HA
ARP6	CFM Reducer Kit. Reduces CFM to less than 300 CFM, 6" round.	5 *	\$49.18	AC

Range hoods work with make-up dampers (MD6TU, MD8TU and MD10TU) and fresh air inlets (641FA, 643FA and 610FA) — see accessories on Page 5.



6" Round Duct — Internal Blower
370 CFM, 7.0 Sones

Broan® Elite RM53000 Series

This Italian inspired brushed stainless steel range hood proves that simplicity can be the perfect design statement and a match for today's conventional cooking appliances. A quiet 370 CFM multi-speed blower with Heat Sentry™, dishwasher-safe filters and generous lighting (bulbs included) provide effective performance and convenient operation.

Model No.	Description	Std. Pk.	List Price	Code
30" RM533004	Stainless Steel Chimney Hood	1	\$1,208.48	DH
36" RM533604 ●	Stainless Steel Chimney Hood	1	\$1,287.68	DH
42" RM534204 ●	Stainless Steel Chimney Hood	1	\$1,454.68	DH
RFX5304	Ducted Flue Extension for 10' ceilings	1	\$291.50	HA
RFXN5304	Non-ducted Flue Extension for 10' ceilings	1	\$291.50	HA
RRK51	Non-ducted Recirculation Kit	1	\$147.16	HA
FILTERSQUARE	Replacement Non-ducted Charcoal Filter	1	\$59.44	HA
ARP6	CFM Reducer Kit. Reduces CFM to less than 300 CFM, 6" round.	5 *	\$49.18	AC

Range hoods work with make-up dampers (MD6TU, MD8TU and MD10TU) and fresh air inlets (641FA, 643FA and 610FA) — see accessories on Page 5.



6" Round Duct — Internal Blower
370 CFM, 7.0 Sones

Broan® Elite RM52000 Series

This wall-mounted chimney hood combines graceful curves and traditional European styling. The 52000 Series is engineered to meet the requirements of today's highly styled, conventional appliances and kitchens. Its 370 CFM centrifugal blower and multi-speed control with Heat Sentry™ provide quiet, effective performance. Halogen lighting (bulbs included) accentuates the beauty of a fully enclosed bottom containing dishwasher-safe filters.

Model No.	Description	Std. Pk.	List Price	Code
30" RM523004	Stainless Steel Chimney Hood	1	\$1,208.48	DH
36" RM523604	Stainless Steel Chimney Hood	1	\$1,287.68	DH
42" RM524204 ●	Stainless Steel Chimney Hood	1	\$1,454.68	DH
RFX5204	Ducted Flue Extension for 9' to 10' ceilings	1	\$283.04	HA
RFXN5204	Non-ducted Flue Extension for 9' to 10' ceilings	1	\$283.04	HA
RRK51	Non-ducted Recirculation Kit	1	\$147.16	HA
FILTERSQUARE	Replacement Non-ducted Charcoal Filter	1	\$59.44	HA
ARP6	CFM Reducer Kit. Reduces CFM to less than 300 CFM, 6" round.	5 *	\$49.18	AC

Range hoods work with make-up dampers (MD6TU, MD8TU and MD10TU) and fresh air inlets (641FA, 643FA and 610FA) — see accessories on Page 5.

- Item too large to ship via UPS/FedEx. Item shipped common carrier at minimum rates.
- * All pricing reflects the individual item cost. You must order in multiples as indicated.
- ◆ UL listed for use over bathtubs and showers when connected to a GFCI protected branch circuit.

Range Hoods — Chimney



6" Round Duct — Internal Blower
370 CFM, 7.0 Sones

Broan® Elite RM51000 Series

The 51000 Series is a wall-mounted chimney hood with sleek, graceful curves that is engineered to meet the requirements of today's highly styled, conventional appliances and kitchens. Its 370 CFM centrifugal blower and multi-speed control with Heat Sentry™ provide quiet, effective performance. Halogen lighting (bulbs included) accentuates the beauty of a fully enclosed bottom containing dishwasher-safe filters.

Model No.	Description	Std. Pk.	List Price	Code
RM519004	35-7/16" (90cm) Stainless Steel Chimney Hood	1	\$1,287.68	DH
RFX5104	Ducted Flue Extension for 10' ceilings	1	\$283.04	HA
RRK51	Non-ducted Recirculation Kit	1	\$147.16	HA
FILTER SQUARE	Replacement Non-ducted Charcoal Filter (for RM51000, RM52000 and RM53000)	1	\$59.44	HA
ARP6	CFM Reducer Kit. Reduces CFM to less than 300 CFM, 6" round.	5 *	\$49.18	AC

Range hoods work with make-up dampers (MD6TU, MD8TU and MD10TU) and fresh air inlets (641FA, 643FA and 610FA) — see accessories on Page 5.

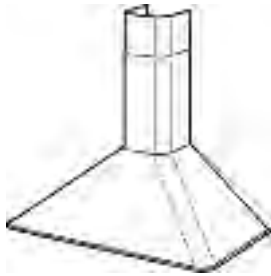

6" Round Duct — Internal Blower
290 CFM, 6.5 Sones

Broan® Elite RM50000 Series

The 50000 Series combines European design with tremendous value to meet the requirements of today's conventional appliance and kitchen styles. Its 290 CFM centrifugal blower and multi-speed control with Heat Sentry™ provide quiet, effective performance. A fully enclosed bottom contains a dishwasher-safe filter for easy cleaning. Plus, dual lighting provides excellent cooktop illumination.

Model No.	Description	Std. Pk.	List Price	Code
30"	RM503001 ● White Chimney Hood	1	\$976.40	DH
	RM503004 ● Stainless Steel Chimney Hood	1	\$976.40	DH
	RM503023 ● Black Chimney Hood	1	\$976.40	DH
36"	RM503601 ● White Chimney Hood	1	\$1,066.96	DH
	RM503604 ● Stainless Steel Chimney Hood	1	\$1,066.96	DH
	RM503623 ● Black Chimney Hood	1	\$1,066.96	DH
RFX5001	Ducted Flue Extension for 9' to 10' ceilings — White	1	\$283.04	HA
RFX5004	Ducted Flue Extension for 9' to 10' ceilings — Stainless Steel	1	\$283.04	HA
RFXN5004	Non-ducted Flue Extension for 9' to 10' ceilings — Stainless Steel	1	\$283.04	HA
RFX5023	Ducted Flue Extension for 9' to 10' ceilings — Black	1	\$283.04	HA
FILTEREB40	Replacement Non-ducted Charcoal Filter (for RMP17004 and RM50000)	1	\$93.42	HA

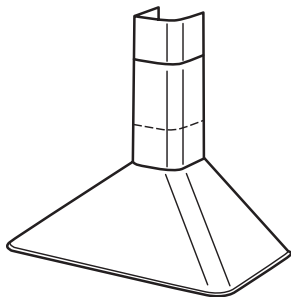

6" Round Duct — Internal Blower
High — 290 CFM, 5.5 Sones
Normal — 135 CFM, 0.5 Sones

Broan® Elite RME50000 Series (ENERGY STAR®)

The RME Series model is part of our new ENERGY STAR® hood offering and an extension of our popular RM50000 chimney hood line. Designed to provide energy efficient operation with a very quiet 290 CFM centrifugal blower. Features include 3-speed slide control, Heat Sentry™, dual 13 watt fluorescent lighting and a dishwasher-safe filter.

Model No.	Description	Std. Pk.	List Price	Code
RME5030SS ●	30" Stainless Steel Chimney Hood	1	\$1,052.58	RH
RFX5004	Ducted Flue Extension for 9' to 10' ceilings — Stainless Steel	1	\$283.04	HA

- Item too large to ship via UPS/FedEx. Item shipped common carrier at minimum rates.
- * All pricing reflects the individual item cost. You must order in multiples as indicated.
- ◆ UL listed for use over bathtubs and showers when connected to a GFCI protected branch circuit.

Range Hoods — Downdrafts

Broan® Elite RMDD Series Downdraft System

Designed specifically to be compatible with most conventional and commercial style cooktops combining a sensational appearance with high performance features. Stainless steel construction on all exposed surfaces provides a durable finish and an unforgettable look.

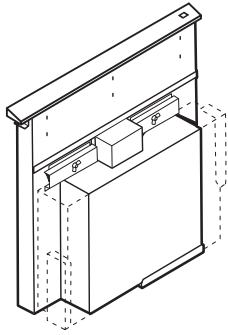

- 3-1/4" x 10" Duct — Internal Blower
500 CFM
- 3-1/4" x 14" Duct — Internal Blower
500 CFM
- 3-1/4" x 14" Duct — External Blower
280 – 1500 CFM

Model No.	Description	Std. Pk.	List Price	Code
30" RMDD3004	Downdraft with Internal Blower	1	\$1,715.08	DH
RMDD3004EX	Downdraft for External Blower. Fits 3-1/4" x 14" duct. Transition (Models 459 & 414) required to 10" rd. Blowers are ordered separately. Select from Models 331H, 332H, 335, 336, HLB3, HLB6, HLB9 and HLB11 on Page 37.	1	\$1,372.60	DH
36" RMDD3604	● Downdraft with Internal Blower	1	\$1,763.16	DH
RMDD3604EX	● Downdraft for External Blower. Fits 3-1/4" x 14" duct. Transition (Models 459 & 414) required to 10" rd. Blowers are ordered separately. Select from Models 331H, 332H, 335, 336, HLB3, HLB6, HLB9 and HLB11 on Page 37.	1	\$1,409.36	DH
48" RMDD4804	● Downdraft with Internal Blower	1	\$1,938.60	DH
RMDD4804EX	● Downdraft for External Blower. Fits 3-1/4" x 14" duct. Transition (Models 459 & 414) required to 10" rd. Blowers are ordered separately. Select from Models 331H, 332H, 335, 336, HLB3, HLB6, HLB9 and HLB11 on Page 37.	1	\$1,599.06	DH
RMDDRBK	Remote Button Kit	1	\$70.74	HA
ARP310	CFM Reducer Kit. Reduces CFM to less than 300 CFM, 3-1/4" x 10".	5 *	\$49.18	AC

Downdrafts work with make-up dampers (MD6TU, MD8TU and MD10TU) and fresh air inlets (641FA, 643FA and 610FA) — see accessories on Page 5.

Broan® 27000 Series Downdraft System ECLIPSE®

Ultimate styling complements virtually every cooktop style. Mounts behind most built-in cooktops in island, peninsula and wall mount installations. The unit mounts flush with the cooktop when not in operation, and is activated by light pressure on the cover which automatically raises the chimney 7" above the cooktop. The elevated chimney enables smoke and vapor to be captured at the top of most cooking vessels. A touch on the top of the chimney retracts it to its down position. Washable aluminum filters.



- 3-1/4" x 10" Duct — Internal Blower
500 CFM

Model No.	Description	Std. Pk.	List Price	Code
30" 273003	Downdraft with stainless steel cover. 28" wide intake fits most nominal 30" wide cooktops.	1	\$1,047.58	DH
273001C	White Cover Only — Optional	1	\$83.62	HA
273002C	■ Bisque Cover Only — Optional	1	\$83.62	HA
273023C	Black Cover Only — Optional	1	\$83.62	HA
36" 273603	● Downdraft with stainless steel cover. 34" wide intake fits most nominal 36" wide cooktops.	1	\$1,047.58	DH
273601C	White Cover Only — Optional	1	\$83.62	HA
273602C	■ Bisque Cover Only — Optional	1	\$83.62	HA
273623C	Black Cover Only — Optional	1	\$83.62	HA
ARP310	CFM Reducer Kit. Reduces CFM to less than 300 CFM, 3-1/4" x 10".	5 *	\$49.18	AC

For replacement filters, see Broan's Replacement Parts Guide.

Downdrafts work with make-up dampers (MD6TU, MD8TU and MD10TU) and fresh air inlets (641FA, 643FA and 610FA) — see accessories on Page 5.

■ Limited quantities available.

- Item too large to ship via UPS/FedEx. Item shipped common carrier at minimum rates.
- * All pricing reflects the individual item cost. You must order in multiples as indicated.
- ◆ UL listed for use over bathtubs and showers when connected to a GFCI protected branch circuit.

Range Hoods — Downdrafts

Broan® 28000 Series Remote Downdraft System ECLIPSE®

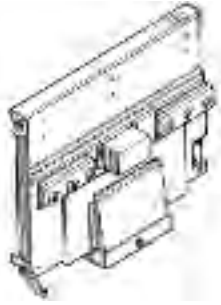

3-1/4" x 10" Duct — External Blower
280 – 1500 CFM

Model No.	Description	Std. Pk.	List Price	Code
30" 283003	Downdraft with stainless steel cover. Designed for use with exterior mounted blowers. 28" wide intake fits most nominal 30" wide cooktops. Transition required to 10" rd. Blower is ordered separately. Select from Models 332H, HLB3, HLB6, HLB9 and HLB11 on Page 37 (332KR not required).	1	\$727.64	DH
273001C	White Cover Only — Optional	1	\$83.62	HA
273002C	■ Bisque Cover Only — Optional	1	\$83.62	HA
273023C	Black Cover Only — Optional	1	\$83.62	HA
36" 283603	● Downdraft with stainless steel cover. Designed for use with exterior mounted blowers. 34" wide intake fits most nominal 36" wide cooktops. Transition required to 10" rd. Blower is ordered separately. Select from Models 332H, HLB3, HLB6, HLB9 and HLB11 on Page 37 (332KR not required).	1	\$727.64	DH
273601C	White Cover Only — Optional	1	\$83.62	HA
273602C	■ Bisque Cover Only — Optional	1	\$83.62	HA
273623C	Black Cover Only — Optional	1	\$83.62	HA

Downdrafts work with make-up dampers (MD6TU, MD8TU and MD10TU) and fresh air inlets (641FA, 643FA and 610FA) — see accessories on Page 5.

■ Limited quantities available.

Range Hoods — Power Packs

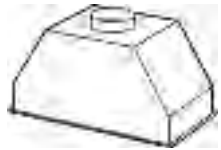

6" Round Duct — Internal Blower
400 CFM, 9.0 Sones
8" Round Duct — External Blower
280 – 1500 CFM

Broan® Elite RMP Series Custom Power Pack

The Rangemaster Custom Power Pack is designed to fit flush with the bottom of a cabinet or custom hood (see "RML" Liner — Page 32). The interior or exterior blowers are combined with multi-speed control with Heat Sentry™ to provide quiet and effective performance. Halogen lighting complements the beauty of a fully enclosed bottom containing dishwasher-safe filters. Optional non-ducted filters (FILTEREB40) for indoor exhaust recirculation. Some ductwork required.

Model No.	Description	Std. Pk.	List Price	Code
RMP17004	Power Pack	1	\$1,075.46	DH
RMPE7004	Power Pack for External Blower. Blowlers are ordered separately. Select from Models 331H, 332H, 335, 336, HLB3, HLB6, HLB9 and HLB11 on Page 37.	1	\$764.12	DH
FILTEREB40	Replacement Non-ducted Charcoal Filter (for RMP17004 and RM50000)	1	\$93.42	HA
GU10	Halogen Bulb; 120V, 50W max.	10 *	\$17.06	AC
ARP6	CFM Reducer Kit. Reduces CFM to less than 300 CFM, 6" round.	5 *	\$49.18	AC

Range hoods work with make-up dampers (MD6TU, MD8TU and MD10TU) and fresh air inlets (641FA, 643FA and 610FA) — see accessories on Page 5.

Broan® Elite RMIP Series Pro-Style Insert

Pro-style insert fits flush with the bottom of the cabinet or custom hood. Internal and external centrifugal blowers from 280 to 1500 CFM with Multi-speed control and Heat Sentry™ to provide quiet and effective performance. Halogen Lighting (bulbs not included) for brilliant illumination and easy-to-clean fully enclosed design. Options include baffle filters and remote wall control.

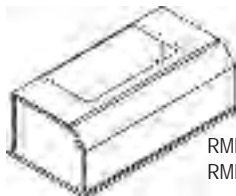

RMP33
RMP45
3-1/4" x 10" Duct — Internal Blower
460 CFM, 10.5 Sones
3-1/4" x 14" Duct — External Blower
850 CFM, 10.5 Sones
10" Round Duct — External Blower
280 – 1500 CFM



RMP1WC

Model No.	Description	Std. Pk.	List Price	Code
RMP33	Pro-Style Insert (blower sold separately), 33" Stainless, Micro Filters; for use with P5, P8, 331H, 332H, 335, 336, HLB3, HLB6, HLB9 and HLB11 on Page 37	1	\$776.58	DH
RMIP45	● Pro-Style Insert (blower sold separately), 45", Stainless, Micro Filters; for use with P5, P8, 331H, 332H, 335, 336, HLB3, HLB6, HLB9 and HLB11 on Page 37	1	\$855.82	DH
RMP1WC	Wall-Mounted Remote Control for RMIP Series, Stainless	1	\$138.68	HA
RBFIP33	Baffle Filter Kit for RMP33, Stainless	1	\$220.72	AC
RBFIP45	Baffle Filter Kit for RMIP45, Stainless	1	\$272.22	AC
PAR20	Halogen Bulb; 120V, 50W	6 *	\$23.20	AC
ARP310	CFM Reducer Kit. Reduces CFM to less than 300 CFM when used with P5 blower, 3-1/4" x 10".	5 *	\$49.18	AC

Range hoods work with make-up dampers (MD6TU, MD8TU and MD10TU) and fresh air inlets (641FA, 643FA and 610FA) — see accessories on Page 5.

- Item too large to ship via UPS/FedEx. Item shipped common carrier at minimum rates.
- * All pricing reflects the individual item cost. You must order in multiples as indicated.
- ◆ UL listed for use over bathtubs and showers when connected to a GFCI protected branch circuit.

Range Hoods — Power Packs

Broan® Elite RML Series Liners for Inserts and Power Packs

Liners feature an adjustable nose that moves 3" to provide application flexibility and a 4" depth for excellent capture.



Model No.	Description	Std. Pk.	List Price	Code
RML3336S	Liner for RMP33 — 36", Stainless (Adj. depth 22.5" - 25.5")	1	\$313.80	HA
RML3342S	Liner for RMP33 — 42", Stainless (Adj. depth 22.5" - 25.5")	1	\$321.10	HA
RML4548S	Liner for RMP45 — 48", Stainless (Adj. depth 22.5" - 25.5")	1	\$339.30	HA
RML4554S	● Liner for RMP45 — 54", Stainless (Adj. depth 22.5" - 25.5")	1	\$370.88	HA
RML4560S	● Liner for RMP45 — 60", Stainless (Adj. depth 22.5" - 25.5")	1	\$375.96	HA
RML7030L	Liner for RMP1-E — 30", Stainless (Adj. depth 20.5" - 23.5")	1	\$284.22	HA
RML7030S	Liner for RMP1-E — 30", Stainless (Adj. depth 17.5" - 20.5")	1	\$265.92	HA
RML7036L	Liner for RMP1-E — 36", Stainless (Adj. depth 20.5" - 23.5")	1	\$321.10	HA
RML7036S	Liner for RMP1-E — 36", Stainless (Adj. depth 17.5" - 20.5")	1	\$313.80	HA
RML7048L	Liner for RMP1-E — 48", Stainless (Adj. depth 20.5" - 23.5")	1	\$393.44	HA
RML7048S	Liner for RMP1-E — 48", Stainless (Adj. depth 17.5" - 20.5")	1	\$339.30	HA

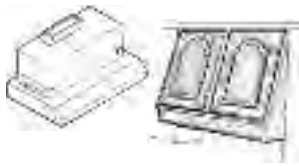

Broan® 10000 Series Custom Hood Kit

Model 103023 fits wood hoods from 30" to 42" wide. Comes standard for 30" installation. Order Extension Kit No. 97009790 for installations up to 36". 42" requires some fabrication. Requires 16-1/2" minimum vertical clearance inside hood. Must use Model 103123 Rough-In Kit below.

Model No.	Description	Std. Pk.	List Price	Code
103023	■ ● Wood Hood Insert	1	\$512.70	DH
103123	■ Wood Hood Insert Rough-In Kit (Required)	1	\$64.98	DH

3-1/4" x 10" Duct — Internal Blower
 360 CFM — 4.5 Sones Vertical
 360 CFM — 4.5 Sones Horizontal

For replacement filters, see Broan's Replacement Parts Guide.

Range hoods work with make-up dampers (MD6TU, MD8TU and MD10TU) and fresh air inlets (641FA, 643FA and 610FA) — see accessories on Page 5.

■ Limited quantities available.

Broan® PM500SS Power Pack

This power pack is designed to fit flush to custom cabinet/hood or can be used with optional liners to protect cabinetry.

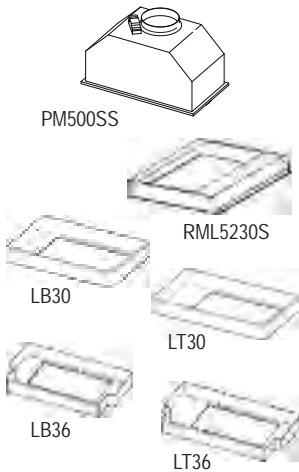

Model No.	Description	Std. Pk.	List Price	Code
PM500SS	Stainless Steel Power Pack, 20-1/2", 500 CFM	1	\$762.20	DH
<u>Liners</u>				
RML5230S	30" Stainless Adjustable Liner (Adjustable depth 17-1/2" to 20-1/2")	1	\$265.92	HA
LT30	30" Painted Liner	1	\$99.56	HA
LT36	36" Painted Liner	1	\$110.18	HA
LB30	30" Painted Liner	1	\$99.56	HA
LB36	36" Painted Liner	1	\$110.18	HA
<u>Non-ducted Recirculation</u>				
359NDK	Non-duct Accessory Kit for PM500 (99010374 - Replacement charcoal filter)	1	\$140.68	AC

Model PM500SS works with make-up air dampers (MD6TU, MD8TU and MD10TU) and fresh air inlets (641FA, 643FA and 610FA) — see accessories on Page 5.

- Item too large to ship via UPS/FedEx. Item shipped common carrier at minimum rates.
- * All pricing reflects the individual item cost. You must order in multiples as indicated.
- ◆ UL listed for use over bathtubs and showers when connected to a GFCI protected branch circuit.

Range Hoods — Power Packs

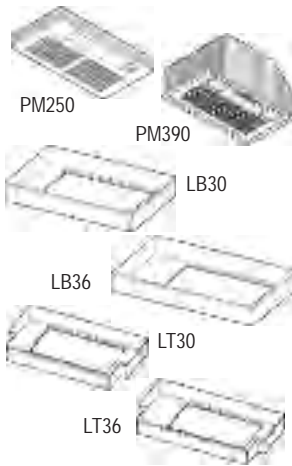

PM250 7" Round Duct — Internal Blower 250 CFM — 8.0 Sones
 PM390 6" Round Duct — Internal Blower 390 CFM — 6.0 Sones

Broan® PM Series Flush-Fit Power Packs

Flush-fitting integrated power packs and liners provide modern style, ventilation, dual 40 watt lighting (bulbs sold separately) and protection for custom cabinet and hood applications. The PM390 has a 390 CFM internal blower and features a three-speed slide control with Heat Sentry™. The PM250 has a 250 CFM two-speed fan with rocker switch control. Both units are designed to work with optional LT or LB liners.

Model No.	Description	Std. Pk.	List Price	Code
PM250	Power Pack, Silver Grille	1	\$193.60	RH
PM390	Power Pack, Silver Grille	1	\$436.20	RH
356NDK +	Non-duct Accessory Kit for PM250	1	\$114.86	HA
357NDK +	Non-duct Accessory Kit for PM390	1	\$140.68	HA
LB30 +	Liner 30N, Box Shape, for PM250, PM390 and PME300	1	\$99.56	HA
LB36 +	Liner 36N, Box Shape, for PM250, PM390 and PME300	1	\$110.18	HA
LT30 +	Liner 30N, T Shape, for PM250, PM390 and PME300	1	\$99.56	HA
LT36 +	Liner 36N, T Shape, for PM250, PM390 and PME300	1	\$110.18	HA
ARP6 +	CFM Reducer Kit. Reduces CFM to less than 300 CFM, 6" round.	5 *	\$49.18	AC

+ Purchase separately.

Model PM390 works with make-up air dampers (MD6TU, MD8TU and MD10TU) and fresh air inlets (641FA, 643FA and 610FA) — see accessories on Page 5.

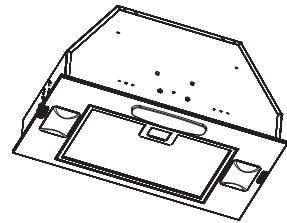

6" Round Duct — Internal Blower
 High — 290 CFM, 5.0 Sones
 Normal — 130 CFM, 0.5 Sones

Broan® PME300 Series Flush Fit Power Pack (ENERGY STAR®)

The PME Series model is part of our new ENERGY STAR® hood offering and an extension of our PM390 power pack line. Designed to provide energy efficient operation with a very quiet 290 CFM centrifugal blower. Features include 3-speed slide control, Heat Sentry™, dual 13 watt fluorescent light and a dishwasher-safe filter.

Model No.	Description	Std. Pk.	List Price	Code
PME300	Power Pack, Silver	1	\$606.84	RH
LB30 +	Liner 30N, Box Shape, for PM250, PM390 and PME300	1	\$99.56	HA
LB36 +	Liner 36N, Box Shape, for PM250, PM390 and PME300	1	\$110.18	HA
LT30 +	Liner 30N, T Shape, for PM250, PM390 and PME300	1	\$99.56	HA
LT36 +	Liner 36N, T Shape, for PM250, PM390 and PME300	1	\$110.18	HA

+ Purchase separately.

- Item too large to ship via UPS/FedEx. Item shipped common carrier at minimum rates.
- * All pricing reflects the individual item cost. You must order in multiples as indicated.
- ◆ UL listed for use over bathtubs and showers when connected to a GFCI protected branch circuit.

Range Hoods — High Performance

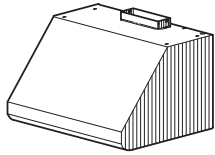

3-1/4" x 10" Duct — Internal Blower
600 CFM, 1.5 Sones
4-1/2" x 18" Duct — Internal Blower
1200 CFM, 2.0 Sones
10" Round Duct — External Blower
280 – 1500 CFM

Pro-Style Hoods — E60000 Series

The E60000 Series has a choice of two internal blowers or eight external blower options. Features include bright halogen lighting, dishwasher-safe baffle filters with a removable grease rail, variable speed control and Heat Sentry™. Options include a soffit flue, backsplash and non-duct recirculation. It is also compatible with Broan make-up air dampers. (Requires 50 watt max. halogen bulbs, not included; two in 30" and 36" — three in 42" and 48" widths.) Duct horizontal or vertical.

Model No.	Description	Std. Pk.	List Price	Code
<u>Internal Blower</u>				
30" E6030SS ●	Stainless Shell	1	\$1,907.64	DH
36" E6036SS ●	Stainless Shell	1	\$1,983.58	DH
42" E6042TSS ●	Stainless Shell	1	\$2,332.70	DH
48" E6048TSS ●	Stainless Shell	1	\$2,409.66	DH
<u>External Blower</u>				
30" E60E30SS ●	Stainless Shell	1	\$1,616.48	DH
36" E60E36SS ●	Stainless Shell	1	\$1,709.88	DH
42" E60E42SS ●	Stainless Shell	1	\$1,754.42	DH
48" E60E48SS ●	Stainless Shell	1	\$1,842.56	DH
AEE60302SS	12" High Soffit, 30" Hood	1	\$299.76	HA
AEE60362SS	12" High Soffit, 36" Hood	1	\$311.34	HA
AEE60422SS ●	12" High Soffit, 42" Hood	1	\$322.98	HA
AEE60482SS ●	12" High Soffit, 48" Hood	1	\$334.62	HA
ANKE60302SS	Non-Duct Recirculation Kit, 30" Hood	1	\$346.48	HA
ANKE60362SS	Non-Duct Recirculation Kit, 36" Hood	1	\$358.98	HA
ANKE60422SS	Non-Duct Recirculation Kit, 42" Hood	1	\$448.02	HA
ANKE60482SS	Non-Duct Recirculation Kit, 48" Hood	1	\$453.52	HA
ARP310	CFM Reducer Kit, reduces CFM to less than 300 CFM, 3-1/4" x 10"	5 *	\$49.18	AC
GU10	Halogen Bulb; 120V, 50W max.	10 *	\$17.06	AC
MD6T ∅	6" Automatic Make-Up Air Damper	1	\$174.86	HA
MD8T ∅	8" Automatic Make-Up Air Damper	1	\$188.30	HA
MD10T ∅	10" Automatic Make-Up Air Damper	1	\$307.66	HA

∅ Work with fresh air inlets (641FA, 643FA and 610FA) — see accessories on Page 5.

- Item too large to ship via UPS/FedEx. Item shipped common carrier at minimum rates.
- * All pricing reflects the individual item cost. You must order in multiples as indicated.
- ◆ UL listed for use over bathtubs and showers when connected to a GFCI protected branch circuit.

Range Hoods — High Performance

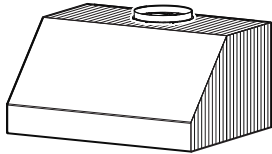

10" Round Duct — Internal Blower
1100 CFM — 12.0 Sones Vertical

Broan® Elite Pro Outdoor Hood — EPD61 Series

The Pro Outdoor is made of corrosion resistant stainless steel and provides an extra deep 27" design, giving it improved performance and best-in-class capture! It includes a powerful 1100 CFM internal blower for more exhaust capacity, yet quiet operation. An optional 3" wall extension provides a full 30" of cook top coverage for a larger capture area. Requires 50 watt halogen bulbs (not included); two in 36" and three in 48".

Model No.	Description	Std. Pk.	List Price	Code
36" EPD6136SS ●	Professional Grade Brushed Stainless Steel Range Hood	1	\$2,440.08	OH
48" EPD6148SS ●	Professional Grade Brushed Stainless Steel Range Hood	1	\$2,758.34	OH
60" EPD6160SS ●	Professional Grade Brushed Stainless Steel Range Hood	1	\$3,639.00	OH
AWEPD36SS	3" Wall extension for 36" range hood (provides 30" depth)	1	\$387.24	OH
AWEPD48SS	3" Wall extension for 48" range hood (provides 30" depth)	1	\$437.10	OH
AWEPD60SS	3" Wall extension for 60" range hood (provides 30" depth)	1	\$469.00	OH
AEEP6SS	6" Flue cover for 8' ceiling (for standard 27" depth hood)	1	\$182.48	OH
AEEP6SSE	6" Flue cover for 8' ceiling (for extended 30" depth hood)	1	\$199.44	OH
AEEP18SS	18" Flue cover for 9' ceiling (for standard 27" depth hood)	1	\$318.28	OH
AEEP18SSE	18" Flue cover for 9' ceiling (for extended 30" depth hood)	1	\$335.24	OH
AEEP30SS	30" Flue cover for 10' ceiling (for standard 27" depth hood)	1	\$420.12	OH
AEEP30SSE	30" Flue cover for 10' ceiling (for extended 30" depth hood)	1	\$437.10	OH
AEEP2445SS	Professional Grade Brushed Stainless Steel Flue Extension, standard 13" depth and height adjustable from 24" to 45"	1	\$843.42	OH
AEEP2445SSE	Professional Grade Brushed Stainless Steel Flue Extension, extended 16" depth and height adjustable from 24" to 45"	1	\$875.26	OH
GU10	Halogen Bulb; 120V, 50W max.	10 *	\$17.06	AC

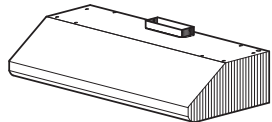

3-1/4" x 10" Duct — Internal Blower
600 CFM, 1.5 Sones
4-1/2" x 18" Duct — Internal Blower
1200 CFM, 2.0 Sones
10" Round Duct — External Blower
280 – 1200 CFM

Pro-Style Hoods — E64000 Series

The E64000 Series has a choice of two internal blowers or eight external blower options. Features include bright halogen lighting, dishwasher-safe baffle filters with a removable grease rail, variable speed control and Heat Sentry™. Options include a soffit flue, backsplash and non-duct recirculation. It is also compatible with Broan make-up air dampers. (Requires 50 watt max. halogen bulbs, not included; two in 30" and 36" — three in 42" and 48" widths.) Duct horizontal or vertical.

Model No.	Description	Std. Pk.	List Price	Code
<u>Internal Blower</u>				
30" E6430SS	Stainless Shell	1	\$1,268.42	DH
36" E6436SS	Stainless Shell	1	\$1,295.24	DH
42" E6442SS ●	Stainless Shell	1	\$1,393.08	DH
48" E6448SS ●	Stainless Shell	1	\$1,449.34	DH
E6448TSS ●	Stainless Shell	1	\$1,717.36	DH
<u>External Blower</u>				
30" E64E30SS	Stainless Shell	1	\$1,027.70	DH
36" E64E36SS	Stainless Shell	1	\$1,078.44	DH
42" E64E42SS ●	Stainless Shell	1	\$1,181.82	DH
48" E64E48SS ●	Stainless Shell	1	\$1,246.02	DH
ANKE60302SS	Non-Duct Recirculation Kit, 30" Hood	1	\$346.48	HA
ANKE60362SS	Non-Duct Recirculation Kit, 36" Hood	1	\$358.98	HA
ANKE60422SS	Non-Duct Recirculation Kit, 42" Hood	1	\$448.02	HA
ANKE60482SS	Non-Duct Recirculation Kit, 48" Hood	1	\$453.52	HA
ARP310	CFM Reducer Kit, reduces CFM to less than 300 CFM, 3-1/4" x 10"	5 *	\$49.18	AC
GU10	Halogen Bulb; 120V, 50W max.	10 *	\$17.06	AC
MD6T ∅	6" Automatic Make-Up Air Damper	1	\$174.86	HA
MD8T ∅	8" Automatic Make-Up Air Damper	1	\$188.30	HA
MD10T ∅	10" Automatic Make-Up Air Damper	1	\$307.66	HA

∅ Work with fresh air inlets (641FA, 643FA and 610FA) — see accessories on Page 5.

- Item too large to ship via UPS/FedEx. Item shipped common carrier at minimum rates.
- * All pricing reflects the individual item cost. You must order in multiples as indicated.
- ◆ UL listed for use over bathtubs and showers when connected to a GFCI protected branch circuit.

Range Hoods — High Performance

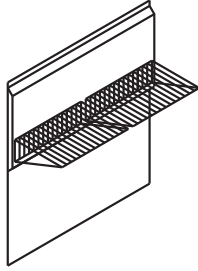

Broan® RMP Series Backsplash

Professional style backsplash with folding storage racks.

Model No.	Description	Std. Pk.	List Price	Code
30" RMP3004	Stainless Steel Backsplash	1	\$537.06	HA
36" RMP3604	Stainless Steel Backsplash	1	\$574.82	HA
42" RMP4204	Stainless Steel Backsplash	1	\$612.48	HA
48" RMP4804	Stainless Steel Backsplash	1	\$650.20	HA
54" RMP5404 ●	Stainless Steel Backsplash	1	\$688.00	HA
60" RMP6004 ●	Stainless Steel Backsplash	1	\$725.66	HA



Broan® Elite E661 Series

The E661 Series models are part of our new generation of range hoods; stylish, powerful and most of all, quieter than ever. Designed for high performance cooking applications, a sleek under-cabinet hood with ultra quiet internal 600 CFM blower. Features include multi-speed electronic controls with Heat Sentry™, three-level dual halogen lighting (bulbs included) and large professional style dishwasher-safe mesh filters.

Model No.	Description	Std. Pk.	List Price	Code
30" E66130BL ■	Black Range Hood	1	\$1,131.78	RH
E66130SS ■	Stainless Steel Range Hood	1	\$1,215.28	RH
E66130WH ■	White Range Hood	1	\$1,131.78	RH
36" E66136BL ■	Black Range Hood	1	\$1,167.52	RH
E66136SS ■	Stainless Steel Range Hood	1	\$1,253.66	RH
E66136WH ■	White Range Hood	1	\$1,167.52	RH
42" E66142SS ■	Stainless Steel Range Hood	1	\$1,293.20	RH
GU10	Halogen Bulb; 120V, 50W max.	10 *	\$17.06	AC
T460	Transition; 3-1/4" x 14" to 7" Round	1	\$34.90	AC
T461	Adapter; 3-1/4" x 14" to 3-1/4" x 10"	1	\$45.24	AC
WC638	Wall Cap, 3-1/4" x 14", Black	1	\$95.00	AC
ARP314	CFM Reducer Kit. Reduces CFM to less than 300 CFM, 3-1/4" x 14".	5 *	\$49.18	AC

3-1/4" x 14" Duct — Internal Blower
 Horizontal: Normal (low) —
 130 CFM, 0.3 Sones High —
 310 CFM, 2.5 Sones Boost —
 600 CFM, 8.5 Sones

Vertical: Normal (low) —
 120 CFM, 0.4 Sones High —
 290 CFM, 2.5 Sones Boost —
 550 CFM, 8.5 Sones

Range hoods work with make-up dampers (MD6TU, MD8TU and MD10TU) and fresh air inlets (641FA, 643FA and 610FA) — see accessories on Page 5.

■ Limited quantities available.

- Item too large to ship via UPS/FedEx. Item shipped common carrier at minimum rates.
- * All pricing reflects the individual item cost. You must order in multiples as indicated.
- ◆ UL listed for use over bathtubs and showers when connected to a GFCI protected branch circuit.

Broan® Elite Internal and External Mounted Blowers

Broan internal and external blowers are specially designed to provide powerful, but quiet kitchen ventilation solutions to meet the unique needs of any application.

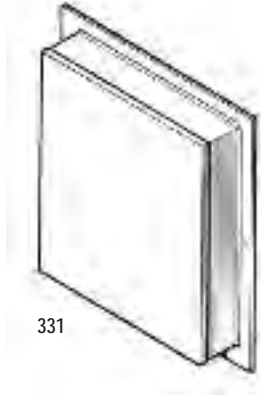

331

Model No.	Description	Std. Pk.	List Price	Code
P5	500 CFM Blower for interior mounting for RMIP insert. 3-1/4" x 10" duct size at discharge. 120V / 60 Hz.	1	\$504.92	RH
P8	850 CFM Blower for interior mounting for RMIP insert. 3-1/4" x 14" duct size at discharge. 120V / 60 Hz. Fits only in 36", 42" and 48" range hoods.	1	\$920.68	RH
331H	+ 600 CFM Exterior Blower — 2.3 amps. Fits 10" round duct.	1	\$643.02	DH
332H	+ 900 CFM Exterior Blower — 5.7 amps. Fits 10" round duct.	1	\$835.62	DH
335	+ 1200 CFM Blower for exterior blower. 3.0 total amps. 10" round duct at discharge. 120V.	1	\$1,113.90	DH
336	+ 1500 CFM Blower for exterior blower. 3.8 total amps. 10" round duct at discharge. 120V.	1	\$1,390.56	DH
HLB3	+ 280 CFM In-Line Blower	1	\$424.78	DH
HLB6	+ 600 CFM In-Line Blower	1	\$716.78	DH
HLB9	●+ 800 CFM In-Line Blower	1	\$961.04	DH
HLB11	●+ 1100 CFM In-Line Blower	1	\$1,146.88	DH
332KR	Rough-in Kit for Models 331H, 332H, 335 and 336 exterior blowers and HLB3, HLB6, HLB9 and HLB11 in-line blowers. Fits 10" round duct. Only for use with RMIP insert.	1	\$110.28	HA
72V / 72W	Electronic Variable Speed Control, 6 amp capacity. 120V. Fits single gang box. Suitable for use with 331H, 332H, 335, 336, HLB3, HLB6, HLB9 and HLB11.	1	\$84.92	AC

+ The 332KR will be required if external blower is used with RMIP models.

Note: Broan internal and external blowers are designed and UL listed for use with Broan products only. Use with other manufacturers' products can not be recommended and may result in violation of local electrical codes or practices.

- Item too large to ship via UPS/FedEx. Item shipped common carrier at minimum rates.
- * All pricing reflects the individual item cost. You must order in multiples as indicated.
- ◆ UL listed for use over bathtubs and showers when connected to a GFCI protected branch circuit.

Range Hoods — Under Cabinet

Broan® EVOLUTION™ QP4 Series

EVOLUTION 4 is the ultimate in under-cabinet designs. It is the high performance solution, delivering up to 630 CFM, to complement higher BTU appliances and special cooking needs. Advanced, soft-touch controls include an ambient light sensor and sleep mode. Four 50-watt max. halogen bulbs are included.

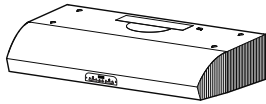

3-1/4" x 14" Duct — Internal Blower
430 CFM, 4.5 Sones Vertical
470 CFM, 4.5 Sones Horizontal
7" Round Duct — Internal Blower
360 CFM, 4.5 Sones
630 CFM, 7.5 Sones
(Boost Mode)

Requires (4) 50 watt GU10 MR16 bulbs (included).

Model No.	Description	Std. Pk.	List Price	Code
30" QP430SS ■	Stainless Steel Range Hood	1	\$960.24	QP
36" QP436SS ■	Stainless Steel Range Hood	1	\$974.90	QP
42" QP442SS ■	Stainless Steel Range Hood	1	\$987.38	QP
BPP3FA30 ■	Replacement Filter	1	\$71.60	QA
BPP3FA36 ■	Replacement Filter	1	\$82.96	QA
BPP3FA42 ■	Replacement Filter	1	\$100.00	QA
BCR1	RF remote control	1	\$88.64	QA
BP87 ■	7" Damper for round discharge range hood. (S97010792 — Single Pack)	3 *	\$11.46	AC
GU10	Halogen Bulb; 120V, 50W max.	10 *	\$17.06	AC
MD6T ∅	6" Automatic Make-Up Air Damper	1	\$174.86	HA
MD8T ∅	8" Automatic Make-Up Air Damper	1	\$188.30	HA
MD10T ∅	10" Automatic Make-Up Air Damper	1	\$307.66	HA
T460	Transition; 3-1/4" x 14" to 7" Round	1	\$34.90	AC
T461	Adapter; 3-1/4" x 14" to 3-1/4" x 10"	1 *	\$45.24	AC
WC638	Wall Cap, 3-1/4" x 14", Black	1	\$95.00	AC

∅ Work with fresh air inlets (641FA, 643FA and 610FA) — see accessories on Page 5.

■ Limited quantities available.

Broan® EVOLUTION™ QP3 Series

EVOLUTION 3 provides ultra quiet operation and a very powerful 450 CFM boost mode. Advanced, soft-touch controls include an ambient light sensor and sleep mode. Four 50-watt max. halogen bulbs are included.

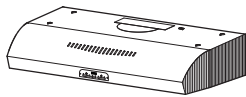

3-1/4" x 10" Duct — Internal Blower
320 CFM, 5.5 Sones Vertical
360 CFM, 5.0 Sones Horizontal
7" Round Duct — Internal Blower
300 CFM, 5.5 Sones
450 CFM, 7.0 Sones
(Boost Mode)

Converts to non-ducted. Add non-ducted filter (available separately).

Requires (4) 50 watt GU10 MR16 bulbs (included).

Model No.	Description	Std. Pk.	List Price	Code
30" QP330BL ■	Black-on-Black Range Hood	1	\$714.84	QP
QP330SS ■	Stainless Steel Range Hood	1	\$776.18	QP
QP330WW ■	White-on-White Range Hood	1	\$714.84	QP
36" QP336BL ■	Black-on-Black Range Hood	1	\$728.46	QP
QP336SS ■	Stainless Steel Range Hood	1	\$789.84	QP
QP336WW ■	White-on-White Range Hood	1	\$728.46	QP
42" QP342BL ■	Black-on-Black Range Hood	1	\$740.96	QP
QP342SS ■	Stainless Steel Range Hood	1	\$802.30	QP
QP342WW ■	White-on-White Range Hood	1	\$740.96	QP
BPPF30	Non-duct Filters for QP130, QP230 and QP330	6 *	\$29.82	QA
BPPF36	Non-duct Filters for QP136, QP236 and QP336	3 *	\$32.24	QA
BPPF42	Non-duct Filters for QP142, QP242 and QP342	1	\$38.92	QA
BPP3FA30	Replacement QP330 aluminum grease filter	1	\$71.60	QA
BPP3FA36	Replacement QP336 aluminum grease filter	1	\$82.96	QA
BPP3FA42	Replacement QP342 aluminum grease filter	1	\$100.00	QA
BCR1	RF remote control	1	\$88.64	QA
BP87 ■	7" Damper for round discharge range hood. (S97010792 — Single Pack)	3 *	\$11.46	AC
GU10	Halogen Bulb; 120V, 50W max.	10 *	\$17.06	AC
MD6T ∅	6" Automatic Make-Up Air Damper	1	\$174.86	HA
MD8T ∅	8" Automatic Make-Up Air Damper	1	\$188.30	HA
MD10T ∅	10" Automatic Make-Up Air Damper	1	\$307.66	HA

∅ Work with fresh air inlets (641FA, 643FA and 610FA) — see accessories on Page 5.

■ Limited quantities available.

- Item too large to ship via UPS/FedEx. Item shipped common carrier at minimum rates.
- * All pricing reflects the individual item cost. You must order in multiples as indicated.
- ◆ UL listed for use over bathtubs and showers when connected to a GFCI protected branch circuit.

Range Hoods — Under Cabinet

Broan® EVOLUTION™ QP2 Series

EVOLUTION 2 has the control, power and easy-to-clean features every cook loves. Very quiet operation with a 350 CFM boost mode, the QP2 four 50-watt max. halogen bulbs (included) and a soft-touch three-speed control panel.

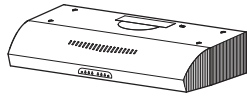

3-1/4" x 10" Duct — Internal Blower
310 CFM, 6.0 Sones Vertical
350 CFM, 5.0 Sones Horizontal
7" Round Duct — Internal Blower
280 CFM, 6.0 Sones
Requires (4) 50 watt GU10 MR16
bulbs (included).

Model No.	Description	Std. Pk.	List Price	Code
30" QP230BC ■	Bisque-on-Bisque Range Hood	1	\$529.58	QP
QP230BL ■	Black-on-Black Range Hood	1	\$529.58	QP
QP230SS ■	Stainless Steel Range Hood	1	\$589.82	QP
QP230WW ■	White-on-White Range Hood	1	\$529.58	QP
36" QP236BC ■	Bisque-on-Bisque Range Hood	1	\$542.08	QP
QP236BL ■	Black-on-Black Range Hood	1	\$542.08	QP
QP236SS ■	Stainless Steel Range Hood	1	\$602.32	QP
QP236WW ■	White-on-White Range Hood	1	\$542.08	QP
42" QP242BC ■	Bisque-on-Bisque Range Hood	1	\$555.72	QP
QP242BL ■	Black-on-Black Range Hood	1	\$555.72	QP
QP242SS ■	Stainless Steel Range Hood	1	\$615.96	QP
QP242WW ■	White-on-White Range Hood	1	\$555.72	QP
BPPF30	Non-duct Filters for QP130, QP230 and QP330	6 *	\$29.82	QA
BPPF36	Non-duct Filters for QP136, QP236 and QP336	3 *	\$32.24	QA
BPPF42	Non-duct Filters for QP142, QP242 and QP342	1	\$38.92	QA
BPP2FA30	Replacement QP230 aluminum grease filter	1	\$56.82	QA
BPP2FA36	Replacement QP236 aluminum grease filter	1	\$68.18	QA
BPP2FA42	Replacement QP242 aluminum grease filter	1	\$85.26	QA
BP87 ■	7" Damper for round discharge range hood. (S97010792 — Single Pack)	3 *	\$11.46	AC
GU10	Halogen Bulb; 120V, 50W max.	10 *	\$17.06	AC

■ Limited quantities available.

Range hoods work with make-up dampers (MD6TU, MD8TU and MD10TU) and fresh air inlets (641FA, 643FA and 610FA) — see accessories on Page 5.

Broan® EVOLUTION™ QP1 Series

EVOLUTION 1 has the same great basic features of the QP2, with a 300 CFM boost mode and a two-speed control for blowers and lighting. Four 35-watt halogen bulbs (not included) light the cooktop.

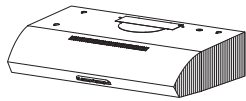

3-1/4" x 10" Duct — Internal Blower
280 CFM, 5.0 Sones Vertical
300 CFM, 5.0 Sones Horizontal
7" Round Duct — Internal Blower
260 CFM, 5.5 Sones
Converts to non-ducted. Add non-ducted filter (available separately).
Requires (4) 35 watt GU10 MR16
bulbs (purchase separately).

Model No.	Description	Std. Pk.	List Price	Code
30" QP130BL ■	Black-on-Black Range Hood	1	\$348.44	QP
QP130SS ■	Stainless Steel Range Hood	1	\$405.72	QP
QP130WW ■	White-on-White Range Hood	1	\$348.44	QP
36" QP136BL ■	Black-on-Black Range Hood	1	\$361.56	QP
QP136SS ■	Stainless Steel Range Hood	1	\$418.84	QP
QP136WW ■	White-on-White Range Hood	1	\$361.56	QP
42" QP142BL ■	Black-on-Black Range Hood	1	\$392.90	QP
QP142SS ■	Stainless Steel Range Hood	1	\$453.86	QP
QP142WW ■	White-on-White Range Hood	1	\$392.90	QP
BPPF30	Non-duct Filters for QP130, QP230 and QP330	6 *	\$29.82	QA
BPPF36	Non-duct Filters for QP136, QP236 and QP336	3 *	\$32.24	QA
BPPF42	Non-duct Filters for QP142, QP242 and QP342	1	\$38.92	QA
BPPFA30	Replacement QP130 aluminum grease filters	3 *	\$53.70	QA
BPPFA36	Replacement QP136 aluminum grease filters	3 *	\$60.86	QA
BPPFA42	Replacement QP142 aluminum grease filter	1	\$68.18	QA
BP87 ■	7" Damper for round discharge range hood. (S97010792 — Single Pack)	3 *	\$11.46	AC
GU1035	Halogen Bulb; 120V, 35W	10 *	\$15.92	AC

■ Limited quantities available.

- Item too large to ship via UPS/FedEx. Item shipped common carrier at minimum rates.
- * All pricing reflects the individual item cost. You must order in multiples as indicated.
- ◆ UL listed for use over bathtubs and showers when connected to a GFCI protected branch circuit.

Range Hoods — Under Cabinet

Broan® QS3 Series ALLURE III

The popular QS3 Series range hood provides an ultra quiet, extra powerful 430 CFM boost mode. Easy-to-clean bottom pan and filters with three-level lighting and Advanced Heat Sentry™. Optional non-duct operation. Works with optional make-up air dampers.



3-1/4" x 10" Duct — Internal Blower
280 CFM — 5.5 Sones Vertical
300 CFM — 4.5 Sones Horizontal
7" Round Duct — Internal Blower
270 CFM — 5.5 Sones Vertical
(Boost Mode) 430 CFM,
8.0 Sones Horizontal

Converts to non-ducted. Add non-ducted filter (available separately).

	Model No.	Description	Std. Pk.	List Price	Code
30"	QS330AA ■	Almond-on-Almond Range Hood	1	\$672.46	AH
	QS330BC ■	Bisque-on-Bisque Range Hood	1	\$672.46	AH
	QS330BL ■	Black Range Hood	1	\$672.46	AH
	QS330SS ■	Stainless Steel Range Hood	1	\$736.12	AH
	QS330WW ■	White-on-White Range Hood	1	\$672.46	AH
36"	QS336AA ■	Almond-on-Almond Range Hood	1	\$686.62	AH
	QS336BC ■	Bisque-on-Bisque Range Hood	1	\$686.62	AH
	QS336BL ■	Black Range Hood	1	\$686.62	AH
	QS336SS ■	Stainless Steel Range Hood	1	\$757.40	AH
	QS336WW ■	White-on-White Range Hood	1	\$686.62	AH
42"	QS342AA ■	Almond-on-Almond Range Hood	1	\$700.76	AH
	QS342BC ■	Bisque-on-Bisque Range Hood	1	\$700.76	AH
	QS342BL ■	Black Range Hood	1	\$700.76	AH
	QS342SS ■	Stainless Steel Range Hood	1	\$778.62	AH
	QS342WW ■	White-on-White Range Hood	1	\$700.76	AH
	BPSF30	Non-ducted Filter for 30" series hoods (S99010308 — Single Pack)	4 *	\$31.52	AC
	BPSF36	Non-ducted Filter for 36" series hoods (S99010309 — Single Pack)	4 *	\$33.70	AC
	BPSF42	Non-ducted Filter for 42" series hoods (S99010310 — Single Pack)	8 *	\$36.22	AC
	BPS3FA30	Aluminum Filter for 30" series hoods (S99010305 — Single Pack)	6 *	\$61.84	AC
	BPS3FA36	Aluminum Filter for 36" series hoods (S99010306 — Single Pack)	6 *	\$69.20	AC
	BP87 ■	7" Damper for round discharge range hood. (S97010792 — Single Pack)	3 *	\$11.46	AC
	PAR20	Halogen Bulb; 120V, 50W	6 *	\$23.20	AC

■ Limited quantities available.

Single packs are higher priced.

For aluminum filter for 42" series hood, order service part S99010307 (2-pack).

Range hoods work with make-up dampers (MD6TU, MD8TU and MD10TU) and fresh air inlets (641FA, 643FA and 610FA) — see accessories on Page 5.

● Item too large to ship via UPS/FedEx. Item shipped common carrier at minimum rates.

* All pricing reflects the individual item cost. You must order in multiples as indicated.

◆ UL listed for use over bathtubs and showers when connected to a GFCI protected branch circuit.

Range Hoods — Under Cabinet

Broan® QS2 Series ALLURE II

Finally, a range hood with all the best features at a reasonable price! The QS2 Series has very quiet operation with a powerful 300 CFM blower. Easy-to-clean bottom pan and filters with three-level lighting and Heat Sentry™. Optional non-duct operation.



3-1/4" x 10" Duct — Internal Blower
280 CFM — 5.5 Sones Vertical
300 CFM — 4.5 Sones Horizontal
7" Round Duct — Internal Blower
280 CFM — 5.0 Sones Vertical
Converts to non-ducted. Add non-ducted filter (available separately).

	Model No.	Description	Std. Pk.	List Price	Code
30"	QS230AA ■	Almond-on-Almond Range Hood	1	\$502.56	AH
	QS230BC ■	Bisque-on-Bisque Range Hood	1	\$502.56	AH
	QS230BL ■	Black Range Hood	1	\$502.56	AH
	QS230SS ■	Stainless Steel Range Hood	1	\$566.26	AH
	QS230WW ■	White-on-White Range Hood	1	\$502.56	AH
36"	QS236AA ■	Almond-on-Almond Range Hood	1	\$520.28	AH
	QS236BC ■	Bisque-on-Bisque Range Hood	1	\$520.28	AH
	QS236BL ■	Black Range Hood	1	\$520.28	AH
	QS236SS ■	Stainless Steel Range Hood	1	\$591.00	AH
	QS236WW ■	White-on-White Range Hood	1	\$520.28	AH
42"	QS242AA ■	Almond-on-Almond Range Hood	1	\$534.40	AH
	QS242BC ■	Bisque-on-Bisque Range Hood	1	\$534.40	AH
	QS242BL ■	Black Range Hood	1	\$534.40	AH
	QS242SS ■	Stainless Steel Range Hood	1	\$612.28	AH
	QS242WW ■	White-on-White Range Hood	1	\$534.40	AH
	BPSF30	Non-ducted Filter for 30" series hoods (S99010308 — Single Pack)	4 *	\$31.52	AC
	BPSF36	Non-ducted Filter for 36" series hoods (S99010309 — Single Pack)	4 *	\$33.70	AC
	BPSF42	Non-ducted Filter for 42" series hoods (S99010310 — Single Pack)	8 *	\$36.22	AC
	BPS2FA30	Aluminum Filter for 30" series hoods (S99010302 — Single Pack)	6 *	\$40.44	AC
	BPS2FA36	Aluminum Filter for 36" series hoods (S99010303 — Single Pack)	6 *	\$44.88	AC
	ARP310	CFM Reducer Kit, reduces CFM to less than 300 CFM, 3-1/4" x 10"	5 *	\$49.18	AC
	BP87 ■	7" Damper for round discharge range hood. (S97010792 — Single Pack)	3 *	\$11.46	AC
	PAR20	Halogen Bulb; 120V, 50W	6 *	\$23.20	AC

■ Limited quantities available.

Single packs are higher priced.

For aluminum filter for 42" series hood, order service part S99010304 (2-pack).

- Item too large to ship via UPS/FedEx. Item shipped common carrier at minimum rates.
- * All pricing reflects the individual item cost. You must order in multiples as indicated.
- ◆ UL listed for use over bathtubs and showers when connected to a GFCI protected branch circuit.

Range Hoods — Under Cabinet

Broan® QS1 Series ALLURE I

The quietest range hood in its category operates quietly and has 220 CFM power at the high setting. Easy cleaning and a two-level light/speed setting make it the perfect choice for the everyday kitchen.



3-1/4" x 10" Duct — Internal Blower
210 CFM — 5.5 Sones Vertical
220 CFM — 5.0 Sones Horizontal
7" Round Duct — Internal Blower
230 CFM — 5.0 Sones Vertical
Converts to non-ducted. Add non-ducted filter (available separately).

	Model No.	Description	Std. Pk.	List Price	Code
30"	QS130AA ■	Almond-on-Almond Range Hood	1	\$283.14	AH
	QS130BC ■	Bisque-on-Bisque Range Hood	1	\$283.14	AH
	QS130BL ■	Black Range Hood	1	\$283.14	AH
	QS130SS ■	Stainless Steel Range Hood	1	\$343.82	AH
	QS130WW ■	White-on-White Range Hood	1	\$283.14	AH
36"	QS136AA ■	Almond-on-Almond Range Hood	1	\$296.62	AH
	QS136BC ■	Bisque-on-Bisque Range Hood	1	\$296.62	AH
	QS136BL ■	Black Range Hood	1	\$296.62	AH
	QS136SS ■	Stainless Steel Range Hood	1	\$364.08	AH
	QS136WW ■	White-on-White Range Hood	1	\$296.62	AH
42"	QS142AA ■	Almond-on-Almond Range Hood	1	\$320.52	AH
	QS142BC ■	Bisque-on-Bisque Range Hood	1	\$320.52	AH
	QS142BL ■	Black Range Hood	1	\$320.52	AH
	QS142SS ■	Stainless Steel Range Hood	1	\$384.26	AH
	QS142WW ■	White-on-White Range Hood	1	\$320.52	AH
	BPSF30	Non-ducted Filter for 30" series hoods (S99010308 — Single Pack)	4 *	\$31.52	AC
	BPSF36	Non-ducted Filter for 36" series hoods (S99010309 — Single Pack)	4 *	\$33.70	AC
	BPSF42	Non-ducted Filter for 42" series hoods (S99010310 — Single Pack)	8 *	\$36.22	AC
	BPS1FA30	Aluminum Filter for 30" series hoods (S99010299 — Single Pack)	3 *	\$27.60	AC
	BPS1FA36	Aluminum Filter for 36" series hoods (S99010300 — Single Pack)	3 *	\$30.22	AC
	BP87 ■	7" Damper for round discharge range hood. (S97010792 — Single Pack)	3 *	\$11.46	AC
	PAR20	Halogen Bulb; 120V, 50W	6 *	\$23.20	AC

■ Limited quantities available.

Single packs are higher priced.

For aluminum filter for 42" series hood, order service part S99010301 (2-pack).

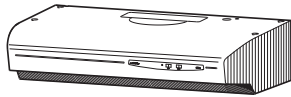

3-1/4" x 10" Duct — Internal Blower
210 CFM, 5.0 Sones — High
110 CFM, 1.5 Sones — Normal
7" Round Duct — Internal Blower
210 CFM, 1.5 Sones
Includes one compact fluorescent
4 watt night light bulb.

QSE Series (ENERGY STAR)

The QSE Series models are part of our new ENERGY STAR hood offering and an extension of our popular Allure, America's contemporary style choice. Designed to provide energy efficient operation with a quiet 210 CFM axial blade blower. Features include convenient two-speed rocker control, two levels of lighting and dishwasher-safe filters.

	Model No.	Description	Std. Pk.	List Price	Code
30"	QSE130SS ■	Stainless Range Hood	1	\$430.30	AH
	QSE130BL ■	Black Range Hood	1	\$375.12	AH
	QSE130WW ■	White Range Hood	1	\$375.12	AH
	BPS1FA30	Aluminum filter for 30" Series hoods	3 *	\$27.60	AC
	BP87 ■	7" Damper for round discharge range hood. (S97010792 — Single Pack)	3 *	\$11.46	AC

■ Limited quantities available.

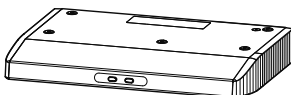

3-1/4" x 10" Duct — Internal Blower
290 CFM, 5.5 Sones — High
100 CFM, 0.9 Sones — Low

QDE Series (ENERGY STAR)

A sleek, contemporary styled range hood with high-performance, 290 CFM capability and ENERGY STAR qualification. Features include energy efficient dual 13-watt lamps (included), 2-speed control, fully enclosed bottom pan for easy cleaning and dishwasher-safe filters.

	Model No.	Description	Std. Pk.	List Price	Code
30"	QDE30WW ■	White-on-White Range Hood	1	\$708.50	RH
	QDE30SS ■	Stainless Steel Range Hood	1	\$743.34	RH
	BPQDE30	Aluminum replacement grease filters for QDE30 Series (3 Pack)	3 *	\$57.82	AC

■ Limited quantities available.

● Item too large to ship via UPS/FedEx. Item shipped common carrier at minimum rates.

* All pricing reflects the individual item cost. You must order in multiples as indicated.

◆ UL listed for use over bathtubs and showers when connected to a GFCI protected branch circuit.

Range Hoods — Under Cabinet

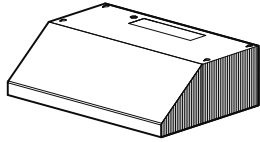

3-1/4" x 10" Duct — Internal Blower
440 CFM, 7.0 Sones — High
200 CFM, 0.7 Sones — Normal

Includes one 42 watt compact fluorescent and one 4 watt night light bulb.

APE Series (ENERGY STAR)

The APE Series models are part of our new ENERGY STAR hood offering and an extension of our popular 9" professional style under-cabinet line. Designed to provide energy efficient operation with a very quiet 440 CFM dual centrifugal blower. Features include hidden variable speed control with last setting memory, two levels of lighting. Heat Sentry™ and dishwasher safe filters with antimicrobial protection.

Model No.	Description	Std. Pk.	List Price	Code
30" APE130SS ■	Stainless Range Hood	1	\$752.48	RH
BPAPFA	Replacement Grease Filter with antimicrobial protection (3 packs/2 filters per pack)	3 *	\$51.62	AC

■ Limited quantities available.

Range hoods work with make-up dampers (MD6TU, MD8TU and MD10TU) and fresh air inlets (641FA, 643FA and 610FA) — see accessories on Page 5.

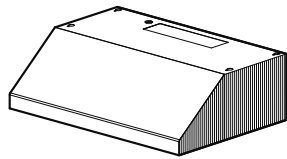

3-1/4" x 10" Duct — Internal Blower
440 CFM — Horizontal and
Vertical 7.0 Sones — High
120 CFM, 0.5 Sones — Low

Converts to non-ducted. Add non-ducted recirculation kit (available separately).

Pro-Style Hoods AP1 Series

Broan's newest 9" pro-style hoods — never before have appearance and value been so elegantly combined. Two halogen bulbs (sold separately) provide two-level lighting. Dishwasher-safe, anti-microbial filters look new over repeated cleanings. Hood features variable speed controls and an optional non-duct choice.

Model No.	Description	Std. Pk.	List Price	Code
30" AP130SS ■	Variable, 430 Stainless Steel Range Hood	1	\$709.82	RH
AP130WW ■	Variable, White on White Range Hood	1	\$658.18	RH
AP130BL ■	Variable, Black on Black Range Hood	1	\$658.18	RH
36" AP136SS ■	Variable, 430 Stainless Steel Range Hood	1	\$730.44	RH
AP136WW ■	Variable, White on White Range Hood	1	\$678.82	RH
AP136BL ■	Variable, Black on Black Range Hood	1	\$678.82	RH
30" NDK35830SS ■	Non-ducted Recirculation Kit for 9N Pro Hood, Stainless	1	\$165.96	HA
NDK35830WW ■	Non-ducted Recirculation Kit for 9N Pro Hood, White	1	\$153.66	HA
NDK35830BL ■	Non-ducted Recirculation Kit for 9N Pro Hood, Black	1	\$153.66	HA
36" NDK35836SS ■	Non-ducted Recirculation Kit for 9N Pro Hood, Stainless	1	\$178.22	HA
NDK35836WW ■	Non-ducted Recirculation Kit for 9N Pro Hood, White	1	\$165.96	HA
NDK35836BL ■	Non-ducted Recirculation Kit for 9N Pro Hood, Black	1	\$165.96	HA
88F	Replacement Non-ducted Filter for 88000, AP1 and RP2 Series. Master Pack contains 6 pairs of filters. (S97007662 — Single Pack)	6 *	\$32.30	AC
BPAPFA	Replacement Grease Filter with antimicrobial protection (3 packs/2 filters per pack)	3 *	\$51.62	AC
GU10	Halogen Bulb; 120V, 50W max.	10 *	\$17.06	AC

■ Limited quantities available.

Range hoods work with make-up dampers (MD6TU, MD8TU and MD10TU) and fresh air inlets (641FA, 643FA and 610FA) — see accessories on Page 5.

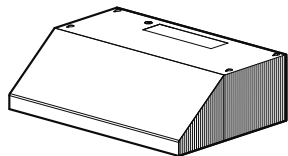

3-1/4" x 10" Duct — Internal Blower
440 CFM — Horizontal and
Vertical 7.0 Sones — High
120 CFM, 0.5 Sones — Low

Pro-Style Hoods RP1 Series

Broan's newest 9" pro-style hoods — never before have appearance and value been so elegantly combined. Two halogen bulbs (sold separately) provide two-level lighting. Dishwasher-safe filters for easy cleaning. Hood features a two-speed rocker blower control.

Model No.	Description	Std. Pk.	List Price	Code
30" RP130SS ■	430 Stainless Steel Range Hood	1	\$619.46	RH
RP130WW ■	White on White Range Hood	1	\$567.82	RH
RP130BL ■	Black on Black Range Hood	1	\$567.82	RH
36" RP136SS ■	430 Stainless Steel Range Hood	1	\$640.08	RH
RP136WW ■	White on White Range Hood	1	\$588.48	RH
RP136BL ■	Black on Black Range Hood	1	\$588.48	RH
BPRPFA	Replacement Grease Filter (3 packs/2 filters per pack) (S97017455 — Single Pack)	3 *	\$23.24	AC
GU10	Halogen Bulb; 120V, 50W max.	10 *	\$17.06	AC

■ Limited quantities available.

Range hoods work with make-up dampers (MD6TU, MD8TU and MD10TU) and fresh air inlets (641FA, 643FA and 610FA) — see accessories on Page 5.

- Item too large to ship via UPS/FedEx. Item shipped common carrier at minimum rates.
- * All pricing reflects the individual item cost. You must order in multiples as indicated.
- ◆ UL listed for use over bathtubs and showers when connected to a GFCI protected branch circuit.

Range Hoods — Under Cabinet

Broan® 88000 Series

An infinite speed slide control operates a powerful, quiet blower. Can convert to non-duct operation. Damper/adaptor included, filters sold separately. Uses two 75-watt bulbs (sold separately) and optional make-up air dampers.



3-1/4" x 10" Duct — Internal Blower
360 CFM — 5.5 Sones Vertical
350 CFM — 6.0 Sones Horizontal

Converts to non-ducted. Add non-ducted filters (available separately).

Model No.	Description	Std. Pk.	List Price	Code
30" 883001 ■	White Range Hood	1	\$505.36	RH
883002 ■	Bisque Range Hood	1	\$505.36	RH
883004 ■	Stainless Steel Range Hood	1	\$569.32	RH
883008 ■	Almond Range Hood	1	\$505.36	RH
883011 ■	White on White Range Hood	1	\$505.36	RH
883023 ■	Black Range Hood	1	\$505.36	RH
36" 883601 ■	White Range Hood	1	\$555.90	RH
883604 ■	Stainless Steel Range Hood	1	\$624.38	RH
883608 ■	Almond Range Hood	1	\$555.90	RH
883623 ■	Black Range Hood	1	\$555.90	RH
42" 884201 ■	White Range Hood	1	\$609.80	RH
884204 ■	Stainless Steel Range Hood	1	\$737.90	RH
884223 ■	Black Range Hood	1	\$609.80	RH
48" 884801 ■	White Range Hood	1	\$636.12	RH
884804 ■	Stainless Steel Range Hood	1	\$668.48	RH
884823 ■	Black Range Hood	1	\$636.12	RH
88F	Replacement Non-ducted Filter for 88000, AP1 and AP2 Series. Master Pack contains 6 pairs of filters. (S97007662 — Single Pack)	6 *	\$32.30	AC

■ Limited quantities available.

Single packs are higher priced.

Range hoods work with make-up dampers (MD6TU, MD8TU and MD10TU) and fresh air inlets (641FA, 643FA and 610FA) — see accessories on Page 5.

Broan® Range Hood Specials

IMPORTANT: Orders for specials become non-cancellable upon acceptance by the Company. Range hood specials will be shipped within three weeks from receipt of order. Ducted only design, with infinite speed slide control and last-setting memory.



89000 Series — Solid-State
3-1/4" x 10" Duct — Internal Blower
460 CFM — 6.0 Sones Vertical
440 CFM — 7.0 Sones Horizontal



88000 Series — Solid-State
3-1/4" x 10" Duct — Internal Blower
360 CFM — 5.5 Sones Vertical
350 CFM — 6.0 Sones Horizontal

Converts to non-ducted. Add non-ducted filters (available separately).

Model No.	Description	Std. Pk.	List Price	Code
30" 893001 ■	White Range Hood Special	1	\$657.16	RH
893004 ■	Stainless Steel Range Hood Special	1	\$738.36	RH
893011 ■	White-on-White Range Hood Special	1	\$657.16	RH
893023 ■	Black Range Hood Special	1	\$657.16	RH
36" 893601 ■	White Range Hood Special	1	\$680.60	RH
893604 ■	Stainless Steel Range Hood Special	1	\$761.82	RH
893623 ■	Black Range Hood Special	1	\$680.60	RH
39" 893901 ■	White Range Hood Special	1	\$719.62	RH
893904 ■	Stainless Steel Range Hood Special	1	\$800.82	RH
42" 894201 ■	White Range Hood Special	1	\$704.02	RH
894204 ■	Stainless Steel Range Hood Special	1	\$785.22	RH
894223 ■	Black Range Hood Special	1	\$704.02	RH
48" 894801 ■	White Range Hood Special	1	\$727.44	RH
894804 ■	Stainless Steel Range Hood Special	1	\$808.68	RH
Model No.	Description	Std. Pk.	List Price	Code
39" 883901 ■	White Range Hood Special	1	\$618.26	RH
883904 ■	Stainless Steel Range Hood Special	1	\$701.82	RH

■ Limited quantities available.

Range hoods work with make-up dampers (MD6TU, MD8TU and MD10TU) and fresh air inlets (641FA, 643FA and 610FA) — see accessories on Page 5.

● Item too large to ship via UPS/FedEx. Item shipped common carrier at minimum rates.

* All pricing reflects the individual item cost. You must order in multiples as indicated.

◆ UL listed for use over bathtubs and showers when connected to a GFCI protected branch circuit.

Range Hoods — Under Cabinet

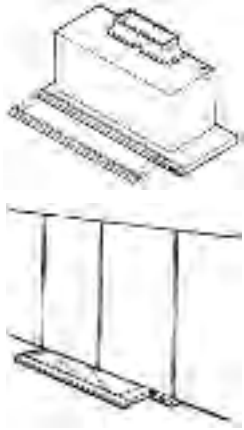

3-1/4" x 10" Duct — Internal Blower
300 CFM — 4.5 Sones Vertical

Broan® Elite 15000 Series Slide Out SILHOUETTE™

Thin-line styling to complement today's contemporary and European styled kitchens. Superior air movement provided by a high efficiency, dual centrifugal blower system. Solid-state infinite speed slide control with memory. Heat Sentry™. Bright, economical 24" fluorescent light (tube not included). Washable foam filter.

	Model No.	Description	Std. Pk.	List Price	Code
30"	153001	White Slide Out	1	\$980.66	DH
	153004	Brushed Aluminum Slide Out	1	\$1,019.04	DH
	153023	Black Slide Out	1	\$980.66	DH
36"	153601	White Slide Out	1	\$1,060.24	DH
	153604	Brushed Aluminum Slide Out	1	\$1,099.60	DH
	153623	Black Slide Out	1	\$1,060.24	DH

For replacement filters, see Broan's Replacement Parts Guide.



3-1/4" x 10" Duct — Internal Blower
200 CFM, 5.0 Sones Vertical
190 CFM, 4.5 Sones Horizontal
7" Round Duct — Internal Blower
250 CFM, 4.5 Sones

Broan® QML Series

This Pro-Style under cabinet hood is available in a 30" width, making it the perfect fit for the most common cook-top size. The sleek 6" high design brings a modern style to today's kitchens. The canopy type range hood has a fully enclosed bottom design, making it very easy to clean. Dual halogen lighting with two light levels provides brilliant cook-top illumination (GU1035, MR16 bulbs not included), and the two-speed rocker control switch makes it easy to use. Dishwasher safe grease filter ensures peak performance for many years to come.

The QML can be installed to duct outdoors or as non-ducted with the purchase of the BPQFT filter. (3-1/4" x 10" damper/duct connector and 7" round duct adapter plate included.)

	Model No.	Description	Std. Pk.	List Price	Code
30"	QML30BL ■	Black Range Hood	1	\$272.90	QP
	QML30SS ■	Stainless Range Hood	1	\$309.54	QP
	QML30WW ■	White Range Hood	1	\$272.90	QP
	BPQTF	Non-ducted Filters (99010317 — Single Pack)	4 *	\$11.80	AC
	BPQTAf	Aluminum Grease Filters (99010316 — Single Pack)	4 *	\$9.40	AC
	GU1035	Halogen Bulb; 120V, 35W	10 *	\$15.92	AC

■ Limited quantities available.

- Item too large to ship via UPS/FedEx. Item shipped common carrier at minimum rates.
- * All pricing reflects the individual item cost. You must order in multiples as indicated.
- ◆ UL listed for use over bathtubs and showers when connected to a GFCI protected branch circuit.

Range Hoods — Under Cabinet

Broan® QT20000 Series QUIET HOOD

Patented air chamber design reduces noise up to 40% over conventional hoods. Convertible to ducted or non-ducted. Infinite rotary speed control and dual 40-watt bulbs with night-light (bulbs sold separately).



3-1/4" x 10" Duct — Internal Blower
200 CFM — 4.5 Sones Vertical
170 CFM — 4.5 Sones Horizontal
7" Rounded Duct — Internal Blower
220 CFM — 4.5 Sones Vertical

Converts to non-ducted. Add BPQTF non-ducted filter (sold separately).

Model No.	Description	Std. Pk.	List Price	Code
30" QT230AA ■	Almond-on-Almond Range Hood	1	\$246.34	AH
QT230BC ■	Bisque-on-Bisque Range Hood	1	\$246.34	AH
QT230BL ■	Black Range Hood	1	\$246.34	AH
QT230SS ■	Stainless Steel Range Hood	1	\$325.60	AH
QT230WW ■	White-on-White Range Hood	1	\$246.34	AH
36" QT236AA ■	Almond-on-Almond Range Hood	1	\$254.82	AH
QT236BC ■	Bisque-on-Bisque Range Hood	1	\$254.82	AH
QT236BL ■	Black Range Hood	1	\$254.82	AH
QT236SS ■	Stainless Steel Range Hood	1	\$334.10	AH
QT236WW ■	White-on-White Range Hood	1	\$254.82	AH
42" QT242AA ■	Almond-on-Almond Range Hood	1	\$260.48	AH
QT242BC ■	Bisque-on-Bisque Range Hood	1	\$260.48	AH
QT242BL ■	Black Range Hood	1	\$260.48	AH
QT242SS ■	Stainless Steel Range Hood	1	\$339.72	AH
QT242WW ■	White-on-White Range Hood	1	\$260.48	AH
BPQTF	Non-ducted Filters (99010317 — Single Pack)	4 *	\$11.80	AC
BPQAF	Aluminum Grease Filters (99010316 — Single Pack)	4 *	\$9.40	AC
BP87 ■	7" Damper for round discharge range hood. (S97010792 — Single Pack)	3 *	\$11.46	AC

■ Limited quantities available.

Single packs are higher priced.

Broan® 46000 Series

Convertible to ducted or non-ducted (non-duct filter sold separately). Variable speed rotary control. 75-watt cooktop lighting (bulb sold separately).



3-1/4" x 10" Duct — Internal Blower
190 CFM — 7.5 Sones Vertical
190 CFM — 7.5 Sones Horizontal
7" Rounded Duct — Internal Blower
220 CFM — 7.5 Sones

Converts to non-ducted.

Model No.	Description	Std. Pk.	List Price	Code
24" 462401	White Range Hood	1	\$200.12	RH
462404	Stainless Steel Range Hood	1	\$258.92	RH
462423	Black Range Hood	1	\$200.12	RH
30" 463001	White Range Hood	1	\$190.58	RH
463002	Bisque Range Hood	1	\$190.58	RH
463004	Stainless Steel Range Hood	1	\$249.36	RH
463008 ■	Almond Range Hood	1	\$190.58	RH
463011	White-on-White Range Hood	1	\$190.58	RH
463023	Black Range Hood	1	\$190.58	RH
36" 463601	White Range Hood	1	\$200.12	RH
463602	Bisque Range Hood	1	\$200.12	RH
463604	Stainless Steel Range Hood	1	\$258.92	RH
463608 ■	Almond Range Hood	1	\$200.12	RH
463623	Black Range Hood	1	\$200.12	RH
42" 464201	White Range Hood	1	\$209.72	RH
464202	Bisque Range Hood	1	\$209.72	RH
464204	Stainless Steel Range Hood	1	\$268.48	RH
464208 ■	Almond Range Hood	1	\$209.72	RH
41F	Replacement Non-ducted Filter for F40000, 41000 and 46000 Series range hoods. Master Pack contains 6 filters. (S97007696 — Single Pack)	6 *	\$17.42	AC
BP29	10-1/2" x 8-3/4" Washable Aluminum Filter for F40000, 40000, 42000 and 46000 Series. Contains 6 filters. (S97006931 — Single Pack)	6 *	\$9.34	AC

■ Limited quantities available.

Single packs are higher priced.

● Item too large to ship via UPS/FedEx. Item shipped common carrier at minimum rates.

* All pricing reflects the individual item cost. You must order in multiples as indicated.

◆ UL listed for use over bathtubs and showers when connected to a GFCI protected branch circuit.

Range Hoods — Under Cabinet

Broan® 43000 Series

Adapt to any installation with these four-way convertible range hoods. An enclosed light and fan/filter assembly makes for easy cleaning.



3-1/4" x 10" Duct — Internal Blower
 190 CFM — 7.0 Sones Vertical
 160 CFM — 7.0 Sones Horizontal
 7" Rounded Duct — Internal Blower
 220 CFM — 8.0 Sones Vertical

Converts to non-ducted. Includes washable aluminum filter with light lens.

Model No.	Description	Std. Pk.	List Price	Code	
30"	433004	Stainless Steel Range Hood	1	\$205.14	LL
	433011	White-on-White Range Hood	1	\$143.36	LL
	433018	■ Almond-on-Almond Range Hood	1	\$143.36	LL
	433022	Bisque-on-Bisque Range Hood	1	\$143.36	LL
	433023	Black Range Hood	1	\$143.36	LL
36"	433604	Stainless Steel Range Hood	1	\$212.20	LL
	433611	White-on-White Range Hood	1	\$152.80	LL
	433618	■ Almond-on-Almond Range Hood	1	\$152.80	LL
	433622	Bisque-on-Bisque Range Hood	1	\$152.80	LL
	433623	Black Range Hood	1	\$152.80	LL
BP57	11-3/8" x 11-3/4" Washable Aluminum and Charcoal Filter with light lens. Master pack contains 8 filters. (SR610050 — Single Pack.)	8 *	\$16.50	AC	
BP58	Replacement Charcoal Filter Pack. Each pack contains three 7-3/4" x 10-1/2" pads. Master pack contains 8 filter packs. (SR610051 — Single Pack)	8 *	\$11.58	AC	

■ Limited quantities available.

Single packs are higher priced.

● Item too large to ship via UPS/FedEx. Item shipped common carrier at minimum rates.
 * All pricing reflects the individual item cost. You must order in multiples as indicated.
 ◆ UL listed for use over bathtubs and showers when connected to a GFCI protected branch circuit.

Range Hoods — Under Cabinet

Broan® F40000 Series

Adapt to any installation with these four-way convertible range hoods. An enclosed light and fan/filter assembly makes for easy cleaning.

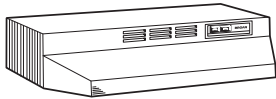

3-1/4" x 10" Duct — Internal Blower
 160 CFM — 6.5 Sones Vertical
 160 CFM — 6.5 Sones Horizontal
 7" Round Duct — Internal Blower
 190 CFM — 6.5 Sones

Converts to non-ducted. Includes washable aluminum filter. Non-ducted filter purchased separately.

	Model No.	Description	Std. Pk.	List Price	Code
24"	F402401	White Range Hood	1	\$141.00	LL
	F402402 ■	Bisque Range Hood	1	\$141.00	LL
	F402404	Stainless Steel Range Hood	1	\$200.46	LL
	F402408	Almond Range Hood	1	\$141.00	LL
	F402411	White-on-White Range Hood	1	\$141.00	LL
	F402422	Bisque-on-Bisque Range Hood	1	\$141.00	LL
	F402423	Black Range Hood	1	\$141.00	LL
	30"	F403001	White Range Hood	1	\$135.24
F403002 ■		Bisque Range Hood	1	\$135.24	LL
F403004		Stainless Steel Range Hood	1	\$192.26	LL
F403008		Almond Range Hood	1	\$135.24	LL
F403011		White-on-White Range Hood	1	\$135.24	LL
F403022		Bisque-on-Bisque Range Hood	1	\$135.24	LL
F403023		Black Range Hood	1	\$135.24	LL
36"		F403601	White Range Hood	1	\$148.76
	F403602 ■	Bisque Range Hood	1	\$148.76	LL
	F403604	Stainless Steel Range Hood	1	\$211.48	LL
	F403608	Almond Range Hood	1	\$148.76	LL
	F403611	White-on-White Range Hood	1	\$148.76	LL
	F403622	Bisque-on-Bisque Range Hood	1	\$148.76	LL
	F403623	Black Range Hood	1	\$148.76	LL
	42"	F404201	White Range Hood	1	\$163.62
F404202 ■		Bisque Range Hood	1	\$163.62	LL
F404204		Stainless Steel Range Hood	1	\$232.64	LL
F404208		Almond Range Hood	1	\$163.62	LL
F404211		White-on-White Range Hood	1	\$163.62	LL
F404222		Bisque-on-Bisque Range Hood	1	\$163.62	LL
F404223		Black Range Hood	1	\$163.62	LL
41F		Replacement Non-ducted Filter for F40000, 41000 and 46000 Series range hoods. Master Pack contains 6 filters. (S97007696 — Single Pack)	6 *	\$17.42	AC
BP29	10-1/2" x 8-3/4" Washable Aluminum Filter for F40000, 40000, 42000 and 46000 Series. Contains 6 filters. (S97006931 — Single Pack)	6 *	\$9.34	AC	
BP87Q	7" Damper for round discharge range hood. (S97010792 — Single Pack)	3 *	\$18.42	AC	

■ Limited quantities available.

Single packs are higher priced.

● Item too large to ship via UPS/FedEx. Item shipped common carrier at minimum rates.
 * All pricing reflects the individual item cost. You must order in multiples as indicated.
 ◆ UL listed for use over bathtubs and showers when connected to a GFCI protected branch circuit.

Range Hoods — Under Cabinet

Broan® 42000 Series 7" ROUND DUCTED

High quality, economy level range hood installs as 7" round ducted only. Dishwasher-safe grease filter.



7" Round Duct — Internal Blower
190 CFM — 6.0 Sones Vertical

BP87 Damper must be purchased separately, except on "D" version models.

	Model No.	Description	Std. Pk.	List Price	Code
24"	422401	White Range Hood	1	\$125.04	LL
	422401D	White Range Hood (with damper)	1	\$135.34	LL
	422402	Bisque Range Hood	1	\$125.04	LL
	422404	Stainless Steel Range Hood	1	\$183.84	LL
	422408	■ Almond Range Hood	1	\$125.04	LL
30"	423001	White Range Hood	1	\$120.68	LL
	423001D	White Range Hood (with damper)	1	\$130.62	LL
	423002	Bisque Range Hood	1	\$120.68	LL
	423004	Stainless Steel Range Hood	1	\$179.44	LL
	423008	■ Almond Range Hood	1	\$120.68	LL
	423008D	■ Almond Range Hood (with damper)	1	\$130.62	LL
	423023	Black Range Hood	1	\$120.68	LL
36"	423601	White Range Hood	1	\$125.04	LL
	423601D	White Range Hood (with damper)	1	\$135.34	LL
	423602	Bisque Range Hood	1	\$125.04	LL
	423604	Stainless Steel Range Hood	1	\$183.84	LL
	423608	■ Almond Range Hood	1	\$125.04	LL
	423608D	■ Almond Range Hood (with damper)	1	\$135.34	LL
	423623	Black Range Hood	1	\$125.04	LL
42"	424201	White Range Hood	1	\$129.48	LL
	424201D	White Range Hood (with damper)	1	\$139.80	LL
	424202	Bisque Range Hood	1	\$129.48	LL
	424204	Stainless Steel Range Hood	1	\$188.22	LL
	424208	■ Almond Range Hood	1	\$129.48	LL
	BP29	10-1/2" x 8-3/4" Washable Aluminum Filter for F40000, 40000, 42000 and 46000 Series. Contains 6 filters. (S97006931 — Single Pack)	6 *	\$9.34	AC
	BP87Q	7" Damper for round discharge range hood. (S97010792 — Single Pack)	3 *	\$18.42	AC
	T457	7" to 5" duct reducer	1	\$26.00	AC

■ Limited quantities available.

Single packs are higher priced.

● Item too large to ship via UPS/FedEx. Item shipped common carrier at minimum rates.

* All pricing reflects the individual item cost. You must order in multiples as indicated.

◆ UL listed for use over bathtubs and showers when connected to a GFCI protected branch circuit.

Range Hoods — Under Cabinet

Broan® 40000 Series 3-1/4" x 10" DUCTED

High quality, economy level range hood installs as 3-1/4" x 10" ducted only. Dishwasher-safe grease filter.



3-1/4" x 10" Duct — Internal Blower
160 CFM — 6.5 Sones Vertical
160 CFM — 6.5 Sones Horizontal

	Model No.	Description	Std. Pk.	List Price	Code
21"	402101	White Range Hood	1	\$157.52	LL
	402102	Bisque Range Hood	1	\$157.52	LL
	402108	■ Almond Range Hood	1	\$157.52	LL
24"	402401	White Range Hood	1	\$132.56	LL
	402402	Bisque Range Hood	1	\$132.56	LL
	402404	Stainless Steel Range Hood	1	\$191.36	LL
	402408	■ Almond Range Hood	1	\$132.56	LL
30"	403001	White Range Hood	1	\$128.14	LL
	403002	Bisque Range Hood	1	\$128.14	LL
	403004	Stainless Steel Range Hood	1	\$186.92	LL
	403008	■ Almond Range Hood	1	\$128.14	LL
	403023	Black Range Hood	1	\$128.14	LL
36"	403601	White Range Hood	1	\$132.56	LL
	403602	Bisque Range Hood	1	\$132.56	LL
	403604	Stainless Steel Range Hood	1	\$191.36	LL
	403608	■ Almond Range Hood	1	\$132.56	LL
	403623	Black Range Hood	1	\$132.56	LL
42"	404201	White Range Hood	1	\$136.92	LL
	404202	Bisque Range Hood	1	\$136.92	LL
	404208	■ Almond Range Hood	1	\$136.92	LL
	BP29	10-1/2" x 8-3/4" Washable Aluminum Filter for F40000, 40000, 42000 and 46000 Series. Contains 6 filters. (S97006931 — Single Pack)	6 *	\$9.34	AC

■ Limited quantities available.

Single packs are higher priced.

Broan® 37000 Series (SHELL ONLY)

Shell utilizes a 40000 Series shell, but contains no fan, light, switches or knockouts.



	Model No.	Description	Std. Pk.	List Price	Code
24"	372401	White Range Hood Shell	1	\$79.94	LL
	372408	■ Almond Range Hood Shell	1	\$79.94	LL
30"	373001	White Range Hood Shell	1	\$75.54	LL
	373002	Bisque Range Hood Shell	1	\$75.54	LL
	373004	Stainless Steel Range Hood Shell	1	\$134.30	LL
	373008	■ Almond Range Hood Shell	1	\$75.54	LL
36"	373601	White Range Hood Shell	1	\$79.94	LL
	373604	Stainless Steel Range Hood Shell	1	\$138.70	LL

■ Limited quantities available.

● Item too large to ship via UPS/FedEx. Item shipped common carrier at minimum rates.

* All pricing reflects the individual item cost. You must order in multiples as indicated.

◆ UL listed for use over bathtubs and showers when connected to a GFCI protected branch circuit.

Range Hoods — Under Cabinet

Broan® 41000 Series NON-DUCTED

High quality, economy level range hood installs as non-ducted only. Two-speed fan control. Charcoal replacement filter sold separately.



Non-ducted — Includes filter

	Model No.	Description	Std. Pk.	List Price	Code
21"	412101	White Non-ducted Range Hood	1	\$160.74	LL
	412102	Bisque Non-ducted Range Hood	1	\$160.74	LL
	412108	■ Almond Non-ducted Range Hood	1	\$160.74	LL
	412123	Black Non-ducted Range Hood	1	\$160.74	LL
24"	412401	White Non-ducted Range Hood	1	\$135.78	LL
	412402	Bisque Non-ducted Range Hood	1	\$135.78	LL
	412404	Stainless Steel Non-ducted Range Hood	1	\$194.56	LL
	412408	■ Almond Non-ducted Range Hood	1	\$135.78	LL
30"	413001	White Non-ducted Range Hood	1	\$131.36	LL
	413002	Bisque Non-ducted Range Hood	1	\$131.36	LL
	413004	Stainless Steel Non-ducted Range Hood	1	\$190.16	LL
	413008	■ Almond Non-ducted Range Hood	1	\$131.36	LL
	413023	Black Non-ducted Range Hood	1	\$131.36	LL
36"	413601	White Non-ducted Range Hood	1	\$135.78	LL
	413602	Bisque Non-ducted Range Hood	1	\$135.78	LL
	413604	Stainless Steel Non-ducted Range Hood	1	\$194.56	LL
	413608	■ Almond Non-ducted Range Hood	1	\$135.78	LL
	413623	Black Non-ducted Range Hood	1	\$135.78	LL
42"	414201	White Non-ducted Range Hood	1	\$140.20	LL
	414202	Bisque Non-ducted Range Hood	1	\$140.20	LL
	414204	Stainless Steel Non-ducted Range Hood	1	\$198.98	LL
	414208	■ Almond Non-ducted Range Hood	1	\$140.20	LL
	41F	Replacement Non-ducted Filter for F40000, 41000 and 46000 Series range hoods. Master Pack contains 6 filters. (S97007696 — Single Pack)	6 *	\$17.42	AC

■ Limited quantities available.

Single packs are higher priced.

Range Hoods — Accessories

Broan® SP and EP Backsplashes (24" HIGH)



All Backsplashes furnished in two colors — one per side except stainless steel.

Economy (EP) Backsplashes are packaged 4 per carton and must be ordered in multiples of 4. Prices shown are for each wall shield.

	Model No.	Description	Std. Pk.	List Price	Code
24"	SP240108	White/Almond Backsplash	1	\$39.28	AC
	SP2404	Stainless Steel Backsplash	1	\$99.80	AC
	SP240223	Bisque/Black Backsplash	1	\$39.28	AC
30"	SP300108	White/Almond Backsplash	1	\$39.28	AC
	SP3004	Stainless Steel Backsplash	1	\$99.80	AC
	SP300223	Bisque/Black Backsplash	1	\$39.28	AC
36"	SP360108	White/Almond Backsplash	1	\$45.74	AC
	SP3604	Stainless Steel Backsplash	1	\$106.04	AC
	SP360223	Bisque/Black Backsplash	1	\$45.74	AC
42"	SP420108	■ White/Almond Backsplash	1	\$53.14	AC
	SP4204	Stainless Steel Backsplash	1	\$123.02	AC
	SP420223	Bisque/Black Backsplash	1	\$53.14	AC
30"	EP300108	■ White/Almond Backsplash	4 *	\$35.60	AC
	EP300223	Bisque/Black Backsplash	4 *	\$35.60	AC

■ Limited quantities available.

Note: Backsplashes are accessories and cannot be combined with any other product groups to meet volume requirements.

- Item too large to ship via UPS/FedEx. Item shipped common carrier at minimum rates.
- * All pricing reflects the individual item cost. You must order in multiples as indicated.
- ◆ UL listed for use over bathtubs and showers when connected to a GFCI protected branch circuit.

Range Hoods — Accessories

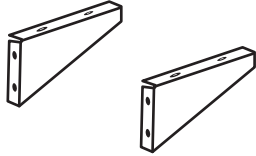

Broan® Range Hood Wall Brackets

Designed for use with 37000, 40000, 41000, 42000, 43000, 46000, 52000, 88000, 89000, AP1 (ducted only), F40000, QL1, QS1, QS2 (36" and 42" only), QS3 (36" and 42" only), QT20000 and RP1 Series.

Model No.	Description	Std. Pk.	List Price	Code
35	Wall Hanging Kit for mounting all hoods to wall when cabinets are not used	1	\$30.14	AC



Broan® Range Hood Electrical Cord Connection Kit

Designed for easy electrical wiring of range hoods. Can be used with Broan, NuTone, Nautilus or Kenmore range hoods.

Model No.	Description	Std. Pk.	List Price	Code
HCK44	Power Cord Kit on individual display card	10 *	\$21.74	AC
HCK44D	Power Cord Kit individual packaged in a polybag. Master Pack — 50.	50 *	\$14.30	AC

Broan: 40000, 41000, 42000, 43000, 46000, 52000, 53000, 88000, 89000, B30, CBD1, CBD3, CBX1, CJD1, CJD3, QL, QML, OP, QS1, QS2, QS3, QT20000, AP, RP, E661, QSE1, Glacier, Antero, Sahale, Spire, Alta, Tenaya, Corteo

NuTone: RL, SL, WA65, WS1, WS2, WS3, NS1, NSP, NS6500, Mantra, Osmos

Kenmore: 5094, 5104, 5114, 5134, 5164, 5174, 5184, 5204, 5205, 5214, 5215, 5234, 5244, 5254, 5260, 5270, 5324, 5334, 5501, 5511, 5521, 5535, 5580, 5817, 5818

Broan® Range Hood Lamp Accessories

Model No.	Description	Std. Pk.	List Price	Code
PAR20	Halogen Bulb; 120V, 50W for QS1, QS2, QS3 and RMIP Series	6 *	\$23.20	AC
GU10	Halogen Bulb; 120V, 50W for E66, RMP, E60, E64, AP, QP2, QP3, QP4 and RP Series	10 *	\$17.06	AC
GU1035	Halogen Bulb; 120V, 35W for EI59, EW58, EW56, QML and QP1 Series	10 *	\$15.92	AC

Trash Compactor Accessories

Broan® Elite Trash Compactor Accessories

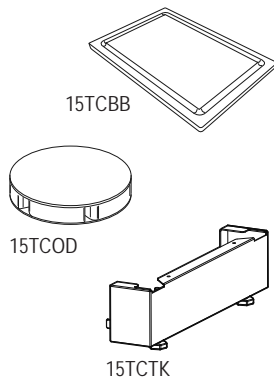

Model No.	Description	Std. Pk.	List Price	Code
15TCBB	■ Cutting Board for 15" compactor	1	\$163.56	CP
15TCBL	15" Compactor Bags, 12 count	1	\$24.94	CP
15TCOD	Odor Control Disc	1	\$53.30	CP
15TCTK	■ Free-standing Toe Kick Kit	1	\$23.58	CP
1006	12" Compactor Bags (includes 10 packs of 12)	10 *	\$19.46	CP

■ Limited quantities available.

- Item too large to ship via UPS/FedEx. Item shipped common carrier at minimum rates.
- * All pricing reflects the individual item cost. You must order in multiples as indicated.
- ◆ UL listed for use over bathtubs and showers when connected to a GFCI protected branch circuit.

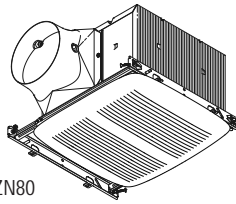

ZN80
ZN110

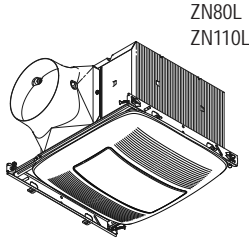

ZN80L
ZN110L

NuTone® ULTRA™ Green Multi-Speed Series

We started with installation and worked back to build the ultimate bath fan. Unique telescoping mounting frame is ideal for both new construction and retrofit. No attic access needed! DC motor for efficiency. Multi-speed capability ideal for meeting ASHRAE 62.2, LEED, ENERGY STAR® for Homes and CA Title 24 — as well as local/spot ventilation needs. Powerful operation maintained over a wide range of real-world installations (CFM rating at 0.1" static pressure maintained through 0.25" static pressure). Fits in 2" x 8" ceiling construction. 10-1/2" L x 11-3/8" W x 7-5/8" H housing. 13" x 14" grille (fan) and 13" x 13-1/4" (fan/light/night light). All models have a 6" duct connector and the 50 CFM and 80 CFM models include a 6" to 4" reducer. All ULTRA 80 and 110 CFM fans can also be used with the MD6TU universal make-up air damper if 6" rigid duct is used. ULTRA non-sensing fans (not fan/lights) can also be used with the RDF1 radiation damper. Now with QStream sound technology that features airflow-smoothing baffles to reduce noise caused by turbulence (50 and 80 CFM models only).

Model No.	Description	Std. Pk.	List Price	Code
Fans				
ZN80 ◆	30 CFM to 80 CFM, <0.3 Sones, ENERGY STAR Fan	1	\$308.94	HP
ZN110 ◆	30 CFM to 110 CFM, <0.3 Sones, ENERGY STAR Fan	1	\$337.68	HP
Fan/Light/Night Light				
ZN80L ◆	30 CFM to 80 CFM, <0.3 Sones, ENERGY STAR Fan with 36W Fluorescent Light (2-18 watt GU24 bulbs included) and 4W Night Light (bulb not included)	1	\$423.68	HP
ZN110L ◆	30 CFM to 110 CFM, <0.3 Sones, ENERGY STAR Fan with 36W Fluorescent Light (2-18 watt GU24 bulbs included) and 4W Night Light (bulb not included)	1	\$454.76	HP



All models are ENERGY STAR certified products.

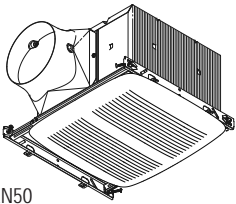

XN50
XN80
XN110

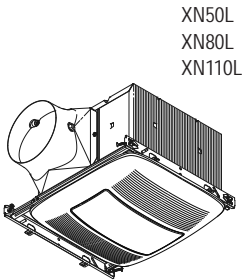

XN50L
XN80L
XN110L

NuTone® ULTRA™ Green Single-Speed Series

We started with installation and worked back to build the ultimate bath fan. Unique telescoping mounting frame is ideal for both new construction and retrofit. No attic access needed! ASHRAE 62.2, LEED, ENERGY STAR® for Homes and CA Title 24 compliant. Powerful operation maintained over a wide range of real-world installations (CFM rating at 0.1" static pressure maintained through 0.25" static pressure). Fits in 2" x 8" ceiling construction. 10-1/2" L x 11-3/8" W x 7-5/8" H housing. 13" x 14" grille (fan) and 13" x 13-1/4" (fan/light/night light). All models have a 6" duct connector and the 50 CFM and 80 CFM models include a 6" to 4" reducer. All ULTRA 80 and 110 CFM fans can also be used with the MD6TU universal make-up air damper if 6" rigid duct is used. ULTRA non-sensing fans (not fan/lights) can also be used with the RDF1 radiation damper. Now with QStream sound technology that features airflow-smoothing baffles to reduce noise caused by turbulence (50 and 80 CFM models only).

Model No.	Description	Std. Pk.	List Price	Code
Fans				
XN50 ◆	50 CFM, <0.3 Sones, ENERGY STAR Fan	1	\$264.80	HP
XN80 ◆	80 CFM, <0.3 Sones, ENERGY STAR Fan	1	\$281.14	HP
XN110 ◆	110 CFM, <0.3 Sones, ENERGY STAR Fan	1	\$301.50	HP
Fan/Light/Night Light				
XN50L ◆	50 CFM, <0.3 Sones, ENERGY STAR Fan with 36W Fluorescent Light (2-18 watt GU24 bulbs included) and 4W Night Light (bulb not included)	1	\$373.90	HP
XN80L ◆	80 CFM, <0.3 Sones, ENERGY STAR Fan with 36W Fluorescent Light (2-18 watt GU24 bulbs included) and 4W Night Light (bulb not included)	1	\$403.14	HP
XN110L ◆	110 CFM, <0.3 Sones, ENERGY STAR Fan with 36W Fluorescent Light (2-18 watt GU24 bulbs included) and 4W Night Light (bulb not included)	1	\$416.52	HP



All models are ENERGY STAR certified products.

- Item too large to ship via UPS/FedEx. Item shipped common carrier at minimum rates.
- * All pricing reflects the individual item cost. You must order in multiples as indicated.
- ◆ UL listed for use over bathtubs and showers when connected to a GFCI protected branch circuit.

Ventilation Fans — ULTRA™

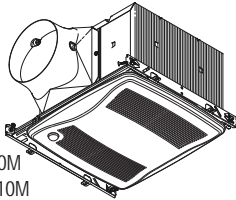

ZN80M
ZN110M

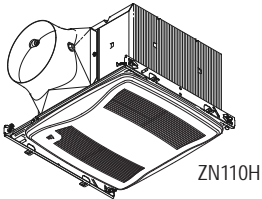

ZN110H

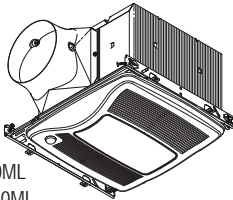

ZN80ML
ZN110ML

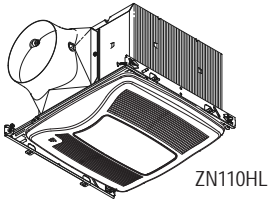

ZN110HL

NuTone® ULTRA™ Green Multi-Speed Series — Sensing

We started with installation and worked back to build the ultimate bath fan. Unique telescoping mounting frame is ideal for both new construction and retrofit. No attic access needed! DC motor for efficiency. Multi-speed capability ideal for meeting ASHRAE 62.2, LEED, ENERGY STAR® for Homes and CA Title 24 — as well as local/spot ventilation needs. Humidity or motion sensing triggers fan to ramp up from lower continuous ventilation level to maximum CFM. Powerful operation maintained over a wide range of real-world installations (CFM rating at 0.1" static pressure maintained through 0.25" static pressure). Fits in 2" x 8" ceiling construction. 10-1/2" L x 11-3/8" W x 7-5/8" H housing. 13" x 14" grille (fan) and 13" x 13-1/4" (fan/light/night light). All models have a 6" duct connector and the 80 CFM models include a 6" to 4" reducer. All ULTRA 80 and 110 CFM fans can also be used with the MD6TU universal make-up air damper if 6" rigid duct is used. ULTRA non-sensing fans (not fan/lights) can also be used with the RDF1 radiation damper. Now with QStream sound technology that features airflow-smoothing baffles to reduce noise caused by turbulence (50 and 80 CFM models only).

Model No.	Description	Std. Pk.	List Price	Code
Fans				
ZN80M	◆ 80 CFM, <0.3 Sones, ENERGY STAR Motion Sensing Fan	1	\$356.76	HP
ZN110H	◆ 110 CFM, <0.3 Sones, ENERGY STAR Humidity Sensing Fan	1	\$448.82	HP
ZN110M	◆ 110 CFM, <0.3 Sones, ENERGY STAR Motion Sensing Fan	1	\$383.74	HP
Fan/Light/Night Light				
ZN80ML	◆ 80 CFM, <0.3 Sones, ENERGY STAR Motion Sensing Fan with 36W Fluorescent Light (2-18 watt GU24 bulbs included) and 4W Night Light (bulb not included),	1	\$478.38	HP
ZN110HL	◆ 110 CFM, <0.3 Sones, ENERGY STAR Humidity Sensing Fan with 36W Fluorescent Light (2-18 watt GU24 bulbs included) and 4W Night Light (bulb not included)	1	\$570.70	HP
ZN110ML	◆ 110 CFM, <0.3 Sones, ENERGY STAR Motion Sensing Fan with 36W Fluorescent Light (2-18 watt GU24 bulbs included) and 4W Night Light (bulb not included)	1	\$511.80	HP



All models are ENERGY STAR certified products.

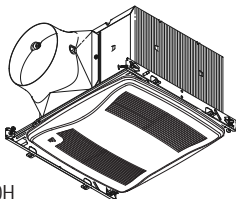

XN110H

XN110HL

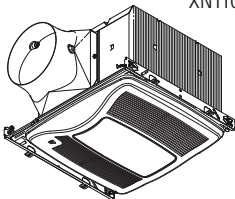

NuTone® ULTRA™ Green Single-Speed Series — Sensing

We started with installation and worked back to build the ultimate bath fan. Unique telescoping mounting frame is ideal for both new construction and retrofit. No attic access needed! DC motor for efficiency. ASHRAE 62.2, LEED, ENERGY STAR® for Homes and CA Title 24 compliant. Humidity sensing models will automatically turn fan on when rapid rise in humidity is sensed. Powerful operation maintained over a wide range of real-world installations (CFM rating at 0.1" static pressure maintained through 0.25" static pressure). Fits in 2" x 8" ceiling construction. 10-1/2" L x 11-3/8" W x 7-5/8" H housing. 13" x 14" grille (fan) and 13" x 13-1/4" (fan/light/night light). All models have a 6" duct connector. All ULTRA 80 and 110 CFM fans can also be used with the MD6TU universal make-up air damper if 6" rigid duct is used. ULTRA non-sensing fans (not fan/lights) can also be used with the RDF1 radiation damper. Now with QStream sound technology that features airflow-smoothing baffles to reduce noise caused by turbulence (50 and 80 CFM models only).

Model No.	Description	Std. Pk.	List Price	Code
Fan				
XN110H	◆ 110 CFM, <0.3 Sones, ENERGY STAR Humidity Sensing Fan	1	\$404.48	HP
Fan/Light/Night Light				
XN110HL	◆ 110 CFM, <0.3 Sones, ENERGY STAR Humidity Sensing Fan with 36W Fluorescent Light (2-18 watt GU24 bulbs included) and 4W Night Light (bulb not included)	1	\$523.64	HP



All models are ENERGY STAR certified products.

- Item too large to ship via UPS/FedEx. Item shipped common carrier at minimum rates.
- * All pricing reflects the individual item cost. You must order in multiples as indicated.
- ◆ UL listed for use over bathtubs and showers when connected to a GFCI protected branch circuit.

Ventilation Fans — ULTRA™

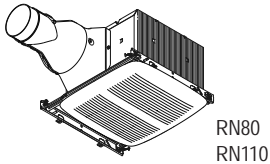

RN80
RN110

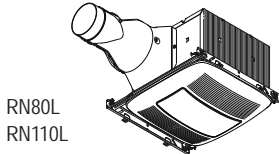

RN80L
RN110L

NuTone® ULTRA™ Pro Fan and Fan/Light Series

The preferred install choice for professionals to deliver quiet performance *ULTRA*Quick™ installation, with no attic access required. QStream™ sound technology features airflow-smoothing baffles to reduce noise caused by turbulence and QFlow™ sound technology that removes the duct damper from the airstream to reduce static pressure. 4" duct for ideal retrofit installation and ENERGY STAR® certified. 10-1/2" x 11-3/8" x 7-5/8" housing fits 2" x 8" ceiling construction. UL Listed for use over bathtubs and showers when connected to a GFCI protected branch circuit.

Model No.	Description	Std. Pk.	List Price	Code
Fans				
RN80	80 CFM, <0.3 Sones, ENERGY STAR Fan	1	\$262.06	HP
RN110	110 CFM, 0.6 Sones, ENERGY STAR Fan	1	\$290.68	HP
Fan/Light				
RN80L	80 CFM, <0.3 Sones, ENERGY STAR Fan/Light, two energy efficient 18W GU24 Fluorescent Lights (bulbs included)	1	\$383.00	HP
RN110L	110 CFM, 0.8 Sones, ENERGY STAR Fan/Light, two energy efficient 18W GU24 Fluorescent Lights (bulbs included)	1	\$408.46	HP



All models are ENERGY STAR certified products.

Ventilation Fans — QT Series™

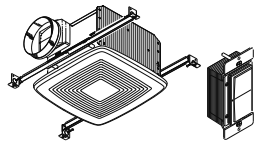

SSQTXE080
SSQTXE110

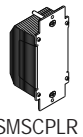

SMSCPLR

Broan SmartSense® Intelligent Ventilation System

The intelligent fan control system creates an integrated residential exhaust ventilation system using Broan's industry leading ventilation control technology and award winning QTXE fans. The Broan SmartSense system uses Broan's Link-Logic™ control technology powered by INSTEON™, a powerful communication technology to monitor everyday manual fan usage throughout the home. Broan SmartSense calculates additional ventilation required by Green Building and ASHRAE Standard 62 related requirements and automatically controls installed fans to achieve proper ventilation. SSQTXE080 and SSQTXE110 fans can provide a single fan solution for small apartments or mix and matched for a customized, integrated ventilation system.

Model No.	Description	Std. Pk.	List Price	Code
SSQTXE080	80 CFM SmartSense Fan with Control	1	\$287.06	HV
SSQTXE110	110 CFM SmartSense Fan with Control	1	\$318.84	HV
SMSCPLR †	SmartSense Phase Coupler	1	\$45.90	AR

† The SmartSense Phase Coupler is only required when fans are located on separate phases of power. If fans are on the same circuit or phase, the phase coupler is not necessary.

Broan® Ventilation Fan with Sensonic™ Speakers and Speaker Kit

Unlike wireless speakers that require counter space, Sensonic speakers with Bluetooth® wireless technology fill your room with rich sound from above. From hard rock to news talk, play any audio through the dual high-fidelity speakers and enjoy entertainment and privacy at the touch of a button. It's brilliant audio performance concealed behind the fan grille.

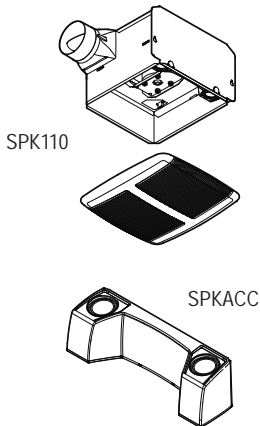

SPK110

SPKACC

Model No.	Description	Std. Pk.	List Price	Code
SPK110	Sensonic Speaker Fan; 110 CFM, 1.0 Sones	1	\$394.84	HV
SPKACC	Sensonic Speaker Accessory	1	\$181.98	AC

- Item too large to ship via UPS/FedEx. Item shipped common carrier at minimum rates.
- * All pricing reflects the individual item cost. You must order in multiples as indicated.
- ◆ UL listed for use over bathtubs and showers when connected to a GFCI protected branch circuit.

Ventilation Fans — QT Series™

NuTone® QT Series™ Fan and Fan/Light/Night Light Series (QTXEN Models)

The industry's quietest, most powerful and stylish fans with a 3 year warranty. 6" ducting for superior performance and ENERGY STAR certified. Includes hanger bar system for fast and flexible installations for all types of construction. 10-1/2" x 11-3/8" x 7-5/8" high housing. 12-7/8" x 13-5/8" grille (QTXEN fans) and 13" x 14" grille (QTXEN fan/lights). Type IC.



QTXEN080
QTXEN110

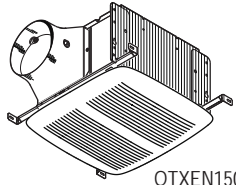

QTXEN150

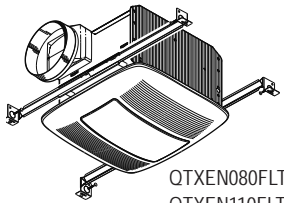

QTXEN080FLT
QTXEN110FLT

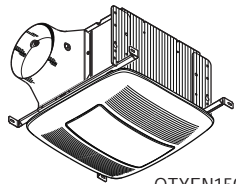

QTXEN150FLT

Model No.	Description	Std. Pk.	List Price	Code
Fans				
QTXEN080 ◆	80 CFM, 0.3 Sones, ENERGY STAR Fan	1	\$252.68	HV
QTXEN110 ◆	110 CFM 0.7 Sones, ENERGY STAR Fan	1	\$285.90	HV
QTXEN150 ◆	150 CFM, 1.4 Sones, ENERGY STAR Fan	1	\$342.46	HV
Fan/Light/Night Light				
QTXEN080FLT ◆	80 CFM, 0.3 Sones, ENERGY STAR Fan with 36W Fluorescent Light (2-18 watt GU24 bulbs included) and 4W Night Light (bulb not included)	1	\$372.34	HV
QTXEN110FLT ◆	110 CFM, 0.7 Sones, ENERGY STAR Fan with 36W Fluorescent Light (2-18 watt GU24 bulbs included) and 4W Night Light (bulb not included)	1	\$412.22	HV
QTXEN150FLT ◆	150 CFM, 1.4 Sones, ENERGY STAR Fan with 36W Fluorescent Light (2-18 watt GU24 bulbs included) and 4W Night Light (bulb not included)	1	\$482.08	HV



All models are ENERGY STAR certified products.

NuTone® LunAura Collection Ambient Ultra Silent™ Fan/Light

Great for any room in the home. The benefits of powerful, ultra silent, ENERGY STAR certified ventilation. Now come with a soft beautiful blue LED night light which delivers improved safety and navigation as well as a calming spa setting.

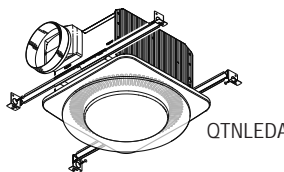

QTNLEDA

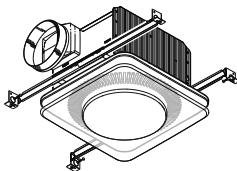

QTNLEDB

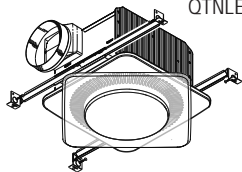

Model No.	Description	Std. Pk.	List Price	Code
QTNLEDA	110 CFM, 0.7 Sones, ENERGY STAR Fan/Light/Night Light with 36 watt (2-18) GU24 bulbs included. 6" or 4" duct. Round design.	1	\$423.30	NF
QTNLEDB	110 CFM, 0.7 Sones, ENERGY STAR Fan/Light/Night Light with 36 watt (2-18) GU24 bulbs included. 6" or 4" duct. Square/Diamond design.	1	\$423.30	NF



All models are ENERGY STAR certified products.

- Item too large to ship via UPS/FedEx. Item shipped common carrier at minimum rates.
- * All pricing reflects the individual item cost. You must order in multiples as indicated.
- ◆ UL listed for use over bathtubs and showers when connected to a GFCI protected branch circuit.

Ventilation Fans — InVent™ Series

NuTone® InVent™ Series Ventilation Fans

New, versatile housing platform that marks a revolution of our mid-range ventilation fans and allows for easy installation in both new construction and retrofit applications. 10" x 9-1/4" x 5-3/4" housing features foldable mounting ears for easy, room-side replacement. 4" duct connector mounts from the inside of the housing and features a new damper technology, improving air tightness scores.

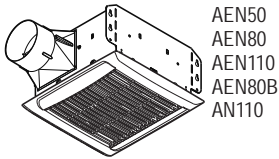

AEN50
AEN80
AEN110
AEN80B
AN110

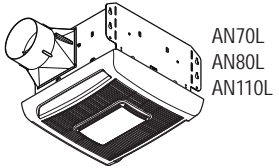

AN70L
AN80L
AN110L

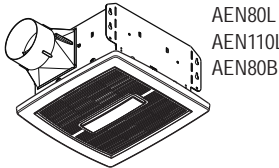

AEN80L
AEN110L
AEN80BL

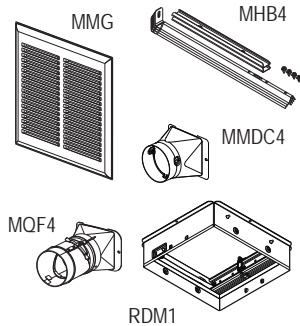

RDM1

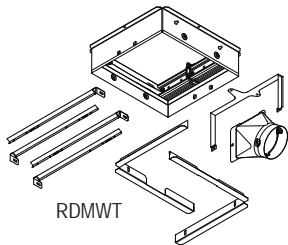

RDMWT

Model No.		Description	Std. Pk.	List Price	Code
Ventilation Fans					
AN110	Ω	110 CFM, 3.0 Sones	1	\$166.68	HM
AEN50	Ω	50 CFM, 0.5 Sones, ENERGY STAR Fan	1	\$166.68	HM
AEN80	Ω	80 CFM, 0.8 Sones, ENERGY STAR Fan	1	\$240.00	HM
AEN110	Ω	110 CFM, 1.3 Sones, ENERGY STAR Fan	1	\$266.68	HM
AEN80B	Ω	80 CFM, 1.5 Sones, ENERGY STAR Fan	1	\$116.68	HM
Ventilation Fan/Lights					
AN70L		70 CFM, 2.0 Sones, Fan/Light	1	\$146.68	HM
AN80L		80 CFM, 1.0 Sones, Fan/Light	1	\$350.00	HM
AN110L		110 CFM, 1.3 Sones, Fan/Light	1	\$383.34	HM
AEN80BL	Ω	LED Light, 80 CFM, 1.5 Sones, ENERGY STAR Fan/Light	1	\$216.66	HM
AEN80L	Ω	LED Light, 80 CFM, 0.8 Sones, ENERGY STAR Fan/Light	1	\$400.00	HM
AEN110L	Ω	LED Light, 110 CFM, 1.3 Sones, ENERGY STAR Fan/Light	1	\$433.34	HM
Accessories					
MHB4		Hanger Bars	1	\$20.00	AC
MMDC4	■	Metal Duct Connector	1	\$25.00	AC
MMG		Metal Grille, White	1	\$43.34	AC
MQF4		QFlow Duct Connector	1	\$20.00	AC
RDM1		Radiation Damper	1	\$166.68	HM
RDMWT		Radiation Damper for UL wood truss assembly listings L521, L528, L546, L558, L562, L574, L576, L581, L583, L585, P522, P533, P538, P545 and P547. Available May, 2017.	1	\$166.68	HM

Ω Works with Model RDM1 and RDMWT radiation damper.



Select models are ENERGY STAR certified products — see product description

■ Limited quantities available.

- Item too large to ship via UPS/FedEx. Item shipped common carrier at minimum rates.
- * All pricing reflects the individual item cost. You must order in multiples as indicated.
- ◆ UL listed for use over bathtubs and showers when connected to a GFCI protected branch circuit.

Ventilation Fans

NuTone® Recessed Fan/Lights

Recessed lights are popular lighting solutions. But NuTone took it a step further by incorporating powerful ventilation in the same design. Our new fan/lights disappear into the ceiling with other recessed lights, so they are practical decorating solutions for any room in the house. In the bath they control humidity, and in a utility room, kitchen or high-traffic family room they keep the air fresh and comfortable. 12-3/4" x 8-1/4" x 6-3/4" high housing. 7-3/8" round trim. Damper/duct connector fits 4" duct. Type IC. Fits 2" x 6" ceiling construction.



744NT
744FLNT
744LEDNT
744SFLNT

Model No.	Description	Std. Pk.	List Price	Code
744NT	◆ Recessed Fan/Light, 70 CFM, 1.5 Sones, 6" white trim. Uses 75W max R30 or BR30 bulb for standard applications.	1	\$171.96	NF
744FLNT	◆ ENERGY STAR Recessed Fan/Light, 70 CFM, 1.5 Sones, 6" white trim. Uses 16W R30 fluorescent bulb (bulb included).	1	\$238.46	NF
744LEDNT	◆ ENERGY STAR Recessed Fan/LED Light, 70 CFM, 1.5 Sones, 6" white trim. Uses 10W BR30 LED bulb (bulb included).	1	\$307.98	NF
744SFLNT	◆ ENERGY STAR Recessed Humidity Sensing Fan/Fluorescent Light, 70 CFM, 1.5 Sones. 6" white trim. Uses 16W R30 fluorescent bulb (bulb included).	1	\$342.68	NF



Select models are ENERGY STAR certified products.

NuTone® LoProfile™ Ventilation Fan

The new NuTone LoProfile™ fan is our latest solution for installations where conventional ventilation simply won't fit. Where multi-family applications require it, the LoProfile™ fan is narrow enough to be installed in a wall between 2 x 4 studs. When plumbing or electrical obstructions are found behind the drywall in ceiling remodel applications our LoProfile™ fan can still fit without having to move anything. And that means most any room with space constraints can have powerful, quiet and efficient ventilation.

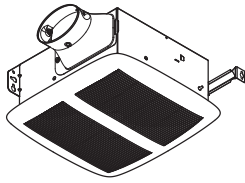

Model No.	Description	Std. Pk.	List Price	Code
LPN80	ENERGY STAR Fan, 80 CFM, 1.0 Sones	1	\$148.96	HV



ENERGY STAR certified product.

- Item too large to ship via UPS/FedEx. Item shipped common carrier at minimum rates.
- * All pricing reflects the individual item cost. You must order in multiples as indicated.
- ◆ UL listed for use over bathtubs and showers when connected to a GFCI protected branch circuit.

Ventilation Fans

NuTone® EZFit Ventilation Fan

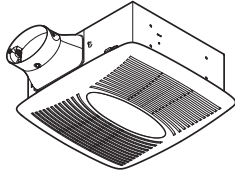

EZFit ventilation fan easily replaces your existing fan in 40 minutes entirely from the room-side. EZLock tabs secure fan directly to drywall, eliminating need for joist/truss mounting. EZConnect wiring connectors eliminate clumsy wire nuts. EZDuct connector allows attachment of existing duct from inside housing so no need to go in the attic. Slim housing fits in virtually all ceiling spaces. Housing dimensions: 12" L x 10-1/2" W x 5" H. Grille dimensions: 12-1/2" L x 13" W.

Model No.	Description	Std. Pk.	List Price	Code
EZ80N	ENERGY STAR Ventilation Fan. 80 CFM, 1.0 Sones	1	\$236.60	HV



ENERGY STAR certified product.

NuTone Basic® Fans

Molded plastic impeller, two-pole motor, 7-1/4" x 7-1/2" x 3-5/8" high galvanized steel housing for ceiling or wall installation. Spring mounted 8-11/16" x 9" plastic grille. Damper/duct connector fits 3" round duct. Snap-in motor plate requires no tools for installation or removals. Fits 2" x 4" ceiling or wall construction.



695
696N

Model No.	Description	Std. Pk.	List Price	Code
695	◆ 70 CFM, 6.0 Sones. Fan — 3" Duct	1	\$59.46	LV
696N	◆ 50 CFM, 4.0 Sones. Fan — 3" Duct	1	\$45.18	LV

All models also available in project packs, see Page 62.

NuTone® Fan/Lights

Powerful fans remove stale air and damaging moisture. 9" x 9" x 6" housing. Damper/duct connector fits 4" round duct. Bright lighting and 7W night light. All models are Type IC. Bulbs not included.

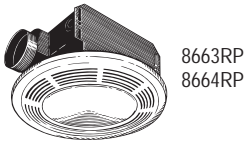

8663RP
8664RP

Model No.	Description	Std. Pk.	List Price	Code
8663RP	100 CFM, 3.5 Sones. Fan/Light/Night Light, Round White Grille with glass lens, 100W max Incandescent Light, 7W Night Light.	1	\$244.08	HV
8664RP	100 CFM, 3.5 Sones. Fan/Light, Round White Grille with glass lens, 100W max Incandescent Light.	1	\$220.04	HV

NuTone® Fan/Lights

Operate fan and light together or independently. Damper/duct connector fits 4" round duct. All models are Type IC. Bulbs not included. Fits 2" x 6" ceiling construction.

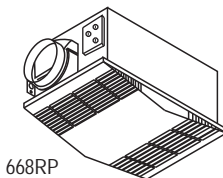

668RP

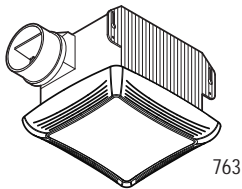

763

Model No.	Description	Std. Pk.	List Price	Code
668RP	◆ 70 CFM, 4.0 Sones. Fan with 100W max incandescent light (bulb not included) — 4" Duct.	1	\$141.06	LV
763	◆ 50 CFM, 2.5 Sones. Fan with 100W max incandescent light (bulb not included) — 4" Duct.	1	\$94.46	LV
MCB2	Mounting Channel/Brackets for Single Packs (2 channels/4 brackets). Works with Model 763.	1	\$14.94	AC

Select models available in project packs, see Page 62.

- Item too large to ship via UPS/FedEx. Item shipped common carrier at minimum rates.
- * All pricing reflects the individual item cost. You must order in multiples as indicated.
- ◆ UL listed for use over bathtubs and showers when connected to a GFCI protected branch circuit.

Ventilation Fans

NuTone® Bath Fan Upgrade Kit

The patented economy fan Bath Fan Upgrade Kit improves performance, reduces the sound level, and upgrades the appearance of your economy fan in 10 minutes. Provide easy upgrade for economy fan without replacing the entire housing, rewiring and reconnecting the duct. Helps ensure tenant/homeowner is using the fan when needed most. Reduces sound up to 50%, improves air movement up to 20% and helps control humidity that causes mold and mildew. Kit includes quiet fan motor, grille, wrench and two motor plates.

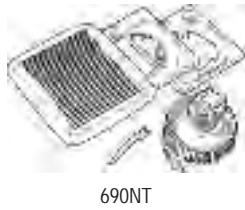

690NT

Model No.	Description	Std. Pk.	List Price	Code
690NT ◆	60 CFM, 3.0 Sones Fan, Economy Upgrade Kit	1	\$59.74	UK

The 690NT Upgrade Kit replaces the models below.

Model No.	Housing Dimension
NuTone: 693, 695 & 696N	7-1/2" x 7-1/4" or 8" x 7-1/4"
Broan: 670, 671, 688 & 689	7-1/2" x 7-1/4" only 8" x 8-1/4" are not compatible.
Nautilus: N671 & N688	

NuTone® Duct-Free Fan

No ductwork necessary! Ideal for powder rooms and closets. Fits in 2" x 4" construction.

Model No.	Description	Std. Pk.	List Price	Code
682NT	Duct-Free Fan with plastic grille. Includes long lasting, easy to replace, activated charcoal filter. Easy snap-in mounting.	1	\$67.62	LV

Ventilation Fans — Project Packs

NuTone® InVent™ Series Project Packs (Housing and Finish Packs)

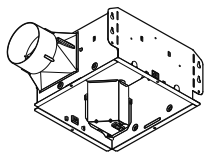

AN000HF

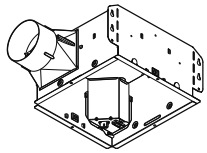

AN000HL

Model No.	Description	Std. Pk.	List Price	Code
Housing Packs				
AN000HF	Ventilation Fan Housing Pack	4 *	\$23.34	HM
AN000HL	Ventilation Fan/Light Housing Pack	4 *	\$23.34	HM
Finish Packs				
AEN50F Ω	50 CFM, 0.5 Sones, ENERGY STAR Finish Pack	4 *	\$143.34	HM
AEN80BF Ω	80 CFM, 1.5 Sones, ENERGY STAR Finish Pack	4 *	\$93.34	HM
AEN80BLF Ω	LED Light, 80 CFM, 1.5 Sones, ENERGY STAR Finish Pack	4 *	\$193.32	HM
AEN80F Ω	80 CFM, 0.8 Sones, ENERGY STAR Finish Pack	4 *	\$216.68	HM
AEN80LF Ω	LED Light, 80 CFM, 0.8 Sones, ENERGY STAR Finish Pack	4 *	\$376.68	HM
AEN110F Ω	110 CFM, 1.3 Sones, ENERGY STAR Finish Pack	4 *	\$243.34	HM
AN70LF	70 CFM, 2.0 Sones, Finish Pack	4 *	\$123.34	HM
AN80HDF ■	80 CFM, 2.0 Sones, Metal Grille, Finish Pack	4 *	\$170.00	HM
AN110F Ω	110 CFM, 3.0 Sones, Finish Pack	4 *	\$143.34	HM

Ω Works with Model RDM1 and RDMWT radiation damper.

■ Limited quantities available.



Select models are ENERGY STAR certified products — see product description.

- Item too large to ship via UPS/FedEx. Item shipped common carrier at minimum rates.
- * All pricing reflects the individual item cost. You must order in multiples as indicated.
- ◆ UL listed for use over bathtubs and showers when connected to a GFCI protected branch circuit.

Ventilation Fans — Project Packs

NuTone® LoProfile™ Project Pack

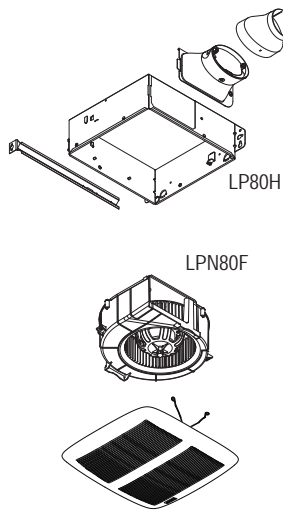

The new NuTone LoProfile™ fan is our latest solution for installations where conventional ventilation simply won't fit. Where multi-family applications require it, the LoProfile™ fan is narrow enough to be installed in a wall between 2 x 4 studs. When plumbing or electrical obstructions are found behind the drywall in ceiling remodel applications, our LoProfile™ fan can still fit without having to move anything. And that means most any room with space constraints can have powerful, quiet and efficient ventilation. Project Packs offer availability to buy housings for rough-in and motor/blower assemblies and grille later for finishing.

Model No.	Description	Std. Pk.	List Price	Code
LP80H	Housing Pack for LPN80	4 *	\$28.04	HV
LPN80F	ENERGY STAR Finish Pack. Motor and Grille Assembly, 80 CFM, 1.0 Sones.	4 *	\$120.92	HV



ENERGY STAR certified products.

NuTone® Radiation Damper Accessory Kit

Model No.	Description	Std. Pk.	List Price	Code
RDFQF	Radiation damper accessory that works with Models SSQTXE110, SSQTXE080, QTREN080, QTREN110, QTXEN050, QTXEN080, QTXEN110, QTRN110F, QTREN110F, QTRN080F and QTREN080F.	1	\$121.24	HV
RDFQL	Radiation damper accessory that works with Models QTREN080FLT, QTREN110FLT, QTXEN080FLT, QTXEN110FLT, QTREN110FLFT and QTREN080FLFT. Also works with Models QTXEN110S and QTXEN110SFLT when used with RDJUMPO accessory.	1	\$121.24	HV
RDFU	Radiation damper accessory that works with Models QTXEN150, QTXEN150FLT, RN80, RN110, XN50, XN80, XN110, ZN80 and ZN110. Also works with Models RN80L, RN110L, XN110HL, ZN110HL, ZN80ML, ZN110ML, XN50L, XN80L, XN110L, ZN80L, ZN110L, XN110H, ZN110H, ZN80M and ZN110M when used with RDJUMPU accessory.	1	\$121.24	HP
RDFUWT	Radiation damper accessory that works with Models QTXEN150, QTXEN150FLT, RN80, RN110, XN50, XN80, XN110, ZN80 and ZN110. Also works with Models RN80L, RN110L, XN110HL, ZN110HL, ZN80ML, ZN110ML, XN50L, XN80L, XN110L, ZN80L, ZN110L, XN110H, ZN110H, ZN80M and ZN110M when used with RDJUMPU accessory. For UL wood truss assembly listings L521, L528, L546, L558, L562, L574, L576, L581, L583, L585, P522, P533, P538, P545 and P547. Available May, 2017.	1	\$121.24	HP
RDJ1	Radiation damper accessory with metal grille and metal duct connector (no housing). Works with 50NT, 80NT, HD50NT and HD80NT.	1	\$141.36	HV
RDF1	Radiation damper. Works with ULTRA® Series non-sensing fans (not fan/lights) and LPN80.	1	\$121.24	HP
Accessories				
RDJUMPO	Wiring jumper kit required for use with RDFQL when used with Models QTXEN110S and QTXEN110SFLT.	1	\$8.44	AC
RDJUMPU	Wiring jumper kit required for use with RDFU when used with Models XN110HL, ZN110HL, ZN80ML, ZN110ML, XN50L, XN80L, XN110L, ZN80L, ZN110L, XN110H, ZN110H, ZN80M and ZN110M.	1	\$16.90	AC
804QDD	4" metal connector for use with QT models.	1	\$18.22	AC

■ Limited quantities available.

- Item too large to ship via UPS/FedEx. Item shipped common carrier at minimum rates.
- * All pricing reflects the individual item cost. You must order in multiples as indicated.
- ◆ UL listed for use over bathtubs and showers when connected to a GFCI protected branch circuit.

NuTone® Fan & Fan/Light Project Packs

NuTone's Project Packs offer a variety of housings packed and sold separately from motor assembly and grille. You can buy housings for rough-in ... by assemblies and grilles later for finishing.

Fan/Light Project Packs — Fits 2" x 6" Ceiling Construction

Model No.	Description	Std. Pk.	List Price	Code
763F	50 CFM, 2.5 Sones, Fan/Light Finish Pack	4 *	\$78.06	LV
763H	50 CFM, 2.5 Sones, Fan/Light Finish Pack	4 *	\$16.40	LV

Basic Fan Project Packs — Fits 2" x 4" Ceiling or Wall Construction

Model No.	Description	Std. Pk.	List Price	Code
690RA	Housing Pack. Housing for 695RB and 696RNB.	6 *	\$9.98	LV
690RMTLA	Series "A" Unit with Metal Duct Collar. Housing for 696RNB and 695RB (replaces 690MTL).	6 *	\$23.24	LV
695RB	◆ Finish Pack. Fan Motor/Grille Assembly. 70 CFM, 6.0 Sones. Uses 690RA housing pack.	6 *	\$49.48	LV
696RNB	◆ Finish Pack. Fan Motor/Grille Assembly. 50 CFM, 4.0 Sones. Uses 690RA housing pack.	6 *	\$35.20	LV

● Item too large to ship via UPS/FedEx. Item shipped common carrier at minimum rates.

* All pricing reflects the individual item cost. You must order in multiples as indicated.

◆ UL listed for use over bathtubs and showers when connected to a GFCI protected branch circuit.

Ventilation Fans — Remote In-Line

NuTone® In-Line Fans

Remote mounted for adaptable and quiet ventilation.

Model No.	Description	Std. Pk.	List Price	Code
ILF120	4" — 110 CFM In-Line Fan, ENERGY STAR certified	1	\$320.94	HV
ILF130	5" — 130 CFM In-Line Fan, ENERGY STAR certified	1	\$336.22	HV
ILF250	6" — 250 CFM In-Line Fan, ENERGY STAR certified	1	\$351.50	HV
ILF360	8" — 360 CFM In-Line Fan	1	\$482.02	HV
ILF530	10" — 530 CFM In-Line Fan	1	\$631.14	HV
ILRF	4"/5" Radon In-Line Fan	1	\$310.64	HV



Select models are ENERGY STAR certified products — see product description.

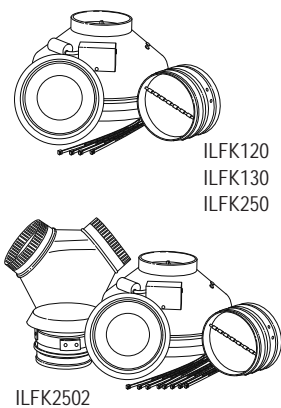

NuTone® In-Line Fan Kits (Complete Installation Kits)

Kit includes all components to install a single dual point exhaust system (except wall control, wire and ducting). Each kit includes fan, damper and duct clamps.

Model No.	Description	Std. Pk.	List Price	Code
ILFK120	4" — 110 CFM In-Line Fan/Grille — Kit, ENERGY STAR certified	1	\$351.50	HV
ILFK130	5" — 130 CFM In-Line Fan/Grille — Kit, ENERGY STAR certified	1	\$366.80	HV
ILFK250	6" — 250 CFM In-Line Fan/Grille — Kit, ENERGY STAR certified	1	\$397.32	HV
ILFK2502	6" — 250 CFM In-Line Fan/Grille — Kit (Includes Y-adaptor and two grilles), ENERGY STAR certified	1	\$458.50	HV



Select models are ENERGY STAR certified products — see product description.

NuTone® In-Line Fan Accessories

Model No.	Description	Std. Pk.	List Price	Code
CVG4	4" Grille	1	\$35.38	AC
CVG6	6" Grille	1	\$47.56	AC
CVLD4	4" Sleeve with Damper	1	\$47.84	AC
CVLD6	6" Sleeve with Damper	1	\$57.12	AC
FY6	6" x 6" x 6" Y-Adaptor	1	\$46.20	AC
FY86	8" x 6" x 6" Y-Adaptor	1	\$35.56	AC

- Item too large to ship via UPS/FedEx. Item shipped common carrier at minimum rates.
- * All pricing reflects the individual item cost. You must order in multiples as indicated.
- ◆ UL listed for use over bathtubs and showers when connected to a GFCI protected branch circuit.

Ventilation Fans — Heater Combinations

NuTone® QT Series™ Heater/Fan/Light

Powerful heating, lighting and ventilation available at the touch of a switch. Quiet, high output 1500 watt heater with exclusive PowerHeat™ design. Requires a dedicated 20 amp circuit. 3 year warranty. 6" ducting for superior performance. 17-5/8" x 11-3/8" x 7-5/8" high housing with hanger bar system. 20" x 15" grille. Fits 2" x 8" ceiling construction.

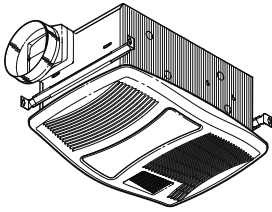

QTXN110HL
QTXN110HFLT



77DW
77DV

Model No.	Description	Std. Pk.	List Price	Code
QTXN110HL	110 CFM, 0.9 Sones, Fan with 1500W heater, 2-60W max incandescent lights and 7W night light (bulbs not included). Recommend 77 Series switch.	1	\$548.52	HV
QTXN110HFLT	110 CFM, 0.9 Sones, Fan with 1500W heater, 2-18W high efficiency, GU24 based fluorescent light (bulbs included) and 7W night light (bulb included) Recommend 77 Series switch.	1	\$610.34	HV
77DW / 77DV	Three-Switch Control for use with sensing Fan/Lights (top switch provides three settings for sensor On/Auto/Off), remaining switches control light, night light and QT Heater/Fan/Light/Night Light (top switch controls light and night light, remaining switches control fan and heater).	1	\$44.60	AC

NuTone® Directionally-Adjustable Heater with Fan and Light

These heaters feature 1500 watts of powerful, directionally-adjustable heat along with 100 CFM of ventilation at only 2.0 sones. They have 4" ducting and fit in 2" x 6" ceiling construction. Attractive grilles are 17-1/2" x 11-1/2" covering a 16" x 10-1/4" x 5-7/8" housing.

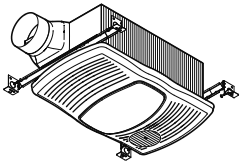

Model No.	Description	Std. Pk.	List Price	Code
765HL	Features 100W max incandescent lighting (bulb not included)	1	\$304.68	LV
765HFL	Features 27W fluorescent lighting (bulb included)	1	\$366.52	LV

NuTone® Heater Combinations with Wall Switch Included

Comfort and convenience combined. Produces instant heat when needed. Select a heater with ventilation fan and/or light with night light (bulbs not included). Housing sizes are noted below and all fit in 2" x 8" ceiling construction.

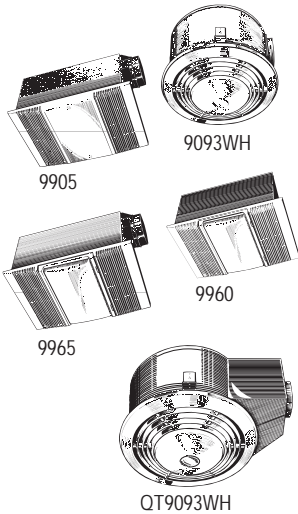

Model No.	Description	Std. Pk.	List Price	Code
9093WH	70 CFM, 3.5 Sones, Combination fan with 1500W heater, 100W incandescent light, 7W night light and white enamel grille. Includes a four-function wall switch. 4" duct connector.	1	\$414.70	HV
9905	70 CFM, 4.0 Sones, Combination fan with 1500W heater. Includes two-function switch. 4" duct connector.	1	\$346.34	HV
9960	1500W heater with 100W max incandescent light and 7W night light. Includes three-function switch.	1	\$313.24	HV
9965	70 CFM, 4.0 Sones, Combination fan with 1500W heater, 100W max incandescent light and 7W night light. Includes four-function switch. 4" duct connector.	1	\$364.42	HV
QT9093WH	110 CFM, 3.0 Sones, Combination fan with 1500W heater, 100W max incandescent light, 7W night light and white enamel grille. Includes a four-function wall switch. 4" duct connector.	1	\$507.64	HV

Rough-in housing sizes: 9093WH — 15-3/8" dia. x 7-1/2"
 9095 — 9-3/4" x 14" x 7-3/4"
 9960 — 9-3/4" x 14" x 7-3/4"
 9965 — 9-3/4" x 14" x 7-3/4"
 QT9093WH — 13-1/4 dia. x 7-1/2"

- Item too large to ship via UPS/FedEx. Item shipped common carrier at minimum rates.
- * All pricing reflects the individual item cost. You must order in multiples as indicated.
- ◆ UL listed for use over bathtubs and showers when connected to a GFCI protected branch circuit.

Ventilation Fans — Heater Combinations

NuTone® Heater Combinations

1300W heating provides optimum performance in smaller spaces. Attractive grille styling. Duct connector with damper fits 4" round duct. 7-7/8" x 14-5/8" x 5-5/8" high housing fits in 2" x 6" ceiling construction.

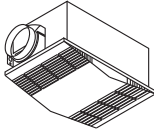

Model No.	Description	Std. Pk.	List Price	Code
605RP	70 CFM, 4.0 Sones, Exhaust fan with 1300W heater	1	\$216.56	LV
665RP	70 CFM, 4.0 Sones, Exhaust fan with 1300W heater and 100W incandescent light (bulb not included).	1	\$218.42	LV

NuTone® Bulb Heaters and Heater/Fans

Produce instant warmth with standard BR40/R40 size 250-watt infrared bulbs (not included). Attractive molded plastic grilles. Damper/duct connector fits 4" round duct (Models 9417DN and 9427P). Models 9412D and 9417DN grilles measure 10-1/4" x 10-1/4". Models 9422P and 9427P grilles measure 10-1/4" x 15-5/8". Housing sizes are noted below. Includes adjustable hanger bar system that spans up to 24". Fits in 2" x 8" ceiling construction.



Model No.	Description	Std. Pk.	List Price	Code
9412D	Single 250W Bulb Heat — Non IC	1	\$51.72	HV
9417DN	Single 250W Bulb Heat with 70 CFM, 4.0 Sones Exhaust Fan — Type IC, UL listed for 60°C wiring (retrofit)	1	\$107.80	HV
9422P	Double 250W Bulb Heat Lamp — Type IC	1	\$86.04	HV
9427P	Double 250W Bulb Heat with 70 CFM, 4.0 Sones Exhaust Fan — Type IC, UL listed for 60°C wiring (retrofit)	1	\$143.84	HV

Rough-in housing sizes: 9412D — 8-3/8" x 8-1/8" x 6"
 9417DN — 8-3/8" x 8-1/8" x 6-3/8"
 9422P — 8-3/8" x 14-1/4" x 6"
 9427P — 8-3/8" x 14-1/4" x 6-3/8"

Ventilation Fans — Utility

NuTone® — Vertical Discharge Fan



Model No.	Description	Std. Pk.	List Price	Code
8210	210 CFM, 6.5 Sones. 7" Round Vertical Discharge	1	\$169.88	HV

NuTone® — Side Discharge Fans

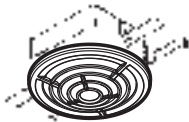

Model No.	Description	Std. Pk.	List Price	Code
8310	160 CFM, 5.0 Sones. 8" Round Side Discharge	1	\$208.24	HV

- Item too large to ship via UPS/FedEx. Item shipped common carrier at minimum rates.
- * All pricing reflects the individual item cost. You must order in multiples as indicated.
- ◆ UL listed for use over bathtubs and showers when connected to a GFCI protected branch circuit.

Ventilation Fans — ULTRA™

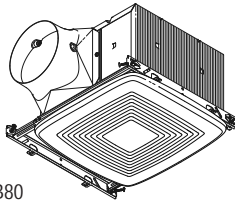

ZB80
ZB110

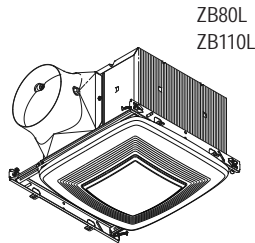

ZB80L
ZB110L

Broan® ULTRA™ Green Multi-Speed Series

We started with installation and worked back to build the ultimate bath fan. Unique telescoping mounting frame is ideal for both new construction and retrofit. No attic access needed! DC motor for efficiency. Multi-speed capability ideal for meeting ASHRAE 62.2, LEED, ENERGY STAR® for Homes and CA Title 24 — as well as local/spot ventilation needs. Powerful operation maintained over a wide range of real-world installations (CFM rating at 0.1" static pressure maintained through 0.25" static pressure). Fits in 2" x 8" ceiling construction. 10-1/2" L x 11-3/8" W x 7-5/8" H housing. 13" x 14" grille (fan) and 13" x 13-1/4" (fan/light/night light). All models have a 6" duct connector and the 50 CFM and 80 CFM models include a 6" to 4" reducer. All ULTRA 80 and 110 CFM fans can also be used with the MD6TU universal make-up air damper if 6" rigid duct is used. ULTRA non-sensing fans (not fan/lights) can also be used with the RDF1 radiation damper. Now with QStream sound technology that features airflow-smoothing baffles to reduce noise caused by turbulence (50 and 80 CFM models only).

Model No.	Description	Std. Pk.	List Price	Code
Fans				
ZB80	◆ 30 CFM to 80 CFM, <0.3 Sones, ENERGY STAR Fan	1	\$308.94	HP
ZB110	◆ 30 CFM to 110 CFM, <0.3 Sones, ENERGY STAR Fan	1	\$337.68	HP
Fan/Light/Night Light				
ZB80L	◆ 30 CFM to 80 CFM, <0.3 Sones, ENERGY STAR Fan with 36W Fluorescent Light (2-18 watt GU24 bulbs included) and 4W Night Light (bulb not included)	1	\$423.68	HP
ZB110L	◆ 30 CFM to 110 CFM, <0.3 Sones, ENERGY STAR Fan with 36W Fluorescent Light (2-18 watt GU24 bulbs included) and 4W Night Light (bulb not included)	1	\$454.76	HP



All models are ENERGY STAR certified products.

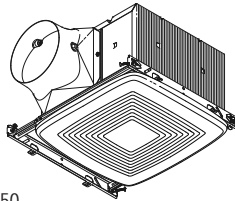

XB50
XB80
XB110

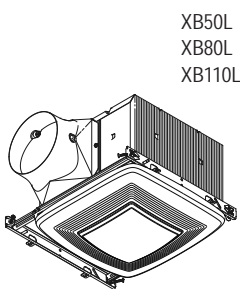

XB50L
XB80L
XB110L

Broan® ULTRA™ Green Single-Speed Series

We started with installation and worked back to build the ultimate bath fan. Unique telescoping mounting frame is ideal for both new construction and retrofit. No attic access needed! DC motor for efficiency. ASHRAE 62.2, LEED, ENERGY STAR® for Homes and CA Title 24 compliant. Powerful operation maintained over a wide range of real-world installations (CFM rating at 0.1" static pressure maintained through 0.25" static pressure). Fits in 2" x 8" ceiling construction. 10-1/2" L x 11-3/8" W x 7-5/8" H housing. 13" x 14" grille (fan) and 13" x 13-1/4" (fan/light/night light). All models have a 6" duct connector and the 50 CFM and 80 CFM models include a 6" to 4" reducer. All ULTRA 80 and 110 CFM fans can also be used with the MD6TU universal make-up air damper if 6" rigid duct is used. ULTRA non-sensing fans (not fan/lights) can also be used with the RDF1 radiation damper. Now with QStream sound technology that features airflow-smoothing baffles to reduce noise caused by turbulence (50 and 80 CFM models only).

Model No.	Description	Std. Pk.	List Price	Code
Fans				
XB50	◆ 50 CFM, <0.3 Sones, ENERGY STAR Fan	1	\$264.80	HP
XB80	◆ 80 CFM, <0.3 Sones, ENERGY STAR Fan	1	\$281.14	HP
XB110	◆ 110 CFM, <0.3 Sones, ENERGY STAR Fan	1	\$301.50	HP
Fan/Light/Night Light				
XB50L	◆ 50 CFM, <0.3 Sones, ENERGY STAR Fan with 36W Fluorescent Light (2-18 watt GU24 bulbs included) and 4W Night Light (bulb not included)	1	\$373.90	HP
XB80L	◆ 80 CFM, <0.3 Sones, ENERGY STAR Fan with 36W Fluorescent Light (2-18 watt GU24 bulbs included) and 4W Night Light (bulb not included)	1	\$403.14	HP
XB110L	◆ 110 CFM, <0.3 Sones, ENERGY STAR Fan with 36W Fluorescent Light (2-18 watt GU24 bulbs included) and 4W Night Light (bulb not included)	1	\$416.52	HP



All models are ENERGY STAR certified products.

- Item too large to ship via UPS/FedEx. Item shipped common carrier at minimum rates.
- * All pricing reflects the individual item cost. You must order in multiples as indicated.
- ◆ UL listed for use over bathtubs and showers when connected to a GFCI protected branch circuit.

Ventilation Fans — ULTRA™

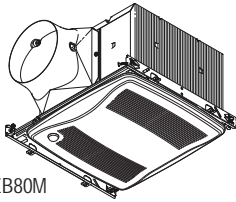

ZB80M
ZB110M

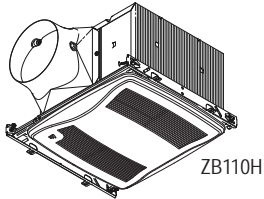

ZB110H

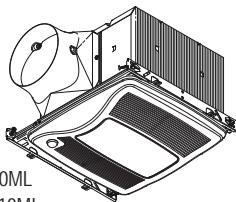

ZB80ML
ZB110ML

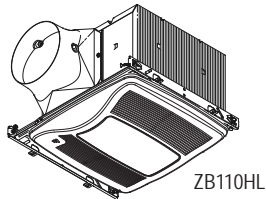

ZB110HL

Broan® ULTRA™ Green Multi-Speed Series — Sensing

We started with installation and worked back to build the ultimate bath fan. Unique telescoping mounting frame is ideal for both new construction and retrofit. No attic access needed! DC motor for efficiency. Multi-speed capability ideal for meeting ASHRAE 62.2, LEED, ENERGY STAR® for Homes and CA Title 24 — as well as local/spot ventilation needs. Humidity or motion sensing triggers fan to ramp up from lower continuous ventilation level to maximum CFM. Powerful operation maintained over a wide range of real-world installations (CFM rating at 0.1" static pressure maintained through 0.25" static pressure). Fits in 2" x 8" ceiling construction. 10-1/2" L x 11-3/8" W x 7-5/8" H housing. 13" x 14" grille (fan) and 13" x 13-1/4" (fan/light/night light). All models have a 6" duct connector and the 80 CFM models include a 6" to 4" reducer. All ULTRA 80 and 110 CFM fans can also be used with the MD6TU universal make-up air damper if 6" rigid duct is used. ULTRA non-sensing fans (not fan/lights) can also be used with the RDF1 radiation damper. Now with QStream sound technology that features airflow-smoothing baffles to reduce noise caused by turbulence (50 and 80 CFM models only).

Model No.	Description	Std. Pk.	List Price	Code
Fans				
ZB80M	◆ 80 CFM, <0.3 Sones, ENERGY STAR Motion Sensing Fan	1	\$356.76	HP
ZB110H	◆ 110 CFM, <0.3 Sones, ENERGY STAR Humidity Sensing Fan	1	\$448.82	HP
ZB110M	◆ 110 CFM, <0.3 Sones, ENERGY STAR Motion Sensing Fan	1	\$383.74	HP
Fan/Light/Night Light				
ZB80ML	◆ 80 CFM, <0.3 Sones, ENERGY STAR Motion Sensing Fan with 36W Fluorescent Light (2-18 watt GU24 bulbs included) and 4W Night Light (bulb not included)	1	\$478.38	HP
ZB110HL	◆ 110 CFM, <0.3 Sones, ENERGY STAR Humidity Sensing Fan with 36W Fluorescent Light (2-18 watt GU24 bulbs included) and 4W Night Light (bulb not included)	1	\$570.70	HP
ZB110ML	◆ 110 CFM, <0.3 Sones, ENERGY STAR Motion Sensing Fan with 36W Fluorescent Light (2-18 watt GU24 bulbs included) and 4W Night Light (bulb not included)	1	\$511.80	HP



All models are ENERGY STAR certified products.

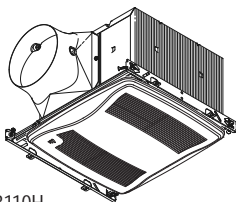

XB110H

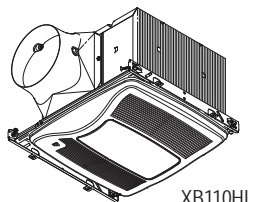

XB110HL

Broan® ULTRA™ Green Single-Speed Series — Sensing

We started with installation and worked back to build the ultimate bath fan. Unique telescoping mounting frame is ideal for both new construction and retrofit. No attic access needed! ASHRAE 62.2, LEED, ENERGY STAR® for Homes and CA Title 24 compliant. Humidity sensing models will automatically turn fan on when rapid rise in humidity is sensed. Powerful operation maintained over a wide range of real-world installations (CFM rating at 0.1" static pressure maintained through 0.25" static pressure). Fits in 2" x 8" ceiling construction. 10-1/2" L x 11-3/8" W x 7-5/8" H housing. 13" x 14" grille (fan) and 13" x 13-1/4" (fan/light/night light). All models have a 6" duct connector. All ULTRA 80 and 110 CFM fans can also be used with the MD6TU universal make-up air damper if 6" rigid duct is used. ULTRA non-sensing fans (not fan/lights) can also be used with the RDF1 radiation damper. Now with QStream sound technology that features airflow-smoothing baffles to reduce noise caused by turbulence (50 and 80 CFM models only).

Model No.	Description	Std. Pk.	List Price	Code
Fan				
XB110H	◆ 110 CFM, <0.3 Sones, ENERGY STAR Humidity Sensing Fan	1	\$404.48	HP
Fan/Light/Night Light				
XB110HL	◆ 110 CFM, <0.3 Sones, ENERGY STAR Humidity Sensing Fan with 36W Fluorescent Light (2-18 watt GU24 bulbs included) and 4W Night Light (bulb not included)	1	\$523.64	HP



All models are ENERGY STAR certified products.

- Item too large to ship via UPS/FedEx. Item shipped common carrier at minimum rates.
- * All pricing reflects the individual item cost. You must order in multiples as indicated.
- ◆ UL listed for use over bathtubs and showers when connected to a GFCI protected branch circuit.

Ventilation Fans — ULTRA™

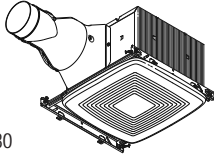

RB80
RB110

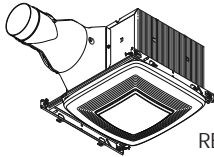

RB80L
RB110L

Broan® ULTRA™ Pro Fan and Fan/Light Series

The preferred install choice for professionals to deliver quiet performance *ULTRA*Quick™ installation, with no attic access required. QStream™ sound technology features airflow-smoothing baffles to reduce noise caused by turbulence and QFlow™ sound technology that removes the duct damper from the airstream to reduce static pressure. 4" duct for ideal retrofit installation and ENERGY STAR® qualified. 10-1/2" x 11-3/8" x 7-5/8" housing fits 2" x 8" ceiling construction. UL Listed for use over bathtubs and showers when connected to a GFCI protected branch circuit.

Model No.	Description	Std. Pk.	List Price	Code
Fans				
RB80	80 CFM, <0.3 Sones, ENERGY STAR Fan	1	\$262.06	HP
RB110	110 CFM, 0.6 Sones, ENERGY STAR Fan	1	\$290.68	HP
Fan/Light				
RB80L	80 CFM, <0.3 Sones, ENERGY STAR Fan/Light, two energy efficient 18W GU24 Fluorescent Lights (bulbs included)	1	\$383.00	HP
RB110L	110 CFM, 0.8 Sones, ENERGY STAR Fan/Light, two energy efficient 18W GU24 Fluorescent Lights (bulbs included)	1	\$408.46	HP



All models are ENERGY STAR certified products.

Ventilation Fans — QT Series™

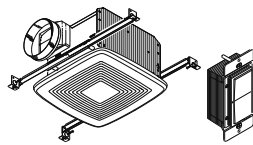

SSQTXE080
SSQTXE110



SMSCPLR

Broan SmartSense® Intelligent Ventilation System

The intelligent fan control system creates an integrated residential exhaust ventilation system using Broan's industry leading ventilation control technology and award winning QTXE fans. The Broan SmartSense system uses Broan's Link-Logic™ control technology powered by INSTEON™, a powerful communication technology to monitor everyday manual fan usage throughout the home. Broan SmartSense calculates additional ventilation required by Green Building and ASHRAE Standard 62 related requirements and automatically controls installed fans to achieve proper ventilation. SSQTXE080 and SSQTXE110 fans can provide a single fan solution for small apartments or mix and matched for a customized, integrated ventilation system.

Model No.	Description	Std. Pk.	List Price	Code
SSQTXE080	80 CFM SmartSense Fan with Control	1	\$287.06	HV
SSQTXE110	110 CFM SmartSense Fan with Control	1	\$318.84	HV
SMSCPLR †	SmartSense Phase Coupler	1	\$45.90	AR

† The SmartSense Phase Coupler is only required when fans are located on separate phases of power. If fans are on the same circuit or phase, the phase coupler is not necessary.

Broan® Ventilation Fan with Sensonic™ Speakers and Speaker Kit

Unlike wireless speakers that require counter space, Sensonic speakers with Bluetooth® wireless technology fill your room with rich sound from above. From hard rock to news talk, play any audio through the dual high-fidelity speakers and enjoy entertainment and privacy at the touch of a button. It's brilliant audio performance concealed behind the fan grille.

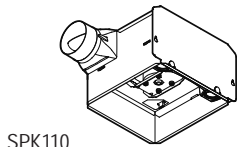

SPK110

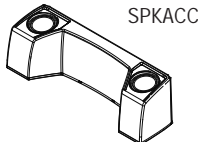

SPKACC

Model No.	Description	Std. Pk.	List Price	Code
SPK110	Sensonic Speaker Fan; 110 CFM, 1.0 Sones	1	\$394.84	HV
SPKACC	Sensonic Speaker Accessory	1	\$181.98	AC

- Item too large to ship via UPS/FedEx. Item shipped common carrier at minimum rates.
- * All pricing reflects the individual item cost. You must order in multiples as indicated.
- ◆ UL listed for use over bathtubs and showers when connected to a GFCI protected branch circuit.

Ventilation Fans — QT Series™

Broan® QT Series™ (QTXE Models)

The industry's quietest, most powerful and stylish fans with a 3 year warranty. 6" ducting for superior performance and ENERGY STAR certified. Includes hanger bar system for fast and flexible installations for all types of construction. Fits in 2" x 8" ceiling construction. 10-1/2" x 11-3/8" x 7-5/8" high housing. 14" x 15" grille (QTXE fans) and 13-3/8" x 14-1/4" grille (QTXE fan/lights).

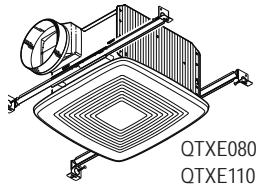

QTXE080
QTXE110

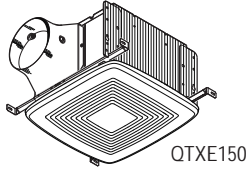

QTXE150

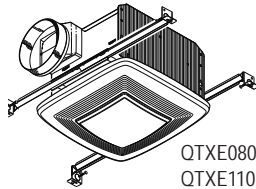

QTXE080FLT
QTXE110FLT

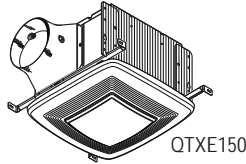

QTXE150FLT

Model No.	Description	Std. Pk.	List Price	Code
Fans				
QTXE080 ◆	80 CFM, 0.3 Sones, ENERGY STAR Fan	1	\$252.68	HV
QTXE110 ◆	110 CFM, 0.7 Sones, ENERGY STAR Fan	1	\$285.90	HV
QTXE150 ◆	150 CFM, 1.4 Sones, ENERGY STAR Fan	1	\$342.46	HV
Fan/Light/Night Light				
QTXE080FLT ◆	80 CFM, 0.3 Sones, ENERGY STAR Fan with 36W Fluorescent Light (2-18 watt GU24 bulbs included) and 4W Night Light (bulb not included)	1	\$372.34	HV
QTXE110FLT ◆	110 CFM, 0.7 Sones, ENERGY STAR Fan with 36W Fluorescent Light (2-18 watt GU24 bulbs included) and 4W Night Light (bulb not included)	1	\$412.22	HV
QTXE150FLT ◆	150 CFM, 1.4 Sones, ENERGY STAR Fan with 36W Fluorescent Light (2-18 watt GU24 bulbs included) and 4W Night Light (bulb not included)	1	\$482.08	HV



All models are ENERGY STAR certified products.

Broan® QT Series™ Humidity Sensing Fan and Fan/Light

Humidity sensing integrated in a ventilation fan is another industry exclusive! Featuring Sensaire® technology and models that are ENERGY STAR® certified, this Ultra Silent™ Humidity Sensing fan is the most effective way to control excess humidity and moisture, even in the most frequently used bathrooms. Homeowners and property managers will appreciate the fact that Broan's humidity sensing fan is automatic — once there is a rapid rise in humidity, the fan will automatically turn on to exhaust excess moisture and turn off once the job is done. The industry's quietest, most powerful and stylish fan with a 3 year warranty. 6" ducting for superior performance. Fits 2" x 8" ceiling construction. 10-1/2 x 11-3/8" x 7-5/8" high housing. 13" x 13-3/4" grille.

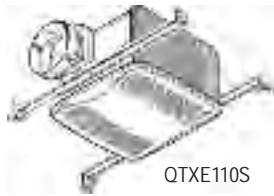

QTXE110S

Model No.	Description	Std. Pk.	List Price	Code
Fan				
QTXE110S ◆	110 CFM, 0.7 Sones, ENERGY STAR Humidity Sensing Fan	1	\$400.62	HV

Broan® InVent Series Sensing Ventilation Fans and Fan/Lights

Introducing the InVent Series humidity sensing fan and fan/light. Building on the innovative features of the InVent Series, the humidity sensing product line will utilize our patented Sensaire™ sense-on-rise technology. The sensor has a user adjustable sensitivity control that simultaneously adjusts the humidity rate-of-rise sensitivity and the humidity set point. In addition to the flexible installation, this humidity sensing product line features LED lighting.

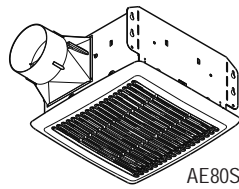

AE80S
AE110S

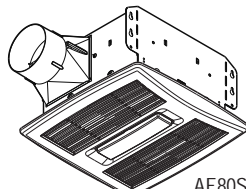

AE80SL
AE110SL

Model No.	Description	Std. Pk.	List Price	Code
Fan				
AE80S	80 CFM, 0.8 Sones, ENERGY STAR Sensing Fan	1	\$326.50	HM
AE110S	110 CFM, 1.0 Sones, ENERGY STAR Sensing Fan	1	\$353.98	HM
Fan/Light				
AE80SL	80 CFM, 0.8 Sones, ENERGY STAR Sensing Fan with LED Light	1	\$429.10	HM
AE110SL	110 CFM, 1.0 Sones, ENERGY STAR Sensing Fan with LED Light	1	\$489.30	HM
Housing Pack				
A000HFS	Sensing Fan Housing Pack — Fan Models Only (Compatible with AE80F and AE110F finish packs.)	4 *	\$103.34	HM

● Item too large to ship via UPS/FedEx. Item shipped common carrier at minimum rates.

* All pricing reflects the individual item cost. You must order in multiples as indicated.

◆ UL listed for use over bathtubs and showers when connected to a GFCI protected branch circuit.

Ventilation Fans — InVent™ Series

Broan® InVent™ Series Ventilation Fans

New, versatile housing platform that marks a revolution of our mid-range ventilation fans and allows for easy installation in both new construction and retrofit applications. 10" x 9-1/4" x 5-3/4" housing features foldable mounting ears for easy, room-side replacement. 4" duct connector mounts from the inside of the housing and features a new damper technology, improving air tightness scores.

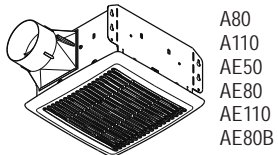

A80
A110
AE50
AE80
AE110
AE80B

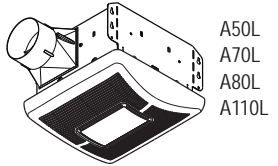

A50L
A70L
A80L
A110L

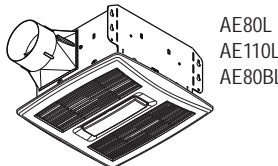

AE80L
AE110L
AE80BL

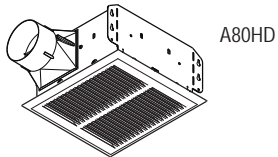

A80HD

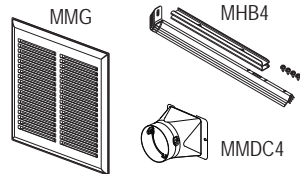

MMG

MHB4

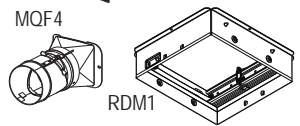

MQF4

MMDC4

RDM1

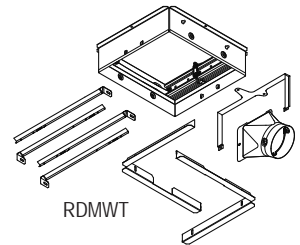

RDMWT

Model No.		Description	Std. Pk.	List Price	Code
Ventilation Fans					
A80	Ω	80 CFM, 2.0 Sones	1	\$150.00	HM
A110	Ω	110 CFM, 3.0 Sones	1	\$166.68	HM
A80HD	Ω	80 CFM, 2.0 Sones, Metal Grille	1	\$193.34	HM
AE50	Ω	50 CFM, 0.5 Sones, ENERGY STAR Fan	1	\$166.68	HM
AE80	Ω	80 CFM, 0.8 Sones, ENERGY STAR Fan	1	\$240.00	HM
AE110	Ω	110 CFM, 1.3 Sones, ENERGY STAR Fan	1	\$266.68	HM
AE80B	Ω	80 CFM, 1.5 Sones, ENERGY STAR Fan	1	\$116.68	HM
Ventilation Fan/Lights					
A50L		50 CFM, 1.5 Sones	1	\$145.00	HM
A70L		70 CFM, 2.0 Sones	1	\$146.68	HM
A80L		80 CFM, 1.0 Sones	1	\$350.00	HM
A110L		110 CFM, 1.3 Sones	1	\$383.34	HM
AE80BL	Ω	LED Light, 80 CFM, 1.5 Sones, ENERGY STAR Fan/Light	1	\$216.66	HM
AE80L	Ω	LED Light, 80 CFM, 0.8 Sones, ENERGY STAR Fan/Light	1	\$400.00	HM
AE110L	Ω	LED Light, 110 CFM, 1.3 Sones, ENERGY STAR Fan/Light	1	\$433.34	HM
Accessories					
MHB4		Hanger Bars	1	\$20.00	AC
MMDC4	■	Metal Duct Connector	1	\$25.00	AC
MMG		Metal Grille, White	1	\$43.34	AC
MQF4		QFlow Duct Connector	1	\$20.00	AC
RDM1		Radiation Damper	1	\$166.68	HM
RDMWT		Radiation Damper for UL wood truss assembly listings L521, L528, L546, L558, L562, L574, L576, L581, L583, L585, P522, P533, P538, P545 and P547. Available May, 2017.	1	\$166.68	HM

Ω Works with Model RDM1 and RDMWT radiation damper. Sensing models work with RDMTW only.



Select models are ENERGY STAR certified products— see product description.

■ Limited quantities available.

- Item too large to ship via UPS/FedEx. Item shipped common carrier at minimum rates.
- * All pricing reflects the individual item cost. You must order in multiples as indicated.
- ◆ UL listed for use over bathtubs and showers when connected to a GFCI protected branch circuit.

Ventilation Fans

Broan® Recessed Fan/Lights

Recessed lights are popular lighting solutions. But Broan took it a step further by incorporating powerful ventilation in the same design. Our new fan/lights disappear into the ceiling with other recessed lights, so they are practical decorating solutions for any room in the house. In the bath they control humidity, and in a utility room, kitchen or high-traffic family room they keep the air fresh and comfortable. 12-3/4" x 8-1/4" x 6-3/4" high housing. 7-3/8" round trim. Damper/duct connector fits 4" duct. Type IC. Fits in 2" x 8" ceiling construction.

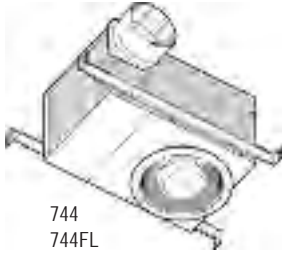

744
744FL
744LED
744SFL

Model No.	Description	Std. Pk.	List Price	Code
744	◆ Recessed Fan/Light, 70 CFM, 1.5 Sones. 6" white trim. Use 75W max R30 or BR30 bulb for standard applications.	1	\$171.96	NF
744FL	◆ Recessed Fan/Fluorescent Light, ENERGY STAR, 70 CFM, 1.5 Sones. 6" white trim. Uses 16W R30 fluorescent bulb (bulb included).	1	\$238.46	NF
744LED	◆ Recessed Fan/LED Light, ENERGY STAR, 70 CFM, 1.5 Sones. 6" white trim. Uses 10W BR30 LED bulb (bulb included).	1	\$307.98	NF
744SFL	◆ ENERGY STAR Recessed Humidity Sensing Fan/Fluorescent Light, 70 CFM, 1.5 Sones. 6" white trim. Uses 16W R30 fluorescent bulb (bulb included).	1	\$342.68	NF



Select models are ENERGY STAR certified products — see product description.

Broan® Ventilation Fan with Soft Surround™ LED Lighting Technology

Powerful, uniquely designed ventilation fan with LED light removes stale air and moisture from bathrooms. HVI certified at 110 CFM, 1.5 Sones. 9-1/4" x 10" x 5-3/4" housing. Damper/duct connector fits 4" round duct. Energy efficient 9 watt LED light is integrated into the unique, low profile grille. The perimeter lighting provides outstanding room coverage and the lens has quality diffusion that eliminates hot spots for a soft yet bright glow. Up to 25,000 hour life means the light may never have to be replaced.

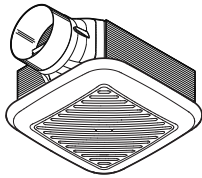

Model No.	Description	Std. Pk.	List Price	Code
791LEDM	ENERGY STAR Ventilation Fan with LED lighting, 110 CFM, 1.5 Sones. Uses 9W integrated LED module (included).	1	\$252.36	HM



ENERGY STAR certified products.

Broan® Decorative Fan/Light

Styling that takes decorative light/fans to the next level. Designs are attractive as lights alone and make no concessions to ventilation function. Styles cover a range of decorating tastes from antique to contemporary. All accept two 60-watt max incandescent bulbs (bulbs not included). Corrosion-resistant finishes. Plug-in light fixture assemblies. Plug-in permanently lubricated motors. 8" x 8-1/4" x 5-3/4" high housing. 4" round duct connectors. Type IC. Fits in 2" x 6" ceiling construction.

741SN



754RB

761BN
761RB
761WHA

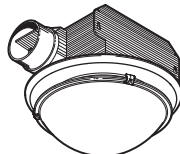

Model No.	Description	Std. Pk.	List Price	Code
741SN	Decorative Satin Nickel Fan/Light with frosted glass, 70 CFM, 3.5 Sones. 13-3/8" diameter base.	1	\$173.40	HV
754RB	Decorative Oil-Rubbed Bronze Fan/Light, white alabaster glass, 70 CFM, 3.5 Sones. 13-3/8" diameter base.	1	\$176.20	HV
761BN	Decorative Brushed Nickel Fan/Light, with opal glass, 80 CFM, 2.5 Sones. 13-1/4" diameter base.	1	\$189.40	HV
761RB	Decorative Oil-Rubbed Bronze Fan/Light, with ivory alabaster glass, 80 CFM, 2.5 Sones. 13-1/4" diameter base.	1	\$189.40	HV
761WHA	Decorative White Fan/Light, with white alabaster glass, 80 CFM, 2.5 Sones. 13-1/4" diameter base.	1	\$189.40	HV
MCB2	Mounting Channel/Brackets for single packs (2 channels, 4 brackets).	1	\$14.94	AC

● Item too large to ship via UPS/FedEx. Item shipped common carrier at minimum rates.

* All pricing reflects the individual item cost. You must order in multiples as indicated.

◆ UL listed for use over bathtubs and showers when connected to a GFCI protected branch circuit.

Ventilation Fans

Broan® LoProfile™ Ventilation Fan

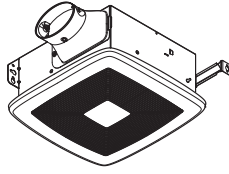

The new Broan LoProfile™ fan is our latest solution for installations where conventional ventilation simply won't fit. Where multi-family applications require it, the LoProfile™ fan is narrow enough to be installed in a wall between 2 x 4 studs. When plumbing or electrical obstructions are found behind the drywall in ceiling remodel applications our LoProfile™ fan can still fit without having to move anything. And that means most any room with space constraints can have powerful, quiet and efficient ventilation.

Model No.	Description	Std. Pk.	List Price	Code
Fan LP80	80 CFM, 1.0 Sones, ENERGY STAR Fan.	1	\$148.96	HV



ENERGY STAR certified products.

Broan® Heavy Duty™ Fan/Light



Heavy Duty™ fan/light was designed for continuous operation — perfect for tough, light-commercial applications. Motor has heavy duty, long-life bearings, tamper proof construction, and is totally enclosed for added protection against dirt and dust. Centrifugal blower wheel provides quiet, efficient ventilation. Convenient mounting ears speed installation. Fan/light unit has white molded 11-1/8" x 10-5/8" polymeric grille and shatter-resistant light lens. 8" x 8-1/4" x 5-3/4" high housing. Damper/duct connector fits 4" round duct. Type IC (Insulation Contact). Fits in 2" x 6" ceiling construction.

Model No.	Description	Std. Pk.	List Price	Code
HD80L ♦	Heavy Duty Fan/Light, 80 CFM, 2.5 Sones. 100W max Incandescent Light (bulb not included). Type IC.	1	\$154.68	HV
MCB2	Mounting Channel/Brackets for single packs (2 channels, 4 brackets).	1	\$14.94	AC

Broan® Radiation Damper Project Packs

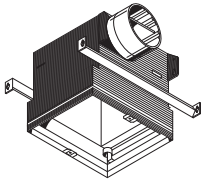

RDH

Model No.	Description	Std. Pk.	List Price	Code
RDH	Housing with radiation damper attached	4 *	\$138.76	HV
80RDF	80 CFM motor with metal grille finish pack	4 *	\$109.24	HV
110RDF	110 CFM motor with metal grille finish pack	4 *	\$114.96	HV
HD50RDF	Heavy duty 50 CFM motor with metal grille finish pack	4 *	\$120.88	HV

Broan® Metal Grille Kit — Selected Ventilation Fans



Everything you need to furnish a metal grille for most standard Broan exhaust fans. Spring-mounted hardware included.

Model No.	Description	Std. Pk.	List Price	Code
S97011308	White Metal Grille Kit, fits Models 670, 671, 688 & 689	1	\$45.60	PT

Broan® Fan/Lights

9" x 9" x 6" housing. Damper/duct connector fits 4" round duct. Bright 100-watt max light capacity. All models are Type IC. Bulbs not included. Fits in 2" x 6" ceiling construction.



750
751

Model No.	Description	Std. Pk.	List Price	Code
750 ♦	Fan/Light/Night Light, 100 CFM, 3.5 Sones, round white grille with glass lens	1	\$244.08	HV
751 ♦	Fan/Light, 100 CFM, 3.5 Sones, round white grille with glass lens	1	\$220.04	HV
MCB2	Mounting Channel/Brackets for single packs (2 channels, 4 brackets).	1	\$14.94	AC

- Item too large to ship via UPS/FedEx. Item shipped common carrier at minimum rates.
- * All pricing reflects the individual item cost. You must order in multiples as indicated.
- ♦ UL listed for use over bathtubs and showers when connected to a GFCI protected branch circuit.

Ventilation Fans

Broan® Economy Fans

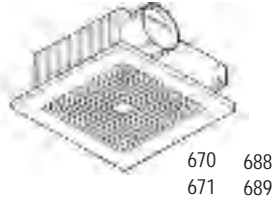

Molded plastic impeller, two-pole motor, 7-1/4" x 7-1/2" x 3-5/8" high galvanized steel housing for ceiling or wall installation. Spring mounted 9-1/4" x 9" plastic grille. Damper/duct connector fits 3" round duct. Snap-in motor plate requires no tools for installation or removal. Fits 2" x 4" ceiling or wall construction.

Model No.	Description	Std. Pk.	List Price	Code
670 ◆	Ventilation Fan, 50 CFM, 3.5 Sones	1	\$65.02	LV
671 ◆	Ventilation Fan, 70 CFM, 6.0 Sones	1	\$59.46	LV
688 ◆	Ventilation Fan, 50 CFM, 4.0 Sones	1	\$45.18	LV
689 ◆	Ventilation Fan, 60 CFM, 5.5 Sones	1	\$56.26	LV

All models available in project packs, see Page 76.

Broan® Economy Fan/Light



Compact unit provides ventilator and 100-watt light capacity in one unit (bulb not included). Molded 11-1/8" x 10-5/8" plastic grille and shatter-resistant lens. 8" x 8-1/4" x 5-3/4" high housing. Fits 4" round duct. Fits in 2" x 6" ceiling construction.

Model No.	Description	Std. Pk.	List Price	Code
678 ◆	50 CFM, 2.5 Sones Fan/Light. Type IC.	1	\$97.30	LV
MCB2	Mounting Channel/Brackets for single packs (2 channels, 4 brackets).	1	\$14.94	AC

All models available in project packs, see Page 76.

Broan® Bath Fan Upgrade Kit

The patented economy fan Bath Fan Upgrade Kit improves performance, reduces the sound level, and upgrades the appearance of your economy fan in 10 minutes. Provide easy upgrade for economy fan without replacing the entire housing, rewiring and reconnecting the duct. Helps ensure tenant/homeowner is using the fan when needed most. Reduces sound up to 50%, improves air movement up to 20% and helps control humidity that causes mold and mildew. Kit includes quiet fan motor, grille, wrench and two motor plates.

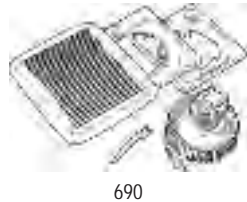

Model No.	Description	Std. Pk.	List Price	Code
690	60 CFM, 3.0 Sones, Economy Upgrade Kit	1	\$59.74	UK

The 690 Upgrade Kit replaces the models below.

Model No.	Housing Dimension
Broan: 670, 671, 688 & 689	7-1/2" x 7-1/4" only 8" x 8-1/4" are not compatible.
Nautilus: N671 & N688	
NuTone: 693, 695 & 696N	7-1/2" x 7-1/4" or 8" x 7-1/4"

Broan® Duct-Free Fan

No ductwork necessary! Ideal for powder rooms and closets. Type IC (Insulation Contact). Fits in 2" x 4" construction.

Model No.	Description	Std. Pk.	List Price	Code
682	Duct-free Fan with plastic grille. Includes long lasting, easy to replace activated charcoal filter. Easy snap-in mounting.	1	\$67.62	LV

- Item too large to ship via UPS/FedEx. Item shipped common carrier at minimum rates.
- * All pricing reflects the individual item cost. You must order in multiples as indicated.
- ◆ UL listed for use over bathtubs and showers when connected to a GFCI protected branch circuit.

Ventilation Fans — Project Packs

Broan® InVent™ Series Project Packs (Housing and Finish Packs)

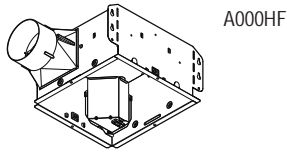

A000HF

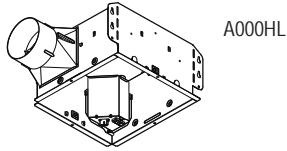

A000HL

Model No.	Description	Std. Pk.	List Price	Code
Housing Packs				
A000HF	Ventilation Fan Housing Pack	4 *	\$23.34	HM
A000HL	Ventilation Fan/Light Housing Pack	4 *	\$23.34	HM
Finish Packs				
A70LF	70 CFM, 2.0 Sones, Finish Pack	4 *	\$123.34	HM
A80F	Ω 80 CFM, 2.0 Sones, Finish Pack	4 *	\$126.68	HM
A80HDF	Ω 80 CFM, 2.0 Sones, Metal Grille, Finish Pack	4 *	\$170.00	HM
A110F	Ω 110 CFM, 3.0 Sones, Finish Pack	4 *	\$143.34	HM
AE50F	Ω 50 CFM, 0.5 Sones, ENERGY STAR Finish Pack	4 *	\$143.34	HM
AE80BF	Ω 80 CFM, 1.5 Sones, ENERGY STAR Finish Pack	4 *	\$93.34	HM
AE80BLF	Ω LED light, 80 CFM, 1.5 Sones, ENERGY STAR Finish Pack	4 *	\$193.32	HM
AE80F	Ω 80 CFM, 0.8 Sones, ENERGY STAR Finish Pack	4 *	\$216.68	HM
AE80LF	Ω LED light, 80 CFM, 0.8 Sones, ENERGY STAR Finish Pack	4 *	\$376.68	HM
AE110F	Ω 110 CFM, 1.3 Sones, ENERGY STAR Finish Pack	4 *	\$243.34	HM
AE110LF	Ω LED light, 110 CFM, 1.3 Sones, ENERGY STAR Finish Pack	4 *	\$337.84	HM

Ω Works with Model RDM1 and RDMWT radiation damper.



Select models are ENERGY STAR certified products — see product description.

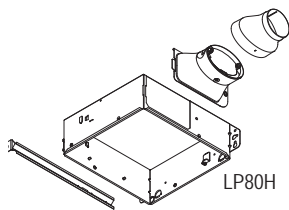

LP80H

LP80F

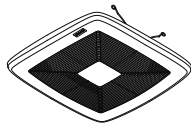
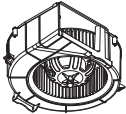

Broan® LoProfile™ Project Packs

The new Broan LoProfile™ fan is our latest solution for installations where conventional ventilation simply won't fit. Where multi-family applications require it, the LoProfile™ fan is narrow enough to be installed in a wall between 2 x 4 studs. When plumbing or electrical obstructions are found behind the drywall in ceiling remodel applications, our LoProfile™ fan can still fit without having to move anything. And that means most any room with space constraints can have powerful, quiet and efficient ventilation. Project Packs offer availability to buy housings for rough-in and motor/blower assemblies and grille later for finishing.

Model No.	Description	Std. Pk.	List Price	Code
LP80H	Housing Pack for LP80	4 *	\$28.04	HV
LP80F	ENERGY STAR Finish Pack. Motor and Grille Assembly. 80 CFM, 1.0 Sones.	4 *	\$120.92	HV



Select models are ENERGY STAR certified products — see product description.

- Item too large to ship via UPS/FedEx. Item shipped common carrier at minimum rates.
- * All pricing reflects the individual item cost. You must order in multiples as indicated.
- ◆ UL listed for use over bathtubs and showers when connected to a GFCI protected branch circuit.

Broan® Radiation Damper Accessory Kit

Model No.	Description	Std. Pk.	List Price	Code
RDFQF	Radiation damper accessory that works with Models QTRE080, QTRE080C2S, QTRE080R, QTRE110, QTXE050, QTXE080, QTXE110, SSQTXE110, SSQTXE80, QTR110F, QTRE110F, QTR080F and QTRE080F.	1	\$121.24	HV
RDFQL	Radiation damper accessory that works with Models QTRE080FLT, QTRE110FLT, QTXE110FLT, QTXE080FLT, QTXE110FLT, QTRE110FLFT and QTRE080FLFT. Also works with Models QTXE110S and QTXE110SFLT when used with RDJUMPQ accessory.	1	\$121.24	HV
RDFU	Radiation damper accessory that works with Models QTXE150, QTXE150FLT, RB80, RB110, XB50, XB80, XB110, ZB80 and ZB110. Also works with Models RB80L, RB110L, XB110HL, ZB110HL, ZB80ML, ZB110ML, XB50L, XB80L, XB110L, ZB80L, ZB110L, XB110H, ZB110H, ZB80M and ZB110M when used with RDJUMPU accessory.	1	\$121.24	HP
RDFUWT	Radiation damper accessory that works with Models QTXE150, QTXE150FLT, RB80, RB110, XB50, XB80, XB110, ZB80 and ZB110. Also works with Models RB80L, RB110L, XB110HL, ZB110HL, ZB80ML, ZB110ML, XB50L, XB80L, XB110L, ZB80L, ZB110L, XB110H, ZB110H, ZB80M and ZB110M when used with RDJUMPU accessory. For UL wood truss assembly listings L521, L528, L546, L558, L562, L574, L576, L581, L583, L585, P522, P533, P538, P545 and P547. Available May, 2017.	1	\$121.24	HP
RDJ1	Radiation damper accessory with metal grille and metal duct connector (no housing). Works with 770, 784, 676, 684, HD50 and HD80.	1	\$141.36	HV
RDF1	Radiation damper. Works with ULTRA® Series non-sensing fans (not fan/lights) and LP80.	1	\$121.24	HP
Accessories				
RDJUMPQ	Wiring jumper kit required for use with RDFQL when used with Models QTXE110S and QTXE110SFLT.	1	\$8.44	AC
RDJUMPU	Wiring jumper kit required for use with RDFU when used with Models XB110HL, ZB110HL, ZB80ML, ZB110ML, XB50L, XB80L, XB110L, ZB80L, ZB110L, XB110H, ZB110H, ZB80M and ZB110M.	1	\$16.90	AC
804QDD	■ 4" metal connector for use with QT models.	1	\$18.22	AC

■ Limited quantities available.

Broan® Fan and Combination Unit Project Packs

Broan's project packs offer a variety of housings packed and sold separately from motor assembly and grille. You can buy housings for rough-in ... buy assemblies and grilles later for finishing. Type IC.

Fan/Light Project Packs — Fits 2" x 6" Ceiling Construction

Model No.	Description	Std. Pk.	List Price	Code
2677H	Housing Pack for 2678F, 2679F, 2680F, FL2679F, FL2679FT, FL2680F and FL2680FT. Type IC. Mounting ears.	4 *	\$16.40	LV
3677H	Housing Pack. Same as 2677H, except includes built-in slide channels and mounting brackets.	4 *	\$21.04	LV
2678F	◆ Finish Pack. Motor, Reflector and Grille Assembly. 50 CFM, 2.5 Sones, 100W light. Uses 2677H or 3677H housing pack.	4 *	\$80.90	LV

● Item too large to ship via UPS/FedEx. Item shipped common carrier at minimum rates.

* All pricing reflects the individual item cost. You must order in multiples as indicated.

◆ UL listed for use over bathtubs and showers when connected to a GFCI protected branch circuit.

Ventilation Fans — Project Packs

Broan Economy Fan Project Packs — Fits 2" x 4" Ceiling or Wall Construction

Model No.	Description	Std. Pk.	List Price	Code
1667H	Housing Pack for 1670F, 1671F, 1688F and 1689F (damper/plastic duct connector included)	6 *	\$9.98	LV
1667HMTL	Housing Pack for 1670F, 1671F, 1688F and 1689F (damper/metal duct connector included)	6 *	\$23.66	LV
1670F	◆ Finish Pack. Motor Assembly and Grille. 50 CFM, 3.5 Sones.	6 *	\$55.04	LV
1671F	◆ Finish Pack. Motor Assembly and Grille. 70 CFM, 6.0 Sones.	6 *	\$49.48	LV
1688F	◆ Finish Pack. Motor Assembly and Grille. 50 CFM, 4.0 Sones.	6 *	\$35.20	LV
1689F	◆ Finish Pack. Motor Assembly and Grille, 60 CFM, 5.5 Sones	6 *	\$46.28	LV

Combination Unit Project Packs — Fits 2" x 6" Ceiling Construction

Model No.	Description	Std. Pk.	List Price	Code
654H	Housing Pack for 655F, 656F, 657F, 658F and 659F (damper/duct connector included). Type IC.	4 *	\$26.66	LV
655F	Finish Pack. Heater/Fan/Light Assembly and Grille. 70 CFM, 4.0 Sones, 100W light, 1300W heater. Uses 654H housing pack.	1	\$191.76	LV
656F	Finish Pack. Heater/Light Assembly and Grille. 100W light, 1300W heater. Uses 654H housing pack.	1	\$163.82	LV
657F	◆ Finish Pack. Fan/Light Assembly and Grille. 70 CFM, 4.0 Sones, 100W light. Uses 654H housing pack.	1	\$117.34	LV
658F	Finish Pack. Heater/Fan Assembly and Grille. 70 CFM, 4.0 Sones, 1300W heater. Uses 654H housing pack.	1	\$184.60	LV
659F	Finish Pack. Heater/Fan/Light Assembly and Grille. 50 CFM, 2.5 Sones, 100W light, 1300W heater. Uses 654H housing pack.	1	\$188.72	LV

Bulb Heater/Fan Project Packs — Fits 2" x 6" Ceiling Construction

Model No.	Description	Std. Pk.	List Price	Code
162H	■ Housing and Blower Assembly for 162F. Type IC.	4 *	\$87.08	HV
162F	■ Grille and Springs	4 *	\$20.72	HV

■ Limited quantities available.

- Item too large to ship via UPS/FedEx. Item shipped common carrier at minimum rates.
- * All pricing reflects the individual item cost. You must order in multiples as indicated.
- ◆ UL listed for use over bathtubs and showers when connected to a GFCI protected branch circuit.

Ventilation Fans — Remote In-Line

It's a pretty simple concept. Mount a high efficiency ventilator in an out-of-the-way location and get the exhaust needed with virtually no sound. Suitable for intermittent or continuous duty. Install the fan in the attic, basement, crawlspace or wherever is convenient. Energy efficient, permanently lubricated motors with high-pressure centrifugal blower wheels accommodate longer duct runs. Designed for quick, easy installation. Removable panels offer easy access to the motor without disturbing ductwork.

Broan® Single-Port Remote In-Line Ventilators

6" round inlet and outlet.



Model No.		Description	Std. Pk.	List Price	Code
SP100	+	Ventilator, 110 CFM, 1.0 Sone	1	\$285.40	HV
SP140	+	Ventilator, 150 CFM, 1.5 Sones	1	\$301.24	HV
SP200	+	Ventilator, 210 CFM, 2.0 Sones	1	\$317.08	HV
CVG4		4" Grille	1	\$35.38	AC
CVG6		6" Grille	1	\$47.56	AC

+ HVI rated airflow at 0.2" static pressure. These products were tested using sound test procedures similar to those used by HVI for other exhaust fans.

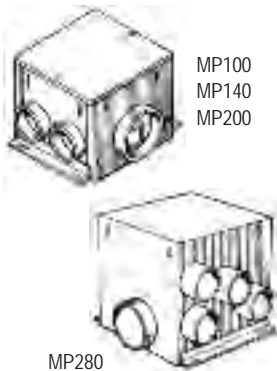

MP100
MP140
MP200

MP280

Broan® Multi-Port Remote In-Line Ventilators

Ventilate multiple rooms simultaneously. (1) 6" round outlet, (4) 4 round inlets and two inlet covers furnished.

Model No.		Description	Std. Pk.	List Price	Code
MP100	+	Ventilator, 110 CFM, 1.0 Sone	1	\$317.08	HV
MP140	+	Ventilator, 150 CFM, 1.5 Sones	1	\$367.88	HV
MP200	+	Ventilator, 210 CFM, 2.0 Sones	1	\$437.82	HV
MP280	+	Ventilator, 290 CFM, 3.0 Sones	1	\$507.50	HV
CVG4		4" Grille	1	\$35.38	AC
CVG6		6" Grille	1	\$47.56	AC

+ HVI rated airflow at 0.2" static pressure. These products were tested using sound test procedures similar to those used by HVI for other exhaust fans.

- Item too large to ship via UPS/FedEx. Item shipped common carrier at minimum rates.
- * All pricing reflects the individual item cost. You must order in multiples as indicated.
- ◆ UL listed for use over bathtubs and showers when connected to a GFCI protected branch circuit.

Ventilation Fans — Heater Combinations

Broan® QT Series™ Heater/Fan/Light

Powerful heating, lighting and ventilation available at the touch of a switch. Quiet, high output 1500 watt heater with exclusive PowerHeat™ design. Requires a dedicated 20 amp circuit. 3 year warranty. 6" ducting for superior performance. 17-5/8" x 11-3/8" x 7-5/8" high housing with hanger bar system. 20" x 15" grille. Fits in 2" x 8" ceiling construction.



QTX110HL
QTX110HFLT



77DW
77DV

Model No.	Description	Std. Pk.	List Price	Code
QTX110HL	110 CFM, 0.9 Sones, Fan with 1500W heater, 2-60W max incandescent light and 7W night light (bulbs not included). Recommend 77 Series switch.	1	\$548.52	HV
QTX110HFLT	110 CFM, 0.9 Sones, Fan with 1500W heater, 2-18W high efficiency, GU24 based fluorescent light (bulbs included) and 7W night light (bulb included). Recommend 77 Series switch.	1	\$610.34	HV
77DW / 77DV	Three-Switch Control for use with sensing Fan/Lights (top switch provides three settings for sensor On/Auto/Off), remaining switches control light, night light and QT Heater/Fan/Light/Night Light (top switch controls light and night light, remaining switches control fan and heater).	1	\$44.60	AC

Broan® Directionally-Adjustable Heater with Fan and Light

These heaters feature 1500 watts of powerful, directionally-adjustable heat along with 100 CFM of ventilation at only 2.0 sones. They have 4" ducting and fit in 2" x 6" ceiling construction. Attractive grilles are 17-1/2" x 11-1/2" covering a 16" x 10-1/4" x 5-7/8" housing.

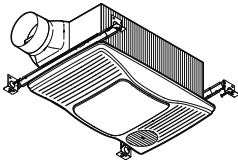

Model No.	Description	Std. Pk.	List Price	Code
100HL	Features 100W max incandescent lighting (bulb not included)	1	\$304.68	LV
100HFL	Features 27W fluorescent lighting (bulb included)	1	\$366.52	LV

Broan® Heater Combinations

Model 655 Heater/Fan/Light (featured) has a 1300-watt fan-forced heater and 70 CFM, 3.5 Sones ventilator, plus 100-watt light capacity in one compact unit (bulb not included). Two separate motors for heater and ventilator. Attractive 16-3/4" x 10-5/8" molded plastic grille and shatter-resistant lens. Built-in damper/duct connector fits 4" round duct. 14-1/4" x 8-1/4" x 5-3/4" high housing. Bulbs not included with any combination unit. All units are Type IC (Insulation Contact). Fits in 2" x 6" ceiling construction.



655 659
656 696
657



658

Model No.	Description	Std. Pk.	List Price	Code
655	Heater/Fan/Light, 70 CFM, 4.0 Sones	1	\$218.42	LV
656	Heater/Light; same as Model 655 but does not include fan	1	\$190.46	LV
657	◆ Fan/Light; same as Model 655 but does not include heater	1	\$144.00	LV
658	Heater/Fan; same as Model 655 but does not include light	1	\$211.26	LV
659	Heater/Fan/Light; same as Model 655 except 50 CFM, 2.5 Sones	1	\$215.38	LV
696	Fan/Light; same as Model 657 except 100 CFM, 4.5 Sones. Includes acoustic insulation.	1	\$197.84	LV

Select models available in project packs, see Page 75.

- Item too large to ship via UPS/FedEx. Item shipped common carrier at minimum rates.
- * All pricing reflects the individual item cost. You must order in multiples as indicated.
- ◆ UL listed for use over bathtubs and showers when connected to a GFCI protected branch circuit.

Ventilation Fans — Heater Combinations



Broan® Bulb Heaters and Heater/Fans

Produce instant warmth with standard BR40/R40 size 250-watt infrared bulbs (not included). Attractive molded plastic grilles. Damper/duct connector fits 4" round duct (Models 162 and 164). Models 161 and 162 grilles measure 10-1/4" x 10-1/4". Models 163 and 164 grilles measure 10-1/4" x 15-5/8". Housing sizes are noted below. Includes adjustable hanger bar system that spans up to 24". Fits 2" x 8" ceiling construction.

Model No.	Description	Std. Pk.	List Price	Code
161	Single 250W Bulb Heat — Not Type IC	1	\$51.72	HV
162	Single 250W Bulb Heat with 70 CFM, 4.0 Sones Exhaust Fan — Type IC, UL Listed for 60°C wiring (retrofit)	1	\$107.80	HV
163	Double 250W Bulb Heat Lamp — Type IC	1	\$86.04	HV
164	Double 250W Bulb Heat with 70 CFM, 4.0 Sones Exhaust Fan	1	\$143.84	HV

Select models available in project packs, see Page 75.

Rough-in housing sizes: 161 — 8-3/8" x 8-1/8" x 6"
 162 — 8-3/8" x 8-1/8" x 6-3/8"
 163 — 8-3/8" x 14-1/4" x 6"
 164 — 8-3/8" x 14-1/4" x 6-3/8"

Broan® Room-to-Room Fans

Install in interior walls to provide air flow of heated or cooled air from one room to another. Permanently lubricated motor. Models 510 and 511 have built-in switch for variable speed sound level selection. Models 510 and 511 adjust to fit walls from 3" to 5-1/2" thick.



Model No.	Description	Std. Pk.	List Price	Code
510	10" Fan, 380 CFM, 6.5 Sones. 13-1/2" square plastic grille.	1	\$208.34	HV
511	8" Fan, 180 CFM, 3.5 Sones. 13-1/2" square plastic grille.	1	\$166.92	HV
512	6" Fan with 8" Diameter Plastic Grille, 90 CFM, 3.5 Sones. Installs in interior walls up to 5-1/8" thick. Use with Model 57W/57V speed control or 69W/69V on/off switch (available separately).	1	\$73.74	HV

Broan® Through the Wall Fan

This versatile unit can be installed in outside walls from 5-1/4" to 10" thick. Exterior, white louvered, polymeric wall cap blends with any exterior wall covering. Includes white plastic interior grille, fan, flexible ducting and exterior louvered wall cap with birdscreen. Interior grille measures 8" round. Wall cap measures 8" square.



Model No.	Description	Std. Pk.	List Price	Code
512M	Through the Wall Ventilator, 70 CFM, 3.5 Sones	1	\$105.30	HV

- Item too large to ship via UPS/FedEx. Item shipped common carrier at minimum rates.
- * All pricing reflects the individual item cost. You must order in multiples as indicated.
- ◆ UL listed for use over bathtubs and showers when connected to a GFCI protected branch circuit.

Ventilation Fans — Utility

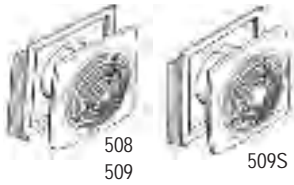

Broan® Direct Discharge Fans

Housing adjusts to fit walls 4-1/2" to 9-1/2" thick. Permanently lubricated motor with "twist-lock" installation; built-in backdraft damper.

Model No.	Description	Std. Pk.	List Price	Code
508	270 CFM, 10" Fan, 6.0 Sones, 13-1/2" square plastic grille	1	\$231.94	HV
509	180 CFM, 8" Fan, 6.5 Sones, 11-1/2" square plastic grille	1	\$154.34	HV
509S	8" Fan. Same as Model 509 (built-in on/off switch included).	1	\$163.20	HV



Broan® Chain-Operated Fans

Pull chain opens door and turns on fan – no wall switch to wire. Specially designed high performance fan blade. Housing adjusts to fit walls 4-1/2" to 9-1/2" thick.

Model No.	Description	Std. Pk.	List Price	Code
506	470 CFM, 10" Fan, 8.0 Sones, 13-1/2" square plastic grille	1	\$231.94	HV
507	250 CFM, 8" Fan, 7.0 Sones, 11-1/2" square plastic grille	1	\$188.64	HV



Broan® Vertical Discharge Fans

Quiet, efficient operation. Model 504 uses a 10" round duct or can be used with Model 472 reducer-damper (available separately) for 8" round duct. Housing is 10-1/4" x 7". Model 505 has a built-in backdraft damper, uses 8" round duct. Housing is 8-1/4" x 7".

Model No.	Description	Std. Pk.	List Price	Code
504	350 CFM, 10" Fan, 6.5 Sones, 13-1/2" square plastic grille	1	\$182.92	HV
505	180 CFM, 8" Fan, 5.5 Sones, 11-1/2" square plastic grille	1	\$131.38	HV
673	◆ Ventilation Fan, 60 CFM, 4.5 Sones	1	\$59.34	LV



Broan® Side Discharge Fans

Mounting brackets are adjustable to allow installation in walls or ceilings with studs or joists up to 24" on center. Requires 3-1/4" x 10" duct. Housing has built-in backdraft damper. Model 502 housing is 16-3/4" x 13-7/8". Model 503 housing is 14" x 12".

Model No.	Description	Std. Pk.	List Price	Code
502	270 CFM, 10" Fan, 8.0 Sones, 13-1/2" square plastic grille	1	\$232.20	HV
503	160 CFM, 8" Fan, 5.0 Sones, 11-1/2" square plastic grille	1	\$154.18	HV



Broan® Motordor® Wall Fan

The updated version of Broan's very first fan! Separate motor opens door when fan is turned on; closes door when turned off. 13-1/2" square grille. Housing is 11-1/2" square. Adjusts to fit walls from 5-1/2" to 9-7/8" thick.

Model No.	Description	Std. Pk.	List Price	Code
12C	360 CFM, 8" Fan, 8.0 Sones, 13-1/2" square plastic grille	1	\$466.80	HV

- Item too large to ship via UPS/FedEx. Item shipped common carrier at minimum rates.
- * All pricing reflects the individual item cost. You must order in multiples as indicated.
- ◆ UL listed for use over bathtubs and showers when connected to a GFCI protected branch circuit.

Ventilation Fans — Utility

Broan® Metal Grille Kits and Filters — Utility Fans

Everything you need to furnish a heavy duty metal grille for most Broan Utility Ventilators. All mounting hardware included.



Model No.	Description	Std. Pk.	List Price	Code
S97013825	White Painted Steel Metal Grille Kit for 10" fan units without switch hole	1	\$42.48	PT
S97013826	White Painted Steel Metal Grille Kit for 8" fan units without switch hole	1	\$35.46	PT
S97013827	White Painted Steel Metal Grille Kit for 10" fan units with switch hole	1	\$51.44	PT
S99010042	Washable Aluminum Filter for use with 8" utility ventilators	1	\$10.46	PT
S99010271	Washable Aluminum Filter for use with 10" utility ventilators	1	\$13.04	PT

Ventilation Fans — High Capacity

Broan® Ceiling Mount Ventilators — 100, 150, 200, 250 and 300 CFM

Incredibly Reliable – Unbelievably Quiet!® The quietest in the industry — Single, impact resistant centrifugal blower wheel driven by low RPM motor. 12-1/4" x 12-1/2" x 11-3/4" high housing. Low profile white polymeric grille (14" x 14") or sturdy, low profile metal grille finished with painted white enamel (14" x 14"). Built-in backdraft damper. Discharges horizontally or vertically through 6" or 8" round duct. Housings lined with acoustic insulation (except Model L300KMG). All ratings at 60 Hz.

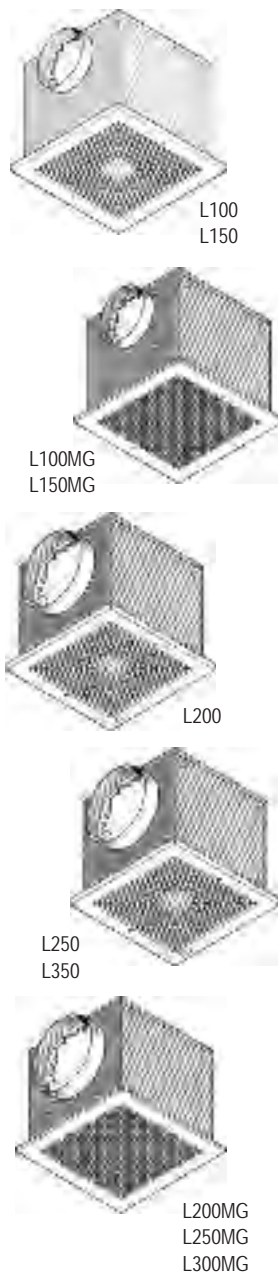

Model No.	Description *	Std. Pk.	List Price	Code
L100	Ventilator; 109 CFM Horizontal, 0.9 Sones; 112 CFM Vertical, 1.0 Sones. Polymeric grille. 6" rd. duct connector. 120V.	1	\$243.56	HV
L100MG	Ventilator; 115 CFM Horizontal/Vertical, 0.9 Sones. Metal grille. 6" rd. duct connector. 120V.	1	\$269.92	HV
L150	Ventilator; 157 CFM Horizontal, 1.5 Sones; 160 CFM Vertical, 1.6 Sones. Polymeric grille. 6" rd. duct connector. 120V.	1	\$251.76	HV
L150MG	Ventilator; 161 CFM Horizontal, 1.4 Sones; 162 CFM Vertical, 1.6 Sones. Metal grille. 6" rd. duct connector. 120V.	1	\$278.20	HV
L200	Ventilator; 210 CFM Horizontal, 1.7 Sones; 207 CFM Vertical, 2.0 Sones. Polymeric grille. 8" rd. duct connector. 120V.	1	\$277.48	HV
L200MG	Ventilator; 215 CFM Horizontal, 1.9 Sones; 209 CFM Vertical, 1.8 Sones. Metal grille. 8" rd. duct connector. 120V.	1	\$303.88	HV
L250	Ventilator; 259 CFM Horizontal, 2.2 Sones; 259 CFM Vertical, 2.7 Sones. Polymeric grille. 8" rd. duct connector. 120V.	1	\$293.92	HV
L250MG	Ventilator; 265 CFM Horizontal, 2.5 Sones; 262 CFM Vertical, 2.7 Sones. Metal grille. 8" rd. duct connector. 120V.	1	\$320.28	HV
L300	Ventilator; 308 CFM Horizontal, 2.9 Sones; 313 CFM Vertical, 3.0 Sones. Polymeric grille. 8" rd. duct connector. 120V.	1	\$300.28	HV
L300MG	Ventilator; 316 CFM Horizontal, 3.0 Sones; 314 CFM Vertical, 2.8 Sones. Metal grille. 8" rd. duct connector. 120V.	1	\$326.68	HV
L300KMG	▲ Ventilator; 277 CFM Horizontal, 3.1 Sones; 277 CFM Vertical, 3.7 Sones. Metal grille and blower wheel. 8" rd. duct connector. Suitable for kitchen installation. 120V.	1	\$346.68	HV

* AMCA licensed CFM/Sone ratings at 0.125" static pressure.

▲ Indicates product is suitable for kitchen installation.

- Item too large to ship via UPS/FedEx. Item shipped common carrier at minimum rates.
- * All pricing reflects the individual item cost. You must order in multiples as indicated.
- ◆ UL listed for use over bathtubs and showers when connected to a GFCI protected branch circuit.

Ventilation Fans — High Capacity

Broan® Ceiling Mount Ventilators — 400, 500 and 700 CFM

Two impact resistant centrifugal blower wheels driven by low RPM motor (kitchen units have metal wheels). 21-1/2" x 21-1/4" x 11-3/4" high housing. Sturdy, low profile metal grille finished with painted white enamel (20" x 14"). Discharges horizontally or vertically through 4-1/2" x 18-1/2" duct connector. Housings lined with acoustic insulation (except kitchen models). All ratings at 60 Hz.



Model No.	Description *	Std. Pk.	List Price	Code
L400	Ventilator; 434 CFM Horizontal, 2.3 Sones; 416 CFM Vertical, 2.6 Sones. 120V.	1	\$406.90	HV
L400K ▲	Ventilator; 406 CFM Horizontal, 3.3 Sones; 399 CFM Vertical, 3.3 Sones. Metal wheels. 120V.	1	\$442.58	HV
L500	Ventilator; 514 CFM Horizontal, 3.3 Sones; 512 CFM Vertical, 3.2 Sones. 120V.	1	\$492.50	HV
L500K ▲	Ventilator; 481 CFM Horizontal, 4.4 Sones; 473 CFM Vertical, 4.0 Sones. Metal wheels. 120V.	1	\$528.14	HV
L700	Ventilator; 701 CFM Horizontal, 4.7 Sones; 687 CFM Vertical; 5.0 Sones. 120V.	1	\$578.10	HV
423	Duct Transition — 4-1/2" x 18-1/2" to 10" rd. for 400, 500 & 700 CFM models	1	\$70.56	AC

* AMCA licensed CFM/Sone ratings at 0.125" static pressure.

▲ Indicates product is suitable for kitchen installation.

Broan® Ceiling Mount Ventilators — 900 and 1500 CFM

Single, impact resistant centrifugal blower wheel driven by low RPM motor. 22" x 18" x 18" high housing. Sturdy, low profile metal grille finished with painted white enamel (23-7/8" x 19-7/8"). Discharges horizontally or vertically through 8" x 12" duct connector. Housings lined with acoustic insulation. All ratings at 60 Hz.

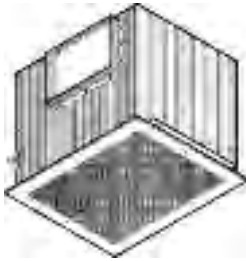

Model No.	Description *	Std. Pk.	List Price	Code
L900	Ventilator; 901 CFM Horizontal, 4.1 Sones; 885 CFM Vertical, 3.4 Sones. 120V.	1	\$730.16	HV
L1500	Ventilator; 1513 CFM Horizontal, 8.4 Sones; 1502 CFM Vertical, 8.4 Sones. 120V.	1	\$815.80	HV
T81212	Duct Transition — 8" x 12" to 12" rd. for 900 & 1500 CFM models	1	\$71.60	AC

* AMCA licensed CFM/Sone ratings at 0.125" static pressure.

- Item too large to ship via UPS/FedEx. Item shipped common carrier at minimum rates.
- * All pricing reflects the individual item cost. You must order in multiples as indicated.
- ◆ UL listed for use over bathtubs and showers when connected to a GFCI protected branch circuit.

Ventilation Fans — High Capacity

Broan® In-Line Ventilators — 100, 150, 200, 250 and 300 CFM

Single impact resistant centrifugal blower wheel driven by low RPM motor. 12-1/4" x 12-1/2" x 11-3/4" high housing. Removable access panel. No insulation inside housing.

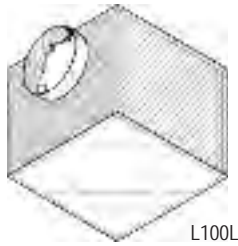

L100L

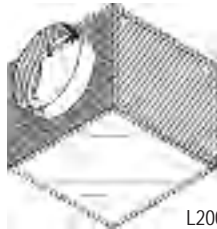

L200L

Model No.	Description *	Std. Pk.	List Price	Code
L100L ▲	Ventilator; 106 CFM Straight Through, 0.7 Sones; 95 CFM Right Angle, 0.3 Sones. 6" rd. duct connectors. 120V.	1	\$262.80	HV
L150L ▲	Ventilator; 147 CFM Straight Through, 1.1 Sones; 142 CFM Right Angle, 1.3 Sones. 6" rd. duct connectors. 120V.	1	\$271.08	HV
L200L ▲	Ventilator; 195 CFM Straight Through, 1.9 Sones; 183 CFM Right Angle, 1.0 Sones. 8" rd. duct connectors. 120V.	1	\$297.30	HV
L250L ▲	Ventilator; 245 CFM Straight Through, 2.3 Sones; 238 CFM Right Angle, 1.7 Sones. 8" rd. duct connectors. 120V.	1	\$313.70	HV
L300L ▲	Ventilator; 293 CFM Straight Through, 3.1 Sones; 283 CFM Right Angle, 2.4 Sones. 8" rd. duct connectors. 120V.	1	\$320.12	HV

* AMCA licensed CFM/Sone ratings at 0.125" static pressure.

▲ Indicates product is suitable for kitchen installation.

Broan® In-Line Ventilators — 400, 500 and 700 CFM

Two impact resistant centrifugal blower wheels driven by low RPM motor. 21-1/2" x 21-1/4" x 11-3/4" high housing. Two 4-1/2" x 18-1/2" duct connectors. Removable access panel.



Model No.	Description *	Std. Pk.	List Price	Code
L400L	Ventilator; 406 CFM Straight Through, 1.6 Sones; 391 CFM Right Angle, 1.2 Sones. 120V.	1	\$437.22	HV
L400KL ▲	Ventilator; 375 CFM Straight Through, 3.1 Sones; 380 CFM Right Angle, 2.0 Sones. 120V.	1	\$472.96	HV
L500L	Ventilator; 519 CFM Straight Through/Right Angle, 3.4 Sones. 120V.	1	\$522.86	HV
L500KL ▲	Ventilator; 472 CFM Straight Through, 3.8 Sones; 459 CFM Right Angle, 1.8 Sones. 120V.	1	\$558.54	HV
L700L	Ventilator; 681 CFM Straight Through, 3.7 Sones; 629 CFM Right Angle, 2.7 Sones. 120V.	1	\$608.44	HV
423	Duct Transition — 4-1/2" x 18-1/2" to 10" rd. for 400, 500 & 700 CFM models	1	\$70.56	AC

* AMCA licensed CFM/Sone ratings at 0.125" static pressure.

▲ Indicates product is suitable for kitchen installation.

Broan® In-Line Ventilators — 900 and 1500

Single impact resistant centrifugal blower wheel driven by low RPM motor. 22" x 18" x 18" high housing. Two 8" x 12" duct connectors. Removable access panel.



Model No.	Description *	Std. Pk.	List Price	Code
L900L	Ventilator; 894 CFM Straight Through, 3.8 Sones; 858 CFM Right Angle, 3.4 Sones. 120V.	1	\$766.00	HV
L1500L	Ventilator; 1214 CFM Straight Through, 6.7 Sones; 1076 CFM Right Angle, 3.5 Sones. 120V.	1	\$851.58	HV
T81212	Duct Transition — 8" x 12" to 12" rd. for 900 & 1500 CFM models	1	\$71.60	AC

* AMCA licensed CFM/Sone ratings at 0.125" static pressure.

- Item too large to ship via UPS/FedEx. Item shipped common carrier at minimum rates.
- * All pricing reflects the individual item cost. You must order in multiples as indicated.
- ◆ UL listed for use over bathtubs and showers when connected to a GFCI protected branch circuit.

Ventilation Fans — High Capacity

Broan® Cabinet Ventilators — 2000 and 3500 CFM

Twin, double inlet metal blower wheels 8" x 7-7/8". Fits 7-3/4" x 33-3/4" duct. Ratings at 60 Hz.

Model No.	Description *	Std. Pk.	List Price	Code
L2000L	Ventilator; 1791 CFM Straight Through, 9.4 Sones; 1898 CFM Right Angle, 10.1 Sones. 120V.	1	\$1,221.78	HV
L3500EXL	Ventilator; 3452 CFM Straight Through, 14.5 Sones; 3696 CFM Right Angle, 14.2 Sones. 240V	1	\$1,691.26	HV

* AMCA licensed CFM/Sone ratings at 0.125" static pressure.

Broan® Accessories for High Capacity Ventilation Fans

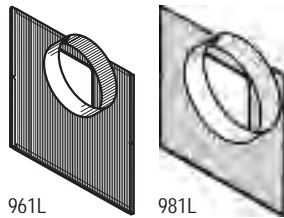

961L

981L

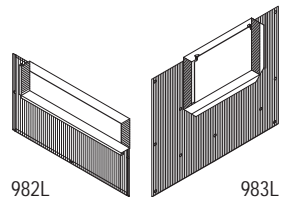

982L

983L



LAF1



LAF2



RD1

RD2

RD3



MG1

Model No.	Description	Std. Pk.	List Price	Code
80L	Variable Speed Control — 3.0 Amp, 120 Volts, 60 Hz (may be used with select models).	1	\$50.98	AC
277V	Electronic Variable Speed Control, 277V, 6A — Ivory. For models with "C" suffix.	1	\$91.60	AC
423	Duct Transition — 4-1/2" x 18-1/2" to 10" rd. for 400, 500 & 700 CFM models	1	\$70.56	AC
961L	In-line Adapter Kit, 6" rd. for 100 & 150 CFM ceiling mount models	1	\$31.28	AC
981L	In-line Adapter Kit, 8" rd. for 200, 250 & 300 CFM ceiling mount models	1	\$31.28	AC
982L	In-line Adapter Kit, 4-1/2" x 18-1/2" for 400, 500 & 700 CFM ceiling mount models	1	\$39.80	AC
983L	In-line Adapter Kit, 8" x 12" for 900 & 1500 CFM ceiling mount models	1	\$42.64	AC
D100	■ Damper Kit for Model L2000L Ventilator. Twin damper flaps and mounting hardware.	1	\$31.82	AC
D101	Damper Kit for Model L3500EXL Ventilator. Twin damper flaps and mounting hardware.	1	\$33.46	AC
G102	Grille Kit for Model L2000L Ventilator. White enameled steel grille measures 16-1/4" x 39-5/8".	1	\$149.58	AC
G103	Grille Kit for Model L3500EXL Ventilator. White enameled steel grille measures 18-3/8" x 47-1/4".	1	\$192.74	AC
LAF1	Grease Filter for use with metal grilles — Models L100, L150, L200, L250 and L300 Series.	1	\$15.40	AC
LAF2	Grease Filter for Models L400K & L500K	1	\$26.56	AC
MG1	Metal Grille Kit for 100, 150, 200, 250 & 300 CFM ceiling mount models	1	\$36.96	AC
RD1	Ceiling Radiation/Fire Damper for 100, 150, 200, 250 & 300 CFM ceiling mount models. UL rated 3 hours.	1	\$171.06	AC
RD2	Ceiling Radiation/Fire Damper for 400, 500 & 700 CFM ceiling mount models. UL rated 3 hours.	1	\$182.48	AC
RD3	Ceiling Radiation/Fire Damper for 900 & 1500 CFM ceiling mount models. UL rated 3 hours.	1	\$228.14	AC
T81212	Duct Transition, 8" x 12" to 12" rd. for 900 & 1500 CFM models	1	\$71.60	AC
V104	Vibration Dampening Hangers. Fits both Models L2000L and L3500EXL ventilators. Set of four required.	4 *	\$23.88	AC

■ Limited quantities available.

● Item too large to ship via UPS/FedEx. Item shipped common carrier at minimum rates.

* All pricing reflects the individual item cost. You must order in multiples as indicated.

◆ UL listed for use over bathtubs and showers when connected to a GFCI protected branch circuit.

Whole House Mechanical Ventilation

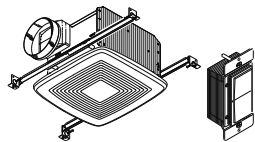

SSQTXE080
SSQTXE110

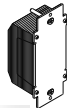

SMSCPLR



SMD6
SMD8

Broan SmartSense® Intelligent Ventilation System

The intelligent fan control system creates an integrated residential exhaust ventilation system using Broan's industry leading ventilation control technology and award winning QTXE fans. The Broan SmartSense system uses Broan's Link-Logic™ control technology powered by INSTEON™, a powerful communication technology to monitor everyday manual fan usage throughout the home. Broan SmartSense calculates additional ventilation required by Green Building and ASHRAE Standard 62 related requirements and automatically controls installed fans to achieve proper ventilation. SSQTXE080 and SSQTXE110 fans can provide a single fan solution for small apartments or mix and matched for a customized, integrated ventilation system.

Model No.	Description	Std. Pk.	List Price	Code
SSQTXE080	80 CFM SmartSense Fan with Control	1	\$287.06	HV
SSQTXE110	110 CFM SmartSense Fan with Control	1	\$318.84	HV
SMSCPLR	+ SmartSense Phase Coupler	1	\$45.90	AR
SMD6	6" LinkLogic automatic make-up air damper	1	\$281.36	HA
SMD8	8" LinkLogic automatic make-up air damper	1	\$296.16	HA

† The SmartSense Phase Coupler is only required when fans are located on separate phases of power. If fans are on the same circuit or phase, the phase coupler is not necessary.

Broan® Fresh Air Systems

The key to maintaining good indoor air quality and controlling excess moisture is to simultaneously introduce fresh air from outside while expelling stale air from inside. All without compromising your home's energy-efficiency or comfort. That's precisely what Broan's indoor air quality units do. With unparalleled performances, easy maintenance and reliability, the I.A.Q. line offers solutions to every budget and application, from residential to light-commercial.



AE60

Model No.	Description	Std. Pk.	List Price	Code
AE60	Air Exchanger, 160 – 185 CFM	1	\$809.40	AQ
B12LCDARNW	Light Commercial Heat Recovery Ventilator, recirculation defrost, aluminum core, reverse door, normal low speed, white pre paint	1	\$7,585.16	AQ
B12LCDASNW	Light Commercial Heat Recovery Ventilator, recirculation defrost, aluminum core, standard door, normal low speed, white pre paint	1	\$7,585.16	AQ
B12LCDPRNC	Light Commercial Heat Recovery Ventilator, recirculation defrost polypropylene core, reverse door, normal low speed, corrosion resistant	1	\$7,973.92	AQ
B12LCDPRNW	Light Commercial Heat Recovery Ventilator, recirculation defrost, polypropylene core, reverse door, normal low speed, white pre paint	1	\$6,880.80	AQ
B12LCDPSNC	Light Commercial Heat Recovery Ventilator, recirculation defrost, polypropylene core, standard door, normal low speed, corrosion resistant	1	\$7,973.92	AQ
B12LCDPSNW	Light Commercial Heat Recovery Ventilator, recirculation defrost, polypropylene core, standard door, normal low speed, white pre paint	1	\$6,880.80	AQ
B12LCEARNW	Light Commercial Heat Recovery Ventilator, exhaust only, aluminum core, reverse door, normal low speed, white pre paint	1	\$7,131.32	AQ
B12LCEASNW	Light Commercial Heat Recovery Ventilator, exhaust only, aluminum core, standard door, normal low speed, white pre paint	1	\$7,131.32	AQ
B12LCEPRNC	Light Commercial Heat Recovery Ventilator, exhaust only, polypropylene core, reverse door, normal low speed, corrosion resistant	1	\$7,520.08	AQ
B12LCEPRNW	Light Commercial Heat Recovery Ventilator, exhaust only, polypropylene core, reverse door, normal low speed, white pre paint	1	\$6,426.96	AQ
B12LCEPSNC	Light Commercial Heat Recovery Ventilator, exhaust only, polypropylene core, standard door, normal low speed, corrosion resistant	1	\$7,520.08	AQ
B12LCEPSNW	Light Commercial Heat Recovery Ventilator, exhaust only, polypropylene core, standard door, normal low speed, white pre paint	1	\$6,426.96	AQ
B6LCDARN	Light Commercial Heat Recovery Ventilator, recirculation defrost, aluminum core, reverse door, normal low speed	1	\$6,285.44	AQ
B6LCDASN	Light Commercial Heat Recovery Ventilator, recirculation defrost, aluminum core, standard door, normal low speed	1	\$6,285.44	AQ



Select models are ENERGY STAR certified products — see product description.

- Item too large to ship via UPS/FedEx. Item shipped common carrier at minimum rates.
- * All pricing reflects the individual item cost. You must order in multiples as indicated.
- ◆ UL listed for use over bathtubs and showers when connected to a GFCI protected branch circuit.

Whole House Mechanical Ventilation

Broan® Fresh Air Systems CONTINUED



ERVH100S
HRVH100SE

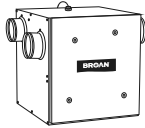

ERV70S



ERV70T



ERV140TE
HRV150TE

Model No.	Description	Std. Pk.	List Price	Code
B6LCDPRN	Light Commercial Heat Recovery Ventilator, recirculation defrost, polypropylene core, reverse door, normal low speed	1	\$5,846.24	AQ
B6LCDPSN	Light Commercial Heat Recovery Ventilator, recirculation defrost, polypropylene core, standard door, normal low speed	1	\$5,846.24	AQ
B6LCEARN	Light Commercial Heat Recovery Ventilator, exhaust only, aluminum core, reverse door, normal low speed	1	\$5,021.52	AQ
B6LCEASN	Light Commercial Heat Recovery Ventilator, exhaust only, aluminum core, standard door, normal low speed	1	\$5,021.52	AQ
B6LCEPRN	Light Commercial Heat Recovery Ventilator, exhaust only, polypropylene core, reverse door, normal low speed	1	\$4,582.32	AQ
B6LCEPSN	Light Commercial Heat Recovery Ventilator, exhaust only, polypropylene core, standard door, normal low speed	1	\$4,582.32	AQ
ERV70S	Energy Recovery Ventilator, 70 CFM max, side ports	1	\$1,246.76	AQ
ERV70T	Energy Recovery Ventilator, 70 CFM max, top ports	1	\$1,246.76	AQ
ERV100S	Sky Energy Recovery Ventilator, 100 CFM, side port	1	\$1,371.56	AQ
ERV100SP	Sky Energy Recovery Ventilator, 100 CFM, plus side port	1	\$1,496.36	AQ
ERV110S	Flex Heat Recovery Ventilator, 110 CFM, side port	1	\$1,366.56	AQ
ERV110T	Flex Heat Recovery Ventilator, 110 CFM, top port	1	\$1,366.56	AQ
ERV120S	Flex Energy Recovery Ventilator, 120 CFM, side port	1	\$1,433.96	AQ
ERV120T	Flex Energy Recovery Ventilator, 120 CFM, top port	1	\$1,433.96	AQ
ERV140TE	Energy Recovery Ventilator, 140 CFM max, top ports, ENERGY STAR certified.	1	\$2,494.76	AQ
ERV180S	Advance Energy Recovery Ventilator, 180 CFM, side port	1	\$1,870.76	AQ
ERV200TE	HE Energy Recovery Ventilator, 200 CFM, ECM, top port	1	\$3,549.86	AQ
ERV250TE	HE Energy Recovery Ventilator, 250 CFM, ECM, top port	1	\$2,995.20	AQ
ERVH100S	Energy Recovery Ventilator, 100 CFM max, side ports, ENERGY STAR certified.	1	\$1,995.56	AQ
ERVS100S	Sky Energy Recovery Ventilator, 100 Humidity Sensing, side port	1	\$1,064.00	AQ
HRV80S	Flex Heat Recovery Ventilator, 80 CFM, side port	1	\$1,026.34	AQ
HRV80T	Flex Heat Recovery Ventilator, 80 CFM, top port	1	\$1,026.34	AQ
HRV90S	Flex Heat Recovery Ventilator, 90 CFM, side port	1	\$1,154.40	AQ
HRV90T	Flex Heat Recovery Ventilator, 90 CFM, top port	1	\$1,154.40	AQ
HRV120S	Flex Heat Recovery Ventilator, 120 CFM, side port	1	\$1,246.76	AQ
HRV120T	Flex Heat Recovery Ventilator, 120 CFM, top port	1	\$1,246.76	AQ
HRV150S	Advance Heat Recovery Ventilator, 150 CFM, side port	1	\$1,616.16	AQ
HRV150TE	Heat Recovery Ventilator, 156 CFM max, top ports, ENERGY STAR certified.	1	\$1,643.12	AQ
HRV160T	Advance Heat Recovery Ventilator, 160 CFM, top port	1	\$1,553.76	AQ
HRV160TE	HE Heat Recovery Ventilator, 160 CFM, ECM, top port	1	\$1,870.76	AQ
HRV190S	Advance Heat Recovery Ventilator, 190 CFM	1	\$1,870.76	AQ
HRV200TE	HE Heat Recovery Ventilator, 200 CFM, ECM, top port	1	\$2,745.60	AQ
HRV250TE	HE Heat Recovery Ventilator, 250 CFM, DCM, top port	1	\$2,884.28	AQ
HRVH100S	Advance Heat Recovery Ventilator, HEPA, 100 CFM, side port	1	\$1,496.36	AQ
HRVH100SE	Heat Recovery Ventilator, 104 CFM max, side ports, ENERGY STAR certified.	1	\$1,773.82	AQ

■ Limited quantities available.



Select models are ENERGY STAR certified products — see product description.

- Item too large to ship via UPS/FedEx. Item shipped common carrier at minimum rates.
- * All pricing reflects the individual item cost. You must order in multiples as indicated.
- ◆ UL listed for use over bathtubs and showers when connected to a GFCI protected branch circuit.

Whole House Mechanical Ventilation

Broan® Fresh Air System Accessories

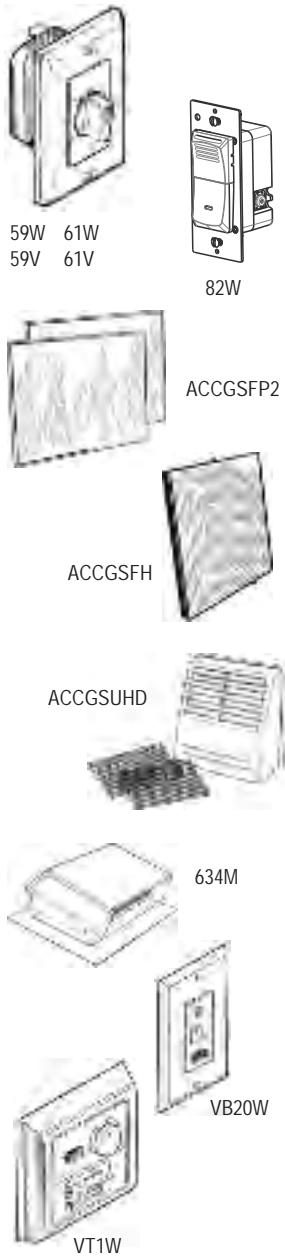

Model No.	Description	Std. Pk.	List Price	Code
59V / 59W	60 Minute Time Control, with "continuous on" feature. Fits single gang box.	1	\$60.34	AC
61V / 61W	15 Minute Time Control, no "continuous on" feature. Fits single gang box.	1	\$60.34	AC
82W	Premium Humidity Control with Sensaire technology that senses rapid rise in humidity. Also includes duty cycle timer. Fits in single gang box. (White)	1	\$101.30	AC
634M	Steel Roof Cap for 6" round duct. Includes damper and birdscreen. Black.	1	\$60.34	AC
641	Aluminum Wall Cap for 6" round duct (includes damper and birdscreen). Natural finish.	1	\$71.04	AC
ACCGSEF2	2-Core Foam Filter Kit	1	\$39.80	GA
ACCGSFF2	HRV Core Foam Filters (Two Pieces)	1	\$39.78	GA
ACCGSFH	HEPA Filter Only	1	\$168.70	GA
ACCGSFHP2	1 Year HEPA Filter Kit (Two pre-filters and one HEPA)	1	\$198.50	GA
ACCGSFHP10	1 Year HEPA Filter Multi-Pack (Ten ACCGSFHP2)	1	\$1,881.00	GA
ACCGSFP2	Pre-filter Kit (Two Pieces)	1	\$36.68	GA
ACCGSFP20	Pre-filter Multi-Pack (Ten ACCGSFP2)	1	\$353.44	GA
ACCGSUP5	Alpine/Pine Filter Kit (Five Pieces)	1	\$71.52	GA
ACCGSUHD	AirDuo Outdoor Hood	1	\$56.98	GA
ACCHEPAPFK	Prefilter Kit	1	\$36.20	AQ
ACCHEPARF	Replacement HEPA Filter for ERVH100SE/HRVH100SE	1	\$98.04	AQ
ACCWMK	Walk Mount Bracket Kit	1	\$70.02	AQ
B1600705	Light Commercial Heat Recovery Ventilator Pool	1	\$7,180.10	AQ
BD4	Pressure Relief Damper with Wall Cap and 4" collar	1	\$83.98	AQ
BD6	Pressure Relief Damper with Wall Cap and 6" collar	1	\$83.98	AQ
DT4C	Flex Duct, 4", Non-insulated (25')	4 *	\$49.36	AC
DT4W	Flex Duct, 4", Insulated (25')	1	\$71.72	AC
DT6C	Flex Duct, 6", Non-insulated (25')	1	\$64.64	AC
DT6W	Flex Duct, 6", Insulated (25')	1	\$100.32	AC
EH6	Exterior Inlet/Outlet Hood, 6"	1	\$76.70	AQ
TYIK1	Installation Kit (Tandem Y, complete exterior vent, screws)	1	\$125.48	AQ
VB20W	▲ 20-Minute Push Button Timer	1	\$31.66	AQ
VB60W	20/40/60 Minute Wall Control	1	\$45.96	AQ
VT1W	□ Basic Wall Control. Off-low-high rocker switch. Dehumidistat. Low Voltage.	1	\$61.16	AQ
VT4W	‡ Wall Control, Off/Low/High Speed/Intermittent 20 min./hour	1	\$84.98	AQ
VT5W	« Programmable Electronic Wall Control with LCD Display. Four modes and filter function.	1	\$96.16	AQ
VT6W	Constructo Wall Control	1	\$57.12	AQ
VT7W	Deco-Touch Wall Control	1	\$167.82	AQ
VT8W	Altitude Wall Control	1	\$271.96	AQ
VT9W	HE Wall Control	1	\$208.00	AQ
VT10W	Pool Plus Wall Control	1	\$698.68	AQ

‡ Can be used with HRV90H and ERV90HC.

▲ Can be used with all units except GSE, GSH, GSV and GSF units.

« Can only be used with GSE and GSH units.

□ Can only be used with HRV100 and HRV200.

● Item too large to ship via UPS/FedEx. Item shipped common carrier at minimum rates.

* All pricing reflects the individual item cost. You must order in multiples as indicated.

◆ UL listed for use over bathtubs and showers when connected to a GFCI protected branch circuit.

Whole House Mechanical Ventilation

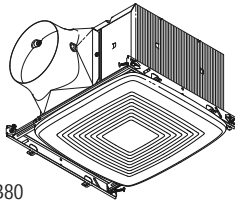

ZB80
ZB110

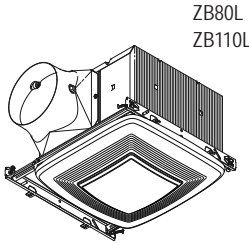

ZB80L
ZB110L

Broan® ULTRA™ Green Multi-Speed Series

We started with installation and worked back to build the ultimate bath fan. Unique telescoping mounting frame is ideal for both new construction and retrofit. No attic access needed! DC motor for efficiency. Multi-speed capability ideal for meeting ASHRAE 62.2, LEED, ENERGY STAR® for Homes and CA Title 24 — as well as local/spot ventilation needs. Powerful operation maintained over a wide range of real-world installations (CFM rating at 0.1" static pressure maintained through 0.25" static pressure). Fits in 2" x 8" ceiling construction. 10-1/2" L x 11-3/8" W x 7-5/8" H housing. 13" x 14" grille (fan) and 13" x 13-1/4" (fan/light/night light). All models have a 6" duct connector and the 50 CFM and 80 CFM models include a 6" to 4" reducer. All ULTRA 80 and 110 CFM fans can also be used with the MD6TU universal make-up air damper if 6" rigid duct is used. ULTRA non-sensing fans (not fan/lights) can also be used with the RDF1 radiation damper. Now with QStream sound technology that features airflow-smoothing baffles to reduce noise caused by turbulence (50 and 80 CFM models only).

Model No.	Description	Std. Pk.	List Price	Code
Fans				
ZB80 ◆	30 CFM to 80 CFM, <0.3 Sones, ENERGY STAR Fan	1	\$308.94	HP
ZB110 ◆	30 CFM to 110 CFM, <0.3 Sones, ENERGY STAR Fan	1	\$337.68	HP
Fan/Light/Night Light				
ZB80L ◆	30 CFM to 80 CFM, <0.3 Sones, ENERGY STAR Fan with 36W Fluorescent Light (2-18 watt GU24 bulbs included) and 4W Night Light (bulb not included)	1	\$423.68	HP
ZB110L ◆	30 CFM to 110 CFM, <0.3 Sones, ENERGY STAR Fan with 36W Fluorescent Light (2-18 watt GU24 bulbs included) and 4W Night Light (bulb not included)	1	\$454.76	HP



All models are ENERGY STAR certified products.

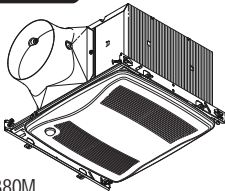

ZB80M
ZB110M

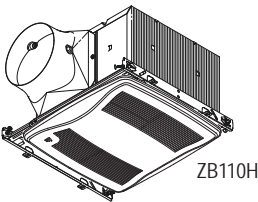

ZB110H

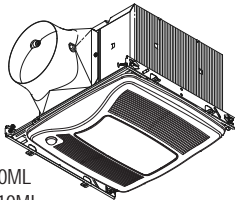

ZB80ML
ZB110ML

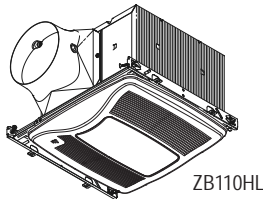

ZB110HL

Broan® ULTRA™ Green Multi-Speed Series — Sensing

We started with installation and worked back to build the ultimate bath fan. Unique telescoping mounting frame is ideal for both new construction and retrofit. No attic access needed! DC motor for efficiency. Multi-speed capability ideal for meeting ASHRAE 62.2, LEED, ENERGY STAR® for Homes and CA Title 24 — as well as local/spot ventilation needs. Humidity or motion sensing triggers fan to ramp up from lower continuous ventilation level to maximum CFM. Powerful operation maintained over a wide range of real-world installations (CFM rating at 0.1" static pressure maintained through 0.25" static pressure). Fits in 2" x 8" ceiling construction. 10-1/2" L x 11-3/8" W x 7-5/8" H housing. 13" x 14" grille (fan) and 13" x 13-1/4" (fan/light/night light). All models have a 6" duct connector and the 80 CFM models include a 6" to 4" reducer. All ULTRA 80 and 110 CFM fans can also be used with the MD6TU universal make-up air damper if 6" rigid duct is used. ULTRA non-sensing fans (not fan/lights) can also be used with the RDF1 radiation damper. Now with QStream sound technology that features airflow-smoothing baffles to reduce noise caused by turbulence (50 and 80 CFM models only).

Model No.	Description	Std. Pk.	List Price	Code
Fans				
ZB80M ◆	80 CFM, <0.3 Sones, ENERGY STAR Motion Sensing Fan	1	\$356.76	HP
ZB110H ◆	110 CFM, <0.3 Sones, ENERGY STAR Humidity Sensing Fan	1	\$448.82	HP
ZB110M ◆	110 CFM, <0.3 Sones, ENERGY STAR Motion Sensing Fan	1	\$383.74	HP
Fan/Light/Night Light				
ZB80ML ◆	80 CFM, <0.3 Sones, ENERGY STAR Motion Sensing Fan with 36W Fluorescent Light (2-18 watt GU24 bulbs included) and 4W Night Light (bulb not included)	1	\$478.38	HP
ZB110HL ◆	110 CFM, <0.3 Sones, ENERGY STAR Humidity Sensing Fan with 36W Fluorescent Light (2-18 watt GU24 bulbs included) and 4W Night Light (bulb not included)	1	\$570.70	HP
ZB110ML ◆	110 CFM, <0.3 Sones, ENERGY STAR Motion Sensing Fan with 36W Fluorescent Light (2-18 watt GU24 bulbs included) and 4W Night Light (bulb not included)	1	\$511.80	HP



All models are ENERGY STAR certified products.

See Ventilation Fan section for other Whole House Mechanical Ventilation options.

- Item too large to ship via UPS/FedEx. Item shipped common carrier at minimum rates.
- * All pricing reflects the individual item cost. You must order in multiples as indicated.
- ◆ UL listed for use over bathtubs and showers when connected to a GFCI protected branch circuit.

Whole House Mechanical Ventilation

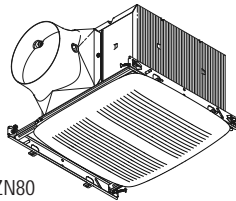

ZN80
ZN110

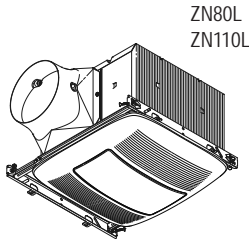

ZN80L
ZN110L

NuTone® ULTRA™ Green Multi-Speed Series

We started with installation and worked back to build the ultimate bath fan. Unique telescoping mounting frame is ideal for both new construction and retrofit. No attic access needed! DC motor for efficiency. Multi-speed capability ideal for meeting ASHRAE 62.2, LEED, ENERGY STAR® for Homes and CA Title 24 — as well as local/spot ventilation needs. Powerful operation maintained over a wide range of real-world installations (CFM rating at 0.1" static pressure maintained through 0.25" static pressure). Fits in 2" x 8" ceiling construction. 10-1/2" L x 11-3/8" W x 7-5/8" H housing. 13" x 14" grille (fan) and 13" x 13-1/4" (fan/light/night light). All models have a 6" duct connector and the 50 CFM and 80 CFM models include a 6" to 4" reducer. All ULTRA 80 and 110 CFM fans can also be used with the MD6TU universal make-up air damper if 6" rigid duct is used. ULTRA non-sensing fans (not fan/lights) can also be used with the RDF1 radiation damper. Now with QStream sound technology that features airflow-smoothing baffles to reduce noise caused by turbulence (50 and 80 CFM models only).

Model No.	Description	Std. Pk.	List Price	Code
Fans				
ZN80	◆ 30 CFM to 80 CFM, <0.3 Sones, ENERGY STAR Fan	1	\$308.94	HP
ZN110	◆ 30 CFM to 110 CFM, <0.3 Sones, ENERGY STAR Fan	1	\$337.68	HP
Fan/Light/Night Light				
ZN80L	◆ 30 CFM to 80 CFM, <0.3 Sones, ENERGY STAR Fan with 36W Fluorescent Light (2-18 watt GU24 bulbs included) and 4W Night Light (bulb not included)	1	\$423.68	HP
ZN110L	◆ 30 CFM to 110 CFM, <0.3 Sones, ENERGY STAR Fan with 36W Fluorescent Light (2-18 watt GU24 bulbs included) and 4W Night Light (bulb not included)	1	\$454.76	HP



All models are ENERGY STAR certified products.

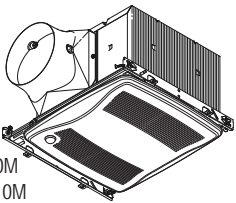

ZN80M
ZN110M

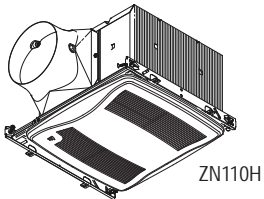

ZN110H

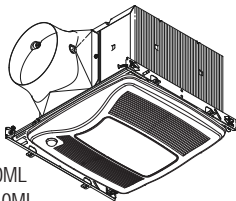

ZN80ML
ZN110ML

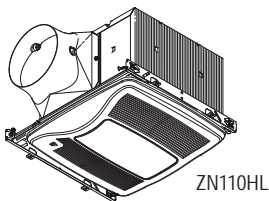

ZN110HL

NuTone® ULTRA™ Green Multi-Speed Series — Sensing

We started with installation and worked back to build the ultimate bath fan. Unique telescoping mounting frame is ideal for both new construction and retrofit. No attic access needed! DC motor for efficiency. Multi-speed capability ideal for meeting ASHRAE 62.2, LEED, ENERGY STAR® for Homes and CA Title 24 — as well as local/spot ventilation needs. Humidity or motion sensing triggers fan to ramp up from lower continuous ventilation level to maximum CFM. Powerful operation maintained over a wide range of real-world installations (CFM rating at 0.1" static pressure maintained through 0.25" static pressure). Fits in 2" x 8" ceiling construction. 10-1/2" L x 11-3/8" W x 7-5/8" H housing. 13" x 14" grille (fan) and 13" x 13-1/4" (fan/light/night light). All models have a 6" duct connector and the 80 CFM models include a 6" to 4" reducer. All ULTRA 80 and 110 CFM fans can also be used with the MD6TU universal make-up air damper if 6" rigid duct is used. ULTRA non-sensing fans (not fan/lights) can also be used with the RDF1 radiation damper. Now with QStream sound technology that features airflow-smoothing baffles to reduce noise caused by turbulence (50 and 80 CFM models only).

Model No.	Description	Std. Pk.	List Price	Code
Fans				
ZN80M	◆ 80 CFM, <0.3 Sones, ENERGY STAR Motion Sensing Fan	1	\$356.76	HP
ZN110H	◆ 110 CFM, <0.3 Sones, ENERGY STAR Humidity Sensing Fan	1	\$448.82	HP
ZN110M	◆ 110 CFM, <0.3 Sones, ENERGY STAR Motion Sensing Fan	1	\$383.74	HP
Fan/Light/Night Light				
ZN80ML	◆ 80 CFM, <0.3 Sones, ENERGY STAR Motion Sensing Fan with 36W Fluorescent Light (2-18 watt GU24 bulbs included) and 4W Night Light (bulb not included)	1	\$478.38	HP
ZN110HL	◆ 110 CFM, <0.3 Sones, ENERGY STAR Humidity Sensing Fan with 36W Fluorescent Light (2-18 watt GU24 bulbs included) and 4W Night Light (bulb not included)	1	\$570.70	HP
ZN110ML	◆ 110 CFM, <0.3 Sones, ENERGY STAR Motion Sensing Fan with 36W Fluorescent Light (2-18 watt GU24 bulbs included) and 4W Night Light (bulb not included)	1	\$511.80	HP



All models are ENERGY STAR certified products.

- Item too large to ship via UPS/FedEx. Item shipped common carrier at minimum rates.
- * All pricing reflects the individual item cost. You must order in multiples as indicated.
- ◆ UL listed for use over bathtubs and showers when connected to a GFCI protected branch circuit.

Carton/UPC Directory

Model	UPC Code	Std. Carton		Master Carton		Length	Width	Height	Cube
		Pk.	Wt.	Pk.	Wt.				
1006	0 26715 02320 2	—	—	10	20.00	1.48	1.05	0.83	1.28
100HFL	0 26715 18026 4	1	16.90	—	—	1.76	0.87	1.17	1.78
100HL	0 26715 18025 7	1	16.70	—	—	1.75	0.88	1.17	1.80
103023	0 26715 02335 6	1	31.60	—	—	2.46	1.03	1.35	3.43
103123	0 26715 02336 3	1	2.00	—	—	1.87	0.54	0.24	0.24
110RDF	0 26715 14611 6	—	—	4	17.50	1.83	0.98	1.06	1.91
112	0 26715 00405 8	1	12.80	—	—	1.70	0.38	1.11	0.72
114	0 26715 02254 0	1	12.70	—	—	1.68	0.38	1.11	0.72
120	0 26715 00440 9	1	7.30	—	—	1.23	0.93	0.51	0.58
124	0 26715 00441 6	1	7.40	—	—	1.25	0.92	0.50	0.57
128	0 26715 00442 3	1	7.60	—	—	1.25	0.92	0.50	0.57
12C	0 26715 02108 6	1	15.70	—	—	1.25	0.87	1.28	1.38
153001	0 26715 02346 2	1	39.10	—	—	2.88	1.28	1.23	4.49
153004	0 26715 16338 0	1	38.60	—	—	2.88	1.27	1.22	4.44
153023	0 26715 02347 9	1	38.90	—	—	2.89	1.27	1.23	4.52
153601	0 26715 02348 6	1	41.40	—	—	3.38	1.27	1.23	5.24
153604	0 26715 16339 7	1	41.20	—	—	3.38	1.27	1.22	5.21
153623	0 26715 02349 3	1	41.10	—	—	3.36	1.28	1.22	5.24
157	0 26715 08073 1	1	3.00	—	—	1.04	1.06	0.33	0.37
157CBB	0 26715 18259 6	1	7.10	—	—	1.98	1.05	0.13	0.28
157CBL	0 26715 18256 5	1	1.95	16	31.20	0.75	0.94	0.10	0.07
157COD	0 26715 18257 2	1	0.60	10	6.00	0.56	0.54	0.13	0.04
157CTK	0 26715 18258 9	1	2.40	—	—	1.33	0.34	0.33	0.15
161	0 26715 00263 4	1	5.30	—	—	1.15	0.91	0.62	0.64
162	0 26715 00262 7	1	7.40	—	—	1.04	0.90	0.62	0.58
162F	0 26715 02258 8	—	—	4	2.50	0.89	0.88	0.33	0.26
162H	0 26715 02259 5	—	—	4	26.00	1.53	1.05	1.08	1.72
163	0 26715 00261 0	1	7.20	—	—	1.40	0.93	0.58	0.76
164	0 26715 00260 3	1	9.10	—	—	1.38	1.03	0.60	0.85
165F	0 26715 00454 6	1	5.10	—	—	1.24	0.93	0.52	0.59
165FT	0 26715 03035 4	1	6.00	—	—	1.25	0.93	0.50	0.58
1667H	0 26715 02326 4	—	—	6	7.88	1.57	0.68	0.99	1.06
1667HMTL	0 26715 14457 0	—	—	6	8.25	1.56	0.67	0.99	1.03
1670F	0 26715 02327 1	—	—	6	14.63	1.33	1.13	0.92	1.38
1671F	0 26715 02328 8	—	—	6	15.38	1.33	1.14	0.92	1.39
167F	0 26715 00455 3	1	5.20	—	—	1.24	0.93	0.52	0.59
167FT	0 26715 03036 1	1	6.00	—	—	1.25	0.93	0.50	0.58
1688F	0 26715 02329 5	—	—	6	12.75	1.95	0.78	0.83	1.27
1689F	0 26715 02330 1	—	—	6	13.88	1.33	1.14	0.92	1.39
170	0 26715 00443 0	1	7.20	—	—	1.25	0.93	0.51	0.59
171H	0 26715 02262 5	—	—	4	11.00	1.43	1.04	0.84	1.25
174	0 26715 00257 3	1	7.20	—	—	1.24	0.93	0.51	0.58
174F	0 26715 00457 7	1	5.00	—	—	1.25	0.93	0.52	0.60
174FT	0 26715 03038 5	1	5.10	—	—	1.24	0.93	0.52	0.60
178	0 26715 00448 5	1	7.40	—	—	1.25	0.93	0.51	0.59
192	0 26715 10003 3	1	22.00	—	—	1.86	1.53	0.58	1.63
194	0 26715 02265 6	1	21.80	—	—	1.86	1.52	0.58	1.62
198	0 26715 02267 0	1	21.70	—	—	1.85	1.53	0.58	1.65
2677H	0 26715 13914 9	—	—	4	9.75	1.69	0.78	1.07	1.40
2678F	0 26715 13915 6	—	—	4	12.75	1.81	0.99	1.06	1.90
269VL	0 26715 08269 8	1	0.40	—	—	0.41	0.41	0.29	0.05
269WL	0 26715 08268 1	1	0.55	—	—	0.41	0.40	0.33	0.05
273001C	0 26715 05494 7	1	1.40	—	—	3.11	0.23	0.14	0.10
273002C	0 26715 14276 7	1	1.40	—	—	3.07	0.23	0.14	0.10
273003	0 26715 05297 4	1	66.20	—	—	2.83	2.90	0.90	7.39
273023C	0 26715 05497 8	1	1.30	—	—	3.11	0.23	0.14	0.10
273601C	0 26715 05495 4	1	1.50	—	—	3.09	0.23	0.14	0.10
273602C	0 26715 14277 4	1	2.30	—	—	3.11	0.22	0.13	0.09
273603	0 26715 05298 1	1	72.70	—	—	3.33	2.89	0.90	8.67
273623C	0 26715 05496 1	1	1.50	—	—	3.10	0.23	0.14	0.10
277V	0 26715 13191 4	1	0.55	—	—	0.42	0.25	0.31	0.03
283003	0 26715 05408 4	1	37.90	—	—	2.95	2.83	0.91	7.57
283603	0 26715 05409 1	1	43.20	—	—	3.33	2.89	0.92	8.81
326N	7 84891 77015 9	1	1.10	—	—	0.77	0.51	0.25	0.10
330ALM	0 26715 25008 0	1	0.45	20	9.00	0.99	0.53	0.77	0.41
330W	7 84891 99508 8	1	0.23	20	4.60	0.44	0.29	0.15	0.02
331H	0 26715 07181 4	1	30.00	—	—	2.61	0.82	2.33	4.95
332H	0 26715 07182 1	1	32.00	—	—	2.63	0.84	2.33	5.14
332KR	0 26715 12215 8	1	3.30	—	—	2.03	0.93	0.23	0.44
335	0 26715 10996 8	1	38.20	—	—	3.01	1.24	2.19	8.17
336	0 26715 10997 5	1	43.60	—	—	3.00	1.21	2.19	7.93

Model	UPC Code	Std. Carton		Master Carton		Length	Width	Height	Cube
		Pk.	Wt.	Pk.	Wt.				
345CSOBK	0 26715 20467 0	1	20.00	—	—	2.29	0.95	2.61	5.68
345CSOWW	0 26715 20468 7	1	19.60	—	—	2.26	0.96	2.57	5.55
345GOBK	0 26715 20465 6	1	20.90	—	—	2.33	1.05	2.58	6.33
345GOWW	0 26715 20466 3	1	21.90	—	—	2.32	1.08	2.62	6.52
345RSOBK	0 26715 20469 4	1	26.80	—	—	2.02	0.93	2.63	4.94
345RSOWW	0 26715 20470 0	1	26.80	—	—	2.02	0.93	2.63	4.94
345SOBK	0 26715 20471 7	1	21.00	—	—	2.59	0.83	2.25	4.86
345SOWW	0 26715 20472 4	1	20.75	—	—	2.60	0.80	2.27	4.72
349BR	0 26715 18983 0	1	18.20	—	—	2.17	0.75	2.16	3.51
35	0 26715 02169 7	1	1.70	—	—	1.02	0.49	0.13	0.06
350BK	0 26715 18270 1	1	16.60	—	—	1.93	0.72	1.91	2.63
350BR	0 26715 18260 2	1	16.40	—	—	1.92	0.70	1.90	2.55
353	0 26715 00153 8	1	11.10	—	—	1.32	0.73	1.38	1.32
35316	0 26715 13697 1	1	13.10	—	—	1.32	0.72	1.38	1.31
355BK	0 26715 18269 5	1	17.80	—	—	1.93	0.73	1.90	2.65
355BR	0 26715 18268 8	1	17.10	—	—	1.94	0.71	1.88	2.58
356BK	0 26715 18267 1	1	20.40	—	—	1.93	0.78	1.92	2.89
356BR	0 26715 18271 8	1	21.00	—	—	1.94	0.77	1.88	2.80
356NDK	0 26715 17423 2	1	5.10	—	—	2.15	0.89	0.93	1.79
357NDK	0 26715 17424 9	1	5.30	—	—	1.68	1.19	1.05	2.11
358	0 26715 00156 9	1	17.80	—	—	1.99	0.72	1.97	2.81
359NDK	0 26715 23795 1	1	5.10	—	—	1.69	1.19	1.06	2.13
360ALM	0 26715 25007 3	1	9.90	20	198.00	1.08	1.05	0.82	0.93
360IV	7 84891 77161 3	1	0.27	20	5.40	0.35	0.31	0.22	0.02
360W	7 84891 99336 7	1	0.27	20	5.40	0.35	0.31	0.22	0.02
3677H	0 26715 14133 3	—	—	4	13.25	1.70	0.76	1.07	1.38
372	7 84891 77220 7	1	7.00	—	—	0.82	1.47	1.43	1.72
372401	0 26715 03224 2	1	6.80	—	—	2.25	0.64	1.63	2.35
372408	0 26715 03225 9	1	7.00	—	—	2.25	0.63	1.63	2.30
373001	0 26715 03227 3	1	8.30	—	—	2.75	0.64	1.63	2.87
373002	0 26715 14257 6	1	8.40	—	—	2.75	0.63	1.62	2.82
373004	0 26715 04454 2	1	8.80	—	—	2.75	0.63	1.63	2.83
373008	0 26715 03228 0	1	8.40	—	—	2.76	0.63	1.63	2.84
373601	0 26715 03232 7	1	9.70	—	—	3.25	0.65	1.63	3.43
373604	0 26715 04455 9	1	9.90	—	—	3.25	0.63	1.63	3.34
376JL	7 84891 99227 8	1	1.74	6	10.44	0.55	0.55	0.28	0.08
378	7 84891 99229 2	1	0.10	20	2.00	0.29	0.13	0.01	0.00
3808	7 84891 99231 5	—	—	8	13.70	8.00	0.67	0.33	1.78
3808B	7 84891 77261 0	—	—	440	742.50	0.67	8.00	0.33	1.78
3810	0 26715 23544 5	—	—	10	22.00	10.00	0.71	0.46	3.25
391	7 84891 99240 7	1	0.50	6	3.00	0.73	0.67	0.15	0.07
392	7 84891 77320 4	1	0.97	—	—	0.93	0.33	0.33	0.10
393	7 84891 99242 1	1	0.90	6	5.40	0.55	0.54	0.27	0.08
394	7 84891 99339 8	1	0.10	10	1.00	0.03	0.25	0.32	0.00
395	7 84891 99243 8	1	1.90	6	11.40	2.32	0.33	0.50	0.39
3964	0 26715 23843 9	1	5.20	—	—	0.94	0.69	0.81	0.53
402101	0 26715 03090 3	1	10.10	—	—	2.00	0.63	1.65	2.09
402102	0 26715 14273 6	1	9.30	—	—	2.00	0.63	1.63	2.06
402108	0 26715 03091 0	1	9.30	—	—	2.00	0.63	1.63	2.06
402401	0 26715 02358 5	1	10.90	—	—	2.24	0.63	1.63	2.28
402402</									

Model	UPC Code	Std. Carton		Master Carton		Length	Width	Height	Cube
		Pk.	Wt.	Pk.	Wt.				
412101	0 26715 03100 9	1	9.30	—	—	2.00	0.63	1.63	2.06
412102	0 26715 14272 9	1	9.30	—	—	2.00	0.63	1.63	2.06
412108	0 26715 03101 6	1	9.30	—	—	2.00	0.63	1.63	2.06
412123	0 26715 18790 4	1	9.30	—	—	2.00	0.63	1.63	2.06
412401	0 26715 00842 1	1	10.10	—	—	2.24	0.63	1.62	2.27
412402	0 26715 14248 4	1	10.10	—	—	2.24	0.63	1.62	2.27
412404	0 26715 00843 8	1	10.40	—	—	2.23	0.63	1.63	2.30
412408	0 26715 00844 5	1	10.10	—	—	2.24	0.63	1.62	2.27
412H	0 26715 00268 9	1	1.45	—	—	0.88	0.87	0.65	0.50
413	0 26715 01599 3	1	1.90	—	—	1.03	1.03	0.87	0.91
413001	0 26715 00230 6	1	11.40	—	—	2.75	0.63	1.63	2.79
413002	0 26715 14249 1	1	11.40	—	—	2.75	0.63	1.63	2.79
413004	0 26715 00406 5	1	11.70	—	—	2.75	0.64	1.63	2.87
413008	0 26715 00231 3	1	11.40	—	—	2.75	0.63	1.63	2.79
413023	0 26715 03106 1	1	11.40	—	—	2.75	0.63	1.63	2.79
413601	0 26715 00232 0	1	12.60	—	—	3.24	0.63	1.63	3.34
413602	0 26715 14250 7	1	12.60	—	—	3.24	0.63	1.63	3.34
413604	0 26715 02364 6	1	13.20	—	—	3.24	0.63	1.63	3.34
413608	0 26715 00233 7	1	12.60	—	—	3.24	0.63	1.63	3.34
413623	0 26715 03107 8	1	12.60	—	—	3.24	0.63	1.63	3.34
414	0 26715 07547 8	1	1.90	—	—	1.02	1.01	0.88	0.90
414201	0 26715 00411 9	1	13.80	—	—	3.75	0.63	1.62	3.84
414202	0 26715 14251 4	1	13.80	—	—	3.75	0.63	1.62	3.84
414204	0 26715 03583 0	1	14.50	—	—	3.75	0.63	1.62	3.79
414208	0 26715 00412 6	1	13.80	—	—	3.75	0.63	1.62	3.84
415	0 26715 00796 7	—	—	4	6.50	1.69	1.68	0.68	1.92
418	0 26715 05945 4	1	3.40	—	—	1.13	1.12	0.90	1.14
419	0 26715 01600 6	1	1.10	—	—	0.98	0.77	0.77	0.58
41F	0 26715 00091 3	—	—	6	1.50	0.94	0.41	0.85	0.33
421	0 26715 03900 5	1	0.75	—	—	0.96	0.84	0.13	0.10
422401	0 26715 03110 8	1	10.40	—	—	2.23	0.65	1.62	2.35
422401D	0 26715 17252 8	1	10.40	—	—	2.23	0.65	1.62	2.35
422402	0 26715 14245 3	1	10.40	—	—	2.23	0.65	1.62	2.35
422404	0 26715 03111 5	1	10.70	—	—	2.23	0.63	1.63	2.30
422408	0 26715 03112 2	1	10.40	—	—	2.23	0.65	1.62	2.35
423	0 26715 03902 9	1	3.60	—	—	1.60	0.95	0.95	1.44
423001	0 26715 00226 9	1	11.60	—	—	2.75	0.63	1.63	2.79
423001D	0 26715 17257 3	1	11.60	—	—	2.75	0.63	1.63	2.79
423002	0 26715 14246 0	1	11.60	—	—	2.75	0.63	1.63	2.79
423004	0 26715 00414 0	1	12.10	—	—	2.73	0.63	1.63	2.81
423008	0 26715 00227 6	1	11.60	—	—	2.75	0.63	1.63	2.79
423008D	0 26715 17253 5	1	11.60	—	—	2.75	0.63	1.63	2.79
423023	0 26715 03116 0	1	11.60	—	—	2.75	0.63	1.63	2.79
423601	0 26715 00228 3	1	12.90	—	—	3.24	0.65	1.63	3.42
423601D	0 26715 17255 9	1	12.90	—	—	3.24	0.65	1.63	3.42
423602	0 26715 14247 7	1	12.90	—	—	3.24	0.65	1.63	3.42
423604	0 26715 00417 1	1	13.50	—	—	3.25	0.64	1.63	3.39
423608	0 26715 00229 0	1	12.90	—	—	3.24	0.65	1.63	3.42
423608D	0 26715 17254 2	1	12.90	—	—	3.24	0.65	1.63	3.42
423623	0 26715 03117 7	1	12.90	—	—	3.24	0.65	1.63	3.42
424	0 26715 03903 6	1	4.10	—	—	1.61	0.96	0.94	1.45
424201	0 26715 00420 1	1	14.10	—	—	3.75	0.63	1.63	3.88
424201D	0 26715 17256 6	1	12.90	—	—	3.24	0.65	1.63	3.42
424202	0 26715 14292 7	1	14.10	—	—	3.75	0.65	1.63	3.96
424204	0 26715 03584 7	1	14.90	—	—	3.75	0.63	1.63	3.88
424208	0 26715 00421 8	1	14.10	—	—	3.75	0.65	1.63	3.96
427	0 26715 12607 1	1	2.50	—	—	1.65	0.94	0.60	0.93
428	0 26715 01114 8	1	1.30	—	—	1.03	0.49	0.72	0.36
429	0 26715 01115 5	1	2.20	—	—	1.00	1.03	0.88	0.90
430	0 26715 01601 3	1	2.80	—	—	0.98	0.90	0.53	0.47
431	0 26715 01602 0	1	3.60	—	—	1.02	0.88	0.79	0.71
432	0 26715 22966 6	1	1.95	—	—	1.02	1.00	0.85	0.87
433	0 26715 00051 7	1	3.25	—	—	1.74	1.63	0.24	0.69
433004	0 26715 10058 3	1	14.20	—	—	2.78	0.62	1.61	2.75
433011	0 26715 10056 9	1	13.80	—	—	2.75	0.67	1.63	2.98
433018	0 26715 10057 6	1	14.90	—	—	2.75	0.65	1.64	2.93
433022	0 26715 14234 7	1	14.40	—	—	2.76	0.64	1.63	2.89
433023	0 26715 14519 5	1	13.80	—	—	2.77	0.64	1.63	2.88
433604	0 26715 10061 3	1	15.80	—	—	3.26	0.64	1.65	3.44
433611	0 26715 10059 0	1	15.80	—	—	3.28	0.65	1.65	3.50
433618	0 26715 10060 6	1	15.60	—	—	3.26	0.63	1.64	3.39

Model	UPC Code	Std. Carton		Master Carton		Length	Width	Height	Cube
		Pk.	Wt.	Pk.	Wt.				
433622	0 26715 14235 4	1	16.20	—	—	3.27	0.63	1.64	3.40
433623	0 26715 14520 1	1	15.20	—	—	3.26	0.65	1.64	3.48
437	0 26715 03907 4	1	12.00	—	—	2.34	0.83	1.58	3.07
438	0 26715 07549 2	1	1.60	—	—	0.69	0.69	0.69	0.33
441	0 26715 03908 1	1	3.80	—	—	1.13	1.17	0.32	0.42
453	0 26715 04491 7	1	5.20	—	—	2.08	1.00	1.00	2.08
454	0 26715 04492 4	1	5.10	—	—	2.11	1.08	1.06	2.41
459	0 26715 15379 4	1	1.90	—	—	1.28	0.67	0.77	0.65
462401	0 26715 14502 7	1	12.20	—	—	2.23	0.66	1.63	2.39
462404	0 26715 14503 4	1	12.60	—	—	2.23	0.66	1.63	2.39
462423	0 26715 14505 8	1	12.20	—	—	2.23	0.66	1.63	2.39
463001	0 26715 01062 2	1	13.40	—	—	2.75	0.67	1.62	2.96
463002	0 26715 14242 2	1	13.40	—	—	2.75	0.67	1.62	2.96
463004	0 26715 00237 5	1	13.90	—	—	2.74	0.65	1.63	2.91
463008	0 26715 00234 4	1	13.40	—	—	2.75	0.67	1.62	2.96
463011	0 26715 10395 9	1	13.40	—	—	2.75	0.67	1.62	2.96
463023	0 26715 03120 7	1	13.40	—	—	2.75	0.67	1.62	2.96
463601	0 26715 01061 5	1	14.90	—	—	3.25	0.66	1.63	3.48
463602	0 26715 14243 9	1	14.90	—	—	3.25	0.66	1.63	3.48
463604	0 26715 00241 2	1	15.40	—	—	3.23	0.64	1.62	3.35
463608	0 26715 00238 2	1	14.90	—	—	3.25	0.66	1.63	3.48
463623	0 26715 03122 1	1	14.90	—	—	3.25	0.66	1.63	3.48
464201	0 26715 00242 9	1	16.00	—	—	3.75	0.63	1.63	3.88
464202	0 26715 14244 6	1	16.00	—	—	3.75	0.63	1.63	3.88
464204	0 26715 00244 3	1	16.50	—	—	3.75	0.63	1.63	3.88
464208	0 26715 00243 6	1	16.00	—	—	3.75	0.63	1.63	3.88
472	0 26715 02281 6	1	2.60	—	—	0.87	0.87	0.68	0.51
475	0 26715 16541 4	1	0.30	—	—	0.57	0.57	0.38	0.12
475B	0 26715 16540 7	—	—	6	1.13	0.97	0.54	0.56	0.29
502	0 26715 02282 3	1	10.80	—	—	1.46	0.63	1.20	1.11
503	0 26715 02283 0	1	7.90	—	—	1.28	0.58	1.05	0.77
504	0 26715 02284 7	1	8.60	—	—	1.17	0.80	1.18	1.10
505	0 26715 02285 4	1	7.00	—	—	1.15	0.74	1.16	0.99
506	0 26715 02286 1	1	12.60	—	—	1.24	0.78	1.26	1.22
507	0 26715 02287 8	1	11.10	—	—	1.25	0.79	1.26	1.25
508	0 26715 02288 5	1	13.30	—	—	1.64	0.89	1.25	1.83
509	0 26715 02289 2	1	12.70	—	—	1.64	0.92	1.23	1.86
509S	0 26715 02290 8	1	13.00	—	—	1.60	0.90	1.19	1.71
510	0 26715 02291 5	1	10.20	—	—	1.14	0.78	1.18	1.04
511	0 26715 02292 2	1	8.30	—	—	1.15	0.78	1.18	1.05
512	0 26715 02293 9	1	3.20	—	—	0.73	0.72	0.59	0.31
512M	0 26715 06713 8	1	3.40	—	—	0.71	0.71	0.82	0.41
57V	0 26715 03815 2	1	0.30	—	—	0.43	0.25	0.30	0.03
57W	0 26715 03859 6	1	0.30	—	—	0.43	0.25	0.30	0.03
59V	0 26715 03820 6	1	0.40	—	—	0.43	0.25	0.30	0.03
59W	0 26715 03864 0	1	0.40	—	—	0.43	0.25	0.30	0.03
59V	0 26715 03820 6	1	0.40	—	—	0.43	0.25	0.30	0.03
59W	0 26715 03864 0	1	0.40	—	—	0.43	0.25	0.30	0.03
605RP	7 84891 34408 4	1	12.70	—	—	1.59	0.99	0.78	1.24
610FA	0 26715 21105 0	1	2.50	—	—	1.13	1.13	0.90	1.13
611	0 26715 06692 6	1	3.40	—	—				

Model	UPC Code	Std. Carton		Master Carton		Length	Width	Height	Cube
		Pk.	Wt.	Pk.	Wt.				
637004EX	0 26715 15233 9	1	82.00	—	—	3.58	2.63	2.13	19.99
639	0 26715 00264 1	1	2.50	—	—	1.12	0.82	0.54	0.49
63V	0 26715 03829 9	1	0.70	—	—	0.41	0.41	0.31	0.05
63W	0 26715 03873 2	1	0.80	—	—	0.41	0.41	0.29	0.05
641	0 26715 01137 7	1	1.30	—	—	0.79	0.79	0.67	0.42
641FA	0 26715 19206 9	1	1.20	—	—	0.78	0.78	0.66	0.40
642	0 26715 01138 4	—	—	4	3.50	1.13	1.13	0.83	1.06
643	0 26715 02294 6	1	2.40	—	—	1.13	1.13	0.88	1.13
643FA	0 26715 19207 6	1	2.40	—	—	1.13	1.13	0.89	1.14
644	0 26715 00393 8	1	3.20	—	—	1.60	1.21	0.61	1.18
646	0 26715 01605 1	1	0.90	—	—	0.69	0.71	0.70	0.34
647	0 26715 05212 7	1	1.40	—	—	0.78	0.79	0.68	0.42
649	0 26715 00394 5	1	1.40	—	—	1.10	0.82	0.55	0.49
64V	0 26715 04986 8	1	0.50	—	—	0.43	0.24	0.30	0.03
64W	0 26715 15854 6	1	0.50	—	—	0.43	0.24	0.30	0.03
654H	0 26715 02295 3	—	—	4	20.25	1.49	1.09	1.28	2.09
655	0 26715 00254 2	1	13.10	—	—	1.53	1.00	0.78	1.20
655F	0 26715 02296 0	1	8.60	—	—	1.43	0.96	0.74	1.02
656	0 26715 02297 7	1	11.30	—	—	1.53	1.01	0.81	1.25
656F	0 26715 02298 4	1	6.98	—	—	1.45	0.97	0.76	1.07
657	0 26715 02299 1	1	9.70	—	—	1.54	1.01	0.80	1.24
657F	0 26715 02300 4	1	5.20	—	—	1.45	0.95	0.73	1.00
658	0 26715 02301 1	1	12.40	—	—	1.53	1.01	0.81	1.25
658F	0 26715 02302 8	1	8.10	—	—	1.44	0.95	0.73	0.99
659	0 26715 02303 5	1	12.50	—	—	1.53	1.01	0.82	1.26
659F	0 26715 02304 2	1	8.40	—	—	1.43	0.96	0.74	1.01
665RP	7 84891 34447 3	1	12.80	—	—	1.58	1.00	0.79	1.25
668RP	7 84891 34451 0	1	9.10	—	—	1.58	0.99	0.79	1.24
66V	0 26715 03836 7	1	0.35	—	—	0.43	0.26	0.31	0.04
66W	0 26715 03877 0	1	0.35	—	—	0.43	0.26	0.31	0.04
670	0 26715 02305 9	1	3.80	—	—	0.84	0.36	0.78	0.24
671	0 26715 00252 8	1	3.70	—	—	0.85	0.37	0.78	0.24
673	0 26715 00253 5	1	3.20	—	—	0.72	0.32	0.59	0.30
678	0 26715 00259 7	1	5.90	—	—	0.79	0.98	1.08	0.84
67W	0 26715 03882 4	1	0.30	—	—	0.43	0.27	0.33	0.04
682	0 26715 00719 6	1	3.50	—	—	0.78	0.43	0.73	0.25
682NT	7 84891 30168 1	1	3.50	—	—	0.80	0.44	0.73	0.26
685WL	0 26715 08272 8	1	0.60	—	—	0.41	0.42	0.32	0.05
688	0 26715 00251 1	1	3.50	—	—	0.85	0.37	0.78	0.24
689	0 26715 00289 4	1	3.50	—	—	0.85	0.37	0.74	0.23
68V	0 26715 03844 2	1	0.90	—	—	0.43	0.27	0.33	0.04
68W	0 26715 03885 5	1	0.35	—	—	0.43	0.26	0.31	0.04
690	0 26715 16807 1	1	4.80	—	—	0.95	0.43	0.81	0.33
690NT	7 84891 25870 1	1	4.70	—	—	0.94	0.44	0.82	0.34
690RA	7 84891 25450 5	—	—	6	7.88	1.58	0.68	0.99	1.07
690RMTLA	7 84891 25451 2	—	—	6	8.25	1.56	0.67	0.98	1.02
695	7 84891 25836 7	1	3.80	—	—	0.85	0.38	0.79	0.25
695RB	7 84891 25453 6	—	—	6	15.75	1.32	1.14	1.00	1.50
696	0 26715 02315 8	1	10.30	—	—	1.54	1.01	0.80	1.24
696N	7 84891 25841 1	1	3.40	—	—	0.86	0.38	0.80	0.26
696RNB	7 84891 25455 0	—	—	6	12.48	1.95	0.79	0.88	1.35
69W	0 26715 08225 4	1	0.30	—	—	0.43	0.27	0.33	0.04
70TW	0 26715 18793 5	1	0.70	—	—	0.47	0.30	0.42	0.06
71V	0 26715 03852 7	1	1.00	—	—	0.43	0.25	0.30	0.03
72V	0 26715 03855 8	1	0.50	—	—	0.43	0.25	0.30	0.03
72W	0 26715 05375 9	1	0.50	—	—	0.43	0.25	0.30	0.03
72V	0 26715 03855 8	1	0.50	—	—	0.43	0.25	0.30	0.03
72W	0 26715 05375 9	1	0.50	—	—	0.43	0.25	0.30	0.03
73	0 26715 01606 8	1	0.70	—	—	0.73	0.28	0.28	0.06
741SN	0 26715 14509 6	1	10.90	—	—	1.18	1.18	1.14	1.58
744	0 26715 16301 4	1	9.40	—	—	1.20	0.79	0.88	0.83
744FL	0 26715 17091 3	1	10.20	—	—	1.21	0.79	0.90	0.86
744FLNT	7 84891 95128 2	1	9.80	—	—	1.22	0.83	0.89	0.89
744LED	0 26715 20915 6	1	10.30	—	—	1.23	0.79	0.92	0.89
744LEDNT	0 26715 20916 3	1	10.30	—	—	1.23	0.81	0.91	0.90
744NT	7 84891 95124 4	1	9.60	—	—	1.23	0.81	0.91	0.90
744SFL	0 26715 19208 3	1	10.30	—	—	1.23	0.90	0.81	0.89
744SFLNT	0 26715 19209 0	1	10.30	—	—	1.23	0.81	0.91	0.90
750	0 26715 14867 7	1	11.80	—	—	1.39	0.83	1.38	1.60
751	0 26715 14868 4	1	12.00	—	—	1.40	0.82	1.38	1.58
754RB	0 26715 16735 7	1	11.80	—	—	1.18	1.16	1.27	1.72

Model	UPC Code	Std. Carton		Master Carton		Length	Width	Height	Cube
		Pk.	Wt.	Pk.	Wt.				
75V	0 26715 03832 9	1	0.50	—	—	0.43	0.26	0.30	0.03
761BN	0 26715 19152 9	1	11.60	—	—	1.23	1.23	1.20	1.80
761RB	0 26715 19153 6	1	11.80	—	—	1.23	1.22	1.20	1.80
761WHA	0 26715 20106 8	1	12.20	—	—	1.23	1.22	1.21	1.80
763	0 26715 23517 9	1	5.90	—	—	0.79	0.98	1.08	0.84
763F	0 26715 23686 2	—	—	4	13.45	1.81	0.99	1.06	1.90
763H	0 26715 23685 5	—	—	4	9.80	1.69	0.75	1.08	1.36
765HFL	0 26715 18028 8	1	17.30	—	—	1.76	0.88	1.18	1.82
765HL	0 26715 18027 1	1	16.80	—	—	1.75	0.87	1.17	1.77
77DV	0 26715 10631 8	1	0.90	—	—	0.43	0.26	0.33	0.04
77DW	0 26715 10630 1	1	0.90	—	—	0.43	0.26	0.33	0.04
77DV	0 26715 10631 8	1	0.90	—	—	0.43	0.26	0.33	0.04
77DW	0 26715 10630 1	1	0.90	—	—	0.43	0.26	0.33	0.04
77DV	0 26715 10631 8	1	0.90	—	—	0.43	0.26	0.33	0.04
78V	0 26715 07888 2	1	0.90	—	—	0.43	0.26	0.33	0.04
78W	0 26715 07889 9	1	0.90	—	—	0.43	0.26	0.33	0.04
791LEDM	0 26715 23955 9	1	9.90	—	—	1.24	0.90	1.25	1.40
79V	0 26715 07890 5	1	0.30	—	—	0.43	0.26	0.33	0.04
79W	0 26715 07891 2	1	0.40	—	—	0.43	0.24	0.33	0.03
804DD	7 84891 27013 0	1	0.20	24	4.80	0.33	0.33	0.13	0.01
804DU	7 84891 27039 0	1	6.20	—	—	0.69	0.68	2.58	1.21
804QDD	0 26715 23484 4	1	0.40	—	—	0.42	0.42	0.23	0.04
80L	0 26715 17226 9	1	0.40	—	—	0.27	0.22	0.50	0.03
80RDF	0 26715 14612 3	—	—	4	17.50	1.83	0.99	1.03	1.87
8210	7 84891 21210 9	1	6.30	—	—	0.94	0.73	0.95	0.66
82W	0 26715 23034 1	1	0.32	—	—	0.37	0.18	0.19	0.01
83	0 26715 02241 0	1	0.30	—	—	0.43	0.25	0.31	0.03
8310	7 84891 21310 6	1	7.70	—	—	1.26	0.63	1.03	0.82
834	7 84891 99161 5	1	0.20	6	1.20	0.88	0.88	0.06	0.04
84	0 26715 02243 4	1	2.80	—	—	1.13	0.89	0.40	0.40
843BL	0 26715 16460 8	1	2.90	—	—	0.79	0.78	0.66	0.41
85	0 26715 02244 1	1	5.40	—	—	1.90	1.56	0.39	1.16
854	7 84891 99282 7	—	—	6	2.63	1.11	1.08	0.31	0.37
8663RP	7 84891 21615 2	1	11.70	—	—	1.40	0.83	1.40	1.62
8664RP	7 84891 21625 1	1	11.70	—	—	1.38	0.81	1.38	1.54
877	7 84891 27570 8	1	1.30	—	—	0.90	0.67	0.73	0.44
87W	0 26715 25037 0	1	18.00	50	900.00	1.50	1.25	0.79	1.48
883001	0 26715 01093 6	1	31.00	—	—	2.67	1.00	1.83	4.89
883002	0 26715 14236 1	1	31.30	—	—	2.67	1.83	1.00	4.89
883004	0 26715 01094 3	1	30.20	—	—	2.75	1.04	1.88	5.37
883008	0 26715 01095 0	1	32.10	—	—	2.67	1.83	1.00	4.89
883011	0 26715 02382 0	1	31.70	—	—	2.75	1.00	1.83	5.04
883023	0 26715 01106 3	1	31.60	—	—	2.67	1.83	1.00	4.89
883601	0 26715 01099 8	1	34.60	—	—	3.17	1.83	1.00	5.81
883604	0 26715 01100 1	1	33.30	—	—	3.17	1.83	1.00	5.81
883608	0 26715 01101 8	1	34.30	—	—	3.17	1.83	1.00	5.81
883623	0 26715 02384 4	1	33.40	—	—	3.25	1.83	1.00	5.96
883901	0 26715 10692 9	1	34.90	—	—	3.48	1.03	1.84	6.56
883904	0 26715 10693 6	1	32.50	—	—	3.48	1.03	1.84	6.56
884201	0 26715 02385 1	1	36.10	—	—	3.72	1.09	1.86	7.54
884204	0 26715 02386 8	1	35.80	—	—	3.77	1.03	1.86	7.23
884223	0 26715 02392 9	1	34.50	—	—	3.71	1.04	1.83	7.08
884									

Model	UPC Code	Std. Carton		Master Carton		Length	Width	Height	Cube
		Pk.	Wt.	Pk.	Wt.				
894223	0 26715 08251 3	1	35.50	—	—	3.72	1.05	1.86	7.25
894801	0 26715 08248 3	1	38.50	—	—	4.23	1.03	1.88	8.12
894804	0 26715 02396 7	1	37.80	—	—	4.21	1.03	1.88	8.09
90	0 26715 02249 6	1	0.35	—	—	0.40	0.40	0.29	0.05
9093WH	7 84891 32194 8	1	20.30	—	—	1.51	0.98	1.48	2.20
9412D	7 84891 32600 4	1	5.30	—	—	1.14	0.90	0.61	0.63
9417DN	7 84891 32594 6	1	7.40	—	—	1.05	0.90	0.63	0.59
9422P	7 84891 32648 6	1	7.50	—	—	1.37	0.92	0.59	0.74
9427P	7 84891 32649 3	1	9.00	—	—	1.38	1.04	0.62	0.88
961L	0 26715 13188 4	1	2.10	—	—	1.06	1.05	0.18	0.20
97	0 26715 03890 9	1	1.60	—	—	0.68	0.68	0.71	0.33
9810WH	7 84891 32811 4	1	9.80	—	—	1.13	0.48	1.43	0.77
9815WH	7 84891 32816 9	1	9.80	—	—	1.44	0.46	1.12	0.74
981L	0 26715 12471 8	1	1.60	—	—	1.06	1.05	0.18	0.19
982L	0 26715 12472 5	1	2.90	—	—	1.84	1.04	0.19	0.37
983L	0 26715 12473 2	1	3.60	—	—	1.86	1.53	0.18	0.50
9905	7 84891 32830 5	1	12.50	—	—	1.58	1.16	0.99	1.82
9960	7 84891 32840 4	1	12.90	—	—	1.58	1.17	1.02	1.87
9965	7 84891 32850 3	1	14.80	—	—	1.58	1.16	1.01	1.85
A000HF	0 26715 23611 4	—	—	4	11.30	1.95	0.97	1.07	2.01
A000HFS	0 26715 24930 5	—	—	4	13.00	1.93	0.97	1.08	2.00
A000HL	0 26715 23662 6	—	—	4	11.55	1.94	0.96	1.08	2.00
A110	0 26715 23653 4	1	8.90	—	—	1.11	1.11	0.92	1.13
A110F	0 26715 23660 2	—	—	4	23.15	2.22	1.04	1.25	2.89
A110L	0 26715 23533 9	1	9.61	—	—	1.10	1.10	1.04	1.27
A50L	0 26715 23648 0	1	9.36	—	—	1.10	1.10	1.04	1.27
A70L	0 26715 23649 7	1	9.56	—	—	1.10	1.10	1.04	1.27
A70LF	0 26715 23656 5	—	—	4	26.50	2.21	1.04	1.75	4.03
A80	0 26715 23651 0	1	8.75	—	—	1.11	1.11	0.92	1.13
A80F	0 26715 23657 2	—	—	4	22.40	2.21	1.04	1.25	2.88
A80HD	0 26715 23652 7	1	9.45	—	—	1.11	1.11	0.92	1.13
A80HDF	0 26715 23658 9	—	—	4	25.30	2.22	1.04	1.25	2.89
A80L	0 26715 23531 5	1	9.61	—	—	1.10	1.10	1.04	1.27
ACCGSEF2	0 26715 15658 0	1	0.20	—	—	0.70	0.39	0.15	0.04
ACCGSFF2	0 26715 15255 1	1	0.20	—	—	0.77	0.40	0.15	0.05
ACCGSFH	0 26715 15253 7	1	2.90	—	—	1.69	1.62	0.20	0.55
ACCGSFHP10	0 26715 15260 5	1	33.90	—	—	2.21	1.77	1.70	6.63
ACCGSFHP2	0 26715 15254 4	1	3.20	—	—	1.69	1.62	0.21	0.57
ACCGSFP2	0 26715 15252 0	1	0.91	—	—	1.67	1.31	0.06	0.14
ACCGSFP20	0 26715 15259 9	1	10.10	—	—	1.75	1.38	0.62	1.48
ACCGSUHD	0 26715 15257 5	1	2.00	—	—	0.96	0.81	0.88	0.68
ACCGSUP5	0 26715 15256 8	1	0.50	—	—	0.68	0.53	0.40	0.14
ACCHEPAPFK	0 26715 22860 7	1	0.50	—	—	0.96	0.21	1.08	0.22
ACCHEPARF	0 26715 22859 1	1	1.20	—	—	0.96	0.21	1.08	0.22
ACCWVK	0 26715 22858 4	1	1.55	—	—	2.06	0.21	0.17	0.07
AE110	0 26715 23529 2	1	8.80	—	—	1.11	1.11	0.92	1.13
AE110F	0 26715 23607 7	—	—	4	22.80	2.23	1.04	1.25	2.90
AE110L	0 26715 23666 4	1	9.07	—	—	1.13	1.10	0.92	1.13
AE110LF	0 26715 24188 0	—	—	4	24.00	2.21	1.03	1.26	2.87
AE110S	0 26715 24928 2	1	9.50	—	—	1.13	1.11	0.92	1.15
AE110SL	0 26715 24929 9	1	9.80	—	—	1.13	1.11	0.92	1.15
AE50	0 26715 23646 6	1	8.60	—	—	1.11	1.11	0.92	1.13
AE50F	0 26715 23655 8	—	—	4	22.10	2.23	1.04	1.26	2.92
AE60	0 26715 10573 1	1	31.60	—	—	2.19	1.10	1.39	3.36
AE80	0 26715 23527 8	1	8.75	—	—	1.11	1.11	0.92	1.13
AE80B	0 26715 23600 8	1	8.75	—	—	1.11	1.11	0.92	1.13
AE80BF	0 26715 23609 1	—	—	4	22.50	2.23	1.04	1.25	2.90
AE80BL	0 26715 23957 3	1	9.16	—	—	1.10	1.10	0.88	1.08
AE80BLF	0 26715 23958 0	—	—	4	24.03	2.21	1.04	1.23	2.83
AE80F	0 26715 23605 3	—	—	4	22.40	2.21	1.04	1.25	2.88
AE80L	0 26715 23664 0	1	9.00	—	—	1.13	1.10	0.92	1.13
AE80LF	0 26715 23668 8	—	—	4	24.05	2.20	1.03	1.26	2.86
AE80S	0 26715 24926 8	1	9.40	—	—	1.13	1.11	0.92	1.15
AE80SL	0 26715 24927 5	1	9.70	—	—	1.11	1.11	0.92	1.13
AEE60302SS	0 26715 18645 7	1	12.30	—	—	3.72	2.26	0.42	3.50
AEE60362SS	0 26715 18646 4	1	11.90	—	—	3.70	2.26	0.42	3.48
AEE60422SS	0 26715 18647 1	1	13.90	—	—	4.67	2.25	0.42	4.37
AEE60482SS	0 26715 18648 8	1	14.00	—	—	4.67	2.25	0.42	4.37
AEPD18SS	0 26715 20409 0	1	16.45	—	—	2.38	1.38	1.90	6.24
AEPD18SSE	0 26715 20412 0	1	14.60	—	—	2.17	1.33	1.50	4.33
AEPD2445SS	0 26715 22743 3	1	35.80	—	—	2.42	1.38	2.38	7.94

Model	UPC Code	Std. Carton		Master Carton		Length	Width	Height	Cube
		Pk.	Wt.	Pk.	Wt.				
AEEP2445SSE	0 26715 22744 0	1	33.00	—	—	2.04	1.40	2.17	6.17
AEEP30SS	0 26715 20410 6	1	24.10	—	—	2.90	1.38	2.38	9.53
AEEP30SSE	0 26715 20413 7	1	22.30	—	—	2.53	1.37	2.21	7.65
AEEP6SS	0 26715 20408 3	1	5.60	—	—	2.19	0.55	1.11	1.34
AEEP6SSE	0 26715 20411 3	1	6.00	—	—	2.21	0.54	1.38	1.64
AEN110	0 26715 23530 8	1	8.80	—	—	1.11	1.11	0.92	1.13
AEN110F	0 26715 23608 4	—	—	4	22.90	2.22	1.04	1.25	2.89
AEN110L	0 26715 23667 1	1	9.35	—	—	1.13	1.10	0.92	1.13
AEN50	0 26715 23647 3	1	8.60	—	—	1.11	1.11	0.92	1.13
AEN50F	0 26715 23683 1	—	—	4	21.75	2.22	1.04	1.25	2.89
AEN80	0 26715 23528 5	1	8.75	—	—	1.11	1.11	0.92	1.13
AEN80B	0 26715 23601 5	1	8.75	—	—	1.11	1.11	0.92	1.13
AEN80BF	0 26715 23610 7	—	—	4	22.40	2.21	1.04	1.25	2.88
AEN80BL	0 26715 23959 7	1	9.26	—	—	1.10	1.10	0.90	1.09
AEN80BLF	0 26715 23960 3	—	—	4	24.03	2.21	1.04	1.23	2.83
AEN80F	0 26715 23606 0	—	—	4	22.40	2.21	1.04	1.25	2.88
AEN80L	0 26715 23665 7	1	9.10	—	—	1.13	1.10	0.92	1.13
AEN80LF	0 26715 23669 5	—	—	4	24.20	2.21	1.04	1.23	2.83
AN000HF	0 26715 23612 1	—	—	4	11.30	1.95	0.97	1.07	2.01
AN000HL	0 26715 23663 3	—	—	4	11.55	1.95	0.97	1.08	2.03
AN110	0 26715 23654 1	1	8.90	—	—	1.11	1.11	0.92	1.13
AN110F	0 26715 23661 9	—	—	4	22.90	2.22	1.04	1.25	2.89
AN110L	0 26715 23534 6	1	9.61	—	—	1.10	1.10	1.04	1.27
AN70L	0 26715 23650 3	1	9.61	—	—	1.10	1.10	1.04	1.27
AN70LF	0 26715 23684 8	—	—	4	26.50	2.21	1.04	1.75	4.03
AN80HDF	0 26715 23659 6	—	—	4	25.30	2.22	1.04	1.25	2.89
AN80L	0 26715 23532 2	1	9.61	—	—	1.10	1.10	1.04	1.27
ANKE60302SS	0 26715 18641 9	1	12.00	—	—	3.68	2.27	0.42	3.48
ANKE60362SS	0 26715 18642 6	1	12.50	—	—	3.68	2.27	0.43	3.55
ANKE60422SS	0 26715 18643 3	1	16.50	—	—	4.67	2.25	0.42	4.37
ANKE60482SS	0 26715 18644 0	1	16.80	—	—	4.67	2.25	0.42	4.37
AP130BL	0 26715 17586 4	1	31.10	—	—	2.71	1.04	2.06	5.81
AP130SS	0 26715 17584 0	1	32.00	—	—	2.70	1.03	2.04	5.65
AP130WW	0 26715 17585 7	1	34.00	—	—	2.68	1.03	2.04	5.66
AP136BL	0 26715 17589 5	1	35.30	—	—	3.19	1.03	2.06	6.73
AP136SS	0 26715 17587 1	1	34.10	—	—	3.21	1.03	2.04	6.77
AP136WW	0 26715 17588 8	1	34.50	—	—	3.18	1.03	2.07	6.74
APE130SS	0 26715 19721 7	1	33.40	—	—	2.70	1.03	2.05	5.72
ARP310	0 26715 18222 0	—	—	5	1.25	0.68	0.52	0.40	0.14
ARP314	0 26715 18223 7	—	—	5	1.56	0.68	0.53	0.38	0.13
ARP6	0 26715 18224 4	—	—	5	1.88	0.68	0.51	0.39	0.13
AVDOFPN	7 84891 71271 5	1	16.10	—	—	1.85	4.73	0.25	2.19
AVDORPN	7 84891 71273 9	1	23.00	—	—	1.96	5.25	0.23	2.36
AVDSMN	7 84891 71304 0	1	7.20	—	—	4.33	0.42	0.17	0.30
AVDWRPN	7 84891 71274 6	1	15.80	—	—	1.85	4.75	0.25	2.20
AWEPD36SS	0 26715 20414 4	1	16.00	—	—	3.29	1.77	0.42	2.43
AWEPD48SS	0 26715 20415 1	1	19.00	—	—	4.31	1.77	0.40	3.02
AWEPD60SS	0 26715 24006 7	1	22.60	—	—	1.78	5.36	0.38	3.57
B12LCDARNW	0 26715 24298 6	1	269.00	—	—	3.15	3.67	2.50	28.84
B12LCDASNW	0 26715 24296 2	1	279.00	—	—	3.54	4.38	2.31	35.83
B12LCDPRNC	0 26715 24308 2	1	268.00	—	—	3.53	4.38	2.29	35.34
B12LCDPRNW	0								

Model	UPC Code	Std. Carton		Master Carton		Length	Width	Height	Cube
		Pk.	Wt.	Pk.	Wt.				
BD6	0 26715 05776 4	1	3.20	—	—	1.52	0.77	0.79	0.92
BK105	7 84891 03001 7	—	—	24	27.00	1.77	1.13	0.84	1.67
BK110NBWH	7 84891 03003 1	—	—	24	48.00	1.08	1.07	1.79	2.07
BK115LWH	7 84891 03005 5	—	—	24	48.00	1.12	1.06	1.76	2.08
BK120NBWH	7 84891 03004 8	—	—	24	48.00	1.08	1.07	1.79	2.07
BK125LWH	7 84891 03006 2	—	—	24	48.00	1.07	1.07	1.75	1.99
BK131LPB	7 84891 03009 3	—	—	24	48.00	1.77	1.08	1.12	2.12
BK131LRBZ	7 84891 03012 3	—	—	6	12.37	1.04	0.61	0.89	0.57
BK131LSN	7 84891 03011 6	—	—	6	12.37	1.05	0.63	0.92	0.60
BK131LWH	7 84891 03010 9	—	—	6	12.75	1.04	0.61	0.91	0.58
BK140LWH	7 84891 03013 0	—	—	24	45.00	1.56	0.88	1.33	1.82
BK140SLPB	7 84891 03015 4	—	—	24	45.60	1.56	0.88	1.32	1.80
BK142LWH	7 84891 03014 7	—	—	24	46.10	1.57	0.88	1.33	1.83
BK144LCL	7 84891 03002 4	—	—	24	48.00	1.09	1.07	1.83	2.13
BK147LWH	7 84891 03016 1	—	—	24	64.70	1.93	1.21	1.19	2.78
BP1	0 26715 02401 8	—	—	15	4.69	1.24	0.53	1.03	0.68
BP10	0 26715 03253 2	—	—	8	1.50	0.94	0.41	0.85	0.33
BP11	0 26715 03254 9	—	—	8	1.50	1.07	0.40	0.83	0.35
BP17	0 26715 04013 1	—	—	4	8.25	1.14	0.76	1.09	0.95
BP18	0 26715 04014 8	—	—	4	9.00	1.13	0.77	1.09	0.95
BP19	0 26715 04059 9	—	—	4	7.50	1.13	0.78	1.08	0.95
BP2	0 26715 02402 5	—	—	12	4.50	1.51	0.56	1.02	0.86
BP20	0 26715 04060 5	—	—	6	2.63	0.95	0.56	0.93	0.49
BP24	0 26715 04485 6	—	—	15	6.56	0.96	0.56	0.93	0.49
BP25	0 26715 04486 3	—	—	6	2.25	0.81	0.73	0.54	0.32
BP27	0 26715 04488 7	—	—	6	8.25	1.10	0.58	1.01	0.65
BP28	0 26715 04489 4	—	—	6	11.63	1.09	0.59	1.01	0.65
BP29	0 26715 04988 2	—	—	6	1.13	1.03	0.82	0.22	0.18
BP33	0 26715 05436 7	—	—	6	2.63	0.94	0.56	0.93	0.49
BP34	0 26715 05438 1	—	—	6	2.63	0.94	0.56	0.93	0.49
BP35	0 26715 05440 4	—	—	12	7.50	1.03	0.84	1.02	0.88
BP36	0 26715 05442 8	—	—	5	1.88	0.82	0.73	0.55	0.33
BP38	0 26715 05446 6	—	—	10	5.00	0.94	0.55	0.92	0.47
BP4	0 26715 03135 1	—	—	12	2.25	0.94	0.93	0.71	0.62
BP43	0 26715 04990 5	—	—	12	2.25	1.13	0.76	1.08	0.92
BP436	0 26715 23500 1	—	—	6	1.30	1.23	0.92	0.50	0.57
BP46	0 26715 07167 8	—	—	12	3.75	0.94	0.55	0.93	0.48
BP5	0 26715 03136 8	—	—	4	1.00	1.03	0.23	0.81	0.19
BP50	0 26715 07997 1	—	—	6	9.00	1.08	0.58	1.02	0.64
BP51	0 26715 07998 8	—	—	6	11.63	1.08	0.60	1.03	0.67
BP52	0 26715 07999 5	—	—	4	8.50	1.13	0.76	1.10	0.95
BP55	0 26715 08259 9	—	—	8	1.50	1.06	0.39	0.82	0.34
BP56	0 26715 08260 5	—	—	8	1.50	0.94	0.39	0.85	0.31
BP57	0 26715 10749 0	—	—	8	3.00	1.24	0.55	1.05	0.72
BP58	0 26715 10750 6	—	—	8	1.50	0.96	0.56	0.92	0.49
BP7	0 26715 03138 2	—	—	8	2.00	1.10	0.41	0.98	0.44
BP87	0 26715 04989 9	—	—	3	1.31	0.82	0.73	0.32	0.19
BP87Q	0 26715 20177 8	—	—	3	0.94	0.81	0.73	0.33	0.20
BP90	0 26715 16744 9	—	—	4	1.50	0.85	0.84	0.20	0.14
BP91	0 26715 19975 4	—	—	4	3.25	1.08	0.58	1.01	0.64
BPAPFA	0 26715 17857 5	—	—	3	1.88	1.04	1.04	0.23	0.25
BPP2FA30	0 26715 17728 8	1	1.50	—	—	1.46	1.19	0.10	0.18
BPP2FA36	0 26715 17730 1	1	1.80	—	—	1.44	1.24	0.10	0.18
BPP2FA42	0 26715 19280 9	1	1.90	—	—	1.25	1.46	0.15	0.27
BPP3FA30	0 26715 19281 6	1	1.65	—	—	1.44	1.21	0.10	0.18
BPP3FA36	0 26715 19282 3	1	1.90	—	—	1.43	1.27	0.11	0.20
BPP3FA42	0 26715 19283 0	1	2.10	—	—	1.46	1.22	0.13	0.24
BPPF30	0 26715 17725 7	—	—	6	3.00	1.40	1.04	0.43	0.62
BPPF36	0 26715 17726 4	—	—	3	2.04	1.42	1.30	0.23	0.43
BPPF42	0 26715 19420 9	1	1.00	—	—	1.46	1.20	0.11	0.19
BPPFA30	0 26715 17727 1	—	—	3	3.38	1.44	0.26	1.08	0.40
BPPFA36	0 26715 17729 5	—	—	3	3.94	1.44	0.26	1.28	0.48
BPPFA42	0 26715 19421 6	1	1.80	—	—	1.47	1.20	0.14	0.25
BPQDE30	0 26715 18227 5	—	—	3	3.75	1.26	1.25	0.34	0.54
BPQTAFA	0 26715 13384 0	—	—	4	1.25	1.11	1.00	0.22	0.24
BPQTAFF	0 26715 13383 3	—	—	4	1.50	1.12	1.00	0.22	0.24
BPRPFA	0 26715 17733 2	—	—	3	1.69	1.06	1.04	0.23	0.26
BPS1FA30	0 26715 13816 6	—	—	3	2.06	1.27	1.06	0.28	0.37
BPS1FA36	0 26715 13817 3	—	—	3	2.25	1.53	0.29	1.06	0.47
BPS2FA30	0 26715 13818 0	—	—	6	4.13	1.28	0.45	1.08	0.62
BPS2FA36	0 26715 13865 4	—	—	6	4.40	1.53	0.44	1.08	0.73

Model	UPC Code	Std. Carton		Master Carton		Length	Width	Height	Cube
		Pk.	Wt.	Pk.	Wt.				
BPS3FA30	0 26715 13867 8	—	—	6	6.38	1.28	0.45	1.08	0.62
BPS3FA36	0 26715 13868 5	—	—	6	7.88	1.53	0.45	1.07	0.73
BPSF30	0 26715 13813 5	—	—	4	2.00	1.28	1.05	0.28	0.37
BPSF36	0 26715 13814 2	—	—	4	2.25	1.53	1.05	0.28	0.44
BPSF42	0 26715 13815 9	—	—	8	4.50	1.81	0.54	1.07	1.04
C350BN	0 26715 17883 4	1	1.85	—	—	0.77	0.29	0.63	0.14
C350GN	0 26715 17885 8	—	—	4	1.75	0.83	0.82	0.25	0.17
C370BN	0 26715 17884 1	1	2.35	—	—	0.77	0.29	0.63	0.14
C905	0 26715 02482 7	—	—	6	5.63	0.77	0.28	0.42	0.09
C907	0 26715 07128 9	—	—	6	12.00	0.77	0.34	0.46	0.12
C909	0 26715 07129 6	—	—	6	7.20	0.76	0.29	0.42	0.09
C915	7 84891 07130 0	—	—	6	6.00	0.72	0.38	0.50	0.13
CA130	7 84891 98190 6	1	1.20	12	14.40	1.98	0.27	0.27	0.14
CF328	7 84891 77410 2	1	0.10	20	2.00	0.08	0.19	0.36	0.01
CF329	7 84891 77411 9	1	0.20	20	4.00	0.39	0.34	0.10	0.01
CF361	7 84891 77412 6	1	0.20	20	4.00	0.46	0.23	0.15	0.02
CF361F	7 84891 77426 3	1	0.30	20	6.00	0.44	0.21	0.12	0.01
CF362	7 84891 77413 3	1	0.10	20	2.00	0.25	0.19	0.25	0.01
CF363	7 84891 77414 0	1	0.16	10	1.60	0.31	0.19	0.21	0.01
CF364	7 84891 77415 7	1	0.16	—	—	0.28	0.19	0.24	0.01
CF365	7 84891 77416 4	1	0.20	10	2.00	0.28	0.19	0.25	0.01
CF366	7 84891 77417 1	1	0.10	10	1.00	0.20	0.20	0.08	0.00
CF367	7 84891 77418 8	—	—	6	6.90	3.07	0.45	0.68	0.94
CF368	7 84891 77419 5	1	0.10	20	2.00	0.39	0.25	0.20	0.02
CF369	7 84891 77429 4	1	0.10	20	2.00	0.18	0.21	0.27	0.01
CF372	0 26715 23014 3	1	0.15	25	3.75	0.21	0.25	0.17	0.01
CF377	7 84891 77431 7	1	0.22	20	4.40	0.36	0.36	0.19	0.02
CF380	7 84891 77258 0	1	0.03	20	0.60	0.30	0.19	0.06	0.00
CF382	7 84891 77433 1	1	0.15	20	3.00	0.29	0.29	0.19	0.02
CF382S	7 84891 77434 8	1	0.11	10	1.10	0.24	0.24	0.19	0.01
CF382XS	7 84891 77436 2	1	0.10	10	1.00	0.23	0.20	0.19	0.01
CF383	7 84891 77422 5	1	0.22	20	4.40	0.39	0.37	0.19	0.03
CF384	7 84891 77438 6	1	0.23	10	2.30	0.46	0.32	0.19	0.03
CF385	7 84891 77440 9	1	0.09	20	1.80	0.24	0.19	0.23	0.01
CF386	7 84891 77442 3	1	0.08	10	0.80	0.22	0.19	0.21	0.01
CF387	7 84891 77444 7	1	0.19	10	1.90	0.38	0.35	0.19	0.02
CF388	7 84891 77446 1	1	0.05	—	—	0.18	0.18	0.13	0.00
CF389	7 84891 77448 5	1	0.01	10	0.10	0.18	0.18	0.08	0.00
CF3918	7 84891 77449 2	1	0.55	6	3.30	0.85	0.67	0.10	0.06
CFC56BR	0 26715 19726 2	1	18.50	—	—	2.29	0.75	0.89	1.53
CFC56WH	0 26715 19725 5	1	18.40	—	—	2.29	0.74	0.90	1.53
CFH52BS	0 26715 19622 7	1	14.80	—	—	1.63	1.00	0.62	1.01
CFH52RB	0 26715 19623 4	1	15.50	—	—	1.65	1.00	0.63	1.03
CFH52WH	0 26715 19620 3	1	15.20	—	—	1.64	0.61	1.00	1.00
CFOS2BO	0 26715 19625 8	1	17.50	—	—	1.73	0.93	0.97	1.54
CFOS2WB	0 26715 19626 5	1	17.40	—	—	1.73	0.93	0.98	1.57
CFOS2WH	0 26715 19624 1	1	17.70	—	—	1.72	0.93	0.97	1.53
CFSS2BS	0 26715 19618 0	1	17.50	—	—	1.76	0.83	0.89	1.29
CFSS2RB	0 26715 19619 7	1	17.50	—	—	1.76	0.82	0.86	1.23
CFSS2WH	0 26715 19616 6	1	17.70	—	—	1.77	0.82	0.87	1.25
CFSABR	0 26715 19942 6	1	2.00	20	40.00	0.49	0.52	0.33	0.08

Model	UPC Code	Std. Carton		Master Carton		Length	Width	Height	Cube
		Pk.	Wt.	Pk.	Wt.				
CI399ALM	0 26715 25123 0	1	0.25	32	8.00	0.44	0.30	0.16	0.02
CI399EB	0 26715 25122 3	1	0.05	200	10.00	0.18	0.10	0.07	0.00
CI399RK	0 26715 25121 6	1	0.25	25	6.25	0.57	0.40	0.13	0.03
CI399W	0 26715 25120 9	1	0.25	32	8.00	0.44	0.30	0.16	0.02
CK110	7 84891 98324 5	1	2.20	6	13.20	1.66	0.73	0.18	0.21
CK135	7 84891 98352 8	1	1.13	25	28.25	2.13	0.38	0.13	0.10
CS100	0 26715 23613 8	1	8.45	—	—	2.00	1.32	0.83	2.17
CS200	0 26715 23614 5	1	3.95	—	—	2.20	0.86	0.32	0.61
CS300	0 26715 23615 2	1	17.00	—	—	1.54	1.21	2.67	4.97
CS400	0 26715 23616 9	1	19.10	—	—	1.54	1.21	2.67	4.97
CS500	0 26715 23617 6	1	25.65	—	—	1.54	1.21	2.67	4.97
CS600	0 26715 23618 3	1	25.20	—	—	1.54	1.21	2.67	4.97
CT105	0 26715 23634 3	1	0.12	50	6.00	0.47	0.25	0.21	0.02
CT106G	7 84891 77031 9	1	0.19	50	9.50	0.69	0.38	0.18	0.05
CT109	0 26715 23632 9	1	0.15	50	7.50	0.47	0.25	0.19	0.02
CT110	0 26715 23633 6	1	0.17	50	8.50	1.14	0.47	0.13	0.07
CT132	7 84891 77033 3	1	0.95	25	23.75	1.52	0.50	0.11	0.08
CT140G	7 84891 98353 5	1	1.45	12	17.40	0.94	0.79	0.26	0.19
CT143B	7 84891 77034 0	1	0.40	30	12.00	0.83	0.22	0.17	0.03
CT150B	7 84891 98354 2	1	0.94	12	11.28	1.08	0.77	0.25	0.21
CT156B	7 84891 77971 8	1	1.10	12	13.20	1.22	0.30	0.54	0.20
CT157B	7 84891 77972 5	1	0.90	12	10.80	1.22	0.30	0.58	0.21
CT158	0 26715 23635 0	1	0.64	21	13.44	1.07	0.46	0.29	0.14
CT170	0 26715 19316 5	1	2.10	20	42.00	2.33	0.21	0.33	0.16
CT175	0 26715 19317 2	1	1.80	20	36.00	2.33	0.21	0.33	0.16
CT350B	7 84891 77976 3	1	2.00	12	24.00	1.04	0.33	0.92	0.32
CT700	0 26715 19315 8	1	7.00	6	42.00	0.35	1.17	1.42	0.58
CVG4	7 84891 99490 6	1	0.29	6	1.74	0.52	0.52	0.23	0.06
CVG6	7 84891 27070 3	1	0.50	6	3.00	0.63	0.63	0.25	0.10
CVL4	7 84891 99491 3	1	0.60	6	3.60	0.83	0.42	0.33	0.12
CVL5	7 84891 99493 7	1	0.80	6	4.80	0.83	0.42	0.42	0.14
CVL6	7 84891 99495 1	1	0.80	6	4.80	0.83	0.50	0.50	0.21
CVLD4	7 84891 27095 6	1	0.60	6	3.60	0.33	0.33	0.34	0.04
CVLD6	7 84891 27101 4	1	0.80	6	4.80	0.45	0.52	0.24	0.06
CWT45	0 26715 21036 7	1	0.10	—	—	0.42	0.31	0.21	0.03
D100	0 26715 02550 3	1	0.80	—	—	1.11	0.78	0.07	0.06
D101	0 26715 02424 7	1	0.90	—	—	1.17	0.81	0.06	0.06
DC4	0 26715 13506 6	—	—	6	1.65	0.95	0.45	0.81	0.35
DH100W	0 55321 80021 1	1	0.60	—	—	0.45	0.26	0.33	0.04
DR12OBQ	0 26715 19667 8	1	0.50	—	—	1.00	0.08	0.07	0.00
DR12OWB	0 26715 19671 5	1	0.60	—	—	1.00	0.08	0.07	0.01
DR12OWH	0 26715 19663 0	1	0.50	—	—	1.00	0.07	0.07	0.00
DR12RB	0 26715 19655 5	1	0.50	—	—	1.00	0.08	0.08	0.01
DR12WH	0 26715 19645 6	1	0.50	—	—	1.00	0.08	0.08	0.01
DR18OBQ	0 26715 19668 5	1	1.00	—	—	1.50	0.08	0.07	0.01
DR18OWB	0 26715 19672 2	1	0.90	—	—	1.50	0.08	0.07	0.01
DR18RB	0 26715 19656 2	1	0.90	—	—	1.50	0.08	0.08	0.01
DR18WH	0 26715 19646 3	1	1.00	—	—	1.50	0.08	0.08	0.01
DR1BA	7 84891 99384 8	1	0.80	6	4.80	0.52	0.15	0.15	0.01
DR1SA	7 84891 99385 5	1	0.80	6	4.80	0.52	0.15	0.15	0.01
DR24BR	0 26715 19660 9	1	1.40	—	—	2.00	0.08	0.08	0.01
DR24OBQ	0 26715 19669 2	1	1.00	—	—	2.02	0.08	0.08	0.01
DR24OWB	0 26715 19673 9	1	1.20	—	—	2.00	0.08	0.07	0.01
DR24RB	0 26715 19657 9	1	1.30	—	—	2.00	0.08	0.08	0.01
DR24WH	0 26715 19647 0	1	1.20	—	—	2.00	0.08	0.08	0.01
DR2SA	7 84891 12234 7	1	1.10	—	—	0.51	0.18	0.42	0.04
DR36BR	0 26715 19661 6	1	1.90	—	—	3.00	0.08	0.08	0.02
DR36BS	0 26715 19653 1	1	2.00	—	—	3.00	0.08	0.08	0.02
DR36OBQ	0 26715 19670 8	1	2.00	—	—	3.00	0.08	0.07	0.01
DR36OWB	0 26715 19674 6	1	1.90	—	—	3.00	0.08	0.08	0.02
DR36RB	0 26715 19658 6	1	1.90	—	—	3.00	0.08	0.08	0.02
DR36WH	0 26715 19648 7	1	2.00	—	—	3.03	0.08	0.08	0.02
DR48BR	0 26715 19662 3	1	2.70	—	—	4.02	0.08	0.08	0.03
DR48BS	0 26715 19654 8	1	2.60	—	—	4.00	0.08	0.08	0.02
DR48RB	0 26715 19659 3	1	2.60	—	—	4.00	0.08	0.08	0.02
DR48WH	0 26715 19649 4	1	2.70	—	—	4.02	0.08	0.08	0.03
DT4C	0 55321 16070 4	—	—	4	8.00	0.90	0.86	0.88	0.68
DT4W	0 55321 16067 4	1	6.15	—	—	2.25	0.71	0.71	1.13
DT6C	0 55321 16071 1	1	2.40	—	—	0.88	0.65	0.61	0.35
DT6W	0 55321 16068 1	1	8.10	—	—	2.46	0.84	0.81	1.67
E5490SS	0 26715 17438 6	1	87.00	—	—	3.38	2.75	1.88	17.40
E6030SS	0 26715 18624 2	1	70.00	—	—	3.51	2.00	2.79	19.59
E6036SS	0 26715 18625 9	1	74.00	—	—	3.51	2.00	2.79	19.59
E6042TSS	0 26715 18626 6	1	94.00	—	—	4.51	2.00	2.79	25.17
E6048TSS	0 26715 18627 3	1	96.00	—	—	4.53	2.00	2.79	25.26
E60E30SS	0 26715 18628 0	1	96.00	—	—	2.00	3.52	2.79	19.66
E60E36SS	0 26715 18629 7	1	67.00	—	—	3.51	2.00	2.79	19.59
E60E42SS	0 26715 18630 3	1	77.50	—	—	4.53	2.00	2.79	25.26
E60E48SS	0 26715 18631 0	1	82.00	—	—	4.53	2.00	2.79	25.26
E6430SS	0 26715 18632 7	1	43.60	—	—	3.32	1.13	2.23	8.33
E6436SS	0 26715 18633 4	1	46.90	—	—	3.30	1.13	2.18	8.17
E6442SS	0 26715 18634 1	1	53.40	—	—	4.32	1.15	2.25	11.17
E6448SS	0 26715 18635 8	1	55.50	—	—	4.33	1.15	2.23	11.13
E6448TSS	0 26715 18636 5	1	65.40	—	—	4.29	1.14	2.25	11.02
E64E30SS	0 26715 18637 2	1	35.60	—	—	3.31	1.13	2.25	8.37
E64E36SS	0 26715 18638 9	1	38.80	—	—	3.31	1.15	2.25	8.56
E64E42SS	0 26715 18639 6	1	44.90	—	—	4.29	1.15	2.25	11.10
E64E48SS	0 26715 18640 2	1	48.30	—	—	1.15	4.32	2.25	11.17
E66130BL	0 26715 16759 3	1	34.30	—	—	3.03	0.67	2.07	4.17
E66130SS	0 26715 16754 8	1	32.10	—	—	3.02	0.67	2.07	4.16
E66130WH	0 26715 16757 9	1	34.00	—	—	3.03	0.65	2.06	4.05
E66136BL	0 26715 16760 9	1	37.90	—	—	3.51	0.65	2.06	4.69
E66136SS	0 26715 16755 5	1	36.60	—	—	3.52	0.68	2.07	4.97
E66136WH	0 26715 16758 6	1	37.40	—	—	3.53	0.65	2.05	4.70
E66142SS	0 26715 16756 2	1	39.00	—	—	4.02	0.64	2.06	5.30
EH6	0 26715 05779 5	1	2.50	—	—	1.58	0.81	0.80	1.02
EI5936SS	0 26715 19491 9	1	88.00	—	—	3.27	2.44	1.80	14.36
EP300108	0 26715 06289 8	—	—	4	6.50	2.75	2.28	0.07	0.42
EP300223	0 26715 14094 7	—	—	4	6.00	2.75	2.29	0.07	0.42
EPD6136SS	0 26715 20406 9	1	91.00	—	—	3.50	2.00	2.79	19.54
EPD6148SS	0 26715 20407 6	1	110.00	—	—	4.52	2.00	2.79	25.24
EPD6160SS	0 26715 24005 0	1	145.00	—	—	2.00	6.50	2.83	36.83
ERV100S	0 26715 24255 9	1	41.00	—	—	2.36	1.04	2.08	5.12
ERV100SP	0 26715 24256 6	1	42.50	—	—	2.36	1.04	2.08	5.12
ERV110S	0 26715 24253 5	1	48.00	—	—	2.46	1.25	1.93	5.92
ERV110T	0 26715 24254 2	1	49.00	—	—	2.15	1.46	1.92	6.00
ERV120S	0 26715 24261 0	1	49.00	—	—	2.46	1.25	1.93	5.92
ERV120T	0 26715 24260 3	1	49.00	—	—	2.15	1.46	1.92	6.00
ERV140TE	0 26715 22803 4	1	57.00	—	—	2.23	1.48	2.27	7.49
ERV180S	0 26715 24265 8	1	67.00	—	—	3.38	1.74	1.67	9.80
ERV200TE	0 26715 24267 2	1	111.00	—	—	2.92	1.96	2.96	16.90
ERV250TE	0 26715 24269 6	1	97.00	—	—	2.90	1.93	3.03	16.86
ERV70S	0 26715 22801 0	1	37.00	—	—	1.94	1.52	1.60	4.73
ERV70T	0 26715 22800 3	1	36.00	—	—	1.79	1.52	1.54	4.20
ERVH100S	0 26715 24251 1	1	51.00	—	—	3.50	1.26	1.75	7.72
ERVS100S	0 26715 24257 3	1	40.85	—	—	2.34	1.03	2.10	5.05
EW5630SS	0 26715 19493 3	1	57.30	—	—	3.20	1.76	2.05	11.53
EW5636SS	0 26715 19492 6	1	60.00	—	—	3.19	1.76	2.07	11.60
EW5830SS	0 26715 19495 7	1	36.60	—	—	2.92	1.35	2.07	8.14
EW5836SS	0 26715 19494 0	1	40.00	—	—	3.40	1.37	2.10	9.76
EZ80N	0 26715 23143 0	1	9.60	—	—	1.53	0.54	1.15	0.95
F402401	0 26715 14293 4	1	11.60	—	—	2.23	0.65	1.63	2.36
F402402	0 26715 14294 1	1	11.7						

Model	UPC Code	Std. Carton		Master Carton		Length	Width	Height	Cube
		Pk.	Wt.	Pk.	Wt.				
F404201	0 26715 14307 8	1	15.30	—	—	3.75	0.63	1.63	3.88
F404202	0 26715 14308 5	1	15.40	—	—	3.74	0.65	1.63	3.95
F404204	0 26715 14309 2	1	16.00	—	—	3.75	0.63	1.63	3.88
F404208	0 26715 14310 8	1	15.40	—	—	3.73	0.67	1.63	4.04
F404211	0 26715 14466 2	1	15.30	—	—	3.75	0.63	1.63	3.88
F404222	0 26715 14467 9	1	15.30	—	—	3.73	0.66	1.62	3.96
F404223	0 26715 17320 4	1	15.40	—	—	3.75	0.63	1.63	3.88
FILTERE56	0 26715 19513 8	1	0.90	—	—	0.59	0.16	0.78	0.07
FILTERE56FL	0 26715 22857 7	1	0.95	—	—	1.88	0.83	0.10	0.16
FILTEREB40	0 26715 15235 3	1	1.75	5	8.75	0.77	0.30	0.73	0.17
FILTERESQUARE	0 26715 15236 0	1	1.60	—	—	0.82	0.17	0.82	0.11
FX54SS	0 26715 17443 0	1	29.90	—	—	3.58	1.44	1.38	7.10
FXN54SS	0 26715 17442 3	1	32.15	—	—	3.58	1.44	1.42	7.30
FXNE56SS	0 26715 19515 2	1	18.60	—	—	3.89	1.09	1.08	4.60
FXNE58SS	0 26715 19516 9	1	12.90	—	—	3.00	0.85	1.01	2.57
FXNE59SS	0 26715 19514 5	1	38.10	—	—	3.09	1.09	1.08	3.66
FY6	7 84891 20698 6	1	1.90	—	—	1.16	0.56	1.11	0.72
FY86	7 84891 20697 9	1	2.70	—	—	1.08	1.03	1.23	1.35
G102	0 26715 02425 4	1	5.60	—	—	3.59	1.36	0.08	0.41
G103	0 26715 02426 1	1	8.00	—	—	4.29	1.54	0.08	0.55
G686N	0 26715 17886 5	—	—	4	2.00	0.84	0.82	0.28	0.19
GU10	0 26715 16883 5	—	—	10	1.25	0.68	0.62	0.20	0.08
GU1035	0 26715 19749 1	—	—	10	1.25	0.88	0.37	0.26	0.08
HCK44	0 26715 14603 1	—	—	10	5.00	1.98	0.65	0.83	1.07
HCK44D	0 26715 15148 6	—	—	50	17.50	1.24	0.78	0.81	0.79
HD50RDF	0 26715 14609 3	—	—	4	16.75	1.83	0.99	1.06	1.92
HD80L	0 26715 05285 1	1	6.70	—	—	0.78	0.98	1.06	0.80
HLB11	0 26715 16924 5	1	68.00	—	—	2.18	1.86	2.65	10.71
HLB3	0 26715 16921 4	1	24.90	—	—	1.34	1.33	2.08	3.73
HLB6	0 26715 16922 1	1	44.80	—	—	2.11	1.38	2.43	7.03
HLB9	0 26715 16923 8	1	67.10	—	—	2.17	1.86	2.64	10.64
HRV120S	0 26715 24259 7	1	43.00	—	—	2.46	1.25	1.93	5.92
HRV120T	0 26715 24258 0	1	43.00	—	—	2.15	1.46	1.92	6.00
HRV150S	0 26715 24262 7	1	63.00	—	—	3.04	1.73	1.70	8.94
HRV150TE	0 26715 22802 7	1	56.00	—	—	2.21	1.48	2.27	7.42
HRV160T	0 26715 24263 4	1	53.30	—	—	2.27	1.48	2.29	7.71
HRV160TE	0 26715 24264 1	1	54.40	—	—	2.27	1.48	2.29	7.71
HRV190S	0 26715 24266 5	1	64.00	—	—	3.08	1.75	1.67	8.99
HRV200TE	0 26715 24268 9	1	130.00	—	—	2.92	1.96	2.96	16.90
HRV250TE	0 26715 24270 2	1	95.00	—	—	2.88	1.94	3.01	16.76
HRV80S	0 26715 24248 1	1	36.20	—	—	1.94	1.53	1.63	4.80
HRV80T	0 26715 24247 4	1	36.30	—	—	1.82	1.52	1.58	4.37
HRV90S	0 26715 24250 4	1	36.20	—	—	1.94	1.53	1.63	4.80
HRV90T	0 26715 24249 8	1	36.30	—	—	1.82	1.52	1.58	4.37
HRVH100S	0 26715 24252 8	1	50.85	—	—	3.48	1.27	1.75	7.72
HRVH100SE	0 26715 22804 1	1	52.00	—	—	3.50	1.27	1.69	7.51
HVDCT	0 26715 23597 1	1	0.85	—	—	0.79	0.49	0.21	0.08
HVLFABL	0 26715 23591 9	1	5.85	—	—	2.04	0.65	1.20	1.58
HVLFABR	0 26715 23592 6	1	5.85	—	—	2.04	0.65	1.22	1.61
HVPFBL	0 26715 23598 8	1	0.15	—	—	0.23	0.23	0.21	0.01
HVPFBR	0 26715 23599 5	1	0.15	—	—	0.23	0.23	0.21	0.01
HVRC1	0 26715 23595 7	1	0.35	—	—	0.40	0.36	0.37	0.05
HVRC4	0 26715 23596 4	1	0.60	—	—	0.40	0.36	0.37	0.05
HVRFABL	0 26715 23593 3	1	2.55	—	—	1.25	0.37	0.92	0.42
HVRFABR	0 26715 23594 0	1	2.55	—	—	1.25	0.37	0.92	0.42
ICAB	0 26715 23862 0	1	0.73	12	8.76	1.23	0.86	0.12	0.12
ICAK	0 26715 23861 3	1	0.00	6	0.00	0.00	0.00	0.00	0.00
ICDFUW	0 26715 23859 0	1	15.10	—	—	1.20	3.88	0.08	0.39
ICDM	0 26715 23858 3	1	16.10	—	—	1.20	3.88	0.08	0.39
ICDRUW	0 26715 23860 6	1	10.95	—	—	1.20	3.88	0.08	0.39
ICUDWHX	0 26715 23863 7	1	60.00	—	—	1.57	4.63	0.88	6.37
ICUNUWX	0 26715 23864 4	1	46.00	—	—	1.57	4.61	0.80	5.78
ILF120	7 84891 20600 9	1	5.00	—	—	0.88	0.86	0.89	0.68
ILF130	7 84891 20610 8	1	4.80	—	—	0.88	0.86	0.88	0.66
ILF250	7 84891 20615 3	1	7.50	—	—	1.03	1.01	0.88	0.90
ILF360	7 84891 20625 2	1	9.00	—	—	1.15	1.14	1.23	1.61
ILF530	7 84891 20640 5	1	11.90	—	—	1.16	1.14	1.20	1.59
ILFK120	7 84891 20650 4	1	6.10	—	—	0.86	0.84	1.05	0.76
ILFK130	7 84891 20655 9	1	6.70	—	—	1.16	1.15	1.22	1.62
ILFK250	7 84891 20660 3	1	9.30	—	—	1.13	1.15	1.23	1.60
ILFK2502	7 84891 20665 8	1	12.10	—	—	1.67	1.16	1.17	2.25

Model	UPC Code	Std. Carton		Master Carton		Length	Width	Height	Cube
		Pk.	Wt.	Pk.	Wt.				
ILRF	7 84891 20690 0	1	6.40	—	—	0.88	0.86	1.03	0.78
L100	0 26715 12449 7	1	18.90	—	—	1.36	1.25	1.33	2.26
L100L	0 26715 12459 6	1	19.10	—	—	1.36	1.24	1.33	2.23
L100MG	0 26715 12514 2	1	19.30	—	—	1.35	1.23	1.33	2.21
L150	0 26715 12450 3	1	19.30	—	—	1.37	1.23	1.33	2.23
L1500	0 26715 12458 9	1	59.60	—	—	2.16	1.84	1.90	7.55
L1500L	0 26715 12468 8	1	58.80	—	—	2.16	1.83	1.90	7.52
L150L	0 26715 12460 2	1	19.70	—	—	1.36	1.24	1.33	2.25
L150MG	0 26715 12515 9	1	19.70	—	—	1.35	1.24	1.33	2.23
L200	0 26715 12451 0	1	19.10	—	—	1.36	1.24	1.33	2.25
L2000L	0 26715 12469 5	1	87.50	—	—	3.25	1.42	1.54	7.10
L200L	0 26715 12461 9	1	19.50	—	—	1.36	1.25	1.32	2.24
L200MG	0 26715 12516 6	1	19.50	—	—	1.35	1.23	1.33	2.22
L250	0 26715 12452 7	1	21.00	—	—	1.38	1.23	1.33	2.26
L250L	0 26715 12462 6	1	21.40	—	—	1.34	1.24	1.33	2.22
L250MG	0 26715 12517 3	1	21.50	—	—	1.34	1.24	1.33	2.22
L300	0 26715 12453 4	1	21.00	—	—	1.38	1.23	1.33	2.25
L300KMG	0 26715 12519 7	1	22.40	—	—	1.34	1.23	1.34	2.22
L300L	0 26715 12463 3	1	21.40	—	—	1.35	1.24	1.33	2.23
L300MG	0 26715 12518 0	1	20.80	—	—	1.35	1.23	1.33	2.21
L3500EXL	0 26715 12470 1	1	142.00	—	—	3.92	1.60	1.73	10.86
L400	0 26715 12454 1	1	32.50	—	—	2.13	1.38	1.28	3.75
L400K	0 26715 12520 3	1	34.70	—	—	2.14	1.38	1.28	3.78
L400KL	0 26715 12512 8	1	34.80	—	—	2.12	1.38	1.28	3.71
L400L	0 26715 12464 0	1	32.10	—	—	2.13	1.38	1.28	3.73
L500	0 26715 12455 8	1	32.90	—	—	2.12	1.38	1.27	3.71
L500K	0 26715 12521 0	1	35.40	—	—	2.11	1.39	1.28	3.74
L500KL	0 26715 12513 5	1	36.00	—	—	2.12	1.37	1.27	3.66
L500L	0 26715 12465 7	1	33.10	—	—	2.12	1.38	1.25	3.64
L700	0 26715 12456 5	1	32.90	—	—	2.12	1.38	1.27	3.69
L700L	0 26715 12466 4	1	32.90	—	—	2.13	1.39	1.26	3.74
L900	0 26715 12457 2	1	58.70	—	—	2.16	1.83	1.89	7.49
L900L	0 26715 12467 1	1	57.50	—	—	2.16	1.84	1.89	7.52
LA100WH	7 84891 95195 4	—	—	3	4.13	0.64	0.55	0.71	0.25
LA107WH	7 84891 99129 5	1	1.90	3	5.70	0.24	0.63	0.79	0.12
LA11BG	7 84891 95188 6	—	—	6	7.88	1.25	0.76	0.53	0.50
LA11WH	7 84891 95187 9	—	—	6	7.88	1.25	0.73	0.53	0.49
LA126WH	7 84891 98008 4	1	1.40	6	8.40	0.68	0.21	0.53	0.07
LA130WH	7 84891 99134 9	1	1.60	6	9.60	0.21	0.65	0.49	0.07
LA139WH	7 84891 99983 3	1	1.40	6	8.40	0.87	0.33	0.58	0.16
LA140WH	7 84891 99984 0	1	1.40	6	8.40	0.82	0.27	0.60	0.13
LA14WH	7 84891 95189 3	—	—	6	10.50	1.20	0.53	0.71	0.45
LA164WH	7 84891 02648 5	1	3.20	—	—	0.69	0.69	0.17	0.08
LA165SA	7 84891 02649 2	1	3.30	—	—	0.70	0.68	0.35	0.17
LA174WH	7 84891 02650 8	1	3.80	—	—	0.71	0.36	1.08	0.27
LA18WH	7 84891 95190 9	—	—	6	10.50	1.34	0.71	0.73	0.70
LA202WH	7 84891 95196 1	—	—	3	4.69	0.78	0.65	0.82	0.41
LA223WH	0 26715 23566 7	1	0.45	3	1.35	0.35	0.19	0.39	0.03
LA224RWH	0 26715 23570 4	1	0.45	3	1.35	0.28	0.22	0.40	0.02
LA224WH	0 26715 23568 1	1	0.55	3	1.65	0.33	0.22	0.40	0.03
LA225WH	0 26715 23564 3	1	0.35	3	1.05	0.35	0.11		

Model	UPC Code	Std. Carton		Master Carton		Length	Width	Height	Cube
		Pk.	Wt.	Pk.	Wt.				
LK30AWH	0 26715 19631 9	1	6.50	—	—	1.03	1.01	0.92	0.95
LK50DBQ	0 26715 19644 9	1	4.00	—	—	1.02	1.01	0.75	0.77
LK50DWB	0 26715 19643 2	1	3.70	—	—	1.02	1.02	0.75	0.78
LK50DWH	0 26715 19642 5	1	3.90	—	—	1.01	1.02	0.75	0.77
LP80	0 26715 20347 5	1	9.20	—	—	1.39	1.15	0.50	0.80
LP80F	0 26715 23408 0	—	—	4	24.35	2.29	1.27	1.10	3.21
LP80H	0 26715 23410 3	—	—	4	16.60	1.19	1.19	1.53	2.16
LPN80	0 26715 20348 2	1	9.10	—	—	1.39	1.15	0.50	0.80
LPN80F	0 26715 23409 7	—	—	4	24.35	2.29	1.27	1.10	3.21
LT30	0 26715 17297 9	1	6.70	—	—	2.63	0.43	1.46	1.66
LT36	0 26715 17296 6	1	8.20	—	—	3.13	0.43	1.46	1.97
MCB2	0 26715 13906 4	1	1.10	—	—	1.28	0.21	0.15	0.04
MVC309NWHGL	7 84891 99194 3	—	—	6	5.63	0.88	0.63	0.76	0.42
MD10S	0 26715 21104 3	1	5.30	—	—	0.92	0.90	1.29	1.06
MD10T	0 26715 21103 6	1	6.65	—	—	0.92	0.90	1.31	1.08
MD10TU	0 26715 21102 9	1	6.95	—	—	0.92	0.90	1.29	1.06
MD6S	0 26715 20418 2	1	3.20	—	—	0.87	0.57	0.81	0.40
MD6T	0 26715 19203 8	1	4.30	—	—	0.86	0.55	0.81	0.38
MD6TU	0 26715 20378 9	1	4.70	—	—	0.87	0.54	0.81	0.38
MD8S	0 26715 20419 9	1	4.10	—	—	0.85	0.73	0.96	0.60
MD8T	0 26715 19204 5	1	5.30	—	—	0.86	0.73	0.97	0.60
MD8TU	0 26715 20379 6	1	5.60	—	—	0.86	0.73	0.98	0.61
MG1	0 26715 13196 9	1	2.30	—	—	1.19	1.18	0.08	0.12
MHB4	0 26715 23540 7	1	0.80	—	—	1.18	0.24	0.10	0.03
MMDC4	0 26715 23538 4	1	0.75	—	—	0.44	0.43	0.53	0.10
MMG	0 26715 23542 1	1	1.40	—	—	1.10	0.18	1.20	0.23
MP100	0 26715 05724 5	1	15.20	—	—	1.20	1.18	1.06	1.49
MP140	0 26715 05725 2	1	15.60	—	—	1.21	1.20	1.08	1.56
MP200	0 26715 05723 8	1	15.70	—	—	1.20	1.17	1.06	1.48
MP280	0 26715 05726 9	1	31.70	—	—	1.58	1.53	1.40	3.38
MOF4	0 26715 23539 1	1	0.70	—	—	0.78	0.53	0.54	0.22
NA200TA	0 26715 18479 8	1	3.70	6	22.20	0.43	0.59	0.33	0.09
NA3003C	0 26715 18457 6	1	0.20	—	—	0.40	0.34	0.10	0.01
NA3008C	0 26715 18458 3	1	0.20	—	—	0.40	0.33	0.10	0.01
NA300MCWH	0 26715 18484 2	1	0.20	30	6.00	0.17	0.41	0.50	0.03
NA300TA	0 26715 18480 4	1	4.80	6	28.80	0.36	0.65	0.33	0.08
NDB300AB	0 26715 18455 2	1	0.90	30	27.00	0.40	0.23	0.67	0.06
NDB300BB	0 26715 18454 5	1	1.00	30	30.00	0.22	0.40	0.58	0.05
NDB300N	0 26715 18456 9	1	0.90	—	—	0.40	0.22	0.67	0.06
NDB300WH	0 26715 18453 8	1	0.60	30	18.00	0.58	0.23	0.42	0.05
NDK35830BL	0 26715 17592 5	1	7.30	—	—	2.83	0.40	1.20	1.36
NDK35830SS	0 26715 17590 1	1	6.80	—	—	2.83	0.39	1.20	1.33
NDK35830WWW	0 26715 17591 8	1	7.30	—	—	2.83	0.40	1.20	1.36
NDK35836BL	0 26715 17595 6	1	8.30	—	—	3.33	1.21	0.39	1.58
NDK35836SS	0 26715 17593 2	1	8.00	—	—	3.35	0.41	1.21	1.65
NDK35836WWW	0 26715 17594 9	1	9.10	—	—	3.33	1.21	0.40	1.61
NES300DBL	0 26715 18467 5	1	0.30	70	21.00	0.35	0.17	0.58	0.03
NES300DWH	0 26715 18466 8	1	0.30	70	21.00	0.56	0.35	0.16	0.03
NF100CWH	0 26715 18471 2	1	2.10	8	16.80	0.18	1.53	1.33	0.37
NF100MWH	0 26715 18481 1	1	1.10	12	13.20	1.48	0.13	1.00	0.18
NF200MWH	0 26715 18468 2	1	0.08	25	2.00	1.36	0.52	0.01	0.00
NF300DWH	0 26715 18478 1	1	0.30	24	7.20	0.64	0.12	0.46	0.03
NF300PWH	0 26715 18477 4	1	0.90	24	21.60	0.70	0.13	0.94	0.08
NF300RWH	0 26715 18476 7	1	0.90	24	21.60	0.70	0.13	0.94	0.08
NM100WH	0 26715 18472 9	1	4.70	4	18.80	0.87	1.61	0.75	1.05
NM200AL	0 26715 18448 4	1	4.70	4	18.80	0.88	1.62	0.75	1.06
NM200K	0 26715 18444 6	1	12.10	—	—	1.73	0.91	1.55	2.44
NM200WH	0 26715 18446 0	1	4.70	4	18.80	0.87	1.62	0.75	1.05
NPS103WH	0 26715 18474 3	1	1.00	18	18.00	0.51	0.28	0.58	0.08
NPS104WH	0 26715 18501 6	1	1.00	18	18.00	0.52	0.28	0.50	0.07
NPS200WH	0 26715 18451 4	1	1.00	18	18.00	0.51	0.28	0.50	0.07
NR380WH	0 26715 18462 8	1	2.40	5	12.00	0.32	1.00	1.00	0.32
NRKF200P	0 26715 18464 4	1	0.90	24	21.60	0.43	0.27	0.50	0.06
NRKR200R	0 26715 18463 7	1	0.90	15	13.50	0.56	0.53	0.25	0.07
NRKR300D	0 26715 18502 3	1	0.70	5	3.50	0.24	0.35	0.58	0.05
NRKRWH300	0 26715 18460 6	1	14.30	2	28.60	1.48	1.23	0.50	0.91
NRKS200PWH	0 26715 18465 1	1	1.00	6	6.00	0.57	0.74	0.42	0.18
NRKS300R	0 26715 18821 5	1	1.60	5	8.00	0.32	0.99	1.00	0.31
NRS103WH	0 26715 18473 6	1	0.90	18	16.20	0.51	0.26	0.58	0.08
NRS104WH	0 26715 18475 0	1	0.90	18	16.20	0.51	0.28	0.50	0.07
NRS200AL	0 26715 18452 1	1	0.90	18	16.20	0.26	0.51	0.50	0.07

Model	UPC Code	Std. Carton		Master Carton		Length	Width	Height	Cube
		Pk.	Wt.	Pk.	Wt.				
NRS200WH	0 26715 18450 7	1	0.90	18	16.20	0.26	0.51	0.58	0.08
NW4S	0 26715 18694 5	1	2.23	10	22.30	0.63	0.63	0.18	0.07
NWH300	0 26715 18459 0	1	12.25	2	24.50	1.48	1.22	0.43	0.77
P5	0 26715 12434 3	1	17.60	—	—	2.33	1.33	0.50	1.56
P57W	0 26715 03860 2	—	—	4	1.25	0.67	0.50	0.35	0.12
P59V	0 26715 03821 3	—	—	4	2.50	1.09	0.38	0.69	0.28
P59W	0 26715 03865 7	—	—	4	2.50	1.09	0.38	0.69	0.29
P66V	0 26715 03837 4	—	—	4	1.50	0.67	0.35	0.63	0.15
P66W	0 26715 03878 7	—	—	4	1.50	0.67	0.35	0.63	0.15
P685WL	0 26715 08274 2	—	—	4	2.25	0.86	0.51	0.68	0.30
P68W	0 26715 03886 2	—	—	4	1.50	0.67	0.35	0.63	0.15
P8	0 26715 12435 0	1	25.90	—	—	2.33	1.33	0.42	1.30
PAR20	0 26715 13225 6	—	—	6	1.86	0.77	0.64	0.51	0.25
PB10LGL	7 84891 99052 6	—	—	12	0.75	0.34	0.34	0.43	0.05
PB15LBR	0 26715 17990 9	—	—	3	0.38	0.34	0.33	0.41	0.05
PB15LPB	0 26715 17980 0	—	—	3	0.38	0.33	0.36	0.39	0.05
PB15LSN	0 26715 17976 3	—	—	3	0.38	0.33	0.33	0.43	0.05
PB18LWHCL	7 84891 99362 6	—	—	12	0.30	0.34	0.34	0.44	0.05
PB18WHCL	7 84891 05177 7	—	—	12	0.30	0.36	0.33	0.42	0.05
PB19LGL	7 84891 99280 3	—	—	12	1.50	0.35	0.33	0.42	0.05
PB27LBR	0 26715 17991 6	—	—	3	0.56	0.34	0.34	0.42	0.05
PB27LSN	7 84891 05244 6	—	—	6	0.75	0.33	0.35	0.43	0.05
PB29LR	7 84891 05252 1	—	—	6	0.38	0.33	0.34	0.42	0.05
PB29LSN	7 84891 05254 5	—	—	6	0.38	0.43	0.31	0.59	0.08
PB41APB41LA	7 84891 99435 7	—	—	24	1.08	0.73	0.73	0.54	0.29
PB41BGL	7 84891 99434 0	—	—	24	2.06	0.95	0.70	0.82	0.54
PB41LBGL	7 84891 99897 3	—	—	24	2.06	0.94	0.71	0.78	0.52
PB41LBR	7 84891 05350 4	—	—	24	1.50	0.93	0.71	0.78	0.51
PB41LSN	7 84891 05351 1	—	—	24	1.50	0.97	0.77	0.78	0.58
PB4LBL	0 26715 17997 8	—	—	3	0.56	0.33	0.33	0.43	0.05
PB4LBR	0 26715 17989 3	—	—	3	0.56	0.35	0.34	0.43	0.05
PB4LSN	0 26715 17975 6	—	—	3	0.56	0.33	0.37	0.43	0.05
PB53LWH	0 26715 17995 4	—	—	3	0.75	0.34	0.34	0.43	0.05
PB59LPB	0 26715 17986 2	—	—	3	0.38	0.34	0.34	0.43	0.05
PB61LPB	0 26715 17985 5	—	—	3	0.75	0.34	0.34	0.42	0.05
PB64LAB	0 26715 17992 3	—	—	3	0.56	0.34	0.34	0.40	0.05
PB67AB	0 26715 17993 0	—	—	3	0.19	0.34	0.33	0.43	0.05
PB69LBL	0 26715 17998 5	—	—	6	0.38	0.33	0.35	0.43	0.05
PB69LPB	0 26715 17978 7	—	—	6	0.38	0.33	0.36	0.43	0.05
PB69LPC	0 26715 18000 4	—	—	6	0.38	0.34	0.33	0.43	0.05
PB69LSN	0 26715 17977 0	—	—	6	0.38	0.35	0.33	0.43	0.05
PB69LWH	0 26715 17994 7	—	—	6	0.38	0.31	0.34	0.42	0.04
PB78LWHCL	0 26715 21135 7	1	0.06	6	0.38	0.23	0.04	0.36	0.00
PB7LBL	7 84891 06001 4	—	—	12	0.60	0.34	0.34	0.44	0.05
PB7LPB	7 84891 06002 1	—	—	12	0.60	0.34	0.34	0.44	0.05
PB7LSN	7 84891 06003 8	—	—	12	0.60	0.34	0.34	0.44	0.05
PB7LWH	7 84891 06004 5	—	—	12	0.60	0.34	0.34	0.44	0.05
PB7WH	7 84891 06005 2	—	—	12	0.60	0.34	0.34	0.44	0.05
PB82WH	0 26715 23569 8	—	—	6	0.45	0.34	0.34	0.43	0.05
PB85BR	0 26715 23573 5	—	—	6	1.20	0.34	0.34	0.43	0.

Model	UPC Code	Std. Carton		Master Carton		Length	Width	Height	Cube
		Pk.	Wt.	Pk.	Wt.				
QP142SS	0 26715 17696 0	1	33.80	—	—	3.90	0.85	2.02	6.72
QP142WW	0 26715 17697 7	1	35.30	—	—	3.88	0.87	1.98	6.67
QP230BC	0 26715 19277 9	1	30.30	—	—	2.91	0.88	1.98	5.10
QP230BL	0 26715 17698 4	1	30.70	—	—	2.91	0.88	1.97	5.05
QP230SS	0 26715 17699 1	1	29.40	—	—	2.90	0.88	1.97	4.99
QP230WW	0 26715 17700 4	1	30.40	—	—	2.92	0.88	1.98	5.09
QP236BC	0 26715 19278 6	1	32.50	—	—	3.29	0.87	1.98	5.63
QP236BL	0 26715 17704 2	1	33.70	—	—	3.41	0.88	1.98	5.91
QP236SS	0 26715 17705 9	1	32.30	—	—	3.39	0.88	1.97	5.84
QP236WW	0 26715 17706 6	1	33.70	—	—	3.40	0.88	1.98	5.96
QP242BC	0 26715 19279 3	1	37.00	—	—	3.79	0.86	1.96	6.37
QP242BL	0 26715 17707 3	1	36.70	—	—	3.88	0.88	1.98	6.71
QP242SS	0 26715 17708 0	1	35.30	—	—	3.88	0.88	1.98	6.70
QP242WW	0 26715 17709 7	1	36.80	—	—	3.87	0.88	1.97	6.65
QP330BL	0 26715 17710 3	1	33.80	—	—	2.92	0.87	1.97	4.97
QP330SS	0 26715 17711 0	1	32.90	—	—	2.90	0.88	1.98	5.01
QP330WW	0 26715 17712 7	1	33.70	—	—	2.89	0.87	1.96	4.91
QP336BL	0 26715 17716 5	1	37.10	—	—	3.41	0.86	1.97	5.75
QP336SS	0 26715 17717 2	1	35.80	—	—	3.40	0.88	1.96	5.88
QP336WW	0 26715 17718 9	1	37.00	—	—	3.41	0.89	1.97	5.98
QP342BL	0 26715 17719 6	1	38.50	—	—	3.79	0.88	1.96	6.50
QP342SS	0 26715 17720 2	1	37.90	—	—	3.88	0.88	1.96	6.65
QP342WW	0 26715 17721 9	1	39.10	—	—	3.78	0.87	1.97	6.45
QP430SS	0 26715 19900 6	1	32.40	—	—	2.89	0.88	1.96	4.95
QP436SS	0 26715 19901 3	1	35.80	—	—	3.38	0.92	1.95	6.05
QP442SS	0 26715 19902 0	1	38.80	—	—	3.90	0.85	2.02	6.72
QS130AA	0 26715 13556 1	1	23.20	—	—	2.79	0.83	1.98	4.59
QS130BC	0 26715 13555 4	1	22.80	—	—	2.80	0.84	1.98	4.67
QS130BL	0 26715 13557 8	1	23.30	—	—	2.79	0.83	1.98	4.57
QS130SS	0 26715 13558 5	1	21.50	—	—	2.79	0.82	1.98	4.50
QS130WW	0 26715 13554 7	1	22.60	—	—	2.79	0.83	1.98	4.55
QS136AA	0 26715 13561 5	1	25.40	—	—	3.28	0.83	1.98	5.43
QS136BC	0 26715 13560 8	1	24.80	—	—	3.29	0.84	1.98	5.49
QS136BL	0 26715 13562 2	1	24.80	—	—	3.30	0.83	1.98	5.43
QS136SS	0 26715 13563 9	1	23.90	—	—	3.31	0.82	1.99	5.38
QS136WW	0 26715 13559 2	1	25.20	—	—	3.29	0.83	1.98	5.36
QS142AA	0 26715 13566 0	1	27.90	—	—	3.80	0.82	1.98	6.13
QS142BC	0 26715 13565 3	1	27.50	—	—	3.80	0.82	1.97	6.10
QS142BL	0 26715 13567 7	1	27.30	—	—	3.77	0.83	1.98	6.23
QS142SS	0 26715 13568 4	1	25.70	—	—	3.79	0.83	1.98	6.20
QS142WW	0 26715 13564 6	1	27.40	—	—	3.79	0.83	1.98	6.24
QS230AA	0 26715 13571 4	1	30.10	—	—	2.83	0.83	1.98	4.64
QS230BC	0 26715 13570 7	1	29.70	—	—	2.79	0.84	1.97	4.62
QS230BL	0 26715 13573 8	1	31.10	—	—	2.80	0.85	1.98	4.72
QS230SS	0 26715 13572 1	1	29.20	—	—	2.80	0.83	1.97	4.54
QS230WW	0 26715 13569 1	1	29.90	—	—	2.79	0.81	1.97	4.44
QS236AA	0 26715 13576 9	1	33.00	—	—	3.30	0.83	1.98	5.45
QS236BC	0 26715 13575 2	1	32.90	—	—	3.29	0.83	1.98	5.36
QS236BL	0 26715 13577 6	1	32.90	—	—	3.28	0.83	1.98	5.43
QS236SS	0 26715 13578 3	1	31.70	—	—	3.29	0.82	1.98	5.31
QS236WW	0 26715 13574 5	1	32.70	—	—	3.29	0.83	1.98	5.44
QS242AA	0 26715 13581 3	1	36.20	—	—	3.79	0.82	1.97	6.09
QS242BC	0 26715 13580 6	1	36.10	—	—	3.78	0.83	1.98	6.25
QS242BL	0 26715 13582 0	1	36.20	—	—	3.80	0.83	1.97	6.17
QS242SS	0 26715 13583 7	1	34.30	—	—	3.79	0.83	1.98	6.24
QS242WW	0 26715 13579 0	1	36.40	—	—	3.78	0.82	1.98	6.11
QS330AA	0 26715 13586 8	1	31.80	—	—	2.79	0.81	1.96	4.42
QS330BC	0 26715 13585 1	1	30.40	—	—	2.79	0.83	1.98	4.55
QS330BL	0 26715 13587 5	1	30.40	—	—	2.78	0.83	1.97	4.52
QS330SS	0 26715 13588 2	1	29.90	—	—	2.79	0.83	1.98	4.61
QS330WW	0 26715 13584 4	1	31.00	—	—	2.78	0.83	1.97	4.52
QS336AA	0 26715 13591 2	1	34.30	—	—	3.28	0.82	1.98	5.30
QS336BC	0 26715 13590 5	1	34.60	—	—	3.29	0.83	1.97	5.34
QS336BL	0 26715 13592 9	1	34.00	—	—	3.29	0.83	1.98	5.39
QS336SS	0 26715 13593 6	1	32.70	—	—	3.29	0.83	1.98	5.39
QS336WW	0 26715 13589 9	1	33.50	—	—	3.30	0.82	1.97	5.30
QS342AA	0 26715 13596 7	1	37.20	—	—	3.79	0.83	1.98	6.24
QS342BC	0 26715 13595 0	1	37.50	—	—	3.80	0.83	1.98	6.25
QS342BL	0 26715 13597 4	1	37.40	—	—	3.78	0.83	1.98	6.23
QS342SS	0 26715 13598 1	1	35.50	—	—	3.80	0.82	1.96	6.08
QS342WW	0 26715 13594 3	1	37.70	—	—	3.79	0.83	1.98	6.18

Model	UPC Code	Std. Carton		Master Carton		Length	Width	Height	Cube
		Pk.	Wt.	Pk.	Wt.				
OSE130BL	0 26715 19723 1	1	24.10	—	—	2.80	0.83	1.98	4.56
OSE130SS	0 26715 19722 4	1	22.30	—	—	2.82	0.83	1.98	4.59
OSE130WW	0 26715 19724 8	1	24.00	—	—	2.80	0.82	1.96	4.48
QT230AA	0 26715 13372 7	1	17.60	—	—	2.75	0.66	1.63	2.96
QT230BC	0 26715 14218 7	1	17.50	—	—	2.76	0.66	1.63	2.95
QT230BL	0 26715 13373 4	1	17.40	—	—	2.76	0.65	1.62	2.90
QT230SS	0 26715 13374 1	1	17.50	—	—	2.75	0.67	1.63	2.98
QT230WW	0 26715 13371 0	1	17.50	—	—	2.75	0.66	1.63	2.94
QT236AA	0 26715 13376 5	1	18.40	—	—	3.24	0.67	1.63	3.53
QT236BC	0 26715 14232 3	1	18.70	—	—	3.25	0.66	1.63	3.48
QT236BL	0 26715 13377 2	1	17.80	—	—	3.25	0.67	1.63	3.52
QT236SS	0 26715 13378 9	1	18.20	—	—	3.25	0.66	1.63	3.48
QT236WW	0 26715 13375 8	1	18.10	—	—	3.26	0.65	1.59	3.37
QT242AA	0 26715 13380 2	1	20.30	—	—	3.75	0.66	1.63	4.03
QT242BC	0 26715 14233 0	1	20.20	—	—	3.75	0.67	1.63	4.06
QT242BL	0 26715 13381 9	1	20.30	—	—	3.75	0.66	1.63	4.01
QT242SS	0 26715 13382 6	1	21.20	—	—	3.76	0.64	1.63	3.94
QT242WW	0 26715 13379 6	1	20.50	—	—	3.73	0.66	1.63	4.01
QT9093WH	7 84891 32212 9	1	23.50	—	—	1.96	1.61	1.00	3.15
QTHB1	0 26715 17278 8	1	1.50	—	—	1.38	3.88	0.29	0.15
QTNLEDA	0 26715 19949 5	1	13.60	—	—	1.30	1.23	1.31	2.08
QTNLEDB	0 26715 19950 1	1	13.80	—	—	1.32	1.23	1.29	2.08
QTX110HFLT	0 26715 18797 3	1	22.80	—	—	1.76	1.37	1.32	3.16
QTX110HL	0 26715 16389 2	1	22.60	—	—	1.76	1.36	1.33	3.18
QTXE080	0 26715 16375 5	1	11.60	—	—	1.33	0.95	1.29	1.63
QTXE080FLT	0 26715 17177 4	1	13.05	—	—	1.34	1.23	1.29	2.12
QTXE110	0 26715 16377 9	1	10.70	—	—	1.33	0.96	1.28	1.64
QTXE110FLT	0 26715 17178 1	1	12.00	—	—	1.34	1.21	1.28	2.08
QTXE110S	0 26715 16415 8	1	12.15	—	—	1.32	1.00	1.28	1.69
QTXE150	0 26715 16379 3	1	11.70	—	—	1.33	0.96	1.29	1.65
QTXE150FLT	0 26715 17179 8	1	13.10	—	—	1.33	1.22	1.30	2.10
QTXEN080	7 84891 21825 5	1	11.60	—	—	1.31	0.96	1.30	1.63
QTXEN080FLT	7 84891 21530 8	1	12.90	—	—	1.31	1.23	1.29	2.07
QTXEN110	7 84891 21827 9	1	10.70	—	—	1.32	0.96	1.29	1.63
QTXEN110FLT	7 84891 21531 5	1	12.00	—	—	1.31	1.23	1.29	2.08
QTXEN150	7 84891 21829 3	1	11.60	—	—	1.32	0.96	1.29	1.63
QTXEN150FLT	7 84891 21532 2	1	13.00	—	—	1.32	1.23	1.28	2.08
QTXN110HFLT	0 26715 18798 0	1	22.70	—	—	1.75	1.36	1.33	3.15
QTXN110HL	7 84891 21848 4	1	22.60	—	—	1.75	1.37	1.34	3.21
RB110	0 26715 23005 1	1	13.50	—	—	1.17	1.25	0.96	1.40
RB110L	0 26715 23007 5	1	14.60	—	—	1.24	1.15	1.21	1.73
RB80	0 26715 23004 4	1	14.50	—	—	1.17	1.25	0.96	1.40
RB80L	0 26715 23006 8	1	14.60	—	—	1.24	1.15	1.21	1.73
RBFP33	0 26715 15797 6	1	6.90	—	—	1.29	0.70	1.15	1.04
RBFP45	0 26715 15798 3	1	9.60	—	—	1.28	0.71	1.15	1.05
RCK01	0 26715 19675 3	1	0.60	—	—	0.48	0.27	0.27	0.03
RD1	0 26715 12474 9	1	4.10	—	—	1.09	0.37	1.08	0.43
RD2	0 26715 12475 6	1	4.80	—	—	1.87	0.37	1.10	0.75
RD3	0 26715 12476 3	1	6.40	—	—	1.90	1.58	0.37	1.10
RDF1	0 26715 20166 2	1	4.90	—	—	1.12	1.03	0.42	0.48

Model	UPC Code	Std. Carton		Master Carton		Length	Width	Height	Cube
		Pk.	Wt.	Pk.	Wt.				
RFXN5004	0 26715 17205 4	1	7.30	—	—	3.26	0.86	0.80	2.24
RFXN5204	0 26715 17206 1	1	10.20	—	—	3.29	1.12	1.18	4.32
RFXN5304	0 26715 16523 0	1	15.10	—	—	3.56	1.47	1.38	7.18
RG4	7 84891 00517 6	1	0.30	12	3.60	0.88	0.73	0.05	0.03
RK54	0 26715 17440 9	1	4.50	—	—	1.46	0.90	0.89	1.17
RKE56	0 26715 19518 3	1	7.10	—	—	2.12	0.57	1.42	1.70
RKE58	0 26715 19519 0	1	7.00	—	—	2.12	0.60	1.14	1.45
RKE59	0 26715 19517 6	1	6.60	—	—	2.12	0.63	1.34	1.77
RM503001	0 26715 15813 3	1	36.70	—	—	2.82	1.51	2.03	8.64
RM503004	0 26715 14948 3	1	35.70	—	—	2.79	1.54	2.03	8.72
RM503023	0 26715 15814 0	1	36.70	—	—	2.82	1.51	2.03	8.64
RM503601	0 26715 15815 7	1	40.80	—	—	3.17	1.50	2.04	9.70
RM503604	0 26715 14949 0	1	38.10	—	—	3.18	1.50	2.01	9.56
RM503623	0 26715 15816 4	1	38.20	—	—	3.17	1.51	2.04	9.75
RM519004	0 26715 15089 2	1	37.45	—	—	3.18	1.58	2.03	10.15
RM523004	0 26715 15092 2	1	41.50	—	—	2.82	1.58	2.03	8.98
RM523604	0 26715 15093 9	1	42.80	—	—	3.17	1.53	2.04	9.86
RM524204	0 26715 15094 6	1	45.60	—	—	3.73	1.56	2.03	11.80
RM533004	0 26715 16519 3	1	46.10	—	—	2.81	1.54	2.03	8.80
RM533604	0 26715 16520 9	1	48.00	—	—	3.19	1.56	2.05	10.20
RM534204	0 26715 16521 6	1	52.00	—	—	3.75	1.54	2.04	11.80
RM659004	0 26715 15087 8	1	56.80	—	—	3.39	1.72	2.27	13.20
RMDD3004	0 26715 15175 2	1	66.20	—	—	2.83	2.90	0.90	7.39
RMDD3004EX	0 26715 15178 3	1	53.60	—	—	2.83	2.91	0.90	7.42
RMDD3604	0 26715 15176 9	1	72.70	—	—	3.33	2.89	0.90	8.67
RMDD3604EX	0 26715 15179 0	1	61.80	—	—	3.33	2.91	0.89	8.64
RMDD4804	0 26715 15177 6	1	96.00	—	—	4.33	2.90	0.92	11.50
RMDD4804EX	0 26715 15180 6	1	77.00	—	—	2.92	4.33	0.92	11.59
RMDDRBK	0 26715 15181 3	1	0.30	—	—	0.40	0.35	0.35	0.05
RME5030SS	0 26715 19889 4	1	36.10	—	—	2.80	1.53	2.03	8.68
RMP33	0 26715 15784 6	1	32.50	—	—	3.31	1.16	2.20	8.43
RMP45	0 26715 15785 3	1	41.80	—	—	4.29	1.14	2.21	10.82
RMPWC	0 26715 15796 9	1	1.60	—	—	0.68	0.53	0.41	0.15
RML3336S	0 26715 16367 0	1	10.70	—	—	3.67	2.25	0.42	3.44
RML3342S	0 26715 16368 7	1	14.10	—	—	4.67	2.25	0.42	4.37
RML4548S	0 26715 16369 4	1	13.30	—	—	4.67	2.25	0.42	4.37
RML4554S	0 26715 17282 5	1	18.20	—	—	6.70	2.28	0.42	6.35
RML4560S	0 26715 16370 0	1	19.10	—	—	6.67	2.25	0.42	6.25
RML5230S	0 26715 24015 9	1	11.35	—	—	3.68	2.27	0.43	3.62
RML7030L	0 26715 15793 8	1	11.40	—	—	3.69	2.27	0.42	3.49
RML7030S	0 26715 15790 7	1	10.70	—	—	3.68	2.27	0.43	3.59
RML7036L	0 26715 15794 5	1	11.90	—	—	3.67	2.25	0.42	3.44
RML7036S	0 26715 15791 4	1	11.00	—	—	3.69	2.26	0.43	3.58
RML7048L	0 26715 15795 2	1	16.20	—	—	4.69	2.26	0.42	4.41
RML7048S	0 26715 15792 1	1	14.70	—	—	4.67	2.25	0.42	4.37
RMP17004	0 26715 15228 5	1	35.60	—	—	3.11	1.53	1.21	5.76
RMP3004	0 26715 15324 4	1	19.40	—	—	3.67	2.25	0.42	3.44
RMP3604	0 26715 15325 1	1	19.60	—	—	3.69	2.26	0.42	3.47
RMP4204	0 26715 15326 8	1	23.00	—	—	4.67	2.25	0.42	4.37
RMP4804	0 26715 15327 5	1	24.20	—	—	4.67	2.25	0.42	4.37
RMP5404	0 26715 15328 2	1	30.00	—	—	6.67	2.27	0.42	6.31
RMP6004	0 26715 15329 9	1	34.80	—	—	6.71	2.26	0.44	6.63
RMPE7004	0 26715 15229 2	1	12.30	—	—	2.46	0.77	1.17	2.20
RN110	0 26715 23009 9	1	13.50	—	—	1.17	1.25	0.96	1.40
RN110L	0 26715 23011 2	1	14.60	—	—	1.24	1.15	1.21	1.73
RN80	0 26715 23008 2	1	14.50	—	—	1.17	1.25	0.96	1.40
RN80L	0 26715 23010 5	1	14.60	—	—	1.24	1.15	1.21	1.73
ROUNDFILTER	0 26715 08370 1	1	1.66	—	—	0.75	0.73	0.30	0.16
RP130BL	0 26715 17580 2	1	33.00	—	—	2.71	1.02	2.04	5.62
RP130SS	0 26715 17578 9	1	31.50	—	—	2.69	1.03	2.03	5.59
RP130WWW	0 26715 17579 6	1	33.20	—	—	2.69	1.03	2.04	5.63
RP136BL	0 26715 17583 3	1	35.10	—	—	3.20	1.03	2.04	6.75
RP136SS	0 26715 17581 9	1	34.30	—	—	3.20	1.04	2.05	6.83
RP136WWW	0 26715 17582 6	1	33.80	—	—	3.18	1.03	2.03	6.61
RRK51	0 26715 15090 8	1	3.70	—	—	1.47	0.89	0.90	1.18
RVK1A	0 26715 15782 2	1	2.90	—	—	1.00	0.46	0.94	0.43
S97011308	0 26715 05311 7	1	1.00	—	—	1.03	0.88	0.06	0.05
S97013825	0 26715 10088 0	1	3.55	—	—	1.27	1.23	0.23	0.36
S97013826	0 26715 10089 7	1	2.35	—	—	1.07	1.02	0.16	0.17
S97013827	0 26715 10090 3	1	3.45	—	—	1.26	1.24	0.23	0.35
S99010042	0 26715 03239 6	1	0.10	—	—	0.79	0.79	0.01	0.01

Model	UPC Code	Std. Carton		Master Carton		Length	Width	Height	Cube
		Pk.	Wt.	Pk.	Wt.				
S99010271	0 26715 07821 9	1	0.10	—	—	0.87	0.87	0.01	0.01
S990712044	0 26715 13553 0	1	0.10	—	—	0.35	0.29	0.00	0.00
SMD6	0 26715 19201 4	1	4.80	—	—	0.87	0.56	0.81	0.39
SMD8	0 26715 19202 1	1	5.50	—	—	0.86	0.72	0.96	0.59
SMSCPLR	0 26715 18621 1	1	0.40	—	—	0.43	0.24	0.30	0.03
SP100	0 26715 05720 7	1	15.00	—	—	1.20	1.19	1.08	1.55
SP140	0 26715 05721 4	1	15.40	—	—	1.20	1.18	1.06	1.49
SP200	0 26715 05722 1	1	15.50	—	—	1.21	1.18	1.08	1.54
SP240108	0 26715 06279 9	1	3.10	—	—	2.75	2.28	0.07	0.42
SP240223	0 26715 14089 3	1	3.10	—	—	2.75	2.29	0.07	0.42
SP2404	0 26715 02218 2	1	4.60	—	—	2.75	2.29	0.07	0.42
SP300108	0 26715 06281 2	1	2.60	—	—	2.75	2.29	0.07	0.42
SP300223	0 26715 14090 9	1	2.70	—	—	2.75	2.28	0.07	0.42
SP3004	0 26715 00076 0	1	6.00	—	—	2.75	2.29	0.07	0.42
SP360108	0 26715 06283 6	1	3.70	—	—	3.75	2.29	0.07	0.57
SP360223	0 26715 14091 6	1	3.40	—	—	3.75	2.29	0.07	0.57
SP3604	0 26715 00077 7	1	7.60	—	—	3.75	2.29	0.07	0.57
SP420108	0 26715 06285 0	1	3.90	—	—	3.92	2.29	0.07	0.60
SP420223	0 26715 14092 3	1	3.70	—	—	3.75	2.29	0.07	0.57
SP4204	0 26715 02228 1	1	7.30	—	—	3.75	2.29	0.07	0.57
SPB18LWHCL	0 26715 23790 6	1	0.10	—	—	0.25	0.08	0.08	0.00
SPK110	0 26715 23412 7	1	12.05	—	—	1.29	0.94	1.31	1.59
SPKACC	0 26715 23414 1	1	2.10	—	—	1.06	0.53	0.53	0.30
SSQTXE080	0 26715 18620 4	1	12.00	—	—	0.96	1.29	1.33	1.65
SSQTXE110	0 26715 18619 8	1	12.15	—	—	0.97	1.29	1.33	1.66
T457	0 26715 25209 1	1	1.40	—	—	0.67	0.58	0.17	0.06
T460	0 26715 16881 1	1	2.00	—	—	1.30	0.77	0.67	0.66
T461	0 26715 16882 8	1	0.80	8	6.40	1.27	0.44	0.50	0.28
T486	0 26715 22964 2	1	1.50	—	—	0.79	0.79	0.67	0.42
T487	0 26715 20786 2	1	1.40	—	—	0.75	0.77	0.71	0.41
T81212	0 26715 13195 2	1	4.00	—	—	1.09	1.09	0.99	1.18
TF40BS	0 26715 19637 1	1	3.00	—	—	0.78	0.82	0.75	0.47
TF40GAP	0 26715 19639 5	1	4.60	—	—	1.14	1.13	0.58	0.75
TF40GCL	0 26715 19641 8	1	4.80	—	—	1.11	1.13	0.58	0.73
TF40GFW	0 26715 19640 1	1	4.80	—	—	0.94	0.93	0.58	0.51
TF40RB	0 26715 19638 8	1	3.10	—	—	0.78	0.81	0.75	0.47
TF40WH	0 26715 19635 7	1	3.05	—	—	0.83	0.79	0.77	0.51
TYIK1	0 26715 17042 5	1	4.55	—	—	2.08	1.58	0.71	2.34
V104	0 26715 02700 2	—	—	4	2.25	0.40	0.39	0.31	0.05
VB20W	0 26715 10282 2	1	0.25	—	—	0.65	0.53	0.19	0.06
VB60W	0 26715 24317 4	1	0.20	—	—	0.42	0.27	0.08	0.01
VS63WH	7 84891 27434 3	1	0.40	6	2.40	0.40	0.24	0.18	0.02
VS66WH	7 84891 27465 7	1	0.60	6	3.60	0.26	0.40	0.44	0.05
VS67WH	7 84891 27475 6	1	0.60	6	3.60	0.43	0.42	0.25	0.04
VS68WH	7 84891 27485 5	1	0.70	6	4.20	0.43	0.25	0.42	0.04
VS69WH	7 84891 27495 4	1	0.70	2	1.40	0.23	0.44	0.46	0.05
VT10W	0 26715 24316 7	1	0.55	—	—	0.44	0.44	0.17	0.03
VT11W	0 26715 10283 9	1	0.70	—	—	0.20	0.53	0.67	0.07
VT4W	0 26715 17041 8	1	0.30	—	—	0.52	0.20	0.67	0.07
VT5W	0 26715 18336 4	1	0.30	—	—	0.73	0.53	0.14	0.05

XN110H – ZN80ML

Model	UPC Code	Std. Carton		Master Carton		Length	Width	Height	Cube
		Pk.	Wt.	Pk.	Wt.				
XN110H	0 26715 20291 1	1	12.30	—	—	1.23	1.15	0.96	1.35
XN110HL	0 26715 20299 7	1	13.70	—	—	1.23	1.14	1.21	1.70
XN110L	0 26715 20122 8	1	13.40	—	—	1.24	1.15	1.21	1.73
XN50	0 26715 20120 4	1	12.10	—	—	1.24	1.16	0.94	1.35
XN50L	0 26715 20126 6	1	13.70	—	—	1.25	1.16	1.18	1.71
XN80	0 26715 20118 1	1	12.20	—	—	1.24	1.16	0.93	1.34
XN80L	0 26715 20124 2	1	13.50	—	—	1.24	1.15	1.21	1.73
ZB110	0 26715 20107 5	1	11.90	—	—	1.25	1.17	0.95	1.39
ZB110H	0 26715 20286 7	1	12.40	—	—	1.23	1.15	0.94	1.34
ZB110HL	0 26715 20294 2	1	13.80	—	—	1.23	1.15	1.21	1.71
ZB110L	0 26715 20111 2	1	13.60	—	—	1.23	1.15	1.21	1.71
ZB110M	0 26715 20288 1	1	12.30	—	—	1.23	1.14	0.95	1.33
ZB110ML	0 26715 20296 6	1	13.70	—	—	1.24	1.15	1.21	1.73
ZB80	0 26715 20109 9	1	12.00	—	—	1.23	1.15	0.95	1.35

Model	UPC Code	Std. Carton		Master Carton		Length	Width	Height	Cube
		Pk.	Wt.	Pk.	Wt.				
ZB80L	0 26715 20113 6	1	13.60	—	—	1.24	1.17	1.22	1.76
ZB80M	0 26715 20289 8	1	12.60	—	—	1.23	1.16	0.96	1.37
ZB80ML	0 26715 20297 3	1	13.90	—	—	1.24	1.15	1.21	1.73
ZN110	0 26715 20108 2	1	11.80	—	—	1.24	1.16	0.95	1.37
ZN110H	0 26715 20290 4	1	12.40	—	—	1.24	1.16	0.95	1.37
ZN110HL	0 26715 20298 0	1	13.70	—	—	1.24	1.15	1.21	1.73
ZN110L	0 26715 20112 9	1	13.20	—	—	1.24	1.16	1.21	1.74
ZN110M	0 26715 20292 8	1	12.30	—	—	1.23	1.14	0.95	1.33
ZN110ML	0 26715 20300 0	1	13.20	—	—	1.23	1.16	1.19	1.70
ZN80	0 26715 20110 5	1	12.10	—	—	1.25	1.15	0.93	1.34
ZN80L	0 26715 20114 3	1	13.80	—	—	1.24	1.16	1.19	1.71
ZN80M	0 26715 20293 5	1	12.60	—	—	1.24	1.16	0.96	1.38
ZN80ML	0 26715 20301 7	1	13.80	—	—	1.23	1.15	1.20	1.70



BROAN[®]

- Attic Ventilation
- Range Hoods
- Ventilation Fans
- Whole House Mechanical Ventilation

Customer Service 1-800-558-1711
 Technical Support 1-800-637-1453

www.Broan.com

2017 LIST PRICES / FULL LINE PRODUCTS



NuTone[®]

- Central Vacuum Systems
- Door Chimes
- Heaters
- Intercom Systems
- Ironing Centers
- Ventilation Fans

Customer Service 1-888-336-3948
 Technical Support 1-888-336-6151

www.NuTone.com

Effective Date: April 1, 2017
 Supersedes all previous pricing

Download a copy of this price book at
www.broan.com/catalogs or www.nutone.com/catalogs

All sales are governed by the Terms and Conditions available at <http://salesterms.broan-nutone.com>. Buyer's additional or different terms are hereby rejected.

BROAN[®]

Broan 926 W. State Street Hartford, WI 53027

99850822T



Accessories	1	Range Hoods	26	Ventilation Fans	66
Dampers	5	Accessories	51	Bath Fan Upgrade Kit	73
Ducting	6	Blowers	37	Combination Units	78
Elbows	6	Chimney Hoods	26	Decorative Fan/Light	71
Hanger Bars	6	Downdraft Hoods	30	Duct Free	73
Replacement Parts	1	Energy Star Hoods	42	Economy	73
Roof Caps	4	High Performance Hoods	34	Heavy Duty Series	72
Transitions	4	Power Packs	31	High Capacity	81
Wall Caps	5	Under Cabinet Hoods	38	InVent	69
Wall Controls	7			LED	71
Attic Ventilators	8	Trash Compactors	52	LoProfile	72
Parts & Accessories	9	Accessories	52	Project Packs	74
Roof Mount Powered	8			Recessed Fan/Light	71
Gable Mount Powered	9			Remote In-Line	77
Solar Powered	8			Room-to-Room	79
				Sensing	69
				Sensonic™	55 & 68
				SmartSense®	55 & 68
				QT Series™	55 & 68
				ULTRA™	66
				Utility Ventilators	80
				Vertical Discharge	80
				Whole House Mechanical Ventilation	85
				Accessories	87
				Fresh Air Systems	85
				ULTRA™	88
				SmartSense®	85



Accessories	1	Heaters	20	Ventilation Fans	53
Dampers	5	Accessories	22	Basic	59
Ducting	6	Bulb	79	Bath Fan Upgrade Kit	60
Elbows	6	Ceiling	20	Bulb Heaters	65
Hanger Bars	6	Fan-Forced	21	Combination Units	64
Replacement Parts	1	Kickspace	21	Duct Free	60
Roof Caps	4	Portable	21	EZFit	59
Transitions	4	Project Packs	22	In-Line Fans	63
Wall Caps	5	Register	22	InVent	57
		Wall	21	LED	57
Central Vacuum Systems	13	Intercom Systems	23	LoProfile	58
Accessory Kits	14	NM100	23	LunAura	56
Power Units	13	NM200	24	Project Packs	60
Door Chimes	17	Electronic Door Release	25	Recessed Fan/Light	58
Accessories	20	Ironing Centers	25	Sensing	54
Chime Kits	18	Accessories	25	QT Series™	56 & 64
College Pride	19	Cabinets	25	ULTRA™	53 & 89
Hard-Wired Chimes	17	Doors	25	Utility	65
Wireless Chimes	18	Paddle/Ceiling Fans	10		
Wired Pushbuttons	19	Accessories	12		
Wireless Pushbuttons	20	Ceiling Hugger	10		
Haven™		Commercial	11		
Haven™ and Accessories	20	Controls	13		
		Standard Five Blades	10		
		Light Kits	11		
		Outdoor	10		
				Full Line Index	i
				Carton/UPC Directory	90

Full Line Index

Model No.	List Price	Code	Page Number(s)
1006	\$19.46	CP	52
100HFL	\$366.52	LV	78
100HL	\$304.68	LV	78
103023	\$512.70	DH	32
103123	\$64.98	DH	32
110RDF	\$114.96	HV	72
112	\$280.60	HT	21
114	\$249.74	HT	21
120	\$172.30	HT	22
124	\$180.78	HT	22
128	\$186.26	HT	22
12C	\$466.80	HV	80
153001	\$980.66	DH	45
153004	\$1,019.04	DH	45
153023	\$980.66	DH	45
153601	\$1,060.24	DH	45
153604	\$1,099.60	DH	45
153623	\$1,060.24	DH	45
157	\$133.90	HT	20
15TCBB	\$163.56	CP	52
15TCBL	\$24.94	CP	52
15TCOD	\$53.30	CP	52
15TCTK	\$23.58	CP	52
161	\$51.72	HV	79
162	\$107.80	HV	79
162F	\$20.72	HV	76
162H	\$87.08	HV	76
163	\$86.04	HV	79
164	\$143.84	HV	79
165F	\$127.04	HT	22
165FT	\$137.70	HT	22
1667H	\$9.98	LV	76
1667HMTL	\$23.66	LV	76
1670F	\$55.04	LV	76
1671F	\$49.48	LV	76
167F	\$127.04	HT	22
167FT	\$137.70	HT	22
1688F	\$35.20	LV	76
1689F	\$46.28	LV	76
170	\$172.30	HT	21
171H	\$34.56	HT	22
174	\$180.78	HT	21
174F	\$135.52	HT	22
174FT	\$146.20	HT	22
178	\$193.80	HT	21
192	\$422.78	HT	21
194	\$445.58	HT	21
198	\$466.80	HT	21
2677H	\$16.40	LV	75
2678F	\$80.90	LV	75
269VL	\$47.28	AC	7
269WL	\$47.28	AC	7
273001C	\$83.62	HA	30, 31
273002C	\$83.62	HA	30, 31
273003	\$1,047.58	DH	30
273023C	\$83.62	HA	30, 31
273601C	\$83.62	HA	30, 31
273602C	\$83.62	HA	30, 31
273603	\$1,047.58	DH	30
273623C	\$83.62	HA	30, 31
277V	\$91.60	AC	7, 84
283003	\$727.64	DH	31
283603	\$727.64	DH	31
326N	\$68.50	CA	14
330ALM	\$8.76	CA	14
330W	\$8.76	CA	14

Model No.	List Price	Code	Page Number(s)
331H	\$643.02	DH	37
332H	\$835.62	DH	37
332KR	\$110.28	HA	37
335	\$1,113.90	DH	37
336	\$1,390.56	DH	37
345CSOBK	\$562.28	SO	8
345CSOWW	\$562.28	SO	8
345GOBK	\$562.28	SO	8
345GOWW	\$562.28	SO	8
345RSOBK	\$598.34	SO	8
345RSOWW	\$598.34	SO	8
345SOBK	\$562.28	SO	8
345SOWW	\$562.28	SO	8
349BR	\$257.54	HV	8
35	\$30.14	AC	52
350BK	\$222.86	HV	8
350BR	\$229.14	HV	8
353	\$152.26	HV	9
35316	\$230.24	HV	9
355BK	\$236.16	HV	8
355BR	\$242.44	HV	8
356BK	\$307.68	HV	8
356BR	\$313.98	HV	8
356NDK	\$114.86	HA	33
357NDK	\$140.68	HA	33
358	\$273.48	HV	8
359NDK	\$140.68	AC	32
360ALM	\$20.60	CA	14
360IV	\$20.60	CA	14
360W	\$20.60	CA	14
3677H	\$21.04	LV	75
372	\$114.34	CA	14
372401	\$79.94	LL	50
372408	\$79.94	LL	50
373001	\$75.54	LL	50
373002	\$75.54	LL	50
373004	\$134.30	LL	50
373008	\$75.54	LL	50
373601	\$79.94	LL	50
373604	\$138.70	LL	50
376UL	\$73.64	CA	14
378	\$4.12	CA	14
3808	\$9.78	CA	14
3808B	\$9.78	CA	14
3810	\$11.84	CA	14
391	\$11.84	CA	14
392	\$28.84	CA	14
393	\$31.94	CA	14
394	\$20.08	CA	14
395	\$85.50	CA	14
3964	\$111.76	CA	14
402101	\$157.52	LL	50
402102	\$157.52	LL	50
402108	\$157.52	LL	50
402401	\$132.56	LL	50
402402	\$132.56	LL	50
402404	\$191.36	LL	50
402408	\$132.56	LL	50
403001	\$128.14	LL	50
403002	\$128.14	LL	50
403004	\$186.92	LL	50
403008	\$128.14	LL	50
403023	\$128.14	LL	50
403601	\$132.56	LL	50
403602	\$132.56	LL	50
403604	\$191.36	LL	50

Model No.	List Price	Code	Page Number(s)
403608	\$132.56	LL	50
403623	\$132.56	LL	50
404201	\$136.92	LL	50
404202	\$136.92	LL	50
404208	\$136.92	LL	50
406	\$23.10	AC	6
407	\$23.84	AC	6
408	\$26.00	AC	6
410	\$30.78	AC	6
411	\$28.00	AC	4
412101	\$160.74	LL	51
412102	\$160.74	LL	51
412108	\$160.74	LL	51
412123	\$160.74	LL	51
412401	\$135.78	LL	51
412402	\$135.78	LL	51
412404	\$194.56	LL	51
412408	\$135.78	LL	51
412H	\$30.14	AC	4
413	\$34.24	AC	4
413001	\$131.36	LL	51
413002	\$131.36	LL	51
413004	\$190.16	LL	51
413008	\$131.36	LL	51
413023	\$131.36	LL	51
413601	\$135.78	LL	51
413602	\$135.78	LL	51
413604	\$194.56	LL	51
413608	\$135.78	LL	51
413623	\$135.78	LL	51
414	\$50.98	AC	4
414201	\$140.20	LL	51
414202	\$140.20	LL	51
414204	\$198.98	LL	51
414208	\$140.20	LL	51
415	\$17.90	AC	6
418	\$43.28	AC	4, 6
419	\$18.92	AC	6
41F	\$17.42	AC	3, 46, 48, 51
421	\$47.82	AC	5
422401	\$125.04	LL	49
422401D	\$135.34	LL	49
422402	\$125.04	LL	49
422404	\$183.84	LL	49
422408	\$125.04	LL	49
423	\$70.56	AC	4, 82, 83, 84
423001	\$120.68	LL	49
423001D	\$130.62	LL	49
423002	\$120.68	LL	49
423004	\$179.44	LL	49
423008	\$120.68	LL	49
423008D	\$130.62	LL	49
423023	\$120.68	LL	49
423601	\$125.04	LL	49
423601D	\$135.34	LL	49
423602	\$125.04	LL	49
423604	\$183.84	LL	49
423608	\$125.04	LL	49
423608D	\$135.34	LL	49
423623	\$125.04	LL	49
424	\$87.86	AC	4
424201	\$129.48	LL	49
424201D	\$139.80	LL	49
424202	\$129.48	LL	49
424204	\$188.22	LL	49
424208	\$129.48	LL	49

Model No.	List Price	Code	Page Number(s)
427	\$76.34	AC	4
428	\$35.64	AC	6
429	\$47.82	AC	6
430	\$62.18	AC	6
431	\$62.40	AC	6
432	\$31.30	AC	6
433	\$82.22	AC	9
433004	\$205.14	LL	47
433011	\$143.36	LL	47
433018	\$143.36	LL	47
433022	\$143.36	LL	47
433023	\$143.36	LL	47
433604	\$212.20	LL	47
433611	\$152.80	LL	47
433618	\$152.80	LL	47
433622	\$152.80	LL	47
433623	\$152.80	LL	47
437	\$192.06	AC	4
438	\$41.22	AC	5
441	\$102.12	AC	5
453	\$103.26	AC	4
454	\$103.26	AC	4
459	\$46.52	AC	4
462401	\$200.12	RH	46
462404	\$258.92	RH	46
462423	\$200.12	RH	46
463001	\$190.58	RH	46
463002	\$190.58	RH	46
463004	\$249.36	RH	46
463008	\$190.58	RH	46
463011	\$190.58	RH	46
463023	\$190.58	RH	46
463601	\$200.12	RH	46
463602	\$200.12	RH	46
463604	\$258.92	RH	46
463608	\$200.12	RH	46
463623	\$200.12	RH	46
464201	\$209.72	RH	46
464202	\$209.72	RH	46
464204	\$268.48	RH	46
464208	\$209.72	RH	46
472	\$50.60	AC	5
475	\$10.40	AC	4
475B	\$7.64	AC	4
502	\$232.20	HV	80
503	\$154.18	HV	80
504	\$182.92	HV	80
505	\$131.38	HV	80
506	\$231.94	HV	80
507	\$188.64	HV	80
508	\$231.94	HV	80
509	\$154.34	HV	80
509S	\$163.20	HV	80
510	\$208.34	HV	79
511	\$166.92	HV	79
512	\$73.74	HV	79
512M	\$105.30	HV	79
57V	\$46.64	AC	7
57W	\$46.64	AC	7
59V	\$60.34	AC	7, 87
59W	\$60.34	AC	7, 87
605RP	\$216.56	LV	65
610FA	\$135.80	AC	5
611	\$90.64	AC	4
611CM	\$120.12	AC	4
612	\$155.42	AC	4

Model No.	List Price	Code	Page Number(s)
612CM	\$169.90	AC	4
613	\$98.62	AC	5
613004	\$2,227.84	DH	26
614804	\$2,518.80	DH	26
614804EX	\$1,917.40	DH	26
619004	\$2,256.94	DH	26
619004EX	\$1,648.56	DH	26
61V	\$60.34	AC	7, 87
61W	\$60.34	AC	7, 87
6201	\$105.72	PH	21
62W	\$89.52	AC	7
634	\$51.74	AC	4
634M	\$60.34	AC	4, 87
636	\$29.62	AC	4
636AL	\$38.36	AC	4
637004	\$4,310.06	DH	26
637004EX	\$3,891.40	DH	26
639	\$34.86	AC	5
63V	\$79.94	AC	7
63W	\$79.94	AC	7
641	\$71.04	AC	5, 87
641FA	\$57.22	AC	5
642	\$27.04	AC	5
643	\$89.52	AC	5
643FA	\$84.10	AC	5
644	\$66.92	AC	4
646	\$48.14	AC	5
647	\$80.22	AC	5
649	\$45.08	AC	5
64V	\$115.84	AC	7
64W	\$115.84	AC	7
654H	\$26.66	LV	76
655	\$218.42	LV	78
655F	\$191.76	LV	76
656	\$190.46	LV	78
656F	\$163.82	LV	76
657	\$144.00	LV	78
657F	\$117.34	LV	76
658	\$211.26	LV	78
658F	\$184.60	LV	76
659	\$215.38	LV	78
659F	\$188.72	LV	76
665RP	\$218.42	LV	65
668RP	\$141.06	LV	59
66V	\$38.22	AC	7
66W	\$38.22	AC	7
670	\$65.02	LV	73
671	\$59.46	LV	73
673	\$59.34	LV	80
678	\$97.30	LV	73
67W	\$41.40	AC	7
682	\$67.62	LV	73
682NT	\$67.62	LV	60
685WL	\$68.16	AC	7
688	\$45.18	LV	73
689	\$56.26	LV	73
68V	\$31.04	AC	7
68W	\$31.04	AC	7
690	\$59.74	UK	73
690NT	\$59.74	UK	60
690RA	\$9.98	LV	62
690RMTLA	\$23.24	LV	62
695	\$59.46	LV	59
695RB	\$49.48	LV	62
696	\$197.84	LV	78
696N	\$45.18	LV	59

Model No.	List Price	Code	Page Number(s)
696RNB	\$35.20	LV	62
69W	\$12.84	AC	7, 9
70TW	\$66.14	AC	7
71V	\$63.56	AC	7, 9
72V	\$84.92	AC	7, 37
72W	\$84.92	AC	7, 37
73	\$44.84	AC	9
741SN	\$173.40	HV	71
744	\$171.96	NF	71
744FL	\$238.46	NF	71
744FLNT	\$238.46	NF	58
744LED	\$307.98	NF	71
744LEDNT	\$307.98	NF	58
744NT	\$171.96	NF	58
744SFL	\$342.68	NF	71
744SFLNT	\$342.68	NF	58
750	\$244.08	HV	72
751	\$220.04	HV	72
754RB	\$176.20	HV	71
75V	\$86.52	AC	7
761BN	\$189.40	HV	71
761RB	\$189.40	HV	71
761WHA	\$189.40	HV	71
763	\$94.46	LV	59
763F	\$78.06	LV	62
763H	\$16.40	LV	62
765HFL	\$366.52	LV	64
765HL	\$304.68	LV	64
77DV	\$44.60	AC	7, 64, 78
77DW	\$44.60	AC	7, 64, 78
78V	\$49.76	PA	13
78W	\$49.76	PA	13
791LEDM	\$252.36	HM	71
79V	\$70.42	PA	13
79W	\$70.42	PA	13
804DD	\$17.20	AC	5
804DU	\$71.62	AC	6
804QDD	\$18.22	AC	61, 75
80L	\$50.98	AC	84
80RDF	\$109.24	HV	72
8210	\$169.88	HV	65
82W	\$101.30	AC	7, 87
83	\$21.52	AC	22
8310	\$208.24	HV	65
834	\$19.50	AC	1
84	\$44.00	AC	22
843BL	\$54.50	AC	5
85	\$97.60	AC	22
854	\$23.52	AC	1
8663RP	\$244.08	HV	59
8664RP	\$220.04	HV	59
877	\$32.14	AC	4
87W	\$31.14	AC	22
883001	\$505.36	RH	44
883002	\$505.36	RH	44
883004	\$569.32	RH	44
883008	\$505.36	RH	44
883011	\$505.36	RH	44
883023	\$505.36	RH	44
883601	\$555.90	RH	44
883604	\$624.38	RH	44
883608	\$555.90	RH	44
883623	\$555.90	RH	44
883901	\$618.26	RH	44
883904	\$701.82	RH	44
884201	\$609.80	RH	44

Model No.	List Price	Code	Page Number(s)
884204	\$737.90	RH	44
884223	\$609.80	RH	44
884801	\$636.12	RH	44
884804	\$668.48	RH	44
884823	\$636.12	RH	44
885AL	\$39.60	AC	5
885BL	\$31.28	AC	5
885NS	\$30.94	AC	5
889	\$29.32	AC	6
88F	\$32.30	AC	3, 43, 44
893001	\$657.16	RH	44
893004	\$738.36	RH	44
893011	\$657.16	RH	44
893023	\$657.16	RH	44
893601	\$680.60	RH	44
893604	\$761.82	RH	44
893623	\$680.60	RH	44
893901	\$719.62	RH	44
893904	\$800.82	RH	44
894201	\$704.02	RH	44
894204	\$785.22	RH	44
894223	\$704.02	RH	44
894801	\$727.44	RH	44
894804	\$808.68	RH	44
90	\$57.84	AC	7, 21, 22
9093WH	\$414.70	HV	64
9412D	\$51.72	HV	65
9417DN	\$107.80	HV	65
9422P	\$86.04	HV	65
9427P	\$143.84	HV	65
961L	\$31.28	AC	84
97	\$37.08	AC	5
9810WH	\$266.46	HT	21
9815WH	\$273.74	HT	21
981L	\$31.28	AC	84
982L	\$39.80	AC	84
983L	\$42.64	AC	84
9905	\$346.34	HV	64
9960	\$313.24	HV	64
9965	\$364.42	HV	64
A000HF	\$23.34	HM	74
A000HFS	\$103.34	HM	69
A000HL	\$23.34	HM	74
A110	\$166.68	HM	70
A110F	\$143.34	HM	74
A110L	\$383.34	HM	70
A50L	\$145.00	HM	70
A70L	\$146.68	HM	70
A70LF	\$123.34	HM	74
A80	\$150.00	HM	70
A80F	\$126.68	HM	74
A80HD	\$193.34	HM	70
A80HDF	\$170.00	HM	74
A80L	\$350.00	HM	70
ACCGSEF2	\$39.80	GA	87
ACCGSFF2	\$39.78	GA	87
ACCGSFH	\$168.70	GA	87
ACCGSFHP10	\$1,881.00	GA	87
ACCGSFHP2	\$198.50	GA	87
ACCGSFP2	\$36.68	GA	87
ACCGSFP20	\$353.44	GA	87
ACCGSUHD	\$56.98	GA	87
ACCGSUP5	\$71.52	GA	87
ACCHEPAPFK	\$36.20	AQ	87
ACCHEPARF	\$98.04	AQ	87
ACCWMK	\$70.02	AQ	87

Model No.	List Price	Code	Page Number(s)
AE110	\$266.68	HM	70
AE110F	\$243.34	HM	74
AE110L	\$433.34	HM	70
AE110LF	\$337.84	HM	74
AE110S	\$353.98	HM	69
AE110SL	\$489.30	HM	69
AE50	\$166.68	HM	70
AE50F	\$143.34	HM	74
AE60	\$809.40	AQ	85
AE80	\$240.00	HM	70
AE80B	\$116.68	HM	70
AE80BF	\$93.34	HM	74
AE80BL	\$216.66	HM	70
AE80BLF	\$193.32	HM	74
AE80F	\$216.68	HM	74
AE80L	\$400.00	HM	70
AE80LF	\$376.68	HM	74
AE80S	\$326.50	HM	69
AE80SL	\$429.10	HM	69
AEE60302SS	\$299.76	HA	34
AEE60362SS	\$311.34	HA	34
AEE60422SS	\$322.98	HA	34
AEE60482SS	\$334.62	HA	34
AEPD18SS	\$318.28	OH	35
AEPD18SSE	\$335.24	OH	35
AEPD2445SS	\$843.42	OH	35
AEPD2445SSE	\$875.26	OH	35
AEPD30SS	\$420.12	OH	35
AEPD30SSE	\$437.10	OH	35
AEPD6SS	\$182.48	OH	35
AEPD6SSE	\$199.44	OH	35
AEN110	\$266.68	HM	57
AEN110F	\$243.34	HM	60
AEN110L	\$433.34	HM	57
AEN50	\$166.68	HM	57
AEN50F	\$143.34	HM	60
AEN80	\$240.00	HM	57
AEN80B	\$116.68	HM	57
AEN80BF	\$93.34	HM	60
AEN80BL	\$216.66	HM	57
AEN80BLF	\$193.32	HM	60
AEN80F	\$216.68	HM	60
AEN80L	\$400.00	HM	57
AEN80LF	\$376.68	HM	60
AN000HF	\$23.34	HM	60
AN000HL	\$23.34	HM	60
AN110	\$166.68	HM	57
AN110F	\$143.34	HM	60
AN110L	\$383.34	HM	57
AN70L	\$146.68	HM	57
AN70LF	\$123.34	HM	60
AN80HDF	\$170.00	HM	60
AN80L	\$350.00	HM	57
ANKE60302SS	\$346.48	HA	34, 35
ANKE60362SS	\$358.98	HA	34, 35
ANKE60422SS	\$448.02	HA	34, 35
ANKE60482SS	\$453.52	HA	34, 35
AP130BL	\$658.18	RH	43
AP130SS	\$709.82	RH	43
AP130WW	\$658.18	RH	43
AP136BL	\$678.82	RH	43
AP136SS	\$730.44	RH	43
AP136WW	\$678.82	RH	43
APE130SS	\$752.48	RH	43
ARP310	\$49.18	AC	30, 31, 34, 35, 41
ARP314	\$49.18	AC	36

Model No.	List Price	Code	Page Number(s)
ARP6	\$49.18	AC	26, 28, 29, 31, 33
AVDOFPN	\$146.42	IB	25
AVDORPN	\$174.44	IB	25
AVDSMN	\$85.84	IB	25
AVDWRPN	\$183.60	IB	25
AWEPD36SS	\$387.24	OH	35
AWEPD48SS	\$437.10	OH	35
AWEPD60SS	\$469.00	OH	35
B12LCDARNW	\$7,585.16	AQ	85
B12LCDASNW	\$7,585.16	AQ	85
B12LCDPRNC	\$7,973.92	AQ	85
B12LCDPRNW	\$6,880.80	AQ	85
B12LCDPSNC	\$7,973.92	AQ	85
B12LCDPSNW	\$6,880.80	AQ	85
B12LCEARNW	\$7,131.32	AQ	85
B12LCEASNW	\$7,131.32	AQ	85
B12LCEPRNC	\$7,520.08	AQ	85
B12LCEPRNW	\$6,426.96	AQ	85
B12LCEPSNC	\$7,520.08	AQ	85
B12LCEPSNW	\$6,426.96	AQ	85
B1600705	\$7,180.10	AQ	87
B6LCDARN	\$6,285.44	AQ	85
B6LCDASN	\$6,285.44	AQ	85
B6LCDPRN	\$5,846.24	AQ	86
B6LCDPSN	\$5,846.24	AQ	86
B6LCEARN	\$5,021.52	AQ	86
B6LCEASN	\$5,021.52	AQ	86
B6LCEPRN	\$4,582.32	AQ	86
B6LCEPSN	\$4,582.32	AQ	86
BCR1	\$88.64	QA	27, 38
BD4	\$83.98	AQ	6, 87
BD6	\$83.98	AQ	6, 87
BK105	\$24.22	DC	18
BK110NBWH	\$32.14	DC	18
BK115LWH	\$35.28	DC	18
BK120NBWH	\$34.08	DC	18
BK125LWH	\$37.70	DC	18
BK131LPB	\$37.82	DC	18
BK131LRBZ	\$37.82	DC	18
BK131LSN	\$37.82	DC	18
BK131LWH	\$37.82	DC	18
BK140LWH	\$38.82	DC	18
BK140SLPB	\$41.46	DC	18
BK142LWH	\$41.46	DC	18
BK144LCL	\$32.14	DC	18
BK147LWH	\$54.30	DC	18
BP1	\$17.14	AC	2
BP10	\$15.30	AC	2
BP11	\$17.14	AC	2
BP17	\$43.42	AC	2
BP18	\$43.42	AC	2
BP19	\$43.42	AC	2
BP2	\$17.14	AC	2
BP20	\$7.60	AC	1
BP24	\$17.22	AC	1
BP25	\$11.02	AC	1
BP27	\$35.70	AC	1
BP28	\$36.44	AC	1
BP29	\$9.34	AC	2, 46, 48, 49, 50
BP33	\$11.54	AC	1
BP34	\$11.54	AC	1
BP35	\$15.10	AC	1
BP36	\$14.46	AC	1
BP38	\$15.10	AC	1
BP4	\$9.34	AC	2
BP43	\$7.02	AC	2

Model No.	List Price	Code	Page Number(s)
BP436	\$7.02	AC	2
BP46	\$6.12	AC	1
BP5	\$9.44	AC	2
BP50	\$25.94	AC	1
BP51	\$36.44	AC	1
BP52	\$47.66	AC	2
BP55	\$9.34	AC	2
BP56	\$17.14	AC	2
BP57	\$16.50	AC	2, 47
BP58	\$11.58	AC	2, 47
BP7	\$9.44	AC	2
BP87	\$11.46	AC	2, 5, 38, 39, 40, 41, 42, 46
BP87Q	\$18.42	AC	5, 48, 49
BP90	\$8.68	AC	1
BP91	\$18.66	AC	1
BPAPFA	\$51.62	AC	2, 43
BPP2FA30	\$56.82	QA	2, 39
BPP2FA36	\$68.18	QA	2, 39
BPP2FA42	\$85.26	QA	2, 39
BPP3FA30	\$71.60	QA	2, 38
BPP3FA36	\$82.96	QA	2, 38
BPP3FA42	\$100.00	QA	2, 38
BPPF30	\$29.82	QA	2, 38, 39
BPPF36	\$32.24	QA	2, 38, 39
BPPF42	\$38.92	QA	2, 38, 39
BPPFA30	\$53.70	QA	2, 39
BPPFA36	\$60.86	QA	2, 39
BPPFA42	\$68.18	QA	2, 39
BPODE30	\$57.82	AC	2, 42
BPQTAF	\$9.40	AC	2, 45, 46
BPQTF	\$11.80	AC	2, 45, 46
BPRPFA	\$23.24	AC	2, 43
BPS1FA30	\$27.60	AC	3, 42
BPS1FA36	\$30.22	AC	3, 42
BPS2FA30	\$40.44	AC	3, 41
BPS2FA36	\$44.88	AC	3, 41
BPS3FA30	\$61.84	AC	3, 40
BPS3FA36	\$69.20	AC	3, 40
BPSF30	\$31.52	AC	3, 40, 41, 42
BPSF36	\$33.70	AC	3, 40, 41, 42
BPSF42	\$36.22	AC	3, 40, 41, 42
C350BN	\$35.30	AC	1
C350GN	\$10.48	AC	1
C370BN	\$50.44	AC	1
C905	\$17.10	DA	20
C907	\$27.10	DA	20
C909	\$30.18	DA	20
C915	\$27.10	DA	20
CA130	\$61.80	CA	14
CF328	\$2.58	CA	14
CF329	\$6.18	CA	14
CF361	\$14.42	CA	14
CF361F	\$20.08	CA	14
CF362	\$3.10	CA	14
CF363	\$4.64	CA	14
CF364	\$4.64	CA	14
CF365	\$4.64	CA	14
CF366	\$2.58	CA	15
CF367	\$13.90	CA	15
CF368	\$1.76	CA	15
CF369	\$1.76	CA	15
CF372	\$6.18	CA	15
CF377	\$1.76	CA	15
CF380	\$1.04	CA	15
CF382	\$1.64	CA	15
CF382S	\$1.64	CA	15

Model No.	List Price	Code	Page Number(s)
CF382XS	\$2.58	CA	15
CF383	\$2.26	CA	15
CF384	\$3.60	CA	15
CF385	\$1.54	CA	15
CF386	\$2.06	CA	15
CF387	\$3.10	CA	15
CF388	\$1.04	CA	15
CF389	\$2.06	CA	15
CF3918	\$19.58	CA	15
CFC56BR	\$194.20	PF	11
CFC56WH	\$194.20	PF	11
CFH52BS	\$173.78	PF	10
CFH52RB	\$173.78	PF	10
CFH52WH	\$167.14	PF	10
CFO52BQ	\$207.42	PF	10
CFO52WB	\$189.76	PF	10
CFO52WH	\$196.40	PF	10
CFS52BS	\$138.20	PF	10
CFS52RB	\$139.96	PF	10
CFS52WH	\$133.70	PF	10
CFSABR	\$15.32	PA	12
CFSABS	\$15.76	PA	12
CFSARB	\$16.64	PA	12
CFSAWH	\$15.32	PA	12
CFT12WH	\$69.40	AC	7
CH230L	\$184.88	CA	15
CH235	\$149.86	CA	15
CH515	\$353.80	CA	15
CH615	\$353.80	CA	15
CI319	\$2.06	CA	15
CI324	\$2.06	CA	15
CI330	\$6.18	CA	15
CI3301RK	\$88.06	CA	15
CI3303RK	\$120.52	CA	15
CI358W	\$23.70	CA	15
CI365W	\$82.40	CA	15
CI366W	\$7.22	CA	15
CI367IV	\$72.10	CA	15
CI367W	\$72.10	CA	15
CI390W	\$10.30	CA	15
CI395RK	\$29.88	CA	15
CI399ALM	\$10.30	CA	15
CI399EB	\$21.26	CA	15
CI399RK	\$29.88	CA	15
CI399W	\$10.30	CA	15
CK110	\$52.36	CA	15
CK135	\$27.82	CA	16
CS100	\$128.76	CA	16
CS200	\$138.02	CA	16
CS300	\$396.56	CA	16
CS400	\$473.80	CA	16
CS500	\$854.90	CA	16
CS600	\$854.90	CA	16
CT105	\$4.64	CA	16
CT106G	\$6.70	CA	16
CT109	\$3.60	CA	16
CT110	\$3.60	CA	16
CT132	\$26.26	CA	16
CT140G	\$28.84	CA	16
CT143B	\$17.00	CA	16
CT150B	\$24.20	CA	16
CT156B	\$26.26	CA	16
CT157B	\$37.08	CA	16
CT158	\$43.26	CA	16
CT170	\$54.08	CA	16
CT175	\$54.08	CA	16

Model No.	List Price	Code	Page Number(s)
CT350B	\$40.18	CA	16
CT700	\$292.00	CA	16
CVG4	\$35.38	AC	1, 63, 77
CVG6	\$47.56	AC	1, 63, 77
CVL4	\$32.94	AC	1
CVL5	\$20.60	AC	1
CVL6	\$30.82	AC	1
CVLD4	\$47.84	AC	1, 63
CVLD6	\$57.12	AC	1, 63
CWT45	\$42.44	SO	8
D100	\$31.82	AC	84
D101	\$33.46	AC	84
DC4	\$7.52	AC	4
DH100W	\$47.54	AC	9
DR12OBQ	\$15.66	PA	12
DR12OWB	\$15.66	PA	12
DR12OWH	\$15.66	PA	12
DR12RB	\$15.66	PA	12
DR12WH	\$9.04	PA	12
DR18OBQ	\$21.74	PA	12
DR18OWB	\$21.86	PA	12
DR18RB	\$21.74	PA	12
DR18WH	\$11.04	PA	12
DR1BA	\$84.56	IA	25
DR1SA	\$99.98	IA	25
DR24BR	\$24.82	PA	12
DR24OBQ	\$24.82	PA	12
DR24OWB	\$24.82	PA	12
DR24RB	\$24.82	PA	12
DR24WH	\$14.24	PA	12
DR2SA	\$177.64	IA	25
DR36BR	\$32.54	PA	12
DR36BS	\$32.54	PA	12
DR36OBQ	\$32.54	PA	12
DR36OWB	\$32.54	PA	12
DR36RB	\$32.54	PA	12
DR36WH	\$19.10	PA	12
DR48BR	\$39.62	PA	12
DR48BS	\$39.16	PA	12
DR48RB	\$39.16	PA	12
DR48WH	\$26.36	PA	12
DT4C	\$49.36	AC	87
DT4W	\$71.72	AC	87
DT6C	\$64.64	AC	87
DT6W	\$100.32	AC	6, 87
E5490SS	\$2,787.48	DH	28
E6030SS	\$1,907.64	DH	34
E6036SS	\$1,983.58	DH	34
E6042TSS	\$2,332.70	DH	34
E6048TSS	\$2,409.66	DH	34
E60E30SS	\$1,616.48	DH	34
E60E36SS	\$1,709.88	DH	34
E60E42SS	\$1,754.42	DH	34
E60E48SS	\$1,842.56	DH	34
E6430SS	\$1,268.42	DH	35
E6436SS	\$1,295.24	DH	35, 45
E6442SS	\$1,393.08	DH	35
E6448SS	\$1,449.34	DH	35
E6448TSS	\$1,717.36	DH	35
E64E30SS	\$1,027.70	DH	35
E64E36SS	\$1,078.44	DH	35
E64E42SS	\$1,181.82	DH	35
E64E48SS	\$1,246.02	DH	35
E66130BL	\$1,131.78	RH	36
E66130SS	\$1,215.28	RH	36
E66130WH	\$1,131.78	RH	36

Model No.	List Price	Code	Page Number(s)
E66136BL	\$1,167.52	RH	36
E66136SS	\$1,253.66	RH	36
E66136WH	\$1,167.52	RH	36
E66142SS	\$1,293.20	RH	36
EH6	\$76.70	AQ	87
EI5936SS	\$1,651.62	DH	27
EP300108	\$35.60	AC	51
EP300223	\$35.60	AC	51
EPD6136SS	\$2,440.08	OH	35
EPD6148SS	\$2,758.34	OH	35
EPD6160SS	\$3,639.00	OH	35
ERV100S	\$1,371.56	AQ	86
ERV100SP	\$1,496.36	AQ	86
ERV110S	\$1,366.56	AQ	86
ERV110T	\$1,366.56	AQ	86
ERV120S	\$1,433.96	AQ	86
ERV120T	\$1,433.96	AQ	86
ERV140TE	\$2,494.76	AQ	86
ERV180S	\$1,870.76	AQ	86
ERV200TE	\$3,549.86	AQ	86
ERV250TE	\$2,995.20	AQ	86
ERV70S	\$1,246.76	AQ	86
ERV70T	\$1,246.76	AQ	86
ERVH100S	\$1,995.56	AQ	86
ERVS100S	\$1,064.00	AQ	86
EW5630SS	\$1,096.88	DH	27
EW5636SS	\$1,147.96	DH	27
EW5830SS	\$1,096.88	DH	27
EW5836SS	\$1,147.96	DH	27
EZ80N	\$236.60	HV	59
F402401	\$141.00	LL	48
F402402	\$141.00	LL	48
F402404	\$200.46	LL	48
F402408	\$141.00	LL	48
F402411	\$141.00	LL	48
F402422	\$141.00	LL	48
F402423	\$141.00	LL	48
F403001	\$135.24	LL	48
F403002	\$135.24	LL	48
F403004	\$192.26	LL	48
F403008	\$135.24	LL	48
F403011	\$135.24	LL	48
F403022	\$135.24	LL	48
F403023	\$135.24	LL	48
F403601	\$148.76	LL	48
F403602	\$148.76	LL	48
F403604	\$211.48	LL	48
F403608	\$148.76	LL	48
F403611	\$148.76	LL	48
F403622	\$148.76	LL	48
F403623	\$148.76	LL	48
F404201	\$163.62	LL	48
F404202	\$163.62	LL	48
F404204	\$232.64	LL	48
F404208	\$163.62	LL	48
F404211	\$163.62	LL	48
F404222	\$163.62	LL	48
F404223	\$163.62	LL	48
FILTERE56	\$57.56	AC	3, 27
FILTERE56FL	\$73.22	AC	27
FILTEREB40	\$93.42	HA	3, 29, 31
FILTER SQUARE	\$59.44	HA	3, 28, 29
FX54SS	\$929.16	HA	28
FXN54SS	\$929.16	HA	28
FXNE56SS	\$397.74	AC	27
FXNE58SS	\$284.86	AC	27

Model No.	List Price	Code	Page Number(s)
FXNE59SS	\$682.76	AC	27
FY6	\$46.20	AC	63
FY86	\$35.56	AC	63
G102	\$149.58	AC	84
G103	\$192.74	AC	84
G686N	\$12.68	AC	1
GU10	\$17.06	AC	31, 34, 35, 36, 38, 39, 43, 52
GU1035	\$15.92	AC	27, 39, 45, 52
HCK44	\$21.74	AC	52
HCK44D	\$14.30	AC	52
HD50RDF	\$120.88	HV	72
HD80L	\$154.68	HV	72
HLB11	\$1,146.88	DH	37
HLB3	\$424.78	DH	37
HLB6	\$716.78	DH	37
HLB9	\$961.04	DH	37
HRV120S	\$1,246.76	AQ	86
HRV120T	\$1,246.76	AQ	86
HRV150S	\$1,616.16	AQ	86
HRV150TE	\$1,643.12	AQ	86
HRV160T	\$1,553.76	AQ	86
HRV160TE	\$1,870.76	AQ	86
HRV190S	\$1,870.76	AQ	86
HRV200TE	\$2,745.60	AQ	86
HRV250TE	\$2,884.28	AQ	86
HRV80S	\$1,026.34	AQ	86
HRV80T	\$1,026.34	AQ	86
HRV90S	\$1,154.40	AQ	86
HRV90T	\$1,154.40	AQ	86
HRVH100S	\$1,496.36	AQ	86
HRVH100SE	\$1,773.82	AQ	86
HVDCT	\$78.00	ML	20
HVLFABL	\$200.00	ML	20
HVLFABR	\$200.00	ML	20
HVPFBL	\$9.00	ML	20
HVPFBR	\$9.00	ML	20
HVRC1	\$67.00	ML	20
HVRC4	\$206.00	ML	20
HVRFABL	\$165.00	ML	20
HVRFABR	\$165.00	ML	20
ICAB	\$36.16	IB	25
ICAK	\$134.62	IB	25
ICDFUW	\$116.68	IB	25
ICDM	\$151.68	IB	25
ICDRUW	\$116.68	IB	25
ICUDWHX	\$306.68	IB	25
ICUNUWX	\$285.18	IB	25
ILF120	\$320.94	HV	63
ILF130	\$336.22	HV	63
ILF250	\$351.50	HV	63
ILF360	\$482.02	HV	63
ILF530	\$631.14	HV	63
ILFK120	\$351.50	HV	63
ILFK130	\$366.80	HV	63
ILFK250	\$397.32	HV	63
ILFK2502	\$458.50	HV	63
ILRF	\$310.64	HV	63
L100	\$243.56	HV	81
L100L	\$262.80	HV	83
L100MG	\$269.92	HV	81
L150	\$251.76	HV	81
L1500	\$815.80	HV	82
L1500L	\$851.58	HV	83
L150L	\$271.08	HV	83
L150MG	\$278.20	HV	81

Model No.	List Price	Code	Page Number(s)
L200	\$277.48	HV	81
L2000L	\$1,221.78	HV	84
L200L	\$297.30	HV	83
L200MG	\$303.88	HV	81
L250	\$293.92	HV	81
L250L	\$313.70	HV	83
L250MG	\$320.28	HV	81
L300	\$300.28	HV	81
L300KMG	\$346.68	HV	81
L300L	\$320.12	HV	83
L300MG	\$326.68	HV	81
L3500EXL	\$1,691.26	HV	84
L400	\$406.90	HV	82
L400K	\$442.58	HV	82
L400KL	\$472.96	HV	83
L400L	\$437.22	HV	83
L500	\$492.50	HV	82
L500K	\$528.14	HV	82
L500KL	\$558.54	HV	83
L500L	\$522.86	HV	83
L700	\$578.10	HV	82
L700L	\$608.44	HV	83
L900	\$730.16	HV	82
L900L	\$766.00	HV	83
LA100WH	\$36.60	DC	17
LA107WH	\$96.38	DC	17
LA11BG	\$42.26	DC	17
LA11WH	\$42.26	DC	17
LA126WH	\$34.36	DC	17
LA130WH	\$62.70	DC	17
LA139WH	\$34.36	DC	17
LA140WH	\$34.36	DC	17
LA14WH	\$61.42	DC	17
LA164WH	\$166.60	DC	17
LA165SA	\$166.60	DC	17
LA174WH	\$133.60	DC	17
LA18WH	\$78.46	DC	17
LA202WH	\$53.10	DC	17
LA223WH	\$48.18	DC	18
LA224RWH	\$78.72	DC	18
LA224WH	\$88.18	DC	18
LA225WH	\$42.54	DC	18
LA226WH	\$65.18	DC	18
LA301WH	\$41.42	DC	17
LA305WL	\$351.62	DC	17
LA310CY	\$403.22	DC	17
LA39WH	\$162.84	DC	17
LA501CY	\$653.24	DC	17
LA542WH	\$66.46	DC	18
LA552RW	\$82.38	DC	18
LA553WH	\$53.82	DC	18
LA600WH	\$98.86	DC	17, 18
LA70MA	\$315.30	DC	17
LAF1	\$15.40	AC	84
LAF2	\$26.56	AC	84
LB30	\$99.56	HA	32, 33
LB36	\$110.18	HA	32, 33
LK20ASRB	\$92.12	PA	11
LK20FWBS	\$93.44	PA	11
LK20FWWH	\$92.68	PA	11
LK30ABS	\$93.44	PA	11
LK30ARB	\$94.32	PA	11
LK30AWH	\$92.68	PA	11
LK50DBQ	\$61.78	PA	11
LK50DWB	\$61.78	PA	11
LK50DWH	\$61.78	PA	11

Model No.	List Price	Code	Page Number(s)
LP80	\$148.96	HV	72
LP80F	\$120.92	HV	74
LP80H	\$28.04	HV	61, 74
LPN80	\$148.96	HV	58
LPN80F	\$120.92	HV	61
LT30	\$99.56	HA	32, 33
LT36	\$110.18	HA	32, 33
MCB2	\$14.94	AC	59, 71, 72, 73
MCV309NWHGL	\$60.14	DC	17
MD10S	\$297.06	HA	5
MD10T	\$307.66	HA	5, 35
MD10TU	\$350.10	HA	5
MD6S	\$171.86	HA	5
MD6T	\$174.86	HA	5, 27, 34, 35, 38
MD6TU	\$244.00	HA	5
MD8S	\$193.08	HA	5
MD8T	\$188.30	HA	5, 27, 34, 35, 38
MD8TU	\$265.22	HA	5
MG1	\$36.96	AC	84
MHB4	\$20.00	AC	57, 70
MMDC4	\$25.00	AC	57, 70
MMG	\$43.34	AC	57, 70
MP100	\$317.08	HV	77
MP140	\$367.88	HV	77
MP200	\$437.82	HV	77
MP280	\$507.50	HV	77
MQF4	\$20.00	AC	57, 70
NA200TA	\$60.26	NM	23, 24
NA3003C	\$67.62	NM	23, 24
NA3008C	\$133.98	NM	23, 24
NA300MCWH	\$24.60	NM	23, 24
NA300TA	\$77.42	NM	23, 24
NDB300AB	\$73.74	NM	23, 24
NDB300BB	\$79.62	NM	23, 24
NDB300N	\$76.34	NM	23, 24
NDB300WH	\$49.18	NM	23, 24
NDK35830BL	\$153.66	HA	43
NDK35830SS	\$165.96	HA	43
NDK35830WW	\$153.66	HA	43
NDK35836BL	\$165.96	HA	43
NDK35836SS	\$178.22	HA	43
NDK35836WW	\$165.96	HA	43
NES300DBL	\$27.04	NM	23, 24
NES300DWH	\$27.04	NM	23, 24
NF100CWH	\$95.90	NM	24
NF100MWH	\$63.90	NM	23, 24
NF200MWH	\$40.68	NM	23, 24
NF300DWH	\$25.84	NM	23, 24
NF300PWH	\$61.44	NM	23, 24
NF300RWH	\$38.12	NM	23, 24
NM100WH	\$889.84	NM	23
NM200AL	\$946.36	NM	24
NM200K	\$1,354.42	NM	24
NM200WH	\$860.36	NM	24
NPS103WH	\$126.58	NM	23
NPS104WH	\$126.58	NM	23
NPS200WH	\$121.70	NM	24
NR380WH	\$119.24	NM	23
NRKF200P	\$27.04	NM	23, 24
NRKR200R	\$50.40	NM	23, 24
NRKR300D	\$14.74	NM	23, 24
NRKRWH300	\$209.00	NM	23, 24
NRKS200PWH	\$39.32	NM	23, 24
NRKS300R	\$51.62	NM	23
NRS103WH	\$84.84	NM	23
NRS104WH	\$84.84	NM	23

Model No.	List Price	Code	Page Number(s)
NRS200AL	\$90.96	NM	24
NRS200WH	\$82.36	NM	24
NW4S	\$37.20	NM	23, 24
NWH300	\$182.44	NM	23, 24
P5	\$504.92	RH	37
P57W	\$48.72	AC	8
P59V	\$78.12	AC	8
P59W	\$78.12	AC	8
P66V	\$40.70	AC	8
P66W	\$40.70	AC	8
P685WL	\$71.24	AC	8
P68W	\$33.48	AC	8
P8	\$920.68	RH	37
PAR20	\$23.20	AC	31, 40, 41, 42, 52
PB10LGL	\$11.64	DA	19
PB15LBR	\$26.62	DA	19
PB15LPB	\$23.58	DA	19
PB15LSN	\$26.62	DA	19
PB18LWHCL	\$7.86	DA	19
PB18WHCL	\$5.00	DA	19
PB19LGL	\$20.20	DA	19
PB27LBR	\$26.62	DA	19
PB27LSN	\$26.62	DA	19
PB29LR	\$22.08	DA	19
PB29LSN	\$22.08	DA	19
PB41APB41LA	\$3.46	DA	19
PB41BGL	\$7.24	DA	19
PB41LBGL	\$10.08	DA	19
PB41LBR	\$11.96	DA	19
PB41LSN	\$11.96	DA	19
PB4LBL	\$22.78	DA	19
PB4LBR	\$26.62	DA	19
PB4LSN	\$26.62	DA	19
PB53LWH	\$22.78	DA	19
PB59LPB	\$20.50	DA	19
PB61LPB	\$24.96	DA	19
PB64LAB	\$21.22	DA	19
PB67AB	\$7.92	DA	19
PB69LBL	\$8.04	DA	19
PB69LPC	\$8.04	DA	19
PB69LSN	\$10.16	DA	19
PB69LWH	\$8.04	DA	19
PB78LWHCL	\$27.58	DA	20
PB7LBL	\$7.58	DA	19
PB7LPB	\$7.58	DA	19
PB7LSN	\$7.58	DA	19
PB7LWH	\$7.58	DA	19
PB7WH	\$7.58	DA	19
PB82WH	\$21.22	DC	20
PB85BR	\$36.82	DC	20
PB85SN	\$36.82	DC	20
PBL2	\$5.78	DA	20
PM250	\$193.60	RH	33
PM390	\$436.20	RH	33
PM500SS	\$762.20	DH	32
PME300	\$606.84	RH	33
PP500	\$638.60	CX	13
PP600	\$870.36	CX	13
PP650	\$1,158.76	CX	13
QDE30SS	\$743.34	RH	42
QDE30WW	\$708.50	RH	42
QML30BL	\$272.90	QP	45
QML30SS	\$309.54	QP	45
QML30WW	\$272.90	QP	45
QP130BL	\$348.44	QP	39
QP130SS	\$405.72	QP	39

Model No.	List Price	Code	Page Number(s)
QP130WW	\$348.44	QP	39
QP136BL	\$361.56	QP	39
QP136SS	\$418.84	QP	39
QP136WW	\$361.56	QP	39
QP142BL	\$392.90	QP	39
QP142SS	\$453.86	QP	39
QP142WW	\$392.90	QP	39
QP230BC	\$529.58	QP	39
QP230BL	\$529.58	QP	39
QP230SS	\$589.82	QP	39
QP230WW	\$529.58	QP	39
QP236BC	\$542.08	QP	39
QP236BL	\$542.08	QP	39
QP236SS	\$602.32	QP	39
QP236WW	\$542.08	QP	39
QP242BC	\$555.72	QP	39
QP242BL	\$555.72	QP	39
QP242SS	\$615.96	QP	39
QP242WW	\$555.72	QP	39
QP330BL	\$714.84	QP	38
QP330SS	\$776.18	QP	38
QP330WW	\$714.84	QP	38
QP336BL	\$728.46	QP	38
QP336SS	\$789.84	QP	38
QP336WW	\$728.46	QP	38
QP342BL	\$740.96	QP	38
QP342SS	\$802.30	QP	38
QP342WW	\$740.96	QP	38
QP430SS	\$960.24	QP	38
QP436SS	\$974.90	QP	38
QP442SS	\$987.38	QP	38
QS130AA	\$283.14	AH	42
QS130BC	\$283.14	AH	42
QS130BL	\$283.14	AH	42
QS130SS	\$343.82	AH	42
QS130WW	\$283.14	AH	42
QS136AA	\$296.62	AH	42
QS136BC	\$296.62	AH	42
QS136BL	\$296.62	AH	42
QS136SS	\$364.08	AH	42
QS136WW	\$296.62	AH	42
QS142AA	\$320.52	AH	42
QS142BC	\$320.52	AH	42
QS142BL	\$320.52	AH	42
QS142SS	\$384.26	AH	42
QS142WW	\$320.52	AH	42
QS230AA	\$502.56	AH	41
QS230BC	\$502.56	AH	41
QS230BL	\$502.56	AH	41
QS230SS	\$566.26	AH	41
QS230WW	\$502.56	AH	41
QS236AA	\$520.28	AH	41
QS236BC	\$520.28	AH	41
QS236BL	\$520.28	AH	41
QS236SS	\$591.00	AH	41
QS236WW	\$520.28	AH	41
QS242AA	\$534.40	AH	41
QS242BC	\$534.40	AH	41
QS242BL	\$534.40	AH	41
QS242SS	\$612.28	AH	41
QS242WW	\$534.40	AH	41
QS330AA	\$672.46	AH	40
QS330BC	\$672.46	AH	40
QS330BL	\$672.46	AH	40
QS330SS	\$736.12	AH	40
QS330WW	\$672.46	AH	40

Model No.	List Price	Code	Page Number(s)
QS336AA	\$686.62	AH	40
QS336BC	\$686.62	AH	40
QS336BL	\$686.62	AH	40
QS336SS	\$757.40	AH	40
QS336WW	\$686.62	AH	40
QS342AA	\$700.76	AH	40
QS342BC	\$700.76	AH	40
QS342BL	\$700.76	AH	40
QS342SS	\$778.62	AH	40
QS342WW	\$700.76	AH	40
QSE130BL	\$375.12	AH	42
QSE130SS	\$430.30	AH	42
QSE130WW	\$375.12	AH	42
QT230AA	\$246.34	AH	46
QT230BC	\$246.34	AH	46
QT230BL	\$246.34	AH	46
QT230SS	\$325.60	AH	46
QT230WW	\$246.34	AH	46
QT236AA	\$254.82	AH	46
QT236BC	\$254.82	AH	46
QT236BL	\$254.82	AH	46
QT236SS	\$334.10	AH	46
QT236WW	\$254.82	AH	46
QT242AA	\$260.48	AH	46
QT242BC	\$260.48	AH	46
QT242BL	\$260.48	AH	46
QT242SS	\$339.72	AH	46
QT242WW	\$260.48	AH	46
QT9093WH	\$507.64	HV	64
QTHB1	\$18.70	AC	6
QTNLEDA	\$423.30	NF	56
QTNLEDB	\$423.30	NF	56
QTX110HFLT	\$610.34	HV	78
QTX110HL	\$548.52	HV	78
QTXE080	\$252.68	HV	69
QTXE080FLT	\$372.34	HV	69
QTXE110	\$285.90	HV	69
QTXE110FLT	\$412.22	HV	69
QTXE110S	\$400.62	HV	69
QTXE150	\$342.46	HV	69
QTXE150FLT	\$482.08	HV	69
QTXEN080	\$252.68	HV	56
QTXEN080FLT	\$372.34	HV	56
QTXEN110	\$285.90	HV	56
QTXEN110FLT	\$412.22	HV	56
QTXEN150	\$342.46	HV	56
QTXEN150FLT	\$482.08	HV	56
QTXN110HFLT	\$610.34	HV	64
QTXN110HL	\$548.52	HV	64
RB110	\$290.68	HP	68
RB110L	\$408.46	HP	68
RB80	\$262.06	HP	68
RB80L	\$383.00	HP	68
RBFIP33	\$220.72	AC	31
RBFIP45	\$272.22	AC	31
RCK01	\$52.96	PA	10, 13
RD1	\$171.06	AC	84
RD2	\$182.48	AC	84
RD3	\$228.14	AC	84
RDF1	\$121.24	HP	61, 75
RDFQF	\$121.24	HV	61, 75
RDFQL	\$121.24	HV	61, 75
RDFU	\$121.24	HP	61, 75
RDFUWT	\$121.24	HP	61, 75
RDH	\$138.76	HV	72
RDJ1	\$141.36	HV	61, 75

Model No.	List Price	Code	Page Number(s)
RDJUMPQ	\$8.44	AC	61, 75
RDJUMPU	\$16.90	AC	61, 75
RDM1	\$166.68	HM	57, 70
RDMWT	\$166.68	HM	57, 70
RFTH95	\$22.30	AC	9
RFX5001	\$283.04	HA	29
RFX5004	\$283.04	HA	29
RFX5023	\$283.04	HA	29
RFX5104	\$283.04	HA	29
RFX5204	\$283.04	HA	28
RFX5304	\$291.50	HA	28
RFX6104	\$509.40	HA	26
RFX6104EX	\$566.00	HA	26
RFX6304EX	\$1,386.76	HA	26
RFX6504	\$509.40	HA	26
RFXN5004	\$283.04	HA	29
RFXN5204	\$283.04	HA	28
RFXN5304	\$291.50	HA	28
RG4	\$35.64	AC	1
RK54	\$199.12	HA	28
RKE56	\$223.48	AC	27
RKE58	\$223.48	AC	27
RKE59	\$223.48	AC	27
RM503001	\$976.40	DH	29
RM503004	\$976.40	DH	29
RM503023	\$976.40	DH	29
RM503601	\$1,066.96	DH	29
RM503604	\$1,066.96	DH	29
RM503623	\$1,066.96	DH	29
RM519004	\$1,287.68	DH	29
RM523004	\$1,208.48	DH	28
RM523604	\$1,287.68	DH	28
RM524204	\$1,454.68	DH	28
RM533004	\$1,208.48	DH	28
RM533604	\$1,287.68	DH	28
RM534204	\$1,454.68	DH	28
RM659004	\$2,971.64	DH	26
RMDD3004	\$1,715.08	DH	30
RMDD3004EX	\$1,372.60	DH	30
RMDD3604	\$1,763.16	DH	30
RMDD3604EX	\$1,409.36	DH	30
RMDD4804	\$1,938.60	DH	30
RMDD4804EX	\$1,599.06	DH	30
RMDDRKBK	\$70.74	HA	30
RME5030SS	\$1,052.58	RH	29
RMIP33	\$776.58	DH	31
RMIP45	\$855.82	DH	31
RMIPWC	\$138.68	HA	31
RML3336S	\$313.80	HA	32
RML3342S	\$321.10	HA	32
RML4548S	\$339.30	HA	32
RML4554S	\$370.88	HA	32
RML4560S	\$375.96	HA	32
RML5230S	\$265.92	HA	32
RML7030L	\$284.22	HA	32
RML7030S	\$265.92	HA	32
RML7036L	\$321.10	HA	32
RML7036S	\$313.80	HA	32
RML7048L	\$393.44	HA	32
RML7048S	\$339.30	HA	32
RMP17004	\$1,075.46	DH	31
RMP3004	\$537.06	HA	36
RMP3604	\$574.82	HA	36
RMP4204	\$612.48	HA	36
RMP4804	\$650.20	HA	36
RMP5404	\$688.00	HA	36

Model No.	List Price	Code	Page Number(s)
RMP6004	\$725.66	HA	36
RMPE7004	\$764.12	DH	31
RN110	\$290.68	HP	55
RN110L	\$408.46	HP	55
RN80	\$262.06	HP	55
RN80L	\$383.00	HP	55
ROUNDFILTER	\$97.14	HA	3, 26
RP130BL	\$567.82	RH	43
RP130SS	\$619.46	RH	43
RP130WW	\$567.82	RH	43
RP136BL	\$588.48	RH	43
RP136SS	\$640.08	RH	43
RP136WW	\$588.48	RH	43
RRK51	\$147.16	HA	28, 29
RVK1A	\$71.72	AC	4
S97011308	\$45.60	PT	72
S97013825	\$42.48	PT	81
S97013826	\$35.46	PT	81
S97013827	\$51.44	PT	81
S99010042	\$10.46	PT	81
S99010271	\$13.04	PT	81
S990712044	\$0.64	PT	7
SMD6	\$281.36	HA	5, 85
SMD8	\$296.16	HA	5, 85
SMSCPLR	\$45.90	AR	55, 68, 85
SP100	\$285.40	HV	77
SP140	\$301.24	HV	77
SP200	\$317.08	HV	77
SP240108	\$39.28	AC	51
SP240223	\$38.28	AC	51
SP2404	\$99.80	AC	51
SP300108	\$39.28	AC	51
SP300223	\$39.28	AC	51
SP3004	\$99.80	AC	51
SP360108	\$45.74	AC	51
SP360223	\$45.74	AC	51
SP3604	\$106.04	AC	51
SP420108	\$53.14	AC	51
SP420223	\$53.14	AC	51
SP4204	\$123.02	AC	51
SPB18LWHCL	\$7.96	PT	20
SPK110	\$394.84	HV	55, 68
SPKACC	\$181.98	AC	55, 68
SSQTXE080	\$287.06	HV	55, 68, 85
SSQTXE110	\$318.84	HV	55, 68, 85
T457	\$26.00	AC	4, 49
T460	\$34.90	AC	4, 36, 38
T461	\$45.24	AC	4, 36, 38
T486	\$31.30	AC	4
T487	\$33.32	AC	4
T81212	\$71.60	AC	4, 82, 83, 84
TF40BS	\$63.44	PA	11
TF40GAP	\$76.68	PA	11
TF40GCL	\$61.24	PA	11
TF40GFW	\$62.90	PA	11
TF40RB	\$63.44	PA	11
TF40WH	\$62.34	PA	11
TYIK1	\$125.48	AQ	87
V104	\$23.88	AC	84

Model No.	List Price	Code	Page Number(s)
VB20W	\$31.66	AQ	87
VB60W	\$45.96	AQ	87
VS63WH	\$68.00	AC	7
VS66WH	\$86.88	AC	7
VS67WH	\$125.72	AC	7
VS68WH	\$86.88	AC	7
VS69WH	\$125.72	AC	7
VT10W	\$698.68	AQ	87
VT1W	\$61.16	AQ	87
VT4W	\$84.98	AQ	87
VT5W	\$96.16	AQ	87
VT6W	\$57.12	AQ	87
VT7W	\$167.82	AQ	87
VT8W	\$271.96	AQ	87
VT9W	\$208.00	AQ	87
VX1000	\$1493.50	CX	13
VX1000C	\$1,493.50	CX	13
VX3916	\$18.52	XH	16
VX3918	\$74.42	XH	16
VX3918STD	\$18.98	XH	16
WC638	\$95.00	AC	6, 36, 38
WC650	\$20.78	AC	6
WVK2A	\$34.94	AC	6
XB110	\$301.50	HP	66
XB110H	\$404.48	HP	67
XB110HL	\$523.64	HP	67
XB110L	\$416.52	HP	66
XB50	\$264.80	HP	66
XB50L	\$373.90	HP	66
XB80	\$281.14	HP	66
XB80L	\$403.14	HP	66
XN110	\$301.50	HP	53
XN110H	\$404.48	HP	54
XN110HL	\$523.64	HP	54
XN110L	\$416.52	HP	53
XN50	\$264.80	HP	53
XN50L	\$373.90	HP	53
XN80	\$281.14	HP	53
XN80L	\$403.14	HP	53
ZB110	\$337.68	HP	66, 88
ZB110H	\$448.82	HP	67, 88
ZB110HL	\$570.70	HP	67, 88
ZB110L	\$454.76	HP	66, 88
ZB110M	\$383.74	HP	67, 88
ZB110ML	\$511.80	HP	67, 88
ZB80	\$308.94	HP	66, 88
ZB80L	\$423.68	HP	66, 88
ZB80M	\$356.76	HP	67, 88
ZB80ML	\$478.38	HP	67, 88
ZN110	\$337.68	HP	53, 89
ZN110H	\$448.82	HP	54, 89
ZN110HL	\$570.70	HP	54, 89
ZN110L	\$454.76	HP	53, 89
ZN110M	\$383.74	HP	54, 89
ZN110ML	\$511.80	HP	54, 89
ZN80	\$308.94	HP	53, 89
ZN80L	\$423.68	HP	53, 89
ZN80M	\$356.76	HP	54, 89
ZN80ML	\$478.38	HP	54, 89

Accessories — Hood and Fan

Broan – NuTone Fan Replacement Parts

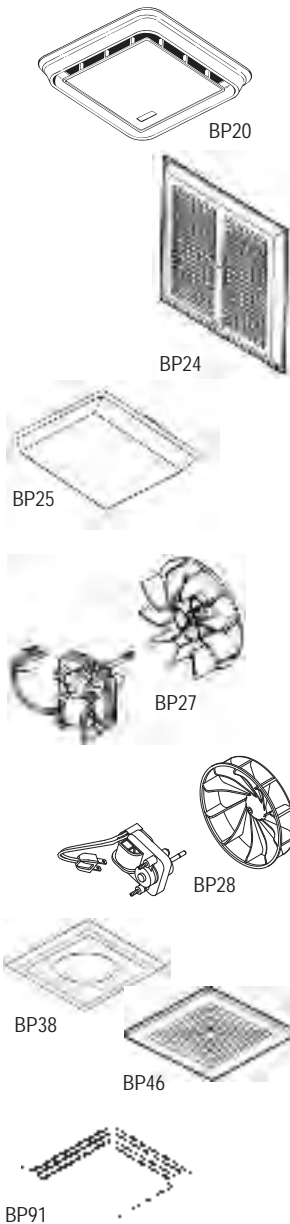

Model No.	Description	Std. Pk.	List Price	Code
BP20	Grille — Bath Fan (663, 670, 671, 675, 688 and 689)	6 *	\$7.60	AC
BP24	Grille — Bath Fan (Metal) (660, 662, 664, 665, 666 and 668)	15 *	\$17.22	AC
BP25	Light Lens — Fan/Light (678, 679, 679FL, 655, 656, 657, 659, 695 and 696)	6 *	\$11.02	AC
BP27	50 CFM Bath Fan Motor and Blower Wheel — Compatible with Broan 662, 668, 678-A, B, C, D, E, F and 688-A, B, C, D, E; Nautilus N678-A, B, C, D, E and N688-A, B, C	6 *	\$35.70	AC
BP28	Motor/Wheel — 70 CFM (655, 657, 658, 679, 671 and 671-A)	6 *	\$36.44	AC
BP33	Grille — Spring-Mounted (AC2650, AC2660, AC2900, 7550 and 7650)	6 *	\$11.54	AC
BP34	Grille — Center Screw-Mounted (Aubrey 7570)	6 *	\$11.54	AC
BP35	Grille/Knob — Utility Fan (8")	12 *	\$15.10	AC
BP36	Light Lens (AC2550, AC25501C and 682L)	5 *	\$14.46	AC
BP38	Grille — Single Bulb Heater	10 *	\$15.10	AC
BP46	Grille Assembly — Spring-Mounted (663, 670, 671, 675, 688, 689, Sears and others)	12 *	\$6.12	AC
BP50	Motor/Wheel — 50 CFM (663N, 663LN, and 696N ver. A)	6 *	\$25.94	AC
BP51	Motor/Wheel — 70 CFM (694 and 695 ver. A)	6 *	\$36.44	AC
BP90	Replacement Grille for 688 Fan	4 *	\$8.68	AC
BP91	Replacement Grille and Light Lens — Each grille and light lens is individually poly bagged and labeled with installation guide. Grille and Light Lens — Fits Fan/Light for Broan 678, 679, 679FL, 679FLT, 680, 680FL, 680FLT, HD50L, HD80L, FL2679FT and FL2680FT; NuTone HD50LNT and HD80LNT; Nautilus N678, N679, N679FL and N680. Light Lens Only — Broan 655, 656, 657, 659, 695, 696 and 707; Nautilus N707.	4 *	\$18.66	AC
C350BN	50 CFM Replacement Motor/Wheel (NuTone 696N A housing)	1	\$35.30	AC
C350GN	Grille — NuTone 695 and 696N with 8" x 7-1/4" housing	4 *	\$10.48	AC
C370BN	70 CFM Replacement Motor/Wheel (NuTone 695 A housing)	1	\$50.44	AC
CVG4	4" Grille	1	\$35.38	AC
CVG6	6" Grille	1	\$47.56	AC
CVL4	4" Sleeve	1	\$32.94	AC
CVL5	Grille Sleeve for 5" Round Duct	1	\$20.60	AC
CVL6	6" Sleeve	1	\$30.82	AC
CVLD4	4" Sleeve with Damper	1	\$47.84	AC
CVLD6	6" Sleeve with Damper	1	\$57.12	AC
G686N	Grille for NuTone 686	4 *	\$12.68	AC
RG4	Grille for NuTone 8832SA	1	\$35.64	AC
834	Filter for 8" Exhaust Fans (807C, 821C, 822C and 831C)	1	\$19.50	AC
854	Filter for 10" Exhaust Fans	6 *	\$23.52	AC

For model specific information, please refer to Broan Retail Parts publication (No. 99850402).

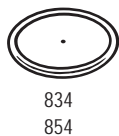
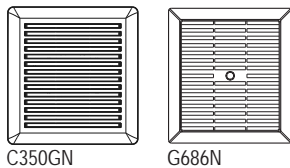

- Item too large to ship via UPS/FedEx. Item shipped common carrier at minimum rates.
- * All pricing reflects the individual item cost. You must order in multiples as indicated.
- ◆ UL listed for use over bathtubs and showers when connected to a GFCI protected branch circuit.

Broan – NuTone Hood Replacement Parts

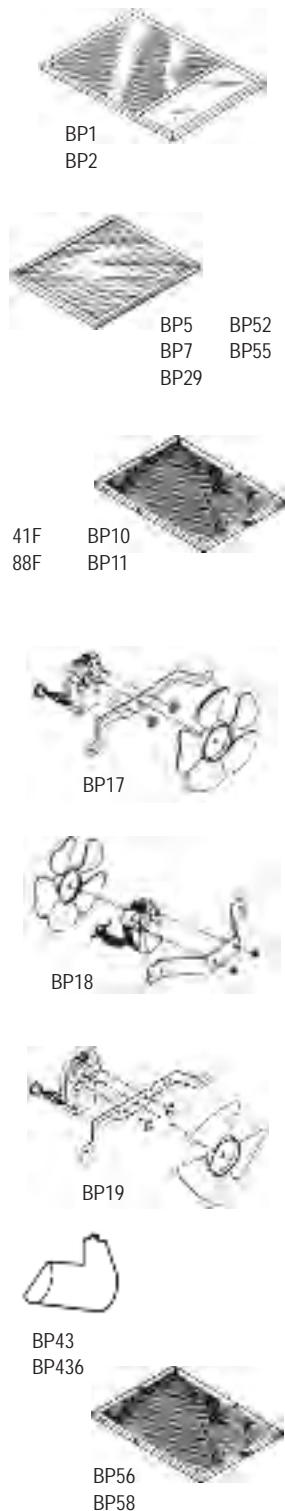

Model No.	Description	Std. Pk.	List Price	Code
BP1	Aluminum Filter with Light Lens (11-3/4" x 13-7/16")	15 *	\$17.14	AC
BP2	Aluminum Filter with Light Lens (10-1/8" x 16-9/16")	12 *	\$17.14	AC
BP4	Aluminum Filter (10-1/2" Diameter)	12 *	\$9.34	AC
BP5	Aluminum Filter (8-5/8" x 11")	4 *	\$9.44	AC
BP7	Aluminum Filter (10-3/8" x 11-3/8")	8 *	\$9.44	AC
BP10	Non-ducted Filter (8" x 9-1/2")	8 *	\$15.30	AC
BP11	Non-ducted Filter (8-5/8" x 10")	8 *	\$17.14	AC
BP17	Fan Assembly — Hood (40000 Series)	4 *	\$43.42	AC
BP18	Fan Assembly — Hood (42000 Series)	4 *	\$43.42	AC
BP19	Fan Assembly — Hood (41000 Series)	4 *	\$43.42	AC
BP29	Aluminum Filter (8-3/4" x 10-1/2")	6 *	\$9.34	AC
BP43	Light Lens — Hood (40000, 41000, 42000 and others) in display box	12 *	\$7.02	AC
BP436	Light Lens — Hood (40000, 41000, 42000 and others) in standard carton	6 *	\$7.02	AC
BP52	Motor/Blade (M2T, MK2T, M4T, V20, V25, V26 and V26N)	4 *	\$47.66	AC
BP55	Aluminum Filter (8" x 9-1/2")	8 *	\$9.34	AC
BP56	Non-ducted Filter (8" x 9-1/2")	8 *	\$17.14	AC
BP57	11-3/8" x 11-3/4" Washable Aluminum and Charcoal Filter with light lens. Master pack contains 8 filters. (SR610050 — Single Pack.)	8 *	\$16.50	AC
BP58	Replacement Charcoal Filter Pack. Each pack contains three 7-3/4" x 10-1/2" pads. Master pack contains 8 filter packs. (SR610051 — Single Pack)	8 *	\$11.58	AC
BP87	7" Damper for round discharge range hood. (S97010792 — Single Pack)	3 *	\$11.46	AC
BPAPFA	Replacement grease filters with antimicrobial protection (3 Pack/2 Filters per Pack)	3 *	\$51.62	AC
BPPF30	Non-duct Filters for QP130, QP230 and QP330	6 *	\$29.82	QA
BPPF36	Non-duct Filters for QP136, QP236 and QP336	3 *	\$32.24	QA
BPPF42	Non-duct Filter for QP142, QP242 and QP342	1	\$38.92	QA
BPPFA30	Replacement QP130 aluminum grease filters	3 *	\$53.70	QA
BPPFA36	Replacement QP136 aluminum grease filters	3 *	\$60.86	QA
BPPFA42	Replacement QP142 aluminum grease filter	1	\$68.18	QA
BPP2FA30	Replacement QP230 aluminum grease filter	1	\$56.82	QA
BPP2FA36	Replacement QP236 aluminum grease filter	1	\$68.18	QA
BPP2FA42	Replacement QP242 aluminum grease filter	1	\$85.26	QA
BPP3FA30	Replacement QP330 aluminum grease filter	1	\$71.60	QA
BPP3FA36	Replacement QP336 aluminum grease filter	1	\$82.96	QA
BPP3FA42	Replacement QP342 aluminum grease filter	1	\$100.00	QA
BQDE30	Aluminum replacement grease filters for QDE30 Series (3 Pack)	3 *	\$57.82	AC
BPQTAF	Aluminum Grease Filters (99010316 — Single Pack)	4 *	\$9.40	AC
BPQTF	Non-ducted Filters (99010317 — Single Pack)	4 *	\$11.80	AC
BPRPFA	Replacement grease filters (3 Pack/2 Filters per Pack) (S97017455 — Single Pack)	3 *	\$23.24	AC

● Item too large to ship via UPS/FedEx. Item shipped common carrier at minimum rates.
 * All pricing reflects the individual item cost. You must order in multiples as indicated.
 ◆ UL listed for use over bathtubs and showers when connected to a GFCI protected branch circuit.

Broan – NuTone Hood Replacement Parts CONTINUED

Model No.	Description	Std. Pk.	List Price	Code
BPS1FA30	Aluminum Replacement Range Hood Filters for use with 30" QS I and WS I Series Allure Hoods. Each pack contains 2 filters.	3 *	\$27.60	AC
BPS1FA36	Aluminum Replacement Range Hood Filters for use with 36" QS I and WS I Series Allure Hoods. Each pack contains 2 filters.	3 *	\$30.22	AC
BPS2FA30	Aluminum Replacement Range Hood Filters for use with 30" QS II and WS II Series Allure Hoods. Each pack contains 2 filters.	6 *	\$40.44	AC
BPS2FA36	Aluminum Replacement Range Hood Filters for use with 36" QS II and WS II Series Allure Hoods. Each pack contains 2 filters.	6 *	\$44.88	AC
BPS3FA30	Aluminum Replacement Range Hood Filters for use with 30" QS III and WS III Series Allure Hoods. Each pack contains 2 filters.	6 *	\$61.84	AC
BPS3FA36	Aluminum Replacement Range Hood Filters for use with 36" QS III and WS III Series Allure Hoods. Each pack contains 2 filters.	6 *	\$69.20	AC
BPSF30	Range Hood Filters for non-duct 30" QS and WS Series Allure Hoods. Each pack contains 2 filters.	4 *	\$31.52	AC
BPSF36	Range Hood Filters for non-duct 36" QS and WS Series Allure Hoods. Each pack contains 2 filters.	4 *	\$33.70	AC
BPSF42	Range Hood Filters for non-duct 42" QS and WS Series Allure Hoods. Each pack contains 2 filters.	8 *	\$36.22	AC
FILTERE56	Non-ducted Filter	1	\$57.56	AC
FILTEREB40	Replacement non-ducted charcoal filter for RMP17004 and RM50000	1	\$93.42	HA
FILTER SQUARE	Replacement non-ducted charcoal filter	1	\$59.44	HA
ROUND FILTER	Replacement non-ducted charcoal filter (for 613004 and 619004)	1	\$97.14	HA
41F	Replacement non-ducted filters for 11000, 41000, 46000, ACS, F40000, RL6200, RL6200FH, SL6200H and SM6500R	6 *	\$17.42	AC
88F	Replacement non-ducted filter for 88000, AP1 and RP2 Series. Master Pack contains 6 pairs of filters (S97007662 — Single Pack).	6 *	\$32.30	AC

● Item too large to ship via UPS/FedEx. Item shipped common carrier at minimum rates.

* All pricing reflects the individual item cost. You must order in multiples as indicated.

◆ UL listed for use over bathtubs and showers when connected to a GFCI protected branch circuit.

Accessories — Hood and Fan

Broan – NuTone Roof Caps

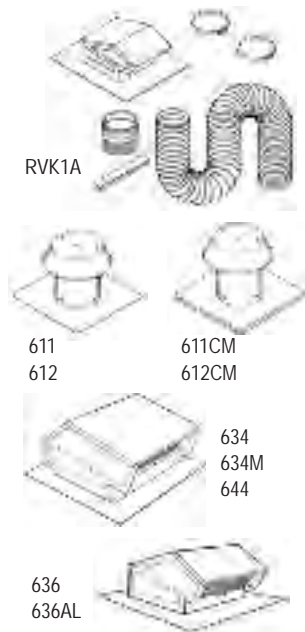

Model No.	Description	Std. Pk.	List Price	Code
437	High Capacity Roof Cap — up to 1200 CFM. Black.	1	\$192.06	AC
611	Aluminum Roof Cap for flat roofs. Up to 8" round duct. Natural finish.	1	\$90.64	AC
611CM	Aluminum Roof Cap for flat roofs. For curb mount installation. Up to 8" round duct. Natural finish.	1	\$120.12	AC
612	Aluminum Roof Cap for flat roofs. Up to 12" round duct. Natural finish.	1	\$155.42	AC
612CM	Aluminum Roof Cap for flat roofs. For curb mount installation. Up to 12" round duct. Natural finish.	1	\$169.90	AC
634	Steel Roof Cap for 3-1/4" x 10" or up to 8" round duct. Black.	1	\$51.74	AC
634M	Steel Roof Cap for 6" round duct. Includes damper and birdscreen. Black. (Not recommended for range hoods.)	1	\$60.34	AC
636	Steel Roof Cap for 3" or 4" round duct. Black.	1	\$29.62	AC
636AL	Same as Model 636 except aluminum. Natural finish.	1	\$38.36	AC
644	Same as Model 634 except aluminum. Natural finish.	1	\$66.92	AC
DC4	4" Duct Collar. For use with Models 636/636AL for easy attachment of 4" round duct.	6 *	\$7.52	AC
RVK1A	Roof Vent Kit, 8' of 4" flexible aluminum duct. Model 636 Roof Cap, 4" to 3" reducer, 4" dia. connector, (2) 4" dia. clamps.	1	\$71.72	AC

Broan – NuTone Transitions

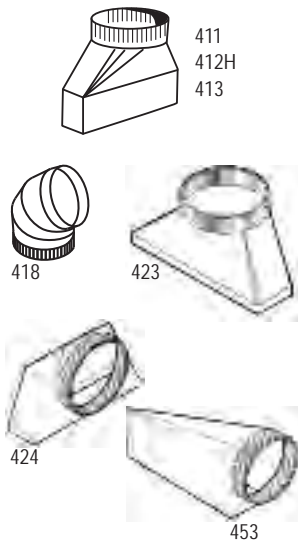

Model No.	Description	Std. Pk.	List Price	Code
411	3-1/4" x 10" to 6" Round Transition	1	\$28.00	AC
412H	3-1/4" x 10" to 7" Round Transition	1	\$30.14	AC
413	3-1/4" x 10" to 8" Round Transition	1	\$34.24	AC
414	8" to 10" Expander	1	\$50.98	AC
418	10" Adjustable Elbow	1	\$43.28	AC
423	Vertical Transition — 4-1/2" x 18-1/2" to 10" round	1	\$70.56	AC
424	Rear Transition — 4-1/2" x 18-1/2" to 10" round	1	\$87.86	AC
427	4-1/2" x 18-1/2" to 10" Round Transition (thin wall)	1	\$76.34	AC
453	■ Horizontal Left Transition — 4-1/2" x 18-1/2" to 10" round (right end boot)	1	\$103.26	AC
454	■ Horizontal Right Transition — 4-1/2" x 18-1/2" to 10" round (left end boot)	1	\$103.26	AC
459	■ 3-1/4" x 14" to 8" Round Transition	1	\$46.52	AC
475	6" to 4" duct reducer (Single pack)	1	\$10.40	AC
475B	6" to 4" duct reducer (6 pack)	6 *	\$7.64	AC
877	6" to 3-1/4" x 10"	1	\$32.14	AC
T457	7" to 5" duct reducer	1	\$26.00	AC
T460	Transition; 3-1/4" x 14" to 7" Round	1	\$34.90	AC
T461	Adapter, 3-1/4" x 14" to 3-1/4" x 10"	1	\$45.24	AC
T486	8" to 6" duct reducer	1	\$31.30	AC
T487	8" to 7" duct reducer	1	\$33.32	AC
T81212	Duct Transition — 8" x 12" to 12" rd. for 900 & 1500 CFM models	1	\$71.60	AC

■ Limited quantities available.

- Item too large to ship via UPS/FedEx. Item shipped common carrier at minimum rates.
- * All pricing reflects the individual item cost. You must order in multiples as indicated.
- ◆ UL listed for use over bathtubs and showers when connected to a GFCI protected branch circuit.

Accessories — Hood and Fan

Broan – NuTone Dampers

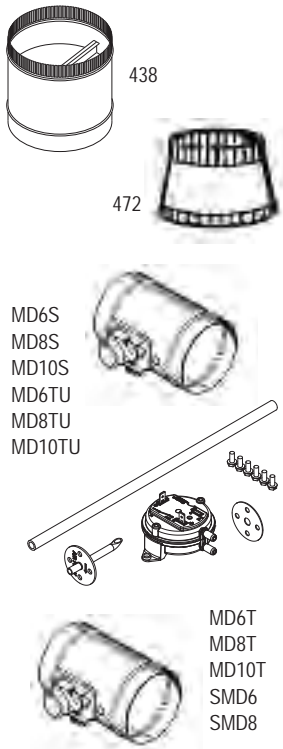

Model No.	Description	Std. Pk.	List Price	Code
97	7" Spring-loaded Damper	1	\$37.08	AC
421	10" Vertical discharge in-line damper	1	\$47.82	AC
438	8" Horizontal or vertical discharge in-line damper	1	\$41.22	AC
472	10" to 8" Reducer-damper, use with Model 504 (includes damper)	1	\$50.60	AC
804DD	■ 4" Diameter Galvanized Metal Duct Collar with Damper	1	\$17.20	AC
BP87	■ 7" Damper for round discharge range hood. (S97010792 — Single Pack)	3 *	\$11.46	AC
BP87Q	7" Damper for round discharge range hood. (S97018803 — Single Pack)	3 *	\$18.42	AC
MD6S	6" Make-up air slave damper (Damper Only)	1	\$171.86	HA
MD6T	6" Automatic make-up air damper	1	\$174.86	HA
MD6TU	6" Universal automatic make-up air damper with pressure sensor kit. Also works with ULTRA and QT Series fans if at least 80 CFM and used with 6" rigid duct.	1	\$244.00	HA
MD8S	8" Make-up air slave damper (Damper Only)	1	\$193.08	HA
MD8T	8" Automatic make-up air damper	1	\$188.30	HA
MD8TU	8" Universal automatic make-up air damper with pressure sensor kit	1	\$265.22	HA
MD10S	10" Make-up air slave damper (Damper Only)	1	\$297.06	HA
MD10T	10" Automatic make-up air damper	1	\$307.66	HA
MD10TU	10" Universal automatic make-up air damper with pressure sensor kit	1	\$350.10	HA
SMD6	6" LinkLogic automatic make-up air damper	1	\$281.36	HA
SMD8	8" LinkLogic automatic make-up air damper	1	\$296.16	HA

■ Limited quantities available.

Broan – NuTone Wall Caps

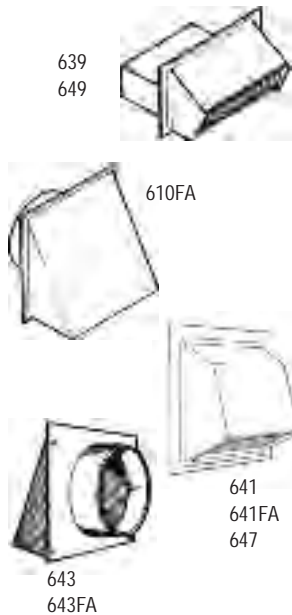

Model No.	Description	Std. Pk.	List Price	Code
441	Aluminum Wall Cap with gravity damper for 10" round duct	1	\$102.12	AC
610FA	10" Aluminum Fresh Air Inlet Wall Cap	1	\$135.80	AC
613	Aluminum Wall Cap for 12" round duct. Natural finish.	1	\$98.62	AC
639	Steel Wall Cap for 3-1/4" x 10" duct. Black.	1	\$34.86	AC
641	Aluminum Wall Cap for 6" round duct (includes damper and birdscreen). Natural finish.	1	\$71.04	AC
641FA	Aluminum Fresh Air Inlet Wall Cap for 6" round duct	1	\$57.22	AC
642	4" Round Aluminum Wall Cap	4 *	\$27.04	AC
643	Aluminum Wall Cap for 8" round duct. Natural finish.	1	\$89.52	AC
643FA	Aluminum Fresh Air Inlet Wall Cap for 8" round duct	1	\$84.10	AC
646	Plastic Louvered Wall Cap for 6" duct. White.	1	\$48.14	AC
647	Wall Cap. Same as Model 641 except for 7" round duct.	1	\$80.22	AC
649	Wall Cap. Same as Model 639 except aluminum. Natural finish.	1	\$45.08	AC
843BL	Wall Cap (black) for 6" round duct	1	\$54.50	AC
885AL	Wall Cap (aluminum) for 3" and 4" round duct	6 *	\$39.60	AC
885BL	Wall Cap (steel — black finish) for 3" and 4" round duct	6 *	\$31.28	AC
885NS	Wall Cap for 3" and 4" round duct (no birdscreen). Steel - black finish.	6 *	\$30.94	AC

● Item too large to ship via UPS/FedEx. Item shipped common carrier at minimum rates.

* All pricing reflects the individual item cost. You must order in multiples as indicated.

◆ UL listed for use over bathtubs and showers when connected to a GFCI protected branch circuit.

Accessories — Hood and Fan

Broan – NuTone Wall Caps CONTINUED

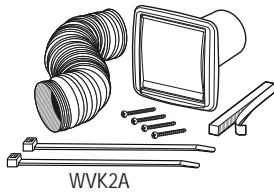

Model No.	Description	Std. Pk.	List Price	Code
BD4	Pressure Relief Damper with Wall Cap and 4" collar.	1	\$83.98	AQ
BD6	Pressure Relief Damper with Wall Cap and 6" collar.	1	\$83.98	AQ
WC638	Wall Cap — 3-1/4" x 14", Black.	1	\$95.00	AC
WC650	4" Wall Cap for 4" round duct. Includes 4" diameter metal duct connector and four mounting screws.	4 *	\$20.78	AC
WVK2A	Wall Ducting Kit — 5' of 4" diameter flexible foil duct, white wall cap for 4" round duct, 3" to 4" duct adapter, 2 nylon zip ties and mounting screws.	1	\$34.94	AC

Broan – NuTone 24" Duct Sections

Prices shown are for one complete 2' section.

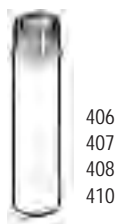

Model No.	Description	Std. Pk.	List Price	Code
406	6" Round Duct	5 *	\$23.10	AC
407	7" Round Duct	5 *	\$23.84	AC
408	8" Round Duct	1	\$26.00	AC
410	10" Round Duct	5 *	\$30.78	AC
804DU	4" Insulated Flexible Duct (25 ft.)	1	\$71.62	AC
889	3-1/4" x 10" Duct (5 Pieces)	5 *	\$29.32	AC
DT6W	6" Insulated Duct (25 ft.)	1	\$100.32	AC

Broan – NuTone Elbows

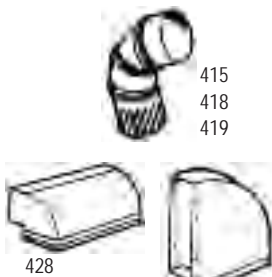

Model No.	Description	Std. Pk.	List Price	Code
415	7" Adjustable Elbow	4 *	\$17.90	AC
418	10" Adjustable Elbow	1	\$43.28	AC
419	6" Adjustable Elbow	1	\$18.92	AC
428	3-1/4" x 10" Vertical Elbow	1	\$35.64	AC
429	3-1/4" x 10" Horizontal Elbow	1	\$47.82	AC
430	Short Eave Elbow for 3-1/4" x 10" duct with backdraft damper and grille	1	\$62.18	AC
431	Long Eave Elbow for 3-1/4" x 10" duct with backdraft damper and grille	1	\$62.40	AC
432	8" Round Elbow	1	\$31.30	AC

Broan – NuTone Hanger Bars

Model No.	Description	Std. Pk.	List Price	Code
QTHB1	One set of hanger bars for QTR Series	1	\$18.70	AC

- Item too large to ship via UPS/FedEx. Item shipped common carrier at minimum rates.
- * All pricing reflects the individual item cost. You must order in multiples as indicated.
- ◆ UL listed for use over bathtubs and showers when connected to a GFCI protected branch circuit.

Accessories — Decorator Wall Mounted Controls

Broan® Decorator Wall Mounted Controls

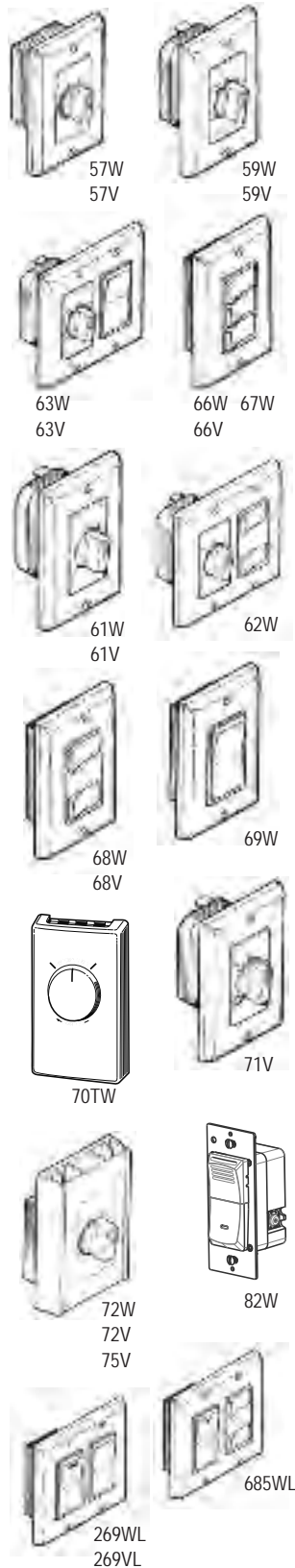

Model No.	Description	Std. Pk.	List Price	Code
57V / 57W	Electronic Variable Speed Control, 3 amp capacity. 120V. Fits single gang box.	1	\$46.64	AC
59V / 59W	60 Minute Time Control, with "continuous on" feature. Fits single gang box.	1	\$60.34	AC
61V / 61W	15 Minute Time Control, no "continuous on" feature. Fits single gang box.	1	\$60.34	AC
62W	60 Minute Time Control with two rocker switches. Fits two-gang box.	1	\$89.52	AC
63V / 63W	60 Minute Time Control with one rocker switch. Fits two-gang box.	1	\$79.94	AC
64V / 64W	Fan/Light Control with off delay. Requires hot and neutral wires in switch box. Fits single gang box.	1	\$115.84	AC
66V / 66W	Three-Function Control. Fits single gang opening.	1	\$38.22	AC
67W	Three-Function Control with polished chrome finish metal wall plate. Fits single gang opening.	1	\$41.40	AC
68V / 68W	Two-Function Control. Fits single gang box.	1	\$31.04	AC
69W	Single Gang Control. One smooth action on/off rocker switch. Fits single gang box.	1	\$12.84	AC
70TW	Fan Thermostat, 22 amp capacity; 120, 250 and 277 VAC	1	\$66.14	AC
71V	12 hour timer automatically turns the ventilator off at a time selected within a 12 hour period. Ivory.	1	\$63.56	AC
72V / 72W	Electronic Variable Speed Control, 6 amp capacity. 120V. Fits single gang box. Suitable for use with 331H, 332H, 335, 336, HLB3, HLB6, HLB9 and HLB11.	1	\$84.92	AC
75V	Electronic Variable Speed Control. Same as 72W/V, except 240V.	1	\$86.52	AC
82W	Premium Humidity Control with Sensaire technology that senses rapid rise in humidity. Also includes duty cycle timer. Fits in single gang box. (White)	1	\$101.30	AC
90	Thermostat Kit. Used to install built-in thermostat in Model 114 kickspace heater. Snap action, bi-metallic, effective temperature range of 40 – 130° F.	1	\$57.84	AC
277V	Electronic Variable Speed Control, 277V, 6A — Ivory. For models with "C" suffix.	1	\$91.60	AC
77DV / 77DW	Three-Function Control for use with sensing Fan/Lights (top switch provides three settings for sensor On/Auto/Off), remaining switches control light, night light and QT Heater/Fan/Light/Night Light (top switch controls light and night light, remaining switches control fan and heater).	1	\$44.60	AC
269VL / 269WL	Two-Function, Two-Gang Control. Two separate smooth action on/off rocker switches — one with pilot light which glows when power is on.	1	\$47.28	AC
685WL	Three-Function, Two-Gang Control. One smooth action on/off rocker switch with pilot light which glows when power is on — one two-function control with separate on/off switches.	1	\$68.16	AC
CFT12WH	12-Hour Timer (White)	1	\$69.40	AC
VS63WH	15 Min. Timer Switch (White)	1	\$68.00	AC
VS66WH	60 Min. Timer/1 On/Off Switch (White)	1	\$86.88	AC
VS67WH	60 Min. Timer/2 On/Off Switches (White)	1	\$125.72	AC
VS68WH	15 Min. Timer/1 On/Off Switch (White)	1	\$86.88	AC
VS69WH	15 Min. Timer/2 On/Off Switches (White)	1	\$125.72	AC
S990712044	Function Labels for two-, three- and four-function wall decorator controls. Easily applied peel-off labels cover HEAT/VENT/LIGHT/NIGHT LIGHT ON/OFF/AUTO functions.	1	\$0.64	PT

W = WHITE decorator style; V = IVORY decorator style.

- Item too large to ship via UPS/FedEx. Item shipped common carrier at minimum rates.
- * All pricing reflects the individual item cost. You must order in multiples as indicated.
- ◆ UL listed for use over bathtubs and showers when connected to a GFCI protected branch circuit.

Accessories — Decorator Wall Mounted Controls

Broan® Decorator Wall Controls / “Blister Packs”

Packaged in see-through “blister packs” for pegboard mounting. Ideal for displays in showrooms to help stimulate sales.



P57W



P59W
P59V

Model No.	Description	Std. Pk.	List Price	Code
P57W	Electronic Variable Speed Control, 3 amp capacity. Fits single gang box.	4 *	\$48.72	AC
P59V / P59W	60 Minute Time Control with “continuous on” feature. Fits single gang box.	4 *	\$78.12	AC
P66V / P66W	Three-Function Control. Fits single gang opening.	4 *	\$40.70	AC
P68W	Two-Function Control. Fits single gang box.	4 *	\$33.48	AC
P685WL	Two-Gang Control. One smooth action on/off rocker switch with pilot light which glows when power is on — one two-function control with separate on/off switches. Fits two-gang box.	4 *	\$71.24	AC

W = WHITE decorator style; V = IVORY decorator style.

Attic Ventilators — Powered

Broan® 28W Solar Powered Attic Ventilators

Remove heat from the attic in summer, help prevent moisture and ice dams in the winter without using any electricity! Energy saving solar powered attic ventilators also reduce energy costs by reducing running time of air conditioners. Easy retrofit can easily replace standard powered attic ventilators.

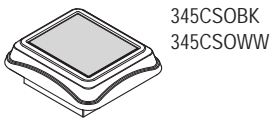

345CSOBK
345CSOWW



345GOBK
345GOWW

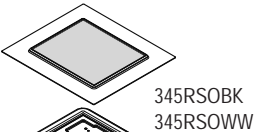

345RSOBK
345RSOWW

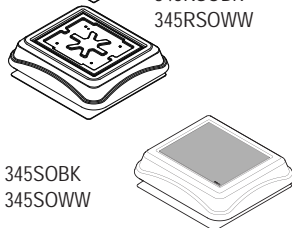

345SOBK
345SOWW

Model No.	Description	Std. Pk.	List Price	Code
345CSOBK	Solar PAV, curb mount, black	1	\$562.28	SO
345CSOWW	Solar PAV, curb mount, weathered wood	1	\$562.28	SO
345GOBK	Solar PAV, gable mount, black	1	\$562.28	SO
345GOWW	Solar PAV, gable mount, weathered wood	1	\$562.28	SO
345RSOBK	Solar PAV, remote mount, black	1	\$598.34	SO
345RSOWW	Solar PAV, remote mount, weathered wood	1	\$598.34	SO
345SOBK	Solar PAV, surface mount, black	1	\$562.28	SO
345SOWW	Solar PAV, surface mount, weathered wood	1	\$562.28	SO
CWT45	Thermostat for Solar PAVs	1	\$42.44	SO

Broan® Roof Mount Powered Attic Ventilators

High performance 14" wing blade. Thermally protected motor. Includes wiring box with a built-in adjustable thermostat. Easy to install.



Model No.	Description	Std. Pk.	List Price	Code
349BR	1000 CFM, Brown Powder-Coated Steel Dome	1	\$257.54	HV
350BK	1050 CFM Attic Ventilator with black PVC dome	1	\$222.86	HV
350BR	1050 CFM Attic Ventilator with brown PVC dome	1	\$229.14	HV
355BK	1000 CFM Attic Ventilator with black PVC dome	1	\$236.16	HV
355BR	1000 CFM Attic Ventilator with brown PVC dome	1	\$242.44	HV
356BK	1600 CFM Attic Ventilator with black PVC dome	1	\$307.68	HV
356BR	1600 CFM Attic Ventilator with brown PVC dome	1	\$313.98	HV
358	1000 CFM Attic Ventilator with aluminum dome	1	\$273.48	HV

- Item too large to ship via UPS/FedEx. Item shipped common carrier at minimum rates.
- * All pricing reflects the individual item cost. You must order in multiples as indicated.
- ◆ UL listed for use over bathtubs and showers when connected to a GFCI protected branch circuit.

Attic Ventilators — Powered

Broan® Gable Mount Powered Attic Ventilator



Outstanding performance from an inside-the-attic gable mounted unit. Designed to discharge hot attic air through existing 14" x 14" minimum or comparable louver in gable wall. High performance 14" wing blade. Thermally protected motor. Includes wiring box with a built-in adjustable thermostat. Easy to install.

Model No.	Description	Std. Pk.	List Price	Code
353	1020 CFM Gable Mount Ventilator (use with Broan Model 433 shutter — Sold separately, see below)	1	\$152.26	HV
35316	1600 CFM Gable Mount Ventilator (use with Broan Model 433 shutter — Sold separately, see below)	1	\$230.24	HV

Broan® Automatic Shutter for Gable Mount Attic Ventilators



Precision built automatic wall shutter. Designed to be used with Broan Models 353 and 35316 Gable Mount Powered Attic Ventilators or Broan Models 345GOBK and 345GOWW Gable Mount Solar Powered Attic Ventilators. Aluminum vanes automatically open when ventilator turns on and are counter-balanced for easy opening; close when air flow ceases. Steel reinforced for strength, weather-tight closure. Easy to install.

Model No.	Description	Std. Pk.	List Price	Code
433	Automatic Shutter	1	\$82.22	AC

Broan® Powered Attic Ventilator Accessories

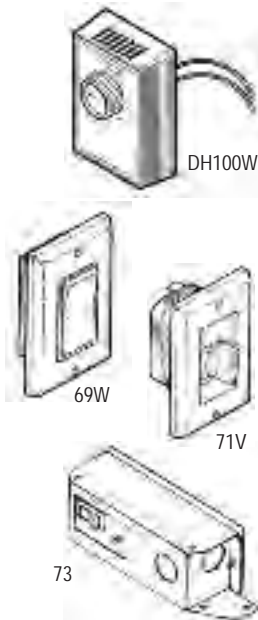

Model No.	Description	Std. Pk.	List Price	Code
DH100W	Dehumidistat, 24V/120V. (For use with all Broan powered attic ventilators — sold separately.)	1	\$47.54	AC
69W	Single Gang Control. One smooth action on/off rocker switch. Fits single gang box.	1	\$12.84	AC
71V	12 hour timer automatically turns the ventilator off at a time selected within a 12 hour period. Ivory.	1	\$63.56	AC
73	High temperature cut-off control automatically shuts off the PAV in the event of a high temperature condition (above 204° F.) Also includes a safety on/off switch to prevent fan from starting when cleaning or servicing.	1	\$44.84	AC

Broan® Powered Attic Ventilator Replacement Accessories

Model No.	Description	Std. Pk.	List Price	Code
RFTH95	Automatic, adjustable thermostat replacement part for NuTone powered attic ventilators.	1	\$22.30	AC

- Item too large to ship via UPS/FedEx. Item shipped common carrier at minimum rates.
- * All pricing reflects the individual item cost. You must order in multiples as indicated.
- ◆ UL listed for use over bathtubs and showers when connected to a GFCI protected branch circuit.

Ceiling Fans

NuTone® Standard Series Ceiling Fans — For Indoor Use Only

Accepts all NuTone light kits. Includes 4" and 6" downrods — additional lengths sold separately. ENERGY STAR certified with 30 year limited warranty. Pull chain operation. Wall and remote control sold separately.

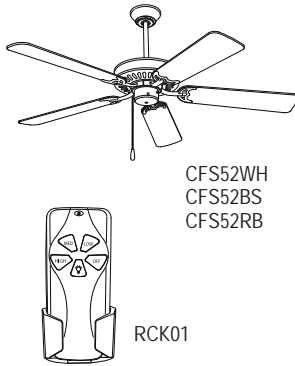

Model No.	Description	Std. Pk.	List Price	Code
CFS52WH	■ 52" Ceiling Fan — Standard Series, White. Dual Finish Blades; Polished White/White Oak.	1	\$133.70	PF
CFS52BS	■ 52" Ceiling Fan — Standard Series, Brushed Steel. Dual Finish Blades; Dark Cherry/Light Oak.	1	\$138.20	PF
CFS52RB	■ 52" Ceiling Fan — Standard Series, Oil Rubbed Bronze. Dual Finish Blades; Dark Cherry/Medium Cherry.	1	\$139.96	PF
RCK01	■ Hand Held Remote Control Transmitter and Receiver. Works with Standard Series only.	1	\$52.96	PA

■ Limited quantities available.



All models are ENERGY STAR certified products.

NuTone® Hugger Series Ceiling Fans — For Indoor Use Only

Accepts NuTone light kits. Designed to mount flush with ceiling; only 7" between ceiling and blades. Pull chain operation. Wall control sold separately.

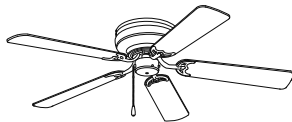

Model No.	Description	Std. Pk.	List Price	Code
CFH52WH	■ 52" Ceiling Fan — Hugger Series, White. Dual Finish Blades; Polished White/White Oak.	1	\$167.14	PF
CFH52BS	■ 52" Ceiling Fan — Hugger Series, Brushed Steel. Dual Finish Blades; Dark Cherry/Light Oak.	1	\$173.78	PF
CFH52RB	■ 52" Ceiling Fan — Hugger Series, Oil Rubbed Bronze. Dual Finish Blades; Dark Cherry/Medium Cherry.	1	\$173.78	PF

■ Limited quantities available.

NuTone® Outdoor Series Ceiling Fans

Wet rated for outdoor use. Accepts NuTone light kits damp rated for outside use. Includes 4" and 6" downrods. Additional lengths sold separately. ENERGY STAR certified with 30 year limited warranty. Pull chain operation. Wall control sold separately.

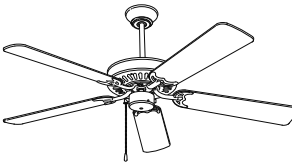

Model No.	Description	Std. Pk.	List Price	Code
CFO52WH	■ 52" Ceiling Fan — Outdoor Wet Rated, White. Dual Finish, All Weather Blades; Polished White/White Oak.	1	\$196.40	PF
CFO52BQ	■ 52" Ceiling Fan — Outdoor Wet Rated, Barbeque Black. Single Finish, All Weather Blades; Dark Ash.	1	\$207.42	PF
CFO52WB	■ 52" Ceiling Fan — Outdoor Wet Rated, Weathered Bronze. Dual Finish, All Weather Blades; Light Oak/Dark Cherry.	1	\$189.76	PF

■ Limited quantities available.



All models are ENERGY STAR certified products.

- Item too large to ship via UPS/FedEx. Item shipped common carrier at minimum rates.
- * All pricing reflects the individual item cost. You must order in multiples as indicated.
- ◆ UL listed for use over bathtubs and showers when connected to a GFCI protected branch circuit.

Ceiling Fans

NuTone® Commercial Series Ceiling Fans

Engineered to withstand harsh warehouse applications. Designed for year-round energy efficiency. In winter, fans help lower costs by recirculating trapped heat at the ceiling. In summer, specially designed contoured blades provide maximum air flow for improved comfort.

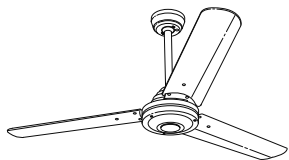

Model No.	Description	Std. Pk.	List Price	Code
CFC56WH	■ 56" Commercial Ceiling Fan — White. Single Finish Commercial Grade Contoured White Blades.	1	\$194.20	PF
CFC56BR	■ 56" Commercial Ceiling Fan — Brown. Single Finish Commercial Grade Contoured Brown Blades.	1	\$194.20	PF

■ Limited quantities available.

NuTone® Light Kits

For the greatest energy savings, 13W CFL bulbs are included. Each NuTone light kit also accepts 40W incandescent bulbs (sold separately).

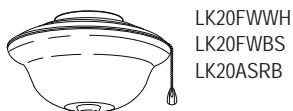

LK20FWWH
LK20FWBS
LK20ASRB

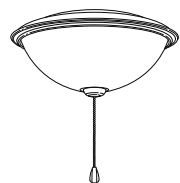

LK30AWH
LK30ABS
LK30ARB

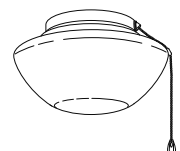

LK50DWH
LK50DWB
LK50DBQ

FOR OUTDOOR USE

Model No.	Description	Std. Pk.	List Price	Code
LK20FWWH	■ Light Kit, Traditional Bowl, Frosted White Glass, White Trim, (2) 13W CFL bulbs included	1	\$92.68	PA
LK20FWBS	■ Light Kit, Traditional Bowl, Frosted White Glass, Brushed Steel Trim, (2) 13W CFL bulbs included	1	\$93.44	PA
LK20ASRB	■ Light Kit, Traditional Bowl, Amber Scavo Glass, Oil-Rubbed Bronze Trim, (2) 13W CFL bulbs included	1	\$92.12	PA
LK30AWH	■ Light Kit, Contemporary Bowl, Alabaster Glass, White Trim, (2) 13W CFL bulbs included	1	\$92.68	PA
LK30ABS	■ Light Kit, Contemporary Bowl, Alabaster Glass, Brushed Steel Trim, (2) 13W CFL bulbs included	1	\$93.44	PA
LK30ARB	■ Light Kit, Contemporary Bowl, Alabaster Glass, Oil-Rubbed Bronze Trim, (2) 13W CFL bulbs included	1	\$94.32	PA
LK50DWH	■ Light Kit, Outdoor, Damp-Rated, White Trim, (1) 13W CFL bulb included	1	\$61.78	PA
LK50DWB	■ Light Kit, Outdoor, Damp-Rated, Weathered Bronze Trim, (1) 13W CFL bulb included	1	\$61.78	PA
LK50DBQ	■ Light Kit, Outdoor, Damp-Rated, BBQ Black Trim, (1) 13W CFL bulb included	1	\$61.78	PA

■ Limited quantities available.

NuTone® Turtle Fitters and Glass

Four arm fitters let you personalize your fan with your choice of 2-1/4" decorative glass. For the greatest energy savings, 13W CFL bulbs are included. Each NuTone fitter also accepts 40W medium base candelabra bulbs (sold separately).

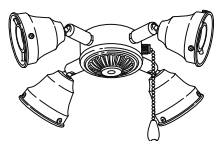

TF40WH
TF40BS
TF40RB



TF40GAP TF40GFW TF40GCL

Model No.	Description	Std. Pk.	List Price	Code
TF40WH	■ Turtle Fitter, White. Includes (4) 13W Compact Fluorescent Bulbs.	1	\$62.34	PA
TF40BS	■ Turtle Fitter, Brushed Steel. Includes (4) 13W Compact Fluorescent Bulbs.	1	\$63.44	PA
TF40RB	■ Turtle Fitter, Oil Rubbed Bronze. Includes (4) 13W Compact Fluorescent Bulbs.	1	\$63.44	PA
TF40GAP	■ Glass for Turtle Fitter, Amber Parchment (Set of 4)	1	\$76.68	PA
TF40GFW	■ Glass for Turtle Fitter, Frosted White (Set of 4)	1	\$62.90	PA
TF40GCL	■ Glass for Turtle Fitter, Clear Cut Glass (Set of 4)	1	\$61.24	PA

■ Limited quantities available.

- Item too large to ship via UPS/FedEx. Item shipped common carrier at minimum rates.
- * All pricing reflects the individual item cost. You must order in multiples as indicated.
- ◆ UL listed for use over bathtubs and showers when connected to a GFCI protected branch circuit.

NuTone® Slope Adapters

Model No.	Description	Std. Pk.	List Price	Code
CFSABR ■	Brown	1	\$15.32	PA
CFSABS ■	Brushed Steel	1	\$15.76	PA
CFSARB ■	Oil-Rubbed Bronze	1	\$16.64	PA
CFSAWH ■	White	1	\$15.32	PA

■ Limited quantities available.

NuTone® Downrods

NuTone ceiling fans include both a 4" and 6" downrod*. Choose from an assortment of 12" to 48" lengths, all 13/16" diameter.

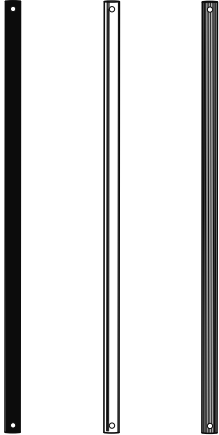

Model No.	Description	Std. Pk.	List Price	Code
DR12WH ■	12" Downrod, White	1	\$9.04	PA
DR18WH ■	18" Downrod, White	1	\$11.04	PA
DR24WH ■	24" Downrod, White	1	\$14.24	PA
DR36WH ■	36" Downrod, White	1	\$19.10	PA
DR48WH ■	48" Downrod, White	1	\$26.36	PA
DR36BS ■	36" Downrod, Brushed Steel	1	\$32.54	PA
DR48BS ■	48" Downrod, Brushed Steel	1	\$39.16	PA
DR12RB ■	12" Downrod, Oil-Rubbed Bronze	1	\$15.66	PA
DR18RB ■	18" Downrod, Oil-Rubbed Bronze	1	\$21.74	PA
DR24RB ■	24" Downrod, Oil-Rubbed Bronze	1	\$24.82	PA
DR36RB ■	36" Downrod, Oil-Rubbed Bronze	1	\$32.54	PA
DR48RB ■	48" Downrod, Oil-Rubbed Bronze	1	\$39.16	PA
DR24BR ■	24" Downrod, Brown	1	\$24.82	PA
DR36BR ■	36" Downrod, Brown	1	\$32.54	PA
DR48BR ■	48" Downrod, Brown	1	\$39.62	PA
DR12OWH ■	12" Downrod, Outdoor White	1	\$15.66	PA
DR12OBQ ■	12" Downrod, Outdoor Barbeque Black	1	\$15.66	PA
DR18OBQ ■	18" Downrod, Outdoor Barbeque Black	1	\$21.74	PA
DR24OBQ ■	24" Downrod, Outdoor Barbeque Black	1	\$24.82	PA
DR36OBQ ■	36" Downrod, Outdoor Barbeque Black	1	\$32.54	PA
DR12OWB ■	12" Downrod, Outdoor Weathered Bronze	1	\$15.66	PA
DR18OWB ■	18" Downrod, Outdoor Weathered Bronze	1	\$21.86	PA
DR24OWB ■	24" Downrod, Outdoor Weathered Bronze	1	\$24.82	PA
DR36OWB ■	36" Downrod, Outdoor Weathered Bronze	1	\$32.54	PA

* Excludes Hugger Series. Commercial fan contains 6" downrod only.

■ Limited quantities available.

- Item too large to ship via UPS/FedEx. Item shipped common carrier at minimum rates.
- * All pricing reflects the individual item cost. You must order in multiples as indicated.
- ◆ UL listed for use over bathtubs and showers when connected to a GFCI protected branch circuit.

Ceiling Fans

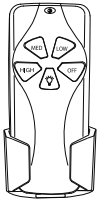

RCK01

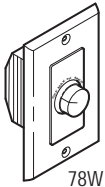

78W
78V

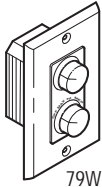

79W
79V

W = WHITE decorator style
V = IVORY decorator style

NuTone® Controls

Each NuTone fan is designed to operate with a pull chain. For added convenience, choose from our assortment of remote and wall controls*.

Model No.	Description	Std. Pk.	List Price	Code
RCK01 ■	Hand Held Remote Control Transmitter and Receiver	1	\$52.96	PA
78V / 78W ■	Four-Speed Control, 1.5 amps	1	\$49.76	PA
79V / 79W ■	Four-Speed Fan/Hi-Off-Low Light Control. For 1.5 amp Fan, 300 Watt Incandescent Light.	1	\$70.42	PA

* Commercial series does not contain pull chain and must be operated with a wall control. Remote control available for standard series only.

■ Limited quantities available.

Central Vacuum Systems

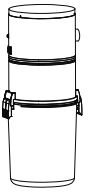

PP500

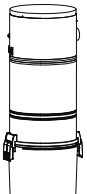

PP600



PP650

NuTone® PurePower Series Power Units

Model No.	Description	Std. Pk.	List Price	Code
PP500	NuTone PurePower 500 AW Power Unit	1	\$638.60	CX
PP600	NuTone PurePower 600 AW Power Unit	1	\$870.36	CX
PP650	NuTone PurePower 650 AW Power Unit	1	\$1,158.76	CX



NuTone® Power Units — VX Series

Model No.	Description	Std. Pk.	List Price	Code
VX1000	Power Unit — Two, Two-Stage Universal Bypass Motors, Bag Filtration	1	\$1,493.50	CX
VX1000C	Power Unit — Two, Two-Stage Universal Bypass Motors, Cyclonic	1	\$1,493.50	CX

- Item too large to ship via UPS/FedEx. Item shipped common carrier at minimum rates.
- * All pricing reflects the individual item cost. You must order in multiples as indicated.
- ◆ UL listed for use over bathtubs and showers when connected to a GFCI protected branch circuit.

Central Vacuum Systems

NuTone® Tools, Hoses, Inlets, Tubing and Fittings

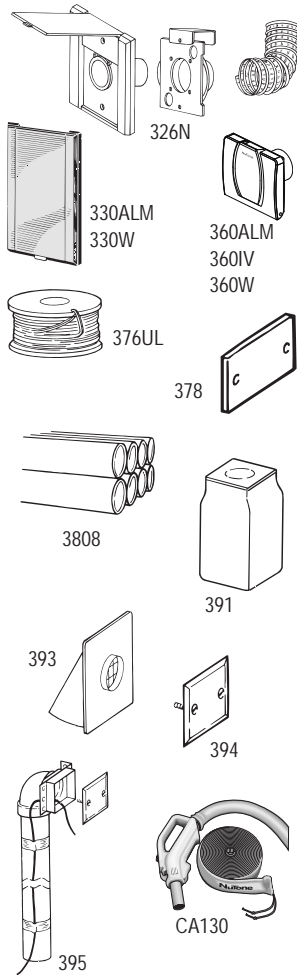

Model No.	Description	Std. Pk.	List Price	Code
326N	Existing Home Inlet Kit	1	\$68.50	CA
330ALM	Standard Inlet — Almond	1	\$8.76	CA
330W	Wall Inlet — White	1	\$8.76	CA
360ALM	Automatic Wall Inlet — Almond	1	\$20.60	CA
360IV	■ Wall Inlet — Ivory	1	\$20.60	CA
360W	Wall Inlet — White	1	\$20.60	CA
372	Standard Hose — 32' wire-reinforced vinyl	1	\$114.34	CA
376UL	Wire — 100' 18/2, UL approved	1	\$73.64	CA
378	Nail Plate	1	\$4.12	CA
3808	● 8' PVC Tubing	8 *	\$9.78	CA
3808B	● 8' PVC Tubing	440 *	\$9.78	CA
3810	10' PVC Tubing	10 *	\$11.84	CA
391	Bags — pack of three (3)	1	\$11.84	CA
392	Muffler	1	\$28.84	CA
393	Metal Wall Cap	1	\$31.94	CA
394	Blank Cover Plate — White	1	\$20.08	CA
395	Inlet Rough-In Assembly Package — for new construction	1	\$85.50	CA
3964	Three-Inlet Installation Rough-In Package	1	\$111.76	CA
CA130	Hose Sock — fits 30' - 32' hoses (comes with assembly tube)	1	\$61.80	CA
CF328	Plaster Guard — for use with Model CF329 mounting plate	1	\$2.58	CA
CF329	Inlet Mounting Plate	1	\$6.18	CA
CF361	Mounting Bracket with Plastic Guard	1	\$14.42	CA
CF361F	Mount Plate w/Flanged Spigot — for any CF382 Series elbow	1	\$20.08	CA
CF362	Flanged Ell — 90°	1	\$3.10	CA
CF363	Flanged Ell, 90° — Special for 3" walls	1	\$4.64	CA
CF364	Flanged Tee	1	\$4.64	CA
CF365	Double Flanged Tee	1	\$4.64	CA

■ Limited quantities available.

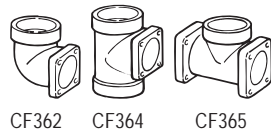
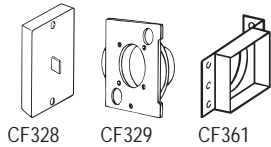

- Item too large to ship via UPS/FedEx. Item shipped common carrier at minimum rates.
- * All pricing reflects the individual item cost. You must order in multiples as indicated.
- ◆ UL listed for use over bathtubs and showers when connected to a GFCI protected branch circuit.

Central Vacuum Systems

NuTone® Tools, Hoses, Inlets, Tubing and Fittings CONTINUED

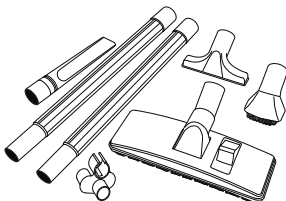
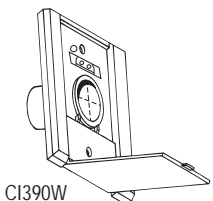
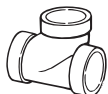
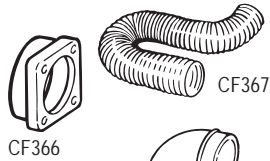

Model No.	Description	Std. Pk.	List Price	Code
CF366	Straight Flange	1	\$2.58	CA
CF367	Flexible Tubing — 36" Length	6 *	\$13.90	CA
CF368	90° Street Ell	1	\$1.76	CA
CF369	45° Street Ell	1	\$1.76	CA
CF372	Utility Inlet — White	1	\$6.18	CA
CF377	90° Sweep Ell — Long	1	\$1.76	CA
CF380	Pipe Support with Wire Clip	1	\$1.04	CA
CF382	90° Sweep Ell	1	\$1.64	CA
CF382S	90° Short Ell — for use with Model CF329 only	1	\$1.64	CA
CF382XS	90° Short Socket Ell for VacPan™	1	\$2.58	CA
CF383	90° Tee	1	\$2.26	CA
CF384	Three-Way Ell	1	\$3.60	CA
CF385	45° Ell	1	\$1.54	CA
CF386	30° Ell	1	\$2.06	CA
CF387	45° Wye	1	\$3.10	CA
CF388	Stop Coupling	1	\$1.04	CA
CF389	End Cap	1	\$2.06	CA
CF3918	Filter Bags — Set of 3, 8 gallon capacity	1	\$19.58	CA
CH230L	High Performance Hose — 42' wire-reinforced vinyl with ON/OFF Switch	1	\$184.88	CA
CH235	Low Voltage Crushproof Hose — 30' features swivel handle	1	\$149.86	CA
CH515	Current-Carrying Crushproof Hose — 30'	1	\$353.80	CA
CH615	Current-Carrying Hose — 30', compatible with CI358, CI390 and CI395 Series Electrified Inlets	1	\$353.80	CA
CI319	Face Plate Extension	1	\$2.06	CA
CI324	Hose Clamp — 2"	10 *	\$2.06	CA
CI330	Exhaust Vent	1	\$6.18	CA
CI3301RK	Rough-In Kit for one inlet add-on. Use with 330 and CI335 Series Inlets.	1	\$88.06	CA
CI3303RK	Rough-In Kit for three inlet installations. Use with 330 and CI335 Series Inlets.	1	\$120.52	CA
CI358W	Direct Connect Wall Valve (Electrified) — White	10 *	\$23.70	CA
CI365W	VacPan™ Automatic Dustpan Inlet — White	1	\$82.40	CA
CI366W	QuickTrim Finish Trim Plate. White. For use with CI-365W.	1	\$7.22	CA
CI367IV	■ VacuSweep Auto Dust Pan — Ivory	1	\$72.10	CA
CI367W	VacuSweep Auto Dust Pan — White	1	\$72.10	CA
CI390W	Electrified Inlet — White, 12AWG, 6' Cord. Use CH620 and CH615 hoses.	1	\$10.30	CA
CI395RK	Rough-In Kit for CI390 and CI395 Electrified Inlets	1	\$29.88	CA
CI399ALM	ElectraValve® Electrified Inlet — Almond	1	\$10.30	CA
CI399EB	E-Box Only for ElectraValve® Electrified Inlet	1	\$21.26	CA
CI399RK	Electrified Inlet Rough-In Kit	1	\$29.88	CA
CI399W	ElectraValve® Electrified Inlet — White	1	\$10.30	CA
CK110	■ Basic Tool Set	1	\$52.36	CA

■ Limited quantities available.

- Item too large to ship via UPS/FedEx. Item shipped common carrier at minimum rates.
- * All pricing reflects the individual item cost. You must order in multiples as indicated.
- ◆ UL listed for use over bathtubs and showers when connected to a GFCI protected branch circuit.

NuTone® Tools, Hoses, Inlets, Tubing and Fittings CONTINUED

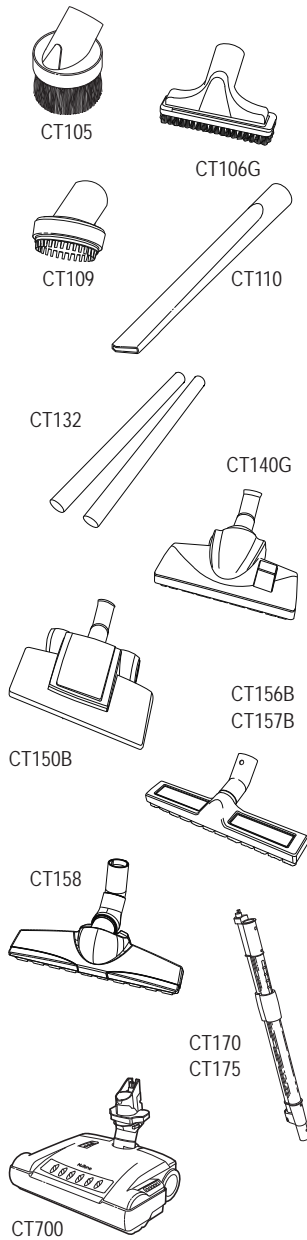

Model No.	Description	Std. Pk.	List Price	Code
CK135	Ratcheting Wand	1	\$27.82	CA
CS100	Car care attachment set	1	\$128.76	CA
CS200	Carpet & bare floor combination attachment set	1	\$138.02	CA
CS300	Bare floor attachment set	1	\$396.56	CA
CS400	Carpet & bare floor combination air turbine pet care attachment set	1	\$473.80	CA
CS500	Carpet & bare floor combination electric pigtail attachment set	1	\$854.90	CA
CS600	Carpet & bare floor combination electric direct connect attachment set	1	\$854.90	CA
CT105	Natural hair dusting brush	1	\$4.64	CA
CT106G	Upholstery Tool with Removable Brush. Natural Hair Bristles.	1	\$6.70	CA
CT109	Pet brush	1	\$3.60	CA
CT110	Long crevice tool	1	\$3.60	CA
CT132	Chrome Wands — set of two	1	\$26.26	CA
CT140G	Standard Combination Floor/Rug Tool	1	\$28.84	CA
CT143B	Universal Dusting Brush (elongated)	1	\$17.00	CA
CT150B	Deluxe Combination Floor/Rug Tool	1	\$24.20	CA
CT156B	Hardwood Floor Tool with Natural Hair Brush	1	\$26.26	CA
CT157B	Extra Wide Hardwood Floor Tool with Natural Hair Brush	1	\$37.08	CA
CT158	Premium twist and turn floor brush	1	\$43.26	CA
CT170	Adjustable wand for 20 Series hoses	1	\$54.08	CA
CT175	Adjustable wand for 15 Series hoses	1	\$54.08	CA
CT350B	Deluxe Air Turbine Brush	1	\$40.18	CA
CT700	Deluxe Power Brush	1	\$292.00	CA
VX3916	Standard Filter Media bags for VX475 Series (three bags per pack)	1	\$18.52	XH
VX3918	Premium Replacement bags for VX550 and VX1000 Series (three bags per pack)	1	\$74.42	XH
VX3918STD	Standard Filter Media bags for VX550 and VX1000 Series (three bags per pack)	1	\$18.98	XH

● Item too large to ship via UPS/FedEx. Item shipped common carrier at minimum rates.
 * All pricing reflects the individual item cost. You must order in multiples as indicated.
 ◆ UL listed for use over bathtubs and showers when connected to a GFCI protected branch circuit.

Door Chimes

NuTone® Hard-Wired Door Chimes



LA11BG
LA11WH



LA70MA



LA18WH
LB18WH

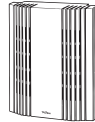

LA107WH



LA126WH



LA130WH

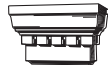

LA139WH



LA140WH



LA164WH

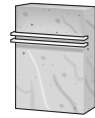

LA165SA



LA174WH



LA301WH

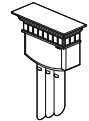

LA310CY



LA501CY

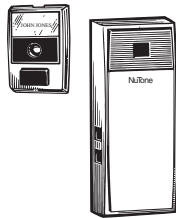

MCV309NWHGL

Model No.	Description	Std. Pk.	List Price	Code
LA11BG	Beige 2 Note	6 *	\$42.26	DC
LA11WH	White 2 Note	6 *	\$42.26	DC
LA14WH	White 2 Note Built-In	6 *	\$61.42	DC
LA18WH	White 2 Note	6 *	\$78.46	DC
LA39WH	White 2 Note Chord Tone	1	\$162.84	DC
LA70MA	Natural Maple Finish Wood Case — 4 – 8 Note	1	\$315.30	DC
LA100WH	Molded white finish, recessed grooves	3 *	\$36.60	DC
LA107WH	White 2 Note; Wired or Wireless	1	\$96.38	DC
LA126WH	White 2 Note	1	\$34.36	DC
LA130WH	White 2 Note	1	\$62.70	DC
LA139WH	Traditional White 2 Note	1	\$34.36	DC
LA140WH	Classic Arched Top 2 Note	1	\$34.36	DC
LA164WH	White Lighted 2 Note	1	\$166.60	DC
LA165SA	Neutral Lighted 2 Note	1	\$166.60	DC
LA174WH	White 8 Note Electronic Built-In Chime (May be used with Intercom Systems)	1	\$133.60	DC
LA202WH	White with rounded corners	3 *	\$53.10	DC
LA301WH	White Shield Design Cover (Two-note Front and Single-note Second Door)	6 *	\$41.42	DC
LA305WL	Walnut finish real wood, brass insert, 3 brass finish tubes	1	\$351.62	DC
LA310CY	Cherry Cover with Satin Nickel Chambers (Eight-note, Four-note and Single-note Chimes)	1	\$403.22	DC
LA501CY	Cherry, beveled mirror, 4 real brass tubes	1	\$653.24	DC
LA600WH	White MP3 Customizable Wired/Wireless Chime	1	\$98.86	DC
MCV309NWHGL	White & Gold 2 Note Mechanical Chime With Viewer	6 *	\$60.14	DC

- Item too large to ship via UPS/FedEx. Item shipped common carrier at minimum rates.
- * All pricing reflects the individual item cost. You must order in multiples as indicated.
- ◆ UL listed for use over bathtubs and showers when connected to a GFCI protected branch circuit.

Door Chimes

NuTone® Wireless Door Chimes

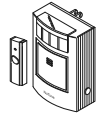

LA224RWH
LA224WH



LA223WH



LA225WH

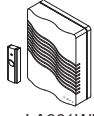

LA226WH



LA542WH

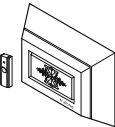

LA552RW

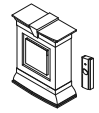

LA553WH

Model No.	Description	Std. Pk.	List Price	Code
LA223WH	White Wireless Plug-In Door Chime — 1, 2 or 8 notes	1	\$48.18	DC
LA224RWH	Visual Wireless Plug-In Door Chime Receiver — 1, 2 or 8 notes	1	\$78.72	DC
LA224WH	Visual Wireless Plug-In Door Chime — 1, 2 or 8 notes. Includes Receiver, Pushbutton and Pushbutton Battery.	1	\$88.18	DC
LA225WH	White Wireless Door Chime — 2 notes. Includes Receiver, Pushbutton and Pushbutton Battery.	1	\$42.54	DC
LA226WH	White Wireless Door Chime — 1, 2 or 8 notes. Includes Receiver.	1	\$65.18	DC
LA542WH	Front/back wireless with two buttons	3 *	\$66.46	DC
LA552RW	Americana wireless chime	1	\$82.38	DC
LA553WH	Pilot wireless chime	3 *	\$53.82	DC
LA600WH	White MP3 Customizable Wired/Wireless Chime	1	\$98.86	DC

NuTone® Chime Kits (CHIME, TRANSFORMER, BUTTON(S))



BK105
BK115LWH

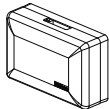

BK140LWH
BK140SLPB
BK142LWH

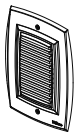

BK147LWH

Model No.	Description	Std. Pk.	List Price	Code
BK105	Chime only, 2-note / 1-note	24 *	\$24.22	DC
BK110NBWH	Chime, 1 unlighted pushbutton, 1 std. transformer	24 *	\$32.14	DC
BK115LWH	Chime, 1 lighted pushbutton, 1 std. transformer	24 *	\$35.28	DC
BK120NBWH	Chime, 2 unlighted pushbutton, 1 std. transformer	24 *	\$34.08	DC
BK125LWH	Chime, 2 lighted pushbutton, 1 std. transformer	24 *	\$37.70	DC
BK131LPB	Chime, 1 lighted stucco pushbutton in polished brass, 1 std. transformer	24 *	\$37.82	DC
BK131LSN	Chime, 1 lighted stucco pushbutton in satin nickel, 1 std. transformer	6 *	\$37.82	DC
BK131LRBZ	Chime, 1 lighted stucco pushbutton in oil-rubbed bronze, 1 std. transformer	6 *	\$37.82	DC
BK131LWH	Chime, 1 lighted stucco pushbutton in white, 1 std. transformer	6 *	\$37.82	DC
BK140LWH	Chime, 1 lighted pushbutton, 1 j-box transformer	24 *	\$38.82	DC
BK140SLPB	Chime, 1 lighted stucco pushbutton in polished brass, 1 j-box transformer	24 *	\$41.46	DC
BK142LWH	Chime, 2 lighted pushbutton, 1 j-box transformer	24 *	\$41.46	DC
BK144LCL	Chime, 1 lighted pushbutton round, 1 std. transformer	24 *	\$32.14	DC
BK147LWH	Recessed Chime, 1 lighted pushbutton, 1 std. transformer	24 *	\$54.30	DC

- Item too large to ship via UPS/FedEx. Item shipped common carrier at minimum rates.
- * All pricing reflects the individual item cost. You must order in multiples as indicated.
- ◆ UL listed for use over bathtubs and showers when connected to a GFCI protected branch circuit.

NuTone® Wired Pushbuttons

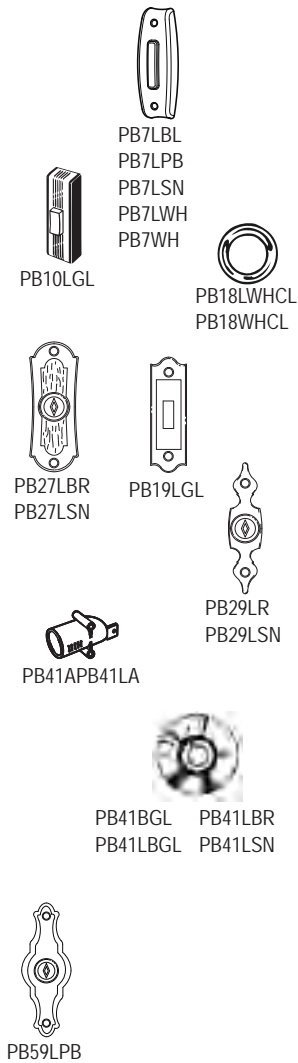

Model No.	Description	Std. Pk.	List Price	Code
PB4LBL	Pushbutton, lighted in black	3 *	\$22.78	DA
PB4LBR	Pushbutton, lighted in oil-rubbed bronze	3 *	\$26.62	DA
PB4LSN	Pushbutton, lighted in satin nickel	3 *	\$26.62	DA
PB7LBL	Pushbutton, lighted in black	12 *	\$7.58	DA
PB7LPB	Pushbutton, lighted in polished brass	12 *	\$7.58	DA
PB7LSN	Pushbutton, lighted in satin nickel	12 *	\$7.58	DA
PB7LWH	Pushbutton, lighted in white	12 *	\$7.58	DA
PB7WH	Pushbutton, unlighted in white	12 *	\$7.58	DA
PB10LGL	Pushbutton, gold and black — lighted	12 *	\$11.64	DA
PB15LBR	Pushbutton, lighted in oil-rubbed bronze	3 *	\$26.62	DA
PB15LPB	Pushbutton, lighted in polished brass	3 *	\$23.58	DA
PB15LSN	Pushbutton, lighted in satin nickel	3 *	\$26.62	DA
PB18LWHCL	Pushbutton, clear with white cap — lighted	12 *	\$7.86	DA
PB18WHCL	Pushbutton, clear with white cap — unlighted	12 *	\$5.00	DA
PB19LGL	Pushbutton, polished brass — lighted	12 *	\$20.20	DA
PB27LBR	Pushbutton, lighted in oil-rubbed bronze	3 *	\$26.62	DA
PB27LSN	Pushbutton, satin nickel — lighted	6 *	\$26.62	DA
PB29LR	Pushbutton, oil-rubbed bronze — lighted	6 *	\$22.08	DA
PB29LSN	Pushbutton, satin nickel — lighted	6 *	\$22.08	DA
PB41APB41LA	Plastic Stucco Sleeves	24 *	\$3.46	DA
PB41BGL	Pushbutton, polished brass stucco — unlighted	24 *	\$7.24	DA
PB41LBGL	Pushbutton, polished brass stucco — lighted	24 *	\$10.08	DA
PB41LBR	Pushbutton, oil-rubbed bronze stucco — lighted	24 *	\$11.96	DA
PB41LSN	Pushbutton, satin nickel stucco — lighted	24 *	\$11.96	DA
PB53LWH	Pushbutton, lighted in white	3 *	\$22.78	DA
PB59LPB	Pushbutton, lighted in polished brass	3 *	\$20.50	DA
PB61LPB	Pushbutton, lighted in polished brass	3 *	\$24.96	DA
PB64LAB	Pushbutton, lighted in antique brass	3 *	\$21.22	DA
PB67AB	Pushbutton, unlighted in antique brass	3 *	\$7.92	DA
PB69LWB	Pushbutton, lighted in black	6 *	\$8.04	DA
PB69LPB	Pushbutton, lighted in polished brass	6 *	\$8.04	DA
PB69LPC	Pushbutton, lighted in polished chrome	6 *	\$8.04	DA
PB69LSN	Pushbutton, lighted in satin nickel	6 *	\$10.16	DA
PB69LWB	Pushbutton, lighted in white	6 *	\$8.04	DA

Note: The diamond symbol on the pushbuttons is currently being replaced with the NuTone Logo.

- Item too large to ship via UPS/FedEx. Item shipped common carrier at minimum rates.
- * All pricing reflects the individual item cost. You must order in multiples as indicated.
- ◆ UL listed for use over bathtubs and showers when connected to a GFCI protected branch circuit.

Door Chimes

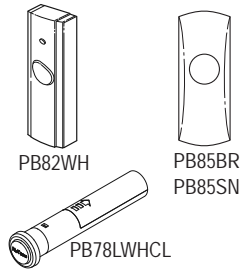

NuTone® Wireless Pushbuttons

Model No.	Description	Std. Pk.	List Price	Code
PB82WH	Unlighted, White	6 *	\$21.22	DC
PB85BR	Unlighted, Oil-Rubbed Bronze	6 *	\$36.82	DC
PB85SN	Unlighted, Satin Nickel	6 *	\$36.82	DC
PB78LWHCL	Wireless — White Lighted	1	\$27.58	DA

NuTone® Chime Accessories



Model No.	Description	Std. Pk.	List Price	Code
C905	16v, 10va Transformer	6 *	\$17.10	DA
C907	16v, 30va Transformer	6 *	\$27.10	DA
C909	Tri-volt 8, 16, 24 Volt 20 VA Transformer	6 *	\$30.18	DA
C915	16v, 10va J-Box Transformer	6 *	\$27.10	DA
PBL2	Replacement bulbs for all lighted pushbuttons — Visu-Pack	12 *	\$5.78	DA
SPB18LWHCL	Replacement Bulb for round button	1	\$7.96	PT

Haven™



HVDCT



HVLFABL
HVLFABR

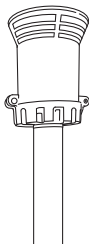

HVRFABL
HVRFABR

NuTone® Haven™ Backyard Lighting & Mosquito Repellent System features innovative landscape fixtures that provide season-long*, effective protection from biting mosquitoes. Don't let biting mosquitoes keep you from enjoying time outdoors with family and friends! Haven's patented mosquito protection system provides protection within 15 minutes of use and is effective against all types of mosquitoes. Four haven fixtures protect a typical deck or patio for over 440 square feet of coverage. They're easy to install and designed to mount on a deck post, railing or stake in the ground. Plus, you can add Haven to an existing low voltage lighting system or install with a transformer and cable for convenient protection from biting mosquitoes.

* 90 days of mosquito protection when used an average of 2.4 hours/day.

Model No.	Description	Std. Pk.	List Price	Code
HVDCT	Dual Controller/Timer	1	\$78.00	ML
HVLFABL	Light & Repellent Fixture — Black	1	\$200.00	ML
HVLFABR	Light & Repellent Fixture — Bronze	1	\$200.00	ML
HVPFBL	Post/Rail Mount Flange — Black	1	\$9.00	ML
HVPFBR	Post/Rail Mount Flange — Bronze	1	\$9.00	ML
HVRC1	Repellent Refill	1	\$67.00	ML
HVRC4	Repellent Refill (4 Pack)	1	\$206.00	ML
HVRFABL	Repellent Fixture — Black	1	\$165.00	ML
HVRFABR	Repellent Fixture — Bronze	1	\$165.00	ML

Heaters

NuTone® Surface Mount Ceiling Heater



Enjoy the comfort of 1250 watts of instant heat in a bathroom, laundry room or any area where you want extra heat without using the central heating system. Easy to install ... fits standard 3-1/4" and 4" octagon, as well as 3-1/2" round electrical boxes. 11" diameter.

Model No.	Description	Std. Pk.	List Price	Code
157	Low-Profile Ceiling Heater — Same as Model 154 except with exclusive totally enclosed, sheathed element. 1250W, 120VAC.	1	\$133.90	HT

- Item too large to ship via UPS/FedEx. Item shipped common carrier at minimum rates.
- * All pricing reflects the individual item cost. You must order in multiples as indicated.
- ◆ UL listed for use over bathtubs and showers when connected to a GFCI protected branch circuit.

Heaters

NuTone® High Capacity Wall Heaters

Large capacity fan-forced heaters for high heat loss areas such as lobbies, entranceways and vestibules. Easily convert to half-wattage. Totally enclosed, sheathed elements. Model 85 surface mount kit for Models 192, 194 and 198 available separately (see Page 22).

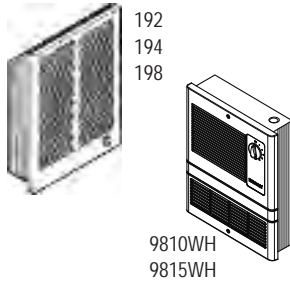

Model No.	Description	Std. Pk.	List Price	Code
192	Wall Heater, 1000/2000W+ 240VAC +, 750/1500W 208VAC. White painted grille.	1	\$422.78	HT
194	Wall Heater, 1500/3000W+ 240VAC +, 1125/2250W 208VAC. White painted grille.	1	\$445.58	HT
198	Wall Heater, 2000/4000W+ 240VAC +, 1500/3000W 208VAC. White painted grille.	1	\$466.80	HT
9810WH	1000W Fan-Forced Wall Heater, White polymeric grille, 120/240 volts.	1	\$266.46	HT
9815WH	1500W Fan-Forced Wall Heater, White polymeric grille, 120/240 volts.	1	\$273.74	HT

+ Factory wired wattage/voltage. Field convertible to other options listed.

NuTone® Kickspace Heaters

Slim and trim ... designed for permanent installation into any cabinet kickspace, vanity base or other area where wall space is limited. Perfect for stairway installation, ticket/toll booths, checkout counters, etc.



Model No.	Description	Std. Pk.	List Price	Code
112	Kickspace Heater. 1500W+ 240VAC +, 750/1500W 120VAC, with built-in thermostat. White.	1	\$280.60	HT
114	Kickspace Heater. Same as Model 112 except w/o built-in thermostat. White.	1	\$249.74	HT
90	Thermostat Kit — Used to install thermostat in Model 114 kickspace heater. Snap action, bi-metallic, effective temperature range of 40 – 130° F.	1	\$57.84	AC

+ Factory wired wattage/voltage. Field convertible to other options listed.

NuTone® Fan-Forced Wall Heaters

Perfect for the bathroom or other areas where fan-forced heat is needed quickly. Easily converts to half-wattage. Attractive white grille finish standard. Housing measures 10-1/4" W x 7-3/4" H x 3-3/4" D. Sturdy steel grille measures 12" W x 9-1/4" H x 1/2" D. Model 84 surface mount kit available separately (see Page 22).



Model No.	Description	Std. Pk.	List Price	Code
170	Wall Heater. 500/1000W+ 120VAC +, 750W 208VAC, 1000W 240 VAC. White painted grille.	1	\$172.30	HT
174	Wall Heater. 750/1500W+ 120VAC +, 1125W 208VAC, 1500W 240 VAC. White painted grille.	1	\$180.78	HT
178	Wall Heater. 1000/2000W+ 240VAC +, 750W/1500W 208 VAC. White painted grille.	1	\$193.80	HT

+ Factory wired wattage/voltage. Field convertible to other options listed.

Broan® Big Heat® Portable Heater

Effective two-level 120V (1500 and 1200 watts) portable heater is compact with easy to use controls. The built-in thermostat will keep you comfortable in nearly any situation. 6' power cord has a polarized plug. Overheat protection shuts off the heater and activates the "caution" light if excess heat is detected. A safety switch instantly shuts off the heater if it is tipped over.



Model No.	Description	Std. Pk.	List Price	Code
6201	Efficient Two-Level Heater, 1500 or 1200 watts. Built-in adjustable thermostat. Steel, 6' cord. Safety tipover switch and overload protector.	6 *	\$105.72	PH

■ Limited quantities available.

- Item too large to ship via UPS/FedEx. Item shipped common carrier at minimum rates.
- * All pricing reflects the individual item cost. You must order in multiples as indicated.
- ◆ UL listed for use over bathtubs and showers when connected to a GFCI protected branch circuit.

Heaters

NuTone® Heater Project Packs

Broan's project packs offer housings packed and sold separately from heater assemblies and grilles. You can buy housings for rough-in ... buy heater/motor assemblies and grilles later for finishing. Order Broan Model 83 Built-in Thermostat available separately — if required for "F" models (see below).



Grille

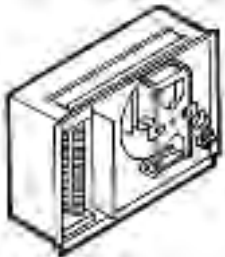

Project Pack Housing and Finish Unit

Model No.	Description	Std. Pk.	List Price	Code
171H	Project Pack Housing Unit. Use with all Finish Units.	4 *	\$34.56	HT
165F	Project Pack Finish Unit. Use 171H Project pack housing for rough-in. 500W+ 120/240VAC +, 375W 208VAC. White grille.	1	\$127.04	HT
165FT	Project Pack. Same as 165F, except includes built-in thermostat.	1	\$137.70	HT
167F	Project Pack Finish Unit. Use 171H Project pack housing for rough-in. 750 +/1500W 240VAC +, 562/1125W 208VAC. White grille.	1	\$127.04	HT
167FT	Project Pack. Same as 167F, except includes built-in thermostat.	1	\$137.70	HT
174F	Project Pack Finish Unit. Use 171H Project pack housing for rough-in. 750/1500W+ 120VAC +, 1125W 208VAC, 1500W 240VAC. White grille.	1	\$135.52	HT
174FT	Project Pack. Same as 174F except includes built-in thermostat.	1	\$146.20	HT

+ Factory wired wattage/voltage. Field convertible to other options listed.

NuTone® Register Heaters

Fan-forced heat for instant warmth from an attractive "register" type heater. Specially designed nickel-chrome element heats in seconds. Use convenient wall-mounted line-voltage thermostat (Broan Model 86W available separately — see below). Housing size 10-1/4" W x 7-3/4" H x 3-3/4" D. Sturdy steel grille size 14-1/4" W x 9-1/4" H x 7/8" D.



Model No.	Description	Std. Pk.	List Price	Code
120	Heater. 500/1000W+ 120VAC +, 750W 208VAC, 1000W 240VAC. White grille.	1	\$172.30	HT
124	Heater. 750/1500W+ 120VAC +, 1125W 208VAC, 1500W 240VAC. White grille.	1	\$180.78	HT
128	Heater. 1000/2000W+ 240VAC +, 750/1500W 208VAC. White grille.	1	\$186.26	HT

+ Factory wired wattage/voltage. Field convertible to other options listed.

NuTone® Heater Accessories

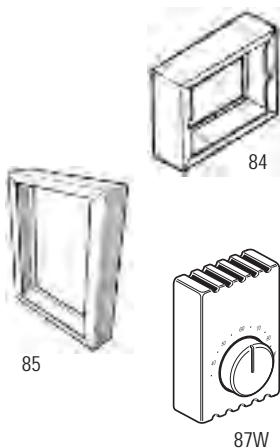

84

85

87W

Model No.	Description	Std. Pk.	List Price	Code
83	Thermostat Kit. Used to install thermostat in Models 165F, 167F, 170F, 174F and 178F Wall Heaters. Snap action, bi-metallic. Rated 120/240VAC, 12.5 amps. Temperature range 40 – 125° F.	1	\$21.52	AC
84	Surface Mount Kit. White enameled steel. For use with Models 165F, 165FT, 167F, 167FT, 170, 170F, 170FT, 174, 174F, 174FT, 178, 178F and 178FT Wall Heaters.	1	\$44.00	AC
85	Surface Mount Kit. White enameled steel. For use with Models 192, 194 and 198 High Capacity Wall Heaters.	1	\$97.60	AC
87W	Line Voltage Wall Thermostat. Snap action bi-metallic, single pole — rated 120/240VAC, 22 amps. Temperature range 50 – 85° F. Decorator white finish.	1	\$31.14	AC
90	Thermostat Kit. Used to install built-in thermostat in Model 114 kickspace heater. Snap action, bi-metallic, effective temperature range of 40 – 130° F.	1	\$57.84	AC

● Item too large to ship via UPS/FedEx. Item shipped common carrier at minimum rates.

* All pricing reflects the individual item cost. You must order in multiples as indicated.

◆ UL listed for use over bathtubs and showers when connected to a GFCI protected branch circuit.

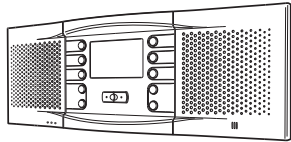

NM100WH

NuTone® NM100 Master Station

Model No.	Description	Std. Pk.	List Price	Code
NM100WH	Master Station, White	1	\$889.84	NM

NuTone® NM100 Speakers and Accessories

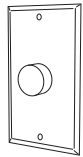

NA300MCWH

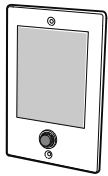

NDB300AB
NDB300BB
NDB300N

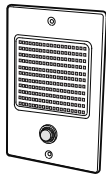

NDB300WH

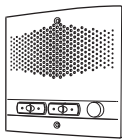

NPS103WH
NPS104WH
NRS103WH
NRS104WH

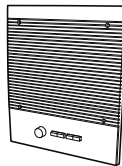

NR380WH

Model No.	Description	Std. Pk.	List Price	Code
NA200TA	Transformer	1	\$60.26	NM
NA3003C	3-Note Chime Module	1	\$67.62	NM
NA3008C	8-Note Chime Module	1	\$133.98	NM
NA300MCWH	Volume Control — White	1	\$24.60	NM
NA300TA	Transformer	1	\$77.42	NM
NDB300AB	Door Speaker — Antique Brass	1	\$73.74	NM
NDB300BB	Door Speaker — Bright Brass	1	\$79.62	NM
NDB300N	Door Speaker — Nickel	1	\$76.34	NM
NDB300WH	Door Speaker — White	1	\$49.18	NM
NES300DBL	Plastic Door Speaker Surface Mount Frame — Black	1	\$27.04	NM
NES300DWH	Plastic Door Speaker Surface Mount Frame — White	1	\$27.04	NM
NF100MWH	Master Retrofit Frame — White	1	\$63.90	NM
NF200MWH	Master Frame — White	1	\$40.68	NM
NF300DWH	Door Speaker Retrofit Frame — White	1	\$25.84	NM
NF300PWH	Outdoor Remote Station Retrofit Frame — White	1	\$61.44	NM
NF300RWH	Indoor Remote Station Retrofit Frame — White	1	\$38.12	NM
NPS103WH	Outdoor Remote Station (3-wire) — White	1	\$126.58	NM
NPS104WH	Outdoor Remote Station (4-wire) — White	1	\$126.58	NM
NR380WH	Indoor 8" Remote Station — White	1	\$119.24	NM
NRKF200P	Outdoor Remote Station Rough-In	1	\$27.04	NM
NRKR200R	Indoor Remote Station Rough-In (Pack of 5)	1	\$50.40	NM
NRKR300D	Door Speaker Rough-In	1	\$14.74	NM
NRKRWH300	Rough-In Kit	1	\$209.00	NM
NRKS200PWH	Outdoor Remote Station Surface Mount Frame — White	1	\$39.32	NM
NRKS300R	Indoor Remote Station Surface Mount Rough-In — White	1	\$51.62	NM
NRS103WH	Indoor Remote Station (3-wire) — White	1	\$84.84	NM
NRS104WH	Indoor Remote Station (4-wire) — White	1	\$84.84	NM
NW4S	Shielded Cable, 22 gauge, 75'	1	\$37.20	NM
NWH300	Master Station Rough-In	1	\$182.44	NM

- Item too large to ship via UPS/FedEx. Item shipped common carrier at minimum rates.
- * All pricing reflects the individual item cost. You must order in multiples as indicated.
- ◆ UL listed for use over bathtubs and showers when connected to a GFCI protected branch circuit.

Intercom Systems

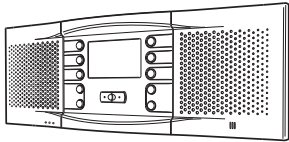

NM200AL
NM200WH

NuTone® NM200 Master Station

Model No.	Description	Std. Pk.	List Price	Code
NM200AL	Master Station — Almond	1	\$946.36	NM
NM200WH	Master Station — White	1	\$860.36	NM

NuTone® NM200 Speakers and Accessories

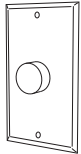

NA300MCWH



NDB300AB
NDB300BB
NDB300N

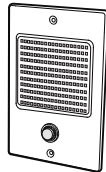

NDB300WH

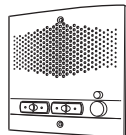

NPS200WH
NRS200AL
NRS200WH

Model No.	Description	Std. Pk.	List Price	Code
NA200TA	Transformer	1	\$60.26	NM
NA3003C	3-Note Chime Module	1	\$67.62	NM
NA3008C	8-Note Chime Module	1	\$133.98	NM
NA300MCWH	Volume Control — White	1	\$24.60	NM
NA300TA	Transformer	1	\$77.42	NM
NDB300AB	Door Speaker — Antique Brass	1	\$73.74	NM
NDB300BB	Door Speaker — Bright Brass	1	\$79.62	NM
NDB300N	Door Speaker — Nickel	1	\$76.34	NM
NDB300WH	Door Speaker — White	1	\$49.18	NM
NES300DBL	Plastic Door Speaker Surface Mount Frame — Black	1	\$27.04	NM
NES300DWH	Plastic Door Speaker Surface Mount Frame — White	1	\$27.04	NM
NF100CWH	■ Master and CD Combination Retrofit Frame — White	1	\$95.90	NM
NF100MWH	Master Retrofit Frame — White	1	\$63.90	NM
NF200MWH	Master Frame — White	1	\$40.68	NM
NF300DWH	Door Speaker Retrofit Frame — White	1	\$25.84	NM
NF300PWH	Outdoor Remote Station Retrofit Frame — White	1	\$61.44	NM
NF300RWH	Indoor Remote Station Retrofit Frame — White	1	\$38.12	NM
NM200K	Music Intercom Kit	1	\$1,354.42	NM
NPS200WH	Outdoor Remote Station — White	1	\$121.70	NM
NRKF200P	Outdoor Remote Station Rough-In	1	\$27.04	NM
NRKR200R	Indoor Remote Station Rough-In (Pack of 5)	1	\$50.40	NM
NRKR300D	Door Speaker Rough-In	1	\$14.74	NM
NRKRWH300	Rough-In Kit	1	\$209.00	NM
NRKS200PWH	Outdoor Remote Station Surface Mount Frame — White	1	\$39.32	NM
NRS200AL	Indoor Remote Station — Almond	1	\$90.96	NM
NRS200WH	Indoor Remote Station — White	1	\$82.36	NM
NW4S	Shielded Cable, 22 gauge, 75'	1	\$37.20	NM
NWH300	Master Station Rough-In	1	\$182.44	NM

■ Limited quantities available.

- Item too large to ship via UPS/FedEx. Item shipped common carrier at minimum rates.
- * All pricing reflects the individual item cost. You must order in multiples as indicated.
- ◆ UL listed for use over bathtubs and showers when connected to a GFCI protected branch circuit.

Intercom Systems

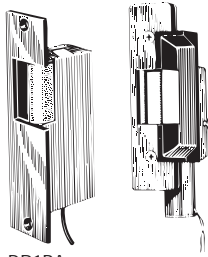

DR1BA
DR1SA

DR2SA

NuTone® Electronic Door Release

Model No.	Description	Std. Pk.	List Price	Code
DR1BA	Door Release, Electric, Wood Door Frame, Brass Anodized	1	\$84.56	IA
DR1SA	Door Release, Electric, Wood Door Frame, Silver Anodized	1	\$99.98	IA
DR2SA	Door Release, Electric, Metal Door Frame, Silver Anodized	1	\$177.64	IA

Ironing Centers — Built-In

NuTone® Ironing Centers



ICUDWH
ICUNUW

Model No.	Description	Std. Pk.	List Price	Code
<u>Ironing Centers</u>				
ICUDWHX	Built-In Ironing Center — White with White Raised Panel Door - Over Packed (includes hinges and ironing board cover)	1	\$306.68	IB
ICUNUWX	Built-In Ironing Center — Unfinished Birch, No Door - Over Packed (includes hinges and ironing board covers)	1	\$285.18	IB
<u>Custom Doors</u>				
ICDM	Custom Door — Mirror	1	\$151.68	IB
ICDFUW	Custom Door — Birch Flat Panel (Unfinished)	1	\$116.68	IB
ICDRUW	Custom Door — Birch Raised Panel (Unfinished)	1	\$116.68	IB
<u>Accessories</u>				
ICAK	Deluxe Accessory — LED Light, Electrical Outlet, Timer	1	\$134.62	IB
ICAB	Accessory — Replacement Ironing Board Cover	1	\$36.16	IB

NuTone® Ironing Centers

Model No.	Description	Std. Pk.	List Price	Code
<u>Custom Doors</u>				
AVDOFPN	■ Custom Door — Birch Flat Panel (Unfinished). Fits AVD40N and AVD50N.	1	\$146.42	IB
AVDORPN	■ Custom Door — Oak Raised Panel (Unfinished). Fits AVD40N and AVD50N.	1	\$174.44	IB
AVDWRPN	■ Custom Door — White Raised Panel. Fits AVD40N and AVD50N.	1	\$183.60	IB
<u>Accessories</u>				
AVDSMN	■ Surface Mount Collar. Fits AVD40N and AVD50N.	1	\$85.84	IB

■ Limited quantities available.

- Item too large to ship via UPS/FedEx. Item shipped common carrier at minimum rates.
- * All pricing reflects the individual item cost. You must order in multiples as indicated.
- ◆ UL listed for use over bathtubs and showers when connected to a GFCI protected branch circuit.

Range Hoods — Chimney



619004
6" Round Duct — Internal Blower
450 CFM, 9.0 Sones
614804
8" Round Duct — Internal Blower
900 CFM, 9.5 Sones
8" Round Duct — External Blower
280 – 1500 CFM

Broan® Elite 61000 Series

Wall-mounted hood with telescopic flue that accommodates 8' to 9' ceilings. Seamless corners provide stylish, easy cleaning surface. Three-speed blower with Heat Sentry™ and light control. Available in 30", 35-7/16" (90cm) and 48" widths in stainless. Two (30" & 35-7/16") or four (48") 20-watt halogen bulbs (included) provide bright cooktop lighting. Internal and external blower capability.

Model No.	Description	Std. Pk.	List Price	Code
30" 613004	Stainless Steel Range Hood	1	\$2,227.84	DH
90cm 619004	35-7/16" (90cm) Stainless Steel Range Hood	1	\$2,256.94	DH
619004EX	35-7/16" (90cm) Stainless Steel Range Hood, External Blower. Blowers are ordered separately. Select from Models 331H, 332H, 335, 336, HLB3, HLB6, HLB9 and HLB11 on Page 37.	1	\$1,648.56	DH
48" 614804	● Stainless Steel Range Hood	1	\$2,518.80	DH
614804EX	● Stainless Steel Range Hood, External Blower. Blowers are ordered separately. Select from Models 331H, 332H, 335, 336, HLB3, HLB6, HLB9 and HLB11 on Page 37.	1	\$1,917.40	DH
RFX6104	Ducted Flue Extension for 61000 Series with Internal Blower (not for Model 614804)	1	\$509.40	HA
RFX6104EX	Flue Extension for 61000EX Series with External Blower and Model 614804	1	\$566.00	HA
ROUNDFILTER	Replacement Non-ducted Charcoal Filter (for 613004 and 619004)	1	\$97.14	HA
ARP6	CFM Reducer Kit. Reduces CFM to less than 300 CFM, 6" round when used with 613004 and 619004.	5 *	\$49.18	AC

Range hoods work with make-up dampers (MD6TU, MD8TU and MD10TU) and fresh air inlets (641FA, 643FA and 610FA) — see accessories on Page 5.



8" Round Duct — Internal Blower
900 CFM, 9.5 Sones
8" Round Duct — External Blower
280 – 1500 CFM

Broan® Elite 63000 Series

Island-mounted hood with telescopic flue accommodates 8' to 9' ceilings. Seamless corners provide stylish, easy cleaning surface. Three-speed blower with Heat Sentry™. 27-9/16" x 39-3/8" (70cm x 100cm) in stainless. Four 20-watt halogen bulbs (included) provide bright cooktop lighting.

Model No.	Description	Std. Pk.	List Price	Code
637004	● 27-9/16" x 39-3/8" (70cm x 100cm) Stainless Steel Range Hood	1	\$4,310.06	DH
637004EX	● 27-9/16" x 39-3/8" (70cm x 100cm) Stainless Steel Range Hood, External Blower. Blowers are ordered separately. Select from Models 331H, 332H, 335, 336, HLB3, HLB6, HLB9 and HLB11 on Page 37.	1	\$3,891.40	DH
RFX6304EX	Flue Extension for 9' to 10' ceilings	1	\$1,386.76	HA

Range hoods work with make-up dampers (MD6TU, MD8TU and MD10TU) and fresh air inlets (641FA, 643FA and 610FA) — see accessories on Page 5.

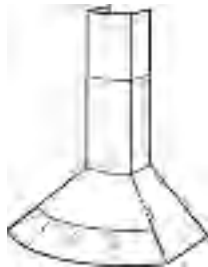

6" Round Duct — Internal Blower
450 CFM, 9.0 Sones

Broan® Elite RM65000 Series

This delightful, hand-crafted design blends curved and angular surfaces to form a stunning union of stainless steel and glass. The 65000 Series' 450 CFM centrifugal blower is combined with an advanced, multi-speed electronic control featuring a convenient 10-minute delay shut-off and Heat Sentry™. Two 20-watt halogen bulbs (included), two level brightness.

Model No.	Description	Std. Pk.	List Price	Code
RM659004	● 35-7/16" (90cm) Stainless Steel Range Hood	1	\$2,971.64	DH
RFX6504	Flue Extension for 9' to 10' ceilings	1	\$509.40	HA
ARP6	CFM Reducer Kit. Reduces CFM to less than 300 CFM, 6" round.	5 *	\$49.18	AC

Range hoods work with make-up dampers (MD6TU, MD8TU and MD10TU) and fresh air inlets (641FA, 643FA and 610FA) — see accessories on Page 5.

- Item too large to ship via UPS/FedEx. Item shipped common carrier at minimum rates.
- * All pricing reflects the individual item cost. You must order in multiples as indicated.
- ◆ UL listed for use over bathtubs and showers when connected to a GFCI protected branch circuit.

Range Hoods — Chimney

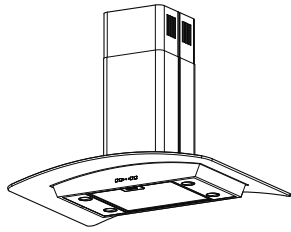

6" Round Duct — Internal Blower
High — 500 CFM, 10.5 Sones
Low — 200 CFM, 2.5 Sones

Compatible with Broan make-up air dampers.

Broan® Elite EI59 Series

Beautiful contemporary European glass island design. The curved glass canopy provides a stunning focal point without blocking the view of your surroundings. Electronic pushbutton control and halogen lighting (bulbs included).

Model No.	Description	Std. Pk.	List Price	Code
36" EI5936SS ●	Stainless Steel Range Hood	1	\$1,651.62	DH
FXNE59SS	Ducted or Non-ducted Flue Extension for 10' ceilings	1	\$682.76	AC
RKE59	Non-ducted Kit	1	\$223.48	AC
FILTERE56	Non-ducted Filter	1	\$57.56	AC
GU1035	Halogen Bulb; 120V, 35W	10 *	\$15.92	AC
MD6T Ø	6" Automatic Make-Up Air Damper	1	\$174.86	HA
MD8T Ø	8" Automatic Make-Up Air Damper	1	\$188.30	HA
MD10T Ø	10" Automatic Make-Up Air Damper	1	\$307.66	HA
BCR1	RF Remote Control	1	\$88.64	QA

Ø Work with fresh air inlets (641FA, 643FA and 610FA) — see accessories on Page 5.

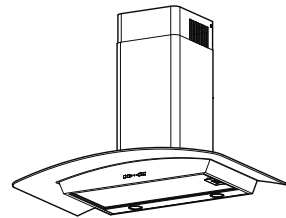

6" Round Duct — Internal Blower
High — 500 CFM, 10.5 Sones
Low — 200 CFM, 2.5 Sones

Compatible with Broan make-up air dampers.

Broan® Elite EW56 Series

Elegant European curved glass design that is both beautiful and functional. The airy design is a stunning focal point that complements its surrounding perfectly. Electronic pushbutton control and halogen lighting (bulbs included).

Model No.	Description	Std. Pk.	List Price	Code
30" EW5630SS ●	Stainless Steel Range Hood	1	\$1,096.88	DH
36" EW5636SS ●	Stainless Steel Range Hood	1	\$1,147.96	DH
FXNE56SS	Ducted or Non-ducted Flue Extension for 10' ceilings	1	\$397.74	AC
RKE56	Non-ducted Kit	1	\$223.48	AC
FILTERE56FL	Non-ducted Filter — Flat	1	\$73.22	AC
GU1035	Halogen Bulb; 120V, 35W	10 *	\$15.92	AC
MD6T Ø	6" Automatic Make-Up Air Damper	1	\$174.86	HA
MD8T Ø	8" Automatic Make-Up Air Damper	1	\$188.30	HA
MD10T Ø	10" Automatic Make-Up Air Damper	1	\$307.66	HA
BCR1	RF Remote Control	1	\$88.64	QA

Ø Work with fresh air inlets (641FA, 643FA and 610FA) — see accessories on Page 5.

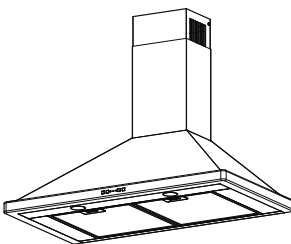

6" Round Duct — Internal Blower
High — 500 CFM, 10.5 Sones
Low — 200 CFM, 2.5 Sones

Compatible with Broan make-up air dampers.

Broan® Elite EW58 Series

Inspiring traditional European design. This wonderful design is executed to meet today's needs so that everyone can achieve their dream. Electronic pushbutton control and halogen lighting (bulbs included).

Model No.	Description	Std. Pk.	List Price	Code
30" EW5830SS ●	Stainless Steel Range Hood	1	\$1,096.88	DH
36" EW5836SS ●	Stainless Steel Range Hood	1	\$1,147.96	DH
FXNE58SS	Ducted or Non-ducted Flue Extension for 10' ceilings	1	\$284.86	AC
RKE58	Non-ducted Kit	1	\$223.48	AC
FILTERE56	Non-ducted Filter	1	\$57.56	AC
GU1035	Halogen Bulb; 120V, 35W	10 *	\$15.92	AC
MD6T Ø	6" Automatic Make-Up Air Damper	1	\$174.86	HA
MD8T Ø	8" Automatic Make-Up Air Damper	1	\$188.30	HA
MD10T Ø	10" Automatic Make-Up Air Damper	1	\$307.66	HA
BCR1	RF Remote Control	1	\$88.64	QA

Ø Work with fresh air inlets (641FA, 643FA and 610FA) — see accessories on Page 5.

- Item too large to ship via UPS/FedEx. Item shipped common carrier at minimum rates.
- * All pricing reflects the individual item cost. You must order in multiples as indicated.
- ◆ UL listed for use over bathtubs and showers when connected to a GFCI protected branch circuit.

Range Hoods — Chimney

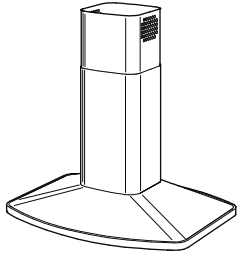

6" Round Duct — Internal Blower
High — 480 CFM, 9.5 Sones
Low — 230 CFM, 3.0 Sones

Broan® Elite E54000 Series

The E54000 Series island hood offers a clean and contemporary style with a soft touch. Engineered to meet today's conventional cooking appliances. 480 CFM multi-speed blower, large dishwasher-safe filters and four halogen lights (bulbs included) provide effective performance and brilliant task lighting.

Model No.	Description	Std. Pk.	List Price	Code
E5490SS ●	27-9/16" x 35-7/16" Stainless Steel Range Hood	1	\$2,787.48	DH
FX54SS	Ducted Flue Extension for 10' ceilings	1	\$929.16	HA
FXN54SS	Non-ducted Flue Extension for 10' ceilings	1	\$929.16	HA
RK54	Non-ducted Recirculation Kit	1	\$199.12	HA
FILTERSQUARE	Replacement Non-ducted Charcoal Filter	1	\$59.44	HA
ARP6	CFM Reducer Kit. Reduces CFM to less than 300 CFM, 6" round.	5 *	\$49.18	AC

Range hoods work with make-up dampers (MD6TU, MD8TU and MD10TU) and fresh air inlets (641FA, 643FA and 610FA) — see accessories on Page 5.



6" Round Duct — Internal Blower
370 CFM, 7.0 Sones

Broan® Elite RM53000 Series

This Italian inspired brushed stainless steel range hood proves that simplicity can be the perfect design statement and a match for today's conventional cooking appliances. A quiet 370 CFM multi-speed blower with Heat Sentry™, dishwasher-safe filters and generous lighting (bulbs included) provide effective performance and convenient operation.

Model No.	Description	Std. Pk.	List Price	Code
30" RM533004	Stainless Steel Chimney Hood	1	\$1,208.48	DH
36" RM533604 ●	Stainless Steel Chimney Hood	1	\$1,287.68	DH
42" RM534204 ●	Stainless Steel Chimney Hood	1	\$1,454.68	DH
RFX5304	Ducted Flue Extension for 10' ceilings	1	\$291.50	HA
RFXN5304	Non-ducted Flue Extension for 10' ceilings	1	\$291.50	HA
RRK51	Non-ducted Recirculation Kit	1	\$147.16	HA
FILTERSQUARE	Replacement Non-ducted Charcoal Filter	1	\$59.44	HA
ARP6	CFM Reducer Kit. Reduces CFM to less than 300 CFM, 6" round.	5 *	\$49.18	AC

Range hoods work with make-up dampers (MD6TU, MD8TU and MD10TU) and fresh air inlets (641FA, 643FA and 610FA) — see accessories on Page 5.

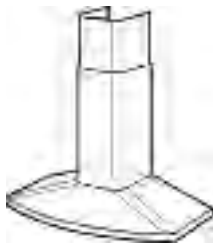

6" Round Duct — Internal Blower
370 CFM, 7.0 Sones

Broan® Elite RM52000 Series

This wall-mounted chimney hood combines graceful curves and traditional European styling. The 52000 Series is engineered to meet the requirements of today's highly styled, conventional appliances and kitchens. Its 370 CFM centrifugal blower and multi-speed control with Heat Sentry™ provide quiet, effective performance. Halogen lighting (bulbs included) accentuates the beauty of a fully enclosed bottom containing dishwasher-safe filters.

Model No.	Description	Std. Pk.	List Price	Code
30" RM523004	Stainless Steel Chimney Hood	1	\$1,208.48	DH
36" RM523604	Stainless Steel Chimney Hood	1	\$1,287.68	DH
42" RM524204 ●	Stainless Steel Chimney Hood	1	\$1,454.68	DH
RFX5204	Ducted Flue Extension for 9' to 10' ceilings	1	\$283.04	HA
RFXN5204	Non-ducted Flue Extension for 9' to 10' ceilings	1	\$283.04	HA
RRK51	Non-ducted Recirculation Kit	1	\$147.16	HA
FILTERSQUARE	Replacement Non-ducted Charcoal Filter	1	\$59.44	HA
ARP6	CFM Reducer Kit. Reduces CFM to less than 300 CFM, 6" round.	5 *	\$49.18	AC

Range hoods work with make-up dampers (MD6TU, MD8TU and MD10TU) and fresh air inlets (641FA, 643FA and 610FA) — see accessories on Page 5.

- Item too large to ship via UPS/FedEx. Item shipped common carrier at minimum rates.
- * All pricing reflects the individual item cost. You must order in multiples as indicated.
- ◆ UL listed for use over bathtubs and showers when connected to a GFCI protected branch circuit.

Range Hoods — Chimney



6" Round Duct — Internal Blower
370 CFM, 7.0 Sones

Broan® Elite RM51000 Series

The 51000 Series is a wall-mounted chimney hood with sleek, graceful curves that is engineered to meet the requirements of today's highly styled, conventional appliances and kitchens. Its 370 CFM centrifugal blower and multi-speed control with Heat Sentry™ provide quiet, effective performance. Halogen lighting (bulbs included) accentuates the beauty of a fully enclosed bottom containing dishwasher-safe filters.

Model No.	Description	Std. Pk.	List Price	Code
RM519004	35-7/16" (90cm) Stainless Steel Chimney Hood	1	\$1,287.68	DH
RFX5104	Ducted Flue Extension for 10' ceilings	1	\$283.04	HA
RRK51	Non-ducted Recirculation Kit	1	\$147.16	HA
FILTER SQUARE	Replacement Non-ducted Charcoal Filter (for RM51000, RM52000 and RM53000)	1	\$59.44	HA
ARP6	CFM Reducer Kit. Reduces CFM to less than 300 CFM, 6" round.	5 *	\$49.18	AC

Range hoods work with make-up dampers (MD6TU, MD8TU and MD10TU) and fresh air inlets (641FA, 643FA and 610FA) — see accessories on Page 5.

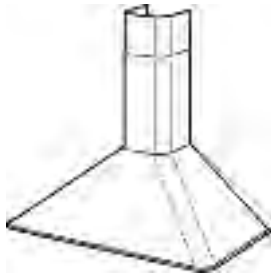

6" Round Duct — Internal Blower
290 CFM, 6.5 Sones

Broan® Elite RM50000 Series

The 50000 Series combines European design with tremendous value to meet the requirements of today's conventional appliance and kitchen styles. Its 290 CFM centrifugal blower and multi-speed control with Heat Sentry™ provide quiet, effective performance. A fully enclosed bottom contains a dishwasher-safe filter for easy cleaning. Plus, dual lighting provides excellent cooktop illumination.

Model No.	Description	Std. Pk.	List Price	Code
30"	RM503001 ● White Chimney Hood	1	\$976.40	DH
	RM503004 ● Stainless Steel Chimney Hood	1	\$976.40	DH
	RM503023 ● Black Chimney Hood	1	\$976.40	DH
36"	RM503601 ● White Chimney Hood	1	\$1,066.96	DH
	RM503604 ● Stainless Steel Chimney Hood	1	\$1,066.96	DH
	RM503623 ● Black Chimney Hood	1	\$1,066.96	DH
RFX5001	Ducted Flue Extension for 9' to 10' ceilings — White	1	\$283.04	HA
RFX5004	Ducted Flue Extension for 9' to 10' ceilings — Stainless Steel	1	\$283.04	HA
RFXN5004	Non-ducted Flue Extension for 9' to 10' ceilings — Stainless Steel	1	\$283.04	HA
RFX5023	Ducted Flue Extension for 9' to 10' ceilings — Black	1	\$283.04	HA
FILTEREB40	Replacement Non-ducted Charcoal Filter (for RMP17004 and RM50000)	1	\$93.42	HA

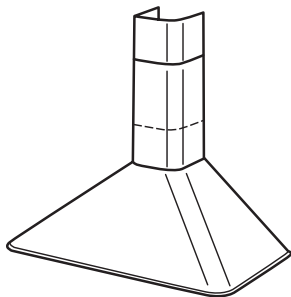

6" Round Duct — Internal Blower
High — 290 CFM, 5.5 Sones
Normal — 135 CFM, 0.5 Sones

Broan® Elite RME50000 Series (ENERGY STAR®)

The RME Series model is part of our new ENERGY STAR® hood offering and an extension of our popular RM50000 chimney hood line. Designed to provide energy efficient operation with a very quiet 290 CFM centrifugal blower. Features include 3-speed slide control, Heat Sentry™, dual 13 watt fluorescent lighting and a dishwasher-safe filter.

Model No.	Description	Std. Pk.	List Price	Code
RME5030SS ●	30" Stainless Steel Chimney Hood	1	\$1,052.58	RH
RFX5004	Ducted Flue Extension for 9' to 10' ceilings — Stainless Steel	1	\$283.04	HA

- Item too large to ship via UPS/FedEx. Item shipped common carrier at minimum rates.
- * All pricing reflects the individual item cost. You must order in multiples as indicated.
- ◆ UL listed for use over bathtubs and showers when connected to a GFCI protected branch circuit.

Range Hoods — Downdrafts

Broan® Elite RMDD Series Downdraft System

Designed specifically to be compatible with most conventional and commercial style cooktops combining a sensational appearance with high performance features. Stainless steel construction on all exposed surfaces provides a durable finish and an unforgettable look.

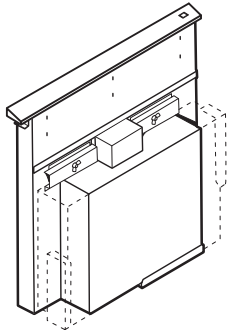

- 3-1/4" x 10" Duct — Internal Blower
500 CFM
- 3-1/4" x 14" Duct — Internal Blower
500 CFM
- 3-1/4" x 14" Duct — External Blower
280 – 1500 CFM

Model No.	Description	Std. Pk.	List Price	Code
30" RMDD3004	Downdraft with Internal Blower	1	\$1,715.08	DH
RMDD3004EX	Downdraft for External Blower. Fits 3-1/4" x 14" duct. Transition (Models 459 & 414) required to 10" rd. Blowers are ordered separately. Select from Models 331H, 332H, 335, 336, HLB3, HLB6, HLB9 and HLB11 on Page 37.	1	\$1,372.60	DH
36" RMDD3604	● Downdraft with Internal Blower	1	\$1,763.16	DH
RMDD3604EX	● Downdraft for External Blower. Fits 3-1/4" x 14" duct. Transition (Models 459 & 414) required to 10" rd. Blowers are ordered separately. Select from Models 331H, 332H, 335, 336, HLB3, HLB6, HLB9 and HLB11 on Page 37.	1	\$1,409.36	DH
48" RMDD4804	● Downdraft with Internal Blower	1	\$1,938.60	DH
RMDD4804EX	● Downdraft for External Blower. Fits 3-1/4" x 14" duct. Transition (Models 459 & 414) required to 10" rd. Blowers are ordered separately. Select from Models 331H, 332H, 335, 336, HLB3, HLB6, HLB9 and HLB11 on Page 37.	1	\$1,599.06	DH
RMDDRKBK	Remote Button Kit	1	\$70.74	HA
ARP310	CFM Reducer Kit. Reduces CFM to less than 300 CFM, 3-1/4" x 10".	5 *	\$49.18	AC

Downdrafts work with make-up dampers (MD6TU, MD8TU and MD10TU) and fresh air inlets (641FA, 643FA and 610FA) — see accessories on Page 5.

Broan® 27000 Series Downdraft System ECLIPSE®

Ultimate styling complements virtually every cooktop style. Mounts behind most built-in cooktops in island, peninsula and wall mount installations. The unit mounts flush with the cooktop when not in operation, and is activated by light pressure on the cover which automatically raises the chimney 7" above the cooktop. The elevated chimney enables smoke and vapor to be captured at the top of most cooking vessels. A touch on the top of the chimney retracts it to its down position. Washable aluminum filters.



- 3-1/4" x 10" Duct — Internal Blower
500 CFM

Model No.	Description	Std. Pk.	List Price	Code
30" 273003	Downdraft with stainless steel cover. 28" wide intake fits most nominal 30" wide cooktops.	1	\$1,047.58	DH
273001C	White Cover Only — Optional	1	\$83.62	HA
273002C	■ Bisque Cover Only — Optional	1	\$83.62	HA
273023C	Black Cover Only — Optional	1	\$83.62	HA
36" 273603	● Downdraft with stainless steel cover. 34" wide intake fits most nominal 36" wide cooktops.	1	\$1,047.58	DH
273601C	White Cover Only — Optional	1	\$83.62	HA
273602C	■ Bisque Cover Only — Optional	1	\$83.62	HA
273623C	Black Cover Only — Optional	1	\$83.62	HA
ARP310	CFM Reducer Kit. Reduces CFM to less than 300 CFM, 3-1/4" x 10".	5 *	\$49.18	AC

For replacement filters, see Broan's Replacement Parts Guide.

Downdrafts work with make-up dampers (MD6TU, MD8TU and MD10TU) and fresh air inlets (641FA, 643FA and 610FA) — see accessories on Page 5.

■ Limited quantities available.

- Item too large to ship via UPS/FedEx. Item shipped common carrier at minimum rates.
- * All pricing reflects the individual item cost. You must order in multiples as indicated.
- ◆ UL listed for use over bathtubs and showers when connected to a GFCI protected branch circuit.

Range Hoods — Downdrafts

Broan® 28000 Series Remote Downdraft System ECLIPSE®



3-1/4" x 10" Duct — External Blower
280 – 1500 CFM

Model No.	Description	Std. Pk.	List Price	Code
30" 283003	Downdraft with stainless steel cover. Designed for use with exterior mounted blowers. 28" wide intake fits most nominal 30" wide cooktops. Transition required to 10" rd. Blower is ordered separately. Select from Models 332H, HLB3, HLB6, HLB9 and HLB11 on Page 37 (332KR not required).	1	\$727.64	DH
273001C	White Cover Only — Optional	1	\$83.62	HA
273002C	■ Bisque Cover Only — Optional	1	\$83.62	HA
273023C	Black Cover Only — Optional	1	\$83.62	HA
36" 283603	● Downdraft with stainless steel cover. Designed for use with exterior mounted blowers. 34" wide intake fits most nominal 36" wide cooktops. Transition required to 10" rd. Blower is ordered separately. Select from Models 332H, HLB3, HLB6, HLB9 and HLB11 on Page 37 (332KR not required).	1	\$727.64	DH
273601C	White Cover Only — Optional	1	\$83.62	HA
273602C	■ Bisque Cover Only — Optional	1	\$83.62	HA
273623C	Black Cover Only — Optional	1	\$83.62	HA

Downdrafts work with make-up dampers (MD6TU, MD8TU and MD10TU) and fresh air inlets (641FA, 643FA and 610FA) — see accessories on Page 5.

■ Limited quantities available.

Range Hoods — Power Packs

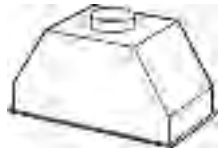

6" Round Duct — Internal Blower
400 CFM, 9.0 Sones
8" Round Duct — External Blower
280 – 1500 CFM

Broan® Elite RMP Series Custom Power Pack

The Rangemaster Custom Power Pack is designed to fit flush with the bottom of a cabinet or custom hood (see "RML" Liner — Page 32). The interior or exterior blowers are combined with multi-speed control with Heat Sentry™ to provide quiet and effective performance. Halogen lighting complements the beauty of a fully enclosed bottom containing dishwasher-safe filters. Optional non-ducted filters (FILTEREB40) for indoor exhaust recirculation. Some ductwork required.

Model No.	Description	Std. Pk.	List Price	Code
RMP17004	Power Pack	1	\$1,075.46	DH
RMPE7004	Power Pack for External Blower. Blowlers are ordered separately. Select from Models 331H, 332H, 335, 336, HLB3, HLB6, HLB9 and HLB11 on Page 37.	1	\$764.12	DH
FILTEREB40	Replacement Non-ducted Charcoal Filter (for RMP17004 and RM50000)	1	\$93.42	HA
GU10	Halogen Bulb; 120V, 50W max.	10 *	\$17.06	AC
ARP6	CFM Reducer Kit. Reduces CFM to less than 300 CFM, 6" round.	5 *	\$49.18	AC

Range hoods work with make-up dampers (MD6TU, MD8TU and MD10TU) and fresh air inlets (641FA, 643FA and 610FA) — see accessories on Page 5.

Broan® Elite RMIP Series Pro-Style Insert

Pro-style insert fits flush with the bottom of the cabinet or custom hood. Internal and external centrifugal blowers from 280 to 1500 CFM with Multi-speed control and Heat Sentry™ to provide quiet and effective performance. Halogen Lighting (bulbs not included) for brilliant illumination and easy-to-clean fully enclosed design. Options include baffle filters and remote wall control.

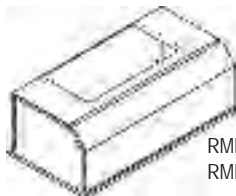

RMP33
RMP45
3-1/4" x 10" Duct — Internal Blower
460 CFM, 10.5 Sones
3-1/4" x 14" Duct — External Blower
850 CFM, 10.5 Sones
10" Round Duct — External Blower
280 – 1500 CFM



RMP1WC

Model No.	Description	Std. Pk.	List Price	Code
RMP33	Pro-Style Insert (blower sold separately), 33" Stainless, Micro Filters; for use with P5, P8, 331H, 332H, 335, 336, HLB3, HLB6, HLB9 and HLB11 on Page 37	1	\$776.58	DH
RMIP45	● Pro-Style Insert (blower sold separately), 45", Stainless, Micro Filters; for use with P5, P8, 331H, 332H, 335, 336, HLB3, HLB6, HLB9 and HLB11 on Page 37	1	\$855.82	DH
RMP1WC	Wall-Mounted Remote Control for RMIP Series, Stainless	1	\$138.68	HA
RBFIP33	Baffle Filter Kit for RMP33, Stainless	1	\$220.72	AC
RBFIP45	Baffle Filter Kit for RMIP45, Stainless	1	\$272.22	AC
PAR20	Halogen Bulb; 120V, 50W	6 *	\$23.20	AC
ARP310	CFM Reducer Kit. Reduces CFM to less than 300 CFM when used with P5 blower, 3-1/4" x 10".	5 *	\$49.18	AC

Range hoods work with make-up dampers (MD6TU, MD8TU and MD10TU) and fresh air inlets (641FA, 643FA and 610FA) — see accessories on Page 5.

- Item too large to ship via UPS/FedEx. Item shipped common carrier at minimum rates.
- * All pricing reflects the individual item cost. You must order in multiples as indicated.
- ◆ UL listed for use over bathtubs and showers when connected to a GFCI protected branch circuit.

Range Hoods — Power Packs

Broan® Elite RML Series Liners for Inserts and Power Packs

Liners feature an adjustable nose that moves 3" to provide application flexibility and a 4" depth for excellent capture.



Model No.	Description	Std. Pk.	List Price	Code
RML3336S	Liner for RMP33 — 36", Stainless (Adj. depth 22.5" - 25.5")	1	\$313.80	HA
RML3342S	Liner for RMP33 — 42", Stainless (Adj. depth 22.5" - 25.5")	1	\$321.10	HA
RML4548S	Liner for RMP45 — 48", Stainless (Adj. depth 22.5" - 25.5")	1	\$339.30	HA
RML4554S	● Liner for RMP45 — 54", Stainless (Adj. depth 22.5" - 25.5")	1	\$370.88	HA
RML4560S	● Liner for RMP45 — 60", Stainless (Adj. depth 22.5" - 25.5")	1	\$375.96	HA
RML7030L	Liner for RMP1-E — 30", Stainless (Adj. depth 20.5" - 23.5")	1	\$284.22	HA
RML7030S	Liner for RMP1-E — 30", Stainless (Adj. depth 17.5" - 20.5")	1	\$265.92	HA
RML7036L	Liner for RMP1-E — 36", Stainless (Adj. depth 20.5" - 23.5")	1	\$321.10	HA
RML7036S	Liner for RMP1-E — 36", Stainless (Adj. depth 17.5" - 20.5")	1	\$313.80	HA
RML7048L	Liner for RMP1-E — 48", Stainless (Adj. depth 20.5" - 23.5")	1	\$393.44	HA
RML7048S	Liner for RMP1-E — 48", Stainless (Adj. depth 17.5" - 20.5")	1	\$339.30	HA

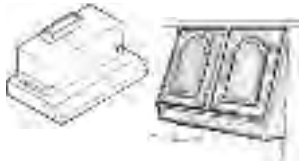

Broan® 10000 Series Custom Hood Kit

Model 103023 fits wood hoods from 30" to 42" wide. Comes standard for 30" installation. Order Extension Kit No. 97009790 for installations up to 36". 42" requires some fabrication. Requires 16-1/2" minimum vertical clearance inside hood. Must use Model 103123 Rough-In Kit below.

3-1/4" x 10" Duct — Internal Blower
360 CFM — 4.5 Sones Vertical
360 CFM — 4.5 Sones Horizontal

Model No.	Description	Std. Pk.	List Price	Code
103023	■ ● Wood Hood Insert	1	\$512.70	DH
103123	■ Wood Hood Insert Rough-In Kit (Required)	1	\$64.98	DH

For replacement filters, see Broan's Replacement Parts Guide.

Range hoods work with make-up dampers (MD6TU, MD8TU and MD10TU) and fresh air inlets (641FA, 643FA and 610FA) — see accessories on Page 5.

■ Limited quantities available.

Broan® PM500SS Power Pack

This power pack is designed to fit flush to custom cabinet/hood or can be used with optional liners to protect cabinetry.

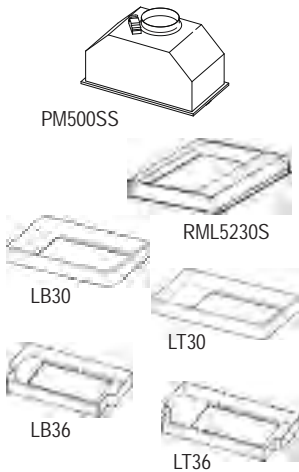

Model No.	Description	Std. Pk.	List Price	Code
PM500SS	Stainless Steel Power Pack, 20-1/2", 500 CFM	1	\$762.20	DH
<u>Liners</u>				
RML5230S	30" Stainless Adjustable Liner (Adjustable depth 17-1/2" to 20-1/2")	1	\$265.92	HA
LT30	30" Painted Liner	1	\$99.56	HA
LT36	36" Painted Liner	1	\$110.18	HA
LB30	30" Painted Liner	1	\$99.56	HA
LB36	36" Painted Liner	1	\$110.18	HA
<u>Non-ducted Recirculation</u>				
359NDK	Non-duct Accessory Kit for PM500 (99010374 - Replacement charcoal filter)	1	\$140.68	AC

Model PM500SS works with make-up air dampers (MD6TU, MD8TU and MD10TU) and fresh air inlets (641FA, 643FA and 610FA) — see accessories on Page 5.

- Item too large to ship via UPS/FedEx. Item shipped common carrier at minimum rates.
- * All pricing reflects the individual item cost. You must order in multiples as indicated.
- ◆ UL listed for use over bathtubs and showers when connected to a GFCI protected branch circuit.

Range Hoods — Power Packs

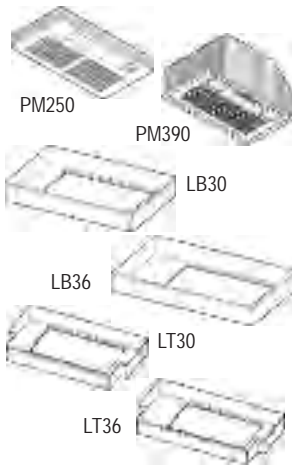

PM250 7" Round Duct — Internal Blower 250 CFM — 8.0 Sones
 PM390 6" Round Duct — Internal Blower 390 CFM — 6.0 Sones

Broan® PM Series Flush-Fit Power Packs

Flush-fitting integrated power packs and liners provide modern style, ventilation, dual 40 watt lighting (bulbs sold separately) and protection for custom cabinet and hood applications. The PM390 has a 390 CFM internal blower and features a three-speed slide control with Heat Sentry™. The PM250 has a 250 CFM two-speed fan with rocker switch control. Both units are designed to work with optional LT or LB liners.

Model No.	Description	Std. Pk.	List Price	Code
PM250	Power Pack, Silver Grille	1	\$193.60	RH
PM390	Power Pack, Silver Grille	1	\$436.20	RH
356NDK +	Non-duct Accessory Kit for PM250	1	\$114.86	HA
357NDK +	Non-duct Accessory Kit for PM390	1	\$140.68	HA
LB30 +	Liner 30N, Box Shape, for PM250, PM390 and PME300	1	\$99.56	HA
LB36 +	Liner 36N, Box Shape, for PM250, PM390 and PME300	1	\$110.18	HA
LT30 +	Liner 30N, T Shape, for PM250, PM390 and PME300	1	\$99.56	HA
LT36 +	Liner 36N, T Shape, for PM250, PM390 and PME300	1	\$110.18	HA
ARP6 +	CFM Reducer Kit. Reduces CFM to less than 300 CFM, 6" round.	5 *	\$49.18	AC

+ Purchase separately.

Model PM390 works with make-up air dampers (MD6TU, MD8TU and MD10TU) and fresh air inlets (641FA, 643FA and 610FA) — see accessories on Page 5.

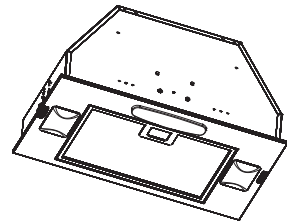

6" Round Duct — Internal Blower
 High — 290 CFM, 5.0 Sones
 Normal — 130 CFM, 0.5 Sones

Broan® PME300 Series Flush Fit Power Pack (ENERGY STAR®)

The PME Series model is part of our new ENERGY STAR® hood offering and an extension of our PM390 power pack line. Designed to provide energy efficient operation with a very quiet 290 CFM centrifugal blower. Features include 3-speed slide control, Heat Sentry™, dual 13 watt fluorescent light and a dishwasher-safe filter.

Model No.	Description	Std. Pk.	List Price	Code
PME300	Power Pack, Silver	1	\$606.84	RH
LB30 +	Liner 30N, Box Shape, for PM250, PM390 and PME300	1	\$99.56	HA
LB36 +	Liner 36N, Box Shape, for PM250, PM390 and PME300	1	\$110.18	HA
LT30 +	Liner 30N, T Shape, for PM250, PM390 and PME300	1	\$99.56	HA
LT36 +	Liner 36N, T Shape, for PM250, PM390 and PME300	1	\$110.18	HA

+ Purchase separately.

- Item too large to ship via UPS/FedEx. Item shipped common carrier at minimum rates.
- * All pricing reflects the individual item cost. You must order in multiples as indicated.
- ◆ UL listed for use over bathtubs and showers when connected to a GFCI protected branch circuit.

Range Hoods — High Performance

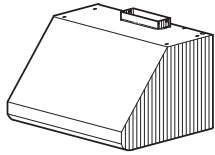

3-1/4" x 10" Duct — Internal Blower
600 CFM, 1.5 Sones
4-1/2" x 18" Duct — Internal Blower
1200 CFM, 2.0 Sones
10" Round Duct — External Blower
280 – 1500 CFM

Pro-Style Hoods — E60000 Series

The E60000 Series has a choice of two internal blowers or eight external blower options. Features include bright halogen lighting, dishwasher-safe baffle filters with a removable grease rail, variable speed control and Heat Sentry™. Options include a soffit flue, backsplash and non-duct recirculation. It is also compatible with Broan make-up air dampers. (Requires 50 watt max. halogen bulbs, not included; two in 30" and 36" — three in 42" and 48" widths.) Duct horizontal or vertical.

Model No.	Description	Std. Pk.	List Price	Code
<u>Internal Blower</u>				
30" E6030SS ●	Stainless Shell	1	\$1,907.64	DH
36" E6036SS ●	Stainless Shell	1	\$1,983.58	DH
42" E6042TSS ●	Stainless Shell	1	\$2,332.70	DH
48" E6048TSS ●	Stainless Shell	1	\$2,409.66	DH
<u>External Blower</u>				
30" E60E30SS ●	Stainless Shell	1	\$1,616.48	DH
36" E60E36SS ●	Stainless Shell	1	\$1,709.88	DH
42" E60E42SS ●	Stainless Shell	1	\$1,754.42	DH
48" E60E48SS ●	Stainless Shell	1	\$1,842.56	DH
AEE60302SS	12" High Soffit, 30" Hood	1	\$299.76	HA
AEE60362SS	12" High Soffit, 36" Hood	1	\$311.34	HA
AEE60422SS ●	12" High Soffit, 42" Hood	1	\$322.98	HA
AEE60482SS ●	12" High Soffit, 48" Hood	1	\$334.62	HA
ANKE60302SS	Non-Duct Recirculation Kit, 30" Hood	1	\$346.48	HA
ANKE60362SS	Non-Duct Recirculation Kit, 36" Hood	1	\$358.98	HA
ANKE60422SS	Non-Duct Recirculation Kit, 42" Hood	1	\$448.02	HA
ANKE60482SS	Non-Duct Recirculation Kit, 48" Hood	1	\$453.52	HA
ARP310	CFM Reducer Kit, reduces CFM to less than 300 CFM, 3-1/4" x 10"	5 *	\$49.18	AC
GU10	Halogen Bulb; 120V, 50W max.	10 *	\$17.06	AC
MD6T ∅	6" Automatic Make-Up Air Damper	1	\$174.86	HA
MD8T ∅	8" Automatic Make-Up Air Damper	1	\$188.30	HA
MD10T ∅	10" Automatic Make-Up Air Damper	1	\$307.66	HA

∅ Work with fresh air inlets (641FA, 643FA and 610FA) — see accessories on Page 5.

- Item too large to ship via UPS/FedEx. Item shipped common carrier at minimum rates.
- * All pricing reflects the individual item cost. You must order in multiples as indicated.
- ◆ UL listed for use over bathtubs and showers when connected to a GFCI protected branch circuit.

Range Hoods — High Performance

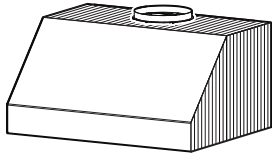

10" Round Duct — Internal Blower
1100 CFM — 12.0 Sones Vertical

Broan® Elite Pro Outdoor Hood — EPD61 Series

The Pro Outdoor is made of corrosion resistant stainless steel and provides an extra deep 27" design, giving it improved performance and best-in-class capture! It includes a powerful 1100 CFM internal blower for more exhaust capacity, yet quiet operation. An optional 3" wall extension provides a full 30" of cook top coverage for a larger capture area. Requires 50 watt halogen bulbs (not included); two in 36" and three in 48".

Model No.	Description	Std. Pk.	List Price	Code
36" EPD6136SS ●	Professional Grade Brushed Stainless Steel Range Hood	1	\$2,440.08	OH
48" EPD6148SS ●	Professional Grade Brushed Stainless Steel Range Hood	1	\$2,758.34	OH
60" EPD6160SS ●	Professional Grade Brushed Stainless Steel Range Hood	1	\$3,639.00	OH
AWEPD36SS	3" Wall extension for 36" range hood (provides 30" depth)	1	\$387.24	OH
AWEPD48SS	3" Wall extension for 48" range hood (provides 30" depth)	1	\$437.10	OH
AWEPD60SS	3" Wall extension for 60" range hood (provides 30" depth)	1	\$469.00	OH
AEEP6SS	6" Flue cover for 8' ceiling (for standard 27" depth hood)	1	\$182.48	OH
AEEP6SSE	6" Flue cover for 8' ceiling (for extended 30" depth hood)	1	\$199.44	OH
AEEP18SS	18" Flue cover for 9' ceiling (for standard 27" depth hood)	1	\$318.28	OH
AEEP18SSE	18" Flue cover for 9' ceiling (for extended 30" depth hood)	1	\$335.24	OH
AEEP30SS	30" Flue cover for 10' ceiling (for standard 27" depth hood)	1	\$420.12	OH
AEEP30SSE	30" Flue cover for 10' ceiling (for extended 30" depth hood)	1	\$437.10	OH
AEEP2445SS	Professional Grade Brushed Stainless Steel Flue Extension, standard 13" depth and height adjustable from 24" to 45"	1	\$843.42	OH
AEEP2445SSE	Professional Grade Brushed Stainless Steel Flue Extension, extended 16" depth and height adjustable from 24" to 45"	1	\$875.26	OH
GU10	Halogen Bulb; 120V, 50W max.	10 *	\$17.06	AC

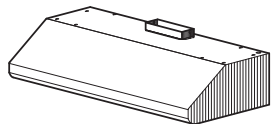

3-1/4" x 10" Duct — Internal Blower
600 CFM, 1.5 Sones
4-1/2" x 18" Duct — Internal Blower
1200 CFM, 2.0 Sones
10" Round Duct — External Blower
280 – 1200 CFM

Pro-Style Hoods — E64000 Series

The E64000 Series has a choice of two internal blowers or eight external blower options. Features include bright halogen lighting, dishwasher-safe baffle filters with a removable grease rail, variable speed control and Heat Sentry™. Options include a soffit flue, backsplash and non-duct recirculation. It is also compatible with Broan make-up air dampers. (Requires 50 watt max. halogen bulbs, not included; two in 30" and 36" — three in 42" and 48" widths.) Duct horizontal or vertical.

Model No.	Description	Std. Pk.	List Price	Code
Internal Blower				
30" E6430SS	Stainless Shell	1	\$1,268.42	DH
36" E6436SS	Stainless Shell	1	\$1,295.24	DH
42" E6442SS ●	Stainless Shell	1	\$1,393.08	DH
48" E6448SS ●	Stainless Shell	1	\$1,449.34	DH
E6448TSS ●	Stainless Shell	1	\$1,717.36	DH
External Blower				
30" E64E30SS	Stainless Shell	1	\$1,027.70	DH
36" E64E36SS	Stainless Shell	1	\$1,078.44	DH
42" E64E42SS ●	Stainless Shell	1	\$1,181.82	DH
48" E64E48SS ●	Stainless Shell	1	\$1,246.02	DH
ANKE60302SS	Non-Duct Recirculation Kit, 30" Hood	1	\$346.48	HA
ANKE60362SS	Non-Duct Recirculation Kit, 36" Hood	1	\$358.98	HA
ANKE60422SS	Non-Duct Recirculation Kit, 42" Hood	1	\$448.02	HA
ANKE60482SS	Non-Duct Recirculation Kit, 48" Hood	1	\$453.52	HA
ARP310	CFM Reducer Kit, reduces CFM to less than 300 CFM, 3-1/4" x 10"	5 *	\$49.18	AC
GU10	Halogen Bulb; 120V, 50W max.	10 *	\$17.06	AC
MD6T ∅	6" Automatic Make-Up Air Damper	1	\$174.86	HA
MD8T ∅	8" Automatic Make-Up Air Damper	1	\$188.30	HA
MD10T ∅	10" Automatic Make-Up Air Damper	1	\$307.66	HA

∅ Work with fresh air inlets (641FA, 643FA and 610FA) — see accessories on Page 5.

- Item too large to ship via UPS/FedEx. Item shipped common carrier at minimum rates.
- * All pricing reflects the individual item cost. You must order in multiples as indicated.
- ◆ UL listed for use over bathtubs and showers when connected to a GFCI protected branch circuit.

Range Hoods — High Performance

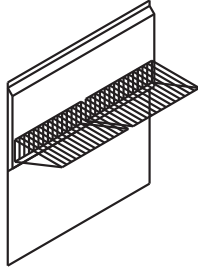

Broan® RMP Series Backsplash

Professional style backsplash with folding storage racks.

Model No.	Description	Std. Pk.	List Price	Code
30" RMP3004	Stainless Steel Backsplash	1	\$537.06	HA
36" RMP3604	Stainless Steel Backsplash	1	\$574.82	HA
42" RMP4204	Stainless Steel Backsplash	1	\$612.48	HA
48" RMP4804	Stainless Steel Backsplash	1	\$650.20	HA
54" RMP5404 ●	Stainless Steel Backsplash	1	\$688.00	HA
60" RMP6004 ●	Stainless Steel Backsplash	1	\$725.66	HA



Broan® Elite E661 Series

The E661 Series models are part of our new generation of range hoods; stylish, powerful and most of all, quieter than ever. Designed for high performance cooking applications, a sleek under-cabinet hood with ultra quiet internal 600 CFM blower. Features include multi-speed electronic controls with Heat Sentry™, three-level dual halogen lighting (bulbs included) and large professional style dishwasher-safe mesh filters.

Model No.	Description	Std. Pk.	List Price	Code
30" E66130BL ■	Black Range Hood	1	\$1,131.78	RH
E66130SS ■	Stainless Steel Range Hood	1	\$1,215.28	RH
E66130WH ■	White Range Hood	1	\$1,131.78	RH
36" E66136BL ■	Black Range Hood	1	\$1,167.52	RH
E66136SS ■	Stainless Steel Range Hood	1	\$1,253.66	RH
E66136WH ■	White Range Hood	1	\$1,167.52	RH
42" E66142SS ■	Stainless Steel Range Hood	1	\$1,293.20	RH
GU10	Halogen Bulb; 120V, 50W max.	10 *	\$17.06	AC
T460	Transition; 3-1/4" x 14" to 7" Round	1	\$34.90	AC
T461	Adapter; 3-1/4" x 14" to 3-1/4" x 10"	1	\$45.24	AC
WC638	Wall Cap, 3-1/4" x 14", Black	1	\$95.00	AC
ARP314	CFM Reducer Kit. Reduces CFM to less than 300 CFM, 3-1/4" x 14".	5 *	\$49.18	AC

3-1/4" x 14" Duct — Internal Blower
 Horizontal: Normal (low) —
 130 CFM, 0.3 Sones High —
 310 CFM, 2.5 Sones Boost —
 600 CFM, 8.5 Sones

Vertical: Normal (low) —
 120 CFM, 0.4 Sones High —
 290 CFM, 2.5 Sones Boost —
 550 CFM, 8.5 Sones

Range hoods work with make-up dampers (MD6TU, MD8TU and MD10TU) and fresh air inlets (641FA, 643FA and 610FA) — see accessories on Page 5.

■ Limited quantities available.

- Item too large to ship via UPS/FedEx. Item shipped common carrier at minimum rates.
- * All pricing reflects the individual item cost. You must order in multiples as indicated.
- ◆ UL listed for use over bathtubs and showers when connected to a GFCI protected branch circuit.

Broan® Elite Internal and External Mounted Blowers

Broan internal and external blowers are specially designed to provide powerful, but quiet kitchen ventilation solutions to meet the unique needs of any application.

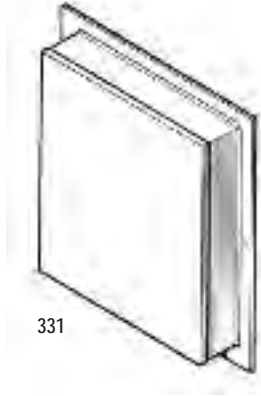

331

Model No.	Description	Std. Pk.	List Price	Code
P5	500 CFM Blower for interior mounting for RMIP insert. 3-1/4" x 10" duct size at discharge. 120V / 60 Hz.	1	\$504.92	RH
P8	850 CFM Blower for interior mounting for RMIP insert. 3-1/4" x 14" duct size at discharge. 120V / 60 Hz. Fits only in 36", 42" and 48" range hoods.	1	\$920.68	RH
331H	+ 600 CFM Exterior Blower — 2.3 amps. Fits 10" round duct.	1	\$643.02	DH
332H	+ 900 CFM Exterior Blower — 5.7 amps. Fits 10" round duct.	1	\$835.62	DH
335	+ 1200 CFM Blower for exterior blower. 3.0 total amps. 10" round duct at discharge. 120V.	1	\$1,113.90	DH
336	+ 1500 CFM Blower for exterior blower. 3.8 total amps. 10" round duct at discharge. 120V.	1	\$1,390.56	DH
HLB3	+ 280 CFM In-Line Blower	1	\$424.78	DH
HLB6	+ 600 CFM In-Line Blower	1	\$716.78	DH
HLB9	●+ 800 CFM In-Line Blower	1	\$961.04	DH
HLB11	●+ 1100 CFM In-Line Blower	1	\$1,146.88	DH
332KR	Rough-in Kit for Models 331H, 332H, 335 and 336 exterior blowers and HLB3, HLB6, HLB9 and HLB11 in-line blowers. Fits 10" round duct. Only for use with RMIP insert.	1	\$110.28	HA
72V / 72W	Electronic Variable Speed Control, 6 amp capacity. 120V. Fits single gang box. Suitable for use with 331H, 332H, 335, 336, HLB3, HLB6, HLB9 and HLB11.	1	\$84.92	AC

+ The 332KR will be required if external blower is used with RMIP models.

Note: Broan internal and external blowers are designed and UL listed for use with Broan products only. Use with other manufacturers' products can not be recommended and may result in violation of local electrical codes or practices.

- Item too large to ship via UPS/FedEx. Item shipped common carrier at minimum rates.
- * All pricing reflects the individual item cost. You must order in multiples as indicated.
- ◆ UL listed for use over bathtubs and showers when connected to a GFCI protected branch circuit.

Range Hoods — Under Cabinet

Broan® EVOLUTION™ QP4 Series

EVOLUTION 4 is the ultimate in under-cabinet designs. It is the high performance solution, delivering up to 630 CFM, to complement higher BTU appliances and special cooking needs. Advanced, soft-touch controls include an ambient light sensor and sleep mode. Four 50-watt max. halogen bulbs are included.

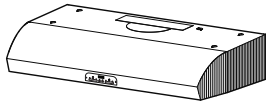

3-1/4" x 14" Duct — Internal Blower
430 CFM, 4.5 Sones Vertical
470 CFM, 4.5 Sones Horizontal
7" Round Duct — Internal Blower
360 CFM, 4.5 Sones
630 CFM, 7.5 Sones
(Boost Mode)

Requires (4) 50 watt GU10 MR16 bulbs (included).

Model No.	Description	Std. Pk.	List Price	Code
30" QP430SS ■	Stainless Steel Range Hood	1	\$960.24	QP
36" QP436SS ■	Stainless Steel Range Hood	1	\$974.90	QP
42" QP442SS ■	Stainless Steel Range Hood	1	\$987.38	QP
BPP3FA30 ■	Replacement Filter	1	\$71.60	QA
BPP3FA36 ■	Replacement Filter	1	\$82.96	QA
BPP3FA42 ■	Replacement Filter	1	\$100.00	QA
BCR1	RF remote control	1	\$88.64	QA
BP87 ■	7" Damper for round discharge range hood. (S97010792 — Single Pack)	3 *	\$11.46	AC
GU10	Halogen Bulb; 120V, 50W max.	10 *	\$17.06	AC
MD6T ∅	6" Automatic Make-Up Air Damper	1	\$174.86	HA
MD8T ∅	8" Automatic Make-Up Air Damper	1	\$188.30	HA
MD10T ∅	10" Automatic Make-Up Air Damper	1	\$307.66	HA
T460	Transition; 3-1/4" x 14" to 7" Round	1	\$34.90	AC
T461	Adapter; 3-1/4" x 14" to 3-1/4" x 10"	1 *	\$45.24	AC
WC638	Wall Cap, 3-1/4" x 14", Black	1	\$95.00	AC

∅ Work with fresh air inlets (641FA, 643FA and 610FA) — see accessories on Page 5.

■ Limited quantities available.

Broan® EVOLUTION™ QP3 Series

EVOLUTION 3 provides ultra quiet operation and a very powerful 450 CFM boost mode. Advanced, soft-touch controls include an ambient light sensor and sleep mode. Four 50-watt max. halogen bulbs are included.

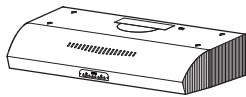

3-1/4" x 10" Duct — Internal Blower
320 CFM, 5.5 Sones Vertical
360 CFM, 5.0 Sones Horizontal
7" Round Duct — Internal Blower
300 CFM, 5.5 Sones
450 CFM, 7.0 Sones
(Boost Mode)

Converts to non-ducted. Add non-ducted filter (available separately).

Requires (4) 50 watt GU10 MR16 bulbs (included).

Model No.	Description	Std. Pk.	List Price	Code
30" QP330BL ■	Black-on-Black Range Hood	1	\$714.84	QP
QP330SS ■	Stainless Steel Range Hood	1	\$776.18	QP
QP330WW ■	White-on-White Range Hood	1	\$714.84	QP
36" QP336BL ■	Black-on-Black Range Hood	1	\$728.46	QP
QP336SS ■	Stainless Steel Range Hood	1	\$789.84	QP
QP336WW ■	White-on-White Range Hood	1	\$728.46	QP
42" QP342BL ■	Black-on-Black Range Hood	1	\$740.96	QP
QP342SS ■	Stainless Steel Range Hood	1	\$802.30	QP
QP342WW ■	White-on-White Range Hood	1	\$740.96	QP
BPPF30	Non-duct Filters for QP130, QP230 and QP330	6 *	\$29.82	QA
BPPF36	Non-duct Filters for QP136, QP236 and QP336	3 *	\$32.24	QA
BPPF42	Non-duct Filters for QP142, QP242 and QP342	1	\$38.92	QA
BPP3FA30	Replacement QP330 aluminum grease filter	1	\$71.60	QA
BPP3FA36	Replacement QP336 aluminum grease filter	1	\$82.96	QA
BPP3FA42	Replacement QP342 aluminum grease filter	1	\$100.00	QA
BCR1	RF remote control	1	\$88.64	QA
BP87 ■	7" Damper for round discharge range hood. (S97010792 — Single Pack)	3 *	\$11.46	AC
GU10	Halogen Bulb; 120V, 50W max.	10 *	\$17.06	AC
MD6T ∅	6" Automatic Make-Up Air Damper	1	\$174.86	HA
MD8T ∅	8" Automatic Make-Up Air Damper	1	\$188.30	HA
MD10T ∅	10" Automatic Make-Up Air Damper	1	\$307.66	HA

∅ Work with fresh air inlets (641FA, 643FA and 610FA) — see accessories on Page 5.

■ Limited quantities available.

- Item too large to ship via UPS/FedEx. Item shipped common carrier at minimum rates.
- * All pricing reflects the individual item cost. You must order in multiples as indicated.
- ◆ UL listed for use over bathtubs and showers when connected to a GFCI protected branch circuit.

Range Hoods — Under Cabinet

Broan® EVOLUTION™ QP2 Series

EVOLUTION 2 has the control, power and easy-to-clean features every cook loves. Very quiet operation with a 350 CFM boost mode, the QP2 four 50-watt max. halogen bulbs (included) and a soft-touch three-speed control panel.

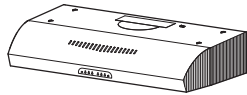

3-1/4" x 10" Duct — Internal Blower
310 CFM, 6.0 Sones Vertical
350 CFM, 5.0 Sones Horizontal
7" Round Duct — Internal Blower
280 CFM, 6.0 Sones

Requires (4) 50 watt GU10 MR16 bulbs (included).

Model No.	Description	Std. Pk.	List Price	Code
30" QP230BC ■	Bisque-on-Bisque Range Hood	1	\$529.58	QP
QP230BL ■	Black-on-Black Range Hood	1	\$529.58	QP
QP230SS ■	Stainless Steel Range Hood	1	\$589.82	QP
QP230WW ■	White-on-White Range Hood	1	\$529.58	QP
36" QP236BC ■	Bisque-on-Bisque Range Hood	1	\$542.08	QP
QP236BL ■	Black-on-Black Range Hood	1	\$542.08	QP
QP236SS ■	Stainless Steel Range Hood	1	\$602.32	QP
QP236WW ■	White-on-White Range Hood	1	\$542.08	QP
42" QP242BC ■	Bisque-on-Bisque Range Hood	1	\$555.72	QP
QP242BL ■	Black-on-Black Range Hood	1	\$555.72	QP
QP242SS ■	Stainless Steel Range Hood	1	\$615.96	QP
QP242WW ■	White-on-White Range Hood	1	\$555.72	QP
BPPF30	Non-duct Filters for QP130, QP230 and QP330	6 *	\$29.82	QA
BPPF36	Non-duct Filters for QP136, QP236 and QP336	3 *	\$32.24	QA
BPPF42	Non-duct Filters for QP142, QP242 and QP342	1	\$38.92	QA
BPP2FA30	Replacement QP230 aluminum grease filter	1	\$56.82	QA
BPP2FA36	Replacement QP236 aluminum grease filter	1	\$68.18	QA
BPP2FA42	Replacement QP242 aluminum grease filter	1	\$85.26	QA
BP87 ■	7" Damper for round discharge range hood. (S97010792 — Single Pack)	3 *	\$11.46	AC
GU10	Halogen Bulb; 120V, 50W max.	10 *	\$17.06	AC

■ Limited quantities available.

Range hoods work with make-up dampers (MD6TU, MD8TU and MD10TU) and fresh air inlets (641FA, 643FA and 610FA) — see accessories on Page 5.

Broan® EVOLUTION™ QP1 Series

EVOLUTION 1 has the same great basic features of the QP2, with a 300 CFM boost mode and a two-speed control for blowers and lighting. Four 35-watt halogen bulbs (not included) light the cooktop.



3-1/4" x 10" Duct — Internal Blower
280 CFM, 5.0 Sones Vertical
300 CFM, 5.0 Sones Horizontal
7" Round Duct — Internal Blower
260 CFM, 5.5 Sones

Converts to non-ducted. Add non-ducted filter (available separately).

Requires (4) 35 watt GU10 MR16 bulbs (purchase separately).

Model No.	Description	Std. Pk.	List Price	Code
30" QP130BL ■	Black-on-Black Range Hood	1	\$348.44	QP
QP130SS ■	Stainless Steel Range Hood	1	\$405.72	QP
QP130WW ■	White-on-White Range Hood	1	\$348.44	QP
36" QP136BL ■	Black-on-Black Range Hood	1	\$361.56	QP
QP136SS ■	Stainless Steel Range Hood	1	\$418.84	QP
QP136WW ■	White-on-White Range Hood	1	\$361.56	QP
42" QP142BL ■	Black-on-Black Range Hood	1	\$392.90	QP
QP142SS ■	Stainless Steel Range Hood	1	\$453.86	QP
QP142WW ■	White-on-White Range Hood	1	\$392.90	QP
BPPF30	Non-duct Filters for QP130, QP230 and QP330	6 *	\$29.82	QA
BPPF36	Non-duct Filters for QP136, QP236 and QP336	3 *	\$32.24	QA
BPPF42	Non-duct Filters for QP142, QP242 and QP342	1	\$38.92	QA
BPPFA30	Replacement QP130 aluminum grease filters	3 *	\$53.70	QA
BPPFA36	Replacement QP136 aluminum grease filters	3 *	\$60.86	QA
BPPFA42	Replacement QP142 aluminum grease filter	1	\$68.18	QA
BP87 ■	7" Damper for round discharge range hood. (S97010792 — Single Pack)	3 *	\$11.46	AC
GU1035	Halogen Bulb; 120V, 35W	10 *	\$15.92	AC

■ Limited quantities available.

- Item too large to ship via UPS/FedEx. Item shipped common carrier at minimum rates.
- * All pricing reflects the individual item cost. You must order in multiples as indicated.
- ◆ UL listed for use over bathtubs and showers when connected to a GFCI protected branch circuit.

Range Hoods — Under Cabinet

Broan® QS3 Series ALLURE III

The popular QS3 Series range hood provides an ultra quiet, extra powerful 430 CFM boost mode. Easy-to-clean bottom pan and filters with three-level lighting and Advanced Heat Sentry™. Optional non-duct operation. Works with optional make-up air dampers.



3-1/4" x 10" Duct — Internal Blower
280 CFM — 5.5 Sones Vertical
300 CFM — 4.5 Sones Horizontal
7" Round Duct — Internal Blower
270 CFM — 5.5 Sones Vertical
(Boost Mode) 430 CFM,
8.0 Sones Horizontal

Converts to non-ducted. Add non-ducted filter (available separately).

	Model No.	Description	Std. Pk.	List Price	Code
30"	QS330AA ■	Almond-on-Almond Range Hood	1	\$672.46	AH
	QS330BC ■	Bisque-on-Bisque Range Hood	1	\$672.46	AH
	QS330BL ■	Black Range Hood	1	\$672.46	AH
	QS330SS ■	Stainless Steel Range Hood	1	\$736.12	AH
	QS330WW ■	White-on-White Range Hood	1	\$672.46	AH
36"	QS336AA ■	Almond-on-Almond Range Hood	1	\$686.62	AH
	QS336BC ■	Bisque-on-Bisque Range Hood	1	\$686.62	AH
	QS336BL ■	Black Range Hood	1	\$686.62	AH
	QS336SS ■	Stainless Steel Range Hood	1	\$757.40	AH
	QS336WW ■	White-on-White Range Hood	1	\$686.62	AH
42"	QS342AA ■	Almond-on-Almond Range Hood	1	\$700.76	AH
	QS342BC ■	Bisque-on-Bisque Range Hood	1	\$700.76	AH
	QS342BL ■	Black Range Hood	1	\$700.76	AH
	QS342SS ■	Stainless Steel Range Hood	1	\$778.62	AH
	QS342WW ■	White-on-White Range Hood	1	\$700.76	AH
	BPSF30	Non-ducted Filter for 30" series hoods (S99010308 — Single Pack)	4 *	\$31.52	AC
	BPSF36	Non-ducted Filter for 36" series hoods (S99010309 — Single Pack)	4 *	\$33.70	AC
	BPSF42	Non-ducted Filter for 42" series hoods (S99010310 — Single Pack)	8 *	\$36.22	AC
	BPS3FA30	Aluminum Filter for 30" series hoods (S99010305 — Single Pack)	6 *	\$61.84	AC
	BPS3FA36	Aluminum Filter for 36" series hoods (S99010306 — Single Pack)	6 *	\$69.20	AC
	BP87 ■	7" Damper for round discharge range hood. (S97010792 — Single Pack)	3 *	\$11.46	AC
	PAR20	Halogen Bulb; 120V, 50W	6 *	\$23.20	AC

■ Limited quantities available.

Single packs are higher priced.

For aluminum filter for 42" series hood, order service part S99010307 (2-pack).

Range hoods work with make-up dampers (MD6TU, MD8TU and MD10TU) and fresh air inlets (641FA, 643FA and 610FA) — see accessories on Page 5.

● Item too large to ship via UPS/FedEx. Item shipped common carrier at minimum rates.

* All pricing reflects the individual item cost. You must order in multiples as indicated.

◆ UL listed for use over bathtubs and showers when connected to a GFCI protected branch circuit.

Range Hoods — Under Cabinet

Broan® QS2 Series ALLURE II

Finally, a range hood with all the best features at a reasonable price! The QS2 Series has very quiet operation with a powerful 300 CFM blower. Easy-to-clean bottom pan and filters with three-level lighting and Heat Sentry™. Optional non-duct operation.



3-1/4" x 10" Duct — Internal Blower
280 CFM — 5.5 Sones Vertical
300 CFM — 4.5 Sones Horizontal
7" Round Duct — Internal Blower
280 CFM — 5.0 Sones Vertical
Converts to non-ducted. Add non-ducted filter (available separately).

	Model No.	Description	Std. Pk.	List Price	Code
30"	QS230AA ■	Almond-on-Almond Range Hood	1	\$502.56	AH
	QS230BC ■	Bisque-on-Bisque Range Hood	1	\$502.56	AH
	QS230BL ■	Black Range Hood	1	\$502.56	AH
	QS230SS ■	Stainless Steel Range Hood	1	\$566.26	AH
	QS230WW ■	White-on-White Range Hood	1	\$502.56	AH
36"	QS236AA ■	Almond-on-Almond Range Hood	1	\$520.28	AH
	QS236BC ■	Bisque-on-Bisque Range Hood	1	\$520.28	AH
	QS236BL ■	Black Range Hood	1	\$520.28	AH
	QS236SS ■	Stainless Steel Range Hood	1	\$591.00	AH
	QS236WW ■	White-on-White Range Hood	1	\$520.28	AH
42"	QS242AA ■	Almond-on-Almond Range Hood	1	\$534.40	AH
	QS242BC ■	Bisque-on-Bisque Range Hood	1	\$534.40	AH
	QS242BL ■	Black Range Hood	1	\$534.40	AH
	QS242SS ■	Stainless Steel Range Hood	1	\$612.28	AH
	QS242WW ■	White-on-White Range Hood	1	\$534.40	AH
	BPSF30	Non-ducted Filter for 30" series hoods (S99010308 — Single Pack)	4 *	\$31.52	AC
	BPSF36	Non-ducted Filter for 36" series hoods (S99010309 — Single Pack)	4 *	\$33.70	AC
	BPSF42	Non-ducted Filter for 42" series hoods (S99010310 — Single Pack)	8 *	\$36.22	AC
	BPS2FA30	Aluminum Filter for 30" series hoods (S99010302 — Single Pack)	6 *	\$40.44	AC
	BPS2FA36	Aluminum Filter for 36" series hoods (S99010303 — Single Pack)	6 *	\$44.88	AC
	ARP310	CFM Reducer Kit, reduces CFM to less than 300 CFM, 3-1/4" x 10"	5 *	\$49.18	AC
	BP87 ■	7" Damper for round discharge range hood. (S97010792 — Single Pack)	3 *	\$11.46	AC
	PAR20	Halogen Bulb; 120V, 50W	6 *	\$23.20	AC

■ Limited quantities available.

Single packs are higher priced.

For aluminum filter for 42" series hood, order service part S99010304 (2-pack).

- Item too large to ship via UPS/FedEx. Item shipped common carrier at minimum rates.
- * All pricing reflects the individual item cost. You must order in multiples as indicated.
- ◆ UL listed for use over bathtubs and showers when connected to a GFCI protected branch circuit.

Range Hoods — Under Cabinet

Broan® QS1 Series ALLURE I

The quietest range hood in its category operates quietly and has 220 CFM power at the high setting. Easy cleaning and a two-level light/speed setting make it the perfect choice for the everyday kitchen.



3-1/4" x 10" Duct — Internal Blower
210 CFM — 5.5 Sones Vertical
220 CFM — 5.0 Sones Horizontal
7" Round Duct — Internal Blower
230 CFM — 5.0 Sones Vertical
Converts to non-ducted. Add non-ducted filter (available separately).

	Model No.	Description	Std. Pk.	List Price	Code
30"	QS130AA ■	Almond-on-Almond Range Hood	1	\$283.14	AH
	QS130BC ■	Bisque-on-Bisque Range Hood	1	\$283.14	AH
	QS130BL ■	Black Range Hood	1	\$283.14	AH
	QS130SS ■	Stainless Steel Range Hood	1	\$343.82	AH
	QS130WW ■	White-on-White Range Hood	1	\$283.14	AH
36"	QS136AA ■	Almond-on-Almond Range Hood	1	\$296.62	AH
	QS136BC ■	Bisque-on-Bisque Range Hood	1	\$296.62	AH
	QS136BL ■	Black Range Hood	1	\$296.62	AH
	QS136SS ■	Stainless Steel Range Hood	1	\$364.08	AH
	QS136WW ■	White-on-White Range Hood	1	\$296.62	AH
42"	QS142AA ■	Almond-on-Almond Range Hood	1	\$320.52	AH
	QS142BC ■	Bisque-on-Bisque Range Hood	1	\$320.52	AH
	QS142BL ■	Black Range Hood	1	\$320.52	AH
	QS142SS ■	Stainless Steel Range Hood	1	\$384.26	AH
	QS142WW ■	White-on-White Range Hood	1	\$320.52	AH
	BPSF30	Non-ducted Filter for 30" series hoods (S99010308 — Single Pack)	4 *	\$31.52	AC
	BPSF36	Non-ducted Filter for 36" series hoods (S99010309 — Single Pack)	4 *	\$33.70	AC
	BPSF42	Non-ducted Filter for 42" series hoods (S99010310 — Single Pack)	8 *	\$36.22	AC
	BPS1FA30	Aluminum Filter for 30" series hoods (S99010299 — Single Pack)	3 *	\$27.60	AC
	BPS1FA36	Aluminum Filter for 36" series hoods (S99010300 — Single Pack)	3 *	\$30.22	AC
	BP87 ■	7" Damper for round discharge range hood. (S97010792 — Single Pack)	3 *	\$11.46	AC
	PAR20	Halogen Bulb; 120V, 50W	6 *	\$23.20	AC

■ Limited quantities available.

Single packs are higher priced.

For aluminum filter for 42" series hood, order service part S99010301 (2-pack).

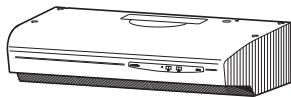

3-1/4" x 10" Duct — Internal Blower
210 CFM, 5.0 Sones — High
110 CFM, 1.5 Sones — Normal
7" Round Duct — Internal Blower
210 CFM, 1.5 Sones
Includes one compact fluorescent
4 watt night light bulb.

QSE Series (ENERGY STAR)

The QSE Series models are part of our new ENERGY STAR hood offering and an extension of our popular Allure, America's contemporary style choice. Designed to provide energy efficient operation with a quiet 210 CFM axial blade blower. Features include convenient two-speed rocker control, two levels of lighting and dishwasher-safe filters.

	Model No.	Description	Std. Pk.	List Price	Code
30"	QSE130SS ■	Stainless Range Hood	1	\$430.30	AH
	QSE130BL ■	Black Range Hood	1	\$375.12	AH
	QSE130WW ■	White Range Hood	1	\$375.12	AH
	BPS1FA30	Aluminum filter for 30" Series hoods	3 *	\$27.60	AC
	BP87 ■	7" Damper for round discharge range hood. (S97010792 — Single Pack)	3 *	\$11.46	AC

■ Limited quantities available.

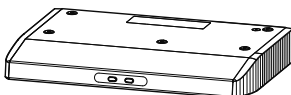

3-1/4" x 10" Duct — Internal Blower
290 CFM, 5.5 Sones — High
100 CFM, 0.9 Sones — Low

QDE Series (ENERGY STAR)

A sleek, contemporary styled range hood with high-performance, 290 CFM capability and ENERGY STAR qualification. Features include energy efficient dual 13-watt lamps (included), 2-speed control, fully enclosed bottom pan for easy cleaning and dishwasher-safe filters.

	Model No.	Description	Std. Pk.	List Price	Code
30"	QDE30WW ■	White-on-White Range Hood	1	\$708.50	RH
	QDE30SS ■	Stainless Steel Range Hood	1	\$743.34	RH
	BPQDE30	Aluminum replacement grease filters for QDE30 Series (3 Pack)	3 *	\$57.82	AC

■ Limited quantities available.

● Item too large to ship via UPS/FedEx. Item shipped common carrier at minimum rates.

* All pricing reflects the individual item cost. You must order in multiples as indicated.

◆ UL listed for use over bathtubs and showers when connected to a GFCI protected branch circuit.

Range Hoods — Under Cabinet

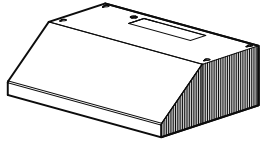

3-1/4" x 10" Duct — Internal Blower
440 CFM, 7.0 Sones — High
200 CFM, 0.7 Sones — Normal

Includes one 42 watt compact fluorescent and one 4 watt night light bulb.

APE Series (ENERGY STAR)

The APE Series models are part of our new ENERGY STAR hood offering and an extension of our popular 9" professional style under-cabinet line. Designed to provide energy efficient operation with a very quiet 440 CFM dual centrifugal blower. Features include hidden variable speed control with last setting memory, two levels of lighting. Heat Sentry™ and dishwasher safe filters with antimicrobial protection.

Model No.	Description	Std. Pk.	List Price	Code
30" APE130SS ■	Stainless Range Hood	1	\$752.48	RH
BPAPFA	Replacement Grease Filter with antimicrobial protection (3 packs/2 filters per pack)	3 *	\$51.62	AC

■ Limited quantities available.

Range hoods work with make-up dampers (MD6TU, MD8TU and MD10TU) and fresh air inlets (641FA, 643FA and 610FA) — see accessories on Page 5.

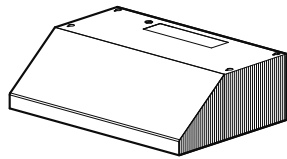

3-1/4" x 10" Duct — Internal Blower
440 CFM — Horizontal and
Vertical 7.0 Sones — High
120 CFM, 0.5 Sones — Low

Converts to non-ducted. Add non-ducted recirculation kit (available separately).

Pro-Style Hoods AP1 Series

Broan's newest 9" pro-style hoods — never before have appearance and value been so elegantly combined. Two halogen bulbs (sold separately) provide two-level lighting. Dishwasher-safe, anti-microbial filters look new over repeated cleanings. Hood features variable speed controls and an optional non-duct choice.

Model No.	Description	Std. Pk.	List Price	Code
30" AP130SS ■	Variable, 430 Stainless Steel Range Hood	1	\$709.82	RH
AP130WW ■	Variable, White on White Range Hood	1	\$658.18	RH
AP130BL ■	Variable, Black on Black Range Hood	1	\$658.18	RH
36" AP136SS ■	Variable, 430 Stainless Steel Range Hood	1	\$730.44	RH
AP136WW ■	Variable, White on White Range Hood	1	\$678.82	RH
AP136BL ■	Variable, Black on Black Range Hood	1	\$678.82	RH
30" NDK35830SS ■	Non-ducted Recirculation Kit for 9N Pro Hood, Stainless	1	\$165.96	HA
NDK35830WW ■	Non-ducted Recirculation Kit for 9N Pro Hood, White	1	\$153.66	HA
NDK35830BL ■	Non-ducted Recirculation Kit for 9N Pro Hood, Black	1	\$153.66	HA
36" NDK35836SS ■	Non-ducted Recirculation Kit for 9N Pro Hood, Stainless	1	\$178.22	HA
NDK35836WW ■	Non-ducted Recirculation Kit for 9N Pro Hood, White	1	\$165.96	HA
NDK35836BL ■	Non-ducted Recirculation Kit for 9N Pro Hood, Black	1	\$165.96	HA
88F	Replacement Non-ducted Filter for 88000, AP1 and RP2 Series. Master Pack contains 6 pairs of filters. (S97007662 — Single Pack)	6 *	\$32.30	AC
BPAPFA	Replacement Grease Filter with antimicrobial protection (3 packs/2 filters per pack)	3 *	\$51.62	AC
GU10	Halogen Bulb; 120V, 50W max.	10 *	\$17.06	AC

■ Limited quantities available.

Range hoods work with make-up dampers (MD6TU, MD8TU and MD10TU) and fresh air inlets (641FA, 643FA and 610FA) — see accessories on Page 5.

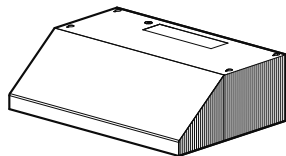

3-1/4" x 10" Duct — Internal Blower
440 CFM — Horizontal and
Vertical 7.0 Sones — High
120 CFM, 0.5 Sones — Low

Pro-Style Hoods RP1 Series

Broan's newest 9" pro-style hoods — never before have appearance and value been so elegantly combined. Two halogen bulbs (sold separately) provide two-level lighting. Dishwasher-safe filters for easy cleaning. Hood features a two-speed rocker blower control.

Model No.	Description	Std. Pk.	List Price	Code
30" RP130SS ■	430 Stainless Steel Range Hood	1	\$619.46	RH
RP130WW ■	White on White Range Hood	1	\$567.82	RH
RP130BL ■	Black on Black Range Hood	1	\$567.82	RH
36" RP136SS ■	430 Stainless Steel Range Hood	1	\$640.08	RH
RP136WW ■	White on White Range Hood	1	\$588.48	RH
RP136BL ■	Black on Black Range Hood	1	\$588.48	RH
BPRPFA	Replacement Grease Filter (3 packs/2 filters per pack) (S97017455 — Single Pack)	3 *	\$23.24	AC
GU10	Halogen Bulb; 120V, 50W max.	10 *	\$17.06	AC

■ Limited quantities available.

Range hoods work with make-up dampers (MD6TU, MD8TU and MD10TU) and fresh air inlets (641FA, 643FA and 610FA) — see accessories on Page 5.

- Item too large to ship via UPS/FedEx. Item shipped common carrier at minimum rates.
- * All pricing reflects the individual item cost. You must order in multiples as indicated.
- ◆ UL listed for use over bathtubs and showers when connected to a GFCI protected branch circuit.

Range Hoods — Under Cabinet

Broan® 88000 Series

An infinite speed slide control operates a powerful, quiet blower. Can convert to non-duct operation. Damper/adaptor included, filters sold separately. Uses two 75-watt bulbs (sold separately) and optional make-up air dampers.



3-1/4" x 10" Duct — Internal Blower
360 CFM — 5.5 Sones Vertical
350 CFM — 6.0 Sones Horizontal

Converts to non-ducted. Add non-ducted filters (available separately).

	Model No.	Description	Std. Pk.	List Price	Code
30"	883001 ■	White Range Hood	1	\$505.36	RH
	883002 ■	Bisque Range Hood	1	\$505.36	RH
	883004 ■	Stainless Steel Range Hood	1	\$569.32	RH
	883008 ■	Almond Range Hood	1	\$505.36	RH
	883011 ■	White on White Range Hood	1	\$505.36	RH
	883023 ■	Black Range Hood	1	\$505.36	RH
36"	883601 ■	White Range Hood	1	\$555.90	RH
	883604 ■	Stainless Steel Range Hood	1	\$624.38	RH
	883608 ■	Almond Range Hood	1	\$555.90	RH
	883623 ■	Black Range Hood	1	\$555.90	RH
42"	884201 ■	White Range Hood	1	\$609.80	RH
	884204 ■	Stainless Steel Range Hood	1	\$737.90	RH
	884223 ■	Black Range Hood	1	\$609.80	RH
48"	884801 ■	White Range Hood	1	\$636.12	RH
	884804 ■	Stainless Steel Range Hood	1	\$668.48	RH
	884823 ■	Black Range Hood	1	\$636.12	RH
	88F	Replacement Non-ducted Filter for 88000, AP1 and AP2 Series. Master Pack contains 6 pairs of filters. (S97007662 — Single Pack)	6 *	\$32.30	AC

■ Limited quantities available.

Single packs are higher priced.

Range hoods work with make-up dampers (MD6TU, MD8TU and MD10TU) and fresh air inlets (641FA, 643FA and 610FA) — see accessories on Page 5.

Broan® Range Hood Specials

IMPORTANT: Orders for specials become non-cancellable upon acceptance by the Company. Range hood specials will be shipped within three weeks from receipt of order. Ducted only design, with infinite speed slide control and last-setting memory.



89000 Series — Solid-State
3-1/4" x 10" Duct — Internal Blower
460 CFM — 6.0 Sones Vertical
440 CFM — 7.0 Sones Horizontal



88000 Series — Solid-State
3-1/4" x 10" Duct — Internal Blower
360 CFM — 5.5 Sones Vertical
350 CFM — 6.0 Sones Horizontal

Converts to non-ducted. Add non-ducted filters (available separately).

	Model No.	Description	Std. Pk.	List Price	Code
30"	893001 ■	White Range Hood Special	1	\$657.16	RH
	893004 ■	Stainless Steel Range Hood Special	1	\$738.36	RH
	893011 ■	White-on-White Range Hood Special	1	\$657.16	RH
	893023 ■	Black Range Hood Special	1	\$657.16	RH
36"	893601 ■	White Range Hood Special	1	\$680.60	RH
	893604 ■	Stainless Steel Range Hood Special	1	\$761.82	RH
	893623 ■	Black Range Hood Special	1	\$680.60	RH
39"	893901 ■	White Range Hood Special	1	\$719.62	RH
	893904 ■	Stainless Steel Range Hood Special	1	\$800.82	RH
42"	894201 ■	White Range Hood Special	1	\$704.02	RH
	894204 ■	Stainless Steel Range Hood Special	1	\$785.22	RH
	894223 ■	Black Range Hood Special	1	\$704.02	RH
48"	894801 ■	White Range Hood Special	1	\$727.44	RH
	894804 ■	Stainless Steel Range Hood Special	1	\$808.68	RH
	Model No.	Description	Std. Pk.	List Price	Code
39"	883901 ■	White Range Hood Special	1	\$618.26	RH
	883904 ■	Stainless Steel Range Hood Special	1	\$701.82	RH

■ Limited quantities available.

Range hoods work with make-up dampers (MD6TU, MD8TU and MD10TU) and fresh air inlets (641FA, 643FA and 610FA) — see accessories on Page 5.

- Item too large to ship via UPS/FedEx. Item shipped common carrier at minimum rates.
- * All pricing reflects the individual item cost. You must order in multiples as indicated.
- ◆ UL listed for use over bathtubs and showers when connected to a GFCI protected branch circuit.

Range Hoods — Under Cabinet

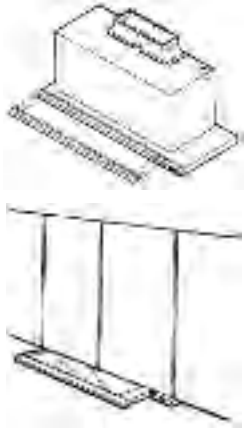

3-1/4" x 10" Duct — Internal Blower
300 CFM — 4.5 Sones Vertical

Broan® Elite 15000 Series Slide Out SILHOUETTE™

Thin-line styling to complement today's contemporary and European styled kitchens. Superior air movement provided by a high efficiency, dual centrifugal blower system. Solid-state infinite speed slide control with memory. Heat Sentry™. Bright, economical 24" fluorescent light (tube not included). Washable foam filter.

	Model No.	Description	Std. Pk.	List Price	Code
30"	153001	White Slide Out	1	\$980.66	DH
	153004	Brushed Aluminum Slide Out	1	\$1,019.04	DH
	153023	Black Slide Out	1	\$980.66	DH
36"	153601	White Slide Out	1	\$1,060.24	DH
	153604	Brushed Aluminum Slide Out	1	\$1,099.60	DH
	153623	Black Slide Out	1	\$1,060.24	DH

For replacement filters, see Broan's Replacement Parts Guide.



3-1/4" x 10" Duct — Internal Blower
200 CFM, 5.0 Sones Vertical
190 CFM, 4.5 Sones Horizontal
7" Round Duct — Internal Blower
250 CFM, 4.5 Sones

Broan® QML Series

This Pro-Style under cabinet hood is available in a 30" width, making it the perfect fit for the most common cook-top size. The sleek 6" high design brings a modern style to today's kitchens. The canopy type range hood has a fully enclosed bottom design, making it very easy to clean. Dual halogen lighting with two light levels provides brilliant cook-top illumination (GU1035, MR16 bulbs not included), and the two-speed rocker control switch makes it easy to use. Dishwasher safe grease filter ensures peak performance for many years to come.

The QML can be installed to duct outdoors or as non-ducted with the purchase of the BPQFT filter. (3-1/4" x 10" damper/duct connector and 7" round duct adapter plate included.)

	Model No.	Description	Std. Pk.	List Price	Code
30"	QML30BL ■	Black Range Hood	1	\$272.90	QP
	QML30SS ■	Stainless Range Hood	1	\$309.54	QP
	QML30WW ■	White Range Hood	1	\$272.90	QP
	BPQTF	Non-ducted Filters (99010317 — Single Pack)	4 *	\$11.80	AC
	BPQTAf	Aluminum Grease Filters (99010316 — Single Pack)	4 *	\$9.40	AC
	GU1035	Halogen Bulb; 120V, 35W	10 *	\$15.92	AC

■ Limited quantities available.

- Item too large to ship via UPS/FedEx. Item shipped common carrier at minimum rates.
- * All pricing reflects the individual item cost. You must order in multiples as indicated.
- ◆ UL listed for use over bathtubs and showers when connected to a GFCI protected branch circuit.

Range Hoods — Under Cabinet

Broan® QT20000 Series QUIET HOOD

Patented air chamber design reduces noise up to 40% over conventional hoods. Convertible to ducted or non-ducted. Infinite rotary speed control and dual 40-watt bulbs with night-light (bulbs sold separately).



3-1/4" x 10" Duct — Internal Blower
200 CFM — 4.5 Sones Vertical
170 CFM — 4.5 Sones Horizontal
7" Rounded Duct — Internal Blower
220 CFM — 4.5 Sones Vertical
Converts to non-ducted. Add BPQTF
non-ducted filter (sold separately).

	Model No.	Description	Std. Pk.	List Price	Code
30"	QT230AA ■	Almond-on-Almond Range Hood	1	\$246.34	AH
	QT230BC ■	Bisque-on-Bisque Range Hood	1	\$246.34	AH
	QT230BL ■	Black Range Hood	1	\$246.34	AH
	QT230SS ■	Stainless Steel Range Hood	1	\$325.60	AH
	QT230WW ■	White-on-White Range Hood	1	\$246.34	AH
36"	QT236AA ■	Almond-on-Almond Range Hood	1	\$254.82	AH
	QT236BC ■	Bisque-on-Bisque Range Hood	1	\$254.82	AH
	QT236BL ■	Black Range Hood	1	\$254.82	AH
	QT236SS ■	Stainless Steel Range Hood	1	\$334.10	AH
	QT236WW ■	White-on-White Range Hood	1	\$254.82	AH
42"	QT242AA ■	Almond-on-Almond Range Hood	1	\$260.48	AH
	QT242BC ■	Bisque-on-Bisque Range Hood	1	\$260.48	AH
	QT242BL ■	Black Range Hood	1	\$260.48	AH
	QT242SS ■	Stainless Steel Range Hood	1	\$339.72	AH
	QT242WW ■	White-on-White Range Hood	1	\$260.48	AH
	BPQTF	Non-ducted Filters (99010317 — Single Pack)	4 *	\$11.80	AC
	BPQAF	Aluminum Grease Filters (99010316 — Single Pack)	4 *	\$9.40	AC
	BP87 ■	7" Damper for round discharge range hood. (S97010792 — Single Pack)	3 *	\$11.46	AC

■ Limited quantities available.

Single packs are higher priced.

Broan® 46000 Series

Convertible to ducted or non-ducted (non-duct filter sold separately). Variable speed rotary control. 75-watt cooktop lighting (bulb sold separately).



3-1/4" x 10" Duct — Internal Blower
190 CFM — 7.5 Sones Vertical
190 CFM — 7.5 Sones Horizontal
7" Rounded Duct — Internal Blower
220 CFM — 7.5 Sones
Converts to non-ducted.

	Model No.	Description	Std. Pk.	List Price	Code
24"	462401	White Range Hood	1	\$200.12	RH
	462404	Stainless Steel Range Hood	1	\$258.92	RH
	462423	Black Range Hood	1	\$200.12	RH
30"	463001	White Range Hood	1	\$190.58	RH
	463002	Bisque Range Hood	1	\$190.58	RH
	463004	Stainless Steel Range Hood	1	\$249.36	RH
	463008 ■	Almond Range Hood	1	\$190.58	RH
	463011	White-on-White Range Hood	1	\$190.58	RH
	463023	Black Range Hood	1	\$190.58	RH
36"	463601	White Range Hood	1	\$200.12	RH
	463602	Bisque Range Hood	1	\$200.12	RH
	463604	Stainless Steel Range Hood	1	\$258.92	RH
	463608 ■	Almond Range Hood	1	\$200.12	RH
	463623	Black Range Hood	1	\$200.12	RH
42"	464201	White Range Hood	1	\$209.72	RH
	464202	Bisque Range Hood	1	\$209.72	RH
	464204	Stainless Steel Range Hood	1	\$268.48	RH
	464208 ■	Almond Range Hood	1	\$209.72	RH
	41F	Replacement Non-ducted Filter for F40000, 41000 and 46000 Series range hoods. Master Pack contains 6 filters. (S97007696 — Single Pack)	6 *	\$17.42	AC
	BP29	10-1/2" x 8-3/4" Washable Aluminum Filter for F40000, 40000, 42000 and 46000 Series. Contains 6 filters. (S97006931 — Single Pack)	6 *	\$9.34	AC

■ Limited quantities available.

Single packs are higher priced.

- Item too large to ship via UPS/FedEx. Item shipped common carrier at minimum rates.
- * All pricing reflects the individual item cost. You must order in multiples as indicated.
- ◆ UL listed for use over bathtubs and showers when connected to a GFCI protected branch circuit.

Range Hoods — Under Cabinet

Broan® 43000 Series

Adapt to any installation with these four-way convertible range hoods. An enclosed light and fan/filter assembly makes for easy cleaning.



3-1/4" x 10" Duct — Internal Blower
 190 CFM — 7.0 Sones Vertical
 160 CFM — 7.0 Sones Horizontal
 7" Rounded Duct — Internal Blower
 220 CFM — 8.0 Sones Vertical

Converts to non-ducted. Includes washable aluminum filter with light lens.

Model No.	Description	Std. Pk.	List Price	Code	
30"	433004	Stainless Steel Range Hood	1	\$205.14	LL
	433011	White-on-White Range Hood	1	\$143.36	LL
	433018	■ Almond-on-Almond Range Hood	1	\$143.36	LL
	433022	Bisque-on-Bisque Range Hood	1	\$143.36	LL
	433023	Black Range Hood	1	\$143.36	LL
36"	433604	Stainless Steel Range Hood	1	\$212.20	LL
	433611	White-on-White Range Hood	1	\$152.80	LL
	433618	■ Almond-on-Almond Range Hood	1	\$152.80	LL
	433622	Bisque-on-Bisque Range Hood	1	\$152.80	LL
	433623	Black Range Hood	1	\$152.80	LL
BP57	11-3/8" x 11-3/4" Washable Aluminum and Charcoal Filter with light lens. Master pack contains 8 filters. (SR610050 — Single Pack.)	8 *	\$16.50	AC	
BP58	Replacement Charcoal Filter Pack. Each pack contains three 7-3/4" x 10-1/2" pads. Master pack contains 8 filter packs. (SR610051 — Single Pack)	8 *	\$11.58	AC	

■ Limited quantities available.

Single packs are higher priced.

● Item too large to ship via UPS/FedEx. Item shipped common carrier at minimum rates.
 * All pricing reflects the individual item cost. You must order in multiples as indicated.
 ◆ UL listed for use over bathtubs and showers when connected to a GFCI protected branch circuit.

Range Hoods — Under Cabinet

Broan® F40000 Series

Adapt to any installation with these four-way convertible range hoods. An enclosed light and fan/filter assembly makes for easy cleaning.

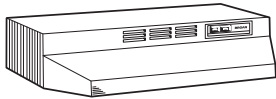

3-1/4" x 10" Duct — Internal Blower
 160 CFM — 6.5 Sones Vertical
 160 CFM — 6.5 Sones Horizontal
 7" Round Duct — Internal Blower
 190 CFM — 6.5 Sones

Converts to non-ducted. Includes washable aluminum filter. Non-ducted filter purchased separately.

	Model No.	Description	Std. Pk.	List Price	Code
24"	F402401	White Range Hood	1	\$141.00	LL
	F402402	■ Bisque Range Hood	1	\$141.00	LL
	F402404	Stainless Steel Range Hood	1	\$200.46	LL
	F402408	Almond Range Hood	1	\$141.00	LL
	F402411	White-on-White Range Hood	1	\$141.00	LL
	F402422	Bisque-on-Bisque Range Hood	1	\$141.00	LL
	F402423	Black Range Hood	1	\$141.00	LL
	30"	F403001	White Range Hood	1	\$135.24
F403002		■ Bisque Range Hood	1	\$135.24	LL
F403004		Stainless Steel Range Hood	1	\$192.26	LL
F403008		Almond Range Hood	1	\$135.24	LL
F403011		White-on-White Range Hood	1	\$135.24	LL
F403022		Bisque-on-Bisque Range Hood	1	\$135.24	LL
F403023		Black Range Hood	1	\$135.24	LL
36"		F403601	White Range Hood	1	\$148.76
	F403602	■ Bisque Range Hood	1	\$148.76	LL
	F403604	Stainless Steel Range Hood	1	\$211.48	LL
	F403608	Almond Range Hood	1	\$148.76	LL
	F403611	White-on-White Range Hood	1	\$148.76	LL
	F403622	Bisque-on-Bisque Range Hood	1	\$148.76	LL
	F403623	Black Range Hood	1	\$148.76	LL
	42"	F404201	White Range Hood	1	\$163.62
F404202		■ Bisque Range Hood	1	\$163.62	LL
F404204		Stainless Steel Range Hood	1	\$232.64	LL
F404208		Almond Range Hood	1	\$163.62	LL
F404211		White-on-White Range Hood	1	\$163.62	LL
F404222		Bisque-on-Bisque Range Hood	1	\$163.62	LL
F404223		Black Range Hood	1	\$163.62	LL
41F		Replacement Non-ducted Filter for F40000, 41000 and 46000 Series range hoods. Master Pack contains 6 filters. (S97007696 — Single Pack)	6 *	\$17.42	AC
BP29	10-1/2" x 8-3/4" Washable Aluminum Filter for F40000, 40000, 42000 and 46000 Series. Contains 6 filters. (S97006931 — Single Pack)	6 *	\$9.34	AC	
BP87Q	7" Damper for round discharge range hood. (S97010792 — Single Pack)	3 *	\$18.42	AC	

■ Limited quantities available.

Single packs are higher priced.

- Item too large to ship via UPS/FedEx. Item shipped common carrier at minimum rates.
- * All pricing reflects the individual item cost. You must order in multiples as indicated.
- ◆ UL listed for use over bathtubs and showers when connected to a GFCI protected branch circuit.

Range Hoods — Under Cabinet

Broan® 42000 Series 7" ROUND DUCTED

High quality, economy level range hood installs as 7" round ducted only. Dishwasher-safe grease filter.



7" Round Duct — Internal Blower
190 CFM — 6.0 Sones Vertical

BP87 Damper must be purchased separately, except on "D" version models.

	Model No.	Description	Std. Pk.	List Price	Code
24"	422401	White Range Hood	1	\$125.04	LL
	422401D	White Range Hood (with damper)	1	\$135.34	LL
	422402	Bisque Range Hood	1	\$125.04	LL
	422404	Stainless Steel Range Hood	1	\$183.84	LL
	422408	■ Almond Range Hood	1	\$125.04	LL
30"	423001	White Range Hood	1	\$120.68	LL
	423001D	White Range Hood (with damper)	1	\$130.62	LL
	423002	Bisque Range Hood	1	\$120.68	LL
	423004	Stainless Steel Range Hood	1	\$179.44	LL
	423008	■ Almond Range Hood	1	\$120.68	LL
	423008D	■ Almond Range Hood (with damper)	1	\$130.62	LL
	423023	Black Range Hood	1	\$120.68	LL
36"	423601	White Range Hood	1	\$125.04	LL
	423601D	White Range Hood (with damper)	1	\$135.34	LL
	423602	Bisque Range Hood	1	\$125.04	LL
	423604	Stainless Steel Range Hood	1	\$183.84	LL
	423608	■ Almond Range Hood	1	\$125.04	LL
	423608D	■ Almond Range Hood (with damper)	1	\$135.34	LL
	423623	Black Range Hood	1	\$125.04	LL
42"	424201	White Range Hood	1	\$129.48	LL
	424201D	White Range Hood (with damper)	1	\$139.80	LL
	424202	Bisque Range Hood	1	\$129.48	LL
	424204	Stainless Steel Range Hood	1	\$188.22	LL
	424208	■ Almond Range Hood	1	\$129.48	LL
	BP29	10-1/2" x 8-3/4" Washable Aluminum Filter for F40000, 40000, 42000 and 46000 Series. Contains 6 filters. (S97006931 — Single Pack)	6 *	\$9.34	AC
	BP87Q	7" Damper for round discharge range hood. (S97010792 — Single Pack)	3 *	\$18.42	AC
	T457	7" to 5" duct reducer	1	\$26.00	AC

■ Limited quantities available.

Single packs are higher priced.

● Item too large to ship via UPS/FedEx. Item shipped common carrier at minimum rates.

* All pricing reflects the individual item cost. You must order in multiples as indicated.

◆ UL listed for use over bathtubs and showers when connected to a GFCI protected branch circuit.

Range Hoods — Under Cabinet

Broan® 40000 Series 3-1/4" x 10" DUCTED

High quality, economy level range hood installs as 3-1/4" x 10" ducted only. Dishwasher-safe grease filter.



3-1/4" x 10" Duct — Internal Blower
160 CFM — 6.5 Sones Vertical
160 CFM — 6.5 Sones Horizontal

	Model No.	Description	Std. Pk.	List Price	Code
21"	402101	White Range Hood	1	\$157.52	LL
	402102	Bisque Range Hood	1	\$157.52	LL
	402108	■ Almond Range Hood	1	\$157.52	LL
24"	402401	White Range Hood	1	\$132.56	LL
	402402	Bisque Range Hood	1	\$132.56	LL
	402404	Stainless Steel Range Hood	1	\$191.36	LL
	402408	■ Almond Range Hood	1	\$132.56	LL
30"	403001	White Range Hood	1	\$128.14	LL
	403002	Bisque Range Hood	1	\$128.14	LL
	403004	Stainless Steel Range Hood	1	\$186.92	LL
	403008	■ Almond Range Hood	1	\$128.14	LL
	403023	Black Range Hood	1	\$128.14	LL
36"	403601	White Range Hood	1	\$132.56	LL
	403602	Bisque Range Hood	1	\$132.56	LL
	403604	Stainless Steel Range Hood	1	\$191.36	LL
	403608	■ Almond Range Hood	1	\$132.56	LL
	403623	Black Range Hood	1	\$132.56	LL
42"	404201	White Range Hood	1	\$136.92	LL
	404202	Bisque Range Hood	1	\$136.92	LL
	404208	■ Almond Range Hood	1	\$136.92	LL
	BP29	10-1/2" x 8-3/4" Washable Aluminum Filter for F40000, 40000, 42000 and 46000 Series. Contains 6 filters. (S97006931 — Single Pack)	6 *	\$9.34	AC

■ Limited quantities available.

Single packs are higher priced.

Broan® 37000 Series (SHELL ONLY)

Shell utilizes a 40000 Series shell, but contains no fan, light, switches or knockouts.



	Model No.	Description	Std. Pk.	List Price	Code
24"	372401	White Range Hood Shell	1	\$79.94	LL
	372408	■ Almond Range Hood Shell	1	\$79.94	LL
30"	373001	White Range Hood Shell	1	\$75.54	LL
	373002	Bisque Range Hood Shell	1	\$75.54	LL
	373004	Stainless Steel Range Hood Shell	1	\$134.30	LL
	373008	■ Almond Range Hood Shell	1	\$75.54	LL
36"	373601	White Range Hood Shell	1	\$79.94	LL
	373604	Stainless Steel Range Hood Shell	1	\$138.70	LL

■ Limited quantities available.

● Item too large to ship via UPS/FedEx. Item shipped common carrier at minimum rates.

* All pricing reflects the individual item cost. You must order in multiples as indicated.

◆ UL listed for use over bathtubs and showers when connected to a GFCI protected branch circuit.

Range Hoods — Under Cabinet

Broan® 41000 Series NON-DUCTED

High quality, economy level range hood installs as non-ducted only. Two-speed fan control. Charcoal replacement filter sold separately.



Non-ducted — Includes filter

	Model No.	Description	Std. Pk.	List Price	Code
21"	412101	White Non-ducted Range Hood	1	\$160.74	LL
	412102	Bisque Non-ducted Range Hood	1	\$160.74	LL
	412108	■ Almond Non-ducted Range Hood	1	\$160.74	LL
	412123	Black Non-ducted Range Hood	1	\$160.74	LL
24"	412401	White Non-ducted Range Hood	1	\$135.78	LL
	412402	Bisque Non-ducted Range Hood	1	\$135.78	LL
	412404	Stainless Steel Non-ducted Range Hood	1	\$194.56	LL
	412408	■ Almond Non-ducted Range Hood	1	\$135.78	LL
30"	413001	White Non-ducted Range Hood	1	\$131.36	LL
	413002	Bisque Non-ducted Range Hood	1	\$131.36	LL
	413004	Stainless Steel Non-ducted Range Hood	1	\$190.16	LL
	413008	■ Almond Non-ducted Range Hood	1	\$131.36	LL
	413023	Black Non-ducted Range Hood	1	\$131.36	LL
36"	413601	White Non-ducted Range Hood	1	\$135.78	LL
	413602	Bisque Non-ducted Range Hood	1	\$135.78	LL
	413604	Stainless Steel Non-ducted Range Hood	1	\$194.56	LL
	413608	■ Almond Non-ducted Range Hood	1	\$135.78	LL
	413623	Black Non-ducted Range Hood	1	\$135.78	LL
42"	414201	White Non-ducted Range Hood	1	\$140.20	LL
	414202	Bisque Non-ducted Range Hood	1	\$140.20	LL
	414204	Stainless Steel Non-ducted Range Hood	1	\$198.98	LL
	414208	■ Almond Non-ducted Range Hood	1	\$140.20	LL
	41F	Replacement Non-ducted Filter for F40000, 41000 and 46000 Series range hoods. Master Pack contains 6 filters. (S97007696 — Single Pack)	6 *	\$17.42	AC

■ Limited quantities available.

Single packs are higher priced.

Range Hoods — Accessories

Broan® SP and EP Backsplashes (24" HIGH)



All Backsplashes furnished in two colors — one per side except stainless steel.

Economy (EP) Backsplashes are packaged 4 per carton and must be ordered in multiples of 4. Prices shown are for each wall shield.

	Model No.	Description	Std. Pk.	List Price	Code
24"	SP240108	White/Almond Backsplash	1	\$39.28	AC
	SP2404	Stainless Steel Backsplash	1	\$99.80	AC
	SP240223	Bisque/Black Backsplash	1	\$39.28	AC
30"	SP300108	White/Almond Backsplash	1	\$39.28	AC
	SP3004	Stainless Steel Backsplash	1	\$99.80	AC
	SP300223	Bisque/Black Backsplash	1	\$39.28	AC
36"	SP360108	White/Almond Backsplash	1	\$45.74	AC
	SP3604	Stainless Steel Backsplash	1	\$106.04	AC
	SP360223	Bisque/Black Backsplash	1	\$45.74	AC
42"	SP420108	■ White/Almond Backsplash	1	\$53.14	AC
	SP4204	Stainless Steel Backsplash	1	\$123.02	AC
	SP420223	Bisque/Black Backsplash	1	\$53.14	AC
30"	EP300108	■ White/Almond Backsplash	4 *	\$35.60	AC
	EP300223	Bisque/Black Backsplash	4 *	\$35.60	AC

■ Limited quantities available.

Note: Backsplashes are accessories and cannot be combined with any other product groups to meet volume requirements.

- Item too large to ship via UPS/FedEx. Item shipped common carrier at minimum rates.
- * All pricing reflects the individual item cost. You must order in multiples as indicated.
- ◆ UL listed for use over bathtubs and showers when connected to a GFCI protected branch circuit.

Range Hoods — Accessories

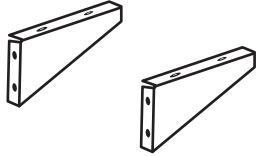

Broan® Range Hood Wall Brackets

Designed for use with 37000, 40000, 41000, 42000, 43000, 46000, 52000, 88000, 89000, AP1 (ducted only), F40000, QL1, QS1, QS2 (36" and 42" only), QS3 (36" and 42" only), QT20000 and RP1 Series.

Model No.	Description	Std. Pk.	List Price	Code
35	Wall Hanging Kit for mounting all hoods to wall when cabinets are not used	1	\$30.14	AC



Broan® Range Hood Electrical Cord Connection Kit

Designed for easy electrical wiring of range hoods. Can be used with Broan, NuTone, Nautilus or Kenmore range hoods.

Model No.	Description	Std. Pk.	List Price	Code
HCK44	Power Cord Kit on individual display card	10 *	\$21.74	AC
HCK44D	Power Cord Kit individual packaged in a polybag. Master Pack — 50.	50 *	\$14.30	AC

Broan: 40000, 41000, 42000, 43000, 46000, 52000, 53000, 88000, 89000, B30, CBD1, CBD3, CBX1, CJD1, CJD3, QL, QML, OP, QS1, QS2, QS3, QT20000, AP, RP, E661, QSE1, Glacier, Antero, Sahale, Spire, Alta, Tenaya, Corteo

NuTone: RL, SL, WA65, WS1, WS2, WS3, NS1, NSP, NS6500, Mantra, Osmos

Kenmore: 5094, 5104, 5114, 5134, 5164, 5174, 5184, 5204, 5205, 5214, 5215, 5234, 5244, 5254, 5260, 5270, 5324, 5334, 5501, 5511, 5521, 5535, 5580, 5817, 5818

Broan® Range Hood Lamp Accessories

Model No.	Description	Std. Pk.	List Price	Code
PAR20	Halogen Bulb; 120V, 50W for QS1, QS2, QS3 and RMIP Series	6 *	\$23.20	AC
GU10	Halogen Bulb; 120V, 50W for E66, RMP, E60, E64, AP, QP2, QP3, QP4 and RP Series	10 *	\$17.06	AC
GU1035	Halogen Bulb; 120V, 35W for EI59, EW58, EW56, QML and QP1 Series	10 *	\$15.92	AC

Trash Compactor Accessories

Broan® Elite Trash Compactor Accessories

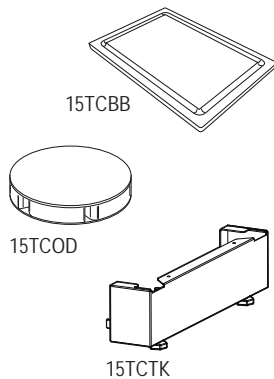

Model No.	Description	Std. Pk.	List Price	Code
15TCBB	■ Cutting Board for 15" compactor	1	\$163.56	CP
15TCBL	15" Compactor Bags, 12 count	1	\$24.94	CP
15TCOD	Odor Control Disc	1	\$53.30	CP
15TCTK	■ Free-standing Toe Kick Kit	1	\$23.58	CP
1006	12" Compactor Bags (includes 10 packs of 12)	10 *	\$19.46	CP

■ Limited quantities available.

- Item too large to ship via UPS/FedEx. Item shipped common carrier at minimum rates.
- * All pricing reflects the individual item cost. You must order in multiples as indicated.
- ◆ UL listed for use over bathtubs and showers when connected to a GFCI protected branch circuit.

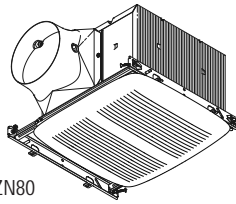

ZN80
ZN110

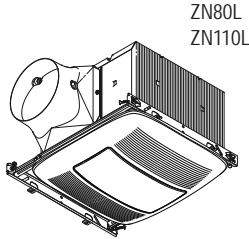

ZN80L
ZN110L

NuTone® ULTRA™ Green Multi-Speed Series

We started with installation and worked back to build the ultimate bath fan. Unique telescoping mounting frame is ideal for both new construction and retrofit. No attic access needed! DC motor for efficiency. Multi-speed capability ideal for meeting ASHRAE 62.2, LEED, ENERGY STAR® for Homes and CA Title 24 — as well as local/spot ventilation needs. Powerful operation maintained over a wide range of real-world installations (CFM rating at 0.1" static pressure maintained through 0.25" static pressure). Fits in 2" x 8" ceiling construction. 10-1/2" L x 11-3/8" W x 7-5/8" H housing. 13" x 14" grille (fan) and 13" x 13-1/4" (fan/light/night light). All models have a 6" duct connector and the 50 CFM and 80 CFM models include a 6" to 4" reducer. All ULTRA 80 and 110 CFM fans can also be used with the MD6TU universal make-up air damper if 6" rigid duct is used. ULTRA non-sensing fans (not fan/lights) can also be used with the RDF1 radiation damper. Now with QStream sound technology that features airflow-smoothing baffles to reduce noise caused by turbulence (50 and 80 CFM models only).

Model No.	Description	Std. Pk.	List Price	Code
Fans				
ZN80 ◆	30 CFM to 80 CFM, <0.3 Sones, ENERGY STAR Fan	1	\$308.94	HP
ZN110 ◆	30 CFM to 110 CFM, <0.3 Sones, ENERGY STAR Fan	1	\$337.68	HP
Fan/Light/Night Light				
ZN80L ◆	30 CFM to 80 CFM, <0.3 Sones, ENERGY STAR Fan with 36W Fluorescent Light (2-18 watt GU24 bulbs included) and 4W Night Light (bulb not included)	1	\$423.68	HP
ZN110L ◆	30 CFM to 110 CFM, <0.3 Sones, ENERGY STAR Fan with 36W Fluorescent Light (2-18 watt GU24 bulbs included) and 4W Night Light (bulb not included)	1	\$454.76	HP



All models are ENERGY STAR certified products.

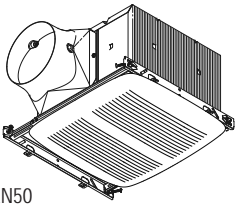

XN50
XN80
XN110

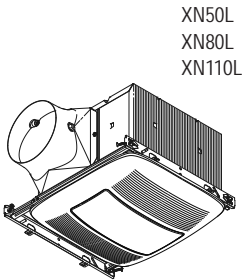

XN50L
XN80L
XN110L

NuTone® ULTRA™ Green Single-Speed Series

We started with installation and worked back to build the ultimate bath fan. Unique telescoping mounting frame is ideal for both new construction and retrofit. No attic access needed! ASHRAE 62.2, LEED, ENERGY STAR® for Homes and CA Title 24 compliant. Powerful operation maintained over a wide range of real-world installations (CFM rating at 0.1" static pressure maintained through 0.25" static pressure). Fits in 2" x 8" ceiling construction. 10-1/2" L x 11-3/8" W x 7-5/8" H housing. 13" x 14" grille (fan) and 13" x 13-1/4" (fan/light/night light). All models have a 6" duct connector and the 50 CFM and 80 CFM models include a 6" to 4" reducer. All ULTRA 80 and 110 CFM fans can also be used with the MD6TU universal make-up air damper if 6" rigid duct is used. ULTRA non-sensing fans (not fan/lights) can also be used with the RDF1 radiation damper. Now with QStream sound technology that features airflow-smoothing baffles to reduce noise caused by turbulence (50 and 80 CFM models only).

Model No.	Description	Std. Pk.	List Price	Code
Fans				
XN50 ◆	50 CFM, <0.3 Sones, ENERGY STAR Fan	1	\$264.80	HP
XN80 ◆	80 CFM, <0.3 Sones, ENERGY STAR Fan	1	\$281.14	HP
XN110 ◆	110 CFM, <0.3 Sones, ENERGY STAR Fan	1	\$301.50	HP
Fan/Light/Night Light				
XN50L ◆	50 CFM, <0.3 Sones, ENERGY STAR Fan with 36W Fluorescent Light (2-18 watt GU24 bulbs included) and 4W Night Light (bulb not included)	1	\$373.90	HP
XN80L ◆	80 CFM, <0.3 Sones, ENERGY STAR Fan with 36W Fluorescent Light (2-18 watt GU24 bulbs included) and 4W Night Light (bulb not included)	1	\$403.14	HP
XN110L ◆	110 CFM, <0.3 Sones, ENERGY STAR Fan with 36W Fluorescent Light (2-18 watt GU24 bulbs included) and 4W Night Light (bulb not included)	1	\$416.52	HP



All models are ENERGY STAR certified products.

- Item too large to ship via UPS/FedEx. Item shipped common carrier at minimum rates.
- * All pricing reflects the individual item cost. You must order in multiples as indicated.
- ◆ UL listed for use over bathtubs and showers when connected to a GFCI protected branch circuit.

Ventilation Fans — ULTRA™

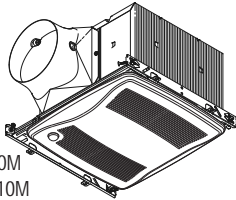

ZN80M
ZN110M

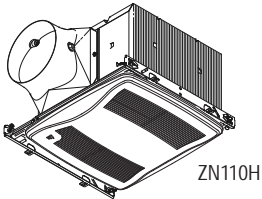

ZN110H

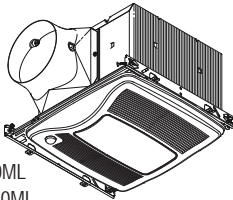

ZN80ML
ZN110ML

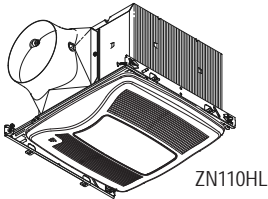

ZN110HL

NuTone® ULTRA™ Green Multi-Speed Series — Sensing

We started with installation and worked back to build the ultimate bath fan. Unique telescoping mounting frame is ideal for both new construction and retrofit. No attic access needed! DC motor for efficiency. Multi-speed capability ideal for meeting ASHRAE 62.2, LEED, ENERGY STAR® for Homes and CA Title 24 — as well as local/spot ventilation needs. Humidity or motion sensing triggers fan to ramp up from lower continuous ventilation level to maximum CFM. Powerful operation maintained over a wide range of real-world installations (CFM rating at 0.1" static pressure maintained through 0.25" static pressure). Fits in 2" x 8" ceiling construction. 10-1/2" L x 11-3/8" W x 7-5/8" H housing. 13" x 14" grille (fan) and 13" x 13-1/4" (fan/light/night light). All models have a 6" duct connector and the 80 CFM models include a 6" to 4" reducer. All ULTRA 80 and 110 CFM fans can also be used with the MD6TU universal make-up air damper if 6" rigid duct is used. ULTRA non-sensing fans (not fan/lights) can also be used with the RDF1 radiation damper. Now with QStream sound technology that features airflow-smoothing baffles to reduce noise caused by turbulence (50 and 80 CFM models only).

Model No.	Description	Std. Pk.	List Price	Code
Fans				
ZN80M	◆ 80 CFM, <0.3 Sones, ENERGY STAR Motion Sensing Fan	1	\$356.76	HP
ZN110H	◆ 110 CFM, <0.3 Sones, ENERGY STAR Humidity Sensing Fan	1	\$448.82	HP
ZN110M	◆ 110 CFM, <0.3 Sones, ENERGY STAR Motion Sensing Fan	1	\$383.74	HP
Fan/Light/Night Light				
ZN80ML	◆ 80 CFM, <0.3 Sones, ENERGY STAR Motion Sensing Fan with 36W Fluorescent Light (2-18 watt GU24 bulbs included) and 4W Night Light (bulb not included),	1	\$478.38	HP
ZN110HL	◆ 110 CFM, <0.3 Sones, ENERGY STAR Humidity Sensing Fan with 36W Fluorescent Light (2-18 watt GU24 bulbs included) and 4W Night Light (bulb not included)	1	\$570.70	HP
ZN110ML	◆ 110 CFM, <0.3 Sones, ENERGY STAR Motion Sensing Fan with 36W Fluorescent Light (2-18 watt GU24 bulbs included) and 4W Night Light (bulb not included)	1	\$511.80	HP



All models are ENERGY STAR certified products.

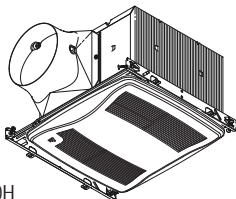

XN110H

XN110HL

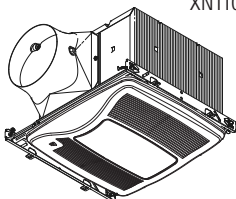

NuTone® ULTRA™ Green Single-Speed Series — Sensing

We started with installation and worked back to build the ultimate bath fan. Unique telescoping mounting frame is ideal for both new construction and retrofit. No attic access needed! DC motor for efficiency. ASHRAE 62.2, LEED, ENERGY STAR® for Homes and CA Title 24 compliant. Humidity sensing models will automatically turn fan on when rapid rise in humidity is sensed. Powerful operation maintained over a wide range of real-world installations (CFM rating at 0.1" static pressure maintained through 0.25" static pressure). Fits in 2" x 8" ceiling construction. 10-1/2" L x 11-3/8" W x 7-5/8" H housing. 13" x 14" grille (fan) and 13" x 13-1/4" (fan/light/night light). All models have a 6" duct connector. All ULTRA 80 and 110 CFM fans can also be used with the MD6TU universal make-up air damper if 6" rigid duct is used. ULTRA non-sensing fans (not fan/lights) can also be used with the RDF1 radiation damper. Now with QStream sound technology that features airflow-smoothing baffles to reduce noise caused by turbulence (50 and 80 CFM models only).

Model No.	Description	Std. Pk.	List Price	Code
Fan				
XN110H	◆ 110 CFM, <0.3 Sones, ENERGY STAR Humidity Sensing Fan	1	\$404.48	HP
Fan/Light/Night Light				
XN110HL	◆ 110 CFM, <0.3 Sones, ENERGY STAR Humidity Sensing Fan with 36W Fluorescent Light (2-18 watt GU24 bulbs included) and 4W Night Light (bulb not included)	1	\$523.64	HP



All models are ENERGY STAR certified products.

- Item too large to ship via UPS/FedEx. Item shipped common carrier at minimum rates.
- * All pricing reflects the individual item cost. You must order in multiples as indicated.
- ◆ UL listed for use over bathtubs and showers when connected to a GFCI protected branch circuit.

Ventilation Fans — ULTRA™

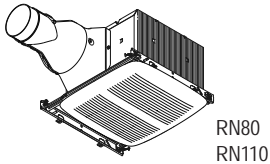

RN80
RN110

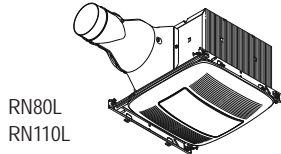

RN80L
RN110L

NuTone® ULTRA™ Pro Fan and Fan/Light Series

The preferred install choice for professionals to deliver quiet performance *ULTRA*Quick™ installation, with no attic access required. QStream™ sound technology features airflow-smoothing baffles to reduce noise caused by turbulence and QFlow™ sound technology that removes the duct damper from the airstream to reduce static pressure. 4" duct for ideal retrofit installation and ENERGY STAR® certified. 10-1/2" x 11-3/8" x 7-5/8" housing fits 2" x 8" ceiling construction. UL Listed for use over bathtubs and showers when connected to a GFCI protected branch circuit.

Model No.	Description	Std. Pk.	List Price	Code
Fans				
RN80	80 CFM, <0.3 Sones, ENERGY STAR Fan	1	\$262.06	HP
RN110	110 CFM, 0.6 Sones, ENERGY STAR Fan	1	\$290.68	HP
Fan/Light				
RN80L	80 CFM, <0.3 Sones, ENERGY STAR Fan/Light, two energy efficient 18W GU24 Fluorescent Lights (bulbs included)	1	\$383.00	HP
RN110L	110 CFM, 0.8 Sones, ENERGY STAR Fan/Light, two energy efficient 18W GU24 Fluorescent Lights (bulbs included)	1	\$408.46	HP



All models are ENERGY STAR certified products.

Ventilation Fans — QT Series™

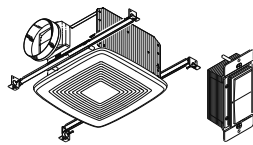

SSQTXE080
SSQTXE110

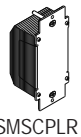

SMSCPLR

Broan SmartSense® Intelligent Ventilation System

The intelligent fan control system creates an integrated residential exhaust ventilation system using Broan's industry leading ventilation control technology and award winning QTXE fans. The Broan SmartSense system uses Broan's Link-Logic™ control technology powered by INSTEON™, a powerful communication technology to monitor everyday manual fan usage throughout the home. Broan SmartSense calculates additional ventilation required by Green Building and ASHRAE Standard 62 related requirements and automatically controls installed fans to achieve proper ventilation. SSQTXE080 and SSQTXE110 fans can provide a single fan solution for small apartments or mix and matched for a customized, integrated ventilation system.

Model No.	Description	Std. Pk.	List Price	Code
SSQTXE080	80 CFM SmartSense Fan with Control	1	\$287.06	HV
SSQTXE110	110 CFM SmartSense Fan with Control	1	\$318.84	HV
SMSCPLR †	SmartSense Phase Coupler	1	\$45.90	AR

† The SmartSense Phase Coupler is only required when fans are located on separate phases of power. If fans are on the same circuit or phase, the phase coupler is not necessary.

Broan® Ventilation Fan with Sensonic™ Speakers and Speaker Kit

Unlike wireless speakers that require counter space, Sensonic speakers with Bluetooth® wireless technology fill your room with rich sound from above. From hard rock to news talk, play any audio through the dual high-fidelity speakers and enjoy entertainment and privacy at the touch of a button. It's brilliant audio performance concealed behind the fan grille.

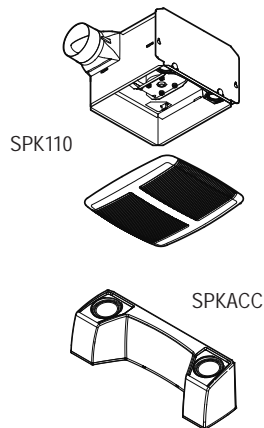

SPK110

SPKACC

Model No.	Description	Std. Pk.	List Price	Code
SPK110	Sensonic Speaker Fan; 110 CFM, 1.0 Sones	1	\$394.84	HV
SPKACC	Sensonic Speaker Accessory	1	\$181.98	AC

- Item too large to ship via UPS/FedEx. Item shipped common carrier at minimum rates.
- * All pricing reflects the individual item cost. You must order in multiples as indicated.
- ◆ UL listed for use over bathtubs and showers when connected to a GFCI protected branch circuit.

Ventilation Fans — QT Series™

NuTone® QT Series™ Fan and Fan/Light/Night Light Series (QTXEN Models)

The industry's quietest, most powerful and stylish fans with a 3 year warranty. 6" ducting for superior performance and ENERGY STAR certified. Includes hanger bar system for fast and flexible installations for all types of construction. 10-1/2" x 11-3/8" x 7-5/8" high housing. 12-7/8" x 13-5/8" grille (QTXEN fans) and 13" x 14" grille (QTXEN fan/lights). Type IC.



QTXEN080
QTXEN110

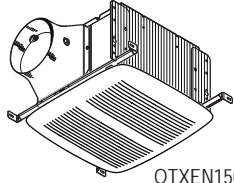

QTXEN150

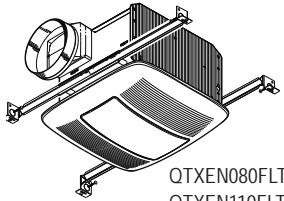

QTXEN080FLT
QTXEN110FLT

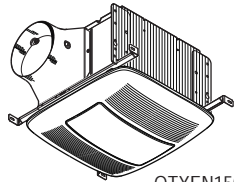

QTXEN150FLT

Model No.	Description	Std. Pk.	List Price	Code
Fans				
QTXEN080 ◆	80 CFM, 0.3 Sones, ENERGY STAR Fan	1	\$252.68	HV
QTXEN110 ◆	110 CFM 0.7 Sones, ENERGY STAR Fan	1	\$285.90	HV
QTXEN150 ◆	150 CFM, 1.4 Sones, ENERGY STAR Fan	1	\$342.46	HV
Fan/Light/Night Light				
QTXEN080FLT ◆	80 CFM, 0.3 Sones, ENERGY STAR Fan with 36W Fluorescent Light (2-18 watt GU24 bulbs included) and 4W Night Light (bulb not included)	1	\$372.34	HV
QTXEN110FLT ◆	110 CFM, 0.7 Sones, ENERGY STAR Fan with 36W Fluorescent Light (2-18 watt GU24 bulbs included) and 4W Night Light (bulb not included)	1	\$412.22	HV
QTXEN150FLT ◆	150 CFM, 1.4 Sones, ENERGY STAR Fan with 36W Fluorescent Light (2-18 watt GU24 bulbs included) and 4W Night Light (bulb not included)	1	\$482.08	HV



All models are ENERGY STAR certified products.

NuTone® LunAura Collection Ambient Ultra Silent™ Fan/Light

Great for any room in the home. The benefits of powerful, ultra silent, ENERGY STAR certified ventilation. Now come with a soft beautiful blue LED night light which delivers improved safety and navigation as well as a calming spa setting.

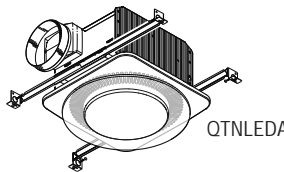

QTNLEDA

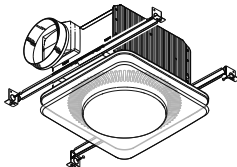

QTNLEDB

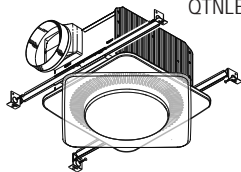

Model No.	Description	Std. Pk.	List Price	Code
QTNLEDA	110 CFM, 0.7 Sones, ENERGY STAR Fan/Light/Night Light with 36 watt (2-18) GU24 bulbs included. 6" or 4" duct. Round design.	1	\$423.30	NF
QTNLEDB	110 CFM, 0.7 Sones, ENERGY STAR Fan/Light/Night Light with 36 watt (2-18) GU24 bulbs included. 6" or 4" duct. Square/Diamond design.	1	\$423.30	NF



All models are ENERGY STAR certified products.

- Item too large to ship via UPS/FedEx. Item shipped common carrier at minimum rates.
- * All pricing reflects the individual item cost. You must order in multiples as indicated.
- ◆ UL listed for use over bathtubs and showers when connected to a GFCI protected branch circuit.

Ventilation Fans — InVent™ Series

NuTone® InVent™ Series Ventilation Fans

New, versatile housing platform that marks a revolution of our mid-range ventilation fans and allows for easy installation in both new construction and retrofit applications. 10" x 9-1/4" x 5-3/4" housing features foldable mounting ears for easy, room-side replacement. 4" duct connector mounts from the inside of the housing and features a new damper technology, improving air tightness scores.

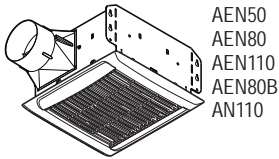

AEN50
AEN80
AEN110
AEN80B
AN110

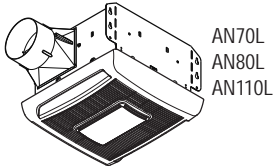

AN70L
AN80L
AN110L

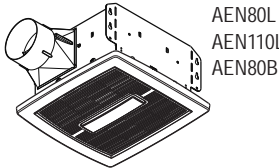

AEN80L
AEN110L
AEN80BL

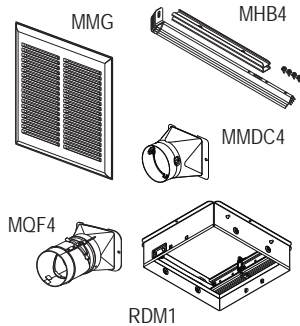

MMG

MHB4

MMDC4

MQF4

RDM1

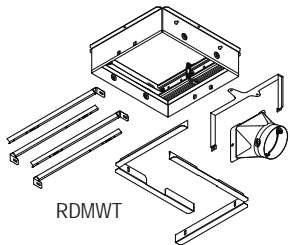

RDMWT

Model No.		Description	Std. Pk.	List Price	Code
Ventilation Fans					
AN110	Ω	110 CFM, 3.0 Sones	1	\$166.68	HM
AEN50	Ω	50 CFM, 0.5 Sones, ENERGY STAR Fan	1	\$166.68	HM
AEN80	Ω	80 CFM, 0.8 Sones, ENERGY STAR Fan	1	\$240.00	HM
AEN110	Ω	110 CFM, 1.3 Sones, ENERGY STAR Fan	1	\$266.68	HM
AEN80B	Ω	80 CFM, 1.5 Sones, ENERGY STAR Fan	1	\$116.68	HM
Ventilation Fan/Lights					
AN70L		70 CFM, 2.0 Sones, Fan/Light	1	\$146.68	HM
AN80L		80 CFM, 1.0 Sones, Fan/Light	1	\$350.00	HM
AN110L		110 CFM, 1.3 Sones, Fan/Light	1	\$383.34	HM
AEN80BL	Ω	LED Light, 80 CFM, 1.5 Sones, ENERGY STAR Fan/Light	1	\$216.66	HM
AEN80L	Ω	LED Light, 80 CFM, 0.8 Sones, ENERGY STAR Fan/Light	1	\$400.00	HM
AEN110L	Ω	LED Light, 110 CFM, 1.3 Sones, ENERGY STAR Fan/Light	1	\$433.34	HM
Accessories					
MHB4		Hanger Bars	1	\$20.00	AC
MMDC4	■	Metal Duct Connector	1	\$25.00	AC
MMG		Metal Grille, White	1	\$43.34	AC
MQF4		QFlow Duct Connector	1	\$20.00	AC
RDM1		Radiation Damper	1	\$166.68	HM
RDMWT		Radiation Damper for UL wood truss assembly listings L521, L528, L546, L558, L562, L574, L576, L581, L583, L585, P522, P533, P538, P545 and P547. Available May, 2017.	1	\$166.68	HM

Ω Works with Model RDM1 and RDMWT radiation damper.



Select models are ENERGY STAR certified products — see product description

■ Limited quantities available.

- Item too large to ship via UPS/FedEx. Item shipped common carrier at minimum rates.
- * All pricing reflects the individual item cost. You must order in multiples as indicated.
- ◆ UL listed for use over bathtubs and showers when connected to a GFCI protected branch circuit.

Ventilation Fans

NuTone® Recessed Fan/Lights

Recessed lights are popular lighting solutions. But NuTone took it a step further by incorporating powerful ventilation in the same design. Our new fan/lights disappear into the ceiling with other recessed lights, so they are practical decorating solutions for any room in the house. In the bath they control humidity, and in a utility room, kitchen or high-traffic family room they keep the air fresh and comfortable. 12-3/4" x 8-1/4" x 6-3/4" high housing. 7-3/8" round trim. Damper/duct connector fits 4" duct. Type IC. Fits 2" x 6" ceiling construction.



744NT
744FLNT
744LEDNT
744SFLNT

Model No.	Description	Std. Pk.	List Price	Code
744NT	◆ Recessed Fan/Light, 70 CFM, 1.5 Sones, 6" white trim. Uses 75W max R30 or BR30 bulb for standard applications.	1	\$171.96	NF
744FLNT	◆ ENERGY STAR Recessed Fan/Light, 70 CFM, 1.5 Sones, 6" white trim. Uses 16W R30 fluorescent bulb (bulb included).	1	\$238.46	NF
744LEDNT	◆ ENERGY STAR Recessed Fan/LED Light, 70 CFM, 1.5 Sones, 6" white trim. Uses 10W BR30 LED bulb (bulb included).	1	\$307.98	NF
744SFLNT	◆ ENERGY STAR Recessed Humidity Sensing Fan/Fluorescent Light, 70 CFM, 1.5 Sones. 6" white trim. Uses 16W R30 fluorescent bulb (bulb included).	1	\$342.68	NF



Select models are ENERGY STAR certified products.

NuTone® LoProfile™ Ventilation Fan

The new NuTone LoProfile™ fan is our latest solution for installations where conventional ventilation simply won't fit. Where multi-family applications require it, the LoProfile™ fan is narrow enough to be installed in a wall between 2 x 4 studs. When plumbing or electrical obstructions are found behind the drywall in ceiling remodel applications our LoProfile™ fan can still fit without having to move anything. And that means most any room with space constraints can have powerful, quiet and efficient ventilation.

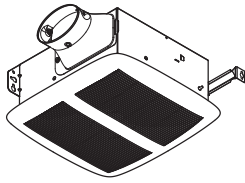

Model No.	Description	Std. Pk.	List Price	Code
LPN80	ENERGY STAR Fan, 80 CFM, 1.0 Sones	1	\$148.96	HV



ENERGY STAR certified product.

- Item too large to ship via UPS/FedEx. Item shipped common carrier at minimum rates.
- * All pricing reflects the individual item cost. You must order in multiples as indicated.
- ◆ UL listed for use over bathtubs and showers when connected to a GFCI protected branch circuit.

Ventilation Fans

NuTone® EZFit Ventilation Fan

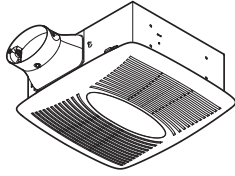

EZFit ventilation fan easily replaces your existing fan in 40 minutes entirely from the room-side. EZLock tabs secure fan directly to drywall, eliminating need for joist/truss mounting. EZConnect wiring connectors eliminate clumsy wire nuts. EZDuct connector allows attachment of existing duct from inside housing so no need to go in the attic. Slim housing fits in virtually all ceiling spaces. Housing dimensions: 12" L x 10-1/2" W x 5" H. Grille dimensions: 12-1/2" L x 13" W.

Model No.	Description	Std. Pk.	List Price	Code
EZ80N	ENERGY STAR Ventilation Fan. 80 CFM, 1.0 Sones	1	\$236.60	HV



ENERGY STAR certified product.

NuTone Basic® Fans

Molded plastic impeller, two-pole motor, 7-1/4" x 7-1/2" x 3-5/8" high galvanized steel housing for ceiling or wall installation. Spring mounted 8-11/16" x 9" plastic grille. Damper/duct connector fits 3" round duct. Snap-in motor plate requires no tools for installation or removals. Fits 2" x 4" ceiling or wall construction.



695
696N

Model No.	Description	Std. Pk.	List Price	Code
695	◆ 70 CFM, 6.0 Sones. Fan — 3" Duct	1	\$59.46	LV
696N	◆ 50 CFM, 4.0 Sones. Fan — 3" Duct	1	\$45.18	LV

All models also available in project packs, see Page 62.

NuTone® Fan/Lights

Powerful fans remove stale air and damaging moisture. 9" x 9" x 6" housing. Damper/duct connector fits 4" round duct. Bright lighting and 7W night light. All models are Type IC. Bulbs not included.

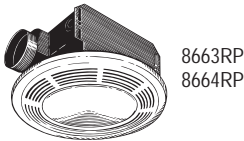

8663RP
8664RP

Model No.	Description	Std. Pk.	List Price	Code
8663RP	100 CFM, 3.5 Sones. Fan/Light/Night Light, Round White Grille with glass lens, 100W max Incandescent Light, 7W Night Light.	1	\$244.08	HV
8664RP	100 CFM, 3.5 Sones. Fan/Light, Round White Grille with glass lens, 100W max Incandescent Light.	1	\$220.04	HV

NuTone® Fan/Lights

Operate fan and light together or independently. Damper/duct connector fits 4" round duct. All models are Type IC. Bulbs not included. Fits 2" x 6" ceiling construction.

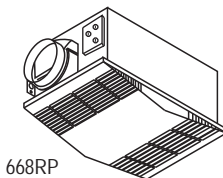

668RP

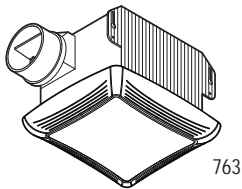

763

Model No.	Description	Std. Pk.	List Price	Code
668RP	◆ 70 CFM, 4.0 Sones. Fan with 100W max incandescent light (bulb not included) — 4" Duct.	1	\$141.06	LV
763	◆ 50 CFM, 2.5 Sones. Fan with 100W max incandescent light (bulb not included) — 4" Duct.	1	\$94.46	LV
MCB2	Mounting Channel/Brackets for Single Packs (2 channels/4 brackets). Works with Model 763.	1	\$14.94	AC

Select models available in project packs, see Page 62.

- Item too large to ship via UPS/FedEx. Item shipped common carrier at minimum rates.
- * All pricing reflects the individual item cost. You must order in multiples as indicated.
- ◆ UL listed for use over bathtubs and showers when connected to a GFCI protected branch circuit.

Ventilation Fans

NuTone® Bath Fan Upgrade Kit

The patented economy fan Bath Fan Upgrade Kit improves performance, reduces the sound level, and upgrades the appearance of your economy fan in 10 minutes. Provide easy upgrade for economy fan without replacing the entire housing, rewiring and reconnecting the duct. Helps ensure tenant/homeowner is using the fan when needed most. Reduces sound up to 50%, improves air movement up to 20% and helps control humidity that causes mold and mildew. Kit includes quiet fan motor, grille, wrench and two motor plates.

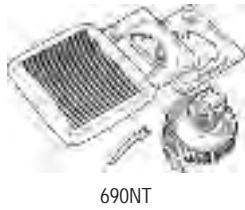

690NT

Model No.	Description	Std. Pk.	List Price	Code
690NT ◆	60 CFM, 3.0 Sones Fan, Economy Upgrade Kit	1	\$59.74	UK

The 690NT Upgrade Kit replaces the models below.

Model No.	Housing Dimension
NuTone: 693, 695 & 696N	7-1/2" x 7-1/4" or 8" x 7-1/4"
Broan: 670, 671, 688 & 689	7-1/2" x 7-1/4" only 8" x 8-1/4" are not compatible.
Nautilus: N671 & N688	

NuTone® Duct-Free Fan

No ductwork necessary! Ideal for powder rooms and closets. Fits in 2" x 4" construction.

Model No.	Description	Std. Pk.	List Price	Code
682NT	Duct-Free Fan with plastic grille. Includes long lasting, easy to replace, activated charcoal filter. Easy snap-in mounting.	1	\$67.62	LV

Ventilation Fans — Project Packs

NuTone® InVent™ Series Project Packs (Housing and Finish Packs)

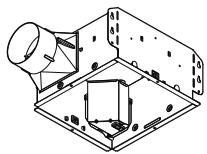

AN000HF

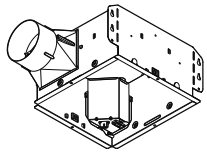

AN000HL

Model No.	Description	Std. Pk.	List Price	Code
Housing Packs				
AN000HF	Ventilation Fan Housing Pack	4 *	\$23.34	HM
AN000HL	Ventilation Fan/Light Housing Pack	4 *	\$23.34	HM
Finish Packs				
AEN50F Ω	50 CFM, 0.5 Sones, ENERGY STAR Finish Pack	4 *	\$143.34	HM
AEN80BF Ω	80 CFM, 1.5 Sones, ENERGY STAR Finish Pack	4 *	\$93.34	HM
AEN80BLF Ω	LED Light, 80 CFM, 1.5 Sones, ENERGY STAR Finish Pack	4 *	\$193.32	HM
AEN80F Ω	80 CFM, 0.8 Sones, ENERGY STAR Finish Pack	4 *	\$216.68	HM
AEN80LF Ω	LED Light, 80 CFM, 0.8 Sones, ENERGY STAR Finish Pack	4 *	\$376.68	HM
AEN110F Ω	110 CFM, 1.3 Sones, ENERGY STAR Finish Pack	4 *	\$243.34	HM
AN70LF	70 CFM, 2.0 Sones, Finish Pack	4 *	\$123.34	HM
AN80HDF ■	80 CFM, 2.0 Sones, Metal Grille, Finish Pack	4 *	\$170.00	HM
AN110F Ω	110 CFM, 3.0 Sones, Finish Pack	4 *	\$143.34	HM

Ω Works with Model RDM1 and RDMWT radiation damper.

■ Limited quantities available.



Select models are ENERGY STAR certified products — see product description.

- Item too large to ship via UPS/FedEx. Item shipped common carrier at minimum rates.
- * All pricing reflects the individual item cost. You must order in multiples as indicated.
- ◆ UL listed for use over bathtubs and showers when connected to a GFCI protected branch circuit.

Ventilation Fans — Project Packs

NuTone® LoProfile™ Project Pack

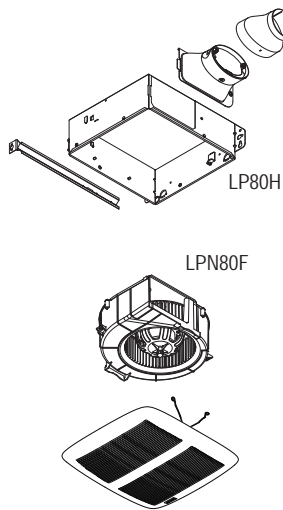

The new NuTone LoProfile™ fan is our latest solution for installations where conventional ventilation simply won't fit. Where multi-family applications require it, the LoProfile™ fan is narrow enough to be installed in a wall between 2 x 4 studs. When plumbing or electrical obstructions are found behind the drywall in ceiling remodel applications, our LoProfile™ fan can still fit without having to move anything. And that means most any room with space constraints can have powerful, quiet and efficient ventilation. Project Packs offer availability to buy housings for rough-in and motor/blower assemblies and grille later for finishing.

Model No.	Description	Std. Pk.	List Price	Code
LP80H	Housing Pack for LPN80	4 *	\$28.04	HV
LPN80F	ENERGY STAR Finish Pack. Motor and Grille Assembly, 80 CFM, 1.0 Sones.	4 *	\$120.92	HV



ENERGY STAR certified products.

NuTone® Radiation Damper Accessory Kit

Model No.	Description	Std. Pk.	List Price	Code
RDFQF	Radiation damper accessory that works with Models SSQTXE110, SSQTXE080, QTREN080, QTREN110, QTXEN050, QTXEN080, QTXEN110, QTRN110F, QTREN110F, QTRN080F and QTREN080F.	1	\$121.24	HV
RDFQL	Radiation damper accessory that works with Models QTREN080FLT, QTREN110FLT, QTXEN080FLT, QTXEN110FLT, QTREN110FLFT and QTREN080FLFT. Also works with Models QTXEN110S and QTXEN110SFLT when used with RDJUMPO accessory.	1	\$121.24	HV
RDFU	Radiation damper accessory that works with Models QTXEN150, QTXEN150FLT, RN80, RN110, XN50, XN80, XN110, ZN80 and ZN110. Also works with Models RN80L, RN110L, XN110HL, ZN110HL, ZN80ML, ZN110ML, XN50L, XN80L, XN110L, ZN80L, ZN110L, XN110H, ZN110H, ZN80M and ZN110M when used with RDJUMPU accessory.	1	\$121.24	HP
RDFUWT	Radiation damper accessory that works with Models QTXEN150, QTXEN150FLT, RN80, RN110, XN50, XN80, XN110, ZN80 and ZN110. Also works with Models RN80L, RN110L, XN110HL, ZN110HL, ZN80ML, ZN110ML, XN50L, XN80L, XN110L, ZN80L, ZN110L, XN110H, ZN110H, ZN80M and ZN110M when used with RDJUMPU accessory. For UL wood truss assembly listings L521, L528, L546, L558, L562, L574, L576, L581, L583, L585, P522, P533, P538, P545 and P547. Available May, 2017.	1	\$121.24	HP
RDJ1	Radiation damper accessory with metal grille and metal duct connector (no housing). Works with 50NT, 80NT, HD50NT and HD80NT.	1	\$141.36	HV
RDF1	Radiation damper. Works with ULTRA® Series non-sensing fans (not fan/lights) and LPN80.	1	\$121.24	HP
Accessories				
RDJUMPO	Wiring jumper kit required for use with RDFQL when used with Models QTXEN110S and QTXEN110SFLT.	1	\$8.44	AC
RDJUMPU	Wiring jumper kit required for use with RDFU when used with Models XN110HL, ZN110HL, ZN80ML, ZN110ML, XN50L, XN80L, XN110L, ZN80L, ZN110L, XN110H, ZN110H, ZN80M and ZN110M.	1	\$16.90	AC
804QDD	4" metal connector for use with QT models.	1	\$18.22	AC

■ Limited quantities available.

- Item too large to ship via UPS/FedEx. Item shipped common carrier at minimum rates.
- * All pricing reflects the individual item cost. You must order in multiples as indicated.
- ◆ UL listed for use over bathtubs and showers when connected to a GFCI protected branch circuit.

NuTone® Fan & Fan/Light Project Packs

NuTone's Project Packs offer a variety of housings packed and sold separately from motor assembly and grille. You can buy housings for rough-in ... by assemblies and grilles later for finishing.

Fan/Light Project Packs — Fits 2" x 6" Ceiling Construction

Model No.	Description	Std. Pk.	List Price	Code
763F	50 CFM, 2.5 Sones, Fan/Light Finish Pack	4 *	\$78.06	LV
763H	50 CFM, 2.5 Sones, Fan/Light Finish Pack	4 *	\$16.40	LV

Basic Fan Project Packs — Fits 2" x 4" Ceiling or Wall Construction

Model No.	Description	Std. Pk.	List Price	Code
690RA	Housing Pack. Housing for 695RB and 696RNB.	6 *	\$9.98	LV
690RMTLA	Series "A" Unit with Metal Duct Collar. Housing for 696RNB and 695RB (replaces 690MTL).	6 *	\$23.24	LV
695RB	◆ Finish Pack. Fan Motor/Grille Assembly. 70 CFM, 6.0 Sones. Uses 690RA housing pack.	6 *	\$49.48	LV
696RNB	◆ Finish Pack. Fan Motor/Grille Assembly. 50 CFM, 4.0 Sones. Uses 690RA housing pack.	6 *	\$35.20	LV

● Item too large to ship via UPS/FedEx. Item shipped common carrier at minimum rates.

* All pricing reflects the individual item cost. You must order in multiples as indicated.

◆ UL listed for use over bathtubs and showers when connected to a GFCI protected branch circuit.

Ventilation Fans — Remote In-Line

NuTone® In-Line Fans

Remote mounted for adaptable and quiet ventilation.

Model No.	Description	Std. Pk.	List Price	Code
ILF120	4" — 110 CFM In-Line Fan, ENERGY STAR certified	1	\$320.94	HV
ILF130	5" — 130 CFM In-Line Fan, ENERGY STAR certified	1	\$336.22	HV
ILF250	6" — 250 CFM In-Line Fan, ENERGY STAR certified	1	\$351.50	HV
ILF360	8" — 360 CFM In-Line Fan	1	\$482.02	HV
ILF530	10" — 530 CFM In-Line Fan	1	\$631.14	HV
ILRF	4"/5" Radon In-Line Fan	1	\$310.64	HV



Select models are ENERGY STAR certified products — see product description.

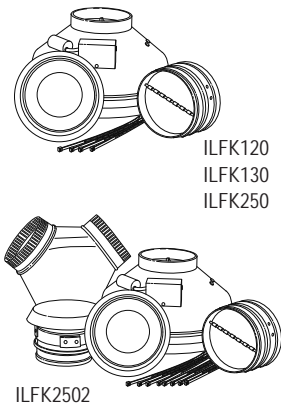

NuTone® In-Line Fan Kits (Complete Installation Kits)

Kit includes all components to install a single dual point exhaust system (except wall control, wire and ducting). Each kit includes fan, damper and duct clamps.

Model No.	Description	Std. Pk.	List Price	Code
ILFK120	4" — 110 CFM In-Line Fan/Grille — Kit, ENERGY STAR certified	1	\$351.50	HV
ILFK130	5" — 130 CFM In-Line Fan/Grille — Kit, ENERGY STAR certified	1	\$366.80	HV
ILFK250	6" — 250 CFM In-Line Fan/Grille — Kit, ENERGY STAR certified	1	\$397.32	HV
ILFK2502	6" — 250 CFM In-Line Fan/Grille — Kit (Includes Y-adaptor and two grilles), ENERGY STAR certified	1	\$458.50	HV



Select models are ENERGY STAR certified products — see product description.

NuTone® In-Line Fan Accessories

Model No.	Description	Std. Pk.	List Price	Code
CVG4	4" Grille	1	\$35.38	AC
CVG6	6" Grille	1	\$47.56	AC
CVLD4	4" Sleeve with Damper	1	\$47.84	AC
CVLD6	6" Sleeve with Damper	1	\$57.12	AC
FY6	6" x 6" x 6" Y-Adaptor	1	\$46.20	AC
FY86	8" x 6" x 6" Y-Adaptor	1	\$35.56	AC

- Item too large to ship via UPS/FedEx. Item shipped common carrier at minimum rates.
- * All pricing reflects the individual item cost. You must order in multiples as indicated.
- ◆ UL listed for use over bathtubs and showers when connected to a GFCI protected branch circuit.

Ventilation Fans — Heater Combinations

NuTone® QT Series™ Heater/Fan/Light

Powerful heating, lighting and ventilation available at the touch of a switch. Quiet, high output 1500 watt heater with exclusive PowerHeat™ design. Requires a dedicated 20 amp circuit. 3 year warranty. 6" ducting for superior performance. 17-5/8" x 11-3/8" x 7-5/8" high housing with hanger bar system. 20" x 15" grille. Fits 2" x 8" ceiling construction.

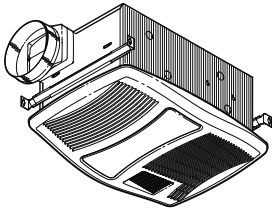

QTXN110HL
QTXN110HFLT



77DW
77DV

Model No.	Description	Std. Pk.	List Price	Code
QTXN110HL	110 CFM, 0.9 Sones, Fan with 1500W heater, 2-60W max incandescent lights and 7W night light (bulbs not included). Recommend 77 Series switch.	1	\$548.52	HV
QTXN110HFLT	110 CFM, 0.9 Sones, Fan with 1500W heater, 2-18W high efficiency, GU24 based fluorescent light (bulbs included) and 7W night light (bulb included) Recommend 77 Series switch.	1	\$610.34	HV
77DW / 77DV	Three-Switch Control for use with sensing Fan/Lights (top switch provides three settings for sensor On/Auto/Off), remaining switches control light, night light and QT Heater/Fan/Light/Night Light (top switch controls light and night light, remaining switches control fan and heater).	1	\$44.60	AC

NuTone® Directionally-Adjustable Heater with Fan and Light

These heaters feature 1500 watts of powerful, directionally-adjustable heat along with 100 CFM of ventilation at only 2.0 sones. They have 4" ducting and fit in 2" x 6" ceiling construction. Attractive grilles are 17-1/2" x 11-1/2" covering a 16" x 10-1/4" x 5-7/8" housing.

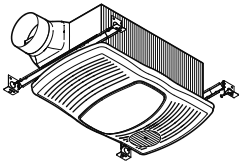

Model No.	Description	Std. Pk.	List Price	Code
765HL	Features 100W max incandescent lighting (bulb not included)	1	\$304.68	LV
765HFL	Features 27W fluorescent lighting (bulb included)	1	\$366.52	LV

NuTone® Heater Combinations with Wall Switch Included

Comfort and convenience combined. Produces instant heat when needed. Select a heater with ventilation fan and/or light with night light (bulbs not included). Housing sizes are noted below and all fit in 2" x 8" ceiling construction.

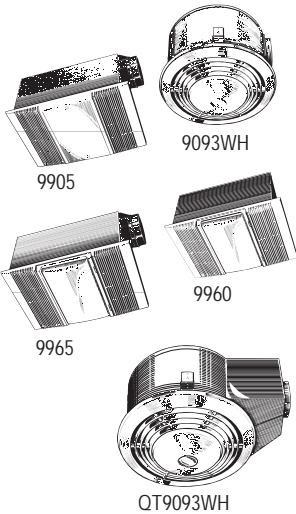

Model No.	Description	Std. Pk.	List Price	Code
9093WH	70 CFM, 3.5 Sones, Combination fan with 1500W heater, 100W incandescent light, 7W night light and white enamel grille. Includes a four-function wall switch. 4" duct connector.	1	\$414.70	HV
9905	70 CFM, 4.0 Sones, Combination fan with 1500W heater. Includes two-function switch. 4" duct connector.	1	\$346.34	HV
9960	1500W heater with 100W max incandescent light and 7W night light. Includes three-function switch.	1	\$313.24	HV
9965	70 CFM, 4.0 Sones, Combination fan with 1500W heater, 100W max incandescent light and 7W night light. Includes four-function switch. 4" duct connector.	1	\$364.42	HV
QT9093WH	110 CFM, 3.0 Sones, Combination fan with 1500W heater, 100W max incandescent light, 7W night light and white enamel grille. Includes a four-function wall switch. 4" duct connector.	1	\$507.64	HV

Rough-in housing sizes: 9093WH — 15-3/8" dia. x 7-1/2"
 9095 — 9-3/4" x 14" x 7-3/4"
 9960 — 9-3/4" x 14" x 7-3/4"
 9965 — 9-3/4" x 14" x 7-3/4"
 QT9093WH — 13-1/4 dia. x 7-1/2"

- Item too large to ship via UPS/FedEx. Item shipped common carrier at minimum rates.
- * All pricing reflects the individual item cost. You must order in multiples as indicated.
- ◆ UL listed for use over bathtubs and showers when connected to a GFCI protected branch circuit.

Ventilation Fans — Heater Combinations

NuTone® Heater Combinations

1300W heating provides optimum performance in smaller spaces. Attractive grille styling. Duct connector with damper fits 4" round duct. 7-7/8" x 14-5/8" x 5-5/8" high housing fits in 2" x 6" ceiling construction.

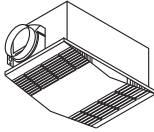

Model No.	Description	Std. Pk.	List Price	Code
605RP	70 CFM, 4.0 Sones, Exhaust fan with 1300W heater	1	\$216.56	LV
665RP	70 CFM, 4.0 Sones, Exhaust fan with 1300W heater and 100W incandescent light (bulb not included).	1	\$218.42	LV

NuTone® Bulb Heaters and Heater/Fans

Produce instant warmth with standard BR40/R40 size 250-watt infrared bulbs (not included). Attractive molded plastic grilles. Damper/duct connector fits 4" round duct (Models 9417DN and 9427P). Models 9412D and 9417DN grilles measure 10-1/4" x 10-1/4". Models 9422P and 9427P grilles measure 10-1/4" x 15-5/8". Housing sizes are noted below. Includes adjustable hanger bar system that spans up to 24". Fits in 2" x 8" ceiling construction.



Model No.	Description	Std. Pk.	List Price	Code
9412D	Single 250W Bulb Heat — Non IC	1	\$51.72	HV
9417DN	Single 250W Bulb Heat with 70 CFM, 4.0 Sones Exhaust Fan — Type IC, UL listed for 60°C wiring (retrofit)	1	\$107.80	HV
9422P	Double 250W Bulb Heat Lamp — Type IC	1	\$86.04	HV
9427P	Double 250W Bulb Heat with 70 CFM, 4.0 Sones Exhaust Fan — Type IC, UL listed for 60°C wiring (retrofit)	1	\$143.84	HV

Rough-in housing sizes: 9412D — 8-3/8" x 8-1/8" x 6"
 9417DN — 8-3/8" x 8-1/8" x 6-3/8"
 9422P — 8-3/8" x 14-1/4" x 6"
 9427P — 8-3/8" x 14-1/4" x 6-3/8"

Ventilation Fans — Utility

NuTone® — Vertical Discharge Fan



Model No.	Description	Std. Pk.	List Price	Code
8210	210 CFM, 6.5 Sones. 7" Round Vertical Discharge	1	\$169.88	HV

NuTone® — Side Discharge Fans

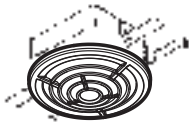

Model No.	Description	Std. Pk.	List Price	Code
8310	160 CFM, 5.0 Sones. 8" Round Side Discharge	1	\$208.24	HV

- Item too large to ship via UPS/FedEx. Item shipped common carrier at minimum rates.
- * All pricing reflects the individual item cost. You must order in multiples as indicated.
- ◆ UL listed for use over bathtubs and showers when connected to a GFCI protected branch circuit.

Ventilation Fans — ULTRA™

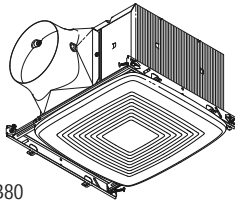

ZB80
ZB110

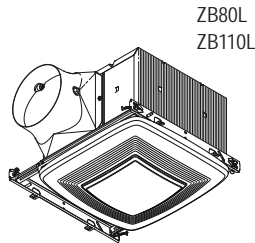

ZB80L
ZB110L

Broan® ULTRA™ Green Multi-Speed Series

We started with installation and worked back to build the ultimate bath fan. Unique telescoping mounting frame is ideal for both new construction and retrofit. No attic access needed! DC motor for efficiency. Multi-speed capability ideal for meeting ASHRAE 62.2, LEED, ENERGY STAR® for Homes and CA Title 24 — as well as local/spot ventilation needs. Powerful operation maintained over a wide range of real-world installations (CFM rating at 0.1" static pressure maintained through 0.25" static pressure). Fits in 2" x 8" ceiling construction. 10-1/2" L x 11-3/8" W x 7-5/8" H housing. 13" x 14" grille (fan) and 13" x 13-1/4" (fan/light/night light). All models have a 6" duct connector and the 50 CFM and 80 CFM models include a 6" to 4" reducer. All ULTRA 80 and 110 CFM fans can also be used with the MD6TU universal make-up air damper if 6" rigid duct is used. ULTRA non-sensing fans (not fan/lights) can also be used with the RDF1 radiation damper. Now with QStream sound technology that features airflow-smoothing baffles to reduce noise caused by turbulence (50 and 80 CFM models only).

Model No.	Description	Std. Pk.	List Price	Code
Fans				
ZB80	◆ 30 CFM to 80 CFM, <0.3 Sones, ENERGY STAR Fan	1	\$308.94	HP
ZB110	◆ 30 CFM to 110 CFM, <0.3 Sones, ENERGY STAR Fan	1	\$337.68	HP
Fan/Light/Night Light				
ZB80L	◆ 30 CFM to 80 CFM, <0.3 Sones, ENERGY STAR Fan with 36W Fluorescent Light (2-18 watt GU24 bulbs included) and 4W Night Light (bulb not included)	1	\$423.68	HP
ZB110L	◆ 30 CFM to 110 CFM, <0.3 Sones, ENERGY STAR Fan with 36W Fluorescent Light (2-18 watt GU24 bulbs included) and 4W Night Light (bulb not included)	1	\$454.76	HP



All models are ENERGY STAR certified products.

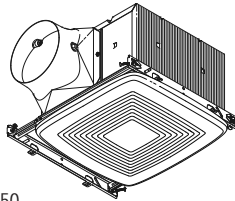

XB50
XB80
XB110

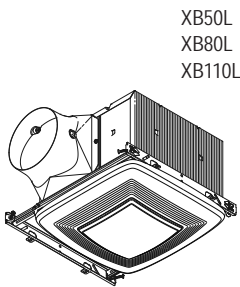

XB50L
XB80L
XB110L

Broan® ULTRA™ Green Single-Speed Series

We started with installation and worked back to build the ultimate bath fan. Unique telescoping mounting frame is ideal for both new construction and retrofit. No attic access needed! DC motor for efficiency. ASHRAE 62.2, LEED, ENERGY STAR® for Homes and CA Title 24 compliant. Powerful operation maintained over a wide range of real-world installations (CFM rating at 0.1" static pressure maintained through 0.25" static pressure). Fits in 2" x 8" ceiling construction. 10-1/2" L x 11-3/8" W x 7-5/8" H housing. 13" x 14" grille (fan) and 13" x 13-1/4" (fan/light/night light). All models have a 6" duct connector and the 50 CFM and 80 CFM models include a 6" to 4" reducer. All ULTRA 80 and 110 CFM fans can also be used with the MD6TU universal make-up air damper if 6" rigid duct is used. ULTRA non-sensing fans (not fan/lights) can also be used with the RDF1 radiation damper. Now with QStream sound technology that features airflow-smoothing baffles to reduce noise caused by turbulence (50 and 80 CFM models only).

Model No.	Description	Std. Pk.	List Price	Code
Fans				
XB50	◆ 50 CFM, <0.3 Sones, ENERGY STAR Fan	1	\$264.80	HP
XB80	◆ 80 CFM, <0.3 Sones, ENERGY STAR Fan	1	\$281.14	HP
XB110	◆ 110 CFM, <0.3 Sones, ENERGY STAR Fan	1	\$301.50	HP
Fan/Light/Night Light				
XB50L	◆ 50 CFM, <0.3 Sones, ENERGY STAR Fan with 36W Fluorescent Light (2-18 watt GU24 bulbs included) and 4W Night Light (bulb not included)	1	\$373.90	HP
XB80L	◆ 80 CFM, <0.3 Sones, ENERGY STAR Fan with 36W Fluorescent Light (2-18 watt GU24 bulbs included) and 4W Night Light (bulb not included)	1	\$403.14	HP
XB110L	◆ 110 CFM, <0.3 Sones, ENERGY STAR Fan with 36W Fluorescent Light (2-18 watt GU24 bulbs included) and 4W Night Light (bulb not included)	1	\$416.52	HP



All models are ENERGY STAR certified products.

- Item too large to ship via UPS/FedEx. Item shipped common carrier at minimum rates.
- * All pricing reflects the individual item cost. You must order in multiples as indicated.
- ◆ UL listed for use over bathtubs and showers when connected to a GFCI protected branch circuit.

Ventilation Fans — ULTRA™

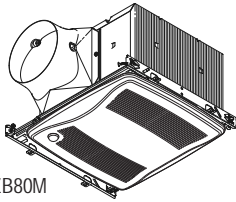

ZB80M
ZB110M

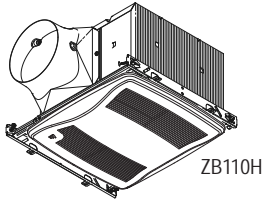

ZB110H

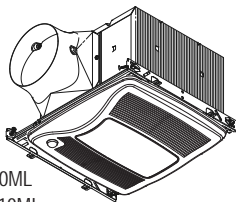

ZB80ML
ZB110ML

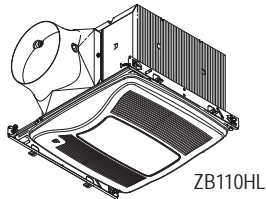

ZB110HL

Broan® ULTRA™ Green Multi-Speed Series — Sensing

We started with installation and worked back to build the ultimate bath fan. Unique telescoping mounting frame is ideal for both new construction and retrofit. No attic access needed! DC motor for efficiency. Multi-speed capability ideal for meeting ASHRAE 62.2, LEED, ENERGY STAR® for Homes and CA Title 24 — as well as local/spot ventilation needs. Humidity or motion sensing triggers fan to ramp up from lower continuous ventilation level to maximum CFM. Powerful operation maintained over a wide range of real-world installations (CFM rating at 0.1" static pressure maintained through 0.25" static pressure). Fits in 2" x 8" ceiling construction. 10-1/2" L x 11-3/8" W x 7-5/8" H housing. 13" x 14" grille (fan) and 13" x 13-1/4" (fan/light/night light). All models have a 6" duct connector and the 80 CFM models include a 6" to 4" reducer. All ULTRA 80 and 110 CFM fans can also be used with the MD6TU universal make-up air damper if 6" rigid duct is used. ULTRA non-sensing fans (not fan/lights) can also be used with the RDF1 radiation damper. Now with QStream sound technology that features airflow-smoothing baffles to reduce noise caused by turbulence (50 and 80 CFM models only).

Model No.	Description	Std. Pk.	List Price	Code
Fans				
ZB80M	◆ 80 CFM, <0.3 Sones, ENERGY STAR Motion Sensing Fan	1	\$356.76	HP
ZB110H	◆ 110 CFM, <0.3 Sones, ENERGY STAR Humidity Sensing Fan	1	\$448.82	HP
ZB110M	◆ 110 CFM, <0.3 Sones, ENERGY STAR Motion Sensing Fan	1	\$383.74	HP
Fan/Light/Night Light				
ZB80ML	◆ 80 CFM, <0.3 Sones, ENERGY STAR Motion Sensing Fan with 36W Fluorescent Light (2-18 watt GU24 bulbs included) and 4W Night Light (bulb not included)	1	\$478.38	HP
ZB110HL	◆ 110 CFM, <0.3 Sones, ENERGY STAR Humidity Sensing Fan with 36W Fluorescent Light (2-18 watt GU24 bulbs included) and 4W Night Light (bulb not included)	1	\$570.70	HP
ZB110ML	◆ 110 CFM, <0.3 Sones, ENERGY STAR Motion Sensing Fan with 36W Fluorescent Light (2-18 watt GU24 bulbs included) and 4W Night Light (bulb not included)	1	\$511.80	HP



All models are ENERGY STAR certified products.

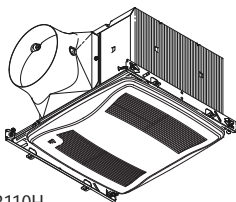

XB110H

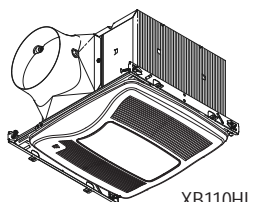

XB110HL

Broan® ULTRA™ Green Single-Speed Series — Sensing

We started with installation and worked back to build the ultimate bath fan. Unique telescoping mounting frame is ideal for both new construction and retrofit. No attic access needed! ASHRAE 62.2, LEED, ENERGY STAR® for Homes and CA Title 24 compliant. Humidity sensing models will automatically turn on when rapid rise in humidity is sensed. Powerful operation maintained over a wide range of real-world installations (CFM rating at 0.1" static pressure maintained through 0.25" static pressure). Fits in 2" x 8" ceiling construction. 10-1/2" L x 11-3/8" W x 7-5/8" H housing. 13" x 14" grille (fan) and 13" x 13-1/4" (fan/light/night light). All models have a 6" duct connector. All ULTRA 80 and 110 CFM fans can also be used with the MD6TU universal make-up air damper if 6" rigid duct is used. ULTRA non-sensing fans (not fan/lights) can also be used with the RDF1 radiation damper. Now with QStream sound technology that features airflow-smoothing baffles to reduce noise caused by turbulence (50 and 80 CFM models only).

Model No.	Description	Std. Pk.	List Price	Code
Fan				
XB110H	◆ 110 CFM, <0.3 Sones, ENERGY STAR Humidity Sensing Fan	1	\$404.48	HP
Fan/Light/Night Light				
XB110HL	◆ 110 CFM, <0.3 Sones, ENERGY STAR Humidity Sensing Fan with 36W Fluorescent Light (2-18 watt GU24 bulbs included) and 4W Night Light (bulb not included)	1	\$523.64	HP



All models are ENERGY STAR certified products.

- Item too large to ship via UPS/FedEx. Item shipped common carrier at minimum rates.
- * All pricing reflects the individual item cost. You must order in multiples as indicated.
- ◆ UL listed for use over bathtubs and showers when connected to a GFCI protected branch circuit.

Ventilation Fans — ULTRA™

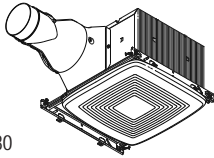

RB80
RB110

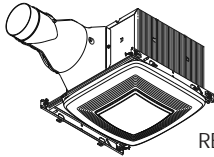

RB80L
RB110L

Broan® ULTRA™ Pro Fan and Fan/Light Series

The preferred install choice for professionals to deliver quiet performance *ULTRA*Quick™ installation, with no attic access required. QStream™ sound technology features airflow-smoothing baffles to reduce noise caused by turbulence and QFlow™ sound technology that removes the duct damper from the airstream to reduce static pressure. 4" duct for ideal retrofit installation and ENERGY STAR® qualified. 10-1/2" x 11-3/8" x 7-5/8" housing fits 2" x 8" ceiling construction. UL Listed for use over bathtubs and showers when connected to a GFCI protected branch circuit.

Model No.	Description	Std. Pk.	List Price	Code
Fans				
RB80	80 CFM, <0.3 Sones, ENERGY STAR Fan	1	\$262.06	HP
RB110	110 CFM, 0.6 Sones, ENERGY STAR Fan	1	\$290.68	HP
Fan/Light				
RB80L	80 CFM, <0.3 Sones, ENERGY STAR Fan/Light, two energy efficient 18W GU24 Fluorescent Lights (bulbs included)	1	\$383.00	HP
RB110L	110 CFM, 0.8 Sones, ENERGY STAR Fan/Light, two energy efficient 18W GU24 Fluorescent Lights (bulbs included)	1	\$408.46	HP



All models are ENERGY STAR certified products.

Ventilation Fans — QT Series™

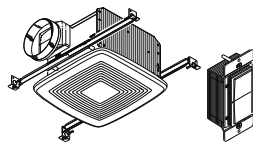

SSQTXE080
SSQTXE110

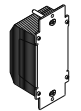

SMSCPLR

Broan SmartSense® Intelligent Ventilation System

The intelligent fan control system creates an integrated residential exhaust ventilation system using Broan's industry leading ventilation control technology and award winning QTXE fans. The Broan SmartSense system uses Broan's Link-Logic™ control technology powered by INSTEON™, a powerful communication technology to monitor everyday manual fan usage throughout the home. Broan SmartSense calculates additional ventilation required by Green Building and ASHRAE Standard 62 related requirements and automatically controls installed fans to achieve proper ventilation. SSQTXE080 and SSQTXE110 fans can provide a single fan solution for small apartments or mix and matched for a customized, integrated ventilation system.

Model No.	Description	Std. Pk.	List Price	Code
SSQTXE080	80 CFM SmartSense Fan with Control	1	\$287.06	HV
SSQTXE110	110 CFM SmartSense Fan with Control	1	\$318.84	HV
SMSCPLR †	SmartSense Phase Coupler	1	\$45.90	AR

† The SmartSense Phase Coupler is only required when fans are located on separate phases of power. If fans are on the same circuit or phase, the phase coupler is not necessary.

Broan® Ventilation Fan with Sensonic™ Speakers and Speaker Kit

Unlike wireless speakers that require counter space, Sensonic speakers with Bluetooth® wireless technology fill your room with rich sound from above. From hard rock to news talk, play any audio through the dual high-fidelity speakers and enjoy entertainment and privacy at the touch of a button. It's brilliant audio performance concealed behind the fan grille.

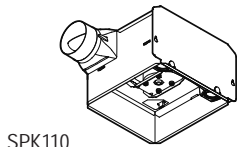

SPK110



SPKACC

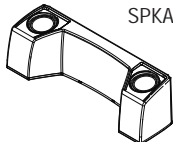

Model No.	Description	Std. Pk.	List Price	Code
SPK110	Sensonic Speaker Fan; 110 CFM, 1.0 Sones	1	\$394.84	HV
SPKACC	Sensonic Speaker Accessory	1	\$181.98	AC

- Item too large to ship via UPS/FedEx. Item shipped common carrier at minimum rates.
- * All pricing reflects the individual item cost. You must order in multiples as indicated.
- ◆ UL listed for use over bathtubs and showers when connected to a GFCI protected branch circuit.

Ventilation Fans — QT Series™

Broan® QT Series™ (QTXE Models)

The industry's quietest, most powerful and stylish fans with a 3 year warranty. 6" ducting for superior performance and ENERGY STAR certified. Includes hanger bar system for fast and flexible installations for all types of construction. Fits in 2" x 8" ceiling construction. 10-1/2" x 11-3/8" x 7-5/8" high housing. 14" x 15" grille (QTXE fans) and 13-3/8" x 14-1/4" grille (QTXE fan/lights).

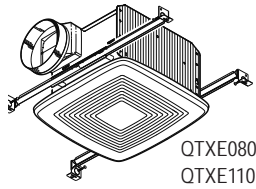

QTXE080
QTXE110

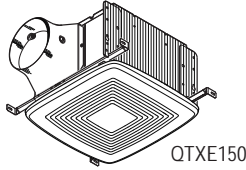

QTXE150

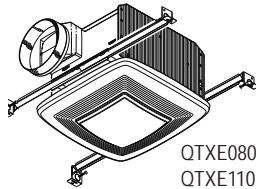

QTXE080FLT
QTXE110FLT

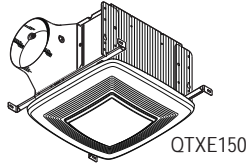

QTXE150FLT

Model No.	Description	Std. Pk.	List Price	Code
Fans				
QTXE080 ♦	80 CFM, 0.3 Sones, ENERGY STAR Fan	1	\$252.68	HV
QTXE110 ♦	110 CFM, 0.7 Sones, ENERGY STAR Fan	1	\$285.90	HV
QTXE150 ♦	150 CFM, 1.4 Sones, ENERGY STAR Fan	1	\$342.46	HV
Fan/Light/Night Light				
QTXE080FLT ♦	80 CFM, 0.3 Sones, ENERGY STAR Fan with 36W Fluorescent Light (2-18 watt GU24 bulbs included) and 4W Night Light (bulb not included)	1	\$372.34	HV
QTXE110FLT ♦	110 CFM, 0.7 Sones, ENERGY STAR Fan with 36W Fluorescent Light (2-18 watt GU24 bulbs included) and 4W Night Light (bulb not included)	1	\$412.22	HV
QTXE150FLT ♦	150 CFM, 1.4 Sones, ENERGY STAR Fan with 36W Fluorescent Light (2-18 watt GU24 bulbs included) and 4W Night Light (bulb not included)	1	\$482.08	HV



All models are ENERGY STAR certified products.

Broan® QT Series™ Humidity Sensing Fan and Fan/Light

Humidity sensing integrated in a ventilation fan is another industry exclusive! Featuring Sensaire® technology and models that are ENERGY STAR® certified, this Ultra Silent™ Humidity Sensing fan is the most effective way to control excess humidity and moisture, even in the most frequently used bathrooms. Homeowners and property managers will appreciate the fact that Broan's humidity sensing fan is automatic — once there is a rapid rise in humidity, the fan will automatically turn on to exhaust excess moisture and turn off once the job is done. The industry's quietest, most powerful and stylish fan with a 3 year warranty. 6" ducting for superior performance. Fits 2" x 8" ceiling construction. 10-1/2 x 11-3/8" x 7-5/8" high housing. 13" x 13-3/4" grille.

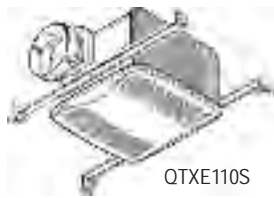

QTXE110S

Model No.	Description	Std. Pk.	List Price	Code
Fan				
QTXE110S ♦	110 CFM, 0.7 Sones, ENERGY STAR Humidity Sensing Fan	1	\$400.62	HV

Broan® InVent Series Sensing Ventilation Fans and Fan/Lights

Introducing the InVent Series humidity sensing fan and fan/light. Building on the innovative features of the InVent Series, the humidity sensing product line will utilize our patented Sensaire™ sense-on-rise technology. The sensor has a user adjustable sensitivity control that simultaneously adjusts the humidity rate-of-rise sensitivity and the humidity set point. In addition to the flexible installation, this humidity sensing product line features LED lighting.

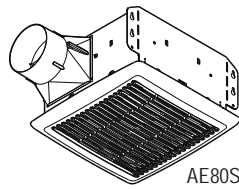

AE80S
AE110S

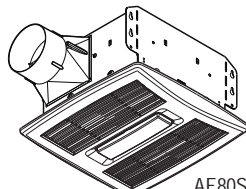

AE80SL
AE110SL

Model No.	Description	Std. Pk.	List Price	Code
Fan				
AE80S	80 CFM, 0.8 Sones, ENERGY STAR Sensing Fan	1	\$326.50	HM
AE110S	110 CFM, 1.0 Sones, ENERGY STAR Sensing Fan	1	\$353.98	HM
Fan/Light				
AE80SL	80 CFM, 0.8 Sones, ENERGY STAR Sensing Fan with LED Light	1	\$429.10	HM
AE110SL	110 CFM, 1.0 Sones, ENERGY STAR Sensing Fan with LED Light	1	\$489.30	HM
Housing Pack				
A000HFS	Sensing Fan Housing Pack — Fan Models Only (Compatible with AE80F and AE110F finish packs.)	4 *	\$103.34	HM

● Item too large to ship via UPS/FedEx. Item shipped common carrier at minimum rates.

* All pricing reflects the individual item cost. You must order in multiples as indicated.

◆ UL listed for use over bathtubs and showers when connected to a GFCI protected branch circuit.

Ventilation Fans — InVent™ Series

Broan® InVent™ Series Ventilation Fans

New, versatile housing platform that marks a revolution of our mid-range ventilation fans and allows for easy installation in both new construction and retrofit applications. 10" x 9-1/4" x 5-3/4" housing features foldable mounting ears for easy, room-side replacement. 4" duct connector mounts from the inside of the housing and features a new damper technology, improving air tightness scores.

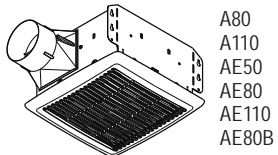

A80
A110
AE50
AE80
AE110
AE80B

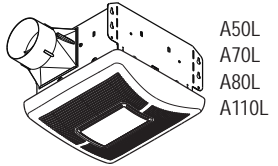

A50L
A70L
A80L
A110L

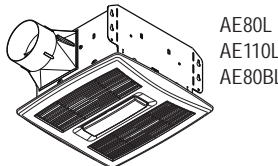

AE80L
AE110L
AE80BL

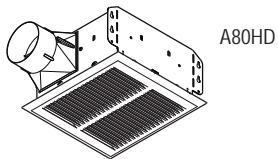

A80HD

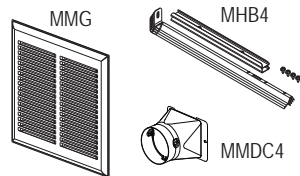

MMG

MHB4

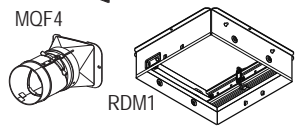

MQF4

MMDC4

RDM1

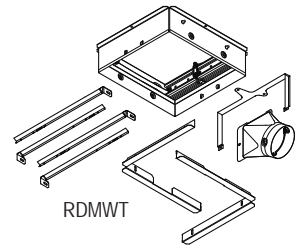

RDMWT

Model No.		Description	Std. Pk.	List Price	Code
Ventilation Fans					
A80	Ω	80 CFM, 2.0 Sones	1	\$150.00	HM
A110	Ω	110 CFM, 3.0 Sones	1	\$166.68	HM
A80HD	Ω	80 CFM, 2.0 Sones, Metal Grille	1	\$193.34	HM
AE50	Ω	50 CFM, 0.5 Sones, ENERGY STAR Fan	1	\$166.68	HM
AE80	Ω	80 CFM, 0.8 Sones, ENERGY STAR Fan	1	\$240.00	HM
AE110	Ω	110 CFM, 1.3 Sones, ENERGY STAR Fan	1	\$266.68	HM
AE80B	Ω	80 CFM, 1.5 Sones, ENERGY STAR Fan	1	\$116.68	HM
Ventilation Fan/Lights					
A50L		50 CFM, 1.5 Sones	1	\$145.00	HM
A70L		70 CFM, 2.0 Sones	1	\$146.68	HM
A80L		80 CFM, 1.0 Sones	1	\$350.00	HM
A110L		110 CFM, 1.3 Sones	1	\$383.34	HM
AE80BL	Ω	LED Light, 80 CFM, 1.5 Sones, ENERGY STAR Fan/Light	1	\$216.66	HM
AE80L	Ω	LED Light, 80 CFM, 0.8 Sones, ENERGY STAR Fan/Light	1	\$400.00	HM
AE110L	Ω	LED Light, 110 CFM, 1.3 Sones, ENERGY STAR Fan/Light	1	\$433.34	HM
Accessories					
MHB4		Hanger Bars	1	\$20.00	AC
MMDC4	■	Metal Duct Connector	1	\$25.00	AC
MMG		Metal Grille, White	1	\$43.34	AC
MQF4		QFlow Duct Connector	1	\$20.00	AC
RDM1		Radiation Damper	1	\$166.68	HM
RDMWT		Radiation Damper for UL wood truss assembly listings L521, L528, L546, L558, L562, L574, L576, L581, L583, L585, P522, P533, P538, P545 and P547. Available May, 2017.	1	\$166.68	HM

Ω Works with Model RDM1 and RDMWT radiation damper. Sensing models work with RDMTW only.



Select models are ENERGY STAR certified products— see product description.

■ Limited quantities available.

- Item too large to ship via UPS/FedEx. Item shipped common carrier at minimum rates.
- * All pricing reflects the individual item cost. You must order in multiples as indicated.
- ◆ UL listed for use over bathtubs and showers when connected to a GFCI protected branch circuit.

Ventilation Fans

Broan® Recessed Fan/Lights

Recessed lights are popular lighting solutions. But Broan took it a step further by incorporating powerful ventilation in the same design. Our new fan/lights disappear into the ceiling with other recessed lights, so they are practical decorating solutions for any room in the house. In the bath they control humidity, and in a utility room, kitchen or high-traffic family room they keep the air fresh and comfortable. 12-3/4" x 8-1/4" x 6-3/4" high housing. 7-3/8" round trim. Damper/duct connector fits 4" duct. Type IC. Fits in 2" x 8" ceiling construction.

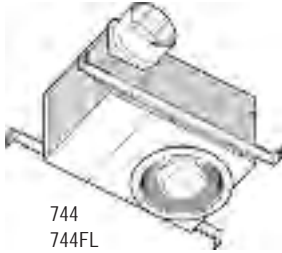

744
744FL
744LED
744SFL

Model No.	Description	Std. Pk.	List Price	Code
744	◆ Recessed Fan/Light, 70 CFM, 1.5 Sones. 6" white trim. Use 75W max R30 or BR30 bulb for standard applications.	1	\$171.96	NF
744FL	◆ Recessed Fan/Fluorescent Light, ENERGY STAR, 70 CFM, 1.5 Sones. 6" white trim. Uses 16W R30 fluorescent bulb (bulb included).	1	\$238.46	NF
744LED	◆ Recessed Fan/LED Light, ENERGY STAR, 70 CFM, 1.5 Sones. 6" white trim. Uses 10W BR30 LED bulb (bulb included).	1	\$307.98	NF
744SFL	◆ ENERGY STAR Recessed Humidity Sensing Fan/Fluorescent Light, 70 CFM, 1.5 Sones. 6" white trim. Uses 16W R30 fluorescent bulb (bulb included).	1	\$342.68	NF



Select models are ENERGY STAR certified products — see product description.

Broan® Ventilation Fan with Soft Surround™ LED Lighting Technology

Powerful, uniquely designed ventilation fan with LED light removes stale air and moisture from bathrooms. HVI certified at 110 CFM, 1.5 Sones. 9-1/4" x 10" x 5-3/4" housing. Damper/duct connector fits 4" round duct. Energy efficient 9 watt LED light is integrated into the unique, low profile grille. The perimeter lighting provides outstanding room coverage and the lens has quality diffusion that eliminates hot spots for a soft yet bright glow. Up to 25,000 hour life means the light may never have to be replaced.

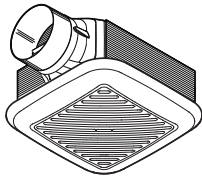

Model No.	Description	Std. Pk.	List Price	Code
791LEDM	ENERGY STAR Ventilation Fan with LED lighting, 110 CFM, 1.5 Sones. Uses 9W integrated LED module (included).	1	\$252.36	HM



ENERGY STAR certified products.

Broan® Decorative Fan/Light

Styling that takes decorative light/fans to the next level. Designs are attractive as lights alone and make no concessions to ventilation function. Styles cover a range of decorating tastes from antique to contemporary. All accept two 60-watt max incandescent bulbs (bulbs not included). Corrosion-resistant finishes. Plug-in light fixture assemblies. Plug-in permanently lubricated motors. 8" x 8-1/4" x 5-3/4" high housing. 4" round duct connectors. Type IC. Fits in 2" x 6" ceiling construction.

741SN



754RB

761BN
761RB
761WHA

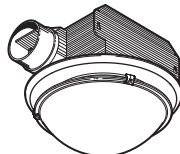

Model No.	Description	Std. Pk.	List Price	Code
741SN	Decorative Satin Nickel Fan/Light with frosted glass, 70 CFM, 3.5 Sones. 13-3/8" diameter base.	1	\$173.40	HV
754RB	Decorative Oil-Rubbed Bronze Fan/Light, white alabaster glass, 70 CFM, 3.5 Sones. 13-3/8" diameter base.	1	\$176.20	HV
761BN	Decorative Brushed Nickel Fan/Light, with opal glass, 80 CFM, 2.5 Sones. 13-1/4" diameter base.	1	\$189.40	HV
761RB	Decorative Oil-Rubbed Bronze Fan/Light, with ivory alabaster glass, 80 CFM, 2.5 Sones. 13-1/4" diameter base.	1	\$189.40	HV
761WHA	Decorative White Fan/Light, with white alabaster glass, 80 CFM, 2.5 Sones. 13-1/4" diameter base.	1	\$189.40	HV
MCB2	Mounting Channel/Brackets for single packs (2 channels, 4 brackets).	1	\$14.94	AC

- Item too large to ship via UPS/FedEx. Item shipped common carrier at minimum rates.
- * All pricing reflects the individual item cost. You must order in multiples as indicated.
- ◆ UL listed for use over bathtubs and showers when connected to a GFCI protected branch circuit.

Ventilation Fans

Broan® LoProfile™ Ventilation Fan

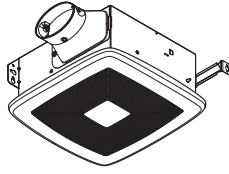

The new Broan LoProfile™ fan is our latest solution for installations where conventional ventilation simply won't fit. Where multi-family applications require it, the LoProfile™ fan is narrow enough to be installed in a wall between 2 x 4 studs. When plumbing or electrical obstructions are found behind the drywall in ceiling remodel applications our LoProfile™ fan can still fit without having to move anything. And that means most any room with space constraints can have powerful, quiet and efficient ventilation.

Model No.	Description	Std. Pk.	List Price	Code
Fan LP80	80 CFM, 1.0 Sones, ENERGY STAR Fan.	1	\$148.96	HV



ENERGY STAR certified products.

Broan® Heavy Duty™ Fan/Light



Heavy Duty™ fan/light was designed for continuous operation — perfect for tough, light-commercial applications. Motor has heavy duty, long-life bearings, tamper proof construction, and is totally enclosed for added protection against dirt and dust. Centrifugal blower wheel provides quiet, efficient ventilation. Convenient mounting ears speed installation. Fan/light unit has white molded 11-1/8" x 10-5/8" polymeric grille and shatter-resistant light lens. 8" x 8-1/4" x 5-3/4" high housing. Damper/duct connector fits 4" round duct. Type IC (Insulation Contact). Fits in 2" x 6" ceiling construction.

Model No.	Description	Std. Pk.	List Price	Code
HD80L ♦	Heavy Duty Fan/Light, 80 CFM, 2.5 Sones. 100W max Incandescent Light (bulb not included). Type IC.	1	\$154.68	HV
MCB2	Mounting Channel/Brackets for single packs (2 channels, 4 brackets).	1	\$14.94	AC

Broan® Radiation Damper Project Packs

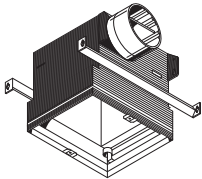

RDH

Model No.	Description	Std. Pk.	List Price	Code
RDH	Housing with radiation damper attached	4 *	\$138.76	HV
80RDF	80 CFM motor with metal grille finish pack	4 *	\$109.24	HV
110RDF	110 CFM motor with metal grille finish pack	4 *	\$114.96	HV
HD50RDF	Heavy duty 50 CFM motor with metal grille finish pack	4 *	\$120.88	HV

Broan® Metal Grille Kit — Selected Ventilation Fans



Everything you need to furnish a metal grille for most standard Broan exhaust fans. Spring-mounted hardware included.

Model No.	Description	Std. Pk.	List Price	Code
S97011308	White Metal Grille Kit, fits Models 670, 671, 688 & 689	1	\$45.60	PT

Broan® Fan/Lights

9" x 9" x 6" housing. Damper/duct connector fits 4" round duct. Bright 100-watt max light capacity. All models are Type IC. Bulbs not included. Fits in 2" x 6" ceiling construction.



750
751

Model No.	Description	Std. Pk.	List Price	Code
750 ♦	Fan/Light/Night Light, 100 CFM, 3.5 Sones, round white grille with glass lens	1	\$244.08	HV
751 ♦	Fan/Light, 100 CFM, 3.5 Sones, round white grille with glass lens	1	\$220.04	HV
MCB2	Mounting Channel/Brackets for single packs (2 channels, 4 brackets).	1	\$14.94	AC

- Item too large to ship via UPS/FedEx. Item shipped common carrier at minimum rates.
- * All pricing reflects the individual item cost. You must order in multiples as indicated.
- ♦ UL listed for use over bathtubs and showers when connected to a GFCI protected branch circuit.

Ventilation Fans

Broan® Economy Fans

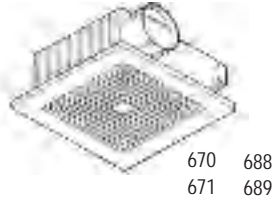

670 688
671 689

Molded plastic impeller, two-pole motor, 7-1/4" x 7-1/2" x 3-5/8" high galvanized steel housing for ceiling or wall installation. Spring mounted 9-1/4" x 9" plastic grille. Damper/duct connector fits 3" round duct. Snap-in motor plate requires no tools for installation or removal. Fits 2" x 4" ceiling or wall construction.

Model No.	Description	Std. Pk.	List Price	Code
670 ◆	Ventilation Fan, 50 CFM, 3.5 Sones	1	\$65.02	LV
671 ◆	Ventilation Fan, 70 CFM, 6.0 Sones	1	\$59.46	LV
688 ◆	Ventilation Fan, 50 CFM, 4.0 Sones	1	\$45.18	LV
689 ◆	Ventilation Fan, 60 CFM, 5.5 Sones	1	\$56.26	LV

All models available in project packs, see Page 76.

Broan® Economy Fan/Light



Compact unit provides ventilator and 100-watt light capacity in one unit (bulb not included). Molded 11-1/8" x 10-5/8" plastic grille and shatter-resistant lens. 8" x 8-1/4" x 5-3/4" high housing. Fits 4" round duct. Fits in 2" x 6" ceiling construction.

Model No.	Description	Std. Pk.	List Price	Code
678 ◆	50 CFM, 2.5 Sones Fan/Light. Type IC.	1	\$97.30	LV
MCB2	Mounting Channel/Brackets for single packs (2 channels, 4 brackets).	1	\$14.94	AC

All models available in project packs, see Page 76.

Broan® Bath Fan Upgrade Kit

The patented economy fan Bath Fan Upgrade Kit improves performance, reduces the sound level, and upgrades the appearance of your economy fan in 10 minutes. Provide easy upgrade for economy fan without replacing the entire housing, rewiring and reconnecting the duct. Helps ensure tenant/homeowner is using the fan when needed most. Reduces sound up to 50%, improves air movement up to 20% and helps control humidity that causes mold and mildew. Kit includes quiet fan motor, grille, wrench and two motor plates.

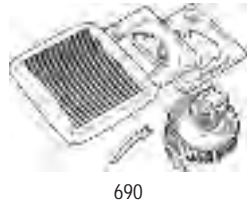

690

Model No.	Description	Std. Pk.	List Price	Code
690	60 CFM, 3.0 Sones, Economy Upgrade Kit	1	\$59.74	UK

The 690 Upgrade Kit replaces the models below.

Model No.	Housing Dimension
Broan: 670, 671, 688 & 689	7-1/2" x 7-1/4" only 8" x 8-1/4" are not compatible.
Nautilus: N671 & N688	
NuTone: 693, 695 & 696N	7-1/2" x 7-1/4" or 8" x 7-1/4"

Broan® Duct-Free Fan

No ductwork necessary! Ideal for powder rooms and closets. Type IC (Insulation Contact). Fits in 2" x 4" construction.

Model No.	Description	Std. Pk.	List Price	Code
682	Duct-free Fan with plastic grille. Includes long lasting, easy to replace activated charcoal filter. Easy snap-in mounting.	1	\$67.62	LV

- Item too large to ship via UPS/FedEx. Item shipped common carrier at minimum rates.
- * All pricing reflects the individual item cost. You must order in multiples as indicated.
- ◆ UL listed for use over bathtubs and showers when connected to a GFCI protected branch circuit.

Ventilation Fans — Project Packs

Broan® InVent™ Series Project Packs (Housing and Finish Packs)

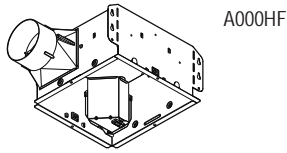

A000HF

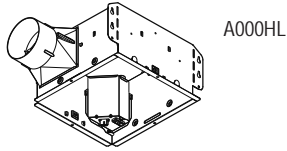

A000HL

Model No.	Description	Std. Pk.	List Price	Code
Housing Packs				
A000HF	Ventilation Fan Housing Pack	4 *	\$23.34	HM
A000HL	Ventilation Fan/Light Housing Pack	4 *	\$23.34	HM
Finish Packs				
A70LF	70 CFM, 2.0 Sones, Finish Pack	4 *	\$123.34	HM
A80F	Ω 80 CFM, 2.0 Sones, Finish Pack	4 *	\$126.68	HM
A80HDF	Ω 80 CFM, 2.0 Sones, Metal Grille, Finish Pack	4 *	\$170.00	HM
A110F	Ω 110 CFM, 3.0 Sones, Finish Pack	4 *	\$143.34	HM
AE50F	Ω 50 CFM, 0.5 Sones, ENERGY STAR Finish Pack	4 *	\$143.34	HM
AE80BF	Ω 80 CFM, 1.5 Sones, ENERGY STAR Finish Pack	4 *	\$93.34	HM
AE80BLF	Ω LED light, 80 CFM, 1.5 Sones, ENERGY STAR Finish Pack	4 *	\$193.32	HM
AE80F	Ω 80 CFM, 0.8 Sones, ENERGY STAR Finish Pack	4 *	\$216.68	HM
AE80LF	Ω LED light, 80 CFM, 0.8 Sones, ENERGY STAR Finish Pack	4 *	\$376.68	HM
AE110F	Ω 110 CFM, 1.3 Sones, ENERGY STAR Finish Pack	4 *	\$243.34	HM
AE110LF	Ω LED light, 110 CFM, 1.3 Sones, ENERGY STAR Finish Pack	4 *	\$337.84	HM

Ω Works with Model RDM1 and RDMWT radiation damper.



Select models are ENERGY STAR certified products — see product description.

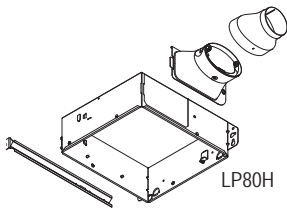

LP80H

LP80F

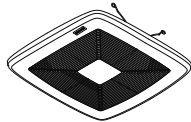
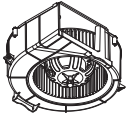

Broan® LoProfile™ Project Packs

The new Broan LoProfile™ fan is our latest solution for installations where conventional ventilation simply won't fit. Where multi-family applications require it, the LoProfile™ fan is narrow enough to be installed in a wall between 2 x 4 studs. When plumbing or electrical obstructions are found behind the drywall in ceiling remodel applications, our LoProfile™ fan can still fit without having to move anything. And that means most any room with space constraints can have powerful, quiet and efficient ventilation. Project Packs offer availability to buy housings for rough-in and motor/blower assemblies and grille later for finishing.

Model No.	Description	Std. Pk.	List Price	Code
LP80H	Housing Pack for LP80	4 *	\$28.04	HV
LP80F	ENERGY STAR Finish Pack. Motor and Grille Assembly. 80 CFM, 1.0 Sones.	4 *	\$120.92	HV



Select models are ENERGY STAR certified products — see product description.

- Item too large to ship via UPS/FedEx. Item shipped common carrier at minimum rates.
- * All pricing reflects the individual item cost. You must order in multiples as indicated.
- ◆ UL listed for use over bathtubs and showers when connected to a GFCI protected branch circuit.

Broan® Radiation Damper Accessory Kit

Model No.	Description	Std. Pk.	List Price	Code
RDFQF	Radiation damper accessory that works with Models QTRE080, QTRE080C2S, QTRE080R, QTRE110, QTXE050, QTXE080, QTXE110, SSQTXE110, SSQTXE80, QTR110F, QTRE110F, QTR080F and QTRE080F.	1	\$121.24	HV
RDFQL	Radiation damper accessory that works with Models QTRE080FLT, QTRE110FLT, QTXE110FLT, QTXE080FLT, QTXE110FLT, QTRE110FLT and QTRE080FLT. Also works with Models QTXE110S and QTXE110SFLT when used with RDJUMPQ accessory.	1	\$121.24	HV
RDFU	Radiation damper accessory that works with Models QTXE150, QTXE150FLT, RB80, RB110, XB50, XB80, XB110, ZB80 and ZB110. Also works with Models RB80L, RB110L, XB110HL, ZB110HL, ZB80ML, ZB110ML, XB50L, XB80L, XB110L, ZB80L, ZB110L, XB110H, ZB110H, ZB80M and ZB110M when used with RDJUMPU accessory.	1	\$121.24	HP
RDFUWT	Radiation damper accessory that works with Models QTXE150, QTXE150FLT, RB80, RB110, XB50, XB80, XB110, ZB80 and ZB110. Also works with Models RB80L, RB110L, XB110HL, ZB110HL, ZB80ML, ZB110ML, XB50L, XB80L, XB110L, ZB80L, ZB110L, XB110H, ZB110H, ZB80M and ZB110M when used with RDJUMPU accessory. For UL wood truss assembly listings L521, L528, L546, L558, L562, L574, L576, L581, L583, L585, P522, P533, P538, P545 and P547. Available May, 2017.	1	\$121.24	HP
RDJ1	Radiation damper accessory with metal grille and metal duct connector (no housing). Works with 770, 784, 676, 684, HD50 and HD80.	1	\$141.36	HV
RDF1	Radiation damper. Works with ULTRA® Series non-sensing fans (not fan/lights) and LP80.	1	\$121.24	HP
Accessories				
RDJUMPQ	Wiring jumper kit required for use with RDFQL when used with Models QTXE110S and QTXE110SFLT.	1	\$8.44	AC
RDJUMPU	Wiring jumper kit required for use with RDFU when used with Models XB110HL, ZB110HL, ZB80ML, ZB110ML, XB50L, XB80L, XB110L, ZB80L, ZB110L, XB110H, ZB110H, ZB80M and ZB110M.	1	\$16.90	AC
804QDD	■ 4" metal connector for use with QT models.	1	\$18.22	AC

■ Limited quantities available.

Broan® Fan and Combination Unit Project Packs

Broan's project packs offer a variety of housings packed and sold separately from motor assembly and grille. You can buy housings for rough-in ... buy assemblies and grilles later for finishing. Type IC.

Fan/Light Project Packs — Fits 2" x 6" Ceiling Construction

Model No.	Description	Std. Pk.	List Price	Code
2677H	Housing Pack for 2678F, 2679F, 2680F, FL2679F, FL2679FT, FL2680F and FL2680FT. Type IC. Mounting ears.	4 *	\$16.40	LV
3677H	Housing Pack. Same as 2677H, except includes built-in slide channels and mounting brackets.	4 *	\$21.04	LV
2678F	◆ Finish Pack. Motor, Reflector and Grille Assembly. 50 CFM, 2.5 Sones, 100W light. Uses 2677H or 3677H housing pack.	4 *	\$80.90	LV

● Item too large to ship via UPS/FedEx. Item shipped common carrier at minimum rates.

* All pricing reflects the individual item cost. You must order in multiples as indicated.

◆ UL listed for use over bathtubs and showers when connected to a GFCI protected branch circuit.

Ventilation Fans — Project Packs

Broan Economy Fan Project Packs — Fits 2" x 4" Ceiling or Wall Construction

Model No.	Description	Std. Pk.	List Price	Code
1667H	Housing Pack for 1670F, 1671F, 1688F and 1689F (damper/plastic duct connector included)	6 *	\$9.98	LV
1667HMTL	Housing Pack for 1670F, 1671F, 1688F and 1689F (damper/metal duct connector included)	6 *	\$23.66	LV
1670F	◆ Finish Pack. Motor Assembly and Grille. 50 CFM, 3.5 Sones.	6 *	\$55.04	LV
1671F	◆ Finish Pack. Motor Assembly and Grille. 70 CFM, 6.0 Sones.	6 *	\$49.48	LV
1688F	◆ Finish Pack. Motor Assembly and Grille. 50 CFM, 4.0 Sones.	6 *	\$35.20	LV
1689F	◆ Finish Pack. Motor Assembly and Grille, 60 CFM, 5.5 Sones	6 *	\$46.28	LV

Combination Unit Project Packs — Fits 2" x 6" Ceiling Construction

Model No.	Description	Std. Pk.	List Price	Code
654H	Housing Pack for 655F, 656F, 657F, 658F and 659F (damper/duct connector included). Type IC.	4 *	\$26.66	LV
655F	Finish Pack. Heater/Fan/Light Assembly and Grille. 70 CFM, 4.0 Sones, 100W light, 1300W heater. Uses 654H housing pack.	1	\$191.76	LV
656F	Finish Pack. Heater/Light Assembly and Grille. 100W light, 1300W heater. Uses 654H housing pack.	1	\$163.82	LV
657F	◆ Finish Pack. Fan/Light Assembly and Grille. 70 CFM, 4.0 Sones, 100W light. Uses 654H housing pack.	1	\$117.34	LV
658F	Finish Pack. Heater/Fan Assembly and Grille. 70 CFM, 4.0 Sones, 1300W heater. Uses 654H housing pack.	1	\$184.60	LV
659F	Finish Pack. Heater/Fan/Light Assembly and Grille. 50 CFM, 2.5 Sones, 100W light, 1300W heater. Uses 654H housing pack.	1	\$188.72	LV

Bulb Heater/Fan Project Packs — Fits 2" x 6" Ceiling Construction

Model No.	Description	Std. Pk.	List Price	Code
162H	■ Housing and Blower Assembly for 162F. Type IC.	4 *	\$87.08	HV
162F	■ Grille and Springs	4 *	\$20.72	HV

■ Limited quantities available.

- Item too large to ship via UPS/FedEx. Item shipped common carrier at minimum rates.
- * All pricing reflects the individual item cost. You must order in multiples as indicated.
- ◆ UL listed for use over bathtubs and showers when connected to a GFCI protected branch circuit.

Ventilation Fans — Remote In-Line

It's a pretty simple concept. Mount a high efficiency ventilator in an out-of-the-way location and get the exhaust needed with virtually no sound. Suitable for intermittent or continuous duty. Install the fan in the attic, basement, crawlspace or wherever is convenient. Energy efficient, permanently lubricated motors with high-pressure centrifugal blower wheels accommodate longer duct runs. Designed for quick, easy installation. Removable panels offer easy access to the motor without disturbing ductwork.

Broan® Single-Port Remote In-Line Ventilators

6" round inlet and outlet.



Model No.		Description	Std. Pk.	List Price	Code
SP100	+	Ventilator, 110 CFM, 1.0 Sone	1	\$285.40	HV
SP140	+	Ventilator, 150 CFM, 1.5 Sones	1	\$301.24	HV
SP200	+	Ventilator, 210 CFM, 2.0 Sones	1	\$317.08	HV
CVG4		4" Grille	1	\$35.38	AC
CVG6		6" Grille	1	\$47.56	AC

+ HVI rated airflow at 0.2" static pressure. These products were tested using sound test procedures similar to those used by HVI for other exhaust fans.

Broan® Multi-Port Remote In-Line Ventilators

Ventilate multiple rooms simultaneously. (1) 6" round outlet, (4) 4 round inlets and two inlet covers furnished.



MP100
MP140
MP200

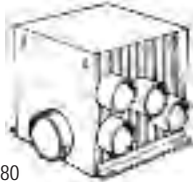

MP280

Model No.		Description	Std. Pk.	List Price	Code
MP100	+	Ventilator, 110 CFM, 1.0 Sone	1	\$317.08	HV
MP140	+	Ventilator, 150 CFM, 1.5 Sones	1	\$367.88	HV
MP200	+	Ventilator, 210 CFM, 2.0 Sones	1	\$437.82	HV
MP280	+	Ventilator, 290 CFM, 3.0 Sones	1	\$507.50	HV
CVG4		4" Grille	1	\$35.38	AC
CVG6		6" Grille	1	\$47.56	AC

+ HVI rated airflow at 0.2" static pressure. These products were tested using sound test procedures similar to those used by HVI for other exhaust fans.

- Item too large to ship via UPS/FedEx. Item shipped common carrier at minimum rates.
- * All pricing reflects the individual item cost. You must order in multiples as indicated.
- ◆ UL listed for use over bathtubs and showers when connected to a GFCI protected branch circuit.

Ventilation Fans — Heater Combinations

Broan® QT Series™ Heater/Fan/Light

Powerful heating, lighting and ventilation available at the touch of a switch. Quiet, high output 1500 watt heater with exclusive PowerHeat™ design. Requires a dedicated 20 amp circuit. 3 year warranty. 6" ducting for superior performance. 17-5/8" x 11-3/8" x 7-5/8" high housing with hanger bar system. 20" x 15" grille. Fits in 2" x 8" ceiling construction.



QTX110HL
QTX110HFLT



77DW
77DV

Model No.	Description	Std. Pk.	List Price	Code
QTX110HL	110 CFM, 0.9 Sones, Fan with 1500W heater, 2-60W max incandescent light and 7W night light (bulbs not included). Recommend 77 Series switch.	1	\$548.52	HV
QTX110HFLT	110 CFM, 0.9 Sones, Fan with 1500W heater, 2-18W high efficiency, GU24 based fluorescent light (bulbs included) and 7W night light (bulb included). Recommend 77 Series switch.	1	\$610.34	HV
77DW / 77DV	Three-Switch Control for use with sensing Fan/Lights (top switch provides three settings for sensor On/Auto/Off), remaining switches control light, night light and QT Heater/Fan/Light/Night Light (top switch controls light and night light, remaining switches control fan and heater).	1	\$44.60	AC

Broan® Directionally-Adjustable Heater with Fan and Light

These heaters feature 1500 watts of powerful, directionally-adjustable heat along with 100 CFM of ventilation at only 2.0 sones. They have 4" ducting and fit in 2" x 6" ceiling construction. Attractive grilles are 17-1/2" x 11-1/2" covering a 16" x 10-1/4" x 5-7/8" housing.

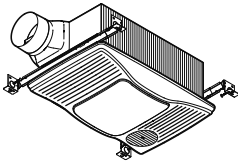

Model No.	Description	Std. Pk.	List Price	Code
100HL	Features 100W max incandescent lighting (bulb not included)	1	\$304.68	LV
100HFL	Features 27W fluorescent lighting (bulb included)	1	\$366.52	LV

Broan® Heater Combinations

Model 655 Heater/Fan/Light (featured) has a 1300-watt fan-forced heater and 70 CFM, 3.5 Sones ventilator, plus 100-watt light capacity in one compact unit (bulb not included). Two separate motors for heater and ventilator. Attractive 16-3/4" x 10-5/8" molded plastic grille and shatter-resistant lens. Built-in damper/duct connector fits 4" round duct. 14-1/4" x 8-1/4" x 5-3/4" high housing. Bulbs not included with any combination unit. All units are Type IC (Insulation Contact). Fits in 2" x 6" ceiling construction.



655 659
656 696
657



658

Model No.	Description	Std. Pk.	List Price	Code
655	Heater/Fan/Light, 70 CFM, 4.0 Sones	1	\$218.42	LV
656	Heater/Light; same as Model 655 but does not include fan	1	\$190.46	LV
657	◆ Fan/Light; same as Model 655 but does not include heater	1	\$144.00	LV
658	Heater/Fan; same as Model 655 but does not include light	1	\$211.26	LV
659	Heater/Fan/Light; same as Model 655 except 50 CFM, 2.5 Sones	1	\$215.38	LV
696	Fan/Light; same as Model 657 except 100 CFM, 4.5 Sones. Includes acoustic insulation.	1	\$197.84	LV

Select models available in project packs, see Page 75.

- Item too large to ship via UPS/FedEx. Item shipped common carrier at minimum rates.
- * All pricing reflects the individual item cost. You must order in multiples as indicated.
- ◆ UL listed for use over bathtubs and showers when connected to a GFCI protected branch circuit.

Ventilation Fans — Heater Combinations



Broan® Bulb Heaters and Heater/Fans

Produce instant warmth with standard BR40/R40 size 250-watt infrared bulbs (not included). Attractive molded plastic grilles. Damper/duct connector fits 4" round duct (Models 162 and 164). Models 161 and 162 grilles measure 10-1/4" x 10-1/4". Models 163 and 164 grilles measure 10-1/4" x 15-5/8". Housing sizes are noted below. Includes adjustable hanger bar system that spans up to 24". Fits 2" x 8" ceiling construction.

Model No.	Description	Std. Pk.	List Price	Code
161	Single 250W Bulb Heat — Not Type IC	1	\$51.72	HV
162	Single 250W Bulb Heat with 70 CFM, 4.0 Sones Exhaust Fan — Type IC, UL Listed for 60°C wiring (retrofit)	1	\$107.80	HV
163	Double 250W Bulb Heat Lamp — Type IC	1	\$86.04	HV
164	Double 250W Bulb Heat with 70 CFM, 4.0 Sones Exhaust Fan	1	\$143.84	HV

Select models available in project packs, see Page 75.

Rough-in housing sizes: 161 — 8-3/8" x 8-1/8" x 6"
 162 — 8-3/8" x 8-1/8" x 6-3/8"
 163 — 8-3/8" x 14-1/4" x 6"
 164 — 8-3/8" x 14-1/4" x 6-3/8"

Broan® Room-to-Room Fans

Install in interior walls to provide air flow of heated or cooled air from one room to another. Permanently lubricated motor. Models 510 and 511 have built-in switch for variable speed sound level selection. Models 510 and 511 adjust to fit walls from 3" to 5-1/2" thick.



Model No.	Description	Std. Pk.	List Price	Code
510	10" Fan, 380 CFM, 6.5 Sones. 13-1/2" square plastic grille.	1	\$208.34	HV
511	8" Fan, 180 CFM, 3.5 Sones. 13-1/2" square plastic grille.	1	\$166.92	HV
512	6" Fan with 8" Diameter Plastic Grille, 90 CFM, 3.5 Sones. Installs in interior walls up to 5-1/8" thick. Use with Model 57W/57V speed control or 69W/69V on/off switch (available separately).	1	\$73.74	HV

Broan® Through the Wall Fan

This versatile unit can be installed in outside walls from 5-1/4" to 10" thick. Exterior, white louvered, polymeric wall cap blends with any exterior wall covering. Includes white plastic interior grille, fan, flexible ducting and exterior louvered wall cap with birdscreen. Interior grille measures 8" round. Wall cap measures 8" square.



Model No.	Description	Std. Pk.	List Price	Code
512M	Through the Wall Ventilator, 70 CFM, 3.5 Sones	1	\$105.30	HV

- Item too large to ship via UPS/FedEx. Item shipped common carrier at minimum rates.
- * All pricing reflects the individual item cost. You must order in multiples as indicated.
- ◆ UL listed for use over bathtubs and showers when connected to a GFCI protected branch circuit.

Ventilation Fans — Utility

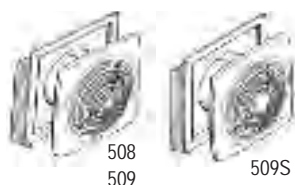

Broan® Direct Discharge Fans

Housing adjusts to fit walls 4-1/2" to 9-1/2" thick. Permanently lubricated motor with "twist-lock" installation; built-in backdraft damper.

Model No.	Description	Std. Pk.	List Price	Code
508	270 CFM, 10" Fan, 6.0 Sones, 13-1/2" square plastic grille	1	\$231.94	HV
509	180 CFM, 8" Fan, 6.5 Sones, 11-1/2" square plastic grille	1	\$154.34	HV
509S	8" Fan. Same as Model 509 (built-in on/off switch included).	1	\$163.20	HV



Broan® Chain-Operated Fans

Pull chain opens door and turns on fan – no wall switch to wire. Specially designed high performance fan blade. Housing adjusts to fit walls 4-1/2" to 9-1/2" thick.

Model No.	Description	Std. Pk.	List Price	Code
506	470 CFM, 10" Fan, 8.0 Sones, 13-1/2" square plastic grille	1	\$231.94	HV
507	250 CFM, 8" Fan, 7.0 Sones, 11-1/2" square plastic grille	1	\$188.64	HV



Broan® Vertical Discharge Fans

Quiet, efficient operation. Model 504 uses a 10" round duct or can be used with Model 472 reducer-damper (available separately) for 8" round duct. Housing is 10-1/4" x 7". Model 505 has a built-in backdraft damper, uses 8" round duct. Housing is 8-1/4" x 7".

Model No.	Description	Std. Pk.	List Price	Code
504	350 CFM, 10" Fan, 6.5 Sones, 13-1/2" square plastic grille	1	\$182.92	HV
505	180 CFM, 8" Fan, 5.5 Sones, 11-1/2" square plastic grille	1	\$131.38	HV
673	◆ Ventilation Fan, 60 CFM, 4.5 Sones	1	\$59.34	LV



Broan® Side Discharge Fans

Mounting brackets are adjustable to allow installation in walls or ceilings with studs or joists up to 24" on center. Requires 3-1/4" x 10" duct. Housing has built-in backdraft damper. Model 502 housing is 16-3/4" x 13-7/8". Model 503 housing is 14" x 12".

Model No.	Description	Std. Pk.	List Price	Code
502	270 CFM, 10" Fan, 8.0 Sones, 13-1/2" square plastic grille	1	\$232.20	HV
503	160 CFM, 8" Fan, 5.0 Sones, 11-1/2" square plastic grille	1	\$154.18	HV



Broan® Motordor® Wall Fan

The updated version of Broan's very first fan! Separate motor opens door when fan is turned on; closes door when turned off. 13-1/2" square grille. Housing is 11-1/2" square. Adjusts to fit walls from 5-1/2" to 9-7/8" thick.

Model No.	Description	Std. Pk.	List Price	Code
12C	360 CFM, 8" Fan, 8.0 Sones, 13-1/2" square plastic grille	1	\$466.80	HV

- Item too large to ship via UPS/FedEx. Item shipped common carrier at minimum rates.
- * All pricing reflects the individual item cost. You must order in multiples as indicated.
- ◆ UL listed for use over bathtubs and showers when connected to a GFCI protected branch circuit.

Ventilation Fans — Utility

Broan® Metal Grille Kits and Filters — Utility Fans

Everything you need to furnish a heavy duty metal grille for most Broan Utility Ventilators. All mounting hardware included.



Model No.	Description	Std. Pk.	List Price	Code
S97013825	White Painted Steel Metal Grille Kit for 10" fan units without switch hole	1	\$42.48	PT
S97013826	White Painted Steel Metal Grille Kit for 8" fan units without switch hole	1	\$35.46	PT
S97013827	White Painted Steel Metal Grille Kit for 10" fan units with switch hole	1	\$51.44	PT
S99010042	Washable Aluminum Filter for use with 8" utility ventilators	1	\$10.46	PT
S99010271	Washable Aluminum Filter for use with 10" utility ventilators	1	\$13.04	PT

Ventilation Fans — High Capacity

Broan® Ceiling Mount Ventilators — 100, 150, 200, 250 and 300 CFM

Incredibly Reliable – Unbelievably Quiet!® The quietest in the industry — Single, impact resistant centrifugal blower wheel driven by low RPM motor. 12-1/4" x 12-1/2" x 11-3/4" high housing. Low profile white polymeric grille (14" x 14") or sturdy, low profile metal grille finished with painted white enamel (14" x 14"). Built-in backdraft damper. Discharges horizontally or vertically through 6" or 8" round duct. Housings lined with acoustic insulation (except Model L300KMG). All ratings at 60 Hz.

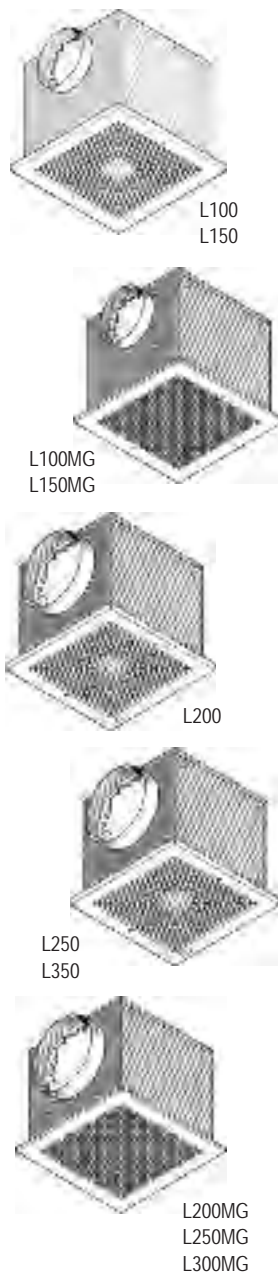

Model No.	Description *	Std. Pk.	List Price	Code
L100	Ventilator; 109 CFM Horizontal, 0.9 Sones; 112 CFM Vertical, 1.0 Sones. Polymeric grille. 6" rd. duct connector. 120V.	1	\$243.56	HV
L100MG	Ventilator; 115 CFM Horizontal/Vertical, 0.9 Sones. Metal grille. 6" rd. duct connector. 120V.	1	\$269.92	HV
L150	Ventilator; 157 CFM Horizontal, 1.5 Sones; 160 CFM Vertical, 1.6 Sones. Polymeric grille. 6" rd. duct connector. 120V.	1	\$251.76	HV
L150MG	Ventilator; 161 CFM Horizontal, 1.4 Sones; 162 CFM Vertical, 1.6 Sones. Metal grille. 6" rd. duct connector. 120V.	1	\$278.20	HV
L200	Ventilator; 210 CFM Horizontal, 1.7 Sones; 207 CFM Vertical, 2.0 Sones. Polymeric grille. 8" rd. duct connector. 120V.	1	\$277.48	HV
L200MG	Ventilator; 215 CFM Horizontal, 1.9 Sones; 209 CFM Vertical, 1.8 Sones. Metal grille. 8" rd. duct connector. 120V.	1	\$303.88	HV
L250	Ventilator; 259 CFM Horizontal, 2.2 Sones; 259 CFM Vertical, 2.7 Sones. Polymeric grille. 8" rd. duct connector. 120V.	1	\$293.92	HV
L250MG	Ventilator; 265 CFM Horizontal, 2.5 Sones; 262 CFM Vertical, 2.7 Sones. Metal grille. 8" rd. duct connector. 120V.	1	\$320.28	HV
L300	Ventilator; 308 CFM Horizontal, 2.9 Sones; 313 CFM Vertical, 3.0 Sones. Polymeric grille. 8" rd. duct connector. 120V.	1	\$300.28	HV
L300MG	Ventilator; 316 CFM Horizontal, 3.0 Sones; 314 CFM Vertical, 2.8 Sones. Metal grille. 8" rd. duct connector. 120V.	1	\$326.68	HV
L300KMG	▲ Ventilator; 277 CFM Horizontal, 3.1 Sones; 277 CFM Vertical, 3.7 Sones. Metal grille and blower wheel. 8" rd. duct connector. Suitable for kitchen installation. 120V.	1	\$346.68	HV

* AMCA licensed CFM/Sone ratings at 0.125" static pressure.

▲ Indicates product is suitable for kitchen installation.

- Item too large to ship via UPS/FedEx. Item shipped common carrier at minimum rates.
- * All pricing reflects the individual item cost. You must order in multiples as indicated.
- ◆ UL listed for use over bathtubs and showers when connected to a GFCI protected branch circuit.

Ventilation Fans — High Capacity

Broan® Ceiling Mount Ventilators — 400, 500 and 700 CFM

Two impact resistant centrifugal blower wheels driven by low RPM motor (kitchen units have metal wheels). 21-1/2" x 21-1/4" x 11-3/4" high housing. Sturdy, low profile metal grille finished with painted white enamel (20" x 14"). Discharges horizontally or vertically through 4-1/2" x 18-1/2" duct connector. Housings lined with acoustic insulation (except kitchen models). All ratings at 60 Hz.



Model No.	Description *	Std. Pk.	List Price	Code
L400	Ventilator; 434 CFM Horizontal, 2.3 Sones; 416 CFM Vertical, 2.6 Sones. 120V.	1	\$406.90	HV
L400K ▲	Ventilator; 406 CFM Horizontal, 3.3 Sones; 399 CFM Vertical, 3.3 Sones. Metal wheels. 120V.	1	\$442.58	HV
L500	Ventilator; 514 CFM Horizontal, 3.3 Sones; 512 CFM Vertical, 3.2 Sones. 120V.	1	\$492.50	HV
L500K ▲	Ventilator; 481 CFM Horizontal, 4.4 Sones; 473 CFM Vertical, 4.0 Sones. Metal wheels. 120V.	1	\$528.14	HV
L700	Ventilator; 701 CFM Horizontal, 4.7 Sones; 687 CFM Vertical; 5.0 Sones. 120V.	1	\$578.10	HV
423	Duct Transition — 4-1/2" x 18-1/2" to 10" rd. for 400, 500 & 700 CFM models	1	\$70.56	AC

* AMCA licensed CFM/Sone ratings at 0.125" static pressure.

▲ Indicates product is suitable for kitchen installation.

Broan® Ceiling Mount Ventilators — 900 and 1500 CFM

Single, impact resistant centrifugal blower wheel driven by low RPM motor. 22" x 18" x 18" high housing. Sturdy, low profile metal grille finished with painted white enamel (23-7/8" x 19-7/8"). Discharges horizontally or vertically through 8" x 12" duct connector. Housings lined with acoustic insulation. All ratings at 60 Hz.

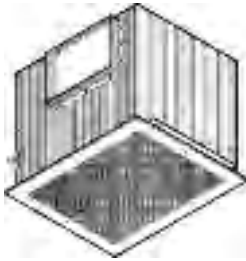

Model No.	Description *	Std. Pk.	List Price	Code
L900	Ventilator; 901 CFM Horizontal, 4.1 Sones; 885 CFM Vertical, 3.4 Sones. 120V.	1	\$730.16	HV
L1500	Ventilator; 1513 CFM Horizontal, 8.4 Sones; 1502 CFM Vertical, 8.4 Sones. 120V.	1	\$815.80	HV
T81212	Duct Transition — 8" x 12" to 12" rd. for 900 & 1500 CFM models	1	\$71.60	AC

* AMCA licensed CFM/Sone ratings at 0.125" static pressure.

- Item too large to ship via UPS/FedEx. Item shipped common carrier at minimum rates.
- * All pricing reflects the individual item cost. You must order in multiples as indicated.
- ◆ UL listed for use over bathtubs and showers when connected to a GFCI protected branch circuit.

Ventilation Fans — High Capacity

Broan® In-Line Ventilators — 100, 150, 200, 250 and 300 CFM

Single impact resistant centrifugal blower wheel driven by low RPM motor. 12-1/4" x 12-1/2" x 11-3/4" high housing. Removable access panel. No insulation inside housing.

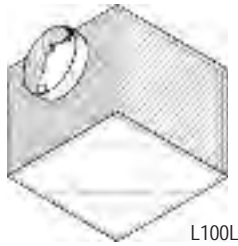

L100L

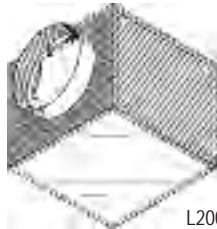

L200L

Model No.	Description *	Std. Pk.	List Price	Code
L100L ▲	Ventilator; 106 CFM Straight Through, 0.7 Sones; 95 CFM Right Angle, 0.3 Sones. 6" rd. duct connectors. 120V.	1	\$262.80	HV
L150L ▲	Ventilator; 147 CFM Straight Through, 1.1 Sones; 142 CFM Right Angle, 1.3 Sones. 6" rd. duct connectors. 120V.	1	\$271.08	HV
L200L ▲	Ventilator; 195 CFM Straight Through, 1.9 Sones; 183 CFM Right Angle, 1.0 Sones. 8" rd. duct connectors. 120V.	1	\$297.30	HV
L250L ▲	Ventilator; 245 CFM Straight Through, 2.3 Sones; 238 CFM Right Angle, 1.7 Sones. 8" rd. duct connectors. 120V.	1	\$313.70	HV
L300L ▲	Ventilator; 293 CFM Straight Through, 3.1 Sones; 283 CFM Right Angle, 2.4 Sones. 8" rd. duct connectors. 120V.	1	\$320.12	HV

* AMCA licensed CFM/Sone ratings at 0.125" static pressure.

▲ Indicates product is suitable for kitchen installation.

Broan® In-Line Ventilators — 400, 500 and 700 CFM

Two impact resistant centrifugal blower wheels driven by low RPM motor. 21-1/2" x 21-1/4" x 11-3/4" high housing. Two 4-1/2" x 18-1/2" duct connectors. Removable access panel.



Model No.	Description *	Std. Pk.	List Price	Code
L400L	Ventilator; 406 CFM Straight Through, 1.6 Sones; 391 CFM Right Angle, 1.2 Sones. 120V.	1	\$437.22	HV
L400KL ▲	Ventilator; 375 CFM Straight Through, 3.1 Sones; 380 CFM Right Angle, 2.0 Sones. 120V.	1	\$472.96	HV
L500L	Ventilator; 519 CFM Straight Through/Right Angle, 3.4 Sones. 120V.	1	\$522.86	HV
L500KL ▲	Ventilator; 472 CFM Straight Through, 3.8 Sones; 459 CFM Right Angle, 1.8 Sones. 120V.	1	\$558.54	HV
L700L	Ventilator; 681 CFM Straight Through, 3.7 Sones; 629 CFM Right Angle, 2.7 Sones. 120V.	1	\$608.44	HV
423	Duct Transition — 4-1/2" x 18-1/2" to 10" rd. for 400, 500 & 700 CFM models	1	\$70.56	AC

* AMCA licensed CFM/Sone ratings at 0.125" static pressure.

▲ Indicates product is suitable for kitchen installation.

Broan® In-Line Ventilators — 900 and 1500

Single impact resistant centrifugal blower wheel driven by low RPM motor. 22" x 18" x 18" high housing. Two 8" x 12" duct connectors. Removable access panel.



Model No.	Description *	Std. Pk.	List Price	Code
L900L	Ventilator; 894 CFM Straight Through, 3.8 Sones; 858 CFM Right Angle, 3.4 Sones. 120V.	1	\$766.00	HV
L1500L	Ventilator; 1214 CFM Straight Through, 6.7 Sones; 1076 CFM Right Angle, 3.5 Sones. 120V.	1	\$851.58	HV
T81212	Duct Transition — 8" x 12" to 12" rd. for 900 & 1500 CFM models	1	\$71.60	AC

* AMCA licensed CFM/Sone ratings at 0.125" static pressure.

- Item too large to ship via UPS/FedEx. Item shipped common carrier at minimum rates.
- * All pricing reflects the individual item cost. You must order in multiples as indicated.
- ◆ UL listed for use over bathtubs and showers when connected to a GFCI protected branch circuit.

Ventilation Fans — High Capacity

Broan® Cabinet Ventilators — 2000 and 3500 CFM

Twin, double inlet metal blower wheels 8" x 7-7/8". Fits 7-3/4" x 33-3/4" duct. Ratings at 60 Hz.

Model No.	Description *	Std. Pk.	List Price	Code
L2000L	Ventilator; 1791 CFM Straight Through, 9.4 Sones; 1898 CFM Right Angle, 10.1 Sones. 120V.	1	\$1,221.78	HV
L3500EXL	Ventilator; 3452 CFM Straight Through, 14.5 Sones; 3696 CFM Right Angle, 14.2 Sones. 240V	1	\$1,691.26	HV

* AMCA licensed CFM/Sone ratings at 0.125" static pressure.

Broan® Accessories for High Capacity Ventilation Fans

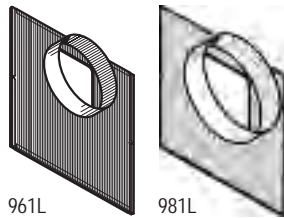

961L

981L

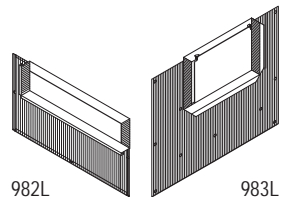

982L

983L



LAF1



LAF2



RD1

RD2

RD3



MG1

Model No.	Description	Std. Pk.	List Price	Code
80L	Variable Speed Control — 3.0 Amp, 120 Volts, 60 Hz (may be used with select models).	1	\$50.98	AC
277V	Electronic Variable Speed Control, 277V, 6A — Ivory. For models with "C" suffix.	1	\$91.60	AC
423	Duct Transition — 4-1/2" x 18-1/2" to 10" rd. for 400, 500 & 700 CFM models	1	\$70.56	AC
961L	In-line Adapter Kit, 6" rd. for 100 & 150 CFM ceiling mount models	1	\$31.28	AC
981L	In-line Adapter Kit, 8" rd. for 200, 250 & 300 CFM ceiling mount models	1	\$31.28	AC
982L	In-line Adapter Kit, 4-1/2" x 18-1/2" for 400, 500 & 700 CFM ceiling mount models	1	\$39.80	AC
983L	In-line Adapter Kit, 8" x 12" for 900 & 1500 CFM ceiling mount models	1	\$42.64	AC
D100	■ Damper Kit for Model L2000L Ventilator. Twin damper flaps and mounting hardware.	1	\$31.82	AC
D101	Damper Kit for Model L3500EXL Ventilator. Twin damper flaps and mounting hardware.	1	\$33.46	AC
G102	Grille Kit for Model L2000L Ventilator. White enameled steel grille measures 16-1/4" x 39-5/8".	1	\$149.58	AC
G103	Grille Kit for Model L3500EXL Ventilator. White enameled steel grille measures 18-3/8" x 47-1/4".	1	\$192.74	AC
LAF1	Grease Filter for use with metal grilles — Models L100, L150, L200, L250 and L300 Series.	1	\$15.40	AC
LAF2	Grease Filter for Models L400K & L500K	1	\$26.56	AC
MG1	Metal Grille Kit for 100, 150, 200, 250 & 300 CFM ceiling mount models	1	\$36.96	AC
RD1	Ceiling Radiation/Fire Damper for 100, 150, 200, 250 & 300 CFM ceiling mount models. UL rated 3 hours.	1	\$171.06	AC
RD2	Ceiling Radiation/Fire Damper for 400, 500 & 700 CFM ceiling mount models. UL rated 3 hours.	1	\$182.48	AC
RD3	Ceiling Radiation/Fire Damper for 900 & 1500 CFM ceiling mount models. UL rated 3 hours.	1	\$228.14	AC
T81212	Duct Transition, 8" x 12" to 12" rd. for 900 & 1500 CFM models	1	\$71.60	AC
V104	Vibration Dampening Hangers. Fits both Models L2000L and L3500EXL ventilators. Set of four required.	4 *	\$23.88	AC

■ Limited quantities available.

● Item too large to ship via UPS/FedEx. Item shipped common carrier at minimum rates.

* All pricing reflects the individual item cost. You must order in multiples as indicated.

◆ UL listed for use over bathtubs and showers when connected to a GFCI protected branch circuit.

Whole House Mechanical Ventilation

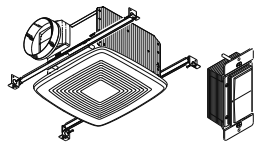

SSQTXE080
SSQTXE110

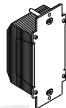

SMSCPLR



SMD6
SMD8

Broan SmartSense® Intelligent Ventilation System

The intelligent fan control system creates an integrated residential exhaust ventilation system using Broan's industry leading ventilation control technology and award winning QTXE fans. The Broan SmartSense system uses Broan's Link-Logic™ control technology powered by INSTEON™, a powerful communication technology to monitor everyday manual fan usage throughout the home. Broan SmartSense calculates additional ventilation required by Green Building and ASHRAE Standard 62 related requirements and automatically controls installed fans to achieve proper ventilation. SSQTXE080 and SSQTXE110 fans can provide a single fan solution for small apartments or mix and matched for a customized, integrated ventilation system.

Model No.	Description	Std. Pk.	List Price	Code
SSQTXE080	80 CFM SmartSense Fan with Control	1	\$287.06	HV
SSQTXE110	110 CFM SmartSense Fan with Control	1	\$318.84	HV
SMSCPLR	+ SmartSense Phase Coupler	1	\$45.90	AR
SMD6	6" LinkLogic automatic make-up air damper	1	\$281.36	HA
SMD8	8" LinkLogic automatic make-up air damper	1	\$296.16	HA

† The SmartSense Phase Coupler is only required when fans are located on separate phases of power. If fans are on the same circuit or phase, the phase coupler is not necessary.

Broan® Fresh Air Systems

The key to maintaining good indoor air quality and controlling excess moisture is to simultaneously introduce fresh air from outside while expelling stale air from inside. All without compromising your home's energy-efficiency or comfort. That's precisely what Broan's indoor air quality units do. With unparalleled performances, easy maintenance and reliability, the I.A.Q. line offers solutions to every budget and application, from residential to light-commercial.



AE60

Model No.	Description	Std. Pk.	List Price	Code
AE60	Air Exchanger, 160 – 185 CFM	1	\$809.40	AQ
B12LCDARNW	Light Commercial Heat Recovery Ventilator, recirculation defrost, aluminum core, reverse door, normal low speed, white pre paint	1	\$7,585.16	AQ
B12LCDASNW	Light Commercial Heat Recovery Ventilator, recirculation defrost, aluminum core, standard door, normal low speed, white pre paint	1	\$7,585.16	AQ
B12LCDPRNC	Light Commercial Heat Recovery Ventilator, recirculation defrost polypropylene core, reverse door, normal low speed, corrosion resistant	1	\$7,973.92	AQ
B12LCDPRNW	Light Commercial Heat Recovery Ventilator, recirculation defrost, polypropylene core, reverse door, normal low speed, white pre paint	1	\$6,880.80	AQ
B12LCDPSNC	Light Commercial Heat Recovery Ventilator, recirculation defrost, polypropylene core, standard door, normal low speed, corrosion resistant	1	\$7,973.92	AQ
B12LCDPSNW	Light Commercial Heat Recovery Ventilator, recirculation defrost, polypropylene core, standard door, normal low speed, white pre paint	1	\$6,880.80	AQ
B12LCEARNW	Light Commercial Heat Recovery Ventilator, exhaust only, aluminum core, reverse door, normal low speed, white pre paint	1	\$7,131.32	AQ
B12LCEASNW	Light Commercial Heat Recovery Ventilator, exhaust only, aluminum core, standard door, normal low speed, white pre paint	1	\$7,131.32	AQ
B12LCEPRNC	Light Commercial Heat Recovery Ventilator, exhaust only, polypropylene core, reverse door, normal low speed, corrosion resistant	1	\$7,520.08	AQ
B12LCEPRNW	Light Commercial Heat Recovery Ventilator, exhaust only, polypropylene core, reverse door, normal low speed, white pre paint	1	\$6,426.96	AQ
B12LCEPSNC	Light Commercial Heat Recovery Ventilator, exhaust only, polypropylene core, standard door, normal low speed, corrosion resistant	1	\$7,520.08	AQ
B12LCEPSNW	Light Commercial Heat Recovery Ventilator, exhaust only, polypropylene core, standard door, normal low speed, white pre paint	1	\$6,426.96	AQ
B6LCDARN	Light Commercial Heat Recovery Ventilator, recirculation defrost, aluminum core, reverse door, normal low speed	1	\$6,285.44	AQ
B6LCDASN	Light Commercial Heat Recovery Ventilator, recirculation defrost, aluminum core, standard door, normal low speed	1	\$6,285.44	AQ



Select models are ENERGY STAR certified products — see product description.

- Item too large to ship via UPS/FedEx. Item shipped common carrier at minimum rates.
- * All pricing reflects the individual item cost. You must order in multiples as indicated.
- ◆ UL listed for use over bathtubs and showers when connected to a GFCI protected branch circuit.

Whole House Mechanical Ventilation

Broan® Fresh Air Systems CONTINUED



ERVH100S
HRVH100SE

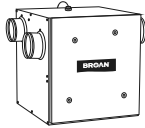

ERV70S



ERV70T



ERV140TE
HRV150TE

Model No.	Description	Std. Pk.	List Price	Code
B6LCDPRN	Light Commercial Heat Recovery Ventilator, recirculation defrost, polypropylene core, reverse door, normal low speed	1	\$5,846.24	AQ
B6LCDPSN	Light Commercial Heat Recovery Ventilator, recirculation defrost, polypropylene core, standard door, normal low speed	1	\$5,846.24	AQ
B6LCEARN	Light Commercial Heat Recovery Ventilator, exhaust only, aluminum core, reverse door, normal low speed	1	\$5,021.52	AQ
B6LCEASN	Light Commercial Heat Recovery Ventilator, exhaust only, aluminum core, standard door, normal low speed	1	\$5,021.52	AQ
B6LCEPRN	Light Commercial Heat Recovery Ventilator, exhaust only, polypropylene core, reverse door, normal low speed	1	\$4,582.32	AQ
B6LCEPSN	Light Commercial Heat Recovery Ventilator, exhaust only, polypropylene core, standard door, normal low speed	1	\$4,582.32	AQ
ERV70S	Energy Recovery Ventilator, 70 CFM max, side ports	1	\$1,246.76	AQ
ERV70T	Energy Recovery Ventilator, 70 CFM max, top ports	1	\$1,246.76	AQ
ERV100S	Sky Energy Recovery Ventilator, 100 CFM, side port	1	\$1,371.56	AQ
ERV100SP	Sky Energy Recovery Ventilator, 100 CFM, plus side port	1	\$1,496.36	AQ
ERV110S	Flex Heat Recovery Ventilator, 110 CFM, side port	1	\$1,366.56	AQ
ERV110T	Flex Heat Recovery Ventilator, 110 CFM, top port	1	\$1,366.56	AQ
ERV120S	Flex Energy Recovery Ventilator, 120 CFM, side port	1	\$1,433.96	AQ
ERV120T	Flex Energy Recovery Ventilator, 120 CFM, top port	1	\$1,433.96	AQ
ERV140TE	Energy Recovery Ventilator, 140 CFM max, top ports, ENERGY STAR certified.	1	\$2,494.76	AQ
ERV180S	Advance Energy Recovery Ventilator, 180 CFM, side port	1	\$1,870.76	AQ
ERV200TE	HE Energy Recovery Ventilator, 200 CFM, ECM, top port	1	\$3,549.86	AQ
ERV250TE	HE Energy Recovery Ventilator, 250 CFM, ECM, top port	1	\$2,995.20	AQ
ERVH100S	Energy Recovery Ventilator, 100 CFM max, side ports, ENERGY STAR certified.	1	\$1,995.56	AQ
ERVS100S	Sky Energy Recovery Ventilator, 100 Humidity Sensing, side port	1	\$1,064.00	AQ
HRV80S	Flex Heat Recovery Ventilator, 80 CFM, side port	1	\$1,026.34	AQ
HRV80T	Flex Heat Recovery Ventilator, 80 CFM, top port	1	\$1,026.34	AQ
HRV90S	Flex Heat Recovery Ventilator, 90 CFM, side port	1	\$1,154.40	AQ
HRV90T	Flex Heat Recovery Ventilator, 90 CFM, top port	1	\$1,154.40	AQ
HRV120S	Flex Heat Recovery Ventilator, 120 CFM, side port	1	\$1,246.76	AQ
HRV120T	Flex Heat Recovery Ventilator, 120 CFM, top port	1	\$1,246.76	AQ
HRV150S	Advance Heat Recovery Ventilator, 150 CFM, side port	1	\$1,616.16	AQ
HRV150TE	Heat Recovery Ventilator, 156 CFM max, top ports, ENERGY STAR certified.	1	\$1,643.12	AQ
HRV160T	Advance Heat Recovery Ventilator, 160 CFM, top port	1	\$1,553.76	AQ
HRV160TE	HE Heat Recovery Ventilator, 160 CFM, ECM, top port	1	\$1,870.76	AQ
HRV190S	Advance Heat Recovery Ventilator, 190 CFM	1	\$1,870.76	AQ
HRV200TE	HE Heat Recovery Ventilator, 200 CFM, ECM, top port	1	\$2,745.60	AQ
HRV250TE	HE Heat Recovery Ventilator, 250 CFM, DCM, top port	1	\$2,884.28	AQ
HRVH100S	Advance Heat Recovery Ventilator, HEPA, 100 CFM, side port	1	\$1,496.36	AQ
HRVH100SE	Heat Recovery Ventilator, 104 CFM max, side ports, ENERGY STAR certified.	1	\$1,773.82	AQ

■ Limited quantities available.



Select models are ENERGY STAR certified products — see product description.

- Item too large to ship via UPS/FedEx. Item shipped common carrier at minimum rates.
- * All pricing reflects the individual item cost. You must order in multiples as indicated.
- ◆ UL listed for use over bathtubs and showers when connected to a GFCI protected branch circuit.

Whole House Mechanical Ventilation

Broan® Fresh Air System Accessories

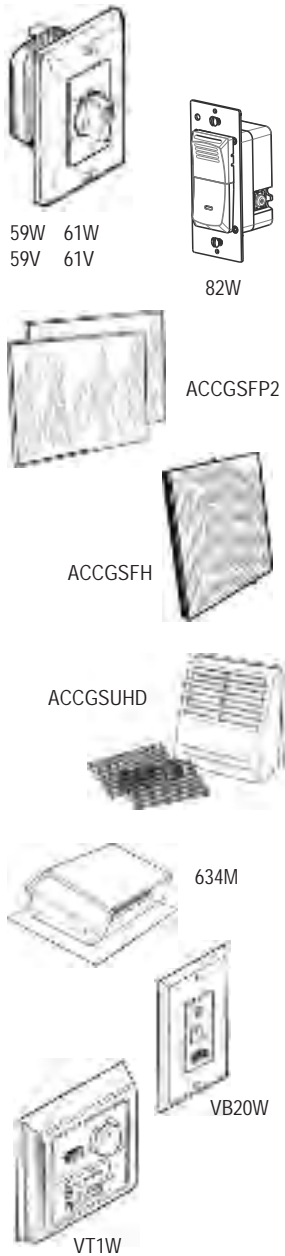

Model No.	Description	Std. Pk.	List Price	Code
59V / 59W	60 Minute Time Control, with "continuous on" feature. Fits single gang box.	1	\$60.34	AC
61V / 61W	15 Minute Time Control, no "continuous on" feature. Fits single gang box.	1	\$60.34	AC
82W	Premium Humidity Control with Sensaire technology that senses rapid rise in humidity. Also includes duty cycle timer. Fits in single gang box. (White)	1	\$101.30	AC
634M	Steel Roof Cap for 6" round duct. Includes damper and birdscreen. Black.	1	\$60.34	AC
641	Aluminum Wall Cap for 6" round duct (includes damper and birdscreen). Natural finish.	1	\$71.04	AC
ACCGSEF2	2-Core Foam Filter Kit	1	\$39.80	GA
ACCGSFF2	HRV Core Foam Filters (Two Pieces)	1	\$39.78	GA
ACCGSFH	HEPA Filter Only	1	\$168.70	GA
ACCGSFHP2	1 Year HEPA Filter Kit (Two pre-filters and one HEPA)	1	\$198.50	GA
ACCGSFHP10	1 Year HEPA Filter Multi-Pack (Ten ACCGSFHP2)	1	\$1,881.00	GA
ACCGSFP2	Pre-filter Kit (Two Pieces)	1	\$36.68	GA
ACCGSFP20	Pre-filter Multi-Pack (Ten ACCGSFP2)	1	\$353.44	GA
ACCGSUP5	Alpine/Pine Filter Kit (Five Pieces)	1	\$71.52	GA
ACCGSUHD	AirDuo Outdoor Hood	1	\$56.98	GA
ACCHEPAPFK	Prefilter Kit	1	\$36.20	AQ
ACCHEPARF	Replacement HEPA Filter for ERVH100SE/HRVH100SE	1	\$98.04	AQ
ACCWMK	Walk Mount Bracket Kit	1	\$70.02	AQ
B1600705	Light Commercial Heat Recovery Ventilator Pool	1	\$7,180.10	AQ
BD4	Pressure Relief Damper with Wall Cap and 4" collar	1	\$83.98	AQ
BD6	Pressure Relief Damper with Wall Cap and 6" collar	1	\$83.98	AQ
DT4C	Flex Duct, 4", Non-insulated (25')	4 *	\$49.36	AC
DT4W	Flex Duct, 4", Insulated (25')	1	\$71.72	AC
DT6C	Flex Duct, 6", Non-insulated (25')	1	\$64.64	AC
DT6W	Flex Duct, 6", Insulated (25')	1	\$100.32	AC
EH6	Exterior Inlet/Outlet Hood, 6"	1	\$76.70	AQ
TYIK1	Installation Kit (Tandem Y, complete exterior vent, screws)	1	\$125.48	AQ
VB20W	▲ 20-Minute Push Button Timer	1	\$31.66	AQ
VB60W	20/40/60 Minute Wall Control	1	\$45.96	AQ
VT1W	□ Basic Wall Control. Off-low-high rocker switch. Dehumidistat. Low Voltage.	1	\$61.16	AQ
VT4W	‡ Wall Control, Off/Low/High Speed/Intermittent 20 min./hour	1	\$84.98	AQ
VT5W	« Programmable Electronic Wall Control with LCD Display. Four modes and filter function.	1	\$96.16	AQ
VT6W	Constructo Wall Control	1	\$57.12	AQ
VT7W	Deco-Touch Wall Control	1	\$167.82	AQ
VT8W	Altitude Wall Control	1	\$271.96	AQ
VT9W	HE Wall Control	1	\$208.00	AQ
VT10W	Pool Plus Wall Control	1	\$698.68	AQ

‡ Can be used with HRV90H and ERV90HC.

▲ Can be used with all units except GSE, GSH, GSV and GSF units.

« Can only be used with GSE and GSH units.

□ Can only be used with HRV100 and HRV200.

● Item too large to ship via UPS/FedEx. Item shipped common carrier at minimum rates.

* All pricing reflects the individual item cost. You must order in multiples as indicated.

◆ UL listed for use over bathtubs and showers when connected to a GFCI protected branch circuit.

Whole House Mechanical Ventilation

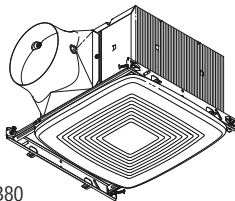

ZB80
ZB110

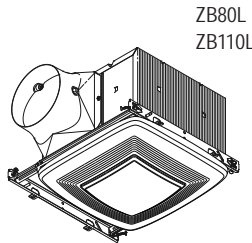

ZB80L
ZB110L

Broan® ULTRA™ Green Multi-Speed Series

We started with installation and worked back to build the ultimate bath fan. Unique telescoping mounting frame is ideal for both new construction and retrofit. No attic access needed! DC motor for efficiency. Multi-speed capability ideal for meeting ASHRAE 62.2, LEED, ENERGY STAR® for Homes and CA Title 24 — as well as local/spot ventilation needs. Powerful operation maintained over a wide range of real-world installations (CFM rating at 0.1" static pressure maintained through 0.25" static pressure). Fits in 2" x 8" ceiling construction. 10-1/2" L x 11-3/8" W x 7-5/8" H housing. 13" x 14" grille (fan) and 13" x 13-1/4" (fan/light/night light). All models have a 6" duct connector and the 50 CFM and 80 CFM models include a 6" to 4" reducer. All ULTRA 80 and 110 CFM fans can also be used with the MD6TU universal make-up air damper if 6" rigid duct is used. ULTRA non-sensing fans (not fan/lights) can also be used with the RDF1 radiation damper. Now with QStream sound technology that features airflow-smoothing baffles to reduce noise caused by turbulence (50 and 80 CFM models only).

Model No.	Description	Std. Pk.	List Price	Code
Fans				
ZB80 ◆	30 CFM to 80 CFM, <0.3 Sones, ENERGY STAR Fan	1	\$308.94	HP
ZB110 ◆	30 CFM to 110 CFM, <0.3 Sones, ENERGY STAR Fan	1	\$337.68	HP
Fan/Light/Night Light				
ZB80L ◆	30 CFM to 80 CFM, <0.3 Sones, ENERGY STAR Fan with 36W Fluorescent Light (2-18 watt GU24 bulbs included) and 4W Night Light (bulb not included)	1	\$423.68	HP
ZB110L ◆	30 CFM to 110 CFM, <0.3 Sones, ENERGY STAR Fan with 36W Fluorescent Light (2-18 watt GU24 bulbs included) and 4W Night Light (bulb not included)	1	\$454.76	HP



All models are ENERGY STAR certified products.

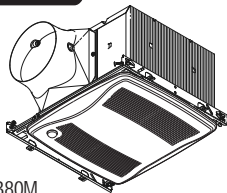

ZB80M
ZB110M

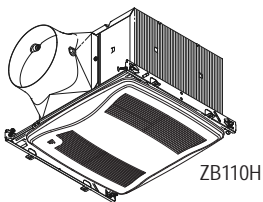

ZB110H

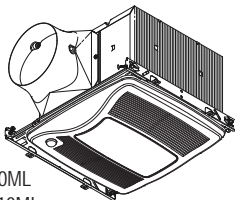

ZB80ML
ZB110ML

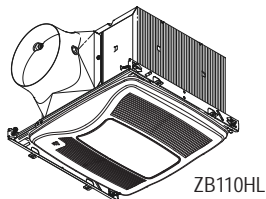

ZB110HL

Broan® ULTRA™ Green Multi-Speed Series — Sensing

We started with installation and worked back to build the ultimate bath fan. Unique telescoping mounting frame is ideal for both new construction and retrofit. No attic access needed! DC motor for efficiency. Multi-speed capability ideal for meeting ASHRAE 62.2, LEED, ENERGY STAR® for Homes and CA Title 24 — as well as local/spot ventilation needs. Humidity or motion sensing triggers fan to ramp up from lower continuous ventilation level to maximum CFM. Powerful operation maintained over a wide range of real-world installations (CFM rating at 0.1" static pressure maintained through 0.25" static pressure). Fits in 2" x 8" ceiling construction. 10-1/2" L x 11-3/8" W x 7-5/8" H housing. 13" x 14" grille (fan) and 13" x 13-1/4" (fan/light/night light). All models have a 6" duct connector and the 80 CFM models include a 6" to 4" reducer. All ULTRA 80 and 110 CFM fans can also be used with the MD6TU universal make-up air damper if 6" rigid duct is used. ULTRA non-sensing fans (not fan/lights) can also be used with the RDF1 radiation damper. Now with QStream sound technology that features airflow-smoothing baffles to reduce noise caused by turbulence (50 and 80 CFM models only).

Model No.	Description	Std. Pk.	List Price	Code
Fans				
ZB80M ◆	80 CFM, <0.3 Sones, ENERGY STAR Motion Sensing Fan	1	\$356.76	HP
ZB110H ◆	110 CFM, <0.3 Sones, ENERGY STAR Humidity Sensing Fan	1	\$448.82	HP
ZB110M ◆	110 CFM, <0.3 Sones, ENERGY STAR Motion Sensing Fan	1	\$383.74	HP
Fan/Light/Night Light				
ZB80ML ◆	80 CFM, <0.3 Sones, ENERGY STAR Motion Sensing Fan with 36W Fluorescent Light (2-18 watt GU24 bulbs included) and 4W Night Light (bulb not included)	1	\$478.38	HP
ZB110HL ◆	110 CFM, <0.3 Sones, ENERGY STAR Humidity Sensing Fan with 36W Fluorescent Light (2-18 watt GU24 bulbs included) and 4W Night Light (bulb not included)	1	\$570.70	HP
ZB110ML ◆	110 CFM, <0.3 Sones, ENERGY STAR Motion Sensing Fan with 36W Fluorescent Light (2-18 watt GU24 bulbs included) and 4W Night Light (bulb not included)	1	\$511.80	HP



All models are ENERGY STAR certified products.

See Ventilation Fan section for other Whole House Mechanical Ventilation options.

- Item too large to ship via UPS/FedEx. Item shipped common carrier at minimum rates.
- * All pricing reflects the individual item cost. You must order in multiples as indicated.
- ◆ UL listed for use over bathtubs and showers when connected to a GFCI protected branch circuit.

Whole House Mechanical Ventilation

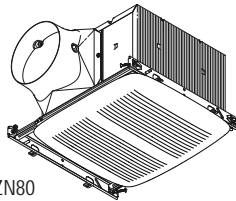

ZN80
ZN110

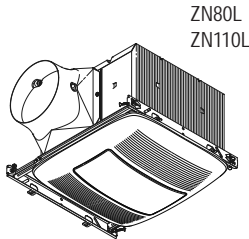

ZN80L
ZN110L

NuTone® ULTRA™ Green Multi-Speed Series

We started with installation and worked back to build the ultimate bath fan. Unique telescoping mounting frame is ideal for both new construction and retrofit. No attic access needed! DC motor for efficiency. Multi-speed capability ideal for meeting ASHRAE 62.2, LEED, ENERGY STAR® for Homes and CA Title 24 — as well as local/spot ventilation needs. Powerful operation maintained over a wide range of real-world installations (CFM rating at 0.1" static pressure maintained through 0.25" static pressure). Fits in 2" x 8" ceiling construction. 10-1/2" L x 11-3/8" W x 7-5/8" H housing. 13" x 14" grille (fan) and 13" x 13-1/4" (fan/light/night light). All models have a 6" duct connector and the 50 CFM and 80 CFM models include a 6" to 4" reducer. All ULTRA 80 and 110 CFM fans can also be used with the MD6TU universal make-up air damper if 6" rigid duct is used. ULTRA non-sensing fans (not fan/lights) can also be used with the RDF1 radiation damper. Now with QStream sound technology that features airflow-smoothing baffles to reduce noise caused by turbulence (50 and 80 CFM models only).

Model No.	Description	Std. Pk.	List Price	Code
Fans				
ZN80	◆ 30 CFM to 80 CFM, <0.3 Sones, ENERGY STAR Fan	1	\$308.94	HP
ZN110	◆ 30 CFM to 110 CFM, <0.3 Sones, ENERGY STAR Fan	1	\$337.68	HP
Fan/Light/Night Light				
ZN80L	◆ 30 CFM to 80 CFM, <0.3 Sones, ENERGY STAR Fan with 36W Fluorescent Light (2-18 watt GU24 bulbs included) and 4W Night Light (bulb not included)	1	\$423.68	HP
ZN110L	◆ 30 CFM to 110 CFM, <0.3 Sones, ENERGY STAR Fan with 36W Fluorescent Light (2-18 watt GU24 bulbs included) and 4W Night Light (bulb not included)	1	\$454.76	HP



All models are ENERGY STAR certified products.

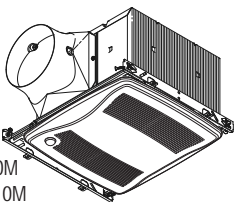

ZN80M
ZN110M

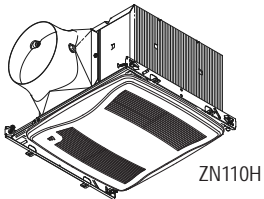

ZN110H

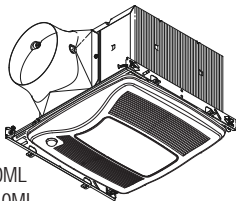

ZN80ML
ZN110ML

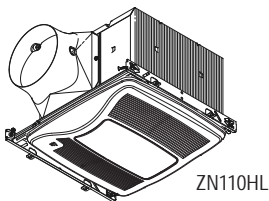

ZN110HL

NuTone® ULTRA™ Green Multi-Speed Series — Sensing

We started with installation and worked back to build the ultimate bath fan. Unique telescoping mounting frame is ideal for both new construction and retrofit. No attic access needed! DC motor for efficiency. Multi-speed capability ideal for meeting ASHRAE 62.2, LEED, ENERGY STAR® for Homes and CA Title 24 — as well as local/spot ventilation needs. Humidity or motion sensing triggers fan to ramp up from lower continuous ventilation level to maximum CFM. Powerful operation maintained over a wide range of real-world installations (CFM rating at 0.1" static pressure maintained through 0.25" static pressure). Fits in 2" x 8" ceiling construction. 10-1/2" L x 11-3/8" W x 7-5/8" H housing. 13" x 14" grille (fan) and 13" x 13-1/4" (fan/light/night light). All models have a 6" duct connector and the 80 CFM models include a 6" to 4" reducer. All ULTRA 80 and 110 CFM fans can also be used with the MD6TU universal make-up air damper if 6" rigid duct is used. ULTRA non-sensing fans (not fan/lights) can also be used with the RDF1 radiation damper. Now with QStream sound technology that features airflow-smoothing baffles to reduce noise caused by turbulence (50 and 80 CFM models only).

Model No.	Description	Std. Pk.	List Price	Code
Fans				
ZN80M	◆ 80 CFM, <0.3 Sones, ENERGY STAR Motion Sensing Fan	1	\$356.76	HP
ZN110H	◆ 110 CFM, <0.3 Sones, ENERGY STAR Humidity Sensing Fan	1	\$448.82	HP
ZN110M	◆ 110 CFM, <0.3 Sones, ENERGY STAR Motion Sensing Fan	1	\$383.74	HP
Fan/Light/Night Light				
ZN80ML	◆ 80 CFM, <0.3 Sones, ENERGY STAR Motion Sensing Fan with 36W Fluorescent Light (2-18 watt GU24 bulbs included) and 4W Night Light (bulb not included)	1	\$478.38	HP
ZN110HL	◆ 110 CFM, <0.3 Sones, ENERGY STAR Humidity Sensing Fan with 36W Fluorescent Light (2-18 watt GU24 bulbs included) and 4W Night Light (bulb not included)	1	\$570.70	HP
ZN110ML	◆ 110 CFM, <0.3 Sones, ENERGY STAR Motion Sensing Fan with 36W Fluorescent Light (2-18 watt GU24 bulbs included) and 4W Night Light (bulb not included)	1	\$511.80	HP



All models are ENERGY STAR certified products.

- Item too large to ship via UPS/FedEx. Item shipped common carrier at minimum rates.
- * All pricing reflects the individual item cost. You must order in multiples as indicated.
- ◆ UL listed for use over bathtubs and showers when connected to a GFCI protected branch circuit.

Carton/UPC Directory

Model	UPC Code	Std. Carton		Master Carton		Length	Width	Height	Cube
		Pk.	Wt.	Pk.	Wt.				
1006	0 26715 02320 2	—	—	10	20.00	1.48	1.05	0.83	1.28
100HFL	0 26715 18026 4	1	16.90	—	—	1.76	0.87	1.17	1.78
100HL	0 26715 18025 7	1	16.70	—	—	1.75	0.88	1.17	1.80
103023	0 26715 02335 6	1	31.60	—	—	2.46	1.03	1.35	3.43
103123	0 26715 02336 3	1	2.00	—	—	1.87	0.54	0.24	0.24
110RDF	0 26715 14611 6	—	—	4	17.50	1.83	0.98	1.06	1.91
112	0 26715 00405 8	1	12.80	—	—	1.70	0.38	1.11	0.72
114	0 26715 02254 0	1	12.70	—	—	1.68	0.38	1.11	0.72
120	0 26715 00440 9	1	7.30	—	—	1.23	0.93	0.51	0.58
124	0 26715 00441 6	1	7.40	—	—	1.25	0.92	0.50	0.57
128	0 26715 00442 3	1	7.60	—	—	1.25	0.92	0.50	0.57
12C	0 26715 02108 6	1	15.70	—	—	1.25	0.87	1.28	1.38
153001	0 26715 02346 2	1	39.10	—	—	2.88	1.28	1.23	4.49
153004	0 26715 16338 0	1	38.60	—	—	2.88	1.27	1.22	4.44
153023	0 26715 02347 9	1	38.90	—	—	2.89	1.27	1.23	4.52
153601	0 26715 02348 6	1	41.40	—	—	3.38	1.27	1.23	5.24
153604	0 26715 16339 7	1	41.20	—	—	3.38	1.27	1.22	5.21
153623	0 26715 02349 3	1	41.10	—	—	3.36	1.28	1.22	5.24
157	0 26715 08073 1	1	3.00	—	—	1.04	1.06	0.33	0.37
157CBB	0 26715 18259 6	1	7.10	—	—	1.98	1.05	0.13	0.28
157CBL	0 26715 18256 5	1	1.95	16	31.20	0.75	0.94	0.10	0.07
157COD	0 26715 18257 2	1	0.60	10	6.00	0.56	0.54	0.13	0.04
157CTK	0 26715 18258 9	1	2.40	—	—	1.33	0.34	0.33	0.15
161	0 26715 00263 4	1	5.30	—	—	1.15	0.91	0.62	0.64
162	0 26715 00262 7	1	7.40	—	—	1.04	0.90	0.62	0.58
162F	0 26715 02258 8	—	—	4	2.50	0.89	0.88	0.33	0.26
162H	0 26715 02259 5	—	—	4	26.00	1.53	1.05	1.08	1.72
163	0 26715 00261 0	1	7.20	—	—	1.40	0.93	0.58	0.76
164	0 26715 00260 3	1	9.10	—	—	1.38	1.03	0.60	0.85
165F	0 26715 00454 6	1	5.10	—	—	1.24	0.93	0.52	0.59
165FT	0 26715 03035 4	1	6.00	—	—	1.25	0.93	0.50	0.58
1667H	0 26715 02326 4	—	—	6	7.88	1.57	0.68	0.99	1.06
1667HMTL	0 26715 14457 0	—	—	6	8.25	1.56	0.67	0.99	1.03
1670F	0 26715 02327 1	—	—	6	14.63	1.33	1.13	0.92	1.38
1671F	0 26715 02328 8	—	—	6	15.38	1.33	1.14	0.92	1.39
167F	0 26715 00455 3	1	5.20	—	—	1.24	0.93	0.52	0.59
167FT	0 26715 03036 1	1	6.00	—	—	1.25	0.93	0.50	0.58
1688F	0 26715 02329 5	—	—	6	12.75	1.95	0.78	0.83	1.27
1689F	0 26715 02330 1	—	—	6	13.88	1.33	1.14	0.92	1.39
170	0 26715 00443 0	1	7.20	—	—	1.25	0.93	0.51	0.59
171H	0 26715 02262 5	—	—	4	11.00	1.43	1.04	0.84	1.25
174	0 26715 00257 3	1	7.20	—	—	1.24	0.93	0.51	0.58
174F	0 26715 00457 7	1	5.00	—	—	1.25	0.93	0.52	0.60
174FT	0 26715 03038 5	1	5.10	—	—	1.24	0.93	0.52	0.60
178	0 26715 00448 5	1	7.40	—	—	1.25	0.93	0.51	0.59
192	0 26715 10003 3	1	22.00	—	—	1.86	1.53	0.58	1.63
194	0 26715 02265 6	1	21.80	—	—	1.86	1.52	0.58	1.62
198	0 26715 02267 0	1	21.70	—	—	1.85	1.53	0.58	1.65
2677H	0 26715 13914 9	—	—	4	9.75	1.69	0.78	1.07	1.40
2678F	0 26715 13915 6	—	—	4	12.75	1.81	0.99	1.06	1.90
269VL	0 26715 08269 8	1	0.40	—	—	0.41	0.41	0.29	0.05
269WL	0 26715 08268 1	1	0.55	—	—	0.41	0.40	0.33	0.05
273001C	0 26715 05494 7	1	1.40	—	—	3.11	0.23	0.14	0.10
273002C	0 26715 14276 7	1	1.40	—	—	3.07	0.23	0.14	0.10
273003	0 26715 05297 4	1	66.20	—	—	2.83	2.90	0.90	7.39
273023C	0 26715 05497 8	1	1.30	—	—	3.11	0.23	0.14	0.10
273601C	0 26715 05495 4	1	1.50	—	—	3.09	0.23	0.14	0.10
273602C	0 26715 14277 4	1	2.30	—	—	3.11	0.22	0.13	0.09
273603	0 26715 05298 1	1	72.70	—	—	3.33	2.89	0.90	8.67
273623C	0 26715 05496 1	1	1.50	—	—	3.10	0.23	0.14	0.10
277V	0 26715 13191 4	1	0.55	—	—	0.42	0.25	0.31	0.03
283003	0 26715 05408 4	1	37.90	—	—	2.95	2.83	0.91	7.57
283603	0 26715 05409 1	1	43.20	—	—	3.33	2.89	0.92	8.81
326N	7 84891 77015 9	1	1.10	—	—	0.77	0.51	0.25	0.10
330ALM	0 26715 25008 0	1	0.45	20	9.00	0.99	0.53	0.77	0.41
330W	7 84891 99508 8	1	0.23	20	4.60	0.44	0.29	0.15	0.02
331H	0 26715 07181 4	1	30.00	—	—	2.61	0.82	2.33	4.95
332H	0 26715 07182 1	1	32.00	—	—	2.63	0.84	2.33	5.14
332KR	0 26715 12215 8	1	3.30	—	—	2.03	0.93	0.23	0.44
335	0 26715 10996 8	1	38.20	—	—	3.01	1.24	2.19	8.17
336	0 26715 10997 5	1	43.60	—	—	3.00	1.21	2.19	7.93

Model	UPC Code	Std. Carton		Master Carton		Length	Width	Height	Cube
		Pk.	Wt.	Pk.	Wt.				
345CSOBK	0 26715 20467 0	1	20.00	—	—	2.29	0.95	2.61	5.68
345CSOWW	0 26715 20468 7	1	19.60	—	—	2.26	0.96	2.57	5.55
345GOBK	0 26715 20465 6	1	20.90	—	—	2.33	1.05	2.58	6.33
345GOWW	0 26715 20466 3	1	21.90	—	—	2.32	1.08	2.62	6.52
345RSOBK	0 26715 20469 4	1	26.80	—	—	2.02	0.93	2.63	4.94
345RSOWW	0 26715 20470 0	1	26.80	—	—	2.02	0.93	2.63	4.94
345SOBK	0 26715 20471 7	1	21.00	—	—	2.59	0.83	2.25	4.86
345SOWW	0 26715 20472 4	1	20.75	—	—	2.60	0.80	2.27	4.72
349BR	0 26715 18983 0	1	18.20	—	—	2.17	0.75	2.16	3.51
35	0 26715 02169 7	1	1.70	—	—	1.02	0.49	0.13	0.06
350BK	0 26715 18270 1	1	16.60	—	—	1.93	0.72	1.91	2.63
350BR	0 26715 18260 2	1	16.40	—	—	1.92	0.70	1.90	2.55
353	0 26715 00153 8	1	11.10	—	—	1.32	0.73	1.38	1.32
35316	0 26715 13697 1	1	13.10	—	—	1.32	0.72	1.38	1.31
355BK	0 26715 18269 5	1	17.80	—	—	1.93	0.73	1.90	2.65
355BR	0 26715 18268 8	1	17.10	—	—	1.94	0.71	1.88	2.58
356BK	0 26715 18267 1	1	20.40	—	—	1.93	0.78	1.92	2.89
356BR	0 26715 18271 8	1	21.00	—	—	1.94	0.77	1.88	2.80
356NDK	0 26715 17423 2	1	5.10	—	—	2.15	0.89	0.93	1.79
357NDK	0 26715 17424 9	1	5.30	—	—	1.68	1.19	1.05	2.11
358	0 26715 00156 9	1	17.80	—	—	1.99	0.72	1.97	2.81
359NDK	0 26715 23795 1	1	5.10	—	—	1.69	1.19	1.06	2.13
360ALM	0 26715 25007 3	1	9.90	20	198.00	1.08	1.05	0.82	0.93
360IV	7 84891 77161 3	1	0.27	20	5.40	0.35	0.31	0.22	0.02
360W	7 84891 99336 7	1	0.27	20	5.40	0.35	0.31	0.22	0.02
3677H	0 26715 14133 3	—	—	4	13.25	1.70	0.76	1.07	1.38
372	7 84891 77220 7	1	7.00	—	—	0.82	1.47	1.43	1.72
372401	0 26715 03224 2	1	6.80	—	—	2.25	0.64	1.63	2.35
372408	0 26715 03225 9	1	7.00	—	—	2.25	0.63	1.63	2.30
373001	0 26715 03227 3	1	8.30	—	—	2.75	0.64	1.63	2.87
373002	0 26715 14257 6	1	8.40	—	—	2.75	0.63	1.62	2.82
373004	0 26715 04454 2	1	8.80	—	—	2.75	0.63	1.63	2.83
373008	0 26715 03228 0	1	8.40	—	—	2.76	0.63	1.63	2.84
373601	0 26715 03232 7	1	9.70	—	—	3.25	0.65	1.63	3.43
373604	0 26715 04455 9	1	9.90	—	—	3.25	0.63	1.63	3.34
376JL	7 84891 99227 8	1	1.74	6	10.44	0.55	0.55	0.28	0.08
378	7 84891 99229 2	1	0.10	20	2.00	0.29	0.13	0.01	0.00
3808	7 84891 99231 5	—	—	8	13.70	8.00	0.67	0.33	1.78
3808B	7 84891 77261 0	—	—	440	742.50	0.67	8.00	0.33	1.78
3810	0 26715 23544 5	—	—	10	22.00	10.00	0.71	0.46	3.25
391	7 84891 99240 7	1	0.50	6	3.00	0.73	0.67	0.15	0.07
392	7 84891 77320 4	1	0.97	—	—	0.93	0.33	0.33	0.10
393	7 84891 99242 1	1	0.90	6	5.40	0.55	0.54	0.27	0.08
394	7 84891 99339 8	1	0.10	10	1.00	0.03	0.25	0.32	0.00
395	7 84891 99243 8	1	1.90	6	11.40	2.32	0.33	0.50	0.39
3964	0 26715 23843 9	1	5.20	—	—	0.94	0.69	0.81	0.53
402101	0 26715 03090 3	1	10.10	—	—	2.00	0.63	1.65	2.09
402102	0 26715 14273 6	1	9.30	—	—	2.00	0.63	1.63	2.06
402108	0 26715 03091 0	1	9.30	—	—	2.00	0.63	1.63	2.06
402401	0 26715 02358 5	1	10.90	—	—	2.24	0.63	1.63	2.28
402402</									

Model	UPC Code	Std. Carton		Master Carton		Length	Width	Height	Cube
		Pk.	Wt.	Pk.	Wt.				
412101	0 26715 03100 9	1	9.30	—	—	2.00	0.63	1.63	2.06
412102	0 26715 14272 9	1	9.30	—	—	2.00	0.63	1.63	2.06
412108	0 26715 03101 6	1	9.30	—	—	2.00	0.63	1.63	2.06
412123	0 26715 18790 4	1	9.30	—	—	2.00	0.63	1.63	2.06
412401	0 26715 00842 1	1	10.10	—	—	2.24	0.63	1.62	2.27
412402	0 26715 14248 4	1	10.10	—	—	2.24	0.63	1.62	2.27
412404	0 26715 00843 8	1	10.40	—	—	2.23	0.63	1.63	2.30
412408	0 26715 00844 5	1	10.10	—	—	2.24	0.63	1.62	2.27
412H	0 26715 00268 9	1	1.45	—	—	0.88	0.87	0.65	0.50
413	0 26715 01599 3	1	1.90	—	—	1.03	1.03	0.87	0.91
413001	0 26715 00230 6	1	11.40	—	—	2.75	0.63	1.63	2.79
413002	0 26715 14249 1	1	11.40	—	—	2.75	0.63	1.63	2.79
413004	0 26715 00406 5	1	11.70	—	—	2.75	0.64	1.63	2.87
413008	0 26715 00231 3	1	11.40	—	—	2.75	0.63	1.63	2.79
413023	0 26715 03106 1	1	11.40	—	—	2.75	0.63	1.63	2.79
413601	0 26715 00232 0	1	12.60	—	—	3.24	0.63	1.63	3.34
413602	0 26715 14250 7	1	12.60	—	—	3.24	0.63	1.63	3.34
413604	0 26715 02364 6	1	13.20	—	—	3.24	0.63	1.63	3.34
413608	0 26715 00233 7	1	12.60	—	—	3.24	0.63	1.63	3.34
413623	0 26715 03107 8	1	12.60	—	—	3.24	0.63	1.63	3.34
414	0 26715 07547 8	1	1.90	—	—	1.02	1.01	0.88	0.90
414201	0 26715 00411 9	1	13.80	—	—	3.75	0.63	1.62	3.84
414202	0 26715 14251 4	1	13.80	—	—	3.75	0.63	1.62	3.84
414204	0 26715 03583 0	1	14.50	—	—	3.75	0.63	1.62	3.79
414208	0 26715 00412 6	1	13.80	—	—	3.75	0.63	1.62	3.84
415	0 26715 00796 7	—	—	4	6.50	1.69	1.68	0.68	1.92
418	0 26715 05945 4	1	3.40	—	—	1.13	1.12	0.90	1.14
419	0 26715 01600 6	1	1.10	—	—	0.98	0.77	0.77	0.58
41F	0 26715 00091 3	—	—	6	1.50	0.94	0.41	0.85	0.33
421	0 26715 03900 5	1	0.75	—	—	0.96	0.84	0.13	0.10
422401	0 26715 03110 8	1	10.40	—	—	2.23	0.65	1.62	2.35
422401D	0 26715 17252 8	1	10.40	—	—	2.23	0.65	1.62	2.35
422402	0 26715 14245 3	1	10.40	—	—	2.23	0.65	1.62	2.35
422404	0 26715 03111 5	1	10.70	—	—	2.23	0.63	1.63	2.30
422408	0 26715 03112 2	1	10.40	—	—	2.23	0.65	1.62	2.35
423	0 26715 03902 9	1	3.60	—	—	1.60	0.95	0.95	1.44
423001	0 26715 00226 9	1	11.60	—	—	2.75	0.63	1.63	2.79
423001D	0 26715 17257 3	1	11.60	—	—	2.75	0.63	1.63	2.79
423002	0 26715 14246 0	1	11.60	—	—	2.75	0.63	1.63	2.79
423004	0 26715 00414 0	1	12.10	—	—	2.73	0.63	1.63	2.81
423008	0 26715 00227 6	1	11.60	—	—	2.75	0.63	1.63	2.79
423008D	0 26715 17253 5	1	11.60	—	—	2.75	0.63	1.63	2.79
423023	0 26715 03116 0	1	11.60	—	—	2.75	0.63	1.63	2.79
423601	0 26715 00228 3	1	12.90	—	—	3.24	0.65	1.63	3.42
423601D	0 26715 17255 9	1	12.90	—	—	3.24	0.65	1.63	3.42
423602	0 26715 14247 7	1	12.90	—	—	3.24	0.65	1.63	3.42
423604	0 26715 00417 1	1	13.50	—	—	3.25	0.64	1.63	3.39
423608	0 26715 00229 0	1	12.90	—	—	3.24	0.65	1.63	3.42
423608D	0 26715 17254 2	1	12.90	—	—	3.24	0.65	1.63	3.42
423623	0 26715 03117 7	1	12.90	—	—	3.24	0.65	1.63	3.42
424	0 26715 03903 6	1	4.10	—	—	1.61	0.96	0.94	1.45
424201	0 26715 00420 1	1	14.10	—	—	3.75	0.63	1.63	3.88
424201D	0 26715 17256 6	1	12.90	—	—	3.24	0.65	1.63	3.42
424202	0 26715 14292 7	1	14.10	—	—	3.75	0.65	1.63	3.96
424204	0 26715 03584 7	1	14.90	—	—	3.75	0.63	1.63	3.88
424208	0 26715 00421 8	1	14.10	—	—	3.75	0.65	1.63	3.96
427	0 26715 12607 1	1	2.50	—	—	1.65	0.94	0.60	0.93
428	0 26715 01114 8	1	1.30	—	—	1.03	0.49	0.72	0.36
429	0 26715 01115 5	1	2.20	—	—	1.00	1.03	0.88	0.90
430	0 26715 01601 3	1	2.80	—	—	0.98	0.90	0.53	0.47
431	0 26715 01602 0	1	3.60	—	—	1.02	0.88	0.79	0.71
432	0 26715 22966 6	1	1.95	—	—	1.02	1.00	0.85	0.87
433	0 26715 00051 7	1	3.25	—	—	1.74	1.63	0.24	0.69
433004	0 26715 10058 3	1	14.20	—	—	2.78	0.62	1.61	2.75
433011	0 26715 10056 9	1	13.80	—	—	2.75	0.67	1.63	2.98
433018	0 26715 10057 6	1	14.90	—	—	2.75	0.65	1.64	2.93
433022	0 26715 14234 7	1	14.40	—	—	2.76	0.64	1.63	2.89
433023	0 26715 14519 5	1	13.80	—	—	2.77	0.64	1.63	2.88
433604	0 26715 10061 3	1	15.80	—	—	3.26	0.64	1.65	3.44
433611	0 26715 10059 0	1	15.80	—	—	3.28	0.65	1.65	3.50
433618	0 26715 10060 6	1	15.60	—	—	3.26	0.63	1.64	3.39

Model	UPC Code	Std. Carton		Master Carton		Length	Width	Height	Cube
		Pk.	Wt.	Pk.	Wt.				
433622	0 26715 14235 4	1	16.20	—	—	3.27	0.63	1.64	3.40
433623	0 26715 14520 1	1	15.20	—	—	3.26	0.65	1.64	3.48
437	0 26715 03907 4	1	12.00	—	—	2.34	0.83	1.58	3.07
438	0 26715 07549 2	1	1.60	—	—	0.69	0.69	0.69	0.33
441	0 26715 03908 1	1	3.80	—	—	1.13	1.17	0.32	0.42
453	0 26715 04491 7	1	5.20	—	—	2.08	1.00	1.00	2.08
454	0 26715 04492 4	1	5.10	—	—	2.11	1.08	1.06	2.41
459	0 26715 15379 4	1	1.90	—	—	1.28	0.67	0.77	0.65
462401	0 26715 14502 7	1	12.20	—	—	2.23	0.66	1.63	2.39
462404	0 26715 14503 4	1	12.60	—	—	2.23	0.66	1.63	2.39
462423	0 26715 14505 8	1	12.20	—	—	2.23	0.66	1.63	2.39
463001	0 26715 01062 2	1	13.40	—	—	2.75	0.67	1.62	2.96
463002	0 26715 14242 2	1	13.40	—	—	2.75	0.67	1.62	2.96
463004	0 26715 00237 5	1	13.90	—	—	2.74	0.65	1.63	2.91
463008	0 26715 00234 4	1	13.40	—	—	2.75	0.67	1.62	2.96
463011	0 26715 10395 9	1	13.40	—	—	2.75	0.67	1.62	2.96
463023	0 26715 03120 7	1	13.40	—	—	2.75	0.67	1.62	2.96
463601	0 26715 01061 5	1	14.90	—	—	3.25	0.66	1.63	3.48
463602	0 26715 14243 9	1	14.90	—	—	3.25	0.66	1.63	3.48
463604	0 26715 00241 2	1	15.40	—	—	3.23	0.64	1.62	3.35
463608	0 26715 00238 2	1	14.90	—	—	3.25	0.66	1.63	3.48
463623	0 26715 03122 1	1	14.90	—	—	3.25	0.66	1.63	3.48
464201	0 26715 00242 9	1	16.00	—	—	3.75	0.63	1.63	3.88
464202	0 26715 14244 6	1	16.00	—	—	3.75	0.63	1.63	3.88
464204	0 26715 00244 3	1	16.50	—	—	3.75	0.63	1.63	3.88
464208	0 26715 00243 6	1	16.00	—	—	3.75	0.63	1.63	3.88
472	0 26715 02281 6	1	2.60	—	—	0.87	0.87	0.68	0.51
475	0 26715 16541 4	1	0.30	—	—	0.57	0.57	0.38	0.12
475B	0 26715 16540 7	—	—	6	1.13	0.97	0.54	0.56	0.29
502	0 26715 02282 3	1	10.80	—	—	1.46	0.63	1.20	1.11
503	0 26715 02283 0	1	7.90	—	—	1.28	0.58	1.05	0.77
504	0 26715 02284 7	1	8.60	—	—	1.17	0.80	1.18	1.10
505	0 26715 02285 4	1	7.00	—	—	1.15	0.74	1.16	0.99
506	0 26715 02286 1	1	12.60	—	—	1.24	0.78	1.26	1.22
507	0 26715 02287 8	1	11.10	—	—	1.25	0.79	1.26	1.25
508	0 26715 02288 5	1	13.30	—	—	1.64	0.89	1.25	1.83
509	0 26715 02289 2	1	12.70	—	—	1.64	0.92	1.23	1.86
509S	0 26715 02290 8	1	13.00	—	—	1.60	0.90	1.19	1.71
510	0 26715 02291 5	1	10.20	—	—	1.14	0.78	1.18	1.04
511	0 26715 02292 2	1	8.30	—	—	1.15	0.78	1.18	1.05
512	0 26715 02293 9	1	3.20	—	—	0.73	0.72	0.59	0.31
512M	0 26715 06713 8	1	3.40	—	—	0.71	0.71	0.82	0.41
57V	0 26715 03815 2	1	0.30	—	—	0.43	0.25	0.30	0.03
57W	0 26715 03859 6	1	0.30	—	—	0.43	0.25	0.30	0.03
59V	0 26715 03820 6	1	0.40	—	—	0.43	0.25	0.30	0.03
59W	0 26715 03864 0	1	0.40	—	—	0.43	0.25	0.30	0.03
59V	0 26715 03820 6	1	0.40	—	—	0.43	0.25	0.30	0.03
59W	0 26715 03864 0	1	0.40	—	—	0.43	0.25	0.30	0.03
605RP	7 84891 34408 4	1	12.70	—	—	1.59	0.99	0.78	1.24
610FA	0 26715 21105 0	1	2.50	—	—	1.13	1.13	0.90	1.13
611	0 26715 06692 6	1	3.40	—	—				

Model	UPC Code	Std. Carton		Master Carton		Length	Width	Height	Cube
		Pk.	Wt.	Pk.	Wt.				
637004EX	0 26715 15233 9	1	82.00	—	—	3.58	2.63	2.13	19.99
639	0 26715 00264 1	1	2.50	—	—	1.12	0.82	0.54	0.49
63V	0 26715 03829 9	1	0.70	—	—	0.41	0.41	0.31	0.05
63W	0 26715 03873 2	1	0.80	—	—	0.41	0.41	0.29	0.05
641	0 26715 01137 7	1	1.30	—	—	0.79	0.79	0.67	0.42
641FA	0 26715 19206 9	1	1.20	—	—	0.78	0.78	0.66	0.40
642	0 26715 01138 4	—	—	4	3.50	1.13	1.13	0.83	1.06
643	0 26715 02294 6	1	2.40	—	—	1.13	1.13	0.88	1.13
643FA	0 26715 19207 6	1	2.40	—	—	1.13	1.13	0.89	1.14
644	0 26715 00393 8	1	3.20	—	—	1.60	1.21	0.61	1.18
646	0 26715 01605 1	1	0.90	—	—	0.69	0.71	0.70	0.34
647	0 26715 05212 7	1	1.40	—	—	0.78	0.79	0.68	0.42
649	0 26715 00394 5	1	1.40	—	—	1.10	0.82	0.55	0.49
64V	0 26715 04986 8	1	0.50	—	—	0.43	0.24	0.30	0.03
64W	0 26715 15854 6	1	0.50	—	—	0.43	0.24	0.30	0.03
654H	0 26715 02295 3	—	—	4	20.25	1.49	1.09	1.28	2.09
655	0 26715 00254 2	1	13.10	—	—	1.53	1.00	0.78	1.20
655F	0 26715 02296 0	1	8.60	—	—	1.43	0.96	0.74	1.02
656	0 26715 02297 7	1	11.30	—	—	1.53	1.01	0.81	1.25
656F	0 26715 02298 4	1	6.98	—	—	1.45	0.97	0.76	1.07
657	0 26715 02299 1	1	9.70	—	—	1.54	1.01	0.80	1.24
657F	0 26715 02300 4	1	5.20	—	—	1.45	0.95	0.73	1.00
658	0 26715 02301 1	1	12.40	—	—	1.53	1.01	0.81	1.25
658F	0 26715 02302 8	1	8.10	—	—	1.44	0.95	0.73	0.99
659	0 26715 02303 5	1	12.50	—	—	1.53	1.01	0.82	1.26
659F	0 26715 02304 2	1	8.40	—	—	1.43	0.96	0.74	1.01
665RP	7 84891 34447 3	1	12.80	—	—	1.58	1.00	0.79	1.25
668RP	7 84891 34451 0	1	9.10	—	—	1.58	0.99	0.79	1.24
66V	0 26715 03836 7	1	0.35	—	—	0.43	0.26	0.31	0.04
66W	0 26715 03877 0	1	0.35	—	—	0.43	0.26	0.31	0.04
670	0 26715 02305 9	1	3.80	—	—	0.84	0.36	0.78	0.24
671	0 26715 00252 8	1	3.70	—	—	0.85	0.37	0.78	0.24
673	0 26715 00253 5	1	3.20	—	—	0.72	0.32	0.59	0.30
678	0 26715 00259 7	1	5.90	—	—	0.79	0.98	1.08	0.84
67W	0 26715 03882 4	1	0.30	—	—	0.43	0.27	0.33	0.04
682	0 26715 00719 6	1	3.50	—	—	0.78	0.43	0.73	0.25
682NT	7 84891 30168 1	1	3.50	—	—	0.80	0.44	0.73	0.26
685WL	0 26715 08272 8	1	0.60	—	—	0.41	0.42	0.32	0.05
688	0 26715 00251 1	1	3.50	—	—	0.85	0.37	0.78	0.24
689	0 26715 00289 4	1	3.50	—	—	0.85	0.37	0.74	0.23
68V	0 26715 03844 2	1	0.90	—	—	0.43	0.27	0.33	0.04
68W	0 26715 03885 5	1	0.35	—	—	0.43	0.26	0.31	0.04
690	0 26715 16807 1	1	4.80	—	—	0.95	0.43	0.81	0.33
690NT	7 84891 25870 1	1	4.70	—	—	0.94	0.44	0.82	0.34
690RA	7 84891 25450 5	—	—	6	7.88	1.58	0.68	0.99	1.07
690RMTLA	7 84891 25451 2	—	—	6	8.25	1.56	0.67	0.98	1.02
695	7 84891 25836 7	1	3.80	—	—	0.85	0.38	0.79	0.25
695RB	7 84891 25453 6	—	—	6	15.75	1.32	1.14	1.00	1.50
696	0 26715 02315 8	1	10.30	—	—	1.54	1.01	0.80	1.24
696N	7 84891 25841 1	1	3.40	—	—	0.86	0.38	0.80	0.26
696RNB	7 84891 25455 0	—	—	6	12.48	1.95	0.79	0.88	1.35
69W	0 26715 08225 4	1	0.30	—	—	0.43	0.27	0.33	0.04
70TW	0 26715 18793 5	1	0.70	—	—	0.47	0.30	0.42	0.06
71V	0 26715 03852 7	1	1.00	—	—	0.43	0.25	0.30	0.03
72V	0 26715 03855 8	1	0.50	—	—	0.43	0.25	0.30	0.03
72W	0 26715 05375 9	1	0.50	—	—	0.43	0.25	0.30	0.03
72V	0 26715 03855 8	1	0.50	—	—	0.43	0.25	0.30	0.03
72W	0 26715 05375 9	1	0.50	—	—	0.43	0.25	0.30	0.03
73	0 26715 01606 8	1	0.70	—	—	0.73	0.28	0.28	0.06
741SN	0 26715 14509 6	1	10.90	—	—	1.18	1.18	1.14	1.58
744	0 26715 16301 4	1	9.40	—	—	1.20	0.79	0.88	0.83
744FL	0 26715 17091 3	1	10.20	—	—	1.21	0.79	0.90	0.86
744FLNT	7 84891 95128 2	1	9.80	—	—	1.22	0.83	0.89	0.89
744LED	0 26715 20915 6	1	10.30	—	—	1.23	0.79	0.92	0.89
744LEDNT	0 26715 20916 3	1	10.30	—	—	1.23	0.81	0.91	0.90
744NT	7 84891 95124 4	1	9.60	—	—	1.23	0.81	0.91	0.90
744SFL	0 26715 19208 3	1	10.30	—	—	1.23	0.90	0.81	0.89
744SFLNT	0 26715 19209 0	1	10.30	—	—	1.23	0.81	0.91	0.90
750	0 26715 14867 7	1	11.80	—	—	1.39	0.83	1.38	1.60
751	0 26715 14868 4	1	12.00	—	—	1.40	0.82	1.38	1.58
754RB	0 26715 16735 7	1	11.80	—	—	1.18	1.16	1.27	1.72

Model	UPC Code	Std. Carton		Master Carton		Length	Width	Height	Cube
		Pk.	Wt.	Pk.	Wt.				
75V	0 26715 03832 9	1	0.50	—	—	0.43	0.26	0.30	0.03
761BN	0 26715 19152 9	1	11.60	—	—	1.23	1.23	1.20	1.80
761RB	0 26715 19153 6	1	11.80	—	—	1.23	1.22	1.20	1.80
761WHA	0 26715 20106 8	1	12.20	—	—	1.23	1.22	1.21	1.80
763	0 26715 23517 9	1	5.90	—	—	0.79	0.98	1.08	0.84
763F	0 26715 23686 2	—	—	4	13.45	1.81	0.99	1.06	1.90
763H	0 26715 23685 5	—	—	4	9.80	1.69	0.75	1.08	1.36
765HFL	0 26715 18028 8	1	17.30	—	—	1.76	0.88	1.18	1.82
765HL	0 26715 18027 1	1	16.80	—	—	1.75	0.87	1.17	1.77
77DV	0 26715 10631 8	1	0.90	—	—	0.43	0.26	0.33	0.04
77DW	0 26715 10630 1	1	0.90	—	—	0.43	0.26	0.33	0.04
77DV	0 26715 10631 8	1	0.90	—	—	0.43	0.26	0.33	0.04
77DW	0 26715 10630 1	1	0.90	—	—	0.43	0.26	0.33	0.04
77DV	0 26715 10631 8	1	0.90	—	—	0.43	0.26	0.33	0.04
78V	0 26715 07888 2	1	0.90	—	—	0.43	0.26	0.33	0.04
78W	0 26715 07889 9	1	0.90	—	—	0.43	0.26	0.33	0.04
791LEDM	0 26715 23955 9	1	9.90	—	—	1.24	0.90	1.25	1.40
79V	0 26715 07890 5	1	0.30	—	—	0.43	0.26	0.33	0.04
79W	0 26715 07891 2	1	0.40	—	—	0.43	0.24	0.33	0.03
804DD	7 84891 27013 0	1	0.20	24	4.80	0.33	0.33	0.13	0.01
804DU	7 84891 27039 0	1	6.20	—	—	0.69	0.68	2.58	1.21
804QDD	0 26715 23484 4	1	0.40	—	—	0.42	0.42	0.23	0.04
80L	0 26715 17226 9	1	0.40	—	—	0.27	0.22	0.50	0.03
80RDF	0 26715 14612 3	—	—	4	17.50	1.83	0.99	1.03	1.87
8210	7 84891 21210 9	1	6.30	—	—	0.94	0.73	0.95	0.66
82W	0 26715 23034 1	1	0.32	—	—	0.37	0.18	0.19	0.01
83	0 26715 02241 0	1	0.30	—	—	0.43	0.25	0.31	0.03
8310	7 84891 21310 6	1	7.70	—	—	1.26	0.63	1.03	0.82
834	7 84891 99161 5	1	0.20	6	1.20	0.88	0.88	0.06	0.04
84	0 26715 02243 4	1	2.80	—	—	1.13	0.89	0.40	0.40
843BL	0 26715 16460 8	1	2.90	—	—	0.79	0.78	0.66	0.41
85	0 26715 02244 1	1	5.40	—	—	1.90	1.56	0.39	1.16
854	7 84891 99282 7	—	—	6	2.63	1.11	1.08	0.31	0.37
8663RP	7 84891 21615 2	1	11.70	—	—	1.40	0.83	1.40	1.62
8664RP	7 84891 21625 1	1	11.70	—	—	1.38	0.81	1.38	1.54
877	7 84891 27570 8	1	1.30	—	—	0.90	0.67	0.73	0.44
87W	0 26715 25037 0	1	18.00	50	900.00	1.50	1.25	0.79	1.48
883001	0 26715 01093 6	1	31.00	—	—	2.67	1.00	1.83	4.89
883002	0 26715 14236 1	1	31.30	—	—	2.67	1.83	1.00	4.89
883004	0 26715 01094 3	1	30.20	—	—	2.75	1.04	1.88	5.37
883008	0 26715 01095 0	1	32.10	—	—	2.67	1.83	1.00	4.89
883011	0 26715 02382 0	1	31.70	—	—	2.75	1.00	1.83	5.04
883023	0 26715 01106 3	1	31.60	—	—	2.67	1.83	1.00	4.89
883601	0 26715 01099 8	1	34.60	—	—	3.17	1.83	1.00	5.81
883604	0 26715 01100 1	1	33.30	—	—	3.17	1.83	1.00	5.81
883608	0 26715 01101 8	1	34.30	—	—	3.17	1.83	1.00	5.81
883623	0 26715 02384 4	1	33.40	—	—	3.25	1.83	1.00	5.96
883901	0 26715 10692 9	1	34.90	—	—	3.48	1.03	1.84	6.56
883904	0 26715 10693 6	1	32.50	—	—	3.48	1.03	1.84	6.56
884201	0 26715 02385 1	1	36.10	—	—	3.72	1.09	1.86	7.54
884204	0 26715 02386 8	1	35.80	—	—	3.77	1.03	1.86	7.23
884223	0 26715 02392 9	1	34.50	—	—	3.71	1.04	1.83	7.08
884									

Model	UPC Code	Std. Carton		Master Carton		Length	Width	Height	Cube
		Pk.	Wt.	Pk.	Wt.				
894223	0 26715 08251 3	1	35.50	—	—	3.72	1.05	1.86	7.25
894801	0 26715 08248 3	1	38.50	—	—	4.23	1.03	1.88	8.12
894804	0 26715 02396 7	1	37.80	—	—	4.21	1.03	1.88	8.09
90	0 26715 02249 6	1	0.35	—	—	0.40	0.40	0.29	0.05
9093WH	7 84891 32194 8	1	20.30	—	—	1.51	0.98	1.48	2.20
9412D	7 84891 32600 4	1	5.30	—	—	1.14	0.90	0.61	0.63
9417DN	7 84891 32594 6	1	7.40	—	—	1.05	0.90	0.63	0.59
9422P	7 84891 32648 6	1	7.50	—	—	1.37	0.92	0.59	0.74
9427P	7 84891 32649 3	1	9.00	—	—	1.38	1.04	0.62	0.88
961L	0 26715 13188 4	1	2.10	—	—	1.06	1.05	0.18	0.20
97	0 26715 03890 9	1	1.60	—	—	0.68	0.68	0.71	0.33
9810WH	7 84891 32811 4	1	9.80	—	—	1.13	0.48	1.43	0.77
9815WH	7 84891 32816 9	1	9.80	—	—	1.44	0.46	1.12	0.74
981L	0 26715 12471 8	1	1.60	—	—	1.06	1.05	0.18	0.19
982L	0 26715 12472 5	1	2.90	—	—	1.84	1.04	0.19	0.37
983L	0 26715 12473 2	1	3.60	—	—	1.86	1.53	0.18	0.50
9905	7 84891 32830 5	1	12.50	—	—	1.58	1.16	0.99	1.82
9960	7 84891 32840 4	1	12.90	—	—	1.58	1.17	1.02	1.87
9965	7 84891 32850 3	1	14.80	—	—	1.58	1.16	1.01	1.85
A000HF	0 26715 23611 4	—	—	4	11.30	1.95	0.97	1.07	2.01
A000HFS	0 26715 24930 5	—	—	4	13.00	1.93	0.97	1.08	2.00
A000HL	0 26715 23662 6	—	—	4	11.55	1.94	0.96	1.08	2.00
A110	0 26715 23653 4	1	8.90	—	—	1.11	1.11	0.92	1.13
A110F	0 26715 23660 2	—	—	4	23.15	2.22	1.04	1.25	2.89
A110L	0 26715 23533 9	1	9.61	—	—	1.10	1.10	1.04	1.27
A50L	0 26715 23648 0	1	9.36	—	—	1.10	1.10	1.04	1.27
A70L	0 26715 23649 7	1	9.56	—	—	1.10	1.10	1.04	1.27
A70LF	0 26715 23656 5	—	—	4	26.50	2.21	1.04	1.75	4.03
A80	0 26715 23651 0	1	8.75	—	—	1.11	1.11	0.92	1.13
A80F	0 26715 23657 2	—	—	4	22.40	2.21	1.04	1.25	2.88
A80HD	0 26715 23652 7	1	9.45	—	—	1.11	1.11	0.92	1.13
A80HDF	0 26715 23658 9	—	—	4	25.30	2.22	1.04	1.25	2.89
A80L	0 26715 23531 5	1	9.61	—	—	1.10	1.10	1.04	1.27
ACCGSEF2	0 26715 15658 0	1	0.20	—	—	0.70	0.39	0.15	0.04
ACCGSFF2	0 26715 15255 1	1	0.20	—	—	0.77	0.40	0.15	0.05
ACCGSFH	0 26715 15253 7	1	2.90	—	—	1.69	1.62	0.20	0.55
ACCGSFHP10	0 26715 15260 5	1	33.90	—	—	2.21	1.77	1.70	6.63
ACCGSFHP2	0 26715 15254 4	1	3.20	—	—	1.69	1.62	0.21	0.57
ACCGSFP2	0 26715 15252 0	1	0.91	—	—	1.67	1.31	0.06	0.14
ACCGSFP20	0 26715 15259 9	1	10.10	—	—	1.75	1.38	0.62	1.48
ACCGSUHD	0 26715 15257 5	1	2.00	—	—	0.96	0.81	0.88	0.68
ACCGSUP5	0 26715 15256 8	1	0.50	—	—	0.68	0.53	0.40	0.14
ACCHEPAPFK	0 26715 22860 7	1	0.50	—	—	0.96	0.21	1.08	0.22
ACCHEPARF	0 26715 22859 1	1	1.20	—	—	0.96	0.21	1.08	0.22
ACCWVK	0 26715 22858 4	1	1.55	—	—	2.06	0.21	0.17	0.07
AE110	0 26715 23529 2	1	8.80	—	—	1.11	1.11	0.92	1.13
AE110F	0 26715 23607 7	—	—	4	22.80	2.23	1.04	1.25	2.90
AE110L	0 26715 23666 4	1	9.07	—	—	1.13	1.10	0.92	1.13
AE110LF	0 26715 24188 0	—	—	4	24.00	2.21	1.03	1.26	2.87
AE110S	0 26715 24928 2	1	9.50	—	—	1.13	1.11	0.92	1.15
AE110SL	0 26715 24929 9	1	9.80	—	—	1.13	1.11	0.92	1.15
AE50	0 26715 23646 6	1	8.60	—	—	1.11	1.11	0.92	1.13
AE50F	0 26715 23655 8	—	—	4	22.10	2.23	1.04	1.26	2.92
AE60	0 26715 10573 1	1	31.60	—	—	2.19	1.10	1.39	3.36
AE80	0 26715 23527 8	1	8.75	—	—	1.11	1.11	0.92	1.13
AE80B	0 26715 23600 8	1	8.75	—	—	1.11	1.11	0.92	1.13
AE80BF	0 26715 23609 1	—	—	4	22.50	2.23	1.04	1.25	2.90
AE80BL	0 26715 23957 3	1	9.16	—	—	1.10	1.10	0.88	1.08
AE80BLF	0 26715 23958 0	—	—	4	24.03	2.21	1.04	1.23	2.83
AE80F	0 26715 23605 3	—	—	4	22.40	2.21	1.04	1.25	2.88
AE80L	0 26715 23664 0	1	9.00	—	—	1.13	1.10	0.92	1.13
AE80LF	0 26715 23668 8	—	—	4	24.05	2.20	1.03	1.26	2.86
AE80S	0 26715 24926 8	1	9.40	—	—	1.13	1.11	0.92	1.15
AE80SL	0 26715 24927 5	1	9.70	—	—	1.11	1.11	0.92	1.13
AE60302SS	0 26715 18645 7	1	12.30	—	—	3.72	2.26	0.42	3.50
AE60362SS	0 26715 18646 4	1	11.90	—	—	3.70	2.26	0.42	3.48
AE60422SS	0 26715 18647 1	1	13.90	—	—	4.67	2.25	0.42	4.37
AE60482SS	0 26715 18648 8	1	14.00	—	—	4.67	2.25	0.42	4.37
AEPD18SS	0 26715 20409 0	1	16.45	—	—	2.38	1.38	1.90	6.24
AEPD18SSE	0 26715 20412 0	1	14.60	—	—	2.17	1.33	1.50	4.33
AEPD2445SS	0 26715 22743 3	1	35.80	—	—	2.42	1.38	2.38	7.94

Model	UPC Code	Std. Carton		Master Carton		Length	Width	Height	Cube
		Pk.	Wt.	Pk.	Wt.				
AEEP2445SSE	0 26715 22744 0	1	33.00	—	—	2.04	1.40	2.17	6.17
AEEP30SS	0 26715 20410 6	1	24.10	—	—	2.90	1.38	2.38	9.53
AEEP30SSE	0 26715 20413 7	1	22.30	—	—	2.53	1.37	2.21	7.65
AEEP6SS	0 26715 20408 3	1	5.60	—	—	2.19	0.55	1.11	1.34
AEEP6SSE	0 26715 20411 3	1	6.00	—	—	2.21	0.54	1.38	1.64
AEN110	0 26715 23530 8	1	8.80	—	—	1.11	1.11	0.92	1.13
AEN110F	0 26715 23608 4	—	—	4	22.90	2.22	1.04	1.25	2.89
AEN110L	0 26715 23667 1	1	9.35	—	—	1.13	1.10	0.92	1.13
AEN50	0 26715 23647 3	1	8.60	—	—	1.11	1.11	0.92	1.13
AEN50F	0 26715 23683 1	—	—	4	21.75	2.22	1.04	1.25	2.89
AEN80	0 26715 23528 5	1	8.75	—	—	1.11	1.11	0.92	1.13
AEN80B	0 26715 23601 5	1	8.75	—	—	1.11	1.11	0.92	1.13
AEN80BF	0 26715 23610 7	—	—	4	22.40	2.21	1.04	1.25	2.88
AEN80BL	0 26715 23959 7	1	9.26	—	—	1.10	1.10	0.90	1.09
AEN80BLF	0 26715 23960 3	—	—	4	24.03	2.21	1.04	1.23	2.83
AEN80F	0 26715 23606 0	—	—	4	22.40	2.21	1.04	1.25	2.88
AEN80L	0 26715 23665 7	1	9.10	—	—	1.13	1.10	0.92	1.13
AEN80LF	0 26715 23669 5	—	—	4	24.20	2.21	1.04	1.23	2.83
AN000HF	0 26715 23612 1	—	—	4	11.30	1.95	0.97	1.07	2.01
AN000HL	0 26715 23663 3	—	—	4	11.55	1.95	0.97	1.08	2.03
AN110	0 26715 23654 1	1	8.90	—	—	1.11	1.11	0.92	1.13
AN110F	0 26715 23661 9	—	—	4	22.90	2.22	1.04	1.25	2.89
AN110L	0 26715 23534 6	1	9.61	—	—	1.10	1.10	1.04	1.27
AN70L	0 26715 23650 3	1	9.61	—	—	1.10	1.10	1.04	1.27
AN70LF	0 26715 23684 8	—	—	4	26.50	2.21	1.04	1.75	4.03
AN80HDF	0 26715 23659 6	—	—	4	25.30	2.22	1.04	1.25	2.89
AN80L	0 26715 23532 2	1	9.61	—	—	1.10	1.10	1.04	1.27
ANKE60302SS	0 26715 18641 9	1	12.00	—	—	3.68	2.27	0.42	3.48
ANKE60362SS	0 26715 18642 6	1	12.50	—	—	3.68	2.27	0.43	3.55
ANKE60422SS	0 26715 18643 3	1	16.50	—	—	4.67	2.25	0.42	4.37
ANKE60482SS	0 26715 18644 0	1	16.80	—	—	4.67	2.25	0.42	4.37
AP130BL	0 26715 17586 4	1	31.10	—	—	2.71	1.04	2.06	5.81
AP130SS	0 26715 17584 0	1	32.00	—	—	2.70	1.03	2.04	5.65
AP130WW	0 26715 17585 7	1	34.00	—	—	2.68	1.03	2.04	5.66
AP136BL	0 26715 17589 5	1	35.30	—	—	3.19	1.03	2.06	6.73
AP136SS	0 26715 17587 1	1	34.10	—	—	3.21	1.03	2.04	6.77
AP136WW	0 26715 17588 8	1	34.50	—	—	3.18	1.03	2.07	6.74
APE130SS	0 26715 19721 7	1	33.40	—	—	2.70	1.03	2.05	5.72
ARP310	0 26715 18222 0	—	—	5	1.25	0.68	0.52	0.40	0.14
ARP314	0 26715 18223 7	—	—	5	1.56	0.68	0.53	0.38	0.13
ARP6	0 26715 18224 4	—	—	5	1.88	0.68	0.51	0.39	0.13
AVDOFNP	7 84891 71271 5	1	16.10	—	—	1.85	4.73	0.25	2.19
AVDORPN	7 84891 71273 9	1	23.00	—	—	1.96	5.25	0.23	2.36
AVDSMN	7 84891 71304 0	1	7.20	—	—	4.33	0.42	0.17	0.30
AVDWRPN	7 84891 71274 6	1	15.80	—	—	1.85	4.75	0.25	2.20
AWEPD36SS	0 26715 20414 4	1	16.00	—	—	3.29	1.77	0.42	2.43
AWEPD48SS	0 26715 20415 1	1	19.00	—	—	4.31	1.77	0.40	3.02
AWEPD60SS	0 26715 24006 7	1	22.60	—	—	1.78	5.36	0.38	3.57
B12LCDARNW	0 26715 24298 6	1	269.00	—	—	3.15	3.67	2.50	28.84
B12LCDASNW	0 26715 24296 2	1	279.00	—	—	3.54	4.38	2.31	35.83
B12LCDPRNC	0 26715 24308 2	1	268.00	—	—	3.53	4.38	2.29	35.34
B12LCDPRNW	0								

Model	UPC Code	Std. Carton		Master Carton		Length	Width	Height	Cube
		Pk.	Wt.	Pk.	Wt.				
BD6	0 26715 05776 4	1	3.20	—	—	1.52	0.77	0.79	0.92
BK105	7 84891 03001 7	—	—	24	27.00	1.77	1.13	0.84	1.67
BK110NBWH	7 84891 03003 1	—	—	24	48.00	1.08	1.07	1.79	2.07
BK115LWH	7 84891 03005 5	—	—	24	48.00	1.12	1.06	1.76	2.08
BK120NBWH	7 84891 03004 8	—	—	24	48.00	1.08	1.07	1.79	2.07
BK125LWH	7 84891 03006 2	—	—	24	48.00	1.07	1.07	1.75	1.99
BK131LPB	7 84891 03009 3	—	—	24	48.00	1.77	1.08	1.12	2.12
BK131LRBZ	7 84891 03012 3	—	—	6	12.37	1.04	0.61	0.89	0.57
BK131LSN	7 84891 03011 6	—	—	6	12.37	1.05	0.63	0.92	0.60
BK131LWH	7 84891 03010 9	—	—	6	12.75	1.04	0.61	0.91	0.58
BK140LWH	7 84891 03013 0	—	—	24	45.00	1.56	0.88	1.33	1.82
BK140SLPB	7 84891 03015 4	—	—	24	45.60	1.56	0.88	1.32	1.80
BK142LWH	7 84891 03014 7	—	—	24	46.10	1.57	0.88	1.33	1.83
BK144LCL	7 84891 03002 4	—	—	24	48.00	1.09	1.07	1.83	2.13
BK147LWH	7 84891 03016 1	—	—	24	64.70	1.93	1.21	1.19	2.78
BP1	0 26715 02401 8	—	—	15	4.69	1.24	0.53	1.03	0.68
BP10	0 26715 03253 2	—	—	8	1.50	0.94	0.41	0.85	0.33
BP11	0 26715 03254 9	—	—	8	1.50	1.07	0.40	0.83	0.35
BP17	0 26715 04013 1	—	—	4	8.25	1.14	0.76	1.09	0.95
BP18	0 26715 04014 8	—	—	4	9.00	1.13	0.77	1.09	0.95
BP19	0 26715 04059 9	—	—	4	7.50	1.13	0.78	1.08	0.95
BP2	0 26715 02402 5	—	—	12	4.50	1.51	0.56	1.02	0.86
BP20	0 26715 04060 5	—	—	6	2.63	0.95	0.56	0.93	0.49
BP24	0 26715 04485 6	—	—	15	6.56	0.96	0.56	0.93	0.49
BP25	0 26715 04486 3	—	—	6	2.25	0.81	0.73	0.54	0.32
BP27	0 26715 04488 7	—	—	6	8.25	1.10	0.58	1.01	0.65
BP28	0 26715 04489 4	—	—	6	11.63	1.09	0.59	1.01	0.65
BP29	0 26715 04988 2	—	—	6	1.13	1.03	0.82	0.22	0.18
BP33	0 26715 05436 7	—	—	6	2.63	0.94	0.56	0.93	0.49
BP34	0 26715 05438 1	—	—	6	2.63	0.94	0.56	0.93	0.49
BP35	0 26715 05440 4	—	—	12	7.50	1.03	0.84	1.02	0.88
BP36	0 26715 05442 8	—	—	5	1.88	0.82	0.73	0.55	0.33
BP38	0 26715 05446 6	—	—	10	5.00	0.94	0.55	0.92	0.47
BP4	0 26715 03135 1	—	—	12	2.25	0.94	0.93	0.71	0.62
BP43	0 26715 04990 5	—	—	12	2.25	1.13	0.76	1.08	0.92
BP436	0 26715 23500 1	—	—	6	1.30	1.23	0.92	0.50	0.57
BP46	0 26715 07167 8	—	—	12	3.75	0.94	0.55	0.93	0.48
BP5	0 26715 03136 8	—	—	4	1.00	1.03	0.23	0.81	0.19
BP50	0 26715 07997 1	—	—	6	9.00	1.08	0.58	1.02	0.64
BP51	0 26715 07998 8	—	—	6	11.63	1.08	0.60	1.03	0.67
BP52	0 26715 07999 5	—	—	4	8.50	1.13	0.76	1.10	0.95
BP55	0 26715 08259 9	—	—	8	1.50	1.06	0.39	0.82	0.34
BP56	0 26715 08260 5	—	—	8	1.50	0.94	0.39	0.85	0.31
BP57	0 26715 10749 0	—	—	8	3.00	1.24	0.55	1.05	0.72
BP58	0 26715 10750 6	—	—	8	1.50	0.96	0.56	0.92	0.49
BP7	0 26715 03138 2	—	—	8	2.00	1.10	0.41	0.98	0.44
BP87	0 26715 04989 9	—	—	3	1.31	0.82	0.73	0.32	0.19
BP87Q	0 26715 20177 8	—	—	3	0.94	0.81	0.73	0.33	0.20
BP90	0 26715 16744 9	—	—	4	1.50	0.85	0.84	0.20	0.14
BP91	0 26715 19975 4	—	—	4	3.25	1.08	0.58	1.01	0.64
BPAPFA	0 26715 17857 5	—	—	3	1.88	1.04	1.04	0.23	0.25
BPP2FA30	0 26715 17728 8	1	1.50	—	—	1.46	1.19	0.10	0.18
BPP2FA36	0 26715 17730 1	1	1.80	—	—	1.44	1.24	0.10	0.18
BPP2FA42	0 26715 19280 9	1	1.90	—	—	1.25	1.46	0.15	0.27
BPP3FA30	0 26715 19281 6	1	1.65	—	—	1.44	1.21	0.10	0.18
BPP3FA36	0 26715 19282 3	1	1.90	—	—	1.43	1.27	0.11	0.20
BPP3FA42	0 26715 19283 0	1	2.10	—	—	1.46	1.22	0.13	0.24
BPPF30	0 26715 17725 7	—	—	6	3.00	1.40	1.04	0.43	0.62
BPPF36	0 26715 17726 4	—	—	3	2.04	1.42	1.30	0.23	0.43
BPPF42	0 26715 19420 9	1	1.00	—	—	1.46	1.20	0.11	0.19
BPPFA30	0 26715 17727 1	—	—	3	3.38	1.44	0.26	1.08	0.40
BPPFA36	0 26715 17729 5	—	—	3	3.94	1.44	0.26	1.28	0.48
BPPFA42	0 26715 19421 6	1	1.80	—	—	1.47	1.20	0.14	0.25
BPQDE30	0 26715 18227 5	—	—	3	3.75	1.26	1.25	0.34	0.54
BPQTAF	0 26715 13384 0	—	—	4	1.25	1.11	1.00	0.22	0.24
BPQTAF	0 26715 13383 3	—	—	4	1.50	1.12	1.00	0.22	0.24
BPRPFA	0 26715 17733 2	—	—	3	1.69	1.06	1.04	0.23	0.26
BPS1FA30	0 26715 13816 6	—	—	3	2.06	1.27	1.06	0.28	0.37
BPS1FA36	0 26715 13817 3	—	—	3	2.25	1.53	0.29	1.06	0.47
BPS2FA30	0 26715 13818 0	—	—	6	4.13	1.28	0.45	1.08	0.62
BPS2FA36	0 26715 13865 4	—	—	6	4.40	1.53	0.44	1.08	0.73

Model	UPC Code	Std. Carton		Master Carton		Length	Width	Height	Cube
		Pk.	Wt.	Pk.	Wt.				
BPS3FA30	0 26715 13867 8	—	—	6	6.38	1.28	0.45	1.08	0.62
BPS3FA36	0 26715 13868 5	—	—	6	7.88	1.53	0.45	1.07	0.73
BPSF30	0 26715 13813 5	—	—	4	2.00	1.28	1.05	0.28	0.37
BPSF36	0 26715 13814 2	—	—	4	2.25	1.53	1.05	0.28	0.44
BPSF42	0 26715 13815 9	—	—	8	4.50	1.81	0.54	1.07	1.04
C350BN	0 26715 17883 4	1	1.85	—	—	0.77	0.29	0.63	0.14
C350GN	0 26715 17885 8	—	—	4	1.75	0.83	0.82	0.25	0.17
C370BN	0 26715 17884 1	1	2.35	—	—	0.77	0.29	0.63	0.14
C905	0 26715 02482 7	—	—	6	5.63	0.77	0.28	0.42	0.09
C907	0 26715 07128 9	—	—	6	12.00	0.77	0.34	0.46	0.12
C909	0 26715 07129 6	—	—	6	7.20	0.76	0.29	0.42	0.09
C915	7 84891 07130 0	—	—	6	6.00	0.72	0.38	0.50	0.13
CA130	7 84891 98190 6	1	1.20	12	14.40	1.98	0.27	0.27	0.14
CF328	7 84891 77410 2	1	0.10	20	2.00	0.08	0.19	0.36	0.01
CF329	7 84891 77411 9	1	0.20	20	4.00	0.39	0.34	0.10	0.01
CF361	7 84891 77412 6	1	0.20	20	4.00	0.46	0.23	0.15	0.02
CF361F	7 84891 77426 3	1	0.30	20	6.00	0.44	0.21	0.12	0.01
CF362	7 84891 77413 3	1	0.10	20	2.00	0.25	0.19	0.25	0.01
CF363	7 84891 77414 0	1	0.16	10	1.60	0.31	0.19	0.21	0.01
CF364	7 84891 77415 7	1	0.16	—	—	0.28	0.19	0.24	0.01
CF365	7 84891 77416 4	1	0.20	10	2.00	0.28	0.19	0.25	0.01
CF366	7 84891 77417 1	1	0.10	10	1.00	0.20	0.20	0.08	0.00
CF367	7 84891 77418 8	—	—	6	6.90	3.07	0.45	0.68	0.94
CF368	7 84891 77419 5	1	0.10	20	2.00	0.39	0.25	0.20	0.02
CF369	7 84891 77429 4	1	0.10	20	2.00	0.18	0.21	0.27	0.01
CF372	0 26715 23014 3	1	0.15	25	3.75	0.21	0.25	0.17	0.01
CF377	7 84891 77431 7	1	0.22	20	4.40	0.36	0.36	0.19	0.02
CF380	7 84891 77258 0	1	0.03	20	0.60	0.30	0.19	0.06	0.00
CF382	7 84891 77433 1	1	0.15	20	3.00	0.29	0.29	0.19	0.02
CF382S	7 84891 77434 8	1	0.11	10	1.10	0.24	0.24	0.19	0.01
CF382XS	7 84891 77436 2	1	0.10	10	1.00	0.23	0.20	0.19	0.01
CF383	7 84891 77422 5	1	0.22	20	4.40	0.39	0.37	0.19	0.03
CF384	7 84891 77438 6	1	0.23	10	2.30	0.46	0.32	0.19	0.03
CF385	7 84891 77440 9	1	0.09	20	1.80	0.24	0.19	0.23	0.01
CF386	7 84891 77442 3	1	0.08	10	0.80	0.22	0.19	0.21	0.01
CF387	7 84891 77444 7	1	0.19	10	1.90	0.38	0.35	0.19	0.02
CF388	7 84891 77446 1	1	0.05	—	—	0.18	0.18	0.13	0.00
CF389	7 84891 77448 5	1	0.01	10	0.10	0.18	0.18	0.08	0.00
CF3918	7 84891 77449 2	1	0.55	6	3.30	0.85	0.67	0.10	0.06
CFC56BR	0 26715 19726 2	1	18.50	—	—	2.29	0.75	0.89	1.53
CFC56WH	0 26715 19725 5	1	18.40	—	—	2.29	0.74	0.90	1.53
CFH52BS	0 26715 19622 7	1	14.80	—	—	1.63	1.00	0.62	1.01
CFH52RB	0 26715 19623 4	1	15.50	—	—	1.65	1.00	0.63	1.03
CFH52WH	0 26715 19620 3	1	15.20	—	—	1.64	0.61	1.00	1.00
CFOS2BO	0 26715 19625 8	1	17.50	—	—	1.73	0.93	0.97	1.54
CFOS2WB	0 26715 19626 5	1	17.40	—	—	1.73	0.93	0.98	1.57
CFOS2WH	0 26715 19624 1	1	17.70	—	—	1.72	0.93	0.97	1.53
CFSS2BS	0 26715 19618 0	1	17.50	—	—	1.76	0.83	0.89	1.29
CFSS2RB	0 26715 19619 7	1	17.50	—	—	1.76	0.82	0.86	1.23
CFSS2WH	0 26715 19616 6	1	17.70	—	—	1.77	0.82	0.87	1.25
CFSABR	0 26715 19942 6	1	2.00	20	40.00	0.49	0.52	0.33	0.08

Model	UPC Code	Std. Carton		Master Carton		Length	Width	Height	Cube
		Pk.	Wt.	Pk.	Wt.				
CI399ALM	0 26715 25123 0	1	0.25	32	8.00	0.44	0.30	0.16	0.02
CI399EB	0 26715 25122 3	1	0.05	200	10.00	0.18	0.10	0.07	0.00
CI399RK	0 26715 25121 6	1	0.25	25	6.25	0.57	0.40	0.13	0.03
CI399W	0 26715 25120 9	1	0.25	32	8.00	0.44	0.30	0.16	0.02
CK110	7 84891 98324 5	1	2.20	6	13.20	1.66	0.73	0.18	0.21
CK135	7 84891 98352 8	1	1.13	25	28.25	2.13	0.38	0.13	0.10
CS100	0 26715 23613 8	1	8.45	—	—	2.00	1.32	0.83	2.17
CS200	0 26715 23614 5	1	3.95	—	—	2.20	0.86	0.32	0.61
CS300	0 26715 23615 2	1	17.00	—	—	1.54	1.21	2.67	4.97
CS400	0 26715 23616 9	1	19.10	—	—	1.54	1.21	2.67	4.97
CS500	0 26715 23617 6	1	25.65	—	—	1.54	1.21	2.67	4.97
CS600	0 26715 23618 3	1	25.20	—	—	1.54	1.21	2.67	4.97
CT105	0 26715 23634 3	1	0.12	50	6.00	0.47	0.25	0.21	0.02
CT106G	7 84891 77031 9	1	0.19	50	9.50	0.69	0.38	0.18	0.05
CT109	0 26715 23632 9	1	0.15	50	7.50	0.47	0.25	0.19	0.02
CT110	0 26715 23633 6	1	0.17	50	8.50	1.14	0.47	0.13	0.07
CT132	7 84891 77033 3	1	0.95	25	23.75	1.52	0.50	0.11	0.08
CT140G	7 84891 98353 5	1	1.45	12	17.40	0.94	0.79	0.26	0.19
CT143B	7 84891 77034 0	1	0.40	30	12.00	0.83	0.22	0.17	0.03
CT150B	7 84891 98354 2	1	0.94	12	11.28	1.08	0.77	0.25	0.21
CT156B	7 84891 77971 8	1	1.10	12	13.20	1.22	0.30	0.54	0.20
CT157B	7 84891 77972 5	1	0.90	12	10.80	1.22	0.30	0.58	0.21
CT158	0 26715 23635 0	1	0.64	21	13.44	1.07	0.46	0.29	0.14
CT170	0 26715 19316 5	1	2.10	20	42.00	2.33	0.21	0.33	0.16
CT175	0 26715 19317 2	1	1.80	20	36.00	2.33	0.21	0.33	0.16
CT350B	7 84891 77976 3	1	2.00	12	24.00	1.04	0.33	0.92	0.32
CT700	0 26715 19315 8	1	7.00	6	42.00	0.35	1.17	1.42	0.58
CVG4	7 84891 99490 6	1	0.29	6	1.74	0.52	0.52	0.23	0.06
CVG6	7 84891 27070 3	1	0.50	6	3.00	0.63	0.63	0.25	0.10
CVL4	7 84891 99491 3	1	0.60	6	3.60	0.83	0.42	0.33	0.12
CVL5	7 84891 99493 7	1	0.80	6	4.80	0.83	0.42	0.42	0.14
CVL6	7 84891 99495 1	1	0.80	6	4.80	0.83	0.50	0.50	0.21
CVLD4	7 84891 27095 6	1	0.60	6	3.60	0.33	0.33	0.34	0.04
CVLD6	7 84891 27101 4	1	0.80	6	4.80	0.45	0.52	0.24	0.06
CWT45	0 26715 21036 7	1	0.10	—	—	0.42	0.31	0.21	0.03
D100	0 26715 02550 3	1	0.80	—	—	1.11	0.78	0.07	0.06
D101	0 26715 02424 7	1	0.90	—	—	1.17	0.81	0.06	0.06
DC4	0 26715 13506 6	—	—	6	1.65	0.95	0.45	0.81	0.35
DH100W	0 55321 80021 1	1	0.60	—	—	0.45	0.26	0.33	0.04
DR12OBQ	0 26715 19667 8	1	0.50	—	—	1.00	0.08	0.07	0.00
DR12OWB	0 26715 19671 5	1	0.60	—	—	1.00	0.08	0.07	0.01
DR12OWH	0 26715 19663 0	1	0.50	—	—	1.00	0.07	0.07	0.00
DR12RB	0 26715 19655 5	1	0.50	—	—	1.00	0.08	0.08	0.01
DR12WH	0 26715 19645 6	1	0.50	—	—	1.00	0.08	0.08	0.01
DR18OBQ	0 26715 19668 5	1	1.00	—	—	1.50	0.08	0.07	0.01
DR18OWB	0 26715 19672 2	1	0.90	—	—	1.50	0.08	0.07	0.01
DR18RB	0 26715 19656 2	1	0.90	—	—	1.50	0.08	0.08	0.01
DR18WH	0 26715 19646 3	1	1.00	—	—	1.50	0.08	0.08	0.01
DR1BA	7 84891 99384 8	1	0.80	6	4.80	0.52	0.15	0.15	0.01
DR1SA	7 84891 99385 5	1	0.80	6	4.80	0.52	0.15	0.15	0.01
DR24BR	0 26715 19660 9	1	1.40	—	—	2.00	0.08	0.08	0.01
DR24OBQ	0 26715 19669 2	1	1.00	—	—	2.02	0.08	0.08	0.01
DR24OWB	0 26715 19673 9	1	1.20	—	—	2.00	0.08	0.07	0.01
DR24RB	0 26715 19657 9	1	1.30	—	—	2.00	0.08	0.08	0.01
DR24WH	0 26715 19647 0	1	1.20	—	—	2.00	0.08	0.08	0.01
DR2SA	7 84891 12234 7	1	1.10	—	—	0.51	0.18	0.42	0.04
DR36BR	0 26715 19661 6	1	1.90	—	—	3.00	0.08	0.08	0.02
DR36BS	0 26715 19653 1	1	2.00	—	—	3.00	0.08	0.08	0.02
DR36OBQ	0 26715 19670 8	1	2.00	—	—	3.00	0.08	0.07	0.01
DR36OWB	0 26715 19674 6	1	1.90	—	—	3.00	0.08	0.08	0.02
DR36RB	0 26715 19658 6	1	1.90	—	—	3.00	0.08	0.08	0.02
DR36WH	0 26715 19648 7	1	2.00	—	—	3.03	0.08	0.08	0.02
DR48BR	0 26715 19662 3	1	2.70	—	—	4.02	0.08	0.08	0.03
DR48BS	0 26715 19654 8	1	2.60	—	—	4.00	0.08	0.08	0.02
DR48RB	0 26715 19659 3	1	2.60	—	—	4.00	0.08	0.08	0.02
DR48WH	0 26715 19649 4	1	2.70	—	—	4.02	0.08	0.08	0.03
DT4C	0 55321 16070 4	—	—	4	8.00	0.90	0.86	0.88	0.68
DT4W	0 55321 16067 4	1	6.15	—	—	2.25	0.71	0.71	1.13
DT6C	0 55321 16071 1	1	2.40	—	—	0.88	0.65	0.61	0.35
DT6W	0 55321 16068 1	1	8.10	—	—	2.46	0.84	0.81	1.67
E5490SS	0 26715 17438 6	1	87.00	—	—	3.38	2.75	1.88	17.40
E6030SS	0 26715 18624 2	1	70.00	—	—	3.51	2.00	2.79	19.59
E6036SS	0 26715 18625 9	1	74.00	—	—	3.51	2.00	2.79	19.59
E6042TSS	0 26715 18626 6	1	94.00	—	—	4.51	2.00	2.79	25.17
E6048TSS	0 26715 18627 3	1	96.00	—	—	4.53	2.00	2.79	25.26
E60E30SS	0 26715 18628 0	1	96.00	—	—	2.00	3.52	2.79	19.66
E60E36SS	0 26715 18629 7	1	67.00	—	—	3.51	2.00	2.79	19.59
E60E42SS	0 26715 18630 3	1	77.50	—	—	4.53	2.00	2.79	25.26
E60E48SS	0 26715 18631 0	1	82.00	—	—	4.53	2.00	2.79	25.26
E6430SS	0 26715 18632 7	1	43.60	—	—	3.32	1.13	2.23	8.33
E6436SS	0 26715 18633 4	1	46.90	—	—	3.30	1.13	2.18	8.17
E6442SS	0 26715 18634 1	1	53.40	—	—	4.32	1.15	2.25	11.17
E6448SS	0 26715 18635 8	1	55.50	—	—	4.33	1.15	2.23	11.13
E6448TSS	0 26715 18636 5	1	65.40	—	—	4.29	1.14	2.25	11.02
E64E30SS	0 26715 18637 2	1	35.60	—	—	3.31	1.13	2.25	8.37
E64E36SS	0 26715 18638 9	1	38.80	—	—	3.31	1.15	2.25	8.56
E64E42SS	0 26715 18639 6	1	44.90	—	—	4.29	1.15	2.25	11.10
E64E48SS	0 26715 18640 2	1	48.30	—	—	1.15	4.32	2.25	11.17
E66130BL	0 26715 16759 3	1	34.30	—	—	3.03	0.67	2.07	4.17
E66130SS	0 26715 16754 8	1	32.10	—	—	3.02	0.67	2.07	4.16
E66130WH	0 26715 16757 9	1	34.00	—	—	3.03	0.65	2.06	4.05
E66136BL	0 26715 16760 9	1	37.90	—	—	3.51	0.65	2.06	4.69
E66136SS	0 26715 16755 5	1	36.60	—	—	3.52	0.68	2.07	4.97
E66136WH	0 26715 16758 6	1	37.40	—	—	3.53	0.65	2.05	4.70
E66142SS	0 26715 16756 2	1	39.00	—	—	4.02	0.64	2.06	5.30
EH6	0 26715 05779 5	1	2.50	—	—	1.58	0.81	0.80	1.02
EI5936SS	0 26715 19491 9	1	88.00	—	—	3.27	2.44	1.80	14.36
EP300108	0 26715 06289 8	—	—	4	6.50	2.75	2.28	0.07	0.42
EP300223	0 26715 14094 7	—	—	4	6.00	2.75	2.29	0.07	0.42
EPD6136SS	0 26715 20406 9	1	91.00	—	—	3.50	2.00	2.79	19.54
EPD6148SS	0 26715 20407 6	1	110.00	—	—	4.52	2.00	2.79	25.24
EPD6160SS	0 26715 24005 0	1	145.00	—	—	2.00	6.50	2.83	36.83
ERV100S	0 26715 24255 9	1	41.00	—	—	2.36	1.04	2.08	5.12
ERV100SP	0 26715 24256 6	1	42.50	—	—	2.36	1.04	2.08	5.12
ERV110S	0 26715 24253 5	1	48.00	—	—	2.46	1.25	1.93	5.92
ERV110T	0 26715 24254 2	1	49.00	—	—	2.15	1.46	1.92	6.00
ERV120S	0 26715 24261 0	1	49.00	—	—	2.46	1.25	1.93	5.92
ERV120T	0 26715 24260 3	1	49.00	—	—	2.15	1.46	1.92	6.00
ERV140TE	0 26715 22803 4	1	57.00	—	—	2.23	1.48	2.27	7.49
ERV180S	0 26715 24265 8	1	67.00	—	—	3.38	1.74	1.67	9.80
ERV200TE	0 26715 24267 2	1	111.00	—	—	2.92	1.96	2.96	16.90
ERV250TE	0 26715 24269 6	1	97.00	—	—	2.90	1.93	3.03	16.86
ERV70S	0 26715 22801 0	1	37.00	—	—	1.94	1.52	1.60	4.73
ERV70T	0 26715 22800 3	1	36.00	—	—	1.79	1.52	1.54	4.20
ERVH100S	0 26715 24251 1	1	51.00	—	—	3.50	1.26	1.75	7.72
ERVS100S	0 26715 24257 3	1	40.85	—	—	2.34	1.03	2.10	5.05
EW5630SS	0 26715 19493 3	1	57.30	—	—	3.20	1.76	2.05	11.53
EW5636SS	0 26715 19492 6	1	60.00	—	—	3.19	1.76	2.07	11.60
EW5830SS	0 26715 19495 7	1	36.60	—	—	2.92	1.35	2.07	8.14
EW5836SS	0 26715 19494 0	1	40.00	—	—	3.40	1.37	2.10	9.76
EZ80N	0 26715 23143 0	1	9.60	—	—	1.53	0.54	1.15	0.95
F402401	0 26715 14293 4	1	11.60	—	—	2.23	0.65	1.63	2.36
F402402	0 26715 14294 1	1	11.7						

Model	UPC Code	Std. Carton		Master Carton		Length	Width	Height	Cube
		Pk.	Wt.	Pk.	Wt.				
F404201	0 26715 14307 8	1	15.30	—	—	3.75	0.63	1.63	3.88
F404202	0 26715 14308 5	1	15.40	—	—	3.74	0.65	1.63	3.95
F404204	0 26715 14309 2	1	16.00	—	—	3.75	0.63	1.63	3.88
F404208	0 26715 14310 8	1	15.40	—	—	3.73	0.67	1.63	4.04
F404211	0 26715 14466 2	1	15.30	—	—	3.75	0.63	1.63	3.88
F404222	0 26715 14467 9	1	15.30	—	—	3.73	0.66	1.62	3.96
F404223	0 26715 17320 4	1	15.40	—	—	3.75	0.63	1.63	3.88
FILTERE56	0 26715 19513 8	1	0.90	—	—	0.59	0.16	0.78	0.07
FILTERE56FL	0 26715 22857 7	1	0.95	—	—	1.88	0.83	0.10	0.16
FILTEREB40	0 26715 15235 3	1	1.75	5	8.75	0.77	0.30	0.73	0.17
FILTERESQUARE	0 26715 15236 0	1	1.60	—	—	0.82	0.17	0.82	0.11
FX54SS	0 26715 17443 0	1	29.90	—	—	3.58	1.44	1.38	7.10
FXN54SS	0 26715 17442 3	1	32.15	—	—	3.58	1.44	1.42	7.30
FXNE56SS	0 26715 19515 2	1	18.60	—	—	3.89	1.09	1.08	4.60
FXNE58SS	0 26715 19516 9	1	12.90	—	—	3.00	0.85	1.01	2.57
FXNE59SS	0 26715 19514 5	1	38.10	—	—	3.09	1.09	1.08	3.66
FY6	7 84891 20698 6	1	1.90	—	—	1.16	0.56	1.11	0.72
FY86	7 84891 20697 9	1	2.70	—	—	1.08	1.03	1.23	1.35
G102	0 26715 02425 4	1	5.60	—	—	3.59	1.36	0.08	0.41
G103	0 26715 02426 1	1	8.00	—	—	4.29	1.54	0.08	0.55
G686N	0 26715 17886 5	—	—	4	2.00	0.84	0.82	0.28	0.19
GU10	0 26715 16883 5	—	—	10	1.25	0.68	0.62	0.20	0.08
GU1035	0 26715 19749 1	—	—	10	1.25	0.88	0.37	0.26	0.08
HCK44	0 26715 14603 1	—	—	10	5.00	1.98	0.65	0.83	1.07
HCK44D	0 26715 15148 6	—	—	50	17.50	1.24	0.78	0.81	0.79
HD50RDF	0 26715 14609 3	—	—	4	16.75	1.83	0.99	1.06	1.92
HD80L	0 26715 05285 1	1	6.70	—	—	0.78	0.98	1.06	0.80
HLB11	0 26715 16924 5	1	68.00	—	—	2.18	1.86	2.65	10.71
HLB3	0 26715 16921 4	1	24.90	—	—	1.34	1.33	2.08	3.73
HLB6	0 26715 16922 1	1	44.80	—	—	2.11	1.38	2.43	7.03
HLB9	0 26715 16923 8	1	67.10	—	—	2.17	1.86	2.64	10.64
HRV120S	0 26715 24259 7	1	43.00	—	—	2.46	1.25	1.93	5.92
HRV120T	0 26715 24258 0	1	43.00	—	—	2.15	1.46	1.92	6.00
HRV150S	0 26715 24262 7	1	63.00	—	—	3.04	1.73	1.70	8.94
HRV150TE	0 26715 22802 7	1	56.00	—	—	2.21	1.48	2.27	7.42
HRV160T	0 26715 24263 4	1	53.30	—	—	2.27	1.48	2.29	7.71
HRV160TE	0 26715 24264 1	1	54.40	—	—	2.27	1.48	2.29	7.71
HRV190S	0 26715 24266 5	1	64.00	—	—	3.08	1.75	1.67	8.99
HRV200TE	0 26715 24268 9	1	130.00	—	—	2.92	1.96	2.96	16.90
HRV250TE	0 26715 24270 2	1	95.00	—	—	2.88	1.94	3.01	16.76
HRV80S	0 26715 24248 1	1	36.20	—	—	1.94	1.53	1.63	4.80
HRV80T	0 26715 24247 4	1	36.30	—	—	1.82	1.52	1.58	4.37
HRV90S	0 26715 24250 4	1	36.20	—	—	1.94	1.53	1.63	4.80
HRV90T	0 26715 24249 8	1	36.30	—	—	1.82	1.52	1.58	4.37
HRVH100S	0 26715 24252 8	1	50.85	—	—	3.48	1.27	1.75	7.72
HRVH100SE	0 26715 22804 1	1	52.00	—	—	3.50	1.27	1.69	7.51
HVDCT	0 26715 23597 1	1	0.85	—	—	0.79	0.49	0.21	0.08
HVLFABL	0 26715 23591 9	1	5.85	—	—	2.04	0.65	1.20	1.58
HVLFABR	0 26715 23592 6	1	5.85	—	—	2.04	0.65	1.22	1.61
HVPFBL	0 26715 23598 8	1	0.15	—	—	0.23	0.23	0.21	0.01
HVPFBR	0 26715 23599 5	1	0.15	—	—	0.23	0.23	0.21	0.01
HVRC1	0 26715 23595 7	1	0.35	—	—	0.40	0.36	0.37	0.05
HVRC4	0 26715 23596 4	1	0.60	—	—	0.40	0.36	0.37	0.05
HVRFABL	0 26715 23593 3	1	2.55	—	—	1.25	0.37	0.92	0.42
HVRFABR	0 26715 23594 0	1	2.55	—	—	1.25	0.37	0.92	0.42
ICAB	0 26715 23862 0	1	0.73	12	8.76	1.23	0.86	0.12	0.12
ICAK	0 26715 23861 3	1	0.00	6	0.00	0.00	0.00	0.00	0.00
ICDFUW	0 26715 23859 0	1	15.10	—	—	1.20	3.88	0.08	0.39
ICDM	0 26715 23858 3	1	16.10	—	—	1.20	3.88	0.08	0.39
ICDRUW	0 26715 23860 6	1	10.95	—	—	1.20	3.88	0.08	0.39
ICUDWHX	0 26715 23863 7	1	60.00	—	—	1.57	4.63	0.88	6.37
ICUNUWX	0 26715 23864 4	1	46.00	—	—	1.57	4.61	0.80	5.78
ILF120	7 84891 20600 9	1	5.00	—	—	0.88	0.86	0.89	0.68
ILF130	7 84891 20610 8	1	4.80	—	—	0.88	0.86	0.88	0.66
ILF250	7 84891 20615 3	1	7.50	—	—	1.03	1.01	0.88	0.90
ILF360	7 84891 20625 2	1	9.00	—	—	1.15	1.14	1.23	1.61
ILF530	7 84891 20640 5	1	11.90	—	—	1.16	1.14	1.20	1.59
ILFK120	7 84891 20650 4	1	6.10	—	—	0.86	0.84	1.05	0.76
ILFK130	7 84891 20655 9	1	6.70	—	—	1.16	1.15	1.22	1.62
ILFK250	7 84891 20660 3	1	9.30	—	—	1.13	1.15	1.23	1.60
ILFK2502	7 84891 20665 8	1	12.10	—	—	1.67	1.16	1.17	2.25

Model	UPC Code	Std. Carton		Master Carton		Length	Width	Height	Cube
		Pk.	Wt.	Pk.	Wt.				
ILRF	7 84891 20690 0	1	6.40	—	—	0.88	0.86	1.03	0.78
L100	0 26715 12449 7	1	18.90	—	—	1.36	1.25	1.33	2.26
L100L	0 26715 12459 6	1	19.10	—	—	1.36	1.24	1.33	2.23
L100MG	0 26715 12514 2	1	19.30	—	—	1.35	1.23	1.33	2.21
L150	0 26715 12450 3	1	19.30	—	—	1.37	1.23	1.33	2.23
L1500	0 26715 12458 9	1	59.60	—	—	2.16	1.84	1.90	7.55
L1500L	0 26715 12468 8	1	58.80	—	—	2.16	1.83	1.90	7.52
L150L	0 26715 12460 2	1	19.70	—	—	1.36	1.24	1.33	2.25
L150MG	0 26715 12515 9	1	19.70	—	—	1.35	1.24	1.33	2.23
L200	0 26715 12451 0	1	19.10	—	—	1.36	1.24	1.33	2.25
L2000L	0 26715 12469 5	1	87.50	—	—	3.25	1.42	1.54	7.10
L200L	0 26715 12461 9	1	19.50	—	—	1.36	1.25	1.32	2.24
L200MG	0 26715 12516 6	1	19.50	—	—	1.35	1.23	1.33	2.22
L250	0 26715 12452 7	1	21.00	—	—	1.38	1.23	1.33	2.26
L250L	0 26715 12462 6	1	21.40	—	—	1.34	1.24	1.33	2.22
L250MG	0 26715 12517 3	1	21.50	—	—	1.34	1.24	1.33	2.22
L300	0 26715 12453 4	1	21.00	—	—	1.38	1.23	1.33	2.25
L300KMG	0 26715 12519 7	1	22.40	—	—	1.34	1.23	1.34	2.22
L300L	0 26715 12463 3	1	21.40	—	—	1.35	1.24	1.33	2.23
L300MG	0 26715 12518 0	1	20.80	—	—	1.35	1.23	1.33	2.21
L3500EXL	0 26715 12470 1	1	142.00	—	—	3.92	1.60	1.73	10.86
L400	0 26715 12454 1	1	32.50	—	—	2.13	1.38	1.28	3.75
L400K	0 26715 12520 3	1	34.70	—	—	2.14	1.38	1.28	3.78
L400KL	0 26715 12512 8	1	34.80	—	—	2.12	1.38	1.28	3.71
L400L	0 26715 12464 0	1	32.10	—	—	2.13	1.38	1.28	3.73
L500	0 26715 12455 8	1	32.90	—	—	2.12	1.38	1.27	3.71
L500K	0 26715 12521 0	1	35.40	—	—	2.11	1.39	1.28	3.74
L500KL	0 26715 12513 5	1	36.00	—	—	2.12	1.37	1.27	3.66
L500L	0 26715 12465 7	1	33.10	—	—	2.12	1.38	1.25	3.64
L700	0 26715 12456 5	1	32.90	—	—	2.12	1.38	1.27	3.69
L700L	0 26715 12466 4	1	32.90	—	—	2.13	1.39	1.26	3.74
L900	0 26715 12457 2	1	58.70	—	—	2.16	1.83	1.89	7.49
L900L	0 26715 12467 1	1	57.50	—	—	2.16	1.84	1.89	7.52
LA100WH	7 84891 95195 4	—	—	3	4.13	0.64	0.55	0.71	0.25
LA107WH	7 84891 99129 5	1	1.90	3	5.70	0.24	0.63	0.79	0.12
LA11BG	7 84891 95188 6	—	—	6	7.88	1.25	0.76	0.53	0.50
LA11WH	7 84891 95187 9	—	—	6	7.88	1.25	0.73	0.53	0.49
LA126WH	7 84891 98008 4	1	1.40	6	8.40	0.68	0.21	0.53	0.07
LA130WH	7 84891 99134 9	1	1.60	6	9.60	0.21	0.65	0.49	0.07
LA139WH	7 84891 99983 3	1	1.40	6	8.40	0.87	0.33	0.58	0.16
LA140WH	7 84891 99984 0	1	1.40	6	8.40	0.82	0.27	0.60	0.13
LA14WH	7 84891 95189 3	—	—	6	10.50	1.20	0.53	0.71	0.45
LA164WH	7 84891 02648 5	1	3.20	—	—	0.69	0.69	0.17	0.08
LA165SA	7 84891 02649 2	1	3.30	—	—	0.70	0.68	0.35	0.17
LA174WH	7 84891 02650 8	1	3.80	—	—	0.71	0.36	1.08	0.27
LA18WH	7 84891 95190 9	—	—	6	10.50	1.34	0.71	0.73	0.70
LA202WH	7 84891 95196 1	—	—	3	4.69	0.78	0.65	0.82	0.41
LA223WH	0 26715 23566 7	1	0.45	3	1.35	0.35	0.19	0.39	0.03
LA224RWH	0 26715 23570 4	1	0.45	3	1.35	0.28	0.22	0.40	0.02
LA224WH	0 26715 23568 1	1	0.55	3	1.65	0.33	0.22	0.40	0.03
LA225WH	0 26715 23564 3	1	0.35	3	1.05	0.35	0.11		

Model	UPC Code	Std. Carton		Master Carton		Length	Width	Height	Cube
		Pk.	Wt.	Pk.	Wt.				
LK30AWH	0 26715 19631 9	1	6.50	—	—	1.03	1.01	0.92	0.95
LK50DBQ	0 26715 19644 9	1	4.00	—	—	1.02	1.01	0.75	0.77
LK50DWB	0 26715 19643 2	1	3.70	—	—	1.02	1.02	0.75	0.78
LK50DWH	0 26715 19642 5	1	3.90	—	—	1.01	1.02	0.75	0.77
LP80	0 26715 20347 5	1	9.20	—	—	1.39	1.15	0.50	0.80
LP80F	0 26715 23408 0	—	—	4	24.35	2.29	1.27	1.10	3.21
LP80H	0 26715 23410 3	—	—	4	16.60	1.19	1.19	1.53	2.16
LPN80	0 26715 20348 2	1	9.10	—	—	1.39	1.15	0.50	0.80
LPN80F	0 26715 23409 7	—	—	4	24.35	2.29	1.27	1.10	3.21
LT30	0 26715 17297 9	1	6.70	—	—	2.63	0.43	1.46	1.66
LT36	0 26715 17296 6	1	8.20	—	—	3.13	0.43	1.46	1.97
MCB2	0 26715 13906 4	1	1.10	—	—	1.28	0.21	0.15	0.04
MVC309NWHGL	7 84891 99194 3	—	—	6	5.63	0.88	0.63	0.76	0.42
MD10S	0 26715 21104 3	1	5.30	—	—	0.92	0.90	1.29	1.06
MD10T	0 26715 21103 6	1	6.65	—	—	0.92	0.90	1.31	1.08
MD10TU	0 26715 21102 9	1	6.95	—	—	0.92	0.90	1.29	1.06
MD6S	0 26715 20418 2	1	3.20	—	—	0.87	0.57	0.81	0.40
MD6T	0 26715 19203 8	1	4.30	—	—	0.86	0.55	0.81	0.38
MD6TU	0 26715 20378 9	1	4.70	—	—	0.87	0.54	0.81	0.38
MD8S	0 26715 20419 9	1	4.10	—	—	0.85	0.73	0.96	0.60
MD8T	0 26715 19204 5	1	5.30	—	—	0.86	0.73	0.97	0.60
MD8TU	0 26715 20379 6	1	5.60	—	—	0.86	0.73	0.98	0.61
MG1	0 26715 13196 9	1	2.30	—	—	1.19	1.18	0.08	0.12
MHB4	0 26715 23540 7	1	0.80	—	—	1.18	0.24	0.10	0.03
MMDC4	0 26715 23538 4	1	0.75	—	—	0.44	0.43	0.53	0.10
MMG	0 26715 23542 1	1	1.40	—	—	1.10	0.18	1.20	0.23
MP100	0 26715 05724 5	1	15.20	—	—	1.20	1.18	1.06	1.49
MP140	0 26715 05725 2	1	15.60	—	—	1.21	1.20	1.08	1.56
MP200	0 26715 05723 8	1	15.70	—	—	1.20	1.17	1.06	1.48
MP280	0 26715 05726 9	1	31.70	—	—	1.58	1.53	1.40	3.38
MOF4	0 26715 23539 1	1	0.70	—	—	0.78	0.53	0.54	0.22
NA200TA	0 26715 18479 8	1	3.70	6	22.20	0.43	0.59	0.33	0.09
NA3003C	0 26715 18457 6	1	0.20	—	—	0.40	0.34	0.10	0.01
NA3008C	0 26715 18458 3	1	0.20	—	—	0.40	0.33	0.10	0.01
NA300MCWH	0 26715 18484 2	1	0.20	30	6.00	0.17	0.41	0.50	0.03
NA300TA	0 26715 18480 4	1	4.80	6	28.80	0.36	0.65	0.33	0.08
NDB300AB	0 26715 18455 2	1	0.90	30	27.00	0.40	0.23	0.67	0.06
NDB300BB	0 26715 18454 5	1	1.00	30	30.00	0.22	0.40	0.58	0.05
NDB300N	0 26715 18456 9	1	0.90	—	—	0.40	0.22	0.67	0.06
NDB300WH	0 26715 18453 8	1	0.60	30	18.00	0.58	0.23	0.42	0.05
NDK35830SS	0 26715 17592 5	1	7.30	—	—	2.83	0.40	1.20	1.36
NDK35830SL	0 26715 17590 1	1	6.80	—	—	2.83	0.39	1.20	1.33
NDK35830WWW	0 26715 17591 8	1	7.30	—	—	2.83	0.40	1.20	1.36
NDK35836BL	0 26715 17595 6	1	8.30	—	—	3.33	1.21	0.39	1.58
NDK35836SS	0 26715 17593 2	1	8.00	—	—	3.35	0.41	1.21	1.65
NDK35836WWW	0 26715 17594 9	1	9.10	—	—	3.33	1.21	0.40	1.61
NES300DBL	0 26715 18467 5	1	0.30	70	21.00	0.35	0.17	0.58	0.03
NES300DWH	0 26715 18466 8	1	0.30	70	21.00	0.56	0.35	0.16	0.03
NF100CWH	0 26715 18471 2	1	2.10	8	16.80	0.18	1.53	1.33	0.37
NF100MWH	0 26715 18481 1	1	1.10	12	13.20	1.48	0.13	1.00	0.18
NF200MWH	0 26715 18468 2	1	0.08	25	2.00	1.36	0.52	0.01	0.00
NF300DWH	0 26715 18478 1	1	0.30	24	7.20	0.64	0.12	0.46	0.03
NF300PWH	0 26715 18477 4	1	0.90	24	21.60	0.70	0.13	0.94	0.08
NF300RWH	0 26715 18476 7	1	0.90	24	21.60	0.70	0.13	0.94	0.08
NM100WH	0 26715 18472 9	1	4.70	4	18.80	0.87	1.61	0.75	1.05
NM200AL	0 26715 18448 4	1	4.70	4	18.80	0.88	1.62	0.75	1.06
NM200K	0 26715 18444 6	1	12.10	—	—	1.73	0.91	1.55	2.44
NM200WH	0 26715 18446 0	1	4.70	4	18.80	0.87	1.62	0.75	1.05
NPS103WH	0 26715 18474 3	1	1.00	18	18.00	0.51	0.28	0.58	0.08
NPS104WH	0 26715 18501 6	1	1.00	18	18.00	0.52	0.28	0.50	0.07
NPS200WH	0 26715 18451 4	1	1.00	18	18.00	0.51	0.28	0.50	0.07
NR380WH	0 26715 18462 8	1	2.40	5	12.00	0.32	1.00	1.00	0.32
NRKF200P	0 26715 18464 4	1	0.90	24	21.60	0.43	0.27	0.50	0.06
NRKR200R	0 26715 18463 7	1	0.90	15	13.50	0.56	0.53	0.25	0.07
NRKR300D	0 26715 18502 3	1	0.70	5	3.50	0.24	0.35	0.58	0.05
NRKRWH300	0 26715 18460 6	1	14.30	2	28.60	1.48	1.23	0.50	0.91
NRKS200PWH	0 26715 18465 1	1	1.00	6	6.00	0.57	0.74	0.42	0.18
NRKS300R	0 26715 18821 5	1	1.60	5	8.00	0.32	0.99	1.00	0.31
NRS103WH	0 26715 18473 6	1	0.90	18	16.20	0.51	0.26	0.58	0.08
NRS104WH	0 26715 18475 0	1	0.90	18	16.20	0.51	0.28	0.50	0.07
NRS200AL	0 26715 18452 1	1	0.90	18	16.20	0.26	0.51	0.50	0.07

Model	UPC Code	Std. Carton		Master Carton		Length	Width	Height	Cube
		Pk.	Wt.	Pk.	Wt.				
NRS200WH	0 26715 18450 7	1	0.90	18	16.20	0.26	0.51	0.58	0.08
NW4S	0 26715 18694 5	1	2.23	10	22.30	0.63	0.63	0.18	0.07
NWH300	0 26715 18459 0	1	12.25	2	24.50	1.48	1.22	0.43	0.77
P5	0 26715 12434 3	1	17.60	—	—	2.33	1.33	0.50	1.56
P57W	0 26715 03860 2	—	—	4	1.25	0.67	0.50	0.35	0.12
P59V	0 26715 03821 3	—	—	4	2.50	1.09	0.38	0.69	0.28
P59W	0 26715 03865 7	—	—	4	2.50	1.09	0.38	0.69	0.29
P66V	0 26715 03837 4	—	—	4	1.50	0.67	0.35	0.63	0.15
P66W	0 26715 03878 7	—	—	4	1.50	0.67	0.35	0.63	0.15
P685WL	0 26715 08274 2	—	—	4	2.25	0.86	0.51	0.68	0.30
P68W	0 26715 03886 2	—	—	4	1.50	0.67	0.35	0.63	0.15
P8	0 26715 12435 0	1	25.90	—	—	2.33	1.33	0.42	1.30
PAR20	0 26715 13225 6	—	—	6	1.86	0.77	0.64	0.51	0.25
PB10LGL	7 84891 99052 6	—	—	12	0.75	0.34	0.34	0.43	0.05
PB15LBR	0 26715 17990 9	—	—	3	0.38	0.34	0.33	0.41	0.05
PB15LPB	0 26715 17980 0	—	—	3	0.38	0.33	0.36	0.39	0.05
PB15LSN	0 26715 17976 3	—	—	3	0.38	0.33	0.33	0.43	0.05
PB18LWHCL	7 84891 99362 6	—	—	12	0.30	0.34	0.34	0.44	0.05
PB18WHCL	7 84891 05177 7	—	—	12	0.30	0.36	0.33	0.42	0.05
PB19LGL	7 84891 99280 3	—	—	12	1.50	0.35	0.33	0.42	0.05
PB27LBR	0 26715 17991 6	—	—	3	0.56	0.34	0.34	0.42	0.05
PB27LSN	7 84891 05244 6	—	—	6	0.75	0.33	0.35	0.43	0.05
PB29LR	7 84891 05252 1	—	—	6	0.38	0.33	0.34	0.42	0.05
PB29LSN	7 84891 05254 5	—	—	6	0.38	0.43	0.31	0.59	0.08
PB41APB41LA	7 84891 99435 7	—	—	24	1.08	0.73	0.73	0.54	0.29
PB41BGL	7 84891 99434 0	—	—	24	2.06	0.95	0.70	0.82	0.54
PB41LBGL	7 84891 99897 3	—	—	24	2.06	0.94	0.71	0.78	0.52
PB41LBR	7 84891 05350 4	—	—	24	1.50	0.93	0.71	0.78	0.51
PB41LSN	7 84891 05351 1	—	—	24	1.50	0.97	0.77	0.78	0.58
PB4LBL	0 26715 17997 8	—	—	3	0.56	0.33	0.33	0.43	0.05
PB4LBR	0 26715 17989 3	—	—	3	0.56	0.35	0.34	0.43	0.05
PB4LSN	0 26715 17975 6	—	—	3	0.56	0.33	0.37	0.43	0.05
PB53LWH	0 26715 17995 4	—	—	3	0.75	0.34	0.34	0.43	0.05
PB59LPB	0 26715 17986 2	—	—	3	0.38	0.34	0.34	0.43	0.05
PB61LPB	0 26715 17985 5	—	—	3	0.75	0.34	0.34	0.42	0.05
PB64LAB	0 26715 17992 3	—	—	3	0.56	0.34	0.34	0.40	0.05
PB67AB	0 26715 17993 0	—	—	3	0.19	0.34	0.33	0.43	0.05
PB69LBL	0 26715 17998 5	—	—	6	0.38	0.33	0.35	0.43	0.05
PB69LPB	0 26715 17978 7	—	—	6	0.38	0.33	0.36	0.43	0.05
PB69LPC	0 26715 18000 4	—	—	6	0.38	0.34	0.33	0.43	0.05
PB69LSN	0 26715 17977 0	—	—	6	0.38	0.35	0.33	0.43	0.05
PB69LWH	0 26715 17994 7	—	—	6	0.38	0.31	0.34	0.42	0.04
PB78LWHCL	0 26715 21135 7	1	0.06	6	0.38	0.23	0.04	0.36	0.00
PB7LBL	7 84891 06001 4	—	—	12	0.60	0.34	0.34	0.44	0.05
PB7LPB	7 84891 06002 1	—	—	12	0.60	0.34	0.34	0.44	0.05
PB7LSN	7 84891 06003 8	—	—	12	0.60	0.34	0.34	0.44	0.05
PB7LWH	7 84891 06004 5	—	—	12	0.60	0.34	0.34	0.44	0.05
PB7WH	7 84891 06005 2	—	—	12	0.60	0.34	0.34	0.44	0.05
PB82WH	0 26715 23569 8	—	—	6	0.45	0.34	0.34	0.43	0.05
PB85BR	0 26715 23573 5	—	—	6	1.20	0.34	0.34	0.43	0.

Model	UPC Code	Std. Carton		Master Carton		Length	Width	Height	Cube
		Pk.	Wt.	Pk.	Wt.				
QP142SS	0 26715 17696 0	1	33.80	—	—	3.90	0.85	2.02	6.72
QP142WW	0 26715 17697 7	1	35.30	—	—	3.88	0.87	1.98	6.67
QP230BC	0 26715 19277 9	1	30.30	—	—	2.91	0.88	1.98	5.10
QP230BL	0 26715 17698 4	1	30.70	—	—	2.91	0.88	1.97	5.05
QP230SS	0 26715 17699 1	1	29.40	—	—	2.90	0.88	1.97	4.99
QP230WW	0 26715 17700 4	1	30.40	—	—	2.92	0.88	1.98	5.09
QP236BC	0 26715 19278 6	1	32.50	—	—	3.29	0.87	1.98	5.63
QP236BL	0 26715 17704 2	1	33.70	—	—	3.41	0.88	1.98	5.91
QP236SS	0 26715 17705 9	1	32.30	—	—	3.39	0.88	1.97	5.84
QP236WW	0 26715 17706 6	1	33.70	—	—	3.40	0.88	1.98	5.96
QP242BC	0 26715 19279 3	1	37.00	—	—	3.79	0.86	1.96	6.37
QP242BL	0 26715 17707 3	1	36.70	—	—	3.88	0.88	1.98	6.71
QP242SS	0 26715 17708 0	1	35.30	—	—	3.88	0.88	1.98	6.70
QP242WW	0 26715 17709 7	1	36.80	—	—	3.87	0.88	1.97	6.65
QP330BL	0 26715 17710 3	1	33.80	—	—	2.92	0.87	1.97	4.97
QP330SS	0 26715 17711 0	1	32.90	—	—	2.90	0.88	1.98	5.01
QP330WW	0 26715 17712 7	1	33.70	—	—	2.89	0.87	1.96	4.91
QP336BL	0 26715 17716 5	1	37.10	—	—	3.41	0.86	1.97	5.75
QP336SS	0 26715 17717 2	1	35.80	—	—	3.40	0.88	1.96	5.88
QP336WW	0 26715 17718 9	1	37.00	—	—	3.41	0.89	1.97	5.98
QP342BL	0 26715 17719 6	1	38.50	—	—	3.79	0.88	1.96	6.50
QP342SS	0 26715 17720 2	1	37.90	—	—	3.88	0.88	1.96	6.65
QP342WW	0 26715 17721 9	1	39.10	—	—	3.78	0.87	1.97	6.45
QP430SS	0 26715 19900 6	1	32.40	—	—	2.89	0.88	1.96	4.95
QP436SS	0 26715 19901 3	1	35.80	—	—	3.38	0.92	1.95	6.05
QP442SS	0 26715 19902 0	1	38.80	—	—	3.90	0.85	2.02	6.72
QS130AA	0 26715 13556 1	1	23.20	—	—	2.79	0.83	1.98	4.59
QS130BC	0 26715 13555 4	1	22.80	—	—	2.80	0.84	1.98	4.67
QS130BL	0 26715 13557 8	1	23.30	—	—	2.79	0.83	1.98	4.57
QS130SS	0 26715 13558 5	1	21.50	—	—	2.79	0.82	1.98	4.50
QS130WW	0 26715 13554 7	1	22.60	—	—	2.79	0.83	1.98	4.55
QS136AA	0 26715 13561 5	1	25.40	—	—	3.28	0.83	1.98	5.43
QS136BC	0 26715 13560 8	1	24.80	—	—	3.29	0.84	1.98	5.49
QS136BL	0 26715 13562 2	1	24.80	—	—	3.30	0.83	1.98	5.43
QS136SS	0 26715 13563 9	1	23.90	—	—	3.31	0.82	1.99	5.38
QS136WW	0 26715 13559 2	1	25.20	—	—	3.29	0.83	1.98	5.36
QS142AA	0 26715 13566 0	1	27.90	—	—	3.80	0.82	1.98	6.13
QS142BC	0 26715 13565 3	1	27.50	—	—	3.80	0.82	1.97	6.10
QS142BL	0 26715 13567 7	1	27.30	—	—	3.77	0.83	1.98	6.23
QS142SS	0 26715 13568 4	1	25.70	—	—	3.79	0.83	1.98	6.20
QS142WW	0 26715 13564 6	1	27.40	—	—	3.79	0.83	1.98	6.24
QS230AA	0 26715 13571 4	1	30.10	—	—	2.83	0.83	1.98	4.64
QS230BC	0 26715 13570 7	1	29.70	—	—	2.79	0.84	1.97	4.62
QS230BL	0 26715 13573 8	1	31.10	—	—	2.80	0.85	1.98	4.72
QS230SS	0 26715 13572 1	1	29.20	—	—	2.80	0.83	1.97	4.54
QS230WW	0 26715 13569 1	1	29.90	—	—	2.79	0.81	1.97	4.44
QS236AA	0 26715 13576 9	1	33.00	—	—	3.30	0.83	1.98	5.45
QS236BC	0 26715 13575 2	1	32.90	—	—	3.29	0.83	1.98	5.36
QS236BL	0 26715 13577 6	1	32.90	—	—	3.28	0.83	1.98	5.43
QS236SS	0 26715 13578 3	1	31.70	—	—	3.29	0.82	1.98	5.31
QS236WW	0 26715 13574 5	1	32.70	—	—	3.29	0.83	1.98	5.44
QS242AA	0 26715 13581 3	1	36.20	—	—	3.79	0.82	1.97	6.09
QS242BC	0 26715 13580 6	1	36.10	—	—	3.78	0.83	1.98	6.25
QS242BL	0 26715 13582 0	1	36.20	—	—	3.80	0.83	1.97	6.17
QS242SS	0 26715 13583 7	1	34.30	—	—	3.79	0.83	1.98	6.24
QS242WW	0 26715 13579 0	1	36.40	—	—	3.78	0.82	1.98	6.11
QS330AA	0 26715 13586 8	1	31.80	—	—	2.79	0.81	1.96	4.42
QS330BC	0 26715 13585 1	1	30.40	—	—	2.79	0.83	1.98	4.55
QS330BL	0 26715 13587 5	1	30.40	—	—	2.78	0.83	1.97	4.52
QS330SS	0 26715 13588 2	1	29.90	—	—	2.79	0.83	1.98	4.61
QS330WW	0 26715 13584 4	1	31.00	—	—	2.78	0.83	1.97	4.52
QS336AA	0 26715 13591 2	1	34.30	—	—	3.28	0.82	1.98	5.30
QS336BC	0 26715 13590 5	1	34.60	—	—	3.29	0.83	1.97	5.34
QS336BL	0 26715 13592 9	1	34.00	—	—	3.29	0.83	1.98	5.39
QS336SS	0 26715 13593 6	1	32.70	—	—	3.29	0.83	1.98	5.39
QS336WW	0 26715 13589 9	1	33.50	—	—	3.30	0.82	1.97	5.30
QS342AA	0 26715 13596 7	1	37.20	—	—	3.79	0.83	1.98	6.24
QS342BC	0 26715 13595 0	1	37.50	—	—	3.80	0.83	1.98	6.25
QS342BL	0 26715 13597 4	1	37.40	—	—	3.78	0.83	1.98	6.23
QS342SS	0 26715 13598 1	1	35.50	—	—	3.80	0.82	1.96	6.08
QS342WW	0 26715 13594 3	1	37.70	—	—	3.79	0.83	1.98	6.18

Model	UPC Code	Std. Carton		Master Carton		Length	Width	Height	Cube
		Pk.	Wt.	Pk.	Wt.				
OSE130BL	0 26715 19723 1	1	24.10	—	—	2.80	0.83	1.98	4.56
OSE130SS	0 26715 19722 4	1	22.30	—	—	2.82	0.83	1.98	4.59
OSE130WW	0 26715 19724 8	1	24.00	—	—	2.80	0.82	1.96	4.48
QT230AA	0 26715 13372 7	1	17.60	—	—	2.75	0.66	1.63	2.96
QT230BC	0 26715 14218 7	1	17.50	—	—	2.76	0.66	1.63	2.95
QT230BL	0 26715 13373 4	1	17.40	—	—	2.76	0.65	1.62	2.90
QT230SS	0 26715 13374 1	1	17.50	—	—	2.75	0.67	1.63	2.98
QT230WW	0 26715 13371 0	1	17.50	—	—	2.75	0.66	1.63	2.94
QT236AA	0 26715 13376 5	1	18.40	—	—	3.24	0.67	1.63	3.53
QT236BC	0 26715 14232 3	1	18.70	—	—	3.25	0.66	1.63	3.48
QT236BL	0 26715 13377 2	1	17.80	—	—	3.25	0.67	1.63	3.52
QT236SS	0 26715 13378 9	1	18.20	—	—	3.25	0.66	1.63	3.48
QT236WW	0 26715 13375 8	1	18.10	—	—	3.26	0.65	1.59	3.37
QT242AA	0 26715 13380 2	1	20.30	—	—	3.75	0.66	1.63	4.03
QT242BC	0 26715 14233 0	1	20.20	—	—	3.75	0.67	1.63	4.06
QT242BL	0 26715 13381 9	1	20.30	—	—	3.75	0.66	1.63	4.01
QT242SS	0 26715 13382 6	1	21.20	—	—	3.76	0.64	1.63	3.94
QT242WW	0 26715 13379 6	1	20.50	—	—	3.73	0.66	1.63	4.01
QT9093WH	7 84891 32212 9	1	23.50	—	—	1.96	1.61	1.00	3.15
QTHB1	0 26715 17278 8	1	1.50	—	—	1.38	3.08	0.29	0.15
QTNLEDA	0 26715 19949 5	1	13.60	—	—	1.30	1.23	1.31	2.08
QTNLEDB	0 26715 19950 1	1	13.80	—	—	1.32	1.23	1.29	2.08
QTX110HFLT	0 26715 18797 3	1	22.80	—	—	1.76	1.37	1.32	3.16
QTX110HL	0 26715 16389 2	1	22.60	—	—	1.76	1.36	1.33	3.18
QTXE080	0 26715 16375 5	1	11.60	—	—	1.33	0.95	1.29	1.63
QTXE080FLT	0 26715 17177 4	1	13.05	—	—	1.34	1.23	1.29	2.12
QTXE110	0 26715 16377 9	1	10.70	—	—	1.33	0.96	1.28	1.64
QTXE110FLT	0 26715 17178 1	1	12.00	—	—	1.34	1.21	1.28	2.08
QTXE110S	0 26715 16415 8	1	12.15	—	—	1.32	1.00	1.28	1.69
QTXE150	0 26715 16379 3	1	11.70	—	—	1.33	0.96	1.29	1.65
QTXE150FLT	0 26715 17179 8	1	13.10	—	—	1.33	1.22	1.30	2.10
QTXEN080	7 84891 21825 5	1	11.60	—	—	1.31	0.96	1.30	1.63
QTXEN080FLT	7 84891 21530 8	1	12.90	—	—	1.31	1.23	1.29	2.07
QTXEN110	7 84891 21827 9	1	10.70	—	—	1.32	0.96	1.29	1.63
QTXEN110FLT	7 84891 21531 5	1	12.00	—	—	1.31	1.23	1.29	2.08
QTXEN150	7 84891 21829 3	1	11.60	—	—	1.32	0.96	1.29	1.63
QTXEN150FLT	7 84891 21532 2	1	13.00	—	—	1.32	1.23	1.28	2.08
QTXN110HFLT	0 26715 18798 0	1	22.70	—	—	1.75	1.36	1.33	3.15
QTXN110HL	7 84891 21848 4	1	22.60	—	—	1.75	1.37	1.34	3.21
RB110	0 26715 23005 1	1	13.50	—	—	1.17	1.25	0.96	1.40
RB110L	0 26715 23007 5	1	14.60	—	—	1.24	1.15	1.21	1.73
RB80	0 26715 23004 4	1	14.50	—	—	1.17	1.25	0.96	1.40
RB80L	0 26715 23006 8	1	14.60	—	—	1.24	1.15	1.21	1.73
RBFP33	0 26715 15797 6	1	6.90	—	—	1.29	0.70	1.15	1.04
RBFP45	0 26715 15798 3	1	9.60	—	—	1.28	0.71	1.15	1.05
RCK01	0 26715 19675 3	1	0.60	—	—	0.48	0.27	0.27	0.03
RD1	0 26715 12474 9	1	4.10	—	—	1.09	0.37	1.08	0.43
RD2	0 26715 12475 6	1	4.80	—	—	1.87	0.37	1.10	0.75
RD3	0 26715 12476 3	1	6.40	—	—	1.90	1.58	0.37	1.10
RDF1	0 26715 20166 2	1	4.90	—	—	1.12	1.03	0.42	0.48

Model	UPC Code	Std. Carton		Master Carton		Length	Width	Height	Cube
		Pk.	Wt.	Pk.	Wt.				
RFXN5004	0 26715 17205 4	1	7.30	—	—	3.26	0.86	0.80	2.24
RFXN5204	0 26715 17206 1	1	10.20	—	—	3.29	1.12	1.18	4.32
RFXN5304	0 26715 16523 0	1	15.10	—	—	3.56	1.47	1.38	7.18
RG4	7 84891 00517 6	1	0.30	12	3.60	0.88	0.73	0.05	0.03
RK54	0 26715 17440 9	1	4.50	—	—	1.46	0.90	0.89	1.17
RKE56	0 26715 19518 3	1	7.10	—	—	2.12	0.57	1.42	1.70
RKE58	0 26715 19519 0	1	7.00	—	—	2.12	0.60	1.14	1.45
RKE59	0 26715 19517 6	1	6.60	—	—	2.12	0.63	1.34	1.77
RM503001	0 26715 15813 3	1	36.70	—	—	2.82	1.51	2.03	8.64
RM503004	0 26715 14948 3	1	35.70	—	—	2.79	1.54	2.03	8.72
RM503023	0 26715 15814 0	1	36.70	—	—	2.82	1.51	2.03	8.64
RM503601	0 26715 15815 7	1	40.80	—	—	3.17	1.50	2.04	9.70
RM503604	0 26715 14949 0	1	38.10	—	—	3.18	1.50	2.01	9.56
RM503623	0 26715 15816 4	1	38.20	—	—	3.17	1.51	2.04	9.75
RM519004	0 26715 15089 2	1	37.45	—	—	3.18	1.58	2.03	10.15
RM523004	0 26715 15092 2	1	41.50	—	—	2.82	1.58	2.03	8.98
RM523604	0 26715 15093 9	1	42.80	—	—	3.17	1.53	2.04	9.86
RM524204	0 26715 15094 6	1	45.60	—	—	3.73	1.56	2.03	11.80
RM533004	0 26715 16519 3	1	46.10	—	—	2.81	1.54	2.03	8.80
RM533604	0 26715 16520 9	1	48.00	—	—	3.19	1.56	2.05	10.20
RM534204	0 26715 16521 6	1	52.00	—	—	3.75	1.54	2.04	11.80
RM659004	0 26715 15087 8	1	56.80	—	—	3.39	1.72	2.27	13.20
RMDD3004	0 26715 15175 2	1	66.20	—	—	2.83	2.90	0.90	7.39
RMDD3004EX	0 26715 15178 3	1	53.60	—	—	2.83	2.91	0.90	7.42
RMDD3604	0 26715 15176 9	1	72.70	—	—	3.33	2.89	0.90	8.67
RMDD3604EX	0 26715 15179 0	1	61.80	—	—	3.33	2.91	0.89	8.64
RMDD4804	0 26715 15177 6	1	96.00	—	—	4.33	2.90	0.92	11.50
RMDD4804EX	0 26715 15180 6	1	77.00	—	—	2.92	4.33	0.92	11.59
RMDDRBK	0 26715 15181 3	1	0.30	—	—	0.40	0.35	0.35	0.05
RME5030SS	0 26715 19889 4	1	36.10	—	—	2.80	1.53	2.03	8.68
RMP33	0 26715 15784 6	1	32.50	—	—	3.31	1.16	2.20	8.43
RMP45	0 26715 15785 3	1	41.80	—	—	4.29	1.14	2.21	10.82
RMPWC	0 26715 15796 9	1	1.60	—	—	0.68	0.53	0.41	0.15
RML3336S	0 26715 16367 0	1	10.70	—	—	3.67	2.25	0.42	3.44
RML3342S	0 26715 16368 7	1	14.10	—	—	4.67	2.25	0.42	4.37
RML4548S	0 26715 16369 4	1	13.30	—	—	4.67	2.25	0.42	4.37
RML4554S	0 26715 17282 5	1	18.20	—	—	6.70	2.28	0.42	6.35
RML4560S	0 26715 16370 0	1	19.10	—	—	6.67	2.25	0.42	6.25
RML5230S	0 26715 24015 9	1	11.35	—	—	3.68	2.27	0.43	3.62
RML7030L	0 26715 15793 8	1	11.40	—	—	3.69	2.27	0.42	3.49
RML7030S	0 26715 15790 7	1	10.70	—	—	3.68	2.27	0.43	3.59
RML7036L	0 26715 15794 5	1	11.90	—	—	3.67	2.25	0.42	3.44
RML7036S	0 26715 15791 4	1	11.00	—	—	3.69	2.26	0.43	3.58
RML7048L	0 26715 15795 2	1	16.20	—	—	4.69	2.26	0.42	4.41
RML7048S	0 26715 15792 1	1	14.70	—	—	4.67	2.25	0.42	4.37
RMP17004	0 26715 15228 5	1	35.60	—	—	3.11	1.53	1.21	5.76
RMP3004	0 26715 15324 4	1	19.40	—	—	3.67	2.25	0.42	3.44
RMP3604	0 26715 15325 1	1	19.60	—	—	3.69	2.26	0.42	3.47
RMP4204	0 26715 15326 8	1	23.00	—	—	4.67	2.25	0.42	4.37
RMP4804	0 26715 15327 5	1	24.20	—	—	4.67	2.25	0.42	4.37
RMP5404	0 26715 15328 2	1	30.00	—	—	6.67	2.27	0.42	6.31
RMP6004	0 26715 15329 9	1	34.80	—	—	6.71	2.26	0.44	6.63
RMPE7004	0 26715 15229 2	1	12.30	—	—	2.46	0.77	1.17	2.20
RN110	0 26715 23009 9	1	13.50	—	—	1.17	1.25	0.96	1.40
RN110L	0 26715 23011 2	1	14.60	—	—	1.24	1.15	1.21	1.73
RN80	0 26715 23008 2	1	14.50	—	—	1.17	1.25	0.96	1.40
RN80L	0 26715 23010 5	1	14.60	—	—	1.24	1.15	1.21	1.73
ROUNDFILTER	0 26715 08370 1	1	1.66	—	—	0.75	0.73	0.30	0.16
RP130BL	0 26715 17580 2	1	33.00	—	—	2.71	1.02	2.04	5.62
RP130SS	0 26715 17578 9	1	31.50	—	—	2.69	1.03	2.03	5.59
RP130WWW	0 26715 17579 6	1	33.20	—	—	2.69	1.03	2.04	5.63
RP136BL	0 26715 17583 3	1	35.10	—	—	3.20	1.03	2.04	6.75
RP136SS	0 26715 17581 9	1	34.30	—	—	3.20	1.04	2.05	6.83
RP136WWW	0 26715 17582 6	1	33.80	—	—	3.18	1.03	2.03	6.61
RRK51	0 26715 15090 8	1	3.70	—	—	1.47	0.89	0.90	1.18
RVK1A	0 26715 15782 2	1	2.90	—	—	1.00	0.46	0.94	0.43
S97011308	0 26715 05311 7	1	1.00	—	—	1.03	0.88	0.06	0.05
S97013825	0 26715 10088 0	1	3.55	—	—	1.27	1.23	0.23	0.36
S97013826	0 26715 10089 7	1	2.35	—	—	1.07	1.02	0.16	0.17
S97013827	0 26715 10090 3	1	3.45	—	—	1.26	1.24	0.23	0.35
S99010042	0 26715 03239 6	1	0.10	—	—	0.79	0.79	0.01	0.01

Model	UPC Code	Std. Carton		Master Carton		Length	Width	Height	Cube
		Pk.	Wt.	Pk.	Wt.				
S99010271	0 26715 07821 9	1	0.10	—	—	0.87	0.87	0.01	0.01
S990712044	0 26715 13553 0	1	0.10	—	—	0.35	0.29	0.00	0.00
SMD6	0 26715 19201 4	1	4.80	—	—	0.87	0.56	0.81	0.39
SMD8	0 26715 19202 1	1	5.50	—	—	0.86	0.72	0.96	0.59
SMSCPLR	0 26715 18621 1	1	0.40	—	—	0.43	0.24	0.30	0.03
SP100	0 26715 05720 7	1	15.00	—	—	1.20	1.19	1.08	1.55
SP140	0 26715 05721 4	1	15.40	—	—	1.20	1.18	1.06	1.49
SP200	0 26715 05722 1	1	15.50	—	—	1.21	1.18	1.08	1.54
SP240108	0 26715 06279 9	1	3.10	—	—	2.75	2.28	0.07	0.42
SP240223	0 26715 14089 3	1	3.10	—	—	2.75	2.29	0.07	0.42
SP2404	0 26715 02218 2	1	4.60	—	—	2.75	2.29	0.07	0.42
SP300108	0 26715 06281 2	1	2.60	—	—	2.75	2.29	0.07	0.42
SP300223	0 26715 14090 9	1	2.70	—	—	2.75	2.28	0.07	0.42
SP3004	0 26715 00076 0	1	6.00	—	—	2.75	2.29	0.07	0.42
SP360108	0 26715 06283 6	1	3.70	—	—	3.75	2.29	0.07	0.57
SP360223	0 26715 14091 6	1	3.40	—	—	3.75	2.29	0.07	0.57
SP3604	0 26715 00077 7	1	7.60	—	—	3.75	2.29	0.07	0.57
SP420108	0 26715 06285 0	1	3.90	—	—	3.92	2.29	0.07	0.60
SP420223	0 26715 14092 3	1	3.70	—	—	3.75	2.29	0.07	0.57
SP4204	0 26715 02228 1	1	7.30	—	—	3.75	2.29	0.07	0.57
SPB18LWHCL	0 26715 23790 6	1	0.10	—	—	0.25	0.08	0.08	0.00
SPK110	0 26715 23412 7	1	12.05	—	—	1.29	0.94	1.31	1.59
SPKACC	0 26715 23414 1	1	2.10	—	—	1.06	0.53	0.53	0.30
SSQTXE080	0 26715 18620 4	1	12.00	—	—	0.96	1.29	1.33	1.65
SSQTXE110	0 26715 18619 8	1	12.15	—	—	0.97	1.29	1.33	1.66
T457	0 26715 25209 1	1	1.40	—	—	0.67	0.58	0.17	0.06
T460	0 26715 16881 1	1	2.00	—	—	1.30	0.77	0.67	0.66
T461	0 26715 16882 8	1	0.80	8	6.40	1.27	0.44	0.50	0.28
T486	0 26715 22964 2	1	1.50	—	—	0.79	0.79	0.67	0.42
T487	0 26715 20786 2	1	1.40	—	—	0.75	0.77	0.71	0.41
T81212	0 26715 13195 2	1	4.00	—	—	1.09	1.09	0.99	1.18
TF40BS	0 26715 19637 1	1	3.00	—	—	0.78	0.82	0.75	0.47
TF40GAP	0 26715 19639 5	1	4.60	—	—	1.14	1.13	0.58	0.75
TF40GCL	0 26715 19641 8	1	4.80	—	—	1.11	1.13	0.58	0.73
TF40GFW	0 26715 19640 1	1	4.80	—	—	0.94	0.93	0.58	0.51
TF40RB	0 26715 19638 8	1	3.10	—	—	0.78	0.81	0.75	0.47
TF40WH	0 26715 19635 7	1	3.05	—	—	0.83	0.79	0.77	0.51
TYIK1	0 26715 17042 5	1	4.55	—	—	2.08	1.58	0.71	2.34
V104	0 26715 02700 2	—	—	4	2.25	0.40	0.39	0.31	0.05
VB20W	0 26715 10282 2	1	0.25	—	—	0.65	0.53	0.19	0.06
VB60W	0 26715 24317 4	1	0.20	—	—	0.42	0.27	0.08	0.01
VS63WH	7 84891 27434 3	1	0.40	6	2.40	0.40	0.24	0.18	0.02
VS66WH	7 84891 27465 7	1	0.60	6	3.60	0.26	0.40	0.44	0.05
VS67WH	7 84891 27475 6	1	0.60	6	3.60	0.43	0.42	0.25	0.04
VS68WH	7 84891 27485 5	1	0.70	6	4.20	0.43	0.25	0.42	0.04
VS69WH	7 84891 27495 4	1	0.70	2	1.40	0.23	0.44	0.46	0.05
VT10W	0 26715 24316 7	1	0.55	—	—	0.44	0.44	0.17	0.03
VT11W	0 26715 10283 9	1	0.70	—	—	0.20	0.53	0.67	0.07
VT4W	0 26715 17041 8	1	0.30	—	—	0.52	0.20	0.67	0.07
VT5W	0 26715 18336 4	1	0.30	—	—	0.73	0.53	0.14	0.05

XN110H – ZN80ML

Model	UPC Code	Std. Carton		Master Carton		Length	Width	Height	Cube
		Pk.	Wt.	Pk.	Wt.				
XN110H	0 26715 20291 1	1	12.30	—	—	1.23	1.15	0.96	1.35
XN110HL	0 26715 20299 7	1	13.70	—	—	1.23	1.14	1.21	1.70
XN110L	0 26715 20122 8	1	13.40	—	—	1.24	1.15	1.21	1.73
XN50	0 26715 20120 4	1	12.10	—	—	1.24	1.16	0.94	1.35
XN50L	0 26715 20126 6	1	13.70	—	—	1.25	1.16	1.18	1.71
XN80	0 26715 20118 1	1	12.20	—	—	1.24	1.16	0.93	1.34
XN80L	0 26715 20124 2	1	13.50	—	—	1.24	1.15	1.21	1.73
ZB110	0 26715 20107 5	1	11.90	—	—	1.25	1.17	0.95	1.39
ZB110H	0 26715 20286 7	1	12.40	—	—	1.23	1.15	0.94	1.34
ZB110HL	0 26715 20294 2	1	13.80	—	—	1.23	1.15	1.21	1.71
ZB110L	0 26715 20111 2	1	13.60	—	—	1.23	1.15	1.21	1.71
ZB110M	0 26715 20288 1	1	12.30	—	—	1.23	1.14	0.95	1.33
ZB110ML	0 26715 20296 6	1	13.70	—	—	1.24	1.15	1.21	1.73
ZB80	0 26715 20109 9	1	12.00	—	—	1.23	1.15	0.95	1.35

Model	UPC Code	Std. Carton		Master Carton		Length	Width	Height	Cube
		Pk.	Wt.	Pk.	Wt.				
ZB80L	0 26715 20113 6	1	13.60	—	—	1.24	1.17	1.22	1.76
ZB80M	0 26715 20289 8	1	12.60	—	—	1.23	1.16	0.96	1.37
ZB80ML	0 26715 20297 3	1	13.90	—	—	1.24	1.15	1.21	1.73
ZN110	0 26715 20108 2	1	11.80	—	—	1.24	1.16	0.95	1.37
ZN110H	0 26715 20290 4	1	12.40	—	—	1.24	1.16	0.95	1.37
ZN110HL	0 26715 20298 0	1	13.70	—	—	1.24	1.15	1.21	1.73
ZN110L	0 26715 20112 9	1	13.20	—	—	1.24	1.16	1.21	1.74
ZN110M	0 26715 20292 8	1	12.30	—	—	1.23	1.14	0.95	1.33
ZN110ML	0 26715 20300 0	1	13.20	—	—	1.23	1.16	1.19	1.70
ZN80	0 26715 20110 5	1	12.10	—	—	1.25	1.15	0.93	1.34
ZN80L	0 26715 20114 3	1	13.80	—	—	1.24	1.16	1.19	1.71
ZN80M	0 26715 20293 5	1	12.60	—	—	1.24	1.16	0.96	1.38
ZN80ML	0 26715 20301 7	1	13.80	—	—	1.23	1.15	1.20	1.70