

OKONITE CABLES

STOCK CATALOG

“▲” *In Stock for Immediate Delivery*



**THE
OKONITE
COMPANY**



INDEX

Data Sheet
Section:Sheet

GLOSSARY OF TERMS AND DEFINITIONS

MEDIUM VOLTAGE POWER CABLES 2.4kV AND ABOVE

Single Conductor Cable

Okoguard Non-Shielded Okolon TS-CPE Type MV-90 (CT USE) 2.4kV	2:2
Okoguard Shielded Okoseal Type MV-105 (CT USE) 5/8kV	2:3
Okoguard Shielded Okoseal Type MV-105 5/8 kV	2:4
Okoguard Shielded Okoseal Type MV-105 (CT USE) 15kV	2:8
Okoguard Shielded Okoseal Type MV-105 15kV	2:9
Okoguard Shielded Okolon TS-CPE Type MV-105 (CT USE) 15kV	2:11
Okoguard Shielded Okoseal Type MV-105 35kV	2:16
Okoguard Shielded Okoseal 69kV	2:18

Multi-Conductor Cable

Okoguard Shielded Okoseal Type MV-105 (CT USE) 3/C 5/8kV	2:19
Okoguard Shielded Okoseal Type MV-105 (CT USE) 3/C 15kV	2:20
Okoguard Non-Shielded C-L-X Type MV-90 or MC-HL (CT USE) 2.4kV	2:21
Okoguard Shielded C-L-X Type MV-105 or MC-HL (CT USE) 5/8kV	2:22
Okoguard Shielded C-L-X Type MV-105 or MC-HL (CT USE) 15kV	2:24
Solid Type PILC 3/C 15kV	2:31

UNDERGROUND RESIDENTIAL DISTRIBUTION CABLE

Okoguard URO-J 15kV	2:35
Okoguard URO-J 15kV Filled Strand	2:36
Okoguard URO-J 25kV	2:39
Okoguard URO-J 35kV	2:40

LOW VOLTAGE CABLES TO 2kV

Single Conductor Cable

Okoguard Okolon TS-CPE Type RHH or RHW-2 or USE-2, VW-1 600V RW-90	3:1
Okoguard Okolon TS-CPE Type RHH or RHW-2, 2000V	3:10

Multi-Conductor Cable

C-L-X Type MC-HL for CT USE (XHHW-2) 600V	4:1
C-L-X Type MC (XHHW-2) 600V	4:2
Okonite-FMR Okoseal Type TC 600V	4:5
X-Olene - Okoseal Type TC-ER Control Cable (XHHW-2) 600V	4:8
C-L-X Type MC for CT USE (XHHW-2) 600V Control Cable	4:14
C-L-X Type MC-HL for CT USE (XHHW-2) 600V Control Cable	4:15

INDEX

Data Sheet
Section:Sheet

INSTRUMENTATION CABLES

Okoseal Type P-OS 300V5:2
Okoseal Type P-OS C-L-X 300V5:3
Type SP-OS Instrumentation Cbale5:13
Okoseal Type SP-OS C-L-X 300V5:14
Okoseal Type P-OS Thermocouple 300V5:18
C-L-X Okoseal Type P-OS Thermocouple 300V5:19
Okoseal-N Type P-OS 600V5:29
Okoseal-N Type SP-OS 600V5:31
Okoseal-N Type P-OS C-L-X Type MC-HL 600V5:40
Okoseal-N Type SP-OS C-L-X Type MC-HL 600V5:42
Okobus Type PLTC & Type ITC-ER Fieldbus Cable
Single Pair Type P-OS — Multi Pair Type SP-OS.....5:47
Okobus C-L-X.....5:48
C-L-X X-Olene P-OS, SP-OS5:49

SPECIAL PURPOSE CABLES

X-Ray Low Noise 65-250kV DC6:1
X-Ray 65-1000kV DC6:2
Okoguard Aerial Jumper Cable 15kV6:4
Okoguard-Okolon TS-CPE 5kV Airport Lighting Cable6:6

RAILROAD AND TRANSIT SYSTEM CABLES

Armored Signal Cable7:1
Track Wire7:6
Tower and Case Wire7:10
Case Wire7:11
Nylon Braid Case Wire7:12
Type DEL.....7:17

SPLICING AND TERMINATING PRODUCTS

C-L-X Terminating Tool Kit 6:5
Color Code Tables OSL
Miscellaneous Information OSL

INDEX

Data Sheet
Section:Sheet

INSTRUMENTATION CABLES

Okoseal Type P-OS 300V	5:2
Okoseal Type P-OS C-L-X 300V	5:3
Type SP-OS Instrumentation Cable	5:13
Okoseal Type SP-OS C-L-X 300V	5:14
Okoseal Type P-OS Thermocouple 300V	5:18
C-L-X Okoseal Type P-OS Thermocouple 300V	5:19
Okoseal-N Type P-OS 600V	5:29
Okoseal-N Type SP-OS 600V	5:31
Okoseal-N Type P-OS C-L-X Type MC-HL 600V	5:40
Okoseal-N Type SP-OS C-L-X Type MC-HL 600V	5:42
Okobus Type PLTC & Type ITC-ER Fieldbus Cable Single Pair Type P-OS — Multi Pair Type SP-OS.....	5:47
Okobus C-L-X.....	5:48

SPECIAL PURPOSE CABLES

X-Ray Low Noise 65-250kV DC	6:1
X-Ray 65-100kV DC	6:2
Okoguard Aerial Jumper Cable 15kV	6:4
Okoguard-Okolon TS-CPE 5kV Airport Lighting Cable	6:6

RAILROAD AND TRANSIT SYSTEM CABLES

Armored Signal Cable	7:1
Track Wire	7:6
Tower and Case Wire	7:10
Case Wire	7:11
Nylon Braid Case Wire	7:12
Type DEL.....	7:17

SPLICING AND TERMINATING PRODUCTS

C-L-X Terminating Tool Kit	6:5
Color Code Tables	OSL
Miscellaneous Information	OSL

GLOSSARY

INDUSTRY ASSOCIATIONS

ABS American Bureau of Shipping.

AEIC Association of Edison Illuminating Companies.

ANSI American National Standards Institute.

AREMA American Railway Engineering and Maintenance of Way Association

ASTM American Society for Testing and Materials.

ICEA Insulated Cable Engineers Association (formerly IPCEA).

IEC International Electrotechnical Commission

IEEE Institute of Electrical and Electronics Engineers.

NEC National Electrical Code.

NEMA National Electrical Manufacturers Association.

NFPA National Fire Protection Association.

GOVERNMENT AGENCIES

OSHA Occupational Safety and Health Act administered by U.S. Dept. of Labor which establishes employee safety standards in all industrial and commercial establishments.

RUS Rural Utility Systems of the U.S. Department of Agriculture, formerly REA.

FAA Federal Aviation Administration

EPA Environmental Protection Agency

DOE Department of Energy

FERC Federal Energy Regulatory Commission

OKONITE REGISTERED TRADE NAMES

C-L-X® Continuous-Lightweight-Exterior. Welded and corrugated, impervious metallic sheathed cables.

LOXARMOR® An interlocked "S" shaped armor cable covering, normally galvanized steel or aluminum.

OKOBON® A moisture resistant cable finish consisting of an aluminum/copolymer tape fused to itself and to an overall jacket.

OKOBUS Fieldbus instrumentation cable.

OKOCLEAR TP® (TPPO) Thermoplastic Polyolefin low smoke/zero halogen jacket compound.

OKOCLEAR TS® Thermosetting Polyolefin low smoke/zero halogen jacket compound.

OKOGUARD® Okonite's exclusive ethylene-propylene rubber (EPR) based, thermosetting insulation, with an optimum balance of electrical and physical properties unequalled in other solid dielectrics, used on power cables rated 600 V and above. (43rd Anniversary - 2011)

OKOLENE® Thermoplastic polyethylene or polypropylene based insulation or jacket compound.

OKONITE® Okonite's exclusive ethylene propylene rubber (EPR) based, thermosetting insulation used up to 2000V.

OKONITE-FMR® Okonite's exclusive flame and moisture resistant ethylene propylene rubber (EPR) insulation used up to 2000V.

OKOGUARD-OKOLON® Composite insulation system consisting of a layer of EPR and covered with a chlorinated thermoset compound.

OKO-PACK® Okonite's unique compact round conductor shape and design.

OKOSEAL® A PVC insulation or jacketing compound with excellent resistance to flame and most chemicals.

OKOSEAL-N® PVC insulated and nylon jacketed low voltage conductors, Type THHN, THWN-2 and TFN.

OKOLON TP-CPE® Thermoplastic moisture resistant CPE compound serving as an outer jacket.

OKOLON TS-CPE® Thermoset moisture resistant flame retardant CPE outer jacket.

OKOTHERM® Heat resistant silicone rubber based insulation for use in high temperature locations.

OKOZEL® Okonite's name for its ETFE based flame and radiation resistant insulating and jacketing compound.

P-30® Okolene-Okoseal insulated 600V multiple and single conductor control cable.

P-45® Okolene-Okoseal Insulated 1000V Multiple Conductor Control Cable.

X-OLENE® Okonite's name for its XLPE insulation and jacket.

STANDARD TERMS

AWG American Wire Gauge, based on the circular mil system where 1 mil equals 0.001 inch.

CIC Cable in Conduit for buried distribution systems.

CIC Circuit Integrity flame retardant cables

C-L-X-M C-L-X Marine Shipboard Cable

CPE Chlorinated Polyethylene jacketing material.

CSA Canadian Standards Association. An independent organization which implements and monitors the commercial and consumer electrical product standards. The CSA assures compliance to the various Canadian Electrical Code requirements.

CT Designation given to cables meeting UL requirements for cable tray use.

CTC Designation for Centralized Traffic Control Code Line cable.

CWCMC UL's designation for 600 volt C-L-X marine shipboard cable - "continuously welded corrugated MC" cable.

DEL Diesel Electric Locomotive and car wiring with Okonite insulation and Okolon jacket.

EPR Ethylene Propylene Rubber insulating compound ingredient.

ER Exposed Run, UL term designating cables approved for open wire applications.

ETFE Modified Ethylene Tetrafluoroethylene compound (Okozel) used for insulation and jackets.

FIELDBUS CABLE - High Speed digital signal transmission instrumentation cable having specific electrical characteristics.

FPL Power limited Fire Protective Signal Cable (NEC Art. 760). 300V rated

FMR Flame and Moisture Retardant.

HL Designation given to MC and ITC cables meeting NEC and UL requirements for use in Division 1 hazardous locations.

INSULATION LEVEL-100% Cable for use on grounded systems or where the system is provided with relay protection such that grounds faults will be cleared as rapidly as possible but in any case within one minute.

INSULATION LEVEL-133% Cable for use on ungrounded or grounded systems or where the faulted section will be de-energized in a time not exceeding one hour.

ITC Instrumentation Tray Cable for instrumentation & control circuits operating $\leq 150V$ and ≤ 5 amps., per NEC Article 727.

kcmil A unit of conductor area in thousands of circular mils. (Formerly MCM).

LOCA Loss of Coolant Accident, IEEE 383 defines test requirements.

LCS Longitudinal Corrugated Shield.

GLOSSARY (continued)

MC Metal-Clad cable. NEC type designation for power and control cables enclosed in a welded and corrugated metallic sheath (C-L-X), or an interlocking tape armor (Loxarmor). (Article 330)

MC-HL Metal-Clad cable listed for hazardous locations

mil 0.001 inch.

MV Medium Voltage cable. NEC designation for single & multiple conductor insulated cable rated 2001 to 35,000 volts. (NEC Article 328)

NPLF Non-Power Limited Fire Protective Signal Cable (NEC Art. 760). 600V rated

OKO-MARINE UL designation for non-armored Marine Shipboard Cable.

PLTC Type designation for Power-Limited Tray Cable for use in Class 2 or 3 power-limited circuits; instrumentation, supervisory control, and thermocouple extension.

P-NS Single pair or triad, Non Shielded, instrumentation or thermocouple extension cable.

P-OS Single or multi Pairs or Triads with Overall Shield, instrumentation or thermocouple extension cable.

POWER-LIMITED CIRCUIT Circuit either inherently limited requiring no overcurrent protection or limited by a combination of a power source and overcurrent protection.

PVC Polyvinyl Chloride insulating and jacketing material which is usually flame retardant and resistant to many chemicals.

P-104 Okonite's identification number issued by the Pennsylvania Department of Environmental Resources.

RHH NEC conductor type designation for conductors with Heat resistant rubber or XLPE insulation, for use in dry locations.

RHW-2 NEC conductor type designation for conductors with Heat and Moisture resistant rubber or XLPE insulation, for use in 90°C wet or dry locations.

RTA Thermoplastic insulated, aluminum shielded, polyethylene jacketed communication cable.

SCREEN A semiconducting nonmetallic layer used under and over the insulation of

power cables rated over 2kV to reduce electrical stresses and corona

SEMICONDUCTING An extruded layer or tape of such resistance that when applied between two elements of a cable the adjacent surfaces of the two elements will maintain substantially the same potential.

SHIELD A nonmagnetic, metallic material applied over an insulated conductor(s) to confine the electric field to the insulation.

SP-OS Multiple Shielded Pairs or Triads with Overall Shield, instrumentation or thermocouple extension cable.

TC NEC type designation for power and control tray cable. (Article 336)

TFN NEC conductor type designation for PVC insulated nylon jacketed conductors in sizes #18 and 16 AWG for use in dry locations.

THERMOCOUPLE CABLE - A cable consisting of two dissimilar metals or alloys that, when electrically joined at one end can be used to measure temperature. These cables have no voltage rating.

THHN NEC conductor type designation for PVC insulated nylon jacketed conductors for use in dry locations.

THWN-2 NEC conductor type designation for PVC insulated nylon jacketed conductors for use in 90°C wet or dry locations.

TPPO Thermoplastic Polyolefin, a thermoplastic jacket material with low smoke characteristics and is free of halogens.

UL Underwriters Laboratories. An independent organization which examines, tests, lists and periodically inspects equipment to appropriate standards.

URO-J Underground Residential distribution-Okoguard (EPR) insulation-Okolene Jacket employing a concentric neutral.

USE Underground Service Entrance cable. (NEC Article 338)

VERTICAL TRAY FLAME TEST

Conducted per UL, IEEE or ICEA procedures to demonstrate that a single conductor (1/0 AWG and larger) or multi-conductor cable will not propagate a fire in the defined test.

VOLTAGE LEVELS

Power-Limited - 0-300 Volts

Low Voltage - 600-2000 Volts

Medium Voltage - 2400-46000 Volts

High Voltage - >46 to 345kV

VOLTAGE RATING kV, industry convention to identify voltage levels, phase to phase voltage.

VW-1 Basic flammability test for single conductors; employs a tirrill burner applied intermittently to a Vertical Wire.

XHHW-2 NEC conductor type designation for conductors with Heat and Moisture resistant thermoset insulation for use in 90°C wet or dry locations.

XLPE Cross-Linked Polyethylene insulating compound.

XLPO Cross Linked Polyolefin, a thermoset jacket material with low smoke characteristics and is free of halogens.

Z NEC conductor type designation for conductors with ETFE insulation for use in dry locations.

ZW NEC conductor type designation for conductors with ETFE insulation for use in wet or dry locations.

CONDUCTOR IDENTIFICATION INFORMATION

E-1 Color sequences for utility conductor identification, see Appendix E, Table E-1, ICEA Standard S-73-532, includes green and white.

E-2 Color sequence for industrial conductor identification, see Appendix E, Table E-2, ICEA Standard S-73-532, excludes green and white.

METHOD-1 Conductor identification, colored compounds with tracers in accordance with the ICEA standard.

METHOD-2 Conductor identification, neutral compounds with tracers in accordance with the ICEA Standard.

METHOD-3 Conductor identification, neutral or single colored compounds with surface printing of numbers and color designations in accordance with the ICEA Standard.

METHOD-4 Conductor identification, neutral or single colored compounds with surface printing of numbers in accordance with the ICEA Standard.

METHOD-5 Conductor identification, individual color coding with braids in accordance with the ICEA Standard.



Okoguard®-Okolon® TS-CPE Type MV-90

2.4 kV Nonshielded Power Cable

One Okopact® (Compact Stranded)
Copper Conductor/90°C Rating Wet or Dry
For Cable Tray Use-Sunlight Resistant



- A Uncoated, Okopact (Compact Stranded) Copper Conductor
- B Strand Screen-Extruded Semiconducting EPR
- C Insulation-Okoguard EPR
- D Jacket-Okolon TS-CPE

Insulation

Okoguard is Okonite's registered trade name for its exclusive ethylene-propylene rubber (EPR) based, thermosetting compound, whose optimum balance of electrical and physical properties is unequalled in other solid dielectrics. Okoguard insulation, with the distinctive red color and a totally integrated EPR system, provides the optimum balance for long, problem free service.

Jacket

The Okolon TS-CPE jacket on this cable is a vulcanized chlorinated polyethylene based compound which is mechanically rugged, flame, radiation and oil resistant.

Applications

Okoguard-Okolon TS-CPE 2.4 kV cables are heavy duty nonshielded cables designed for use at up to 2.4 kV phase-to-phase in wet or dry locations in accordance with NEC Section 310.10.

Okoguard-Okolon TS-CPE nonshielded cables are recommended for power distribution and motor circuits in generating plants and substations; in industrial and commercial buildings.

Single conductors may be installed in industrial or commercial occupancies in triplexed or random lay in any raceway or duct in wet or dry locations, or in open runs as permitted by NEC Article 396.

Sizes 1/0 AWG and larger, may be installed in cable trays where permitted by NEC Section 392.10.

Specifications

Conductor: Annealed uncoated copper compact stranded per ASTM B-496.

Strand Screen: Extruded semiconducting EPR strand screen. Meets or exceeds electrical and physical requirements of ICEA S-96-659/NEMA WC71 and UL 1072.

Insulation: Meets or exceeds electrical and physical requirements of ICEA S-96-659/NEMA WC71 and UL 1072.

Jacket: Meets or exceeds electrical and physical requirements of ICEA S-96-659/NEMA WC71 for chlorinated polyethylene jackets.

UL listed as Type MV-90, sunlight resistant, -40°C and for use in cable tray in accordance

with UL 1072. CSA listed as RW90 as 5kV non-shielded (FT4 1/0 and larger) -40°C in accordance with CSA C22.2 No 38.

1/C non-shielded cables can surface discharge in service when in a random phase spacing or when in contact with grounded surfaces.

Product Features

- Okoguard cables meet or exceed all recognized industry standards (UL, CSA, NEMA/ICEA, IEEE).
- 90°C continuous operating temperature.
- 130°C emergency rating.
- 250°C short circuit rating
- Passes UL and IEEE 383 and 1202 (1/0 and larger) Vertical Tray Flame Test.
- Sizes 1/0 and larger meet CSA FT4 Vertical Tray Flame Test.
- Sizes #1 and smaller meet CSA FT1.
- Excellent corona resistance.
- Radiation resistant.
- Exceptional resistance to "treeing".
- Stress cones not required.
- Moisture resistant.
- Resistant to most oils, acids, and alkalis.
- Sunlight Resistant.
- Sizes #6 and #8 AWG are identified as FAA-L-824, Type B 5kV rated.

Okoguard-Okolon TS-CPE Type MV-90

2.4 kV Nonshielded Power Cable

One Okopact (Compact Stranded)
Copper Conductor/90°C Rating Wet or Dry
For Cable Tray Use-Sunlight Resistant



Product Data Section 2: Sheet 2

Catalog Number (1)	Conductor Size AWG or kcmil		Conductor Size -mm ²		Insulation Thickness -mils		Jacket Thickness -mm		Jacket Thickness -mils		Approx. O.D. - mm		Approx. O.D. - Inches		Approx. Net Weight lbs./1000'		Approx. Ship Weight lbs./1000'		Ampacities (2) Conduit in Air		Ampacities (3) Underground Duct		Ampacities (4) Cable Tray		Conductor Size Inches (5)*		
*▲ 114-24-2213	8	8.4	125	3.18	80	2.03	0.60	15.1	215	250	55	64	-	2													
*▲ 114-24-2217	6	13.3	125	3.18	80	2.03	0.63	16.0	260	295	75	85	-	2													
▲ 114-24-2219	4	21.2	125	3.18	80	2.03	0.67	17.1	328	368	97	110	-	2													
▲ 114-24-2221	2	33.6	125	3.18	80	2.03	0.73	18.6	427	492	130	145	-	2													
114-24-2223	1	42.4	125	3.18	80	2.03	0.76	19.4	493	558	155	170	-	2½													
▲ 114-24-2225	1/0	53.5	125	3.18	80	2.03	0.80	20.3	580	645	180	195	195	2½													
▲ 114-24-2227	2/0	67.4	125	3.18	80	2.03	0.88	22.4	682	742	205	220	225	2½													
114-24-2229	3/0	85.0	125	3.18	95	2.41	0.96	24.5	838	908	240	250	260	3													
▲ 114-24-2231	4/0	107.0	125	3.18	95	2.41	0.97	24.6	991	1086	280	290	300	3													
114-24-2233	250	127.0	140	3.56	110	2.79	1.08	27.4	1198	1293	315	320	335	3													
▲ 114-24-2237	350	177.0	140	3.56	110	2.79	1.18	29.9	1555	1660	385	385	410	3½													
▲ 114-24-2243	500	253.0	140	3.56	110	2.79	1.29	32.9	2075	2205	475	470	520	3½													
▲ 114-24-2249	750	380.0	155	3.94	125	3.18	1.54	39.0	3034	3224	600	585	675	5													
114-24-2251	1000	507.0	155	3.94	125	3.18	1.70	43.0	3891	4141	690	670	805	5													

* Marked "FAA L-824 5kV Type B".

Visit Okonite's web site, www.okonite.com for the most up to date dimensions.

▲ **Authorized stock item.** Available from our Customer Service Center.

Aluminum Okopact Conductors

(1) Aluminum conductors are available on special order.

Ampacities

(2) Ampacities are in accordance with Table 310.60(C)(73) of the NEC for three single Type MV-90 conductors, or single conductors twisted together (triplexed) and installed in an isolated conduit in air at an ambient temperature of 40°C and a conductor temperature of 90°C.

(3) Ampacities are in accordance with Table 310.60(C)(77) of the NEC for three single conductors or triplexed cable in one underground raceway, three feet deep with a conductor temperature of 90°C, 100% Load Factor, an ambient earth temperature of 20°C, and thermal resistance (RHO) of 90.

(4) Ampacities based on single Type MV-90 conductors, or single conductors twisted together (triplexed, quadruplexed, etc.), size 1/0 Awg and larger, installed in uncovered cable tray in accordance with Section 392.80(B) of the NEC at an ambient temperature of 40°C and a conductor temperature rating of 90°C.

In accordance with NEC Section 392.80(B)(2)(a), the ampacities are 75% of the values given in NEC Table 310.60(C)(69) (copper conductors). Where the cable tray is covered for more than six feet with solid unventilated covers, the ampacities shall not exceed 93% of the values shown above.

Refer to the NEC, IEEE/ICEA-S-135 Power Cable Ampacities, or the Okonite Engineering Data Bulletin for other ambient temperatures, circuit configurations or installation requirements.

(5) Recommended size of rigid or nonmetallic conduit for three conductors based on 40% maximum fill.

*The jam ratio, conduit I.D. to cable O.D. should be checked to avoid possible jamming.



Okoguard®-Okoseal® Type MV-105

5/8kV Shielded Power Cable

One Okopact® (Compact Stranded) Copper Conductor/105°C Rating
5kV-133% or 8kV-100% Insulation Level

For Cable Tray Use - Sunlight Resistant



- A Uncoated, Okopact (Compact Stranded) Copper Conductor
- B Strand Screen-Extruded Semiconducting EPR
- C Insulation-Okoguard EPR
- D Insulation Screen-Extruded Semiconducting EPR
- E Shielding-CopperTape
- F Jacket-Okoseal

Insulation

Okoguard is Okonite's registered trade name for its exclusive ethylene-propylene rubber (EPR) based, thermosetting compound, whose optimum balance of electrical and physical properties is unequalled in other solid dielectrics.

Okoguard insulation, with the distinctive red color and a totally integrated EPR system, provides the optimum balance of electrical and physical properties for long, problem free service.

The triple tandem extrusion of the screens with the insulation provides optimum electrical characteristics.

Jacket

The Okoseal (PVC) jacket supplied with this cable is mechanically rugged and has excellent resistance to oil, acids and most chemicals.

Applications

Okoguard shielded Okoseal Type MV-105 power cables are recommended for use as feeder circuits, in electric utility generating stations, for distribution circuits, and for feeders or branch circuits in industrial and commercial installations.

Type MV cables may be installed in wet or dry locations, indoors or outdoors (exposed to sunlight), in any raceway or underground duct, directly buried if installed in a system with a grounding conductor in close proximity that conforms with NEC Section 250.4(A)(5), or messenger supported in industrial establishments and electric utilities. Sizes 1/0 AWG and larger may also be installed in cable tray.

Specifications

Conductor: Annealed uncoated copper compact stranded per ASTM B-496.

Strand Screen: Extruded semiconducting EPR strand screen. Meets or exceeds electrical and physical requirements of ICEA S-93-639/NEMA WC74 & S-97-682, AEIC CS8, CSA C68.3 and UL 1072.

Insulation: Meets or exceeds electrical and physical requirements of ICEA S-93-639/NEMA WC74 & S-97-682, AEIC CS8, CSA C68.3 and UL 1072.

Insulation Screen: Extruded semiconducting EPR insulation screen applied directly over the insulation. Meets or exceeds electrical and physical requirements of ICEA S-93-639/NEMA WC74 & S-97-682, AEIC CS8, CSA C68.3 and UL 1072.

Shield: 5 mil bare copper tape helically applied with 25% minimum overlap.

Jacket: Meets or exceeds electrical and physical requirements of ICEA S-93-639/NEMA WC74 & S-97-682, CSA C68.3 and UL 1072 for polyvinyl chloride jackets.

UL Listed as Type MV-105 and sunlight resistant, in accordance with UL 1072.

CSA C68.3 listed and rated FT4.

Product Features

- Triple tandem extruded, all EPR system.
- Okoguard cables meet or exceed all recognized industry standards (UL, AEIC, NEMA/ICEA, IEEE).
- 105°C continuous operating temperature.
- 140°C emergency rating.
- 250°C short circuit rating.
- Passes UL and IEEE 383 and 1202 (1/0 AWG and larger) Vertical Tray Flame Test.
- Excellent corona resistance.
- Screens are clean stripping.
- Exceptional resistance to "treeing".
- Exceptional resistance to moisture.
- Resistant to most oils, acids, and alkalis.
- Sunlight resistant.
- For Cable Tray Use.
- CSA FT4.
- CSA ≤ 350: LTDD (-25C)
- CSA ≥ 500: LTGG (-40C)
- Improved Temperature Rating.

Okoguard-Okoseal Type MV-105

5/8kV Shielded Power Cable

One Okopact (Compact Stranded)

Copper Conductor/ 105°C Rating

5kV-133% or 8kV-100% Insulation Level

For Cable Tray Use - Sunlight Resistant



Product Data Section 2: Sheet 3

Okoguard Insulation: 115 mils (2.92mm), 5kV—133% or 8kV—100% Insulation Level

Catalog Number (1)	Conductor Size AWG or kcmil	Conductor Size -mm ²	Approx. Dia. over Insulation (in.)	Approx. Dia. over Screen (in.)	Jacket Thickness - mils	Jacket Thickness - mm	Approx. O.D. - Inches	Approx. O.D. - mm	Approx. Net Weight lbs./1000'	Approx. Ship Weight lbs./1000'	Ampacities Conduit in Air (2)	Ampacities Underground Duct (3)	Ampacities Cable Tray (4)	Conduit Size Inches (5)*
▲ 114-23-3824	1/0	53.5	0.61	0.67	60	1.52	0.81	20.6	615	655	200	210	220	2½
▲ 114-23-3826	2/0	67.4	0.65	0.71	60	1.52	0.85	21.6	720	775	225	235	245	2½
114-23-3865	3/0	85.0	0.70	0.76	80	2.03	0.95	24.1	895	950	270	270	290	3
▲ 114-23-3832	4/0	107.0	0.75	0.81	80	2.03	0.99	25.2	1030	1090	305	310	335	3
▲ 114-23-3834	250	127.0	0.80	0.86	80	2.03	1.05	26.7	1185	1250	355	345	370	3
▲ 114-23-3838	350	177.0	0.89	0.95	80	2.03	1.14	29.0	1540	1625	430	415	460	3½
▲ 114-23-3846	500	253.0	1.01	1.07	80	2.03	1.26	32.0	2055	2155	530	505	580	3½
▲ 114-23-3873	750	380.0	1.19	1.26	80	2.03	1.45	36.9	2940	3120	665	630	750	4
114-23-3855	1000	507.0	1.34	1.40	80	2.03	1.59	40.4	3781	3960	770	720	900	4

Visit www.okonite.com for the most current cable data.

▲ **Authorized stock item.** Available from our Customer Service Center.

Aluminum Conductors

(1) Aluminum conductors are available on special order.

Ampacities

(2) Ampacities are in accordance with Table 310.60(C)(73) of the NEC for three single Type MV-105 5kV conductors or single conductors twisted together (triplexed) and installed in an isolated conduit in air at an ambient temperature of 40°C and a conductor temperature of 105°C. Refer to Table 310.60(C)(73) for 8kV ampacities

(3) Ampacities are in accordance with Table 310.60(C)(77) of the NEC for three single 5kV conductors or triplexed cable in one underground raceway, three feet deep with a conductor temperature of 105°C, 100% Load Factor, an ambient earth temperature of 20°C and thermal resistance (RHO) of 90. Refer to Table 310.60(C)(77) for 8kV ampacities.

(4) Ampacities based on single Type MV-105 5kV conductors, or single conductors twisted together (triplexed, quadruplexed, etc.) size 1/0 AWG and larger, installed in uncovered cable tray in accordance with Section 392.80(B) of the NEC at an ambient temperature of 40°C and a conductor temperature rating of 105°C. In accordance with NEC Section 392.80(B)(2)(a) the ampacities are 75% of the values given in NEC Table 310.60(C)(69) (copper conductors). Where the cable tray is covered for more than six feet with solid unventilated covers, the ampacities shall not exceed 93% of the values shown above. Refer to Table 310.60(C)(69) for 8kV ampacities.

Refer to the NEC, IEEE/ICEA S-135 Power Cable Ampacities, or the Okonite Engineering Data Bulletin for installation in duct banks, multiple point grounded shields, other ambient temperatures, circuit configurations or installation requirements.

(5) Recommended size of rigid or nonmetallic conduit for three conductors based on 40% maximum fill.

*The jam ratio, conduit I.D. to cable O.D. should be checked to avoid possible jamming.



Okoguard®-Okoseal® Type MV-105

5/8kV Shielded Power Cable

One Okopact® (Compact Stranded) Copper Conductor/105°C Rating
5kV-133% or 8kV-100% Insulation Level



- A Uncoated, Okopact (Compact Stranded) Copper Conductor
- B Strand Screen-Extruded Semiconducting EPR
- C Insulation-Okoguard EPR
- D Insulation Screen-Extruded Semiconducting EPR
- E Shielding-CopperTape
- F Jacket-Okoseal

Insulation

Okoguard is Okonite's registered trade name for its exclusive ethylene-propylene rubber (EPR) based, thermosetting compound, whose optimum balance of electrical and physical properties is unequalled in other solid dielectrics. Okoguard insulation, with the distinctive red color and a totally integrated EPR system, provides the optimum balance of electrical and physical properties for long, problem free service.

The triple tandem extrusion of the screens with the insulation provides optimum electrical characteristics.

Jacket

The Okoseal (PVC) jacket supplied with this cable is mechanically rugged and has excellent resistance to oil, acids and most chemicals.

Applications

Okoguard shielded Okoseal Type MV-105 power cables are recommended for distribution circuits, and for feeders or branch circuits.

Type MV cables may be installed in wet or dry locations, indoors or outdoors (exposed to sunlight), in any raceway or underground duct, directly buried if installed in a system with a grounding conductor in close proximity that conforms with NEC Section 250.4(A)(5), or messenger supported in industrial establishments and electric utilities.

Specifications

Conductor: Annealed uncoated copper compact stranded per ASTM B-496.

Strand Screen: Extruded semiconducting EPR strand screen. Meets or exceeds electrical and physical requirements of ICEA S-93-639/NEMA WC74 & S-97-682, AEIC CS8 and UL 1072.

Insulation: Meets or exceeds electrical and physical requirements of ICEA S-93-639/NEMA WC74 & S-97-682, AEIC CS8 and UL 1072.

Insulation Screen: Extruded semiconducting EPR insulation screen applied directly over the insulation. Meets or exceeds electrical and physical requirements of ICEA S-93-639/NEMA WC74 & S-97-682, AEIC CS8 and UL 1072.

Shield: 5 mil bare copper tape helically applied with 12.5% nominal overlap.

Jacket: Meets or exceeds electrical and physical requirements of ICEA S-93-639/NEMA WC74 & S-97-682, and UL 1072 for polyvinyl chloride jackets.

UL Listed as Type MV-105 and sunlight resistant, in accordance with UL 1072.

Cables listed to CSA C68.3 are also available.

Product Features

- Triple tandem extruded, all EPR system.
- Okoguard cables meet or exceed all recognized industry standards (UL, AEIC, NEMA/ICEA, IEEE).
- 105°C continuous operating temperature.
- 140°C emergency rating.
- 250°C short circuit rating.
- Excellent corona resistance.
- Screens are clean stripping.
- Exceptional resistance to "treeing".
- Exceptional resistance to moisture.
- Resistant to most oils, acids, and alkalis.
- Sunlight resistant.
- Improved Temperature Rating.

Okoguard-Okoseal Type MV-105

5/8kV Shielded Power Cable

One Okopact (Compact Stranded)

Copper Conductor/ 105°C Rating

5kV-133% or 8kV-100% Insulation Level



Product Data Section 2: Sheet 4

Okoguard Insulation: 115 mils (2.92mm), 5kV—133% or 8kV—100% Insulation Level

Catalog Number (1)	Conductor Size AWG or kcmil		Conductor Size -mm ²		Approx. Dia. over Insulation (in.)		Approx. Dia. over Screen (in.)		Jacket Thickness - mils		Jacket Thickness - mm		Approx. O.D. - Inches		Approx. O.D. - mm		Approx. Net Weight lbs./1000'		Approx. Ship Weight lbs./1000'		Ampacities Conduit in Air (2)		Ampacities Underground Duct (3)		Conduit Size Inches (4)*		
▲ 114-23-3817	6	13.3	0.44	0.50	60	1.52	0.64	16.3	285	320	84	92	2														
▲ 114-23-3819	4	21.2	0.48	0.54	60	1.52	0.69	17.5	355	385	110	120	2														
▲ 114-23-3821	2	33.6	0.54	0.60	60	1.52	0.74	18.8	455	495	145	155	2														
114-23-3823	1	42.4	0.58	0.63	60	1.52	0.77	19.5	530	570	175	180	2½														
▲ 114-23-3825	1/0	53.5	0.61	0.67	60	1.52	0.81	20.6	610	645	200	210	2½														
▲ 114-23-3827	2/0	67.4	0.65	0.71	60	1.52	0.85	12.6	710	765	225	235	2½														
114-23-3829	3/0	85.0	0.70	0.75	80	2.03	0.93	23.6	880	935	270	270	3														
▲ 114-23-3831	4/0	107.0	0.75	0.81	80	2.03	0.99	25.1	1035	1100	305	310	3														
▲ 114-23-3833	250	127.0	0.80	0.86	80	2.03	1.04	26.4	1180	1245	355	345	3														
▲ 114-23-3837	350	177.0	0.89	0.95	80	2.03	1.14	29.0	1535	1625	430	415	3½														
▲ 114-23-3843	500	253.0	1.01	1.07	80	2.03	1.25	31.8	2050	2150	530	505	3½														
▲ 114-23-3849	750	380.0	1.19	1.25	80	2.03	1.43	36.8	2935	3110	665	630	4														
114-23-3851	1000	507.0	1.33	1.39	80	2.03	1.57	39.9	3650	3825	770	720	5														

Visit www.okonite.com for the most current cable data.

▲ **Authorized stock item** Available from our Customer Service Center.

Minimum Manufacturing Quantity for non-stock items is 5000'.

Aluminum Conductors

(1) Aluminum conductors are available on special order.

Ampacities

(2) Ampacities are in accordance with Table 310.60(C)(73) of the NEC for three single Type MV-105 5kV conductors or single conductors twisted together (triplexed) and installed in an isolated conduit in air at an ambient temperature of 40°C and a conductor temperature of 105°C. Refer to Table 310.60(C)(73) for 8kV ampacities

(3) Ampacities are in accordance with Table 310.60(C)(77) of the NEC for three single 5kV conductors or triplexed cable in one underground raceway, three feet deep with a conductor temperature of 105°C, 100% Load Factor, an ambient earth temperature of 20°C and thermal resistance (RHO) of 90. Refer to Table 310.60(C)(77) for 8kV ampacities.

Refer to the NEC, IEEE/ICEA S-135 Power Cable Ampacities, or the Okonite Engineering Data Bulletin for installation in duct banks, multiple point grounded shields, other ambient temperatures, circuit configurations or installation requirements.

(4) Recommended size of rigid or nonmetallic conduit for three conductors based on 40% maximum fill.

*The jam ratio, conduit I.D. to cable O.D. should be checked to avoid possible jamming.



Okoguard®-Okoseal® Type MV-105

15kV Shielded Power Cable

One Okopact® (Compact Stranded) Copper Conductor/105°C Rating
100% and 133% Insulation Level

For Cable Tray Use-Sunlight Resistant



- A Uncoated, Okopact (Compact Stranded) Copper Conductor
- B Strand Screen-Extruded Semiconducting EPR
- C Insulation-Okoguard EPR
- D Insulation Screen-Extruded Semiconducting EPR
- E Shield- Copper Tape
- F Jacket-Okoseal

Insulation

Okoguard is Okonite's registered trade name for its exclusive ethylene-propylene rubber (EPR) based, thermosetting compound, whose optimum balance of electrical and physical properties is unequaled in other solid dielectrics. Okoguard insulation, with the distinctive red color and a totally integrated EPR system, provides the optimum balance of electrical and physical properties for long, problem free service.

The triple tandem extrusion of the screens with the insulation provides optimum electrical characteristics.

Jacket

The Okoseal (PVC) jacket supplied with this cable is mechanically rugged and has excellent resistance to flame, oil, acids and most chemicals.

Applications

Okoguard shielded Okoseal Type MV-105 power cables are recommended for use as feeder circuits, in electric utility generating stations, for distribution circuits, and for feeders or branch circuits in industrial and commercial installations.

Type MV cables may be installed in wet or dry locations, indoors or outdoors (exposed to sunlight), in any raceway or underground duct, directly buried if installed in a system with a grounding conductor in close proximity that conforms with NEC Section 250.4(A)(5), or messenger supported in industrial establishments and electric utilities. Sizes 1/0 AWG and larger may also be installed in cable tray.

Specifications

Conductor: Annealed uncoated copper compact stranded per ASTM B-496.

Strand Screen: Extruded EPR semiconducting strand screen. Meets or exceeds electrical and physical requirements of ICEA S-93-639/NEMA WC74 & S-97-682, AEIC CS8, CSA C68.3 and UL 1072.

Insulation: Meets or exceeds electrical and physical requirements of ICEA S-93-639/NEMA WC74 & S-97-682, AEIC CS8, CSA C68.3 and UL 1072.

Insulation Screen: Extruded EPR semiconducting insulation screen applied directly over the insulation. Meets or exceeds electrical and physical requirements of ICEA

S-93-639/NEMA WC74 & S-97-682, AEIC CS8, CSA C68.3 and UL 1072.

Shield: 5 mil bare copper tape helically applied with 25% minimum overlap.

Jacket: Meets or exceeds electrical and physical requirements of ICEA S-93-639/NEMA WC74 & S-97-682, CSA C68.3 and UL 1072 for polyvinyl chloride jackets.

UL listed as Type MV-105, sunlight resistant and for use in cable tray in accordance with UL 1072.

CSA C68.3 listed and rated FT4.

Product Features

- Triple tandem extruded, all EPR system.
- Okoguard cables meet or exceed all recognized industry standards (UL, CSA, AEIC, NEMA/ICEA, IEEE).
- 105°C continuous operating temperature.
- 140°C emergency rating.
- 250°C short circuit rating.
- Passes the Vertical Tray Flame Test requirements of UL 1072 and IEEE 383 and 1202.
- Excellent corona resistance.
- Screens are clean stripping.
- Exceptional resistance to "treeing".
- Exceptional resistance to moisture.
- Resistant to most oils, acids, and alkalies.
- Sunlight resistant.
- For Cable Tray Use.
- CSA FT4.
- CSA ≤ 350: LTDD (-25C)
- CSA ≥ 500: LTGG (-40C)
- Improved Temperature Rating.

Okoguard-Okoseal Type MV-105

15kV Shielded Power Cable

One Okopact (Compact Stranded)

Copper Conductor/105°C Rating

100% and 133% Insulation Level

For Cable Tray Use-Sunlight Resistant



Product Data Section 2: Sheet 8

Catalog Number (1)	Conductor Size AWG or kcmil	Conductor Size -mm ²	Approx. Dia. over Insulation (in.)	Approx. Dia. over Screen (in.)	Jacket Thickness - mils	Jacket Thickness - mm	Approx. O.D. - Inches	Approx. O.D. - mm	Approx. Net Weight lbs./1000'	Approx. Ship Weight lbs./1000'	Ampacities (2)	Conduit in Air Ampacities (3)	Underground Duct Ampacities (4)	Cable Tray Conduit Size Inches (5)*
--------------------	--------------------------------	---------------------------------	---------------------------------------	-----------------------------------	-------------------------	-----------------------	-----------------------	-------------------	----------------------------------	-----------------------------------	----------------	----------------------------------	------------------------------------	---

Okoguard Insulation: 175 mils (4.45mm), 100% Insulation Level

115-23-3064	1/0	53.5	0.74	0.80	80	2.03	0.98	24.8	760	825	215	215	220	3
115-23-3066	2/0	67.4	0.78	0.84	80	2.03	1.02	25.8	870	935	255	245	250	3
115-23-3067	3/0	85.0	0.83	0.89	80	2.03	1.07	27.1	1005	1070	290	275	290	3
115-23-3069	4/0	107.0	0.88	0.94	80	2.03	1.12	28.4	1160	1240	330	315	335	3
115-23-3074	250	127.0	0.93	0.98	80	2.03	1.17	29.7	1330	1415	365	345	370	3½
115-23-3076	350	177.0	1.03	1.07	80	2.03	1.26	32.0	1700	1800	440	415	460	3½
115-23-3090	500	253.0	1.14	1.19	80	2.03	1.38	35.1	2230	2275	535	500	575	4
115-23-3091	750	380.0	1.32	1.37	80	2.03	1.55	39.4	3105	3340	655	610	745	5
115-23-3092	1000	507.0	1.47	1.52	80	2.03	1.71	43.4	3960	4215	755	690	890	5

Okoguard Insulation: 220 mils (5.59mm), 133% Insulation Level

▲ 115-23-3230	1/0	53.5	0.83	0.88	80	2.03	1.10	28.0	905	975	215	215	220	3
▲ 115-23-3232	2/0	67.4	0.87	0.92	80	2.03	1.11	28.2	970	1030	255	245	250	3
115-23-3234	3/0	85.0	0.92	0.98	80	2.03	1.16	29.4	1100	1185	290	275	290	3½
▲ 115-23-3236	4/0	107.0	0.96	1.02	80	2.03	1.21	30.7	1280	1370	330	315	335	3½
▲ 115-23-3238	250	127.0	1.01	1.07	80	2.03	1.26	32.0	1435	1520	365	345	370	3½
▲ 115-23-3240	350	177.0	1.11	1.17	80	2.03	1.35	34.3	1810	1940	440	415	460	4
▲ 115-23-3242	500	253.0	1.22	1.28	80	2.03	1.47	37.3	2350	2535	535	500	575	4
▲ 115-23-3243	750	380.0	1.40	1.46	80	2.03	1.65	41.9	3240	3480	655	610	745	5
▲ 115-23-3244	1000	507.0	1.55	1.60	110	2.79	1.86	47.1	4220	4490	755	690	890	6

Visit Okonite's web site, www.okonite.com for the most up to date dimensions.

▲ **Authorized Stock Item.** Available from our Customer Service Centers. Minimum Manufacturing Quantity for non-stock items is 5000'.

Aluminum Conductors

(1) Aluminum conductors are available on special order. To order aluminum conductors, change the first three digits of the catalog number from 115 to 135.

Ampacities

(2) Ampacities are in accordance with Table 310.60(C)(73) of the NEC for three single Type MV-105 conductors, or single conductors twisted together (triplexed) and installed in an isolated conduit in air at an ambient temperature of 40°C and a conductor temperature of 105°C.

(3) Ampacities are in accordance with Table 310.60(C)(77) of the NEC for three single conductors or triplexed cable in one underground raceway, three feet deep with a conductor temperature of 105°C, 100% Load Factor, an ambient earth temperature of 20°C, and thermal resistance (RHO) of 90.

Refer to the NEC, IEEE/ICEA S-135 Power Cable Ampacities, or the Okonite Engineering Data Bulletin EHB for installation in duct banks, multiple point

ground shields, other ambient temperatures, circuit configurations or installation requirements.

(4) Ampacities based on single Type MV-105 conductors, or single conductors twisted together (triplexed, quadruplexed, etc.) size 1/0 AWG and larger, installed in uncovered cable tray in accordance with Section 392.80(B) of the NEC at an ambient temperature of 40°C and a conductor temperature rating of 105°C. In accordance with NEC Section 392.80(B)(2)(a) (copper conductors), the values are 75% of the values given in table 310.69. Where the cable tray is covered for more than six feet with solid unventilated covers, the ampacities shall not exceed 93% of the values shown above.

(5) Recommended size of rigid or nonmetallic conduit for three conductors based on 40% maximum fill.

*The jam ratio, conduit I.D. to cable O.D. should be checked to avoid possible jamming.



Okoguard®-Okoseal® Type MV-105



15kV Shielded Power Cable

One Okopact® (Compact Stranded) Copper Conductor/105°C Rating
100% and 133% Insulation Level



- A Uncoated, Okopact (Compact Stranded) Copper Conductor
- B Strand Screen- Extruded Semiconducting EPR
- C Insulation-Okoguard EPR
- D Insulation Screen- Extruded semi-conducting EPR
- E Shield-Copper Tape
- F Jacket Okoseal

Insulation

Okoguard is Okonite's registered trade name for its exclusive ethylene-propylene rubber (EPR) based, thermosetting compound, whose optimum balance of electrical and physical properties is unequalled in other solid dielectrics. Okoguard insulation, with the distinctive red color and a totally integrated EPR system, provides the optimum balance of electrical and physical properties for long, problem free service.

The triple tandem extrusion of the screens with the insulation provides optimum electrical characteristics.

Jacket

The Okoseal (PVC) jacket supplied with this cable is mechanically rugged and has excellent resistance to oil, acids and most chemicals.

Applications

Okoguard shielded Okoseal Type MV-105 power cables are recommended for distribution circuits, and for feeders or branch circuits.

Type MV cables may be installed in wet or dry locations, indoors or outdoors (exposed to sunlight), in any raceway or underground duct, directly buried if installed in a system with a grounding conductor in close proximity that conforms with NEC Section 250.4(A)(5), or messenger supported in industrial establishments and electric utilities.

Specifications

Conductor: Annealed uncoated copper compact stranded per ASTM B-496.

Strand Screen: Extruded semiconducting EPR strand screen. Meets or exceeds electrical and physical requirements of ICEA S-93-639/NEMA WC74, AEIC CS8 and UL 1072.

Insulation: Meets or exceeds electrical and physical requirements of ICEA S-93-639/NEMA WC74 & S-97-682, AEIC CS8 and UL 1072.

Insulation Screen: Extruded semiconducting EPR insulation screen. Meets or exceeds electrical and physical requirements of ICEA S-93-639/NEMA WC74 & S-97-682, AEIC CS8 and UL 1072.

Shield: 5 mil bare copper tape helically applied with 12.5% nominal overlap.

Jacket: Meets or exceeds electrical and physical requirements of ICEA S-93-639/NEMA WC74 & S-97-682 and UL 1072 for polyvinyl chloride jackets. UL Listed as Type MV-105 and sunlight resistant in accordance with UL 1072. Cables listed to CSA C68.3 are also available.

Product Features

- Triple tandem extruded, all EPR system.
- Okoguard cables meet or exceed all recognized industry standards (UL, AEIC, NEMA/ICEA, IEEE).
- 105°C continuous operating temperature.
- 140°C emergency rating.
- 250°C short circuit rating.
- Excellent corona resistance.
- Screens are clean stripping.
- Exceptional resistance to "treeing".
- Moisture resistant.
- Resistant to most oils, acids, and alkalies.
- Sunlight resistant.
- Improved Temperature Rating.

Okoguard-Okoseal Type MV-105

15kV Shielded Power Cable

One Okopact (Compact Stranded)

Copper Conductor/105°C Rating



Product Data Section 2: Sheet 9

Catalog Number (1)	Conductor Size AWG or kcmil	Conductor Size - mm ²	Approx. Dia. over Insulation (in.)	Approx. Dia. over Screen (in.)	Jacket Thickness - mills	Jacket Thickness - mm	Approx. O.D. - Inches	Approx. O.D. - mm	Approx. Net Weight lbs./1000'	Approx. Ship Weight lbs./1000'	Ampacities (2) Conduit in Air	Ampacities (3) Direct Burial	Ampacities (4) Underground Duct	Conduit Size Inches (5)*
--------------------	--------------------------------	----------------------------------	---------------------------------------	-----------------------------------	--------------------------	-----------------------	-----------------------	-------------------	----------------------------------	-----------------------------------	----------------------------------	---------------------------------	------------------------------------	-----------------------------

Okoguard Insulation: 175 mils (4.45mm), 100% Insulation Level

115-23-3011	2	33.6	0.67	0.73	60	1.52	0.87	22.1	555	610	165	225	165	3
115-23-3013	1	42.4	0.70	0.76	80	2.03	0.94	23.9	665	720	190	260	185	3
115-23-3015	1/0	53.5	0.74	0.80	80	2.03	0.98	24.8	755	820	215	295	215	3
115-23-3017	2/0	67.4	0.78	0.84	80	2.03	1.02	25.8	865	930	255	335	245	3
115-23-3019	3/0	85.0	0.83	0.89	80	2.03	1.07	27.2	1000	1070	290	380	275	3
115-23-3021	4/0	107.0	0.88	0.94	80	2.03	1.12	28.3	1170	1250	330	435	315	3
115-23-3023	250	127.0	0.93	0.99	80	2.03	1.18	30.0	1325	1405	365	475	345	3½
115-23-3027	350	177.0	1.03	1.07	80	2.03	1.26	32.0	1700	1800	440	575	415	3½
115-23-3031	500	253.0	1.14	1.19	80	2.03	1.38	35.1	2240	2385	535	700	500	4
115-23-3035	750	380.0	1.32	1.37	80	2.03	1.55	39.4	3105	3340	655	865	610	5
115-23-3037	1000	507.0	1.47	1.52	80	2.03	1.71	43.4	3950	4185	755	1005	690	5

Okoguard Insulation: 220 mils (5.59mm), 133% Insulation Level

▲ 115-23-3111	2	33.6	0.76	0.81	80	2.03	1.00	25.4	670	720	165	225	165	3
115-23-3113	1	42.4	0.79	0.85	80	2.03	1.04	26.4	755	820	190	260	185	3
▲ 115-23-3115	1/0	53.5	0.83	0.89	80	2.03	1.07	27.1	845	915	215	295	215	3
▲ 115-23-3117	2/0	67.4	0.87	0.92	80	2.03	1.11	28.2	950	1020	255	335	245	3
115-23-3119	3/0	85.0	0.92	0.98	80	2.03	1.16	29.3	1100	1180	290	380	275	3½
▲ 115-23-3121	4/0	107.0	0.96	1.02	80	2.03	1.20	30.5	1260	1360	330	435	315	3½
▲ 115-23-3123	250	127.0	1.01	1.07	80	2.03	1.26	32.0	1415	1500	365	475	345	3½
▲ 115-23-3127	350	177.0	1.11	1.16	80	2.03	1.35	34.3	1790	1920	440	575	415	4
▲ 115-23-3131	500	253.0	1.22	1.28	80	2.03	1.47	37.3	2325	2510	535	700	500	4
▲ 115-23-3135	750	380.0	1.40	1.46	80	2.03	1.64	41.7	3220	3455	655	865	610	5
▲ 115-23-3139	1000	507.0	1.54	1.60	110	2.79	1.84	46.7	4075	4340	755	1005	690	6

Visit Okonite's web site, www.okonite.com for the most up to date dimensions.

▲ **Authorized stock item.** Available from our Customer Service Centers.

Aluminum Conductors

(1) Aluminum conductors are available on special order.

Ampacities

(2) Ampacities are in accordance with Table 310.60(C)(73) of the NEC for three single Type MV-105 conductors, or single conductors twisted together (triplexed) and installed in an isolated conduit in air at an ambient temperature of 40°C and a conductor temperature of 105°C.

(3) Ampacities are in accordance with Table 310.60(C)(81) of the NEC for an insulated single conductor directly buried with a conductor temperature rating of 105°C, ambient earth temperature of 20°C, 100% Load Factor, thermal resistance (RHO) of 90, 7 1/2 inch spacing between conductor center lines, and 24 inch spacing between circuits.

(4) Ampacities are in accordance with Table 310.60(C)(77) of the NEC for three single conductors or triplexed cable in one underground raceway, three feet

deep with a conductor temperature of 105°C, 100% Load Factor, an ambient earth temperature of 20°C, and thermal resistance (RHO) of 90.

Refer to the NEC, IEEE/ICEA S-135 Power Cable Ampacities, or the Okonite Engineering Data Bulletin for installation in duct banks, multiple point grounded shields, other ambient temperatures, circuit configurations or installation requirements.

(5) Recommended size of rigid or nonmetallic conduit for three conductors based on 40% maximum fill.

*The jam ratio, conduit I.D. to cable O.D. should be checked to avoid possible jamming.

 **THE OKONITE COMPANY**
Ramsey, New Jersey 07446



Okoguard®-Okolon® TS-CPE Type MV-105

15kV Shielded Power Cable

One Okopact® (Compact Stranded) Copper Conductor/105°C Rating
100% and 133% Insulation Level

For Cable Tray Use-Sunlight Resistant



- A Uncoated, Okopact (Compact Stranded) Copper Conductor
- B Strand Screen-Extruded Semiconducting EPR
- C Insulation-Okoguard EPR
- D Insulation Screen-Extruded Semiconducting EPR
- E Shield Copper Tape
- F Jacket-Okolon TS-CPE

Insulation

Okoguard is Okonite's registered trade name for its exclusive ethylene-propylene (EPR) based, thermosetting compound, whose optimum balance of electrical and physical properties is unequalled in other solid dielectrics. Okoguard insulation, with the distinctive red color and a totally integrated EPR system, provides the optimum balance of electrical and physical properties for long, problem free service.

The triple tandem extrusion of the screens with the insulation provides optimum electrical characteristics.

Jacket

The Okolon TS-CPE jacket on this cable is a vulcanized chlorinated polyethylene base compound which is mechanically rugged, flame, radiation, and oil resistant.

Applications

Okoguard shielded Okolon TS-CPE Type MV-105 power cables are recommended for use as feeder circuits in electric utility generating stations, for distribution circuits, and for feeders or branch circuits in industrial and commercial installations. Type MV cables may be installed in wet or dry locations, indoors or outdoors (exposed to sunlight), in any raceway or underground duct, directly buried if installed in a system with a grounding conductor in close proximity that conforms with NEC Section 250.4(A)(5), or messenger supported in industrial establishments and electric utilities. Sizes 1/0 AWG and larger may also be installed in cable tray.

Specifications

Conductor: Annealed uncoated copper compact stranded per ASTM B-496.

Strand Screen: Extruded semiconducting EPR strand screen. Meets or exceeds electrical and physical requirements of ICEA S-93-639/NEMA WC74 & S-97-682, AEIC CS8, CSA C68.3 and UL 1072.

Insulation: Meets or exceeds electrical and physical requirements of ICEA S-93-639/NEMA WC74 & S-97-682, AEIC CS8, CSA C68.3 and UL 1072.

Insulation Screen: Extruded semiconducting EPR insulation screen. Meets or exceeds

electrical and physical requirements of ICEA S-93-639/NEMA WC74 & S-97-682, AEIC CS8, CSA C68.3 and UL 1072.

Shield: 5 mil bare copper tape helically applied, with 25% minimum overlap.

Jacket: Meets or exceeds electrical and physical requirements of ICEA S-93-639/NEMA WC74 & S-97-682, CSA C68.3 and UL 1072 for chlorinated polyethylene jackets.

UL listed as Type MV-105, sunlight resistant and for use in cable tray in accordance with UL 1072.

CSA listed meeting the requirements of C68.3 and rated FT4 (1/0 AWG and larger) and -40°C.

Product Features

- Triple tandem extruded, all EPR system.
- Okoguard cables meet or exceed all recognized industry standards (UL, CSA, AEIC, NEMA/ICEA, IEEE).
- 105°C continuous operating temperature.
- 140°C emergency rating.
- 250°C short circuit rating.
- Passes UL and IEEE 383 and 1202 (1/0 AWG & larger) Vertical Tray Flame Tests.
- Excellent corona resistance.
- Screens are clean stripping.
- Exceptional resistance to "treeing."
- Moisture resistant.
- Resistant to most oils, acids, and alkalis.
- Sunlight resistant.
- For Cable Tray Use; 1/0 AWG and larger.
- CSA FT4 and -40°C.
- Improved Temperature Rating.

Okoguard-Okolon TS-CPE Type MV-105

15kV Shielded Power Cable

One Okopact (Compact Stranded)

Copper Conductor/ 105°C Rating

100% and 133% Insulation Level

For Cable Tray Use-Sunlight Resistant



Product Data Section 2: Sheet 11

Catalog Number (1)	Conductor Size AWG or kcmil		Conductor Size - mm ²		Approx. Dia. over Insulation (in.)		Approx. Dia. over Screen (in.)		Jacket Thickness - mils		Approx. O.D. - mm		Approx. O.D. - Inches		Approx. Net Weight (lbs./1000')		Approx. Ship Weight (lbs./1000')		Ampacities (2) Conduit in Air	Ampacities (3) Underground	Ampacities (4) Cable Tray	Conduit (5) Size Inches*
--------------------	--------------------------------	--	----------------------------------	--	---------------------------------------	--	-----------------------------------	--	----------------------------	--	-------------------	--	-----------------------	--	------------------------------------	--	-------------------------------------	--	----------------------------------	-------------------------------	------------------------------	-----------------------------

Okoguard Insulation: 175 mils (4.45mm), 100% Insulation Level

115-23-2011	2	33.6	0.67	0.73	60	1.52	0.89	22.5	585	640	165	165	—	3
115-23-2013	1	42.4	0.70	0.76	80	2.03	0.96	24.4	700	765	190	185	—	3
115-23-2015	1/0	53.5	0.73	0.79	80	2.03	1.00	25.3	790	855	215	215	220	3
115-23-2017	2/0	67.4	0.77	0.83	80	2.03	1.04	26.4	905	965	255	245	250	3
115-23-2019	3/0	85.0	0.82	0.88	80	2.03	1.09	27.6	1040	1110	290	275	290	3
115-23-2021	4/0	107.0	0.87	0.93	80	2.03	1.13	28.7	1200	1280	330	315	335	3½
115-23-2023	250	127.0	0.93	0.99	80	2.03	1.19	30.3	1370	1450	365	345	370	3½
115-23-2027	350	177.0	1.01	1.07	80	2.03	1.28	32.4	1725	1825	440	415	460	4
115-23-2031	500	253.0	1.13	1.19	80	2.03	1.39	35.4	2255	2370	535	500	575	4
115-23-2035	750	380.0	1.31	1.37	80	2.03	1.57	39.9	3140	3320	655	610	745	5
115-23-2038	1000	507.0	1.46	1.52	80	2.03	1.73	43.9	4020	4255	755	690	890	5

Okoguard Insulation: 220 mils (5.59mm), 133% Insulation Level

115-23-2111	2	33.6	0.75	0.81	80	2.03	1.01	25.8	710	775	165	165	—	3
115-23-2113	1	42.4	0.79	0.85	80	2.03	1.05	26.7	790	860	190	185	—	3
115-23-2115	1/0	53.5	0.82	0.88	80	2.03	1.08	27.5	880	945	215	215	220	3½
115-23-2117	2/0	67.4	0.86	0.92	80	2.03	1.12	28.5	995	1075	255	245	250	3½
115-23-2119	3/0	85.0	0.91	0.97	80	2.03	1.18	29.9	1145	1225	290	275	290	3½
115-23-2121	4/0	107.0	0.96	1.02	80	2.03	1.22	31.1	1310	1400	330	315	335	3½
115-23-2123	250	127.0	1.01	1.07	80	2.03	1.28	32.4	1465	1565	365	345	370	4
115-23-2127	350	177.0	1.10	1.16	80	2.03	1.37	34.7	1840	1940	440	415	460	4
▲ 115-23-2131	500	253.0	1.22	1.28	80	2.03	1.49	37.7	2385	2570	535	500	575	5
▲ 115-23-2135	750	380.0	1.40	1.46	80	2.03	1.66	42.2	3285	3540	655	610	745	5
115-23-2138	1000	507.0	1.54	1.60	110	2.79	1.87	47.5	4275	4540	755	690	890	6
115-23-2144	1250	633.5	1.75	1.81	110	4.33	2.08	52.7	5255	5645	845	770	995	6
115-23-2145	1500	760.2	1.88	1.94	110	4.33	2.20	56.0	6140	6540	925	845	1090	8

Visit Okonite's web site, www.okonite.com for the most up to date dimensions.

▲ **Authorized Stock Item.** Available from our Customer Service Centers.

Aluminum Conductors

(1) Aluminum conductors are available on special order.

Ampacities

(2) Ampacities are in accordance with Table 310.60(C)(73) of the NEC for three single Type MV-105 conductors, or single conductors twisted together (triplexed) and installed in an isolated conduit in air at an ambient temperature of 40°C and a conductor temperature of 105°C.

(3) Ampacities are in accordance with Table 310.60(C)(77) of the NEC for three single conductors or triplexed cable in one underground raceway, three feet deep with a conductor temperature of 105°C, 100% Load Factor, an ambient earth temperature of 20°C and thermal resistance (RHO) of 90.

(4) Ampacities based on single Type MV-105 conductors, or single conductors twisted together (triplexed, quadruplexed, etc.), size 1/0 AWG and larger, installed in uncovered cable tray in accordance with Section 392.80(B) of the NEC at an ambient temperature of 40°C and a conductor temperature rating of

105°C. In accordance with NEC Section 392.80(B)(2)(a), the ampacities are 75% of the values given in NEC Table 310.60(C)(69) (copper conductors). Where the cable tray is covered for more than six feet with solid unventilated covers, the ampacities shall not exceed 93% of the values shown above.

Refer to the NEC, IEEE/ICEA-S-135 Power Cable Ampacities, or the Okonite Engineering Data Bulletin for installation in duct banks, multiple point grounded shields, other ambient temperatures, circuit configurations or installation requirements.

(5) Recommended size of rigid or nonmetallic conduit for three conductors based on 40% maximum fill.

*The jam ratio conduit I.D. to cable O.D. should be checked to avoid possible jamming.



Okoguard®-Okoseal® Type MV-105



35kV Shielded Power Cable

One Okopact® (Compact Stranded) Copper Conductor/105°C Rating
100% and 133% Insulation Level



- A Uncoated, Okopact (Compact Stranded) Copper Conductor
- B Strand Screen- Extruded Semiconducting EPR
- C Insulation-Okoguard EPR
- D Insulation Screen -Extruded Semiconducting EPR
- E Shield-Copper Tape
- F Jacket-Okoseal

Insulation

Okoguard Okonite's registered trade name for its exclusive ethylene-propylene rubber (EPR) based, thermosetting compound, whose optimum balance of electrical and physical properties is unequalled in other solid dielectrics. Okoguard insulation, with the distinctive red color and a totally integrated EPR system, provides the optimum balance of electrical and physical properties for long, problem free service. The triple tandem extrusion of the screens with the insulation provides optimum electrical characteristics.

Jacket

The Okoseal (PVC) jacket supplied with this cable is mechanically rugged and has excellent resistance to oil and most chemicals.

Applications

Okoguard shielded Okoseal Type MV-105 power cables are recommended for distribution circuits, and for feeders or branch circuits in industrial and commercial installations.

Type MV cables may be installed in wet or dry locations, indoors or outdoors (exposed to sunlight), in any raceway or underground duct, directly buried if installed in a system with a grounding conductor in close proximity that conforms with NEC Section 250.4(A)(5), or messenger supported in industrial establishments and electric utilities.

Specifications

Conductor: Annealed uncoated copper compact stranded per ASTM B-496.

Strand Screen: Extruded semiconducting EPR strand screen. Meets or exceeds electrical and physical requirements of ICEA S-93-639/NEMA WC7 & S-97-682, AEIC CS8 and UL 1072.

Insulation: Meets or exceeds electrical and physical requirements of ICEA S-93-639/NEMA WC74, & S-97-682 AEIC CS8 and UL 1072.

Insulation Screen: Extruded semiconducting EPR insulation screen. Meets or exceeds electrical and physical requirements of ICEA S-93-639/NEMA WC74 & S-97-682, AEIC CS8 and UL 1072.

Shield: 5 mil bare copper tape helically applied with 12.5% nominal overlap.

Jacket: Meets or exceeds electrical and physical requirements of ICEA S-93-639/NEMA WC74 & S-97-682 and UL 1072 for polyvinyl chloride jackets.

UL Listed as Type MV-105 and sunlight resistant, in accordance with UL 1072.

A flame retardant construction, size 1/0 AWG and larger, for installation in cable tray is available on special order. This construction is UL labeled "MV-105 FOR CT USE." Cables listed to CSA C68.3 and rated FT4 and -25°C are available on special orders.

Product Features

- Triple tandem extruded all EPR system.
- Okoguard cables meet or exceed all recognized industry standards (UL, AEIC, NEMA/ICEA, IEEE).
- 105°C continuous operating temperature.
- 140°C emergency rating.
- 250°C short circuit rating.
- Excellent corona resistance.
- Screens are clean stripping.
- Exceptional resistance to "treeing."
- Moisture resistant.
- Resistant to most oils, acids, and alkalis.
- Sunlight resistant.
- Improved Temperature Rating

Okoguard-Okoseal Type MV-105

35kV Shielded Power Cable

One Okopact (Compact Stranded)

Copper Conductor/105°C Rating

100% and 133% Insulation Level



Product Data

Section 2: Sheet 16

Catalog Number (1)	Conductor Size AWG or kcmil		Conductor Size - mm ²		Approx. Dia. over Insulation (in.)		Approx. Dia. over Screen (in.)		Jacket Thickness - mils		Jacket Thickness - mm		Approx. O.D. - Inches		Approx. O.D. - mm		Approx. Net Weight lbs./1000'		Approx. Ship Weight lbs./1000'		Ampacities (2) Conduit in Air		Ampacities (3) Direct Burial		Ampacities (4) Underground Duct		Conduit Size Inches (5)*	
--------------------	--------------------------------	--	----------------------------------	--	---------------------------------------	--	-----------------------------------	--	-------------------------	--	-----------------------	--	-----------------------	--	-------------------	--	----------------------------------	--	-----------------------------------	--	----------------------------------	--	---------------------------------	--	------------------------------------	--	-----------------------------	--

Okoguard Insulation: 345 mils (8.76mm), 100% Insulation Level																																												
▲ 115-23-3516	1/0	53.5	1.09	1.15	80	2.03	1.33	34.0	1140	1275	215	295	215	4	115-23-3517	2/0	67.4	1.12	1.19	80	2.03	1.37	35.0	1270	1380	255	335	245	4	115-23-3519	3/0	85.0	1.17	1.23	80	2.03	1.42	36.1	1420	1605	290	380	275	4
▲ 115-23-3521	4/0	107.0	1.23	1.29	80	2.03	1.47	37.4	1595	1800	330	435	315	5	115-23-3523	250	127.0	1.27	1.33	80	2.03	1.52	38.7	1760	1950	365	475	345	5	115-23-3527	350	177.0	1.36	1.43	80	2.03	1.61	41.2	2150	2420	440	575	415	5
▲ 115-23-3531	500	253.0	1.48	1.54	80	2.03	1.73	43.9	2720	3014	535	700	500	5	115-23-3535	750	380.0	1.66	1.72	110	2.79	1.97	50.1	3765	4240	655	865	610	6	115-23-3537	1000	507.0	1.81	1.86	110	2.79	2.12	53.9	4671	5300	755	1005	690	6

Okoguard Insulation: 420 mils (10.7mm), 133% Insulation Level																																												
▲ 115-23-3656	1/0	53.5	1.24	1.30	80	2.03	1.49	37.9	1350	1535	215	295	215	5	115-23-3657	2/0	67.4	1.28	1.34	80	2.03	1.53	39.0	1470	1665	255	335	245	5	115-23-3659	3/0	85.0	1.32	1.39	80	2.03	1.57	40.0	1630	1825	290	380	275	5
▲ 115-23-3661	4/0	107.0	1.39	1.45	80	2.03	1.64	41.9	1840	2085	330	435	315	5	115-23-3663	250	127.0	1.42	1.48	80	2.03	1.69	42.9	1985	2250	365	475	345	5	115-23-3667	350	177.0	1.52	1.58	110	2.79	1.83	46.5	2495	2770	440	575	415	5
115-23-3671	500	253.0	1.63	1.69	110	2.79	1.94	49.3	3085	3555	535	700	500	6	115-23-3675	750	380.0	1.81	1.87	110	2.79	2.12	53.9	4055	4680	655	865	610	6	115-23-3677	1000	507.0	1.97	2.02	110	2.79	2.27	57.6	5980	5630	755	1005	690	8

Visit Okonite's web site, www.okonite.com for the most up to date dimensions.

▲ Authorized stock item. Available from our Customer Service Centers.

Aluminum Conductors

(1) Aluminum Conductors are available on special orders.

Ampacities

(2) Ampacities are in accordance with Table 310.60(C)(73) of the NEC for three single Type MV-105 conductors, or single conductors twisted together (triplexed) and installed in an isolated conduit in air at an ambient temperature of 40°C and a conductor temperature of 105°C.

(3) Ampacities are in accordance with Table 310.60(C)(81) of the NEC for an insulated single conductor directly buried with a conductor temperature rating of 105°C, ambient earth temperature of 20°C, 100% Load Factor, thermal resistance (RHO) of 90, 7 1/2 inch spacing between conductor center lines, and 24 inch spacing between circuits.

(4) Ampacities are in accordance with Table 310.60(C)(77) of the NEC for three single conductors or triplexed cable in one underground raceway, three feet deep with a conductor temperature of 105°C, 100% Load Factor, an ambient earth temperature of 20°C, and thermal resistance (RHO) of 90.

Refer to the NEC, IEEE/ICEA S-135 Power Cable Ampacities, or the Okonite Engineering Data Bulletin for installation in duct banks, multiple point grounded shields, other ambient temperatures, circuit configurations or installation requirements.

(5) Recommended size of rigid or nonmetallic conduit for three conductors based on 40% maximum fill.

*The jam ratio conduit I.D. to cable O.D. should be checked to avoid possible jamming.



Okoguard®-Okoseal®

69kV Shielded Power Cable

Conductor/105°C Rating — 100% Insulation Level



- A Uncoated, Okopact (Compact) or Compress Stranded Copper or Aluminum Conductor
- B Strand Screen-Extruded Semiconducting EPR
- C Insulation-Okoguard EPR
- D Insulation Screen-Extruded Semiconducting EPR
- E Shield- 5 Mil Uncoated Copper Tape
- F Jacket-Okoseal

Insulation

Okoguard is Okonite's registered trade name for its exclusive ethylene-propylene rubber (EPR) based, thermo-setting compound, whose optimum balance of electrical and physical properties is unequalled in other solid dielectrics. Okoguard insulation, with the distinctive red color and a totally integrated EPR system, provides the optimum balance of electrical and physical properties for long, problem free service.

The triple tandem extrusion of the screens with the insulation provides optimum electrical characteristics.

Jacket

The Okoseal (PVC) jacket supplied with this cable is mechanically rugged and has excellent resistance to oil and most chemicals.

Applications

Okoguard-Shielded-Okoseal 69kV Cables are designed for use as primary circuits in electrical utility and industry applications where they provide maximum circuit security and economical installation. Rated 105°C for continuous operating temperature, Okoguard 69kV cables may be installed in wet or dry locations indoors or outdoors (exposed to sunlight) in underground ducts, conduits or direct burial.

Specifications

Conductors: Uncoated copper sizes 350 through 1000 kcmil compact round stranding per ASTM B-496. Uncoated copper sizes larger than 1000 kcmil compress round stranding per ASTM B-8. EC Aluminum per ASTM B609, Class B stranded per B-231.

Strand Screen: Extruded semiconducting EPR strand screen. Meets or exceeds electrical and physical requirements of ICEA S-108-720, AEIC CS9.

Insulation: Meets or exceeds electrical and physical requirements of ICEA S-108-720 and AEIC CS9.

Insulation Screen: Extruded semiconducting EPR insulation screen. Meets or exceeds electrical and physical requirements of ICEA S-108-720 and AEIC CS9.

Shield: 5 mil bare copper tape helically applied with 25% nominal overlap.

Jacket: Meets or exceeds electrical and physical requirements of ICEA S-108-720 for polyvinyl chloride jackets.

Optional jackets include Okolene, Okolon TS-CPE, Okoclear and, when specified, a semi-conducting outer layer.

Optional shields include neutral wires, LCS and a combination of copper tape and wires. A CLX armor covering is also available.

Product Features

- Triple tandem extruded, all EPR system.
- Okoguard cables meet or exceed recognized industry standards (AEIC, NEMA/ ICEA).
- 105°C continuous operating temperature.
- 140°C emergency rating.
- 250°C short circuit rating.
- Excellent corona resistance.
- Exceptional resistance to "treeing."
- Low shield resistance.
- Moisture resistant.
- Resistant to most oils, acids, and alkalis.
- Sunlight resistant.
- Improved Temperature Rating.
- Screens are clean stripping.

Okoguard-Okoseal

69kV Shielded Power Cable

Conductor/ 105°C Rating

100% Insulation Level

Product Data

Section 2: Sheet 18

Okoguard Insulation: 650 mils (16.5mm)

Catalog Number	Conductor Size AWG or kcmil	Conductor Size -mm ²	Approx. Dia. over Insulation (in.)	Approx. Dia. over Screen (in.)	Jacket Thickness - mils	Jacket Thickness - mm	Approx. O.D. - Inches	Approx. O.D. - mm	Approx. Net Weight lbs./1000'	Approx. Ship Weight lbs./1000'	Ampacities (1) Direct Burial	Ampacities (1) Underground Duct	Conduit Size Inches (2)*
Copper Conductor - Compact Round													
115-22-3767	350*	177	2.01	2.11	110	2.79	2.36	59.9	3538	3873	550	495	3 ½
▲ 115-22-3771	500	253	2.12	2.22	110	2.79	2.47	62.7	4179	4514	667	599	3 ½
115-22-3775	750	380	2.30	2.40	110	2.79	2.64	67.1	5213	5805	825	742	4
▲ 115-22-3777	1000	507	2.44	2.54	140	3.56	2.85	72.4	6389	7151	957	861	4
Copper Conductor - Compress Round													
115-22-3778	1250	633	2.68	2.78	140	3.56	3.09	78.5	7582	8344	1066	959	5
115-22-3779	1500	761	2.78	2.88	140	3.56	3.19	81.0	8527	9447	1157	1042	5
Aluminum Conductor - Compress Round													
135-22-3767	350*	177	2.06	2.16	110	2.79	2.41	61.2	2888	3223	429	386	3 ½
135-22-3771	500	253	2.19	2.29	110	2.79	2.54	64.5	3244	3579	523	469	3 ½
135-22-3775	750	380	2.37	2.47	110	2.79	2.72	69.1	3778	4175	650	584	4
135-22-3777	1000	507	2.52	2.62	140	3.56	2.93	74.4	4433	4904	759	683	4
135-22-3778	1250	633	2.68	2.78	140	3.56	3.09	78.5	4954	5716	853	768	5
135-22-3779	1500	761	2.80	2.90	140	3.56	3.21	81.5	5381	6034	936	842	5

Visit Okonite's web site, www.okonite.com for the most up to date dimensions.

▲ Authorized Stock Item. Available from our Customer Service Centers.

Additional conductor sizes are available.

Ampacities

(1) Ampacities are in accordance with ICEA P-53-426 for three single 69kV conductors directly buried or in individual ducts underground, 36" deep with 7 1/2" spacing between conductors, 105°C maximum conductor temperature, 25°C earth temperature, soil resistivity of 90 Rho, 100% load factor, and open circuit shields.

(2) Recommended size of rigid nonmagnetic or nonmetallic conduit for a single conductor based on 53% maximum fill

* Minimum conductor size per, (1) AEIC CS-9 is 500 kcmil; (2) ICEA S-108-720 is 250 kcmil.



Okoguard® Okoseal® Type MV-105



5/8kV Okoguard Shielded Power Cable

3 Okopact® (Compact Stranded) Copper Conductors/105°C Rating
5kV-133% or 8kV-100% Insulation Level

For Cable Tray Use-Sunlight Resistant-For Direct Burial



- A Uncoated Okopact (Compact Stranded) Copper Conductors
- B Extruded Semiconducting EPR Strand Screen
- C Okoguard Insulation (EPR)
- D Extruded Semiconducting EPR Insulation Screen
- E Phase Identification Tape
- F Okopact Compact Copper Grounding Conductor
- G Uncoated Copper Shield
- H Fillers and Binder Tape
- J Jacket-Black Okoseal

Insulation

Okoguard is Okonite's registered trade name for its exclusive ethylene-propylene rubber (EPR) base, thermosetting compound, whose optimum balance of electrical and physical properties is unequalled in other solid dielectrics. Okoguard insulation, with the distinctive red color and a totally integrated EPR system, provides the optimum balance of electrical and physical properties for long, problem free service.

Assembly

The Type MV-105 conductors are assembled with fillers and a binder tape overall. One bare stranded copper ground conductor is placed in one of the outer interstices.

Jacket

The Okoseal (PVC) jacket supplied with this cable is mechanically rugged and has excellent resistance to oil and most chemicals.

Applications

Okoguard shielded three conductor Type MV-105 power cables are recommended for distribution circuits, and for feeders or branch circuits in industrial & utility power distribution systems. Type MV cables may be installed in wet or dry locations, indoors or outdoors (exposed to sunlight), in any raceway or underground duct, directly buried, cable tray, or messenger supported in industrial establishments and electric utilities.

Specifications

Conductors: Uncoated copper compact stranded per ASTM B-496.

Strand Screen: Extruded semiconducting EPR strand screen meets or exceeds electrical and physical requirements of ICEA S-93-639/NEMA WC74 and UL 1072.

Insulation: Okoguard meets or exceeds the electrical and physical requirements of ICEA S-93-639/NEMA WC74 and UL 1072. The insulated conductors are tested in accordance with AEIC CS8.

Insulation Screen: Extruded semiconducting EPR insulation screen per ICEA S-93-639/NEMA WC74, AEIC CS8 and UL 1072.

Shield: 5 mil uncoated copper tape helically applied with 12.5% nominal overlap.

Phase Identification: Color coded (black, red, blue) polyester ribbon laid longitudinally under the copper shield.

Grounding Conductor: Uncoated copper compact stranded per ASTM B-496 and sized in accordance with UL 1072.

Assembly: Cabled with fillers and ground wire in the interstices, binder tape overall.

Jacket: Meets or exceeds electrical and physical requirements of ICEA S-93-639/NEMA WC74 and UL 1072 for polyvinyl chloride jackets.

UL Listed as Type MV-105, sunlight resistant for use in cable tray, and for direct burial in accordance with UL 1072.

Cables listed to CSA C68.3 are also available.

Product Features

- Triple tandem extruded, all EPR system.
- Complete prepackaged, color coded, factory tested wiring system.
- Passes the vertical tray flame test requirements of IEEE 383 and UL 1072.
- Complies with NEC Sections 310-7 and 710-4(b) for direct burial.
- Excellent corona resistance.
- Screens are clean stripping.
- Exceptional resistance to "treeing".
- Improved Temperature Rating.

Okoguard Okoseal Type MV-105



5/8kV Okoguard Shielded Power Cable

3 Okopact (Compact Stranded) Copper Conductors/105°C Rating

5kV-133% or 8kV-100% Insulation Level

For Cable Tray Use-Sunlight Resistant-For Direct Burial

Product Data Section 2: Sheet 19

Okoguard Insulation: 115 mils (2.92mm), 5kV-133% or 8kV-100% Insulation Level

Catalog Number (1)	Conductor Size (AWG/kcmil)		Conductor Size - mm ²	Approx. Diameter over Insulation (in.)		Grounding Conductor Size (AWG/kcmil)		Grounding Conductor Size - mm ²		Approx. Core O.D. - Inches		Approx. Core O.D. - mm		Jacket Thickness (mils)		Jacket Thickness mm		Approx. O.D. - Inches		Approx. O.D. - mm		Approx. Net Weight lbs./1000'		Approx. Ship Weight lbs./1000'		Ampacities In Air (2)			Ampacities Cable Tray (3)			Ampacities Direct Burial (4)							
▲ 114-23-3630	6	13.3	0.44	6	13.3	1.10	27.9	80	2.03	1.29	32.8	1015	1115	88	77	115																							
114-23-3633	4	21.2	0.48	6	13.3	1.19	30.2	80	2.03	1.38	35.1	1235	1390	115	100	150																							
▲ 114-23-3640	2	33.6	0.54	6	13.3	1.32	33.5	80	2.03	1.51	38.3	1560	1715	155	135	190																							
114-23-3642	1/0	53.5	0.61	4	21.2	1.46	37.0	80	2.03	1.65	41.9	2090	2250	205	185	245																							
▲ 114-23-3648	2/0	67.4	0.65	4	21.2	1.55	39.4	110	2.79	1.80	45.7	2513	2695	240	210	280																							
▲ 114-23-3736	4/0	107.0	0.75	3	26.7	1.77	45.0	110	2.79	2.02	51.3	3455	3780	320	285	360																							
114-23-3770	250	127.0	0.80	3	26.7	1.88	47.8	110	2.79	2.13	54.1	3971	4245	355	315	395																							
▲ 114-23-3772	350	177.0	0.89	2	33.6	2.08	52.8	110	2.79	2.33	59.2	5116	5665	440	390	475																							
▲ 114-23-3782	500	253.0	1.01	1	42.4	2.33	59.2	110	2.79	2.59	65.8	6799	7430	545	475	570																							

Visit Okonite's web site, www.okonite.com for the most up to date dimensions.

▲ Authorized stock item. Available from our Customer Service Centers.

Aluminum Conductors

(1) Aluminum conductors available on special orders.

Ampacities

(2) Ampacities are in accordance with Table 310.60(C)(71) of the NEC for an insulated three conductor cable, isolated in air, with a conductor operating temperature of 105°C and an ambient air temperature of 40°C.

(3) Ampacities are in accordance with Table 310.60(C)(75) of the NEC for a three conductor Type MV-105 cable installed in uncovered cable tray in accordance with Section 392.80(B) of the NEC with a conductor operating temperature of 105°C and ambient air temperature of 40°C. Where the cable tray is covered for more than six feet with solid unventilated covers, the ampacities shall not be more than 95% of the values shown above.

(4) Ampacities are in accordance with Table 310.60(C)(83) of the NEC for an insulated three conductor cable directly buried in the earth with a conductor operating temperature of 105°C, ambient earth temperature of 20°C, 100% load factor and thermal resistance (RHO) of 90.

Refer to the NEC, IEEE/ICEA S-135 Power Cable Ampacities, or the Okonite Engineering Data Bulletin for installation in duct banks, other ambient temperatures, circuit configurations or installation requirements.



Okoguard® Okoseal® Type MV-105

15kV Okoguard Shielded Power Cable

3 Okopact® (Compact Stranded) Copper Conductors/105°C Rating
100% & 133% Insulation Level

For Cable Tray Use-Sunlight Resistant-For Direct Burial



- A Uncoated Okopact (Compact Stranded) Copper Conductors
- B Extruded Semiconducting EPR Strand Screen
- C Okoguard Insulation (EPR)
- D Extruded Semiconducting EPR Insulation Screen
- E Phase Identification Tape
- F Okopact Copper Grounding Conductor
- G Uncoated Copper Shield
- H Fillers and Binder Tape
- J Jacket-Black Okoseal

Insulation

Okoguard is Okonite's registered trade name for its exclusive ethylene-propylene rubber (EPR) base, thermosetting compound, whose optimum balance of electrical and physical properties is unequalled in other solid dielectrics. Okoguard insulation, with the distinctive red color and a totally integrated EPR system, provides the optimum balance of electrical and physical properties for long, problem free service.

Assembly

The Type MV-105 conductors are assembled with fillers and a binder tape overall. One bare stranded copper ground conductor is placed in one of the outer interstices.

Jacket

The Okoseal (PVC) jacket supplied with this cable is mechanically rugged and has excellent resistance to oil and most chemicals.

Applications

Okoguard shielded three conductor Okoseal Type MV-105 power cables are recommended for distribution circuits, and for feeders or branch circuits in industrial and utility power distribution systems. Type MV cables may be installed in wet or dry locations, indoors or outdoors (exposed to sunlight), in any raceway or underground duct, directly buried, cable tray, or messenger supported in industrial establishments and electric utilities.

Specifications

Conductors: Uncoated copper compact stranded per ASTM B-496.

Strand Screen: Extruded semiconducting EPR strand screen meets or exceeds electrical and physical requirements of ICEA S-93-639/NEMA WC74 and UL 1072.

Insulation: Okoguard meets or exceeds the electrical and physical requirements of ICEA S-93-639/NEMA WC74 and UL 1072. The insulated conductors are tested in accordance with AEIC CS8.

Insulation Screen: Extruded semiconducting EPR insulation screen per ICEA S-93-639/NEMA WC74, AEIC CS8 and UL 1072.

Shield: 5 mil uncoated copper tape helically applied with 12.5% nominal overlap.

Phase Identification: Color coded (black, red, blue) polyester ribbon laid longitudinally under the copper tape shield.

Grounding Conductor: Uncoated copper compact stranded per ASTM B-496 and sized in accordance with UL 1072.

Assembly: Cabled with fillers and ground wire in the interstices, binder tape overall.

Jacket: Meets or exceeds electrical and physical requirements of ICEA S-93-639/NEMA WC74 and UL 1072 for polyvinyl chloride jackets. UL Listed as Type MV-105, sunlight resistant for use in cable tray, and for direct burial in accordance with UL 1072.

Cables listed to CSA C68.3 are also available.

Product Features

- Triple tandem extruded, all EPR system.
- Complete prepackaged, color coded, factory tested wiring system.
- Passes the UL 1072 & IEEE 383 vertical tray flame test requirements.
- Complies with NEC Sections 310-7 and 710-4(b) for direct burial.
- Excellent corona resistance.
- Screens are clean stripping.
- Exceptional resistance to "treeing".
- Improved Temperature Rating.

Okoguard Okoseal Type MV-105



Product Data Section 2: Sheet 20

15kV Okoguard Shielded Power Cable

3 Okopact (Compact Stranded) Copper Conductors/105°C Rating
100% & 133% Insulation Level

For Cable Tray Use-Sunlight Resistant-For Direct Burial

Catalog Number (1)	Conductor Size AWG/kcmil	Conductor Size - mm ²	Approx. Diameter over Insulation (in.)	Grounding Conductor Size - AWG/kcmil	Grounding Conductor Size -mm ²	Approx. Core O.D.	Approx. Core O.D. - Inches	Jacket Thickness - mm	Jacket Thickness - mils	Approx. O.D. - mm	Approx. O.D. - Inches	Approx. Net Weight lbs./1000'	Approx. Ship Weight lbs./1000'	Ampacities in Air (2)	Ampacities Cable Tray (3)	Ampacities Direct Burial (4)
Okoguard Insulation: 175 mils (4.45mm), 100% Insulation Level																
115-23-3766	2 33.6	0.67	6 13.3	1.59 40.4	110 2.79	1.83 46.5	1985 2130	185 165 200								
115-23-3768	1/0 53.5	0.74	4 21.2	1.74 44.2	110 2.79	1.97 50.0	2560 2770	240 215 255								
115-23-3770	2/0 67.4	0.78	4 21.2	1.82 42.2	110 2.79	2.06 52.3	2890 3150	275 245 290								
115-23-3772	4/0 107.0	0.88	3 26.7	2.04 51.8	110 2.79	2.28 57.9	3905 4190	360 320 375								
115-23-3774	250 127.0	0.93	3 26.7	2.15 54.6	110 2.79	2.39 60.7	4390 4930	400 350 410								
115-23-3776	350 177.0	1.03	2 33.6	2.36 59.9	110 2.79	2.59 65.8	5608 6210	490 430 495								
115-23-3778	500 253.0	1.14	1 42.4	2.61 66.3	140 3.56	2.91 73.9	7480 8255	600 525 590								
115-23-3780	750 380.0	1.32	1/0 53.5	2.99 75.9	140 3.56	3.29 83.6	10320 11330	745 635 720								

Okoguard Insulation: 220 mils (5.59mm), 133% Insulation Level																
▲ 115-23-3802	2 33.6	0.76	6 13.3	1.79 45.5	110 2.79	2.02 51.3	2280 2575	185 165 200								
115-23-3804	1/0 53.5	0.83	4 21.2	1.93 49.0	110 2.79	2.17 55.1	2857 3145	240 215 255								
▲ 115-23-3806	2/0 67.4	0.87	4 21.2	2.02 51.3	110 2.79	2.26 57.4	3260 3570	275 245 290								
▲ 115-23-3808	4/0 107.0	0.97	3 26.7	2.24 56.9	110 2.79	2.48 63.0	4285 4640	360 320 375								
115-23-3810	250 127.0	1.03	3 26.7	2.36 60.0	110 2.79	2.59 65.8	4795 5295	400 350 410								
▲ 115-23-3812	350 177.0	1.12	2 33.6	2.56 65.0	140 3.56	2.85 72.4	6168 7000	490 430 495								
▲ 115-23-3814	500 253.0	1.24	1 42.4	2.81 71.4	140 3.56	3.10 78.7	7895 8945	600 525 590								
115-23-3816	750 380.0	1.41	1/0 53.5	3.19 81.0	140 3.56	3.49 88.7	10805 11800	745 635 720								

Visit Okointe's web site, www.okonite.com for the most up to date dimensions.

▲ Authorized stock item. Available from our Customer Service Centers.

Aluminum Conductors

(1) Aluminum conductors available on special orders.

Ampacities

(2) Ampacities are in accordance with Table 310.60(C)(71) of the NEC for an insulated three conductor cable, isolated in air, with a conductor operating temperature of 105°C and an ambient air temperature of 40°C.

(3) Ampacities are in accordance with Table 310.60(C)(75) of the NEC for a three conductor Type MV-105 cable installed in uncovered cable tray in accordance with Section 392.80(B) of the NEC with a conductor operating temperature of 105°C and ambient air temperature of 40°C. Where the cable tray is covered for more than six feet with solid unventilated covers, the ampacities shall not be more than 95% of the values shown above.

(4) Ampacities are in accordance with Table 310.60(C)(83) of the NEC for an insulated three conductor cable directly buried in the earth with a conductor operating temperature of 105°C, ambient earth temperature of 20°C, 100% load factor, thermal resistance (RHO) of 90.

Refer to the NEC, IEEE/ICEA S-135 Power Cable Ampacities or the Okonite Engineering Data Bulletin for installation in duct banks, other ambient temperatures, circuit configurations or installation requirements.



C-L-X[®] Type MV-90 or MC-HL

2.4 kV Okoguard[®] Nonshielded Power Cable-Aluminum Sheath 5000V CSA RA90

3 Okopact[®] (Compact Stranded) Copper Conductors/90°C Rating
100% and 133% Insulation Level
For Cable Tray Use-Sunlight Resistant-For Direct Burial



- A Uncoated, Okopact (Compact Stranded) Copper Conductor
- B Extruded Semiconducting EPR Strand Screen
- C Okoguard (EPR) Insulation
- D Three Copper Grounding Conductors
- E Phase Identification
- F Fillers and Binder Tape
- G Impervious, Continuous, Corrugated Aluminum C-L-X Sheath
- H Jacket- Low Temperature Yellow Okoseal

Insulation

Okoguard is Okonite's registered trade name for its exclusive ethylene-propylene rubber (EPR) base, thermosetting compound, whose optimum balance of electrical and physical properties is unequalled in other solid dielectrics. Okoguard insulation, with the distinctive red color and a totally integrated EPR system, provides the optimum balance of electrical and physical properties for long, problem free service.

Assembly

The Type MV-90 conductors are assembled with fillers and a binder tape into a round core. Three bare stranded copper grounding conductors, located in the outer interstices, is provided for grounding. A continuously corrugated welded aluminum sheath C-L-X encases the cable core. The C-L-X sheath is protected with a low temperature yellow Okoseal[®] (PVC) jacket. The impervious, continuous, corrugated aluminum C-L-X sheath provides complete protection against moisture, liquids and gases in addition to its excellent mechanical strength. Also, the aluminum C-L-X sheath has adequate ampacity capability to be used as a grounding conductor. The overall Okoseal (PVC) jacket allows the cable to be direct buried in the ground, embedded in concrete or areas subjected to a corrosive atmosphere.

Applications

C-L-X power cables are recommended as an economical alternate to a wire in conduit system. They are designed specifically for use on feeders and branch circuits in industrial power distribution systems. C-L-X power cables may be installed in both exposed and concealed work, wet and dry locations, direct burial in the earth, or embedded in concrete. They may be installed on metal racks, troughs, in cable trays or secured to supports not greater than 6 feet apart. C-L-X power cables are also approved for Classes I, II and III. Divisions 1 and 2 and Class I, Zones 1 and 2 hazardous locations - NEC Articles 501, 502, 503 and 505.

Medium voltage Non-Shielded cables discharge normally in service when spacing between phases is non-uniform or when phases are in close proximity to a grounded surface.

Specifications

Conductors: Annealed uncoated copper compact stranded per ASTM B-496.

Strand Screen: Extruded semiconducting EPR strand screen meets or exceeds electrical and

physical requirements of ICEA S-96-659/NEMA WC71 and UL 1072.

Insulation: Okoguard meets or exceeds the electrical and physical requirements of ICEA S-96-659/NEMA WC71 and UL 1072.

Phase Identification: Print color code (black, red and blue).

Grounding Conductors: Three uncoated copper Class B in accordance with UL 1072.

Assembly: Cabled with fillers and ground wires, in the interstices, binder tape overall.

Sheath: Close fitting, impervious, continuous, corrugated aluminum C-L-X per UL 1072. C-L-X is recognized as a grounding conductor by NEC.

Jacket: A low temperature sunlight resistant, yellow PVC jacket in accordance with UL 1072. Other color jackets are available. UL Listed as type MV-90 or MC-HL, sunlight resistant, for use in cable tray, and for direct burial in accordance with UL 1072 and 2225.

Product Features

- Tandem extruded, all EPR system.
- Complete prepackaged, color coded, factory tested wiring system.
- Okoguard C-L-X cables meet or exceed electrical and physical requirements of all recognized industry standards (UL, AEIC, NEMA/ICEA, IEEE).
- Passes the vertical tray flame test requirements of IEEE 383 and 1202, UL 1072, ICEA T-29-520(210,000 BTU/hr.)
- Complies with NEC Sections 310-7 and 300-50 for direct burial.
- Complies with NEC Articles 501, 502, 503 and 505 for hazardous locations.
- Continuous sheath provides grounding safety.
- Excellent corona resistance.
- Exceptional resistance to "treeing."
- Stress cones not required.
- Minimum installation temperature of -40°C.
- Three symmetrical grounding conductors for PWM/VFD and other modern AC drive/motor applications.
- ABS listed as CWCMC Type MC-HL.
- CSA listed as RA90, FT4, SR, HL, -40°C and 5000V.

C-L-X Type MV-90 or MC-HL

2.4 kV Okoguard Nonshielded Power Cable-
Aluminum Sheath — 5000V CSA RA90

3 Okopact® (Compact Stranded) Copper Conductors/90°C Rating
100% and 133% Insulation Level

For Cable Tray Use-Sunlight Resistant-For Direct Burial



Product Data Section 2: Sheet 21

Okoguard Insulation: 90 mils (2.29mm)

Catalog Number (1)	Conductor Size (AWG/kcmil)		Conductor Size - mm ²	Approx. Diameter over Insulation (in.)	Grounding Conductors No. x Size (AWG/kcmil)		Approx. Core O.D. - Inches	C-L-X O.D. - Inches		Jacket Thickness mils		Approx. O.D. - Inches		Approx. Net Weight lbs./1000'		Approx. Ship Weight lbs./1000'		Ampacities In Air (2)		Ampacities Cable Tray (3)		Ampacities Direct Burial (4)		
With Yellow Okoseal Jacket																								
571-21-3193	8	8.4	0.36	3x12	0.77	19.6	0.97	50	1.27	1.08	27.4	565	630	59	52	85								
571-21-3196	6	13.3	0.39	3x10	0.85	21.6	1.06	50	1.27	1.17	29.7	740	820	79	69	105								
▲ 571-21-3200	4	21.2	0.44	3x10	0.97	24.6	1.19	50	1.27	1.30	33.0	960	1050	105	91	135								
▲ 571-21-3204	2	33.6	0.50	3x10	1.10	27.9	1.34	50	1.27	1.45	36.8	1270	1470	140	125	180								
571-21-3208	1	42.4	0.52	3x8	1.16	29.4	1.42	50	1.27	1.53	38.9	1520	1660	160	140	200								
571-21-3212	1/0	53.5	0.56	3x8	1.23	31.2	1.51	60	1.52	1.65	41.9	1835	1980	185	165	230								
▲ 571-21-3217	2/0	67.4	0.60	3x8	1.33	33.8	1.60	60	1.52	1.73	43.9	2160	2325	215	190	260								
▲ 571-21-3224	4/0	107.0	0.70	3x7	1.53	38.9	1.83	60	1.52	1.96	49.8	3075	3340	285	255	335								
571-21-3228	250	127.0	0.75	3x6	1.64	41.7	1.96	60	1.52	2.09	53.1	3470	3725	320	280	365								
▲ 571-21-3236	350	177.0	0.85	3x6	1.86	47.2	2.19	60	1.52	2.32	58.9	4705	5265	395	350	440								
▲ 571-21-3244	500	253.0	0.96	3x5	2.10	53.3	2.45	75	1.91	2.61	66.3	6405	6965	485	425	530								
571-21-3248	750	380.0	1.14	3x4	2.51	63.8	2.93	75	1.91	3.10	78.7	9220	9980	615	525	650								
571-21-3252	1000	507.0	1.29	3x4	2.90	73.7	3.41	85	2.16	3.59	91.2	12075	13155	705	590	730								

Visit Okonite's web site, www.okonite.com for the most up to date dimensions.

▲ **Authorized stock item.** Available from our Customer Service Centers.
Copper or bronze and non-jacketed C-L-X is available on special order.

Jackets

Optional jacket types available - consult local sales office.

Aluminum Conductors

(1) Aluminum conductors are available on special order.

Ampacities

(2) Ampacities are in accordance with Table 310.71 of the NEC for an insulated three conductor cable, isolated in air, with a conductor operating temperature of 90°C and an ambient air temperature of 40°C.

(3) Ampacities are in accordance with Table 310.75 of the NEC for a three conductor Type MV-90 or MC cable installed in uncovered cable tray in accordance with Section 392.13 of the NEC with a conductor operating temperature of 90°C and ambient air temperature of 40°C. Where the cable tray is covered for more than six feet with solid unventilated covers, the ampacities shall not be more than 95% of the values shown above.

(4) Ampacities are in accordance with Table 310.83 of the NEC for an insulated three conductor cable directly buried in the earth with a conductor operating temperature of 90°C, ambient earth temperature of 20°C, 100% load factor and thermal resistance (RHO) of 90.

Refer to the NEC, IEEE/ICEA S-135 Power Cable Ampacity Tables, or the Okonite Engineering Data Bulletin for installation in duct banks, other ambient temperatures, circuit configurations or installation requirements.

C-L-X® The Okonite Company



C-L-X[®] Type MV-105 or MC-HL

5/8kV Okoguard[®] Shielded Power Cable-Aluminum Sheath

3 Okopact (Compact Stranded) Copper Conductors/105°C Rating

5kV-133% or 8kV-100% Insulation Level

For Cable Tray Use-Sunlight Resistant-For Direct Burial



- A Uncoated (Compact Stranded) Copper Conductors
- B Extruded Semiconducting EPR Strand Screen
- C Okoguard Insulation (EPR)
- D Extruded Semiconducting EPR Insulation Screen
- E Phase Identification Tape
- F Three Copper Grounding Conductors
- G Uncoated Copper Shield
- H Fillers and Binder Tape
- J Impervious, continuous, Corrugated Aluminum C-L-X Sheath
- K Jacket-Yellow Okoseal

Insulation

Okoguard is Okonite's registered trade name for its exclusive ethylene-propylene rubber (EPR) base, thermosetting compound, whose optimum balance of electrical and physical properties is unequalled in other solid dielectrics. Okoguard insulation, with the distinctive red color and a totally integrated EPR system, provides the optimum balance of electrical and physical properties for long, problem free service.

Assembly

Type MV-105 conductors are assembled with fillers, three bare stranded grounding conductors and a binder tape into a round core. A continuously corrugated welded aluminum sheath (C-L-X) encases the cable core. The C-L-X sheath is protected with a low temperature yellow Okoseal[®] jacket. The impervious, continuous, corrugated aluminum C-L-X sheath provides complete protection against moisture, liquids and gases in addition to its excellent mechanical strength. In addition, the aluminum sheath has adequate ampacity capability to be used as a grounding conductor in non HL areas. The Okoseal jacket allows the cable to be direct buried in the ground, embedded in concrete or areas subjected to corrosive atmospheres.

Applications

C-L-X power cables are recommended as an economical alternate to a wire in conduit system. They are designed specifically for use as feeders or branch circuits in industrial and utility power distribution systems. C-L-X power cables may be installed in both exposed and concealed work, wet and dry locations, directly buried in the earth, or embedded in concrete. They may be installed on metal racks, troughs, in cable trays or secured to supports not greater than 6 feet apart.

C-L-X Type MC-HL cables are also approved for Classes I, II, and III, Division 1 and 2 and Class I, Zones 1 and 2 hazardous locations - NEC Articles 501, 502, 503 and 505.

Specifications

Conductors: Uncoated copper compact stranded per ASTM B-496.

Strand Screen: Extruded semiconducting EPR strand screen meets or exceeds electrical and physical requirements of ICEA S-93-639/NEMA WC74 and UL 1072.

Insulation: Okoguard meets or exceeds the electrical and physical requirements of ICEA S-93-639/NEMA WC74 and UL 1072. The insulated conductors are tested in accordance with AEIC CS8.

Insulation Screen: Extruded semiconducting EPR insulation screen per ICEA S-93-639/NEMA WC74, AEIC CS8 and UL 1072.

Shield: 5 mil uncoated copper tape helically applied with 12.5% nominal overlap.

Phase Identification: Color coded (black, red, blue) polyester ribbon laid longitudinally under the copper shield tape.

Grounding Conductors: Three uncoated copper in accordance with UL 1072.

Assembly: Cabled with fillers and ground wires in the interstices, binder tape overall.

Sheath: Close fitting, impervious, continuous, corrugated aluminum C-L-X per UL 1072; C-L-X is recognized as a grounding conductor by NEC.

Jacket: A low temperature, sunlight resistant, yellow PVC jacket in accordance with UL 1072. Other color jackets are available. UL Listed as type MV-105 or MC-HL, sunlight resistant for use in cable tray, and for direct burial in accordance with UL 1072 & 2225. CSA Listed to C68.3.

Product Features

- Triple tandem extruded, all EPR system.
- Complete prepackaged, color coded, factory tested wiring system.
- Okoguard C-L-X cables meet or exceed all recognized industry standards (UL, AEIC, NEMA/ICEA, IEEE).
- Passes the vertical tray flame test requirements of IEEE 383 and 1202, UL 1072, ICEA T-29-520 (210,000 BTU/hr.).
- Complies with NEC Sections 310.7 and 300.50 for direct burial.
- Complies with NEC Articles 501, 502, 503 and 505 for hazardous locations.
- Continuous sheath provides grounding safety.
- Excellent corona resistance.
- Screens are clean stripping.
- Exceptional resistance to "treeing".
- Minimum installation temperature of -40°C.
- Improved Temperature Rating.
- Three symmetrical grounding conductors for PWM/VFD and other modern AC drive/motor applications.
- ABS listed as CWCMC Type MC-HL.
- CSA listed as FT4 and LTGG (-40°C).

C-L-X Type MV-105 or MC-HL

5/8kV Okoguard Shielded Power Cable-Aluminum Sheath
 3 Okopact (Compact Stranded) Copper Conductors/105°C Rating
 100% and 133% Insulation Level

Product Data Section 2: Sheet 22

For Cable Tray Use-Sunlight Resistant-For Direct Burial



Okoguard Insulation: 115 mils (2.92mm), 5kV-133% or 8kV-100% Insulation Level

Catalog Number (1)	Conductor Size (AWG/kcmil)		Conductor Size - mm ²	Approx. Diameter over Insulation (in.)	Grounding Conductors No. x Size (AWG/kcmil)		Approx. Core O.D. - Inches	C-L-X O.D. - mm		Jacket Thickness mils		Jacket Thickness mm		Approx. O.D. - Inches	Approx. O.D. - mm		Approx. Net Weight lbs./1000'	Approx. Ship Weight lbs./1000'	Ampacities In Air (2)	Ampacities Cable Tray (3)	Ampacities Direct Burial(4)
With Yellow Okoseal Jacket																					
*571-22-3694	8	8.4	0.40	3x12	1.04	26.4	1.29	50	1.27	1.40	35.6	907	1056	66	58	90					
571-22-3696	6	13.3	0.44	3x10	1.12	28.4	1.37	50	1.27	1.48	37.6	1090	1259	88	77	115					
571-22-3698	4	21.2	0.48	3x10	1.21	30.7	1.51	60	1.52	1.65	41.9	1398	1556	115	100	150					
▲ 571-22-3706	2	33.6	0.54	3x10	1.34	34.0	1.64	60	1.52	1.78	45.2	1732	1890	154	135	190					
571-22-3708	1	42.4	0.58	3x8	1.40	35.6	1.69	60	1.52	1.82	46.2	1992	2137	180	155	215					
571-22-3710	1/0	53.5	0.61	3x8	1.48	37.6	1.78	60	1.52	1.91	48.5	2273	3012	205	185	245					
▲ 571-22-3717	2/0	67.4	0.65	3x8	1.57	39.9	1.92	60	1.52	2.00	50.8	2616	4171	240	210	280					
▲ 571-22-3725	4/0	107.0	0.75	3x7	1.78	45.2	2.15	60	1.52	2.29	58.2	3613	3980	320	285	360					
571-22-3727	250	127.0	0.80	3x6	1.90	48.3	2.28	60	1.52	2.44	62.0	4175	4390	355	315	395					
▲ 571-22-3838	350	177.0	0.89	3x6	2.10	53.3	2.45	75	1.91	2.61	66.3	5328	5435	440	390	475					
▲ 571-22-3846	500	253.0	1.01	3x5	2.35	57.6	2.75	75	1.91	2.91	73.9	7095	7603	545	475	570					
571-22-3748	750	380.0	1.19	3x4	2.73	69.3	3.24	85	2.16	3.42	86.9	10134	11021	685	585	700					
571-22-3751	1000	507.0	1.34	3x4	3.06	77.7	3.64	85	2.16	3.81	96.8	12966	14596	790	660	785					

* This cable is only rated 5kV (133%), due to UL limitations, it cannot be rated 8kV.

Visit Okonite's web site, www.okonite.com for the most up to date dimensions.

For 8kV ampacities refer to the NEC tables referenced below in the columns listed 5001-35,000 Volts

▲ **Authorized stock item.** Available from our Customer Service Centers.
 Copper or bronze C-L-X and non-jacketed C-L-X are available on special order.

Jackets

Optional jacket types available - consult local sales office.

Aluminum Conductors

(1) Aluminum conductors are available on special order.

Ampacities

(2) Ampacities are in accordance with Table 310.60(C)(71) of the NEC for an insulated three conductor cable, isolated in air, with a conductor operating temperature of 105°C and an ambient air temperature of 40°C.

(3) Ampacities are in accordance with Table 310.60(C)(75) of the NEC for a three conductor Type MV-105 or MC cable installed in uncovered cable tray in

accordance with Section 392.80(B) of the NEC with a conductor operating temperature of 105°C and ambient air temperature of 40°C. Where the cable tray is covered for more than six feet with solid unventilated covers, the ampacities shall not be more than 95% of the values shown above.

(4) Ampacities are in accordance with Table 310.60(B)(83) of the NEC for an insulated three conductor cable directly buried in the earth with a conductor operating temperature of 105°C, ambient earth temperature of 20°C, 100% load factor and thermal resistance (RHO) of 90.

Refer to the NEC, IEEE/ICEA S-135 Power Cable Ampacity Tables, or the Okonite Engineering Data Bulletin for installation in duct banks, other ambient temperatures, circuit configurations or installation requirements.

C-L-X® The Okonite Company



C-L-X[®] Type MV-105 or MC-HL



15kV Okoguard[®] Shielded Power Cable-Aluminum Sheath

3 Okopact[®] (Compact Stranded) Copper Conductors/105°C Rating
133% Insulation Level

For Cable Tray Use-Sunlight Resistant-For Direct Burial

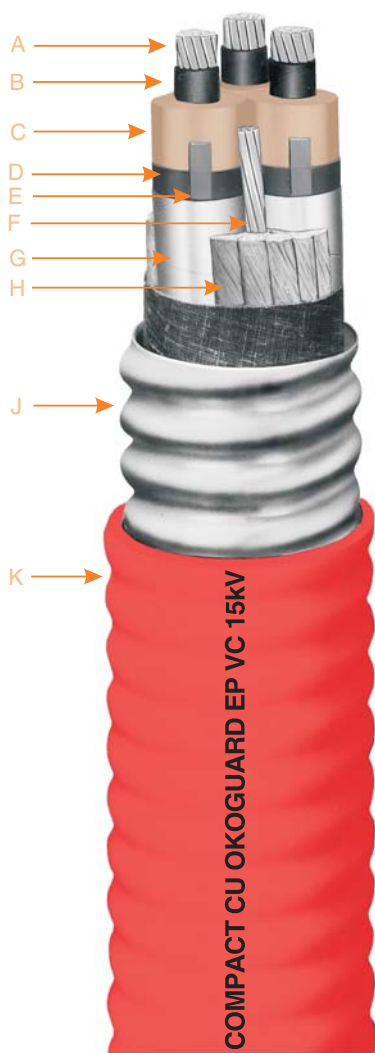

- A Uncoated Okopact (Compact Stranded) Copper Conductors
- B Extruded Semiconducting EPR Strand Screen
- C Okoguard Insulation (EPR)
- D Extruded Semiconducting EPR Insulation Screen
- E Phase Identification Tape
- F Copper Grounding Conductor
- G Uncoated Copper Shield
- H Fillers and Binder Tape
- J Impervious, Continuous, Corrugated Aluminum C-L-X Sheath
- K Jacket-Red Low Temperature Okoseal

Insulation

Okoguard is Okonite's registered trade name for its exclusive ethylene-propylene rubber (EPR) base, thermosetting compound, whose optimum balance of electrical and physical properties is unequalled in other solid dielectrics. Okoguard insulation, with the distinctive red color and a totally integrated EPR system, provides the optimum balance of electrical and physical properties for long, problem free service.

Assembly

The Type MV-105 conductors are assembled with fillers, one bare stranded grounding conductor and a binder tape into a round core. A continuously corrugated welded aluminum sheath (C-L-X) encases the cable core. The C-L-X sheath is protected with a low temperature red Okoseal[®] jacket. The impervious, continuous, corrugated aluminum C-L-X sheath provides complete protection against moisture, liquids and gases in addition to its excellent mechanical strength. In addition, the aluminum sheath has adequate ampacity capability to be used as a grounding conductor in non HL areas. The Okoseal jacket allows the cable to be direct buried in the ground, embedded in concrete or areas subjected to corrosive atmospheres.

Applications

C-L-X power cables are recommended as an economical alternate to a wire in conduit system. They are designed specifically for use as feeders or branch circuits in industrial and utility power distribution systems. C-L-X power cables may be installed in both exposed and concealed work, wet and dry locations, direct burial in the earth, or embedded in concrete. They may be installed on metal racks, troughs, in cable trays or secured to supports not greater than 6 feet apart.

C-L-X Type MC-HL cables are also approved for Classes I, II, and III, Divisions 1 and 2 and Class I, Zones 1 and 2 hazardous locations - NEC Articles 501, 502, 503 and 505.

Specifications

Conductors: Uncoated copper compact stranded per ASTM B-496.

Strand Screen: Extruded semiconducting EPR strand screen meets or exceeds electrical and physical requirements of ICEA S-93-639/NEMA WC74 and UL 1072.

Insulation: Okoguard meets or exceeds the electrical and physical requirements of ICEA S-93-639/NEMA WC74 and UL 1072. The insulated conductors are tested in accordance with AEIC CS8.

Insulation Screen: Extruded semiconducting EPR insulation screen meets or exceeds electrical and physical requirements of ICEA S-93-639/NEMA WC74 and UL 1072.

Shield: 5 mil uncoated copper tape helically applied with 12.5% nominal overlap.

Phase Identification: Color coded (black, red, blue) polyester ribbon laid longitudinally under the copper shield tape.

Grounding Conductor: Uncoated copper in accordance with UL 1072.

Assembly: Cabled with fillers and ground wire in the interstices, binder tape overall.

Sheath: Close fitting, impervious, continuous, corrugated aluminum C-L-X per UL 1072; C-L-X is recognized as a grounding conductor by NEC.

Jacket: A low temperature, sunlight resistant, red PVC jacket in accordance with UL 1072. Other color jackets are available.

UL Listed as type MV-105 or MC-HL, sunlight resistant, for use in cable tray, and for direct burial in accordance with UL 1072 and 2225. UL certified to IEEE 1580. CSA Listed to C68.3.

Product Features

- Triple tandem extruded, all EPR system.
- Complete prepackaged, color coded, factory tested wiring system.
- Okoguard C-L-X cables meet or exceed all recognized industry standards (UL, AEIC, NEMA/ICEA, IEEE).
- Passes the vertical tray flame test requirements of IEEE 383 and 1202, UL 1072, ICEA T-29-520 (210,000 BTU/hr.)
- Complies with NEC Sections 310.7 and 300.50 for direct burial.
- Complies with NEC Articles 501, 502, 503 and 505 for hazardous locations.
- Continuous sheath provides grounding safety.
- Excellent corona resistance.
- Screens are clean stripping.
- Exceptional resistance to "treeing".
- Minimum installation temperature of -40°C.
- Improved Temperature Rating.
- ABS listed as CWCMC Type MC-HL.
- CSA listed as FT4 and LTGG (-40°C).

C-L-X Type MV-105 or MC-HL

Product Data Section 2: Sheet 24

15kV Okoguard Shielded Power Cable-Aluminum Sheath
3 Okopact (Compact Stranded) Copper Conductors/105°C Rating
133% Insulation Level
For Cable Tray Use-Sunlight Resistant-For Direct Burial
Okoguard Insulation: 220 mils (5.59mm)



Catalog Number (1)	Conductor Size (AWG/kcmil)		Conductor Size - mm ²	Approx. Diameter over Insulation (In.)	Grounding Conductor Size (AWG/kcmil)		Approx. Core O.D. - Inches	Approx. Core O.D. - mm	C-L-X O.D. - Inches	Jacket Thickness (mils)	Jacket Thickness mm	Approx. O.D. - Inches	Approx. O.D. - mm	Approx. Net Weight lbs./1000'	Approx. Ship Weight lbs./1000'	Ampacities In Air (2)	Ampacities Cable Tray (3)	Ampacities Direct Burial (4)
With Red Okoseal Jacket																		
▲ 571-23-3504	2	33.6	0.76	6	1.79	45.5	2.15	60	1.52	2.28	57.9	2420	3147	185	165	200		
571-23-3508	1	42.4	0.79	4	1.86	47.3	2.23	60	1.52	2.36	60.0	2706	3404	210	185	225		
571-23-3512	1/0	53.5	0.83	4	1.94	49.3	2.32	75	1.91	2.48	63.0	3076	3674	240	215	255		
▲ 571-23-3516	2/0	67.4	0.87	4	2.03	51.6	2.41	75	1.91	2.57	65.3	3434	4219	275	245	290		
▲ 571-23-3524	4/0	107.0	0.97	3	2.24	57.0	2.63	75	1.91	2.79	70.9	4460	5385	360	320	345		
571-23-3528	250	127.0	1.03	2	2.36	60.0	2.76	75	1.91	2.92	74.2	5078	5845	400	350	410		
▲ 571-23-3536	350	177.0	1.12	2	2.56	65.0	2.98	75	1.91	3.14	79.8	6264	7305	490	430	495		
▲ 571-23-3544	500	253.0	1.24	1	2.81	71.4	3.28	75	1.91	3.46	89.2	8221	9653	600	525	590		
▲ 571-23-3548	750	380.0	1.41	1/0	3.19	81.0	3.76	85	2.16	3.94	100.0	11317	13087	745	635	720		

Visit Okonite's web site, www.okonite.com for the most up to date dimensions.

▲ **Authorized stock item.** Available from our Customer Service Centers.

Jackets

Optional jacket types available - consult local sales office.

Copper or bronze C-L-X and non-jacketed C-L-X are available on special order.

Aluminum Conductors

(1) Aluminum conductors are available on special order.

Ampacities

(2) Ampacities are in accordance with Table 310.60(B)(71) of the NEC for an insulated three conductor cable, isolated in air, with a conductor operating temperature of 105°C and an ambient air temperature of 40°C.

(3) Ampacities are in accordance with Table 310.60(B)(75) of the NEC for a three conductor Type MV-105 or MC cable installed in uncovered cable tray in accordance with Section 392.80(B) of the NEC with a conductor operating temperature of 105°C and ambient air temperature of 40°C. Where the cable tray

is covered for more than six feet with solid unventilated covers, the ampacities shall not be more than 95% of the values shown above.

(4) Ampacities are in accordance with Table 310.60(B)(83) of the NEC for an insulated three conductor cable directly buried in the earth with a conductor operating temperature of 105°C, ambient earth temperature of 20°C, 100% load factor, thermal resistance (RHO) of 90.

Refer to the NEC, IEEE/ICEA S-135 Power Cable Ampacity Tables, or the Okonite Engineering Data Bulletin for installation in duct banks, other ambient temperatures, circuit configurations or installation requirements.

C-L-X® The Okonite Company



Solid Type PILC

15kV Paper Insulated Lead Covered Power Cable

Three Copper Conductors/90°C Rating
100% Insulation Level

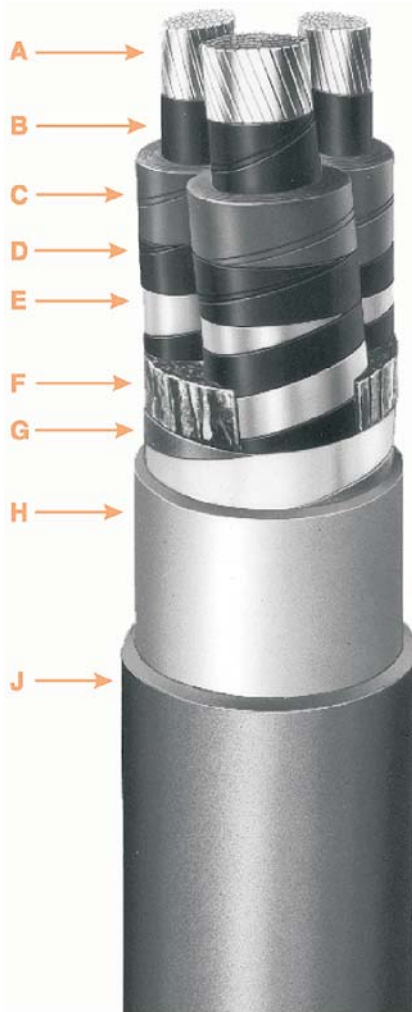

- A Conductors-Stranded Compact Sector, Pre-twisted
- B Strand Screen-Carbon Black Paper Tapes
- C Insulation- Impregnated Paper Tapes
- D Insulation Screen-Carbon Black Paper Tape
- E Shield Copper Tape
- F Fillers-Impregnated Paper
- G Binder Copper Tape
- H Sheath-Copper Bearing Lead
- J Jacket-Okolene (PE)

Insulation

Okonite's impregnated paper insulation consists of the finest electrical grade paper made from coniferous wood pulp and the purest grade polybutene dielectric fluid. The paper is manufactured to Okonite's specifications to produce the necessary mechanical and physical properties to resist tearing and wrinkling during manufacture and subsequent handling during installation conditions; and in addition, to assure properties of low dielectric loss with high dielectric strength. Okonite pretwists the sectors of 3/C cables before taping to virtually eliminate wrinkles at the cabling machine. To maintain a smooth, wrinkle-free precisely gapped tape insulation, Okonite carefully slits its own taping pads into widths tailored for each conductor size and wall thickness. Most important, Okonite has the latest taping machines with the most precise tape tension controls available today.

The impregnating fluids used are of medium viscosity (high viscosity optional) polybutene types, also manufactured to Okonite specifications. Polybutene dielectric fluids are better than natural petroleum based insulating fluids because they resist aging, have lower and more stable power factor values and possess an inherent tackiness which resists draining out of the paper tapes. Okonite's impregnation facilities clay-filter and degas the dielectric fluids to provide low power factors and stable ionization levels from voltage stress.

Sheath & Jacket

Okonite's copper bearing lead sheath provides an impervious barrier from the environment; in addition, it provides mechanical protection for the insulation and encapsulation of the impregnant. All lead sheaths have the inherent capacity for substantial electrical conductivity, even under short circuit conditions without requiring a separate ground. Okonite's lead sheaths are applied with a continuous lead extruder under the control of a thickness gauge for uniform wall thickness and concentricity of extrusion.

The Okolene jacket provides mechanical and corrosion protection for the lead sheath and is used in most installations. (Indoor and aerial installations may not require a jacket). Okolene is a thermoplastic polyethylene material that resists most chemicals and moisture; it is unaffected by oils below 60°C and has a low

coefficient of friction which aids pulling through ducts and conduits.

Applications

Okonite Paper Insulated Lead Covered 3/C cable is recommended for use in underground ducts, direct buried, and aerially when lashed to a messenger. PILC cables are used in any circuit that requires the highest reliability, the longest uninterrupted service life, and where the greatest surge, impulse and AC dielectric strength is desired. An added advantage is that a 3/C PILC cable permits the largest amount of power to be transmitted in the smallest diameter space because of its unique triangle shaped and nested design.

Although not shown as an insulation above 600 Volts in the National Electrical Code, it is readily approved for use by local inspectors because of its extensive safe use by utilities. Therefore, PILC cables can be used in industrial or commercial applications with prior notification and approval by the local inspector.

Also available in other voltage ratings.

Specifications

Okonite PILC cables are manufactured in accordance with and meet the requirements of AEIC CS1-12 12th Edition.

Product Features

- Pre-twisted conductors.
- Polybutene impregnating fluid.
- 90°C continuous operating temperature.
- 110°C emergency rating.
- 200°C short circuit rating.
- High impulse strength.
- Proven service life of over 60 years.
- Impervious to environment.
- Also available with LS/ZH Okoclear TP (TPPO) Okoseal (PVC) and ROC (Reinforced Okonite Covering).

Solid Type PILC

15kV Paper Insulated Lead Covered Power Cable
 Three Copper Conductors/90°C Rating
 100% Insulation Level

Product Data Section 2: Sheet 31

Catalog Number	Conductor Size AWG/kcmil	Conductor Size - mm ²	Insulation Thickness - mils	Insulation Thickness - mm	Lead Thickness - mils	Jacket Thickness - mils	Cable Diameter - mils	Net Weight - lbs./ft.	Ampacities Duct (1)	Ampacities in Air (2)
Concentric Round										
101-63-4120	2	33.6	180	4.6	90	90	1.92	4.34	146	149
101-63-4175	1	42.4	165	4.2	90	90	1.94	4.53	167	171
Compact Round										
101-63-4243	1/0	53.5	165	4.2	90	90	1.97	4.83	191	197
Compact Sector										
101-63-4277	2/0	67.4	165	4.2	90	90	1.92	4.80	215	222
101-63-4335	3/0	85.0	165	4.2	90	90	2.00	5.32	245	256
101-63-4373	4/0	107.0	165	4.2	95	90	2.12	6.13	280	295
101-63-4436	250	127.0	165	4.2	95	90	2.19	6.67	307	327
101-63-4553*	350	177.0	165	4.2	100	90	2.37	8.14	371	402
▲ 101-63-4544	350	177.0	165	4.2	100	90	2.37	8.19	371	402
101-63-4666*	500	253.0	165	4.2	105	110	2.64	10.31	450	498
▲ 101-63-4665	500	253.0	165	4.2	105	110	2.64	10.37	450	498
101-63-4904	750	380.0	165	4.2	110	110	2.94	13.71	555	631
101-63-4986	1000	507.0	165	4.2	120	110	3.29	17.33	636	740

*Zinc Shielding Tape in lieu of Copper

▲ **Authorized Stock Item.** Stock Items with copper shield tapes, copper binder tape and high viscosity polybutene impregnating fluid. Available from our Customer Service Centers.

Ampacities

- (1) One circuit, 90°C conductor, RHO 90 and 20°C earth ambient temperatures, 100% load factor.
- (2) One circuit or multiple circuits spaced a cable diameter or more apart, 40°C ambient air temperature, 40 to 100% load factor.



Okoguard® URO-J 15kV Underground Primary Distribution Cable-Jacketed Red Identification Stripes

Aluminum Conductor/105°C Rating
100% and 133% Insulation Levels



- A Conductor-Stranded Aluminum
- B Strand Screen-
Extruded Semiconducting EPR
- C Insulation-Okoguard-EPR
- D Insulation Screen-
Extruded Semiconducting EPR
- E Concentric Conductor-Bare
Copper Wires
- F Encapsulating Jacket-Okolene
with 3 extruded red ID stripes
and NESC lightning bolt

Insulation

Okoguard is Okonite's registered trade name for its exclusive ethylene-propylene rubber (EPR) based, thermosetting compound, whose optimum balance of electrical and physical properties is unequalled in other solid dielectrics.

Okoguard insulation, with the distinctive red color and a totally integrated EPR system, provides the optimum balance of electrical and physical properties for long, problem free service.

The triple tandem extrusion of the screens with the insulation provides optimum electrical characteristics.

An insulation screen of ethylene-propylene rubber is extruded over the insulation. The bare copper concentric wires are uniformly spaced around the insulation screen. The overall polyethylene jacket provides protection against mechanical damage and corrosion.

Product identification is provided through the use of three red stripes placed 120° apart in the black jacket with an NESC lightning bolt.

Applications

Okoguard URO-J cables provide maximum circuit longevity in underground residential distribution systems. They can be buried directly or installed in underground ducts or conduits.

Specifications

Central Conductor: Aluminum per ASTM B-609, Class B stranded per B-231.

Conductor Screen: Extruded semiconducting ethylene-propylene rubber meets or exceeds the requirements of ICEA S-94-649 and AEIC CS8.

Insulation: Extruded Okoguard meets or exceeds the requirements of ICEA S-94-649 for ethylene-propylene rubber and AEIC CS8.

Insulation Screen: Extruded semiconducting ethylene-propylene rubber meets or exceeds the requirements of ICEA S-94-649 and AEIC CS8.

Concentric Conductor: Bare copper wires.

Jacket: Black Okolene with red extruded stripes meets or exceeds the requirements of ICEA S-94-649 for polyethylene jackets.

Product Features

- Triple tandem extruded, all EPR system
 - Okoguard cables meet or exceed ICEA and RUS 7CFR 1728.204 standards.
 - 105°C continuous operating temperature.
 - 140°C emergency rating.
 - 250°C short circuit rating.
 - Excellent corona resistance.
 - Low dielectric constant and power factor.
 - Screens are clean stripping.
 - Exceptional resistance to "treeing".
 - Moisture resistant.
 - Overall jacket provides extended life.
 - Red extruded stripes.
 - Excellent resistance to most chemicals.
 - Can be listed as Type MV-90 for use in accordance with Article 328 of the NEC on special orders.
 - Cable CSA Listed to C68.5 on special orders.
 - Design Options:
 - Additional conductor sizes
 - Filled strand
 - Copper central conductor
 - Copper flat strap concentric neutral
 - Product identification via colored jackets.
 - Semiconducting jacket
 - Improved Temperature Rating.
- Okoguard insulation system has been tested and qualified for operation at 105°C continuous and 140°C emergency operating temperature.
- Minimum installation temperature of -40°C.

Okoguard URO-J

15kV Underground Primary Distribution Cable-Jacketed
 Red Identification Stripes
 Aluminum Conductor/105°C Rating
 100% Insulation Level

Product Data Section 2: Sheet 35

Okoguard Insulation: 175 mils 100% Insulation Level

Catalog Number	Conductor Size AWG/kcmil	Nominal Dia. over Insulation (in.)	Nominal Dia. over Insulation Screen (in.)	Copper Neutral No. x AWG (1)	Nominal O.D. (in.)	Approx. Net Weight lbs./1000'	Approx. Ship Weight lbs./1000'	90° Ampacity Direct Burial (2)	90° Ampacity Duct (2)	105° Ampacity Direct Burial (2)	105° Ampacity Duct (2)
FULL NEUTRAL											
161-23-2057	2(1x)	0.66	0.73	10 x 14	0.97	513	603	165	120	180	130
▲ 161-23-2060	2(7x)	0.67	0.75	10 x 14	0.98	517	568	165	120	180	130
161-23-2066	1(19x)	0.72	0.80	13 x 14	1.03	608	698	185	135	205	150
161-23-2069	1/0(1x)	0.72	0.80	16 x 14	1.04	657	747	210	155	235	170
▲ 161-23-2072	1/0(19x)	0.75	0.83	16 x 14	1.06	667	725	235	170	235	170
161-23-2075	2/0(19x)	0.81	0.88	13 x 12	1.15	820	910	240	175	270	200
161-23-2078	3/0(19x)	0.86	0.93	16 x 12	1.20	939	1029	270	200	305	225
161-23-2081	4/0(19x)	0.91	0.99	13 x 10	1.30	1138	1238	310	230	650	260
161-23-2084	250(37x)	0.97	1.04	16 x 10	1.36	1302	1418	340	255	385	285
161-23-2090	350(37x)	1.07	1.17	20 x 10	1.49	1615	1793	405	300	455	340
1/3 NEUTRAL											
160-23-2057	2(1x)	0.66	0.73	6 x 14	0.97	467	528	155	135	165	130
160-23-2060	2(7x)	0.68	0.76	6 x 14	1.00	489	579	155	135	165	130
160-23-2066	1(19x)	0.72	0.80	6 x 14	1.03	527	617	175	155	190	150
160-23-2069	1/0(1x)	0.72	0.80	6 x 14	1.04	541	663	200	175	215	175
160-23-2072	1/0(19x)	0.76	0.84	6 x 14	1.07	572	662	200	175	215	175
160-23-2075	2/0(19x)	0.81	0.88	7 x 14	1.12	636	726	230	200	245	195
160-23-2078	3/0(19x)	0.86	0.93	9 x 14	1.17	722	889	260	230	280	225
160-23-2081	4/0(19x)	0.91	0.99	11 x 14	1.23	822	922	290	240	315	225
160-23-2084	250(37x)	0.97	1.04	13 x 14	1.28	918	1018	320	260	345	280
160-23-2090	350(37x)	1.07	1.17	18 x 14	1.41	1166	1315	380	320	415	345
160-23-2093	500(37x)	1.20	1.30	16 x 12	1.57	1513	1691	455	385	495	415
160-23-2096	750(61x)	1.39	1.49	15 x 10	1.87	2152	2402	555	470	600	510
160-23-2099	1000(61x)	1.54	1.68	18 x *(A)	2.06	2711	3059	645	550	685	585

* - Special Conductor Size (A) Wire O.D. =0.1066"

(1) Individual wire size and count may vary. The resulting combination meets the 1/3 or full neutral, size requirement.

Visit Okonite's web site www.okonite.com for the most up to date dimensions.

▲ **Authorized stock item.** Available from our Customer Service Centers.

Ampacities

(2) Full neutral, single phase ampacities are based on 90°C or 105°C conductor temperature, 20°C ambient temperature, 100% load factor, and earth thermal resistivity of RHO 90. One third neutral ampacities are based on ICEA P-53-426 triplexed or triangular configuration for the same conditions stated above.

Okoguard URO-J

15kV Underground Primary Distribution Cable-Jacketed
 Red Identification Stripes
 Aluminum Conductor/105°C Rating
 133% Insulation Levels

Product Data Section 2: Sheet 35

Okoguard Insulation: 220 mils 133% Insulation Level

Catalog Number	Conductor Size AWG/kcmil	Nominal Dia. over Insulation (in.)	Nominal Dia. over Insulation Screen (in.)	Copper Neutral No. x AWG (1)	Nominal O.D. (in.)	Aprox. Net Weight lbs./1000'	Aprox. Ship Weight lbs./1000'	90° Ampacity Direct Burial (2)	90° Ampacity Duct (2)	105° Ampacity Direct Burial (2)	105° Ampacity Duct (2)
FULL NEUTRAL											
▲ 161-23-3057	2(1x)	0.74	0.82	10 x 14	1.06	577	635	165	120	180	130
▲ 161-23-3060	2(7x)	0.77	0.84	10 x 14	1.08	595	662	165	120	180	130
161-23-3066	1(19x)	0.81	0.89	13 x 14	1.13	691	781	185	135	205	150
▲ 161-23-3069	1/0(1x)	0.81	0.89	16 x 14	1.12	726	792	210	170	235	170
▲ 161-23-3072	1/0(19x)	0.84	0.92	16 x 14	1.15	752	818	210	170	235	170
161-23-3075	2/0(19x)	0.90	0.97	13 x 12	1.24	912	1012	240	175	270	200
161-23-3078	3/0(19x)	0.95	1.02	16 x 12	1.29	1036	1136	270	200	305	225
161-23-3081	4/0(19x)	1.01	1.08	13 x 10	1.39	1241	1357	310	230	650	260
161-23-3084	250(37x)	1.06	1.16	16 x 10	1.48	1441	1619	340	255	385	285
161-23-3090	350(37x)	1.17	1.27	20 x 10	1.58	1734	1912	405	300	455	340
1/3 NEUTRAL											
160-23-3057	2(1x)	0.75	0.82	6 x 14	1.06	544	621	155	135	165	130
160-23-3060	2(7x)	0.78	0.85	6 x 14	1.09	569	659	155	135	165	130
160-23-3066	1(19x)	0.81	0.89	6 x 14	1.13	610	700	175	155	190	150
160-23-3069	1/0(1x)	0.82	0.89	6 x 14	1.13	625	715	200	175	215	175
160-23-3072	1/0(19x)	0.85	0.93	6 x 14	1.17	658	748	200	175	215	175
160-23-3075	2/0(19x)	0.90	0.97	7 x 14	1.21	726	826	230	200	245	195
160-23-3078	3/0(19x)	0.95	1.02	9 x 14	1.26	816	916	260	230	280	225
▲ 160-23-3081	4/0(19x)	0.99	1.06	11 x 14	1.30	889	1002	290	240	315	255
160-23-3084	250(37x)	1.06	1.16	13 x 14	1.40	1052	1168	320	260	345	280
160-23-3090	350(37x)	1.17	1.27	18 x 14	1.50	1280	1458	380	320	415	345
160-23-3093	500(37x)	1.29	1.39	16 x 12	1.73	1709	1959	455	385	495	415
▲ 160-23-3096	750(61x)	1.48	1.58	15 x 10	1.96	2237	2518	555	470	600	510
160-23-3099	1000(61x)	1.64	1.77	18 x *(A)	2.15	2875	3223	645	550	685	585
160-23-9592	1100(61x)	1.62	1.75	12 x 14	2.05	2307	2593	700	590	760	645

* - Special Conductor Size (A) Wire O.D. = 0.1066"

** - Special design 7% neutral, Compact Conductor

(1) Individual wire size and count may vary. The resulting combination meets the 1/3 or full neutral, size requirement.

Visit Okonite's web site www.okonite.com for the most up to date dimensions.

Ampacities

(2) Full neutral, single phase ampacities are based on 90°C conductor temperature, 20°C ambient temperature, 100% load factor, earth thermal resistivity of RHO 90 and 36" depth of burial.

One third neutral ampacities are based on ICEA P-53-426 triplexed or triangular configuration for the same conditions stated above.



Okoguard® URO-J

15kV Underground Primary Distribution Cable-Jacketed Red Identification Stripes

Filled Strand Aluminum Conductor/105°C Rating
100% and 133% Insulation Levels



- A Conductor - Stranded Aluminum with Filled Strand - Water Swellable Power
- B Strand Screen - Extruded Semi-conducting EPR
- C Insulation - Okoguard EPR
- D Insulation Screen - Extruded Semi-conducting EPR
- E Concentric Conductor-Bare Copper Wires
- F Encapsulating Jacket-Okolene with Extruded ID Stripes & NESC lightning bolt

Insulation

Okoguard is Okonite's registered trade name for its exclusive ethylene-propylene rubber (EPR) based, thermosetting compound, whose optimum balance of electrical and physical properties is unequalled in other solid dielectrics. Okoguard insulation, with the distinctive red color and a totally integrated EPR system, provides the optimum balance of electrical and physical properties for long, problem free service.

The triple tandem extrusion of the screens with the insulation provides optimum electrical characteristics.

The compressed conductors are filled with water swellable powder. This construction slows the migration of water through the strands in the event of a mechanical dig-in followed by external exposure to water.

An insulation screen of ethylene-propylene rubber is extruded over the insulation. The copper concentric wires are uniformly spaced around the insulation screen. The overall polyethylene jacket provides protection against mechanical damage and corrosion.

Product identification is provided through the use of three red stripes placed 120° apart in the black jacket, with an NESC lightning bolt.

Applications

Okoguard URO-J cables provide maximum circuit longevity in underground residential distribution systems. They can be buried directly or installed in underground ducts or conduits.

Specifications

Central Conductor: Aluminum per ASTM B-609, Class B stranded per B-231.

Filled Strand: Water swellable powder meets or exceeds ICEA T-31-610 water penetration resistance and ANSI/NEMA class A connectorability requirements.

Conductor Screen: Extruded semiconducting ethylene-propylene rubber meets or exceeds the requirements of ICEA S-94-649 and AEIC CS8.

Insulation: Extruded Okoguard meets or exceeds the requirements of ICEA S-94-649 and AEIC CS8.

Insulation Screen: Extruded semiconducting ethylene-propylene rubber meets or exceeds the requirements of ICEA S-94-649 and AEIC CS8.

Concentric Conductor: Bare copper wires.

Jacket: Black Okolene with red extruded stripes meets or exceeds the requirements of ICEA S-94-649 for polyethylene jackets.

Product Features

- Triple tandem extruded, all EPR system.
- Okoguard cables meet or exceed NEMA/ICEA and RUS 7CFR 1728.204 standards.
- 105°C continuous operating temperature.
- 140°C emergency rating.
- 250°C short circuit rating.
- Excellent corona resistance.
- Low dielectric constant and power factor.
- Screens are clean stripping.
- Exceptional resistance to "treeing".
- Filled strand conductor.
- Moisture resistant.
- Overall jacket provides extended life.
- Excellent resistance to most chemicals.
- Can be listed by UL as Type MV-90 on special orders.
- Cable listed by CSA to C68.5 on special orders.
- Design Options:
 - Additional conductor sizes
 - Copper central conductor
 - Copper flat strap concentric neutral
 - Product identification via colored jackets.
 - Semiconducting jackets.
- Improved Temperature Rating. Okoguard insulation system has been tested and qualified for operation at 105°C continuous and 140°C emergency operating temperature.
- Minimum installation temperature of -40°C.

Okoguard URO-J

15kV Underground Primary Distribution Cable-Jacketed
 Red Identification Stripes
 Filled Strand Aluminum Conductor/105°C Rating
 100% Insulation Level

Product Data Section 2: Sheet 36

Okoguard Insulation: 175 mils 100% Insulation Level

Catalog Number	Conductor Size AWG/kcmil	Nominal Dia. over Insulation (in.)	Nominal Dia. over Insulation Screen (in.)	Copper Neutral, No. x AWG (1)	Nominal O.D. (in.)	Approx. Net Weight lbs./1000'		Approx. Ship Weight lbs./1000'		90° Ampacity Direct Burial (2)	90° Ampacity Duct (2)	105° Ampacity Direct Burial (2)	105° Ampacity Duct (2)
FULL NEUTRAL													
163-23-2060	2(7x)	0.68	0.76	10 x 14	1.00	536	626	165	120	180	130		
163-23-2066	1(19x)	0.72	0.80	13 x 14	1.03	608	698	185	135	205	150		
**163-23-2072	1/0(19x)	0.76	0.84	16 x 14	1.07	688	778	210	155	235	170		
163-23-2075	2/0(19x)	0.81	0.88	13 x 12	1.15	820	910	240	175	270	200		
163-23-2078	3/0(19x)	0.86	0.93	16 x 12	1.20	939	1029	270	200	305	225		
163-23-2081	4/0(19x)	0.91	0.99	13 x 10	1.30	1138	1238	310	230	350	260		
163-23-2084	250(37x)	0.97	1.04	16 x 10	1.36	1302	1418	340	255	385	285		
163-23-2090	350(37x)	1.07	1.17	20 x 10	1.49	1615	1793	405	300	455	340		
1/3 NEUTRAL													
162-23-2060	2(7x)	0.68	0.76	6 x 14	1.00	489	579	155	135	165	130		
162-23-2066	1(19x)	0.72	0.80	6 x 14	1.03	527	617	175	155	190	150		
162-23-2072	1/0(19x)	0.76	0.84	6 x 14	1.07	572	662	200	175	215	175		
162-23-2075	2/0(19x)	0.81	0.88	7 x 14	1.12	636	726	230	200	245	195		
162-23-2078	3/0(19x)	0.86	0.93	9 x 14	1.17	722	889	260	230	280	225		
162-23-2081	4/0(19x)	0.91	0.99	11 x 14	1.23	822	922	290	240	315	255		
162-23-2084	250(37x)	0.97	1.04	13 x 14	1.28	918	1018	320	260	345	280		
162-23-2090	350(37x)	1.07	1.17	18 x 14	1.41	1166	1315	380	320	415	345		
162-23-2093	500(37x)	1.20	1.30	16 x 12	1.57	1513	1691	455	385	495	415		
162-23-2096	750(61x)	1.39	1.49	15 x 10	1.87	2152	2402	555	470	600	510		
162-23-2099	1000(61x)	1.54	1.68	18 x *(B)	2.06	2711	3059	645	550	685	585		

* - Special Conductor Size (A) Wire O.D. =0.1066"

** Stocked as unfilled strand as 161-23-2072, see Sec 2, Sheet 35.

(1) Individual wire size and count may vary. The resulting combination meets the 1/3 or full neutral, size requirement.

Visit Okonite's web site www.okonite.com for the most up to date dimensions.

Ampacities

(2) Full neutral, single phase ampacities are based on 90°C or 105°C conductor temperature, 20°C ambient temperature, 100% load factor, and earth thermal resistivity of RHO 90. One third neutral ampacities are based on ICEA P-53-426 triplexed or triangular configuration for the same conditions stated above.

Okoguard URO-J

15kV Underground Primary Distribution Cable-Jacketed
 Red Identification Stripes
 Filled Strand Aluminum Conductor/105°C Rating
 133% Insulation Level

Product Data Section 2: Sheet 36

Okoguard Insulation: 220 mils 133% Insulation Level

Catalog Number	Conductor Size AWG/kcmil	Nominal Dia. over Insulation (in.)	Nominal Dia. over Insulation Screen (in.)	Copper Neutral, No. x AWG (1)	Nominal O.D. (in.)	Aprox. Net Weight lbs./1000'	Aprox. Ship Weight lbs./1000'	90° Ampacity Direct Burial (2)	90° Ampacity Duct (2)	105° Ampacity Direct Burial (2)	105° Ampacity Duct (2)
FULL NEUTRAL											
▲ 163-23-3060	2(7x)	0.77	0.85	10 x 14	1.08	602	669	165	120	180	130
163-23-3066	1(19x)	0.82	0.90	13 x 14	1.14	694	766	185	135	205	150
▲ 163-23-3072	1/0(19x)	0.84	0.92	16 x 14	1.15	753	820	210	155	235	170
163-23-3075	2/0(19x)	0.91	0.98	13 x 12	1.25	916	996	240	175	270	200
163-23-3078	3/0(19x)	0.96	1.04	16 x 12	1.31	1045	1125	270	200	305	225
163-23-3081	4/0(19x)	1.02	1.09	13 x 10	1.41	1252	1347	310	230	350	260
163-23-3084	250(37x)	1.07	1.17	16 x 10	1.48	1456	1606	340	255	385	285
163-23-3090	350(37x)	1.18	1.28	20 x 10	1.59	1762	1912	405	300	455	340
1/3 NEUTRAL											
162-23-3060	2(7x)	0.78	0.85	6 x 14	1.09	562	627	155	135	165	130
162-23-3066	1(19x)	0.82	0.90	6 x 14	1.14	612	684	175	155	190	150
162-23-3072	1/0(19x)	0.86	0.94	6 x 14	1.18	661	733	200	175	215	175
162-23-3075	2/0(19x)	0.91	0.98	7 x 14	1.22	730	810	230	200	245	195
162-23-3078	3/0(19x)	0.96	1.04	9 x 14	1.27	825	905	260	230	280	225
▲ 162-23-3081	4/0(19x)	0.99	1.06	11 x 14	1.30	891	1005	290	240	315	255
162-23-3084	250(37x)	1.07	1.17	13 x 14	1.41	1069	1164	320	260	345	280
▲ 162-23-3090	350(37x)	1.16	1.26	18 x 14	1.50	1254	1425	380	320	415	345
▲ 162-23-3093	500(37x)	1.29	1.39	16 x 12	1.72	1666	1853	455	385	495	415
▲ 162-23-3096	750(61x)	1.48	1.58	15 x 10	1.95	2244	2468	555	470	600	510
▲ 162-23-3099	1000(61x)	1.63	1.77	18 x *(A)	2.15	2808	3093	645	550	685	585

* - Special Conductor Size (A) Wire O.D. = 0.1066"

(1) Individual wire size and count may vary. The resulting combination meets the 1/3 or full neutral, size requirement.

Visit Okonite's web site www.okonite.com for the most up to date dimensions.

▲ **Authorized Stock Item** - Available from Customer Service centers.

Ampacities

(2) Full neutral, single phase ampacities are based on ICEA's S-94-649, Appendix F for 90°C conductor temperature, 20°C ambient temperature, 100% load factor, and earth thermal resistivity of RHO 90 and modified for jacketed cable.

One third neutral ampacities are based on ICEA P-53-426 triplexed or triangular configuration for the same conditions stated above.



Okoguard® URO-J

25kV Underground Primary Distribution Cable-Jacketed Red Identification Stripes

Aluminum Conductor/105°C Rating
100% and 133% Insulation Levels



- A Conductor-Stranded Aluminum
- B Strand Screen-
Extruded Semiconducting EPR
- C Insulation-Okoguard EPR
- D Insulation Screen-
Extruded Semiconducting EPR
- E Concentric Conductor-Bare
Copper Wires
- F Encapsulating Jacket-Okolene with
three extruded red ID stripe, and
NESC lightning bolt

Insulation

Okoguard is Okonite's registered trade name for its exclusive ethylene-propylene rubber (EPR) based, thermosetting compound, whose optimum balance of electrical and physical properties is unequalled in other solid dielectrics. Okoguard insulation, with the distinctive red color and a totally integrated EPR system, provides the optimum balance of electrical and physical properties for long, problem free service.

The triple tandem extrusion of the screens with the insulation provides optimum electrical characteristics.

An insulation screen of ethylene-propylene rubber is extruded over the insulation. The bare copper concentric wires are uniformly spaced around the insulation screen. The overall polyethylene jacket provides protection against mechanical damage and corrosion.

Product identification is provided through the use of three red stripes placed 120° apart in the black jacket with an NESC lightning bolt.

Applications

Okoguard URO-J cables provide maximum circuit longevity in underground residential distribution systems. They can be buried directly or installed in underground ducts or conduits.

Specifications

Central Conductor: Aluminum per ASTM B-609, Class B stranded per B-231.

Conductor Screen: Extruded semiconducting ethylene-propylene rubber meets or exceeds the requirements of ICEA S-94-649 and AEIC CS8.

Insulation: Extruded Okoguard meets or exceeds the requirements of ICEA S-94-649 and AEIC CS8.

Insulation Screen: Extruded semiconducting ethylene-propylene rubber meets or exceeds the requirements of ICEA S-94-649 and AEIC CS8.

Concentric Conductor: Bare copper wires.

Jacket: Black Okolene® with red extruded stripes, meets or exceeds the requirements of ICEA S-94-649 for polyethylene jackets.

Product Features

- Triple tandem extruded, all EPR system.
- Okoguard cables meet or exceed ICEA and RUS 7CFR 1728.204 standards.
- 105°C continuous operating temperature
- 140°C emergency rating
- 250°C short circuit rating
- Excellent corona resistance.
- Low dielectric constant and power factor.
- Screens are clean stripping.
- Exceptional resistance to “treeing”.
- Moisture resistant.
- Overall jacket provides extended life.
- Red extruded stripes
- Excellent resistance to most chemicals.
- Can be UL Listed as MV90 for use in accordance with Art 328 of the NEC on special orders.
- Can be CSA Listed to C68.5 on special orders.
- Design Options:
 - Additional conductor sizes
 - Filled strand
 - Copper central conductor
 - Copper flat strap concentric neutral
 - Product identification via colored jackets
 - Semiconducting jackets
- Improved Temperature Rating.
Okoguard insulation system has been tested and qualified for operation at 105°C continuous and 140°C emergency operating temperature.
- Minimum installation temperature of -40°C.

Okoguard URO-J

25kV Underground Primary Distribution Cable-Jacketed

Red Identification Stripes

Aluminum Conductor/105°C Rating

100% Insulation Levels

Product Data

Section 2: Sheet 39

Okoguard Insulation: 260 mils 100% Insulation Level

Catalog Number	Conductor Size AWG/kcmil	Nominal Dia. over Insulation (in.)	Nominal Dia. over Insulation Screen (in.)	Copper Neutral No. x AWG (1)	Nominal O.D. (in.)	Aprox. Net Weight lbs./1000'	Aprox. Ship Weight lbs./1000'	90° Ampacity Direct Burial (2)	90° Ampacity Duct (2)	105° Ampacity Direct Burial (2)	105° Ampacity Duct (2)
FULL NEUTRAL											
161-23-4066	1 (19x)	0.90	0.97	13 x 14	1.21	772	872	185	135	205	150
▲ 161-23-4069	1/0 (1x)	0.89	0.97	16 x 14	1.20	803	870	210	150	235	170
161-23-4072	1/0 (19x)	0.92	1.00	16 x 14	1.23	832	898	210	150	235	170
▲ 163-23-4072*	1/0 (19x)	0.92	1.00	16 x 14	1.23	833	899	210	150	235	170
161-23-4075	2/0 (19x)	0.98	1.05	13 x 12	1.33	1001	1117	240	175	270	200
161-23-4078	3/0 (19x)	1.03	1.13	16 x 12	1.40	1157	1273	270	200	305	225
161-23-4081	4/0 (19x)	1.09	1.19	13 x 10	1.50	1372	1550	305	225	345	260
161-23-4084	250 (37x)	1.14	1.24	16 x 10	1.56	1546	1724	335	250	380	285
161-23-4090	350 (37x)	1.25	1.35	20 x 10	1.73	1916	2166	405	300	450	345

1/3 NEUTRAL											
160-23-4066	1 (19x)	0.90	0.97	6 x 14	1.21	691	791	175	155	190	150
160-23-4072	1/0 (19x)	0.94	1.01	6 x 14	1.25	741	841	200	175	215	175
160-23-4075	2/0 (19x)	0.98	1.05	7 x 14	1.29	812	912	230	200	245	200
160-23-4078	3/0 (19x)	1.03	1.13	9 x 14	1.37	935	1051	260	230	280	230
160-23-4081	4/0 (19x)	1.07	1.17	11 x 14	1.40	1010	1128	290	245	315	260
▲ 162-23-4081*	4/0 (19x)	1.07	1.17	11 x 14	1.40	1011	1129	290	245	315	260
160-23-4084	250 (37x)	1.14	1.24	13 x 14	1.48	1152	1330	315	265	340	285
160-23-4090	350 (37x)	1.25	1.35	18 x 14	1.59	1388	1566	375	325	410	350
160-23-4093	500 (37x)	1.37	1.47	16 x 12	1.80	1782	1986	450	390	495	415
▲ 162-23-4093*	500 (37x)	1.37	1.47	16 x 12	1.80	1784	1988	450	390	495	415
160-23-4096	750 (61x)	1.56	1.70	15 x 10	2.06	2450	2754	550	480	600	515
▲ 162-23-4096*	750 (61x)	1.56	1.70	15 x 10	2.08	2450	2754	550	480	600	515
160-23-4099	1000 (61x)	1.71	1.85	18 x **(A)	2.23	3027	3533	640	565	680	585
▲ 162-23-4099*	1000 (61x)	1.71	1.85	18 x **(A)	2.23	3024	3535	640	565	680	585

* These items include filled strand

** Special Conductor Size, (A) Wire O.D. =0.1066"

(1) Individual wire size and count may vary. The resulting combination meets the 1/3 or full neutral, size requirement.

Visit Okonite's web site www.okonite.com for the most up to date dimensions.

▲ Authorized Stock Item - Available from Customer Service centers.

Ampacities

(2) Full neutral, single phase ampacities are based on 90°C or 105°C conductor temperature, 20°C ambient temperature, 100% load factor, and earth thermal resistivity of RHO 90.

One third neutral ampacities are based on ICEA P-53-426 triplexed or triangular configuration for the same conditions stated above.

Okoguard URO-J

25kV Underground Primary Distribution Cable-Jacketed

Red Identification Stripes

Aluminum Conductor/105°C Rating

133% Insulation Levels

Product Data Section 2: Sheet 39

Okoguard Insulation: 320 mils 133% Insulation Level

Catalog Number	Conductor Size AWG/komil	Number of Strands	Nominal Dia. over Insulation (in.)	Nominal Dia. over Insulation Screen (in.)	Copper Neutral No. x AWG (1)	Nominal O.D. (in.)	Approx. Net Weight lbs./1000'	Approx. Ship Weight lbs./1000'	90° Ampacity Direct Burial (2)	90° Ampacity Duct (2)	105° Ampacity Direct Burial (2)	105° Ampacity Duct (2)
FULL NEUTRAL												
161-23-5066	1 (19x)	1.02	1.12	13 x 14	1.36	931	1047	185	135	205	150	
161-23-5072	1/0 (19x)	1.06	1.16	16 x 14	1.40	1022	1138	210	150	235	170	
161-23-5075	2/0 (19x)	1.10	1.20	13 x 12	1.47	1175	1353	240	175	270	200	
161-23-5078	3/0 (19x)	1.15	1.25	16 x 12	1.52	1308	2503	270	200	305	225	
161-23-5081	4/0 (19x)	1.21	1.31	13 x 10	1.69	1600	1819	305	225	345	260	
161-23-5084	250 (37x)	1.27	1.37	16 x 10	1.74	1782	2032	335	250	380	285	
161-23-5090	350 (37x)	1.37	1.47	20 x 10	1.85	2099	2349	405	300	450	345	
1/3 NEUTRAL												
160-23-5066	1 (19x)	1.02	1.12	6 x 14	1.36	850	966	175	155	190	150	
160-23-5072	1/0 (19x)	1.06	1.16	6 x 14	1.40	906	1022	200	175	215	175	
160-23-5075	2/0 (19x)	1.10	1.20	7 x 14	1.44	983	1099	230	200	245	200	
160-23-5078	3/0 (19x)	1.15	1.25	9 x 14	1.49	1083	1261	260	230	280	230	
160-23-5081	4/0 (19x)	1.21	1.31	11 x 14	1.55	1200	1378	290	245	315	260	
160-23-5084	250 (37x)	1.27	1.37	13 x 14	1.60	1312	1490	315	265	340	285	
160-23-5090	350 (37x)	1.37	1.47	18 x 14	1.77	1631	1881	375	325	410	350	
160-23-5093	500 (37x)	1.50	1.60	16 x 12	1.93	2025	2275	450	390	495	415	
160-23-5096	750 (61x)	1.69	1.83	15 x 10	2.20	2722	3122	550	480	600	515	
160-23-5099	1000 (61x)	1.84	1.98	18 x ** (A)	2.35	3265	3771	640	565	680	585	

(1) Individual wire size and count may vary. The resulting combination meets the 1/3 or full neutral, size requirement.

** Special Conductor Size, (A) Wire O.D. = 0.1066"

Visit Okonite's web site www.okonite.com for the most up to date dimensions.

Ampacities

(2) Full neutral, single phase ampacities are based on 90°C or 105°C conductor temperature, 20°C ambient temperature, 100% load factor, and earth thermal resistivity of RHO 90.

One third neutral ampacities are based on ICEA P-53-426 triplexed or triangular configuration for the same conditions stated above.



Okoguard® URO-J

35kV Underground Primary Distribution Cable-Jacketed Red Identification Stripes

Aluminum Conductor/105°C Rating
100% and 133% Insulation Levels



- A Conductor-Stranded Aluminum
- B Strand Screen- Extruded Semiconducting EPR
- C Insulation-Okoguard EPR
- D Insulation Screen- Extruded Semiconducting EPR
- E Concentric Conductor-Bare Copper Wires
- F Encapsulating Jacket-Okolene with three extruded red ID stripes and NESC lightning bolt

Insulation

Okoguard is Okonite's registered trade name for its exclusive ethylene-propylene rubber (EPR) based, thermosetting compound, whose optimum balance of electrical and physical properties is unequalled in other solid dielectrics. Okoguard insulation, with the distinctive red color and a totally integrated EPR system, provides the optimum balance of electrical and physical properties for long, problem free service.

The triple tandem extrusion of the screens with the insulation provides optimum electrical characteristics.

An insulation screen of ethylene-propylene rubber is extruded over the insulation. The bare copper concentric wires are uniformly spaced around the insulation screen. The overall polyethylene jacket provides protection against mechanical damage and corrosion.

Product identification is provided through the use of three red stripes placed 120° apart in the black jacket, with an NESC lightning bolt.

Applications

Okoguard URO-J cables provide maximum circuit longevity in underground residential distribution systems. They can be buried directly or installed in underground ducts or conduits.

Specifications

Central Conductor: Aluminum per ASTM B-609, Class B stranded per B-231.

Conductor Screen: Extruded semiconducting ethylene-propylene rubber meets or exceeds the requirements of ICEA S-94-649 and AEIC CS8.

Insulation: Extruded Okoguard meets or exceeds the requirements of ICEA S-94-649 and AEIC CS8.

Insulation Screen: Extruded semiconducting ethylene-propylene rubber meets or exceeds the requirements of ICEA S-94-649 and AEIC CS8.

Concentric Conductor: Bare copper wires.

Jacket: Black Okolene with red extruded stripes meets or exceeds the requirements of ICEA S-94-649 for polyethylene jackets.

Product Features

- Triple tandem extruded, all EPR system.
 - Okoguard cables meet or exceed ICEA and RUS 7CFR 1728.204 standards.
 - 105°C continuous operating temperature
 - 140°C emergency rating
 - 250°C short circuit rating
 - Excellent corona resistance.
 - Low dielectric constant and power factor.
 - Screens are clean stripping.
 - Exceptional resistance to “treeing”.
 - Moisture resistant.
 - Overall jacket provides extended life.
 - Excellent resistance to most chemicals.
 - Can be UL listed to MV90 for use in accordance with Article 328 of the NEC on special orders.
 - Can be CSA listed to C68.5 on special orders
 - Design Options:
 - Additional conductor sizes
 - Filled strand
 - Copper central conductor
 - Copper flat strap concentric neutral
 - Product identification via colored jackets
 - Semiconducting jackets
 - Improved Temperature Rating.
- Okoguard insulation system has been tested and qualified for operation at 105°C continuous and 140°C emergency operating temperature. Appropriate jacket should be selected when cable is to be operated at these higher temperatures.
- Minimum installation temperature of -40°C.

Okoguard URO-J

35kV Underground Primary Distribution Cable-Jacketed

Red Identification Stripes

Aluminum Conductor/105°C Rating

100% Insulation Level

Product Data Section 2: Sheet 40

Okoguard Insulation: 345 mils 100% Insulation Level

Catalog Number	Conductor Size AWG/kcmil	Nominal Dia. Over Insulation	Nominal Dia. Over Insulation Screen	Copper Neutral Number x AWG (1)	Nominal O.D. (In.)	Approx. Net Weight lbs./1000'	Approx. Ship Weight lbs./1000'	90°C Ampacity (2) Direct Burial	90°C Ampacity (2) Duct	105°C Ampacity (2) Direct Burial	105°C Ampacity (2) Duct
FULL NEUTRAL											
▲ 161-23-6072	1/0 (19x)	1.10	1.20	16 x 14	1.44	1061	1179	210	150	235	170
▲ 163-23-6072*	1/0 (19x)	1.10	1.20	16 x 14	1.44	1063	1181	210	150	235	170
161-23-6075	2/0 (19x)	1.15	1.25	13 x 12	1.52	1238	1416	240	175	270	200
161-23-6078	3/0 (19x)	1.20	1.30	16 x 12	1.57	1374	1552	270	200	305	225
161-23-6081	4/0 (19x)	1.26	1.36	13 x 10	1.74	1671	1921	305	225	345	260
161-23-6084	250 (37x)	1.32	1.42	16 x 10	1.79	1856	2106	335	250	380	285
161-23-6090	350 (37x)	1.42	1.52	20 x 10	1.90	2177	2525	405	300	450	345

1/3 NEUTRAL

160-23-6072	1/0 (19x)	1.11	1.21	6 x 14	1.45	966	1082	200	175	215	175
160-23-6075	2/0 (19x)	1.15	1.25	7 x 14	1.49	1045	1223	230	200	245	200
160-23-6078	3/0 (19x)	1.20	1.30	9 x 14	1.54	1148	1326	260	230	280	230
160-23-6081	4/0 (19x)	1.26	1.36	11 x 14	1.60	1267	1445	290	245	315	260
160-23-6084	250 (37x)	1.32	1.42	13 x 14	1.72	1451	1701	315	265	340	285
160-23-6090	350 (37x)	1.42	1.52	18 x 14	1.82	1707	1957	375	325	410	350
160-23-6093	500 (37x)	1.55	1.68	16 x 12	2.02	2167	2515	450	390	495	415
160-23-6096	750 (61x)	1.74	1.88	15 x 10	2.25	2817	3323	550	480	600	515
160-23-6099	1000 (61x)	1.89	2.03	18 x **(A)	2.40	3366	3872	640	565	680	585

* These items include filled strand.

** Special Conductor Size, (A) wire OD=0.1066"

Visit Okonite's web site www.okonite.com for the most up to date dimensions.

▲ **Authorized Stock Item** - Available from Customer Service centers.

(1) Individual wire size and count may vary. The resulting combination meets the 1/3 or full neutral, size requirement.

Ampacities

(2) Full neutral, single phase ampacities are based on 90°C or 105°C conductor temperature, 20°C ambient temperature, 100% load factor, and earth thermal resistivity of RHO 90.

One third neutral ampacities are based on ICEA P-53-426 triplexed or triangular configuration for the same conditions stated above.

Okoguard URO-J

35kV Underground Primary Distribution Cable-Jacketed

Red Identification Stripes

Aluminum Conductor/105°C Rating

133% Insulation Level

Product Data Section 2: Sheet 40

Okoguard Insulation: 420 mils 133% Insulation Level

Catalog Number	Conductor Size AWG/kcmil	Number of Strands	Nominal Dia. Over Insulation	Nominal Dia. Over Insulation Screen	Copper Neutral Number x AWG (1)	Nominal O.D. (In.)	Approx. Net Weight lbs./1000'	Approx. Ship Weight lbs./1000'	90°C Ampacity (2) Direct Burial	90°C Ampacity Duct (2)	105°C Ampacity (2) Direct Burial	105°C Ampacity Duct (2)
FULL NEUTRAL												
161-23-7072	1/0 (19x)	1.26	1.36	16 x 14	1.60	1285	1463	205	150	230	175	
161-23-7075	2/0 (19x)	1.31	1.41	13 x 12	1.74	1520	1770	235	170	265	200	
161-23-7078	3/0 (19x)	1.36	1.46	16 x 12	1.79	1666	1916	265	200	300	230	
161-23-7081	4/0 (19x)	1.42	1.52	13 x 10	1.89	1909	2159	305	225	340	260	
161-23-7084	250 (37x)	1.47	1.57	16 x 10	1.95	2102	2352	335	245	375	290	
161-23-7090	350 (37x)	1.58	1.71	20 x 10	2.09	2498	2846	400	295	445	350	
1/3 NEUTRAL												
160-23-7072	1/0 (19x)	1.26	1.36	6 x 14	1.60	1169	1347	200	175	210	175	
160-23-7075	2/0 (19x)	1.31	1.41	8 x 14	1.71	1323	1573	225	200	240	205	
160-23-7078	3/0 (19x)	1.36	1.46	9 x 14	1.76	1434	1684	255	230	275	235	
160-23-7081	4/0 (19x)	1.42	1.52	11 x 14	1.82	1564	1814	280	245	310	265	
160-23-7084	250 (37x)	1.47	1.57	13 x 14	1.87	1689	1939	315	265	340	290	
160-23-7090	350 (37x)	1.58	1.71	18 x 14	2.01	2019	2367	375	325	405	350	
160-23-7093	500 (37x)	1.70	1.84	16 x 12	2.18	2446	2846	450	390	490	420	
160-23-7096	750 (61x)	1.90	2.03	15 x 10	2.41	3126	3632	550	480	595	515	
160-23-7099	1000 (61x)	2.05	2.18	18 x **(A)	2.56	3696	4202	640	565	680	600	

** Special Conductor Size, (A) wire OD-0.1066"

Visit Okonite's web site www.okonite.com for the most up to date dimensions.

(1) Individual wire size and count may vary. The resulting combination meets the 1/3 or full neutral, size requirement.

Ampacities

(2) Full neutral, single phase ampacities are based on 90°C or 105°C conductor temperature, 20°C ambient temperature, 100% load factor, and earth thermal resistivity of RHO 90.

One third neutral ampacities are based on ICEA P-53-426 triplexed or triangular configuration for the same conditions stated above.



Okoguard-Okolon[®] TS-CPE Type RHH or RHW-2 or USE-2, VW-1, FT-4, CSA RW-90

600V Power and Control

Copper Conductor/90°C Wet or Dry

For Cable Tray Use-Sunlight Resistant-For Direct Burial



A Uncoated, Copper Conductor
B Composite Okoguard/Okolon
TS-CPE Insulation

Composite Insulation

Okoguard-Okolon TS-CPE is Okonite's trade name for its composite insulation system consisting of a layer of EPR and covered with a chlorinated polyethylene (CPE) thermoset compound.

The advantages of Okoguard EPR, with a proven track record of over 40 years as a medium voltage insulation, are now offered in low voltage cables. Okolon TS-CPE is Okonite's trade name for its chlorinated polyethylene (CPE) thermoset compound.

Applications

Okoguard-Okolon TS-CPE 600 Volt Power and Control Cables are recommended for use in all low voltage circuits where continuity of service is the prime consideration. These cables may be installed in wet or dry locations, indoors or outdoors, in raceways, underground ducts, directly buried in the earth, or lashed to a messenger for aerial installation. These cables may also be installed in cable tray (size 1/0 AWG and larger per NEC 392.2).

Specifications

Conductor: Uncoated soft copper per ASTM B-3. Solid per ASTM B-3. Sizes smaller than #8 are compact stranded per ASTM B-8. Sizes #8 and larger are compact stranded per ASTM B-496.

Insulation: Meets or exceeds all requirements of ICEA S-95-658, NEMA WC-70 and UL Standards 44 and 854.

Listed by Underwriters Laboratories, Inc. as Type RHH or RHW-2 or USE-2, VW-1. Sizes 1/0 AWG and larger are also marked sunlight resistant, for use in cable tray.

Listed by CSA as RW-90, -40C, FT1 (1/0 and larger: FT4), sunlight resistant.

Product Features

- Sizes 1/0 AWG and larger pass the Vertical Tray Flame Test requirements of UL 1581 for use in cable tray.
- Passes the IEEE 383-1974 Vertical Tray Flame Test. (sizes #6 AWG and larger)
- Passes the IEEE 1202 Vertical Tray Flame Test. (sizes 1/0 AWG & larger)
- Extreme heat resistance; 90°C continuous rating, wet or dry 130°C emergency overload rating 250°C short circuit rating
- Exceptional resistance to deformation at high temperature.
- Stable electrical properties.
- Low SIC and power factor.
- Low moisture absorption.
- Mechanically rugged.
- Resistant to weather, most oils, acids and alkalis.
- More flexible, easier to install and terminate than XLPE insulation.
- UL and CSA Listed.

Conductor (AWG/kcmil)	Composite Insulation Thickness (mils)	
	Okoguard	Okolon TS-CPE
14-9	30	15
8	45	15
6-2	45	30
1-4/0	55	45
250-500	65	65
750-1000	80	65

Okoguard-Okolon TS-CPE Type RHH or RHW-2 or USE-2, VW-1, FT-4, CSA RW-90

600V Power and Control

Copper Conductor/90°C Wet or Dry

For Cable Tray Use - Sunlight Resistant - For Direct Burial

Product Data Section 3: Sheet 1



Catalog Number	Conductor Size AWG kcmil		Number of Strands	Composite Insulation Thickness - mils		Approx. O.D. - Inches	Approx. O.D. -mm		Approx. Net Weight lbs./1000'		Approx. Ship Weight lbs./1000'		90°C Wet (1)	75°C Wet (1)	ICEA Ampacity (2)
112-24-2061	14	1	45	1.14	0.16	4.06	23	28	15	15	24				
▲ 112-24-2071	14	7	45	1.14	0.17	4.57	25	30	15	15	24				
112-24-2091	12	1	45	1.14	0.18	4.57	32	37	20	20	30				
▲ 112-24-2101	12	7	45	1.14	0.19	4.83	34	39	20	20	30				
112-24-2121	10	1	45	1.14	0.20	5.08	46	51	30	30	42				
▲ 112-24-2131	10	7	45	1.14	0.21	5.33	49	54	30	30	42				
112-24-2171	9	19	45	1.14	0.23	5.84	58	63	30	30	48				
▲ 112-24-2191	8	7	60	1.52	0.27	6.86	75	82	55	50	55				
▲ 112-24-2221	6	7	75	1.91	0.33	8.38	119	130	75	65	75				
▲ 112-24-2251	4	7	75	1.91	0.38	9.75	173	184	95	85	97				
▲ 112-24-2311	2	7	75	1.91	0.43	11.00	257	280	130	115	130				
112-24-2331	1	19	100	2.54	0.52	13.16	340	372	150	130	156				
▲ 112-24-2351	1/0	19	100	2.54	0.56	14.10	414	446	170	150	179				
▲ 112-24-2371	2/0	19	100	2.54	0.60	15.14	507	539	195	175	204				
112-24-2391	3/0	19	100	2.54	0.64	16.33	622	654	225	200	242				
▲ 112-24-2411	4/0	19	100	2.54	0.70	17.68	766	805	260	230	278				
▲ 112-24-2431	250	37	130	3.30	0.80	20.32	938	993	290	255	317				
▲ 112-24-2471	350	37	130	3.30	0.89	22.61	1265	1320	350	310	384				
▲ 112-24-2531	500	37	130	3.30	1.01	25.65	1750	1827	430	380	477				
▲ 112-24-2591	750	61	145	3.68	1.21	30.73	2590	2690	535	475	598				
▲ 112-24-2651	1000	61	145	3.68	1.36	34.54	3391	3568	615	545	689				

Visit Okonite's web site, www.okonite.com, for the most up to date dimensions.

▲ **Authorized stock item.** Available from our Customer Service Centers.

(1) **Ampacities** are based on Table 310.16 of the National Electrical Code for these 90°C rated conductors at an ambient temperature of 30°C. The 75°C wet column is provided for additional information.

The ampacities shown apply to open runs of cable, installation in any approved raceway, direct burial in the earth, or as aerial cable on a messenger. Derating for more than three current carrying conductors within a raceway is in accordance with NEC Section 310.15.B.2.

(2) Based on three (3) conductors in a single enclosed or exposed conduit. Capacities based on 40°C air ambient using ICEA methods. For 30°C ambient multiply values by 1.10; for 50°C multiply by .90. For other ambients or installation conditions refer to Engineering Data Book EHB.

For ampacities in cable tray, see NEC Section 392.11.B.

To order a color other than black, change the last digit of the catalog number as follows:			
White	2	Orange	5
Red	3	Blue	6
Green	4	Yellow	7
Example: To order #14/Sol - Red, the catalog number would be 112-24-2063.			



Okoguard-Okolon® TS-CPE Type RHH or RHW-2, VW-1, FT-4

2kV Power Cable

Copper Conductors/90°C Wet or Dry
For Cable Tray Use - Sunlight Resistant



A Uncoated Copper Conductor
B Composite Okoguard—Okolon
TS-CPE Insulation

Composite Insulation

Okoguard-Okolon® TS-CPE is Okonite's trade name for its composite insulation system consisting of a layer of EPR and covered with a chlorinated polyethylene (CPE) thermoset compound. The combination of the two materials provides a dielectric which has excellent resistance to heat, mechanical abuse, flame, weathering, most oils, acids and alkalies.

The advantages of Okoguard EPR, with a proven track record of over 40 years as a medium voltage insulation, are now offered in low voltage cables. Okolon TS-CPE is Okonite's trade name for its chlorinated polyethylene (CPE) thermoset compound.

Applications

Okoguard-Okolon TS-CPE 2000 volt power cables are recommended for use in all low voltage circuits where continuity of service is the prime consideration. They can be installed in wet or dry locations, indoors or outdoors in conduit, underground ducts, approved raceways. These cables may also be installed in cable tray (size 1/0 AWG kcmil and larger per NEC 392.3).

Specifications

Conductors: Uncoated soft copper per ASTM B-3. Solid per ASTM B-3. Sizes smaller than #8 are compress stranded per ASTM B-8. Sizes #8 and larger are compact stranded per ASTM B-496.

Composite Insulation: Meets or exceeds all requirements of ICEA S-95-658, NEMA WC-70 and UL Standard 44.

Listed by Underwriters Laboratories, Inc. as Type RHH or RHW-2, VW-1. Sizes 1/0 AWG and larger are also marked sunlight resistant, for use in cable tray. All sizes meet FT-1. Sizes 1/0 and larger meet FT-4.

Product Features

- Sizes 1/0 AWG and larger pass the Vertical Tray Flame Test requirements of UL 1581 for use in cable tray.
- Passes the IEEE 383-1974 Vertical Tray Flame Test (size #8 AWG and larger).
- Passes the IEEE 1202 Vertical Tray Flame Test (sizes 1/0 AWG and larger).
- Extreme heat resistance
90°C continuous rating, wet or dry
130°C emergency overload rating
250°C short circuit rating
- Exceptional resistance to deformation at high temperature.
- Stable electrical properties.
- Low SIC and power factor.
- Low moisture absorption.
- Mechanically rugged.
- Resistant to weather, most oils, acids and alkalies.
- Smaller diameter than RHW jacketed cables.
- More flexible, easier to install, terminate or splice than XLPE insulation.
- UL Listed.
- OSHA acceptable.
- UL E1138.
- FT-1 all sizes.
- FT-4 - 1/0 and larger.

Composite Insulation Thickness (mils)		
Conductor (AWG/kcmil)	Okoguard	Okolon TS-CPE
14-10	45	15
9	55	15
8-2	55	30
1-4/0	65	45
250-500	75	65
750-1000	90	65

Okoguard-Okolon TS-CPE Type RHH or RHW-2, VW-1, FT-4 2kV Power Cable



Product Data Section 3: Sheet 10

Copper Conductor/90°C Wet or Dry
For Cable Tray Use - Sunlight Resistant

Catalog Number	Conductor Size AWG or kcmil		Number of Strands	Composite Insulation Thickness - mils	Composite Insulation Thickness - mm	Approx. O.D. - Inches	Approx. O.D. - mm	Approx. Net Weight lbs./1000'	Approx. Ship Weight lbs./1000'	90°C Wet (1) NEC Ampacity	75°C Wet (1) NEC Ampacity	ICEA Ampacity (2)
113-24-2061	14	1	60	1.52	0.19	4.83	28	33	15	15	24	
▲ 113-24-2071	14	7	60	1.52	0.20	5.08	30	35	15	15	24	
113-24-2091	12	1	60	1.52	0.21	5.33	38	43	20	20	30	
▲ 113-24-2101	12	7	60	1.52	0.22	5.59	40	45	20	20	30	
113-24-2121	10	1	60	1.52	0.23	5.84	52	57	30	30	42	
▲ 113-24-2131	10	7	60	1.52	0.24	6.10	55	60	30	30	42	
113-24-2171	9	19	70	1.79	0.28	7.11	70	75	30	30	48	
▲ 113-24-2191	8	7	85	2.16	0.32	8.13	90	101	55	50	55	
▲ 113-24-2221	6	7	85	2.16	0.35	8.89	126	137	75	65	75	
▲ 113-24-2251	4	7	85	2.16	0.40	10.26	180	191	95	85	97	
▲ 113-24-2311	2	7	85	2.16	0.45	11.43	265	278	130	115	130	
113-24-2331	1	19	110	2.79	0.54	13.72	348	367	150	130	156	
▲ 113-24-2351	1/0	19	110	2.79	0.57	14.48	424	442	170	150	179	
▲ 113-24-2371	2/0	19	110	2.79	0.61	15.49	517	537	195	175	204	
113-24-2391	3/0	19	110	2.79	0.66	16.76	633	657	225	200	242	
▲ 113-24-2411	4/0	19	110	2.79	0.71	18.03	777	813	260	230	278	
▲ 113-24-2431	250	37	140	3.56	0.83	21.08	957	1004	290	255	317	
▲ 113-24-2471	350	37	140	3.56	0.92	23.37	1286	1355	350	310	384	
▲ 113-24-2531	500	37	140	3.56	1.04	26.42	1773	1915	430	380	477	
▲ 113-24-2591	750	61	155	3.94	1.24	31.50	2618	2805	535	475	598	
113-24-2651	1000	61	155	3.94	1.38	35.05	3423	3674	615	545	689	

Visit Okonite's web site, www.okonite.com, for the most up to date dimensions.

▲ **Authorized stock item.** Available from our Customer Service Centers.

To order a color other than black, change the last digit of the catalog number as follows:			
White	2	Orange	5
Red	3	Blue	6
Green	4	Yellow	7
Example: To order #14 - Red, the catalog number would be 113-24-2073.			

Ampacities

(1) Ampacities are based on Table 310.15(B)(16) of the National Electrical Code for these 90°C rated conductors at an ambient temperature of 30°C. The 75°C wet column is provided for additional information.

The ampacities shown apply to open runs of cable, installation in any approved raceway, direct burial in the earth, or as aerial cable on a messenger. Derating for more than three current carrying conductors within a raceway is in accordance with NEC 310.15(B)(3).

(2) Based on three (3) conductors in a single enclosed or exposed conduit. Capacities based on 40°C air ambient using ICEA method. For 30°C ambient multiply values by 110; for 50°C multiply by 90. For other ambients or installation conditions refer to Okonite's Engineering Data Book EHB.

For ampacities in cable tray see NEC Section 392.80.



C-L-X[®] Type MC-HL (XHHW-2) 600V Power MC-HL Cable—Aluminum Sheath 600/1000V Marine Cable

Multiple Copper Conductors/90°C Wet or Dry Rating
For Cable Tray Use - Sunlight Resistant - For Direct Burial

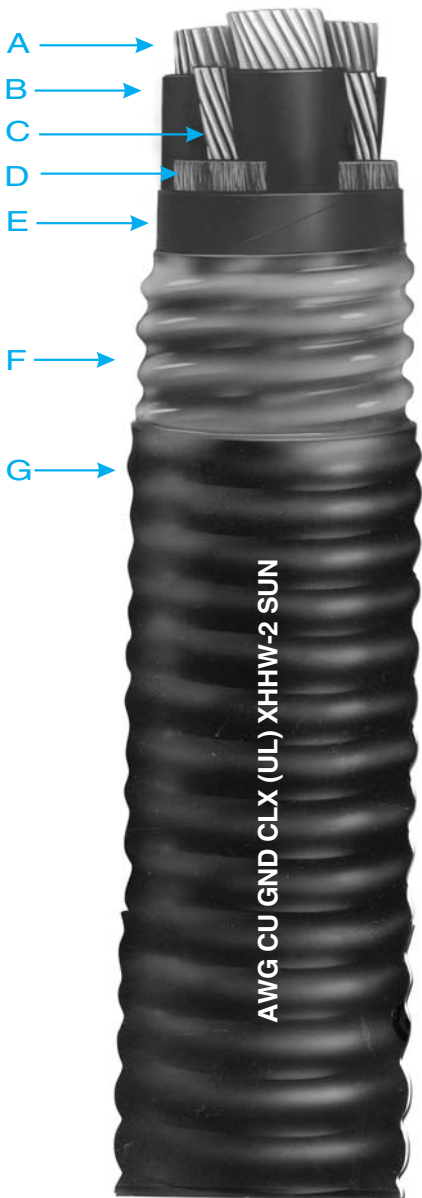

- A Bare, Stranded Copper Conductors
- B X-Olene Insulation —Color Coded for Identification
- C Bare, Stranded Copper Grounding Conductor(s)
- D Non-Hygroscopic Fillers, as necessary
- E Binder Tape
- F Impervious, Continuous, Welded Corrugated, Aluminum C-L-X Sheath
- G Black Okoseal Jacket

Insulation

X-Olene[®] is Okonite's trade name for its chemically cross-linked polyethylene, with high dielectric strength.

Color Coding

Conductors 6 AWG and smaller are color coded using base colors and tracers in accordance with the Conductor Identification Table on the back of this Data Sheet. Sizes 4 AWG and larger are printed number/color coded.

Assembly and Coverings

The individual conductors are cabled together with non-hygroscopic fillers and a binder tape overall. The C-L-X sheath exceeds the grounding conductor requirements of Table 250.122 of the NEC and UL 1569. A bare stranded copper grounding conductor(s), located in the outer interstices, is provided for grounding. The impervious, continuous, welded, corrugated aluminum C-L-X sheath provides complete protection against moisture, liquids and gases and has excellent mechanical strength. For direct burial in the ground, embedment in concrete, or for areas subjected to corrosive atmospheres, the C-L-X sheath is protected with a low temperature black Okoseal[®] (PVC) jacket.

Applications

C-L-X Type MC-HL cables with the impervious, continuous, corrugated aluminum sheath are recommended as an economical alternate to a wire in conduit system.

They are authorized for use on services, feeders and branch circuits for power, lighting, control and signaling circuits in accordance with Article 330 and 725 of the NEC.

C-L-X Type MC-HL cables may be installed indoors or outdoors, in wet or dry locations, as open runs of cable secured to supports spaced not more than six feet apart, in cable tray, as aerial cable on a messenger, in any approved raceway, direct burial, or encased in concrete. C-L-X type MC-HL cables are also approved for Classes I, II and III, Division 1 and 2 and Class I, Zones 1 and 2 hazardous locations per NEC Articles 501, 502, 503 and 505; in Zone 1, Zone 2, Class II Div 2, Class III Div 1 and Class III Div 2 per CEC.

Specifications

Conductors: Uncoated soft copper per ASTM B-3. Sizes smaller than #8 are compact stranded per ASTM B-8. Sizes #8 and larger are compact stranded per ASTM B-496.

Insulation: X-Olene per ICEA S-95-658/ NEMA WC70 and UL 44, Listed UL Type XHHW-2. Meets MIL-DTL-1377H, section 4.8.4.1.2 cold bend at -66°C and ASTM D746-04 brittle point at -76°C.

Conductor Identification: Control Sizes, #9 AWG and smaller, color coded insulation. Power Sizes, #8 AWG and larger, black with printed words of number and color.

Grounding Conductor(s): One or three bare soft copper per ASTM B-3. Stranded in accordance with UL 1581. Meets or exceeds requirements of NEC Table 250.122.

Sheath: Close fitting, impervious, continuous, welded, corrugated aluminum C-L-X per UL 1569. Exceeds grounding conductor requirements of NEC Table 250.122.

Jacket: Black Okoseal (PVC) per UL1569. Meets ASTM D746-04 brittle point at -40°C.

Product Features

- UL Listed as Type MC-HL cable per E38916
- UL Listed for cable tray use, direct burial and sunlight resistant.
- UL 1309 (CWCMC) listed & UL classified in accord with IEEE 1580 as Marine Shipboard Cable rated 600/1000 volts.
- CSA listed as RA90, FT4, HL and LTGG (-40°C).
- Passes the IEEE 383-1974 and IEEE 1202 vertical tray flame tests.
- Passes the 210,000 BTU ICEA T-29-520 Vertical Tray Flame Test.
- Complete pre-packaged, factory-tested wiring system; color coded.
- C-L-X cables are quality control inspected to meet or exceed applicable UL standards.
- 90°C continuous operating temperature in all types of installations.
- 130°C emergency rating.
- 250°C short circuit rating.
- Good EMI shielding characteristics.
- Impervious, continuous metallic sheath excludes moisture, gases and liquids.
- Lower installed system cost than conduit or EMT systems.
- Provides excellent grounding safety.
- Excellent compression and impact resistance.
- Continuous long lengths.
- Installation temperature of -40°C or °F.
- Complies with NEC Articles 501, 502 and 503 for hazardous locations.
- American Bureau of Shipping Type approved as CWCMC Type MC-HL.
- Three symmetrical grounding conductors for PWM/VFD and other modern AC drive/motor applications.
- CSA Type RA90-HL complies with CEC Zone 1, Zone 2, Class II Div 2, Class III Div 1 and Class III Div 2 Hazardous Locations.

C-L-X Type MC-HL (XHHW-2)

600V Power MC-HL Cable—Aluminum Sheath

600/1000V Marine Cable

Multiple Copper Conductors/90°C Wet or Dry Rating

For Cable Tray Use - Sunlight Resistant - For Direct Burial



Product Data Section 4: Sheet 1

Catalog Number	Conductor Size AWG	Number of Conductors	Insulation Thickness - mils	Grounding Conductor(s) AWG	Core O.D. - Inches	Core O.D. - mm	C-L-X O.D. - Inches	C-L-X O.D. - mm	Jacket Thickness - mils	Jacket Thickness - mm	Approx. O.D. - mm	Approx. O.D. - Inches	Cross-Sectional Area (sq. in.) †	Approx. Net Weight lbs./1000	Approx. Ship Weight lbs./1000	90°C Wet or Dry NEC Ampacity	75°C Wet NEC Ampacity
▲ 546-31-3403	14(7X)	3		3 #18	0.33	8.4	0.53	13.5	50	1.27	0.64	16.3	0.32	160	190	15	15
▲ 546-31-3404	(2.08mm ²)	4	30	3 #18	0.37	9.3	0.58	14.7	50	1.27	0.69	17.5	0.37	222	261	15	15
▲ 546-31-3453	12(7X)	3		3 #16	0.37	9.3	0.58	14.7	50	1.27	0.69	17.5	0.37	239	278	20	20
▲ 546-31-3454	(3.31mm ²)	4	30	3 #16	0.45	11.4	0.67	16.9	50	1.27	0.78	19.7	0.47	286	320	20	20
▲ 546-31-3503	10(7X)	3		3 #14	0.41	10.4	0.62	15.8	50	1.27	0.73	18.6	0.42	300	380	30	30
▲ 546-31-3504	(5.26mm ²)	4	30	3 #14	0.45	11.4	0.67	16.9	50	1.27	0.78	19.7	0.47	348	428	30	28
▲ 571-31-3190	8(7X)	3		3#14	0.50	12.7	0.71	18.0	50	1.27	0.81	20.6	0.52	385	420	55	50
▲ 571-31-3263	(8.36mm ²)	4	45	10	0.58	14.7	0.80	20.3	50	1.27	0.90	22.9	0.64	465	495	44	40
▲ 571-31-3191	6(7X)	3		3#12	0.58	14.7	0.80	20.3	50	1.27	0.90	22.9	0.64	525	595	75	65
▲ 571-31-3270	(13.3mm ²)	4	45	8	0.66	16.8	0.89	22.5	50	1.27	0.99	25.1	0.77	630	685	60	52
▲ 571-31-3200	4(7X)	3		3#12	0.68	17.3	0.89	22.5	50	1.27	0.99	25.1	0.77	704	820	95	85
▲ 571-31-3272	(21.2mm ²)	4	45	8	0.77	19.6	0.97	24.7	50	1.27	1.08	27.5	0.92	845	930	76	68
▲ 571-31-3204	2(7X)	3		3#10	0.80	20.3	1.02	25.9	50	1.27	1.13	28.7	1.00	995	1050	130	115
▲ 571-31-3276	(33.6mm ²)	4	45	6	0.92	23.4	1.15	29.2	50	1.27	1.26	32.0	1.25	1245	1370	104	92
571-31-3208	1(19X)	3		3#10	0.92	23.4	1.15	29.2	50	1.27	1.26	32.0	1.25	1100	1181	150	130
571-31-3280	(42.4mm ²)	4	55	6	1.04	26.4	1.29	32.8	50	1.27	1.40	35.6	1.54	1500	1620	120	104
▲ 571-31-3213	1/0(19X)	3		3#10	1.00	25.5	1.24	31.4	50	1.27	1.34	34.0	1.41	1470	1560	170	150
571-31-3285	(53.5mm ²)	4	55	6	1.12	28.4	1.37	34.9	50	1.27	1.48	37.6	1.72	1830	1975	136	120
▲ 571-31-3216	2/0(19X)	3		3#10	1.09	27.7	1.34	34.0	50	1.27	1.44	36.6	1.63	1770	2020	195	175
▲ 571-31-3289	(67.4mm ²)	4	55	6	1.23	31.2	1.51	38.5	60	1.52	1.64	41.7	2.11	2310	2545	156	140
▲ 571-31-3224	4/0(19X)	3		3#8	1.33	33.8	1.60	40.6	60	1.52	1.73	44.0	—	2675	2880	260	230
▲ 571-31-3296	(107mm ²)	4	55	4	1.49	37.8	1.78	45.2	60	1.52	1.91	48.6	—	3430	3710	208	184
▲ 571-31-3228	250(37X)	3		3#8	1.48	37.6	1.74	44.2	60	1.52	1.87	47.5	—	3140	3420	290	255
571-31-3300	(127mm ²)	4	65	4	1.64	41.6	1.96	49.7	60	1.52	2.09	53.0	—	4070	4330	232	185
▲ 571-31-3236	350(37X)	3		3#7	1.66	42.2	1.96	49.7	60	1.52	2.09	53.0	—	4210	4300	350	310
▲ 571-31-3308	(177mm ²)	4	65	3	1.89	48.0	2.19	55.6	75	1.90	2.35	59.8	—	5440	6000	280	248
▲ 571-31-3244	500(37X)	3		3#6	1.94	59.3	2.28	57.9	75	1.90	2.44	62.0	—	5930	6420	430	380
▲ 571-31-3316	(253mm ²)	4	65	2	2.14	54.4	2.49	63.2	75	1.90	2.65	67.4	—	7570	8120	344	304
▲ 571-31-3248	750(61X)	3		3#5	2.37	60.2	2.75	69.8	75	1.90	2.92	74.1	—	8700	9400	535	475
571-31-3320	(380mm ²)	4	80	1	2.61	66.2	3.03	76.9	85	2.16	3.21	81.6	—	11250	12190	428	380
571-31-3252	1000(61X)	3		1/0	2.67	67.7	3.11	79.0	85	2.16	3.30	83.8	—	11410	12430	615	545
571-31-3324	(507mm ²)	4	80	1/0	3.07	78.0	3.63	92.1	85	2.16	3.81	96.8	—	15110	17510	492	436

Visit Okonite's web site, www.okonite.com for the most up to date dimensions.

C-L-X Type MC-HL (XHHW-2)

600V Power MC-HL Cable—Aluminum Sheath

600/1000V Marine Cable

Multiple Copper Conductors/90°C Wet or Dry Rating

For Cable Tray Use - Sunlight Resistant - For Direct Burial



600V Composite Power and Control Cable — Aluminum Sheath

Okoseal Jacket: 50 mils (1.27mm)

Catalog Number	Power Conductors Number x Size	Insulation Thickness - mils	Control Conductors Number X Size	Insulation Thickness - mils	Grounding Conductor (AWG)	C-L-X O.D. - Inches	C-L-X O.D. - mm	Cable O.D. - Inches	Cable O.D. - mm	Cross-Sectional Area (sq. in.) †	Approx. Net Weight lbs./1000'	Approx. Ship Weight lbs./1000'	90°C Wet or Dry NEC Ampacity (1)	75°C Wet NEC Ampacity
▲ 546-31-3984	3X10	30	4X12	30	10	0.75	19.0	0.86	21.9	0.58	425	460	30	30
▲ 571-31-3657	3X8	45	4X12	30	10	0.89	22.6	0.99	25.1	0.77	530	585	55	50
▲ 571-31-3667	3X6	45	4X12	30	8	0.93	23.6	1.03	26.2	0.83	655	720	75	65
▲ 571-31-3677	3X4	45	4X12	30	8	0.97	24.7	1.08	27.5	0.92	810	895	95	85

Visit Okonite's web site, www.okonite.com for the most up to date dimensions.

▲ **Authorized Stock Item** - Available from our Service Centers.

Copper or Bronze C-L-X is available on special order.

Jackets

Optional jacket types available - consult local sales office.

† **Cross-sectional** area for calculation of cable tray fill in accordance with NEC Section 392.22.

(1) Ampacities

Ampacities are based on Table 310.15(B)(16) of the National Electrical Code for XHHW-2 conductors rated 90°C, in a multi-conductor cable, at an ambient temperature of 30°C (86F). The 75°C column is provided for additional information.

The ampacities shown apply to open runs of cable, installation in any approved raceway, direct burial in the earth, or as aerial cable on a messenger. Derating for more than three current carrying conductors within the cable is in accordance with NEC Section 310.15(B)(3)(a).

The ampacities shown also apply to cables installed in cable tray in accordance with NEC Section 392.80.

C-L-X Type MC-HL (XHHW-2)

600V Power MC-HL Cable—Aluminum Sheath

600/1000V Marine Cable

Multiple Copper Conductors/90°C Wet or Dry Rating

For Cable Tray Use - Sunlight Resistant - For Direct Burial



Product Data Section 4: Sheet 1

Conductor Color Coding Sequence

Conductor Number	Base Color
1	Black
2	Red
3	Blue
4	Orange

Special Order: Any or all of the following conductors may be added when specifically requested by the customer to meet his specific application requirements. These conductor codings comply with UL and NEC requirements.

Purpose	Base Color	Tracer Color
Equipment Grounding	Uninsulated Green Green	1 or more continuous yellow stripes
Grounded	White White White White White White White	Black continuous stripe Red continuous stripe Blue continuous stripe Orange continuous stripe Brown continuous stripe Numeric Printing

Sizes 14, 12 & 10 AWG:
Color Coding per ICEA Method 1, E-2 color sequence.

Sizes 8 AWG and larger:
Surface Printing of Numbers and color descriptions per ICEA Method , E-2 color sequence



C-L-X® Type MC (XHHW-2)

**600V Composite Power and Control MC Cable—Aluminum Sheath
600/1000V Marine Cable**

Multiple Copper Conductors/90°C Wet or Dry Rating
For Cable Tray Use - Sunlight Resistant - For Direct Burial

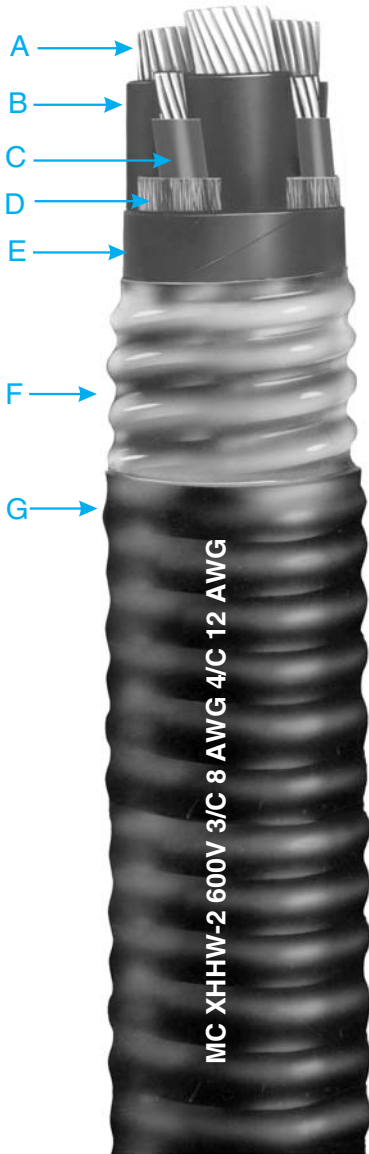

- A** Bare, Stranded Copper Power Conductors
- B** X-Olene Insulation—Color Coded for Identification
- C** Stranded Control Conductors
- D** Non-Hygroscopic Fillers, as necessary
- E** Binder Tape
- F** Impervious, Continuous, Welded Corrugated, Aluminum Sheath
- G** Black Okoseal Jacket

Insulation

X-Olene® is Okonite's trade name for its chemically cross-linked polyethylene, with high dielectric strength.

Color Coding

Conductors 6 AWG and smaller are color coded black, red, blue, orange. Power conductors #4 AWG and larger are printed number/color coded. Control conductors are color coded black, red, blue, yellow. When the control conductors are within one standard AWG size of the power conductors, the control conductors have an additional tracer to facilitate identification.

Assembly and Coverings

The individual conductors are cabled together with non-hygroscopic fillers, bare copper equipment grounding conductor, where indicated, and a binder tape overall. The C-L-X sheath exceeds the grounding conductor requirements of Table 250.122 of the NEC and UL 1569. The impervious, continuous, welded, corrugated aluminum C-L-X sheath provides complete protection against moisture, liquids and gases and has excellent mechanical strength. For direct burial in the ground, embedment in concrete, or for areas subjected to corrosive atmospheres, the C-L-X sheath is protected with a low temperature black Okoseal® (PVC) jacket.

Applications

C-L-X Type MC cables with the impervious, continuous, corrugated aluminum sheath are recommended as an economical alternate to a wire in conduit system.

They are authorized for use on feeders and branch circuits for power, lighting, control and signaling circuits in accordance with Article 330 and 725 of the NEC.

C-L-X Type MC cables may be installed indoors or outdoors, in wet or dry locations, as open runs of cable secured to supports spaced not more than six feet apart, in cable tray, as aerial cable on a messenger, in any approved raceway, direct burial, or encased in concrete. C-L-X type MC cables are also approved for use in Class I & II, Division 2, Class III, Divisions 1 and 2 and Class I, Zone 2 hazardous locations per NEC Articles 501, 502, 503 and 505; in Zone 2, Class II Div 2, Class III Div 1 and Class III Div 2 per CEC.

Specifications

Conductors: Uncoated soft copper per ASTM B-3. Sizes smaller than #8 are compressed stranded per ASTM B-8. Sizes #8 and larger are compact stranded per ASTM B-496.

Insulation: X-Olene per ICEA S-95-658/ NEMA WC-70, ICEA S-73-532/NEMA WC57, and UL 44, Listed UL Type XHHW-2. Meets MIL-DTL-1377H, section 4.8.4.1.2 cold bond at -66°C and ASTM D746-04 brittle point at -76°C.

Conductor Identification: Base color and tracer or printed numbers & color.

Grounding Conductor: Where indicated, bare soft copper per ASTM B-3. Stranded in accordance with UL 1581. Meets or exceeds requirements of NEC Table 250.122.

Sheath: Close fitting, impervious, continuous, welded, corrugated aluminum C-L-X per UL 1569. Exceeds grounding conductor requirements of NEC Table 250-122.

Jacket: Black Okoseal (PVC) per UL 1569. Meets ASTM D746-04 brittle point at -40°C.

Product Features

- UL Listed as Type MC cable per E38916.*
- UL 1309 (CWCMC) listed & UL classified in accord with IEEE 1580 as Marine Shipboard Cable rated 600/1000 volts.
- CSA C22.2 No. 123 listed as RA90, FT4 and LTGG (-40°C).
- UL Listed for cable tray use, direct burial and sunlight resistant.
- Passes the IEEE 383-1974 and IEEE 1202-1991 vertical tray flame tests.
- Passes the 210,000 BTU ICEA T-29-520 Vertical Tray Flame Test.
- Complete pre-packaged, factory-tested wiring system — color coded.
- C-L-X cables are quality control inspected to meet or exceed applicable UL standards.
- 90°C continuous operating temperature in all types of installations.
- 130°C emergency rating.
- 250°C short circuit rating.
- Good EMI shielding characteristics.
- Impervious, continuous metallic sheath excludes moisture, gases and liquids.
- Lower installed system cost than conduit or EMT systems.
- Provides excellent grounding safety.
- Excellent compression and impact resistance.
- Continuous long lengths
- Installation temperature of -40°C or °F.
- American Bureau of Shipping Type approved as CWCMC Type MC.
- CSA Type RA90 complies with CEC Zone 2, Class II Div 2, Class III Div 1 and Class III Div 2 Hazardous Locations.

* Stock items are listed MC-HL

C-L-X Type MC (XHHW-2)

600V Composite Power and Control MC Cable—Aluminum Sheath — 600/1000V Marine Cable

Product Data Section 4: Sheet 2

Multiple Copper Conductors/90°C Wet or Dry Rating



For Cable Tray Use - Sunlight Resistant - For Direct Burial

X-Olene Insulation: #14 Through #10 Awg, 30 mils (0.76mm); #8 Through #2 Awg, 45 mils (1.14mm)

Okoseal Jacket: 50 mils (1.27mm)

Catalog Number	Power Conductors Number X Size	Control Conductors Number X Size	Grounding Conductor AWG	C-L-X O.D. - Inches	C-L-X O.D. - mm	Cable O.D. - Inches	Cable O.D. - mm	Cross-Sectional Area (sq. in.)†	Approx. Net Weight lbs./1000'	Approx. Ship Weight lbs./1000'	90°C Wet or Dry NEC Ampacity (1)	75°C Wet NEC Ampacity
546-31-3983	3X12	3X14	—	0.71	18.0	0.82	20.8	0.53	304	374	20	20
546-31-3927	3X12	4X14	—	0.71	18.0	0.82	20.8	0.53	320	390	20	20
546-31-3950	4X12	3X14	—	0.71	19.1	0.82	20.8	0.53	328	309	20	20
546-31-3925	4X12	4X14	—	0.75	19.1	0.86	21.8	0.58	281	351	20	20
546-31-3758	3X10	3X14	—	0.75	19.1	0.86	21.8	0.58	358	428	30	20
546-31-3992	3X10	4X14	—	0.80	20.3	0.91	23.1	0.65	388	453	30	30
546-31-3990	3X10	3X12	—	0.75	19.1	0.86	21.8	0.58	296	366	30	30
▲ 546-31-3984	3X10	4X12	10	0.75	19.1	0.86	21.8	0.58	430	465	30	30
546-31-3956	4X10	3X14	—	0.80	20.3	0.91	23.1	0.65	408	473	30	28
546-31-3987	4X10	4X14	—	0.80	20.3	0.91	23.1	0.65	424	489	30	28
546-31-3988	4X10	3X12	—	0.80	20.3	0.91	23.1	0.65	432	497	30	28
546-31-3958	4X10	4X12	—	0.80	20.3	0.91	23.1	0.65	455	520	30	28
571-31-3192	3X8	3X14	—	0.80	20.3	0.91	23.1	0.65	420	500	55	50
571-31-3661	3X8	4X14	—	0.84	21.3	0.95	24.1	0.71	450	530	55	50
571-31-3664	3X8	3X12	—	0.80	20.3	0.91	23.1	0.65	450	530	55	50
571-31-3665	3X8	4X12	—	0.84	21.3	0.95	24.1	0.71	490	570	55	50
▲ 571-31-3657	3X8	4X12	10	0.89	22.6	0.99	25.1	0.77	530	585	55	50
571-31-3682	4X8	3X14	—	0.84	21.3	0.95	24.1	0.71	500	580	44	40
571-31-3960	4X8	4X14	—	0.89	22.6	1.00	25.4	0.79	525	605	44	40
571-31-3683	4X8	3X12	—	0.89	22.6	1.00	25.4	0.79	530	615	44	40
571-31-3680	4X8	4X12	—	0.93	23.6	1.04	26.4	0.85	570	650	44	40
571-31-3686	3X6	3X14	—	0.84	21.3	0.95	24.1	0.71	520	600	75	65
571-31-3666	3X6	4X14	—	0.84	21.3	0.95	24.1	0.71	540	620	75	65
571-31-3673	3X6	3X12	—	0.84	21.3	0.95	24.1	0.71	550	630	75	65
571-31-3668	3X6	4X12	—	0.93	23.6	1.03	26.2	0.83	600	680	75	65
▲ 571-31-3667	3X6	4X12	8	0.93	23.6	1.03	26.2	0.83	655	720	75	65
571-31-3968	4X6	3X14	—	0.93	23.6	1.04	26.4	0.85	650	730	60	52
571-31-3684	4X6	4X14	—	0.93	23.6	1.04	26.4	0.85	660	740	60	52
571-31-3685	4X6	3X12	—	0.97	24.6	1.08	27.4	0.92	680	760	60	52
571-31-3965	4X6	4X12	—	0.97	24.6	1.08	27.4	0.92	710	790	60	52
571-31-3655	3X4	3X14	—	0.93	23.6	1.04	26.4	0.85	700	780	95	85
571-31-3970	3X4	4X14	—	0.93	23.6	1.04	26.4	0.85	720	800	95	85
571-31-3671	3X4	3X12	—	0.93	23.6	1.04	26.4	0.85	720	800	95	85
571-31-3974	3X4	4X12	—	0.97	24.6	1.08	27.4	0.92	760	840	95	85
▲ 571-31-3677	3X4	4X12	8	0.97	24.7	1.08	27.5	0.92	810	895	95	85
571-31-3688	4X4	3X14	—	1.06	26.9	1.17	29.7	1.08	890	970	76	68
571-31-3669	4X4	4X14	—	1.06	26.9	1.17	29.7	1.08	920	1000	76	68
571-31-3670	4X4	3X12	—	1.06	26.9	1.17	29.7	1.08	920	1000	76	68
571-31-3672	4X4	4X12	—	1.06	26.9	1.17	29.7	1.08	950	1030	76	68
571-31-3203	3X2	3X14	—	1.06	26.9	1.17	29.7	1.08	985	1065	130	115
571-31-3674	3X2	4X14	—	1.06	26.9	1.17	29.7	1.08	1000	1080	130	115
571-31-3675	3X2	3X12	—	1.06	26.9	1.17	29.7	1.08	1010	1090	130	115
571-31-3505	3X2	4X12	—	1.06	26.9	1.17	29.7	1.08	1040	1115	130	115
571-31-3506	4X2	3X14	—	1.15	29.2	1.26	32.0	1.25	1230	1320	104	92
571-31-3507	4X2	4X14	—	1.15	29.2	1.26	32.0	1.25	1250	1340	104	92
571-31-3508	4X2	3X12	—	1.15	29.2	1.26	32.0	1.25	1260	1350	104	92
571-31-3509	4X2	4X12	—	1.15	29.2	1.26	32.0	1.25	1280	1370	104	92

Visit Okonite's web site, www.okonite.com for the most up to date dimensions.

▲ **Authorized Stock Item** - Available from our Service Centers. These stock items are listed as MC-HL.

Copper or Bronze C-L-X is available on special order.

Jackets

Optional jacket types available - consult local sales office.

†**Cross-sectional** area for calculation of cable tray fill in accordance with NEC Section 392.22.

(1) Ampacities

Ampacities are based on Table 310.15(B)(16) of the National Electrical Code for XHHW-2 conductors rated 90°C, in a multi-conductor cable, at an ambient temperature of 30°C (86°F). The 75°C column is provided for additional information.

The ampacities shown apply to open runs of cable, installation in any approved raceway, direct burial in the earth, or as aerial cable on a messenger. Derating for more than three current carrying conductors within the cable is in accordance with NEC Section 310.15(B)(3)(a).

The ampacities shown also apply to cable installed in cable tray in accordance with NEC Section 392.80



Okonite-FMR® Okoseal® Type



UL Type TC/TC-ER and cUL CIC 600V Power & Control Tray Cable or Oko-Marine Cable 600/1000V

Multiple Copper Conductors With or Without
Grounding Conductor/90°C Wet or Dry

For Cable Tray Use - Sunlight Resistant - For Direct Burial

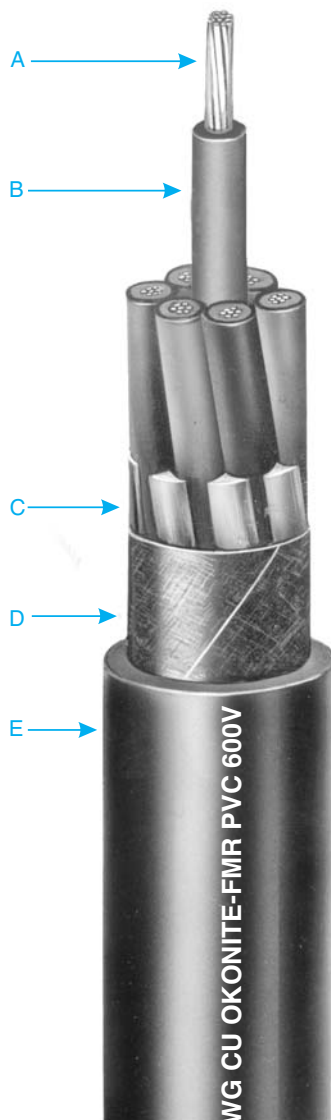

- A Stranded Copper Conductors
- B Okonite-FMR Insulation
- C Fillers, as necessary
- D Binder Tape
- E Okoseal Jacket — Black

Insulation

Okonite-FMR is Okonite's trade name for its heat, moisture, flame and chemical resistant, mechanically rugged ethylene-propylene insulating compound.

The properties of Okonite-FMR insulation substantially enhance the well known features of ethylene-propylene rubber insulations.

Overall Jacket

The Okoseal (PVC) jacket is mechanically rugged and has excellent resistance to most chemicals.

Applications

Okonite-FMR Okoseal Type TC-ER tray cable is permitted for use on power, lighting, control, and signal circuits; indoors or outdoors; in cable trays, raceways, direct burial in the ground, or where supported in outdoor locations by a messenger wire; for Class 1 circuits as permitted in Article 725 of the NEC; and in cable trays in Class I, Division 2 hazardous locations in industrial establishments where the conditions of maintenance and supervision assure that only qualified persons will service the installation. Cables marked TC-ER may also be used between a cable tray and the utilization equipment or device, when installed in accordance with NEC 336.10(7).

As Type Oko-Marine cable, it is suitable for use in marine shipboard and off-shore platform applications in accordance with API and ABS requirements.

Specifications

Conductors: Uncoated soft copper per ASTM B-3. Sizes smaller than #8 are compress stranded per ASTM B-8. Sizes #8 and larger are compact stranded per ASTM B-496.

Insulation: Okonite-FMR meets or exceeds requirements of UL 1581, ICEA S-73-532 (NEMA WC57) and ICEA S-95-658 NEMA WC70 Type II insulation.

Color Coding: Base colors and tracers as shown on reverse of Data Sheet and for sizes #8 AWG and larger black conductors with surface printing of numbers per ICEA S-73-532 NEMA/WC57 Method 4.

Grounding Conductor: Where indicated, bare stranded copper per ASTM B-8, or compact round per ASTM B-496, Class B & NEC Table 250.122.

Assembly: Conductors cabled in accordance with UL 1277 and 1309 using fillers, as necessary, with a cable tape overall.

Overall Jacket: Complies with UL 1277 and 1309. The Okoseal compound meets or exceeds the requirements of UL 1581. UL Listed as Type TC or TC-ER cable with a sunlight resistant low temperature jacket and for direct burial and Type Oko-Marine cable.

Sizes 4 AWG and larger without a grounding conductor are Type TC only (not ER).

Product Features

Insulated conductors are UL rated VW-1. 90°C continuous rating in wet or dry 130°C emergency overload rating 250°C short circuit rating.

Okonite-FMR Okoseal Type TC-ER and Oko-Marine cables are quality control inspected to meet or exceed applicable industry standards.

Resistant to moisture and most chemical atmospheres.

Thermal stability at elevated temperatures.

Flexible, easy to install and terminate.

High dielectric strength.

Installation Temperature -35°C.

Applicable Standards

- UL listed for cable tray use, direct burial, in ducts, and sunlight resistant.
- Vertical Tray Flame Tests; IEEE 383-1974, FT4/IEEE 1202, UL 1277, Sizes 250 kcmil and larger meet ICEA T-29-520 (210,000 BTU/hr).
- OSHA Acceptable
- UL 1309-Oko-Marine
- UL certified to IEEE 1580 - Marine Shipboard Cable rated 600/1000V.
- ABS Type approved; API-RP-14F, IEEE 45 & 1202, 46 CFR 111.60.
- CSA C22.2 No. 239 Type CIC for sizes 4/0 AWG and smaller.
- CSA C22.2 No. 245 Type Marine Shipboard.

Okonite-FMR Okoseal®

UL Type TC/TC-ER and cUL CIC 600V Power & Control Tray Cable or Oko-Marine Cable 600/1000V

Multiple Copper Conductors With or Without Grounding Conductor/90°C Wet or Dry Rating

For Cable Tray Use - Sunlight Resistant - for Direct Burial

Product Data Section 4: Sheet 5



Catalog Number	Conductor Size AWG/kcmil	Number of Conductors	Insulation Thickness (mils)	Grounding Conductor AWG	Jacket Thickness (mils)	Jacket Thickness (mm)	Approx. O.D. (In.)	Approx. O.D. (mm)	Cross-Sectional Area (sq. In.) †	Approx. Net Weight lbs./1000'	Approx. Ship Weight lbs./1000'	90°C Wet or Dry NEC Ampacity (1)	75°C Wet NEC Ampacity (1)
UL TYPE: TC-ER													
▲ 202-10-3203	14(7X)	3	—	45	1.14	0.40	10.2	0.13	104	127	15	15	
▲ 202-10-3204		4	—	45	1.14	0.44	11.2	0.16	126	149	15	15	
▲ 202-10-3205		5	—	45	1.14	0.48	12.2	0.18	151	174	15	15	
▲ 202-10-3207		7	—	45	1.14	0.52	13.2	0.22	195	218	15	14	
202-10-3209		9	—	60	1.52	0.63	16.0	0.32	260	292	15	14	
▲ 202-10-3212		12	—	60	1.52	0.71	18.0	0.40	332	364	12	10	
▲ 202-10-3219		19	—	60	1.52	0.82	20.8	0.54	480	519	12	10	
▲ 202-10-3237		37	—	80	2.03	1.14	29.0	1.03	925	1005	10	8	
▲ 202-10-3403		12(7X)	3	—	45	1.14	0.44	11.2	0.16	134	157	20	20
▲ 202-10-3443			3	12*	45	1.14	0.48	12.2	0.18	162	185	20	20
▲ 202-10-3404			4	—	45	1.14	0.48	12.2	0.19	167	190	20	20
▲ 202-10-3405			5	—	45	1.14	0.52	13.2	0.22	202	225	20	20
▲ 202-10-3407	7		—	60	1.52	0.60	15.2	0.29	281	305	20	17	
▲ 202-10-3409	9		—	60	1.52	0.70	17.8	0.39	363	395	20	17	
▲ 202-10-3412	12		—	60	1.52	0.78	19.8	0.49	446	485	15	12	
▲ 202-10-3419	19		—	80	2.03	0.95	24.1	0.73	697	752	15	12	
202-10-3437	37		—	80	2.03	1.26	32.0	1.27	1266	1266	12	10	
▲ 202-10-3503	10(7X)		3	—	45	1.14	0.49	12.4	0.20	183	206	30	30
▲ 202-10-3543			3	10*	45	1.14	0.53	13.5	0.23	223	247	30	30
▲ 202-10-3504			4	—	60	1.52	0.57	14.5	0.26	243	267	30	28
202-10-3505		5	—	60	1.52	0.62	15.7	0.31	294	318	30	28	
202-10-3507		7	—	60	1.52	0.67	17.0	0.37	384	416	28	24	
202-10-3509		9	—	60	1.52	0.78	19.8	0.49	494	533	28	24	
202-10-3512		12	—	80	2.03	0.92	23.4	0.68	669	724	20	17	

Visit Okonite's web site, www.okonite.com, for the most up to date dimensions.

▲ Authorized stock item — Available from our Service Centers.

Equipment Grounding Conductor: Any conductor in these cables may be permanently re-identified during installation as the equipment grounding conductor in accordance with Section 250.119.B of the NEC.

† **Cross-sectional** area for calculation of cable tray fill in accordance with Section 392.22 of the NEC.

(1) Ampacities

Ampacities are based on Table 310-15(B)(16) of the National Electrical Code for conductors rated 90°C, in a multi-conductor cable, at an ambient temperature of 30°C (86°F). The 75°C column is provided for additional information.

The ampacities shown apply to open runs of cable, installation in any approved raceway, direct burial in the earth, or as aerial cable on a messenger. Derating for more than three current carrying conductors within the cable is in accordance with NEC Section 310.15(B)(3)(a)

The ampacities shown also apply to cables installed in cable tray in accordance with NEC Section 392.80.

Product Data

Section 4: Sheet 5

Catalog Number	Conductor Size AWG/kcmil	UL TC TYPE	Number of Conductors	Insulation Thickness (mils)	Grounding Conductor AWG**	Jacket Thickness (mils)	Jacket Thickness (mm)	Approx. O.D. (In.)	Approx. O.D. (mm)	Cross-Sectional Area (sq. In.) +	Approx. Net Weight lbs./1000'	Approx. Ship Weight lbs./1000'	90°C Wet or Dry NEC Ampacity (1)	75°C Wet NEC Ampacity (1)
112-10-3842	8(7X)	TC-ER	3	45	—	60	1.52	0.64	16.3	0.32	273	305	55	50
▲ 112-10-3844			3		10*	60	1.52	0.70	17.8	0.38	349	388	55	50
112-10-3845			4		—	60	1.52	0.70	17.8	0.38	352	391	45	40
112-10-3847			4		10*	60	1.52	0.73	18.5	0.42	412	451	45	40
112-10-3852	6(7X)	TC-ER	3	45	—	60	1.52	0.72	18.3	0.41	382	421	75	65
▲ 112-10-3854			3		8*	60	1.52	0.76	19.3	0.45	437	469	75	65
112-10-3855			4		—	60	1.52	0.79	20.1	0.49	493	532	60	52
112-10-3857			4		8*	60	1.52	0.83	21.1	0.54	582	637	60	52
112-10-3862	4(7X)	TC	3	45	—	60	1.52	0.81	20.6	0.52	549	588	95	85
▲ 112-10-3864		TC-ER	3		8*	80	2.03	0.84	21.3	0.55	696	751	95	85
112-10-3865		TC	4		—	80	2.03	0.94	23.9	0.69	750	805	76	68
112-10-3867		TC-ER	4		8*	80	2.03	1.00	25.4	0.79	891	955	76	68
112-10-3872	2(7X)	TC	3	45	—	80	2.03	0.99	25.1	0.77	888	952	130	115
▲ 112-10-3874		TC-ER	3		6	80	2.03	0.99	25.1	0.77	941	1005	130	115
112-10-3875		TC	4		—	80	2.03	1.09	27.7	0.93	1133	1200	104	92
112-10-3877		TC-ER	4		6	80	2.03	1.12	28.4	0.99	1242	1322	104	92
112-10-3882	1(19X)	TC	3	55	—	80	2.03	1.10	27.9	0.95	1103	1170	150	130
112-10-3884		TC-ER	3		6	80	2.03	1.10	27.9	0.95	1180	1247	150	130
112-10-3885		TC	4		—	80	2.03	1.21	30.7	1.15	1434	1534	120	104
112-10-3887		TC-ER	4		6	80	2.03	1.21	30.7	1.15	1505	1605	120	104
112-10-3892	1/0(19X)	TC	3	55	—	80	2.03	1.18	30.0	1.09	1330	1410	170	150
▲ 112-10-3894		TC-ER	3		6	80	2.03	1.18	30.0	1.09	1410	1490	170	150
112-10-3895		TC	4		—	80	2.03	1.30	33.0	1.33	1741	1841	136	120
112-10-3897		TC-ER	4		6	80	2.03	1.23	31.2	1.19	1812	1912	136	120
112-10-3902	2/0(19X)	TC	3	55	—	80	2.03	1.27	32.3	1.27	1632	1732	195	175
▲ 112-10-3904		TC-ER	3		6	80	2.03	1.27	32.3	1.27	1711	1811	195	175
112-10-3905		TC	4		—	80	2.03	1.40	35.6	1.54	2114	2230	156	140
112-10-3907		TC-ER	4		6	80	2.03	1.40	35.6	1.54	2186	2302	156	140
112-10-3922	4/0(19X)	TC	3	55	—	80	2.03	1.48	39.4	—	2462	2605	260	230
▲ 112-10-3924		TC-ER	3		4	80	2.03	1.48	39.4	—	2576	2719	260	230
112-10-3925		TC	4		—	80	2.03	1.64	50.0	—	3206	3383	208	184
112-10-3927		TC-ER	4		4	80	2.03	1.64	50.0	—	3320	3497	208	184
112-10-3928	250(37X)	TC	3	65	—	80	2.03	1.62	44.7	—	2904	3047	290	255
112-10-3929		TC-ER	3		4	80	2.03	1.62	44.7	—	3029	3206	290	255
112-10-3930		TC	4		—	110	2.79	1.86	49.3	—	3893	4159	232	185
112-10-3931		TC-ER	4		4	110	2.79	1.86	49.3	—	4000	4265	232	185
112-10-3932	350(37X)	TC	3	65	—	110	2.79	1.89	50.3	—	3995	4261	350	310
▲ 112-10-3933		TC-ER	3		3	110	2.79	1.89	50.3	—	4164	4430	350	310
112-10-3934		TC	4		—	110	2.79	2.08	55.6	—	5243	5590	280	248
112-10-3935		TC-ER	4		3	110	2.79	2.08	55.6	—	5394	5741	280	248
112-10-3936	500(37X)	TC	3	65	—	110	2.79	2.14	57.4	—	5549	5939	430	380
▲ 112-10-3937		TC-ER	3		2	110	2.79	2.14	57.4	—	5743	6133	430	380
112-10-3938		TC	4		—	110	2.79	2.37	63.5	—	7237	7796	344	304
112-10-3939		TC-ER	4		2	110	2.79	2.37	63.5	—	7425	7984	344	304
112-10-3940	750(61X)	TC	3	80	—	110	2.79	2.58	68.6	—	8277	8904	535	475
112-10-3941		TC-ER	3		1	110	2.79	2.58	68.6	—	8515	9142	535	475
112-10-3942		TC	4		—	140	3.56	2.92	76.5	—	10942	11704	428	380
112-10-3943		TC-ER	4		1	140	3.56	2.92	76.5	—	11157	11919	428	380
112-10-3944	1000(61X)	TC	3	80	—	140	3.56	2.96	77.2	—	10953	11715	615	545
112-10-3945		TC-ER	3		1/0	140	3.56	2.96	77.2	—	11237	12000	615	545
112-10-3946		TC	4		—	140	3.56	3.28	85.6	—	14337	15270	492	436
112-10-3947		TC-ER	4		1/0	140	3.56	3.28	85.6	—	14632	15565	492	436

Note: Sizes 4 AWG & larger without a grounding conductor are type TC only (not ER rated).

*Ground size marked with asterisk are green insulated. **Grounds may be split.

Visit Okonite's web site, www.okonite.com, for the most up to date dimensions.

Okonite-FMR Okoseal

UL Type TC/TC-ER and cUL CIC 600V Power & Control Tray

Cable or Oko-Marine Cable 600/1000V

Multiple Copper Conductors With or Without

Grounding Conductor/ 90°C Wet or Dry

For Cable Tray Use - Sunlight Resistant - For Direct Burial

Product Data Section 4: Sheet 5



Conductor Color Coding Sequence Sizes 14, 12 & 10 AWG

Conductor Number	Base Color	Tracer Color
1	Black	
2	Red	
3	Blue	
4	Orange	
5	Yellow	
6	Brown	
7	Red	Black
8	Blue	Black
9	Orange	Black
10	Yellow	Black
11	Brown	Black
12	Black	Red
13	Blue	Red
14	Orange	Red
15	Yellow	Red
16	Brown	Red
17	Black	Blue
18	Red	Blue
19	Orange	Blue
20	Yellow	Blue
21	Brown	Blue
22	Black	Orange
23	Red	Orange
24	Blue	Orange
25	Yellow	Orange
26	Brown	Orange
27	Black	Yellow
28	Red	Yellow
29	Blue	Yellow
30	Orange	Yellow
31	Brown	Yellow
32	Black	Brown
33	Red	Brown
34	Blue	Brown
35	Orange	Brown
36	Yellow	Brown
37	Black	

Color Coding per ICEA Method 1, E-2

Sizes 8 AWG and larger:

Surface Printing of Numbers per ICEA Method 4

Special Order: Any or all of the following conductors may be added when specifically requested by the customer to meet his specific application requirements. These conductor codings comply with UL and NEC requirements.

<u>Purpose</u>	<u>Base Color</u>	<u>Tracer Color</u>
Equipment Grounding	Uninsulated Green Green	1 or more continuous yellow stripes
Grounded	White White White White White White White	Black continuous stripe Red continuous stripe Blue continuous stripe Orange continuous stripe Brown continuous stripe Numeric Printing



X-Olene®-Okoseal®

UL Type TC/TC-ER (XHH/XHHW-2) and cUL CIC

600 Volt Power and Control Tray Cable

Multiple Copper Conductors, 90°C Wet or Dry
With or Without Grounding Conductor

For Cable Tray Use - Sunlight Resistant - For Direct Burial



A Uncoated Copper Conductors
B X-Olene Insulation
C Fillers, as required
D Black Okoseal Jacket

Insulation

X-Olene® is Okonite's trade name for its cross-linked polyethylene, with high dielectric strength insulation.

Jacket

The Okoseal (PVC) jacket supplied with this cable is mechanically rugged and has excellent resistance to acids and most chemicals and is rated for low temperature installations.

Applications

Okonite X-Olene Okoseal tray cable is permitted for use on power, lighting, control, and signal circuits; indoors or outdoors; in cable trays, raceways, direct burial in the ground, or where supported in outdoor locations by a messenger wire; for Class 1 circuits as permitted in Article 725 of the NEC; and in cable trays in Class I, Division 2 hazardous locations in industrial establishments where the conditions of maintenance and supervision assure that only qualified persons will service the installation. Cables marked TC-ER may also be used between a cable tray and the utilization equipment or device, when installed in accordance with NEC 336.10(7).

Specifications

Conductors: Uncoated soft copper per ASTM B-3. Sizes smaller than #8 are compress stranded per ASTM B-8. Sizes #8 and larger are compact stranded per ASTM B-496.

Insulation: X-Olene insulation per UL 1581, listed as XHHW-2.

Color Coding: Base colors and tracers as shown on reverse of Data Sheet and, for sizes #8 AWG and larger, black conductors with surface printing of numbers and colors per ICEA S-73-532 NEMA/WC57 Method 3.

Assembly: Conductors cabled in accordance with UL 1277 using fillers and tape, as needed.

Grounding Conductor: Where indicated, bare or insulated stranded copper in accordance with NEC Table 250.122.

Overall Jacket: Complies with UL 1277. The Okoseal compound meets or exceeds the requirements of UL 1581.

Cable passes the Vertical Tray Flame Test requirements of UL 1277 for Type TC Power and Control Tray Cable.

UL Listed as Type TC or TC-ER cable with a sunlight resistant jacket and for direct burial.

Product Features

Insulated conductors are UL Listed Type XHH / XHHW-2.

90°C continuous rating in wet or dry locations.

130°C emergency overload rating.

250°C short circuit rating.

X-Olene Okoseal Type TC or TC-ER cables are quality control inspected to meet or exceed applicable industry standards.

Resistant to moisture and most chemical atmospheres.

Thermal stability at elevated temperatures.

Easy to install and terminate.

Mechanically rugged.

High dielectric strength.

Small diameter, lightweight.

Minimum installation temperature of -40°C.

Applicable Standards

- UL listed for cable tray use, direct burial, in ducts, and sunlight resistant.
- Vertical Tray Flame Tests: IEEE 383-1974, Sizes 4/0 AWG and larger meet FT4/IEEE 1202.
- CSA C22.2 No. 239 Type CIC for sizes 4/0 AWG and smaller.

X-Olene-Okoseal



Product Data Section 4: Sheet 8

UL Type TC/TC-ER (XHH/XHHW-2) and cUL CIC

600V Power and Control Tray Cable

Multiple Copper Conductors, 90°C Wet or Dry

With or Without Grounding Conductor

For Cable Tray Use - Sunlight Resistant - For Direct Burial

Catalog Number	Conductor Size AWG/kcmil	UL TYPE	Number of Conductors	Insulation Thickness - mils	Jacket Thickness - mils	Jacket Thickness - mils	Approx. Thickness - mm	Approx. O.D. - Inches	Approx. O.D. - mm	Approx. Cross-Sectional Area (sq. in.)†	Approx. Net Weight lbs./1000'	Approx. Ship Weight lbs./1000'	90°C Wet or Dry NEC Ampacity (1)	75°C Wet NEC Ampacity (1)	
▲ 202-31-3502	14(7X) (2.08mm ²)	TC	2	30 (0.76mm)	45	1.14	0.37	9.4	0.11	70	85	15	15		
▲ 202-31-3503		TC-ER	3		45	1.14	0.41	10.4	0.13	105	120	15	15		
▲ 202-31-3504		TC-ER	4		45	1.14	0.43	10.9	0.15	120	135	15	15		
▲ 202-31-3505		TC-ER	5		45	1.14	0.47	11.9	0.17	132	148	15	15		
▲ 202-31-3507		TC-ER	7		45	1.14	0.50	12.7	0.20	182	205	15	14		
▲ 202-31-3509		TC-ER	9		60	1.52	0.62	15.7	0.30	254	278	15	14		
▲ 202-31-3512		TC-ER	12		60	1.52	0.69	17.6	0.38	306	338	12	10		
202-31-3519		TC-ER	19		60	1.52	0.80	20.3	0.50	446	485	12	10		
202-31-3537		TC-ER	37		80	2.03	1.11	28.2	0.97	856	936	10	8		
▲ 202-31-3602		12(7X) (3.31mm ²)	TC		2	30 (0.76mm)	45	1.14	0.40	10.2	0.13	92	107	20	20
▲ 202-31-3603			TC-ER		3		45	1.14	0.44	11.2	0.15	139	152	20	20
▲ 202-31-3604			TC-ER		4		45	1.14	0.47	11.9	0.17	171	187	20	20
▲ 202-31-3605	TC-ER		5	45	1.14		0.52	13.1	0.21	179	195	20	20		
▲ 202-31-3607	TC-ER		7	60	1.52		0.59	15.0	0.27	269	293	20	17		
▲ 202-31-3609	TC-ER		9	60	1.52		0.68	17.3	0.36	344	376	20	17		
▲ 202-31-3612	TC-ER		12	60	1.52		0.77	19.6	0.47	425	464	15	12		
202-31-3619	TC-ER		19	80	2.03		0.95	24.1	0.71	640	704	15	12		
202-31-3637	TC-ER		37	80	2.03		1.24	31.5	1.21	1200	1290	12	10		
▲ 202-31-3702	10(7X) (5.26mm ²)		TC	2	30 (0.76mm)		45	1.14	0.45	11.4	0.16	122	138	30	30
▲ 202-31-3703			TC-ER	3			45	1.14	0.48	12.2	0.18	183	199	30	30
▲ 202-31-3704			TC-ER	4			45	1.14	0.53	13.5	0.22	238	254	30	28
202-31-3705		TC-ER	5	60		1.52	0.61	15.5	0.29	294	318	30	28		
202-31-3707		TC-ER	7	60		1.52	0.66	16.8	0.34	378	410	28	24		
202-31-3709		TC-ER	9	60		1.52	0.77	19.6	0.47	485	524	28	24		
202-31-3712		TC-ER	12	80		2.03	0.91	23.1	0.65	643	698	20	17		

Catalog Number	Conductor Size AWG/kcmil	Number of Conductors	Insulation Thickness - mils	Green Insulated Grounding Conductor AWG	Jacket Thickness - mils	Jacket Thickness - mils	Approx. Thickness - mm	Approx. O.D. - Inches	Approx. O.D. - mm	Approx Cross-Sectional Area (sq. in.)†	Approx. Net Weight lbs./1000'	Approx. Ship Weight lbs./1000'	90°C Wet or Dry NEC Ampacity (1)	75°C Wet NEC Ampacity (1)
UL TYPE: TC-ER														
202-31-3813	14(7X)	3	30	1#14	45	1.14	.43	10.9	0.15	120	135	15	15	
▲ 202-31-3823	12(7X)	3	30	1#12	45	1.14	.47	11.9	0.17	171	187	20	20	
▲ 202-31-3833	10(7X)	3	30	1#10	45	1.14	.53	13.5	0.22	238	254	30	30	

▲ Authorized Stock Item - Available from our Service Centers.

Equipment Grounding Conductor: Any conductor in these cables may be permanently re-identified during installation as the equipment grounding conductor in accordance with Section 250.119.B of the NEC.

† Cross-sectional area for calculation of cable tray fill in accordance with NEC Section 392.22.

(1) Ampacities

Ampacities are based on Table 310.15(B)(16) of the National Electrical Code for XHHW-2 conductors rated 90°C, in a multi-conductor cable, at an ambient temperature of 30°C (86°F). Derating for more than three current carrying conductors within the cable is in accordance with NEC Section 310.15(B)(3)(a).

The ampacities shown also apply to cables installed in cable tray in accordance with NEC Section 392.80.

Product Data

Section 4: Sheet 8

Catalog Number	Conductor Size AWG/kcmil	UL TYPE	Number of Conductors	Insulation Thickness - mils	Grounding Conductor AWG	Jacket Thickness - mils	Jacket Thickness - mm	Approx. O.D. - Inches	Approx. O.D. - mm	Approx. Cross-Sectional Area (sq. in./ft	Approx. Net Weight lbs./1000'	Approx. Ship Weight lbs./1000'	90°C Wet or Dry NEC Ampacity (1)	75°C Wet (1) NEC Ampacity
112-31-3734	8(7X) (8.36mm ²)	TC-ER	3	—	60	1.52	0.64	16.3	0.32	259	298	55	50	
▲ 112-31-3735		TC-ER	3	10	60	1.52	0.66	16.7	0.34	313	352	55	50	
112-31-3736		TC-ER	4	—	60	1.52	0.70	17.8	0.39	331	370	44	40	
112-31-3737		TC-ER	4	10	60	1.52	0.72	18.3	0.41	385	424	44	40	
112-31-3746	6(7X) (13.3mm ²)	TC-ER	3	—	60	1.52	0.71	18.0	0.40	365	404	75	65	
▲ 112-31-3747		TC-ER	3	8	60	1.52	0.74	18.8	0.43	440	479	75	65	
112-31-3748		TC-ER	4	—	60	1.52	0.78	19.8	0.48	471	510	60	52	
112-31-3749		TC-ER	4	8	60	1.52	0.82	20.8	0.53	552	616	60	52	
112-31-3758	4(7X) (21.2mm ²)	TC	3	—	60	1.52	0.81	20.6	0.52	527	566	95	85	
▲ 112-31-3759		TC-ER	3	8	60	1.52	0.81	20.6	0.52	662	715	95	85	
112-31-3760		TC	4	—	80	2.03	0.93	23.6	0.68	720	784	76	68	
112-31-3761		TC-ER	4	8	80	2.03	0.96	24.4	0.72	808	872	76	68	
112-31-3764	2(7X) (33.6mm ²)	TC	3	—	80	2.03	0.97	24.6	0.74	816	880	130	115	
▲ 112-31-3765		TC-ER	3	6	80	2.03	0.97	24.6	0.74	1018	1098	130	115	
112-31-3766		TC	4	—	80	2.03	1.07	27.2	0.90	1060	1140	104	92	
112-31-3767		TC-ER	4	6	80	2.03	1.11	28.2	0.97	1196	1276	104	92	
112-31-3770	1(19X) (42.4mm ²)	TC	3	—	80	2.03	1.09	27.7	0.93	1051	1118	150	130	
112-31-3771		TC-ER	3	6	80	2.03	1.09	27.7	0.93	1127	1194	150	130	
112-31-3772		TC	4	—	80	2.03	1.20	30.5	1.13	1355	1435	120	104	
112-31-3773		TC-ER	4	6	80	2.03	1.20	30.5	1.13	1431	1511	120	104	
112-31-3776	1/0(19X) (53.5mm ²)	TC	3	—	80	2.03	1.17	29.7	1.08	1274	1354	170	150	
▲ 112-31-3777		TC-ER	3	6	80	2.03	1.17	20.7	1.08	1350	1430	170	150	
112-31-3778		TC	4	—	80	2.03	1.29	32.8	1.31	1652	1752	136	120	
112-31-3779		TC-ER	4	6	80	2.03	1.29	32.8	1.31	1729	1829	136	120	
112-31-3780	2/0(19X) (67.4mm ²)	TC	3	—	80	2.03	1.26	32.0	1.25	1561	1661	195	175	
▲ 112-31-3781		TC-ER	3	6	80	2.03	1.26	32.0	1.25	1639	1739	195	175	
112-31-3782		TC	4	—	80	2.03	1.39	35.3	1.52	2033	2149	156	140	
112-31-3783		TC-ER	4	6	80	2.03	1.39	35.3	1.52	2109	2225	156	140	
112-31-3784	4/0 (19X) (107mm ²)	TC	3	—	80	2.03	1.47	37.3	—	2361	2504	260	230	
▲ 112-31-3785		TC-ER	3	4	80	2.03	1.47	37.3	—	2488	2631	260	230	
112-31-3786		TC	4	—	80	2.03	1.63	41.4	—	3101	3278	208	184	
112-31-3787		TC-ER	4	4	80	2.03	1.63	41.4	—	3222	3399	208	184	
112-31-3788	250(37X) (127mm ²)	TC	3	—	80	2.03	1.62	41.2	—	2796	2939	290	255	
112-31-3789		TC-ER	3	4	80	2.03	1.62	41.2	—	2917	3060	290	255	
112-31-3790		TC	4	—	110	2.79	1.85	47.0	—	3778	4044	232	185	
112-31-3791		TC-ER	4	4	110	2.79	1.85	47.0	—	3899	4165	232	185	
112-31-3792	350(37X) (177mm ²)	TC	3	—	110	2.79	1.88	47.8	—	3889	4155	350	310	
▲ 112-31-3793		TC-ER	3	3	110	2.79	1.88	47.8	—	4044	4310	350	310	
112-31-3794		TC	4	—	110	2.79	2.08	52.8	—	5091	5438	280	248	
112-31-3795		TC-ER	4	3	110	2.79	2.08	52.8	—	5245	5592	280	248	
112-31-3796	500(37X) (253mm ²)	TC	3	—	110	2.79	2.13	54.1	—	5386	5733	430	380	
▲ 112-31-3797		TC-ER	3	2	110	2.79	2.13	54.1	—	5581	5928	430	380	
112-31-3798		TC	4	—	110	2.79	2.36	59.9	—	7082	7641	344	304	
112-31-3799		TC-ER	4	2	110	2.79	2.36	59.9	—	7276	7835	344	304	
112-31-3800	750(61X) (380mm ²)	TC	3	—	110	2.79	2.56	65.0	—	7961	8520	535	475	
▲ 112-31-3801		TC-ER	3	1	110	2.79	2.56	65.0	—	8206	8833	535	475	
112-31-3802		TC	4	—	140	3.56	2.90	73.7	—	10632	11394	428	380	
112-31-3803		TC-ER	4	1	140	3.56	2.90	73.7	—	10879	11641	428	380	
112-31-3804	1000(61X) (507mm ²)	TC	3	—	140	3.56	2.93	74.4	—	10584	11346	615	545	
112-31-3805		TC-ER	3	1/0	140	3.56	2.93	74.4	—	10894	11656	615	545	
112-31-3806		TC	4	—	140	3.56	3.25	82.6	—	13925	14858	492	436	
112-31-3807		TC-ER	4	1/0	140	3.56	3.25	82.6	—	14235	15168	492	436	

NOTE: Sizes 4AWG & larger without a grounding conductor are Type TC only (Not ER rated).

X-Olene-Okoseal



UL Type TC/TC-ER (XHH/XHHW-2) and cUL CIC

600 Volt Power and Control Tray Cable

Multiple Copper Conductors, 90°C Wet or Dry

With or Without Grounding Conductor

For Cable Tray Use - Sunlight Resistant - For Direct Burial

Product Data Section 4: Sheet 8

Conductor Color Coding Sequence

Conductor Number	Base Color	Tracer Color
1	Black	
2	Red	
3	Blue	
4	Orange	
5	Yellow	
6	Brown	
7	Red	Black
8	Blue	Black
9	Orange	Black
10	Yellow	Black
11	Brown	Black
12	Black	Red
13	Blue	Red
14	Orange	Red
15	Yellow	Red
16	Brown	Red
17	Black	Blue
18	Red	Blue
19	Orange	Blue
20	Yellow	Blue
21	Brown	Blue
22	Black	Orange
23	Red	Orange
24	Blue	Orange
25	Yellow	Orange
26	Brown	Orange
27	Black	Yellow
28	Red	Yellow
29	Blue	Yellow
30	Orange	Yellow
31	Brown	Yellow
32	Black	Brown
33	Red	Brown
34	Blue	Brown
35	Orange	Brown
36	Yellow	Brown
37	Black	

Color Coding

Sizes 14, 12 & 10 AWG:
per ICEA Method 1, E-2 color sequence

Sizes 8 AWG and larger:
Surface Printing of Numbers and color designation per ICEA Method 3, E-2 color sequence

Special Order: Any or all of the following conductors may be added when specifically requested by the customer to meet his specific application requirements. These conductor codings comply with UL and NEC requirements.

Purpose	Base Color	Tracer Color
Equipment Grounding	Uninsulated Green Green	1 or more continuous yellow stripes
Grounded	White White White White White White White	Black continuous stripe Red continuous stripe Blue continuous stripe Orange continuous stripe Brown continuous stripe Numeric Printing



C-L-X[®] Type MC (XHHW-2)

600V Control Cable — Aluminum Sheath 600/1000V Marine Cable

Multiple Copper Conductors/90°C Wet or Dry Rating

For Cable Tray Use - Sunlight Resistant - For Direct Burial

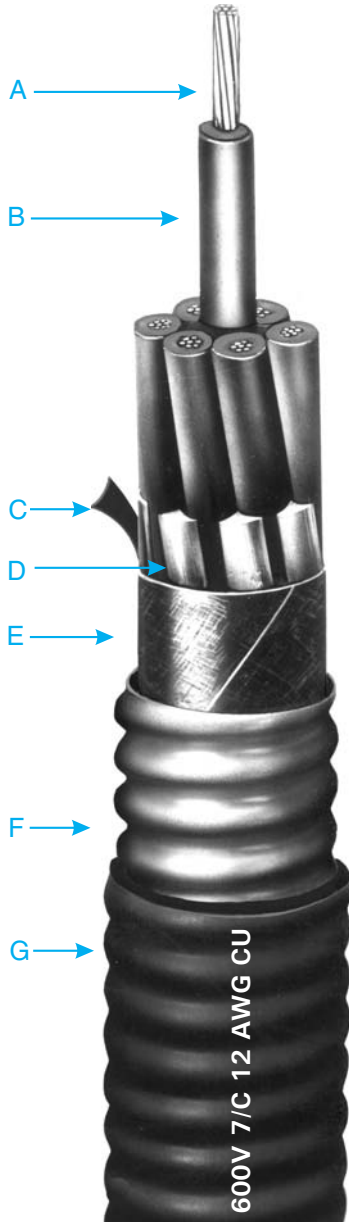

- A Bare, Stranded Copper Conductors
- B X-Olene Insulation - Color Coded for Identification
- C Marker Tape
- D Non-hygroscopic Fillers, as necessary
- E Binder Tape
- F Impervious, Continuous, Corrugated, Aluminum C-L-X Sheath
- G Black Okoseal Jacket

Insulation

X-Olene[®] is Okonite's trade name for its chemically cross-linked polyethylene, with high dielectric strength.

Color Coding

Conductors are color coded using base colors and tracers in accordance with the Conductor Identification Table on the back of this Data Sheet.

Assembly and Coverings

The individual conductors are cabled together with non-hygroscopic fillers and a binder tape overall. The C-L-X sheath exceeds the grounding conductor requirements of Table 250.122 of the NEC and UL 1569.

The impervious, continuous, corrugated aluminum C-L-X sheath provides complete protection against moisture, liquids and gases and has excellent mechanical strength. For direct burial in the ground, embedment in concrete, or for areas subjected to corrosive atmospheres, the C-L-X sheath is protected with a low temperature black Okoseal[®] (PVC) jacket.

Applications

C-L-X Type MC cables with the impervious, continuous, corrugated aluminum sheath are recommended as an economical alternate to a wire in conduit system.

They are authorized for use on services, feeders and branch circuits for power, lighting, control and signaling circuits in accordance with Articles 330 and 725 of the NEC.

C-L-X Type MC cables may be installed indoors or outdoors, in wet or dry locations, as open runs of cable secured to supports spaced not more than six feet apart, in cable tray, as aerial cable on a messenger, in any approved raceway, direct burial, or encased in concrete.

C-L-X Type MC cables are also approved for use in Class I & II, Division 2, Class III, Divisions 1 and 2, and Class I, Zone 2 hazardous locations per NEC articles 501, 502, 503 and 505; in Zone 2, Class II Div 2, Class III Div 1 and Class III Div 2 per CEC.

Specifications

Conductors: Bare soft annealed copper, Class B stranding per ASTM B-8.

Insulation: X-Olene per ICEA S-73-532/ NEMA WC57 and UL 44, Listed UL Type XHHW-2. Meets MIL-DTL-1377H, section 4.8.4.1.2 cold bend at -66°C and ASTM D746-04 brittle point at -76°C.

Conductor Identification: Base Colors and tracers.

Assembly: Per UL 1569 with binder tape overall.

Sheath: Close fitting, impervious, continuous, corrugated aluminum C-L-X per UL 1569.

Exceeds grounding conductor requirements of NEC Table 250.122.

Jacket: Black Okoseal (PVC) per UL requirements for Type MC Cables. Meets ASTM D746-04 brittle point at -40°C.

Product Features

- UL Listed as Type MC cable and Marine Shipboard Cable, E38916 (UL 1596) and E137931 (UL 1309).
- UL Listed for cable tray use, direct burial and sunlight resistant.
- UL 1309 (CWCMC) listed & UL classified in accord with IEEE 1580 as Marine Shipboard Cable rated 600/1000 volts.
- CSA C22.2 No. 123 listed as RA90, FT4 and LTGG (-40°C).
- Passes the IEEE 383-1974 and IEEE 1202 vertical tray flame tests.
- Passes the 210,000 BTU/hr ICEA T-29-520 Vertical Tray Flame Test.
- Complete pre-packaged, factory-tested wiring system — color coded.
- C-L-X cables are quality control inspected to meet or exceed applicable UL standards.
- 90°C continuous operating temperature in all types of installations
- 130°C emergency rating
- 250°C short circuit rating.
- Good EMI shielding characteristics.
- Impervious, continuous metallic sheath excludes moisture, gases and liquids.
- Lower installed system cost than conduit or EMT systems.
- Provides excellent grounding safety
- Excellent compression and impact resistance.
- Continuous long lengths.
- Installation temperature of -40°C or °F.
- UL and American Bureau of Shipping Type approved as CWCMC Type MC.
- CSA Type RA90 complies with CEC Zone 2, Class II Div 2, Class III Div 1, Class III Div 2 Hazardous Locations.

C-L-X Type MC (XHHW-2)



Product Data Section 4: Sheet 14

600V Control Cable—Aluminum Sheath

600/1000V Marine Cable

Multiple Copper Conductors/90°C Wet or Dry Rating

For Cable Tray Use - Sunlight Resistant - For Direct Burial

Catalog Number	Conductor Size AWG	Number of Conductors	Insulation Thickness - mils	Core O.D. - Inches	Core O.D. - mm	C-L-X O.D. - Inches	C-L-X O.D. - mm	Jacket Thickness - mils	Jacket Thickness - mm	Approx. O.D. - Inches	Approx. O.D. - mm	Cross-Sectional Area (sq. in.) †	Approx. Net Weight lbs./1000'	Approx. Ship Weight lbs./1000'	90°C Wet or Dry (1)	75°C Wet	NEC Ampacity			
546-31-3002	14(7X) (2.08mm ²)	2	0.28	7.1	0.49	12.3	50	1.27	0.60	15.1	0.28	142	174	15	15					
▲ 546-31-3003		3	0.30	7.6	0.49	12.4			0.60	15.2	0.32	153	185	15	15					
▲ 546-31-3004		4	0.33	8.4	0.53	13.5			0.64	16.3	0.36	181	214	15	15					
▲ 546-31-3005		5	0.37	9.4	0.58	14.7			0.69	17.5	0.41	210	242	15	15					
▲ 546-31-3007		7	0.41	10.4	0.62	15.7			0.73	18.5	0.46	254	309	15	14					
▲ 546-31-3009		9	0.50	12.7	0.71	18.0			0.82	20.8	0.57	308	363	15	14					
*▲ 546-31-3012		12	0.57	14.4	0.80	20.3			0.91	23.1	0.71	381	448	12	10					
*▲ 546-31-3019		19	0.69	17.5	0.93	23.6			1.04	26.4	0.84	537	604	12	10					
*▲ 546-31-3037		37	0.96	24.4	1.24	31.5			1.35	34.3	1.43	946	1036	10	8					
546-31-3082		12(7X) (3.31mm ²)	2	0.31	7.8	0.53			13.5	50	1.27	0.64	16.3	0.32	164	196	20	20		
▲ 546-31-3083			3	0.34	8.6	0.53			13.5			0.64	16.3	0.32	189	221	20	20		
▲ 546-31-3084			4	0.38	9.6	0.58			14.7			0.69	17.5	0.38	226	258	20	20		
▲ 546-31-3085	5		0.42	10.6	0.62	15.7	0.73	18.5	0.42			262	317	20	20					
▲ 546-31-3087	7		0.47	11.9	0.67	17.0	0.78	19.8	0.48			324	379	20	17					
▲ 546-31-3089	9		0.56	14.2	0.80	20.3	0.91	23.1	0.65			405	472	20	17					
*▲ 546-31-3092	12		0.65	16.5	0.89	22.6	0.99	25.4	0.79			503	570	15	12					
*▲ 546-31-3099	19		0.78	19.8	1.02	25.9	1.13	28.7	1.00			721	801	15	12					
*▲ 546-31-3117	37		1.08	27.4	1.37	34.8	1.48	37.6	1.72			1301	1444	12	10					
546-31-3162	10(7X) (5.26mm ²)		2	0.36	9.1	0.58	14.7	50	1.27			0.69	17.5	0.38	202	234	30	30		
▲ 546-31-3163			3	0.39	9.9	0.58	14.7					0.69	17.5	0.38	238	270	30	30		
▲ 546-31-3164			4	0.44	11.1	0.67	17.0					0.78	19.8	0.48	297	352	30	28		
546-31-3165		5	0.48	12.2	0.71	18.0	0.82			20.8	0.53	348	403	30	28					
▲ 546-31-3167		7	0.54	13.7	0.75	19.1	0.86			21.8	0.58	436	491	28	24					
546-31-3169		9	0.65	16.5	0.89	22.6	1.00			25.4	0.79	544	611	28	24					
546-31-3172*		12	0.74	18.8	0.97	24.6	1.08			27.4	0.85	684	751	20	17					

* These items are not CSA listed. CSA listing available as special order.

Visit Okonite's web site, www.okonite.com for the most up to date dimensions.

▲ **Authorized Stock Item** - Available from our Service Centers.

Copper or Bronze C-L-X - is available on special order.

† **Cross-sectional** area for calculation of cable tray fill in accordance with NEC Section 392.22.

Jackets - Optional jacket types available - consult local sales office.

(1) Ampacities

Ampacities are based on Table 310.15(B)(16) of the National Electrical Code for XHHW-2 conductors rated 90°C, in a multi-conductor cable, at an ambient temperature of 30°C (86F). The 75°C column is provided for additional information.

The ampacities shown apply to open runs of cable, installation in any approved raceway, direct burial in the earth, or as aerial cable on a messenger. Derating for more than three current carrying conductors within the cable is in accordance with NEC Section 310.15(B)(3)(a).

The ampacities shown also apply to cables installed in cable tray in accordance with NEC Section 392.80.

C-L-X Type MC (XHHW-2)



Product Data Section 4: Sheet 14

600V Control Cable — Aluminum Sheath

600/1000V Marine Cable

Multiple Copper Conductors /90°C Wet or Dry Rating

For Cable Tray Use - Sunlight Resistant - For Direct Burial

Conductor Color Coding Sequence

Conductor Number	Base Color	Tracer Color
1	Black	
2	Red	
3	Blue	
4	Orange	
5	Yellow	
6	Brown	
7	Red	Black
8	Blue	Black
9	Orange	Black
10	Yellow	Black
11	Brown	Black
12	Black	Red
13	Blue	Red
14	Orange	Red
15	Yellow	Red
16	Brown	Red
17	Black	Blue
18	Red	Blue
19	Orange	Blue
20	Yellow	Blue
21	Brown	Blue
22	Black	Orange
23	Red	Orange
24	Blue	Orange
25	Yellow	Orange
26	Brown	Orange
27	Black	Yellow
28	Red	Yellow
29	Blue	Yellow
30	Orange	Yellow
31	Brown	Yellow
32	Black	Brown
33	Red	Brown
34	Blue	Brown
35	Orange	Brown
36	Yellow	Brown
37	Black	

Color Coding per ICEA
Method 1, E-2

Special Order: Any or all of the following conductors may be added when specifically requested by the customer to meet his specific application requirements. These conductor codings comply with UL and NEC requirements.

<u>Purpose</u>	<u>Base Color</u>	<u>Tracer Color</u>
Equipment Grounding	Uninsulated Green Green	1 or more continuous yellow stripes
Grounded	White White White White White White	Black continuous stripe Red continuous stripe Blue continuous stripe Orange continuous stripe Brown continuous stripe Numeric printing



C-L-X[®] Type MC-HL (XHHW-2)

600V Control Cable — Aluminum Sheath

600/1000V Marine Cable

Multiple Copper Conductors/90°C Wet or Dry Rating

For Cable Tray Use - Sunlight Resistant - For Direct Burial

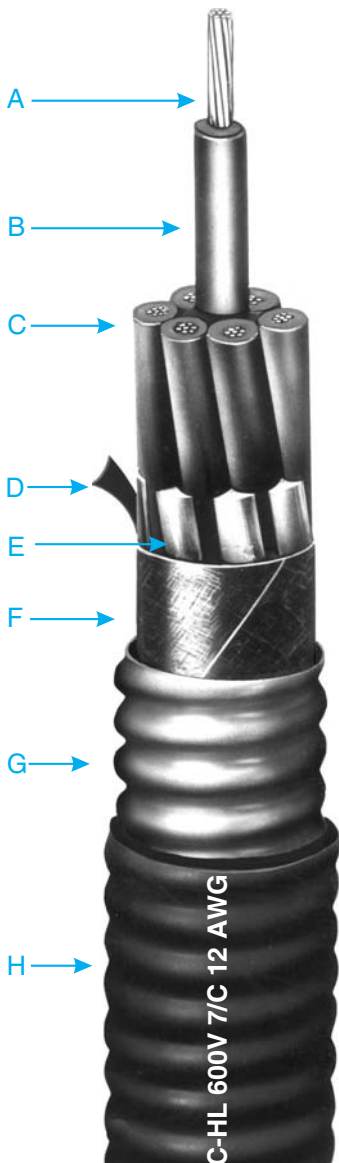

- A Bare, Stranded Copper Conductors
- B X-Olene Insulation - Color Coded for Identification
- C Stranded copper, green insulated grounding conductor
- D Marker Tape
- E Non-hygroscopic Fillers, as necessary
- F Binder Tape
- G Impervious, Continuous, Corrugated, Aluminum C-L-X Sheath
- H Black Okoseal Jacket

Insulation

X-Olene[®] is Okonite's trade name for its chemically cross-linked polyethylene, with high dielectric strength.

Color Coding

Conductors are color coded using base colors and tracers in accordance with the Conductor Identification Table on the back of this Data Sheet.

Assembly and Coverings

The individual conductors are cabled together with non-hygroscopic fillers and a binder tape overall. The C-L-X sheath exceeds the grounding conductor requirements of Table 250.122 of the NEC and UL1569.

The impervious, continuous, corrugated aluminum C-L-X sheath provides complete protection against moisture, liquids and gases and has excellent mechanical strength. For direct burial in the ground, embedment in concrete, or for areas subjected to corrosive atmospheres, the C-L-X sheath is protected with a low temperature black Okoseal[®] (PVC) jacket.

Applications

C-L-X Type MC cables with the impervious, continuous, corrugated aluminum sheath are recommended as an economical alternate to a wire in conduit system.

They are authorized for use on services, feeders and branch circuits for power, lighting, control and signaling circuits in accordance with Articles 330 and 725 of the NEC.

C-L-X Type MC-HL cables may be installed indoors or outdoors, in wet or dry locations, as open runs of cable secured to supports spaced not more than six feet apart, in cable tray, as aerial cable on a messenger, in any approved raceway, direct burial, or encased in concrete. C-L-X Type MC-HL cables are also approved for Classes I, II, and III Division 1 and 2 and Class I, Zones 1 and 2 hazardous locations per NEC Articles 501, 502, and 503 and UL 2225; in Zone Class II Div 2, Class III Div 1 and Class III Div 2 per CEC.

Specifications

Conductors: Bare soft annealed copper, Class B stranding per ASTM B-8.

Insulation: X-Olene per ICEA S-73-532 and UL 44, Listed UL Type XHHW-2. Meets MIL-DTL-1377H, section 4.8.4.1.2, cold bend at -66°C and ASTM D746-04 brittle point at -40°C.

Conductor Identification: Base Colors and tracers.

Grounding Conductor: Green insulated stranded copper per ASTM B-8, Class B. Meets or exceeds requirements of NEC Table 250.122.

Assembly: Per UL 1569 with binder tape overall.

Sheath: Close fitting, impervious, continuous, corrugated aluminum C-L-X per UL 1569.

Exceeds grounding conductor requirements of NEC Table 250.122.

Jacket: Black Okoseal (PVC) per UL requirements for Type MC-HL Cables. Meets ASTM D746-04 brittle point at -40°C.

Product Features

- UL Listed as Type MC-HL cable and Marine Shipboard Cable, E38916 (UL 1569) and E137931 (UL1309).
- UL Listed for cable tray use, direct burial and sunlight resistant.
- UL 1309 listed (CWCMC) & UL classified in accord with IEEE 1580 as Marine Shipboard Cable rated 600/1000V
- CSA C22.2 No. 123 listed as RA90, FT4, HL and LTGG (-40°C).
- Passes the IEEE 383-1974 and IEEE 1202 vertical tray flame tests.
- Passes the 210,000 BTU/hr ICEA T-29-520 Vertical Tray Flame Test.
- Complete pre-packaged, factory-tested wiring system — color coded.
- C-L-X cables are quality control inspected to meet or exceed applicable UL standards.
- 90°C continuous operating temperature in all types of installations.
- 130°C emergency rating
- 250°C short circuit rating.
- Good EMI shielding characteristics.
- Impervious, continuous metallic sheath excludes moisture, gasses and liquids.
- Lower installed system cost than conduit or EMT systems.
- Provides excellent grounding safety.
- Excellent compression and impact resistance.
- Continuous long lengths.
- Installation temperature of -40°C or °F.
- Complies with NEC Articles 501, 502 and 503 for hazardous locations.
- UL and American Bureau of Shipping listed as CWCMC Type MC-HL.
- CSA Type RA 90-HL complies with CEC Zone 1, Zone 2, Class II Div 2, Class III Div 1 and Class III Div 2 Hazardous Locations.

C-L-X Type MC-HL (XHHW-2)



Product Data Section 4: Sheet 15

600V Control Cable—Aluminum Sheath

600/1000V Marine Cable

Multiple Copper Conductors/90°C Wet or Dry Rating

For Cable Tray Use - Sunlight Resistant - For Direct Burial

Catalog Number	Conductor Size AWG	Number of Ungrounded	Green Insulated Grounding Conductor AWG	Core O.D. - Inches	Core O.D. - mm	C-L-X O.D. - Inches	C-L-X O.D. - mm	Jacket Thickness - mils	Jacket Thickness - mm	Approx. O.D. - Inches	Approx. O.D. - mm	Cross-Sectional Area (sq. in.) †	Approx. Net Weight lbs./1000	Approx. Ship Weight lbs./1000	90°C Wet or Dry (1)	75°C Wet NEC Ampacity							
▲ 546-31-3402	14(7X) (2.08mm ²)	2	#14 (7X)	0.30	7.6	0.49	12.4	50	1.27	0.60	15.2	0.28	163	202	15	15							
▲ 546-31-3406		6		0.41	10.4	0.62	15.8										0.73	18.5	0.42	267	347	15	14
▲ 546-31-3408		8		0.49	12.4	0.71	18.0										0.82	20.8	0.53	321	401	15	14
*▲ 546-31-3411		11		0.57	14.5	0.80	20.3																
*▲ 546-31-3418		18		0.69	17.5	0.93	23.6										1.04	26.4	0.85	554	634	12	10
*▲ 546-31-3436		36		0.97	24.6	1.24	31.5										1.35	34.3	1.43	948	1038	10	8
▲ 546-31-3452	12(7X) (3.31mm ²)	2	#12 (7X)	0.34	8.6	0.53	13.5	50	1.27	0.64	16.3	0.32	200	239	20	20							
▲ 546-31-3456		6		0.47	11.9	0.67	17.0										0.78	19.7	0.48	338	418	20	17
▲ 546-31-3458		8		0.56	14.2	0.80	20.3										0.91	23.1	0.65	426	506	20	17
*▲ 546-31-3461		11		0.65	16.5	0.89	22.6																
*▲ 546-31-3468		18		0.78	19.8	1.02	25.9										1.13	28.7	1.00	739	819	15	12
*▲ 546-31-3486		36		1.10	27.9	1.37	34.8										1.48	37.6	1.72	1302	1445	12	10
▲ 546-31-3502	10(7X) (5.26mm ²)	2	#10 (7X)	0.39	9.9	0.58	14.7	50	1.27	0.69	17.5	0.37	253	292	30	30							
▲ 546-31-3506		6		0.54	13.7	0.75	19.1										0.86	21.8	0.58	451	531	28	24
▲ 546-31-3508		8		0.65	16.5	0.89	22.6										1.00	25.4	0.79	568	648	28	24
*▲ 546-31-3511		11		0.75	19.1	0.97	24.6			1.08	27.4	0.92	704	784	20	17							

* These items are not CSA listed. CSA listing available as special order.

Visit Okonite's web site, www.okonite.com for the most up to date dimensions.

▲ **Authorized Stock Item** - Available from our Service Centers.

Copper Or Bronze C-L-X is available on special order.

† **Cross-sectional** area for calculation of cable tray fill in accordance with NEC Section 392.22.

Jacket - Optional jacket types available - consult local sales office.

(1) **Ampacities** are based on 310.15(B)(16) of the National Electrical Code for XHHW-2 conductors rated 90°C, in a multi-conductor cable, at an ambient temperature of 30°C (86°F). The 75°C column is provided for additional information.

The ampacities shown apply to open runs of cable, installation in any approved raceway, direct burial in the earth, or as aerial cable on a messenger. Derating for more than three current carrying conductors within the cable is in accordance with NEC Section 310.15(B)(3)(a).

The ampacities shown also apply to cables installed in cable tray in accordance with NEC Section 392.80.

C-L-X Type MC-HL (XHHW-2)

600V Control Cable — Aluminum Sheath

600/1000V Marine Cable

Multiple Copper Conductors /90°C Wet or Dry Rating

For Cable Tray Use - Sunlight Resistant - For Direct Burial



Product Data Section 4: Sheet 15

Conductor Color Coding Sequence

Ungrounded Conductor Number	Base Color	Tracer Color
1	Black	
2	Red	
3	Blue	
4	Orange	
5	Yellow	
6	Brown	
7	Red	Black
8	Blue	Black
9	Orange	Black
10	Yellow	Black
11	Brown	Black
12	Black	Red
13	Blue	Red
14	Orange	Red
15	Yellow	Red
16	Brown	Red
17	Black	Blue
18	Red	Blue
19	Orange	Blue
20	Yellow	Blue
21	Brown	Blue
22	Black	Orange
23	Red	Orange
24	Blue	Orange
25	Yellow	Orange
26	Brown	Orange
27	Black	Yellow
28	Red	Yellow
29	Blue	Yellow
30	Orange	Yellow
31	Brown	Yellow
32	Black	Brown
33	Red	Brown
34	Blue	Brown
35	Orange	Brown
36	Yellow	Brown
37	Black	

Color Coding per ICEA Method 1, E-2

Special Order: Any or all of the following conductors may be added when specifically requested by the customer to meet his specific application requirements. These conductor codings comply with UL and NEC requirements.

<u>Purpose</u>	<u>Base Color</u>	<u>Tracer Color</u>
Equipment Grounding	Uninsulated Green Green	1 or more continuous yellow stripes
Grounded	White White White White White White	Black continuous stripe Red continuous stripe Blue continuous stripe Orange continuous stripe Brown continuous stripe White stripe Numeric printing



Type P-OS

Type ITC/PLTC Instrumentation Cable

Single Pair or Triad - Overall Shield
300 Volts - 105°C Rating



For Cable Tray Use



- A Bare Stranded Copper Conductor
- B Okoseal Insulation
- C Twisted Pair/Triad
- D Tinned Stranded Copper Drain Wire
- E Aluminum/Polyester Tape
- F Rip Cord
- G Black Okoseal Jacket

Specifications

Conductors: Bare soft annealed copper, Class B, 7-strand concentric per ASTM B-8.

Insulation: Flame-retardant Okoseal® (PVC) per UL 13 and UL 2250, 15 mils nominal thickness, 105°C temperature rating.

Conductor Identification: Pigmented black and white in pairs, black, red and white in triads.

Assembly: Pair or triad assembled with left-hand lay.

Cable Shield: Aluminum/synthetic polymer tape overlapped to provide 100% coverage, and a 7-strand tinned copper drain wire, same size as conductor.

Jacket: Black, flame-retardant, low temperature Okoseal per UL 13 and UL 2250. A rip cord is laid longitudinally under the jacket to facilitate removal.

Classifications

UL Listed as ITC/PLTC — Instrument Tray Cable/Power Limited Tray Cable for use in accordance with Article 727 and Article 725 of the National Electrical Code.

These cables comply with UL 2250 and UL 13 for PLTC, CL2, and CL3.

Applications

Okonite type P-OS (Pair/Triad - Overall Shield) instrumentation cables are designed for use as instrumentation, process control, and computer cables in ITC non-classified or labeled circuits up to 150 volts and 5 amps (750VA) and in Class 2 or 3 Power-Limited circuits where shielding against external interference is required, but shielding against interference among groups is not required; indoors or outdoors; in wet or dry locations with conductor operating temperatures up to 105°C; in cable trays; in raceways; supported by a messenger wire. Suitable Class I, Division 2, Class II, Division 2, or Class III, Division 2 hazardous locations. Also for use

as Power-Limited fire protective signaling cable (FPL) per NEC Code 760.

The overall shield eliminates most of the static interference from the electric field radiated by power cables and other electrical equipment.

For dc service in wet locations, X-Olene® insulation is recommended.

Product Features

- Passes the UL 1581 & IEEE 383-1974 vertical tray flame tests.
- Sunlight resistant and oil resistant.
- Individual pairs or triads are color coded for simplified hook-up.
- Good noise rejection.
- Excellent weathering characteristics.
- OSHA Acceptable.
- Flexible, easy to handle and terminate.
- Twisted with 100% shield coverage to reduce electromagnetic noise pick-up.
- Suitable for low temperature installation of -40°C.

Type P-OS Type ITC/PLTC Instrumentation Cable

Single Pair or Triad - Overall Shield 300V - 105°C Rating
For Cable Tray Use



Product Data Section 5: Sheet 2

Okoseal Insulation 15 mils

Catalog Number	Conductor Size (AWG)	Number of Pairs	Number of Triads	Insulation Thickness (mils)	Jacket Thickness (mils)	Nominal Cable O.D. - (In.)	Cross-Sectional Area † (sq in)	Approx Net Weight (lbs/1000')	Approx Ship Weight (lbs/1000')
264-10-1101 264-15-1101	22	1	1	12	35	0.20 0.21	0.03 0.03	22 26	27 31
264-10-2201 264-15-2201	20	1	1	12		0.22 0.23	0.04 0.04	27 33	32 38
▲ 264-10-3301 ▲ 264-15-3301	18	1	1	15		0.23 0.24	0.05 0.05	35 43	40 48
▲ 264-10-4401 264-10-4901* ▲ 264-15-4401	16	1	1	15		0.25 0.25 0.26	0.05 0.05 0.06	47 47 58	52 52 59

* Tinned Copper Conductor

ELECTRICAL SPECIFICATIONS Per UL Standard 13 & 2250	
Conductor Resistance, nominalohms/1000 ft. @20°C
22 AWG 16.5
20 AWG 10.3
18 AWG 6.5
16 AWG 4.1
Insulation Test Voltage (spark test)5000 Volts ac
Dielectric Test Voltage 1500 Volts ac for 15 sec.
Insulation Resistance Constant @60°F minimum (natural material typical value)2000 Megohms-1000 ft.
Loop Resistance, nominal (2 conductor) ohms-1000 ft @20°C	
22 AWG 33.0
20 AWG 20.8
18 AWG 13.0
16 AWG 8.2
Mutual Capacitance (PF/ft.)*	
#22 34
#20 37
#18 41
#16 44

*Typical Value

▲ Authorized Stock Item: Available from our Customer Service Center.

† Cross-sectional area for calculation of cable tray fill in accordance with NEC Section 392-22

Length Tolerance: Cut lengths of 1000 feet or longer are subject to a tolerance of ± 10%; less than 1000 feet ± 15%.





C-L-X[®] Type P-OS

Type ITC/PLTC Armored Instrumentation Cable

Single Pair or Triad - Overall Shield

300 Volts - 105°C Rating

For Cable Tray Use

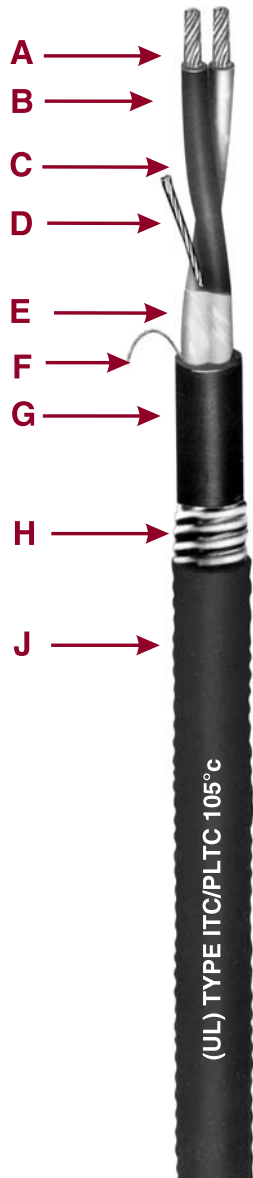

- A Bare Stranded Copper Conductor
- B Okoseal Insulation
- C Twisted Pair/Triad
- D Tinned Stranded Copper Drain Wire
- E Aluminum/Polyester Tape
- F Rip Cord
- G Inner Black Okoseal Jacket
- H Impervious, Continuous Corrugated Aluminum C-L-X Sheath
- J Outer Black Okoseal Jacket

Specifications

Conductors: Bare soft annealed copper, Class B, 7-strand concentric per ASTM B-8.

Insulation: Flame-retardant Okoseal[®] (PVC) per UL Standard 13 and UL 2250, 15 mils nominal thickness, 105°C temperature rating.

Conductor Identification: Pigmented black and white in pairs, black, red and white in triads.

Assembly: Pair or triad assembled with left-hand lay.

Cable Shield: Aluminum/Polyester tape overlapped to provide 100% coverage, and a #18 AWG, 7-strand tinned copper drain wire.

Inner Jacket: Black, flame-retardant Okoseal per UL 13 and UL Standard 2250. A rip cord is laid longitudinally under the jacket to facilitate removal.

C-L-X Sheath: A close-fitting, impervious, continuously welded and corrugated aluminum sheath provides complete protection against moisture, liquids, and gases, has excellent mechanical strength and provides equipment grounding through the sheath.

Outer Jacket: Black, flame-retardant Okoseal per UL 13 and UL Standard 2250.

Classifications

UL Listed as ITC/PLTC — Instrument Tray Cable/Power Limited Tray Cable for use in accordance with Article 727 and Article 725 of the National Electrical Code.

These cables comply with UL 2250 and UL 13 for PLTC, CL2 and CL3.

Applications

Okonite Type C-L-X P-OS (Pair/Triad - Overall Shield) instrumentation cables are designed for use as instrumentation, process control, and computer cables in ITC non-classified or labeled circuits up to 150 volts and 5 amps (750VA) and in Class 2 or 3 Power-Limited circuits where shielding against external interference is required, but shielding against interference among groups is not required; indoors or outdoors; in wet or dry locations with conductor operating temperatures up to 105°C; in cable trays; in raceways; supported by a messenger wire; under raised floors; for direct burial. Suitable Class I, Division 2, and Class I, Zone 2 Class II, Division 2, or Class III, Division 2 and Class I, Zone 2 hazardous locations. Also for use as Power-Limited fire protective signaling cable (FPL) per NEC Code 760. The C-L-X sheath

provides physical protection against mechanical damage. It may be installed in both exposed and concealed work, secured to supports not greater than 6 feet apart.

The overall shield eliminates most of the static interference from the electric field radiated by power cables and other electrical equipment.

For dc service in wet locations, X-Olene[®] insulation is recommended.

Product Features

- Passes the UL 1581, IEEE 383-1974, and IEEE 1202 vertical tray flame tests.
- Passes the 210,000 BTU/hr vertical tray flame test per ICEA T-29-520.
- UL listed as sunlight resistant.
- UL listed for direct burial.
- Complete pre-packaged, factory-tested wiring system-color coded.
- C-L-X enclosure permits installation in cable tray containing light and power cables without a barrier separator.
- Individual pairs or triads are color coded for simplified hook-up.
- Maximum noise rejection.
- Impervious, continuous sheath excludes moisture, gases and liquids.
- C-L-X sheath exceeds equipment grounding conductor requirements of NEC Article 250-118.
- Excellent compression and impact resistance.
- Lower installed system cost than conduit or EMT systems.
- OSHA Acceptable.
- Meets API Standards 14F and 14FZ.
- Suitable for low temperature installation of -40°C.

C-L-X Type P-OS

Type ITC/PLTC Armored Instrumentation Cable

Single Pair or Triad - Overall Shield 300V - 150°C Rating
For Cable Tray Use

Product Data

Section 5: Sheet 3



Conductors: 16 AWG
Okoseal Insulation: 15 mils

Catalog Number	Number of Pairs	Number of Triads	Inner Jacket Thickness-mils	Inner Jacket Nominal O.D. - Inches	Outer Jacket - (mils)	C-L-X O.D. - Inches	Nominal Cable O.D. - Inches	Cross-Sectional Area † (sq in)	Approx Net Weight (lbs/1000')	Approx Ship Weight (lbs/1000')
▲ 564-10-3401	1	1	35	.26	50	.43	.54	.25	134	173
▲ 564-15-3401			35	.28	50	.43	.54	.25	155	194

ELECTRICAL SPECIFICATIONS Per UL Standard 13 & 2250

Conductor Resistance, nominalohms/1000 ft. @20°C
16 AWG..... 4.1
Insulation Test Voltage (spark test).....5000 Volts ac
Dielectric Test Voltage..... 1500 Volts
Insulation Resistance Constant @60°F minimum
(natural material typical value).....2000 Megohms-1000 ft.
Loop Resistance, nominal (2 conductor) ohms-1000 ft @20°C
16 AWG..... 8.2
Mutual Capacitance, typical76 PF/ft.

▲ **Authorized Stock Item:** Available from our Customer Service Center

† **Cross-sectional** area for calculation of cable tray fill in accordance with NEC Section 392.22.

Jackets- Optional jacket types available - consult local sales office.

Copper or bronze C-L-X available on special order.

To order C-L-X Type P-OS without the outer Okoseal jacket, change the sixth digit of the catalog number from 3 to 1, for example to order 1 pr. 16 AWG with a bare aluminum C-L-X, the catalog number would be 564-10-1401.

C-L-X products manufactured in the United States under license granted by Kabelmetal of Hanover, Germany.

Length Tolerance: Cut lengths of 1000 feet or longer are subject to a tolerance of ± 10%; less than 1000 feet ± 15%.





Type SP-OS

Type ITC/PLTC Instrumentation Cable

Multiple Shielded Pairs or Triads - Overall Shield
300 Volts - 105°C Rating



For Cable Tray Use

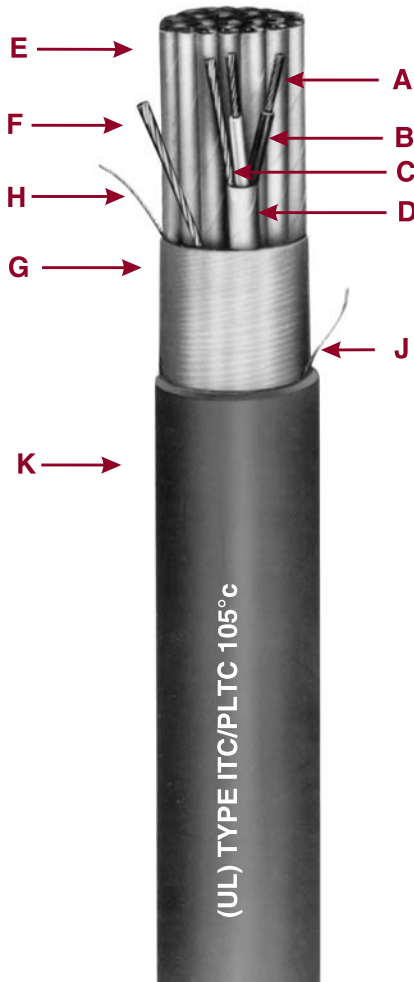

- A** Bare Stranded Copper Conductor
- B** Okoseal Insulation
- C** Tinned Stranded Copper Group Drain Wire
- D** Aluminum/Polyester Tape
- E** Twisted, Shielded Pairs/Triads
- F** Tinned Stranded Copper Drain Wire
- G** Aluminum/Polyester Tape
- H** Communication Wire
- J** Rip Cord
- K** Black Okoseal Jacket

Specifications

Conductors: Bare soft annealed copper, Class B, 7-strand concentric per ASTM B-8.

Insulation: Flame-retardant Okoseal® (PVC) per UL 13 and 2250, 15 mils nominal thickness, 105°C temperature rating.

Conductor Identification: Pigmented black and white in pairs, black, red and white in triads; white conductor numerically printed for group identification.

Group Shield: Aluminum/Polyester tape overlapped to provide 100% coverage, and a 7-strand tinned copper drain wire, two sizes smaller than the conductor. All group shields are completely isolated from each other.

Communications Wire: 22 AWG, solid, bare copper conductor, 12 mils nominal flame-retardant Okoseal insulation, 105°C rating.

Assembly: Pairs or triads assembled with a left-hand lay. Flame-retardant, non-wicking fillers included where required to provide a round cable.

Cable Shield: Aluminum/Polyester tape overlapped to provide 100% coverage, and a 7-strand tinned copper drain wire, same size as conductor.

Jacket: Black, flame-retardant, low temperature Okoseal per UL Subject 13 and 2250. A rip cord is laid longitudinally under the jacket to facilitate removal.

Classifications: UL Listed as ITC/PLTC - Instrument Tray Cable/Power Limited Tray Cable for use in accordance with Article 727 and Article 725 of the National Electrical Code.

Cables comply with UL 2250 and UL 13 for PLTC, CL2 and CL3.

Applications

Okonite® Type SP-OS (Pair/triad - Individual and Overall Shield) instrumentation cables are designed for use as instrumentation, process control, in ITC non-classified or labeled circuits up to 150 volts and 5 amps (750VA) and in Class 2 or 3 Power-Limited circuits where maximum shielding against external interference is required, as well as shielding among groups, particularly where the cable may be

subject to abnormally high current or voltage interference; indoors or outdoors; in wet or dry locations with conductor operating temperatures up to 105°C; in cable trays; in raceways; supported by a messenger wire; under raised floors. Suitable Class I, Division 2, Class II, Division 2, or Class III, Division 2 hazardous locations. Also for use as Power-Limited fire protective signaling cable (FPL) per NEC Code 760.

The isolated individual shields over each pair, when properly grounded, prevent crosstalk or capacitive coupling between adjacent pairs which occurs with ac signals, particularly the pulse type.

The overall shield eliminates most of the static interference from the electrical field radiated by power cables and other electrical equipment.

For dc service in wet locations, X-Olene® insulation is recommended.

Product Features

- Passes the UL 13 and IEEE 383-1974 vertical tray flame tests.
- Passes IEEE 1202 vertical tray flame test (8 pr #18 and 4 pr #16 & larger).
- Sunlight & oil resistant.
- Individual pairs or triads are completely isolated.
- 100% shield coverage for reduced electromagnetic noise pick-up.
- Good external noise rejection.
- Excellent weathering characteristics.
- OSHA Acceptable.
- Flexible, easy to handle and terminate.
- Communication wire included in each cable for voice communication during installation or instrument calibration.
- Suitable for low temperature installation of -40°C.

Type SP-OS Type ITC/PLTC Instrumentation Cable



Product Data Section 5: Sheet 13

Multiple Shielded Pairs or Triads - Overall Shield 300V - 105°C Rating
For Cable Tray Use

Okoseal Insulation: 15 mils

Catalog Number	Strand Size (AWG)	Insulation Thickness (mils)	Number of Pairs	Number of Triads	Jacket Thickness-mils	Nominal Cable O.D. - inches	Cross-Sectional Area † (sq in)	Approx Net Weight (lbs/1000')	Approx Ship Weight (lbs/1000')	
261-10-2202	20(7X)	15	2	40	0.35	0.10	63	74		
261-10-2204			4	50	0.42	0.15	103	126		
261-10-2206			6	50	0.51	0.20	138	161		
261-10-2208			8	50	0.53	0.25	169	193		
261-10-2210			10	60	0.66	0.34	219	258		
261-10-2212			12	60	0.66	0.37	248	287		
261-10-2216			16	60	0.76	0.45	311	350		
261-10-2220			20	60	0.82	0.53	374	413		
261-10-2224			24	70	0.90	0.69	457	521		
261-10-2236			36	70	1.06	0.88	632	696		
261-10-2250			50	70	1.23	1.19	845	951		
261-15-2204			4	50	0.48	0.18	126	149		
261-15-2208			8	50	0.62	0.30	212	236		
261-15-2212			12	60	0.77	0.47	314	353		
261-15-2216			16	60	0.79	0.49	397	436		
261-15-2224			24	70	0.99	0.77	587	651		
261-15-2236			36	70	1.11	0.97	825	905		
261-10-3302			18(7X)	15	2	50	0.38	0.11	89	112
▲ 261-10-3304					4	50	0.47	0.19	133	156
261-10-3306					6	50	0.57	0.25	181	205
▲ 261-10-3308	8	50			0.56	0.29	223	247		
261-10-3310	10	60			0.73	0.42	289	328		
▲ 261-10-3312	12	60			0.69	0.44	330	369		
261-10-3316	16	60			0.83	0.54	417	456		
261-10-3320	20	70			0.94	0.69	523	587		
▲ 261-10-3324	24	70			0.98	0.85	614	678		
▲ 261-10-3336	36	70			1.14	1.11	861	941		
261-10-3350	50	80			1.42	1.58	1188	1294		
▲ 261-15-3304	4	50			0.52	0.23	165	188		
▲ 261-15-3308	8	60			0.68	0.41	301	340		
▲ 261-15-3312	12	60			0.83	0.57	425	464		
261-15-3316	16	60			0.89	0.62	543	607		
261-15-3324	24	70			1.10	0.95	804	884		
261-15-3336	36	70			1.24	1.21	1143	1249		
▲ 261-10-4402	16(7X)	15			2	50	0.43	0.17	116	130
▲ 261-10-4404					4	50	0.51	0.23	179	203
261-10-4406					6	60	0.66	0.34	260	299
▲ 261-10-4408			8	60	0.68	0.40	323	362		
261-10-4410			10	60	0.82	0.53	397	436		
▲ 261-10-4412			12	60	0.81	0.57	456	520		
▲ 261-10-4416			16	70	0.94	0.75	600	664		
261-10-4420			20	70	1.06	0.88	729	809		
▲ 261-10-4424			24	70	1.10	1.07	860	940		
261-10-4436			36	80	1.37	1.47	1250	1356		
261-10-4450			50	80	1.57	1.93	1687	1830		
261-15-4404			4	50	0.55	0.26	227	251		
▲ 261-15-4408			8	60	0.74	0.48	418	457		
▲ 261-15-4412			12	70	0.93	0.74	615	679		
261-15-4416			16	70	1.02	0.82	788	852		
261-15-4424			24	80	1.27	1.27	1167	1273		
261-15-4436			36	80	1.43	1.61	1668	1784		

ELECTRICAL SPECIFICATIONS Per UL Subject 13 & 2250	
Conductor Resistance, nominalohms/1000 ft. @20°C
20 AWG 10.4
18 AWG 6.5
16 AWG 4.1
Insulation Test Voltage (spark test)5000 Volts ac
Dielectric Test Voltage1500 Volts ac for 15 sec.
Insulation Resistance Constant @60°F, minimum (natural material typical value) 2,000 Megohms-1000 ft.
Loop Resistance, nominal (2 conductor) ohms-1000 ft @20°C	
20 AWG 20.8
18 AWG 13.0
16 AWG 8.2
Mutual Capacitance (PF/ft.)*	
20 AWG 59
18 AWG 68
16 AWG 76
*Typical Value	

▲ Authorized Stock Item: Available from our Customer Service Center.

† Cross-sectional area for calculation of cable tray fill in accordance with NEC Section 392.22

Length Tolerance: Cut lengths of 1000 feet or longer are subject to a tolerance of ± 10%; less than 1000 feet ± 15%.



THE OKONITE COMPANY

Ramsey, New Jersey 07446



C-L-X[®] Type SP-OS

Type ITC/PLTC Armored Instrumentation Cable

Multiple Shielded Pairs or Triads - Overall Shield

300 Volts - 105°C Rating

For Cable Tray Use

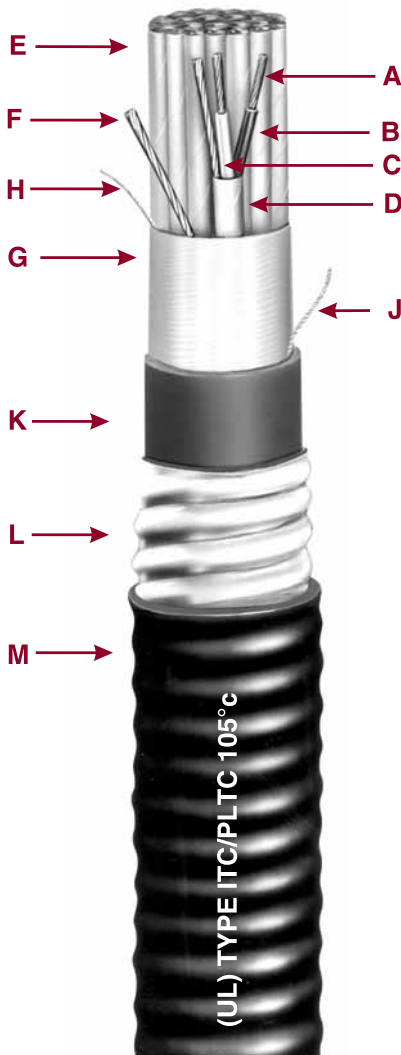

- A Bare Stranded Copper Conductor
- B Okoseal Insulation
- C Tinned Stranded Copper Group Drain Wire
- D Aluminum/Polyester
- E Twisted, Shielded Pairs/Triads
- F Communication Wire
- G Aluminum/Polyester
- H Tinned Stranded Copper Drain Wire
- J Rip Cord
- K Inner Black Okoseal Jacket
- L Impervious, Continuous, Corrugated Aluminum C-L-X Sheath
- M Outer Black Okoseal Jacket

Specifications

Conductors: Bare soft annealed copper, Class B, 7-strand concentric per ASTM B-8.

Insulation: Flame-retardant Okoseal[®] (PVC) per UL 13 and 2250, 15 mils nominal thickness, 105°C temperature rating.

Conductor Identification: Pigmented black and white in pairs, black, red and white in triads; white conductor numerically printed for group identification.

Group Shield: Aluminum/Polyester tape overlapped to provide 100% coverage, and a 7-strand tinned copper drain wire, two sizes smaller than the conductor. All group shields are completely isolated from each other.

Communications Wire: 22 AWG, solid, bare copper conductor, 12 mils nominal flame-retardant Okoseal insulation, 105°C temperature rating.

Assembly: Pairs or triads assembled with left-hand lay. Flame-retardant, non-wicking fillers included where required to provide a round cable.

Cable Shield: Aluminum/Polyester tape overlapped to provide 100% coverage, and a 7-strand tinned copper drain wire, same size as conductor.

Inner Jacket: Black, flame-retardant, low temperature Okoseal per UL 13 and 2250. A rip cord is laid longitudinally under the jacket to facilitate removal.

C-L-X Sheath: A close-fitting, impervious, continuously welded and corrugated, aluminum sheath provides complete protection against moisture, liquids, and gases, has excellent mechanical strength, and provides equipment grounding through the sheath.

Outer Jacket: Black, flame-retardant, low temperature Okoseal per UL 13 and 2250.

Classifications: UL Listed as ITC/PLTC - Instrument Tray Cable/Power Limited Tray Cable for use in accordance with Article 727 and Article 725 of the National Electrical Code.

Cables comply with UL 2250 and UL 13 for PLTC, CL2 and CL3.

Applications

C-L-X Type SP-OS (Pair/triad - Individual and Overall Shield) instrumentation cables are designed for use as instrumentation, process control, in ITC non-classified or labeled circuits up to 150 volts and 5 amps (750VA) and in Class 2 or 3 Power-Limited circuits where maximum shielding against external interference is required, as well as shielding among groups, particularly where the cable may be subject to abnormally high current or voltage interference; indoors or outdoors; in wet or dry locations with conductor operating temperatures up to 105°C; in cable trays; in raceways; supported by a

messenger wire; under raised floors or direct burial. Suitable in Class I & II, Division 2 or Class III, Division 2 and Class I, Zone 2 hazardous locations. Also for use as Power-Limited fire protective signaling cable (FPL) per NEC Code 760. It may be installed in both exposed and concealed work, secured to supports not greater than 6 feet apart.

The isolated individual shields over each pair, when properly grounded, prevent crosstalk or capacitive coupling between adjacent pairs which occurs with ac signals, particularly the pulse type.

The overall shield eliminates most of the static interference from the electric field radiated by power cables and other electrical equipment. The C-L-X sheath provides physical protection against mechanical damage as well as complete protection against moisture or gases entering the cable.

For dc service in wet locations X-Olene[®] insulation is recommended.

Product Features

- Passes the UL 13, IEEE 383-1974 vertical tray flame tests.
- Passes the IEEE 1202 vertical tray flame test (2 pr #18 AWG and larger).
- Passes the 210,000 BTU/hr vertical tray flame test per ICEA T-29-520.
- UL listed for direct burial (2 PR #20 AWG and larger)
- Complete pre-packaged, factory-tested wiring system-color coded.
- C-L-X enclosure permits installation in cable tray containing light and power cables without a barrier separator.
- Individual pairs or triads are completely isolated.
- Impervious, continuous sheath excludes moisture, gases and liquids.
- C-L-X sheath exceeds equipment grounding conductor requirements of NEC Article 250-118.
- Lower installed system cost than conduit or EMT systems.
- Meets API Standards 14F & 14FZ.
- Suitable for low temperature installation to -40°C.

C-L-X Type SP-OS Type ITC/PLTC Armored Instrumentation Cable



Product Data Section 5: Sheet 14

Multiple Shielded Pairs or Triads - Overall Shield 300V - 105°C Rating
For Cable Tray Use

Okoseal Insulation: 15 mils

Catalog Number	Strand Size (AWG)	Number of Pairs	Number of Triads	Inner Jacket Thickness - mils	Nominal Core O.D. (In.)	C-L-X O.D. (In.)	Outer Jacket mils	Nominal Cable O.D. - (In.)	Cross-Sectional Area † (sq in)	Approx Net Weight (lbs/1000')	Approx Ship Weight (lbs/1000')
561-10-3202	20(7X)	2	40	0.36	0.58	50	0.69	.37	198	217	
561-10-3204		4	50	0.43	0.62	50	0.73	.42	234	314	
561-10-3206		6	50	0.48	0.71	50	0.82	.53	286	366	
561-10-3208	20(7X)	8	50	0.53	0.75	50	0.86	.58	317	397	
561-10-3210		10	50	0.57	0.80	50	0.91	.65	393	473	
561-10-3212		12	60	0.63	0.84	50	1.95	.71	430	510	
561-10-3216	20(7X)	16	60	0.72	0.97	50	1.08	.92	501	581	
561-10-3220		20	60	0.81	1.06	50	1.17	1.08	581	661	
561-10-3224		24	70	0.90	1.15	50	1.26	1.25	704	794	
561-10-3236	20(7X)	36	70	1.04	1.34	50	1.45	1.65	907	1013	
561-10-3250		50	70	1.19	1.51	60	1.65	2.14	1230	1373	
561-15-3204		18(7X)	4	50	0.45	0.67	50	0.78	.48	258	338
561-15-3208	8		50	0.56	0.80	50	0.91	.65	369	439	
561-15-3212	12		60	0.67	0.89	50	1.00	.79	504	584	
561-15-3216	18(7X)	16	60	0.77	1.02	50	1.13	1.00	604	684	
561-15-3224		24	70	0.96	1.24	50	1.35	1.43	852	958	
561-15-3236		36	70	1.11	1.42	50	1.53	1.84	1117	1260	
▲ 561-10-3302	18(7X)	2	40	0.38	0.58	50	0.69	0.37	212	292	
▲ 561-10-3304		4	50	0.49	0.71	50	0.82	0.53	273	353	
561-10-3306		6	50	0.55	0.75	50	0.86	0.58	338	418	
▲ 561-10-3308	18(7X)	8	50	0.60	0.80	50	0.92	0.65	389	469	
561-10-3310		10	60	0.67	0.89	50	1.00	0.79	479	559	
▲ 561-10-3312		12	60	0.71	0.93	50	1.04	0.85	529	609	
561-10-3316	18(7X)	16	60	0.79	1.06	50	1.17	1.08	632	738	
561-10-3320		20	60	0.88	1.15	50	1.26	1.25	778	868	
▲ 561-10-3324		24	70	0.98	1.24	50	1.35	1.43	889	995	
561-10-3336	18(7X)	36	70	1.15	1.47	50	1.58	1.96	1203	1346	
561-10-3350		50	80	1.36	1.69	60	1.82	2.60	1629	1812	
561-15-3304		16(7X)	4	50	0.54	0.75	50	0.86	.58	314	394
561-15-3308	8		60	0.69	0.93	50	1.04	.85	475	555	
561-15-3312	12		60	0.79	1.06	50	1.17	1.08	632	712	
561-15-3316	16(7X)	16	70	0.90	1.15	50	1.26	1.25	781	861	
561-15-3324		24	70	1.06	1.34	50	1.45	1.65	1097	1240	
561-15-3336		36	80	1.29	1.60	60	1.73	2.35	1539	1682	
▲ 561-10-3402	16(7X)	2	50	0.44	0.67	50	0.78	0.48	255	336	
▲ 561-10-3404		4	50	0.52	0.71	50	0.82	0.53	327	407	
561-10-3406		6	50	0.59	0.84	50	0.95	0.71	434	514	
▲ 561-10-3408	16(7X)	8	60	0.69	0.93	50	1.04	0.85	505	585	
561-10-3410		10	60	0.75	1.02	50	1.13	1.00	604	684	
▲ 561-10-3412		12	60	0.81	1.06	50	1.17	1.08	671	777	
561-10-3416	16(7X)	16	70	0.95	1.24	50	1.35	1.43	855	945	
561-10-3420		20	70	1.03	1.34	50	1.45	1.65	1004	1101	
▲ 561-10-3424		24	70	1.10	1.37	50	1.48	1.72	1245	1388	
561-10-3436	16(7X)	36	80	1.29	1.60	60	1.73	2.35	1678	1842	
561-10-3450		50	80	1.53	1.87	60	2.00	3.14	2172	2428	
▲ 561-15-3404		16(7X)	4	50	0.58	0.80	50	0.91	0.65	384	464
▲ 561-15-3408	8		60	0.79	1.02	50	1.13	1.00	609	689	
▲ 561-15-3412	12		70	0.95	1.19	50	1.30	1.33	862	952	
561-15-3416	16(7X)	16	70	1.04	1.34	50	1.45	1.65	1053	1159	
561-15-3424		24	80	1.27	1.60	60	1.73	2.35	1574	1738	
561-15-3436		36	80	1.49	1.83	60	1.96	3.02	2119	2306	

ELECTRICAL SPECIFICATIONS	
Conductor Resistance, nominalohms/1000 ft. @20°C
20 AWG.....	10.4
18 AWG.....	6.5
16 AWG.....	4.1
Insulation Test Voltage (spark test).....	5000 Volts ac
Dielectric Test Voltage.....	1500 Volts ac for 15 sec.
Insulation Resistance Constant @60°F minimum (natural material typical value).....	2000 Megohms-1000 ft.
Loop Resistance, nominal (2 conductor) ohms-1000 ft @20°C	
20 AWG.....	20.8
18 AWG.....	13.0
16 AWG.....	8.2
Mutual Capacitance (PF/ft.)*	
#20.....	59
#18.....	68
#16.....	76
*Typical Value	

▲ Authorized Stock Item: Available from our Customer Service Center.

Jackets - Optional jacket types available - consult local sales office.

† Cross-sectional area for calculation of cable tray fill in accordance with NEC Section 392.22.

Copper or bronze C-L-X available on special order. To order C-L-X Type SP-OS without the outer Okoseal jacket, change the sixth digit of the catalog number from 3 to 1. For example, to order 12 pr. 20 AWG with a bare aluminum C-L-X, the catalog number would be 561-10-1212.

C-L-X products manufactured in the United States under license granted by Kabelmetal of Hannover, Germany.

Length Tolerance: Cut lengths of 1000 feet or longer are subject to a tolerance of ± 10%; less than 1000 feet ± 15%.



THE OKONITE COMPANY

Ramsey, New Jersey 07446



Type P-OS

Type ITC/PLTC Thermocouple Extension Cable

Single Pair - Overall Shield - 105°C Rating
For Cable Tray Use



- A Solid Thermocouple Alloy Conductor
- B Okoseal Insulation
- C Twisted Pair/Triad
- D Tinned Stranded Copper Drain Wire
- E Aluminum/Polyester Tape
- F Rip Cord
- G Okoseal Jacket

Specifications

Conductors: Solid alloys per ANSI MC 96.1

Insulation: Flame-retardant Okoseal® (PVC) per UL Standard 13 and 2250, 15 mils nominal thickness, 105°C temperature rating.

Conductor Identification: Pigmented insulation on individual conductors.

Assembly: Pair assembled with left-hand lay.

Cable Shield: Aluminum/Polyester tape overlapped to provide 100% coverage, and a 7-strand tinned copper drain wire, same size as conductor.

Jacket: Flame-retardant, low temperature Okoseal per UL Standard 13 and 2250. A rip cord is laid longitudinally under the jacket to facilitate removal.

Classifications: UL Listed as Type ITC/PLTC - Instrumentation Tray Cable/Power Limited Tray Cable, for use in accordance with Article 727 and 725 of the National Electrical Code.

Cables comply with UL 2250 and UL Subject 13 for PLTC, CL2 and CL3.

Applications

Okonite Type P-OS (Pair/triad - Overall Shield) thermocouple extension cables are designed for use as instrumentation and process control cables in ITC non-classified or labeled circuits up to 150 volts and 5 amps (750VA) and in Class 2 of 3 Power-Limited circuits where shielding against external interference is required, but shielding against interference among groups is not required; indoors or outdoors; in wet or dry locations with conductor operating temperatures up to 105°C; in cable trays; in raceways; supported by a

messenger wire; under raised floors; for direct burial. Suitable Class I, Division 2, Class II, Division 2, or Class III, Division 2 hazardous locations.

Product Features

- Passes the UL 1581 & IEEE 383-1974 vertical tray flame tests.
- Sunlight resistant & oil resistant.
- UL listed for direct burial.
- Individual pairs or triads are color coded for simplified hook-up.
- Good noise rejection.
- Excellent weathering characteristics.
- OSHA Acceptable.
- Flexible, easy to handle terminate.
- Twisted with 100% shield coverage to reduce electromagnetic noise.
- Suitable for low temperature installation of -40°C.

Type P-OS

Type ITC/PLTC Thermocouple Extension Cable

Single Pair - Overall Shield - 105°C Rating
For Cable Tray Use

Product Data

Section 5: Sheet 18



Conductors: 16 AWG
Okoseal Insulation: 15 mils

ASA/ISA Type	Catalog Number	Number of Pairs	Jacket Thickness (mils)	Nominal Cable O.D. - (in.)	Cross-Sectional Area † (sq in)	Approx Net Weight (lbs/1000')	Approx Ship Weight (lbs/1000')
EX	▲ 284-20-1401	1	35	.24	.05	44	49
JX	▲ 284-20-2401	1	35	.24	.05	44	49
KX	▲ 284-20-3401	1	35	.24	.05	44	49
TX	284-20-4401	1	35	.24	.05	44	49

ASA/ISA COLOR CODE AND LIMITS OF ERROR									
ASA/ISA Type	Positive Wire		Negative Wire		Outer Jacket Color	Temperature Range°C	Limits of Error		Nom. Loop Resistance Per 100' @ 20°C
	Alloy	Color	Alloy	Color			Standard	Special (1)	
EX	Chromel	Purple	Constantan	Red	Purple	0 to 200°C	± 1.7°C		27.8 ohms
JX	Iron	White	Constantan	Red	Black	0 to 200°C	± 2.2°C	± 1.1°C	13.9 ohms
KX	Chromel	Yellow	Alumel	Red	Yellow	0 to 200°C	± 2.2°C		23.6 ohms
TX	Copper	Blue	Constantan	Red	Blue	-60 to 100°C	± 1.0°C	± 0.5°C	12.0 ohms

▲ Authorized Stock Item: Available from our Customer Service Center.

SX available upon request.

(1) Special grade alloy conductors for JX and TX are available on special order.

† Cross-sectional area for calculation of cable tray fill in accordance with NEC Section 392.22

ELECTRICAL SPECIFICATIONS Per UL Standard 13 and 2250	
Insulation Test Voltage (spark test).....	5000 Volts ac
Dielectric Test Voltage.....	1500 Volts ac for 15 sec.
Shield Isolation Test	
Pair to Cable Shield.....	exceeds 100M ohms/1000 ft.
Insulation Resistance Constant @60°F minimum (natural material typical value).....	
	2000 Megohms-1000 ft.



C-L-X[®] Type P-OS Type ITC/PLTC Armored Thermocouple Extension Cable

Single Pair - Overall Shield - 105°C Rating
For Cable Tray Use

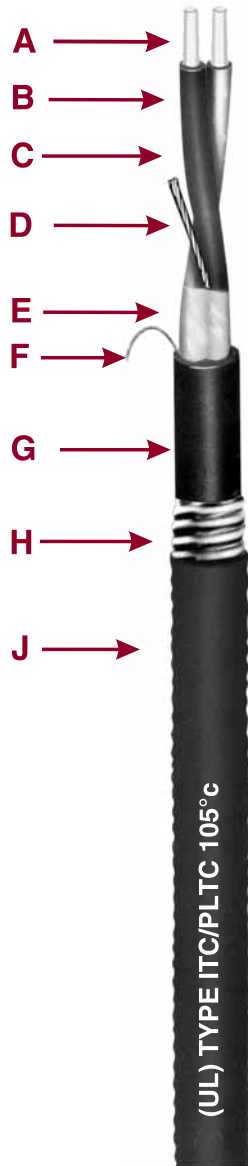

- A** Solid Thermocouple Alloy Conductor
- B** Okoseal Insulation
- C** Twisted Pair
- D** Tinned Stranded Copper Drain Wire
- E** Aluminum/Polyester Tape
- F** Rip Cord
- G** Inner Okoseal Jacket
- H** Impervious, Continuous, Corrugated Aluminum C-L-X Sheath
- J** Outer Okoseal Jacket

Specifications

Conductors: Solid alloys per ANSI MC 96.1.

Insulation: Flame-retardant Okoseal[®] (PVC) per UL Standard 13 and 2250, 15 mils nominal thickness, 105°C temperature rating.

Conductor Identification: Pigmented insulating on individual conductors.

Assembly: Pairs assembled with left-hand lay

Cable Shield: Aluminum/Polyester backed tape overlapped to provide 100% coverage, and a 7-strand tinned copper drain wire, same size as the conductor.

Inner Jacket: Black, flame-retardant, low temperature Okoseal per UL Standard 13 and 2250. A rip cord is laid longitudinally under the jacket to facilitate removal.

C-L-X Sheath: Close fitting, impervious, continuously welded and corrugated aluminum sheath provides complete protection against moisture, liquids, and gases, has excellent mechanical strength and provides equipment grounding through the sheath.

Outer Jacket: Flame-retardant, low temperature Okoseal per UL Standard 13 and 2250.

Classifications: UL Listed as Type ITC/PLTC - Instrumentation Tray Cable/Power Limited Tray Cable, for use in accordance with Article 727 and 725 of the National Electrical Code.

Cables comply with UL 2250 and UL Subject 13 for PLTC, CL2 and CL3.

Applications

Okonite Type C-L-X P-OS (Pair/triad - Overall Shield) Thermocouple Extension cables are designed for use as instrumentation and process control cables in ITC non-classified or labeled circuits up to 150 volts and 5 amps (750VA) and in Class 2 or 3 Power-Limited circuits where shielding against external interference is required, but shielding against interfer-

ence among groups is not required; indoors or outdoors; in wet or dry location with conductor operating temperatures up to 105°C; in cable trays; in raceways; supported by a messenger wire; under raised floors; for direct burial. Suitable Class I, Division 2, Class II, Division 2, or Class III, Division 2 and Class I, Zone 2 hazardous locations. The C-L-X sheath provides physical protection against mechanical damage. It may be installed in both exposed and concealed work, secured to supports not greater than 6 feet apart.

Product Features

- Passes the UL 1581, IEEE 383-1974, & IEEE 1202 vertical tray flame tests.
- Passes the 210,000 BTU/hr vertical tray flame test per ICEA T-29-520.
- Complete pre-packaged, factory-tested wiring system-color coded.
- C-L-X cables are quality control inspected to meet or exceed applicable UL Standards.
- C-L-X enclosure permits installation in cable tray containing light and power cables without a barrier separator.
- Individual pairs or triads are color coded for simplified hook-up.
- Impervious, continuous sheath excludes moisture, gases and liquids.
- C-L-X sheath exceeds equipment grounding conductor requirements of NEC Section 250-118.
- Lower installed system cost than conduit or EMT systems.
- Meets API Standards 14F and 14FZ.
- UL listed for direct burial
- Suitable for low temperature installation of -40°C

C-L-X Type P-OS

Type ITC/PLTC Armored Thermocouple Extension Cable

Single Pair - Overall Shield - 105°C Rating
For Cable Tray Use



Product Data

Section 5: Sheet 19

Conductors: 16 AWG
Okoseal Insulation: 15 mils

ASA/ISA Type	Catalog Number	Number of Pairs	Inner Jacket Thickness - mils	Inner Jacket Nominal O.D. - Inches	C-L-X O.D. - Inches	Outer Jacket - mils	Nominal Cable O.D. - (In.)	Cross-Sectional Area (sq in) †	Approx Net Weight (lbs/1000')	Approx Ship Weight (lbs/1000')
EX	584-20-1401	1	.35	.43	50	.54	.23	128	167	
JX	584-20-2401	1	.35	.43	50	.54	.23	128	167	
KX	▲ 584-20-3401	1	.35	.43	50	.54	.23	128	167	
TX	584-20-4401	1	.35	.43	50	.54	.23	128	167	

ASA/ISA COLOR CODE AND LIMITS OF ERROR

ASA/ISA Type	Positive Wire		Negative Wire		Outer Jacket Color	Temperature Range °C	Limits of Error		Nom. Loop Resistance Per 100' @ 20°C
	Alloy	Color	Alloy	Color			Standard	Special (1)	
EX	Chromel	Purple	Constantan	Red	Purple	0 to 200°C	± 1.7°C		27.8 ohms
JX	Iron	White	Constantan	Red	Black	0 to 200°C	± 2.2°C	± 1.1°C	13.9 ohms
KX	Chromel	Yellow	Alumel	Red	Yellow	0 to 200°C	± 2.2°C		23.6 ohms
TX	Copper	Blue	Constantan	Red	Blue	-60 to 100°C	± 1.0°C	± 0.5°C	12.0 ohms

▲ **Authorized Stock Item:** Available from our Customer Service Centers.

SX available upon request.

(1) Special grade alloy conductors for JX and TX are available on special order.

† **Cross-sectional** area for calculation of cable tray fill in accordance with NEC Section 392.22.

Jackets - Optional jacket types available - consult local sales office.

Copper or bronze C-L-X available on special order.

To order C-L-X Type P-OS without the outer Okoseal jacket, change the sixth digit of the catalog number from 1 to 5 for EX, 2 to 6 for JX, 3 to 7 for KX, and 4 to 8 for TX. For example to order 12 pr. 20 AWG Type KX with a bare aluminum C-L-X, the catalog number would be 584-20-7212.

C-L-X products manufactured in the United States under license granted by Kabelmetal of Hanover, Germany.

Length Tolerance: Cut lengths of 1000 feet or longer are subject to a tolerance of ± 10%; less than 1000 feet ± 15%.

ELECTRICAL SPECIFICATIONS Per UL Standard 2250

Insulation Test Voltage (spark test)	5000 Volts ac
Dielectric Test Voltage	1500 Volts ac for 15 sec.
Shield Isolation Test	
Pair to Cable Shield.....	exceeds 100M ohms/1000 ft.
Insulation Resistance Constant @60°F, minimum (natural material typical value).....	2000 Megohms-1000 ft.



THE OKONITE COMPANY

Ramsey, New Jersey 07446



Okoseal-N[®] Type P-OS

Type TC Instrumentation Cable

Single Pair or Triad - Overall Shield
600 Volts - 90°C Rating Wet or Dry



- A** Stranded Bare Copper Conductor
- B** Okoseal Insulation with Nylon Jacket
- C** Twisted Pair/Triad
- D** Stranded Tinned Copper Drain Wire
- E** Aluminum/Synthetic Polymer Tape
- F** Rip Cord
- G** Black Okoseal Jacket

Specifications

Conductors: Bare soft annealed copper, Class B, 7-strand concentric per ASTM B-8.

Insulation & Jacket: Flame-retardant Okoseal[®] (PVC), 15 mils nominal thickness, nylon jacket, 4 mil nominal thickness, 90°C temperature rating, per UL Standard 1277.

Conductor Identification: Pigmented black and white in pairs, black, white and red in triads.

Assembly: Pair or triad assembled with left-hand lay.

Cable Shield: Aluminum/Polyester tape overlapped to provide 100% coverage, and a 7-strand tinned copper drain wire, same size as conductor.

Jacket: Black, flame-retardant, low temperature Okoseal per UL Standard 1277, 90°C temperature rating. A rip cord is laid longitudinally under the jacket to facilitate removal.

Classification: UL Listed as Type TC Article 336 of the National Electrical Code.

Applications

Okonite's single pair or triad Type P-OS instrumentation cables are designed for use on Class 1 Remote-Control Signaling circuits or where a 600V cable is desired, as instrumentation, process control, or computer cable transmitting signals at levels above 100 milli-volts in circuits where shielding against external interference is required, but shielding against interference among groups is not required. For use indoors or outdoors; wet or dry locations; in cable trays; in raceways; supported by a messenger wire; in Class I, Division 2, Class II, Division 2 or Class III, Division 2 hazardous locations. Also for use as non power limited fire protective signaling cable (NPLF) per NEC Code 760. Type TC cables can be labeled Okomarine to be used in ABS and Coast Guard approved marine applications.

Type TC is authorized for use in Class I & II, Division 2 hazardous locations.

Product Features

- Passes the UL 1277 & IEEE 383-1974 vertical tray flame tests.
- May be combined with 600V power and control cables in the same tray.
- Sunlight resistant & oil resistant
- Individual pairs or triads are color coded for simplified hook-up.
- Good noise rejection.
- Excellent weathering characteristics.
- May be used in approved marine applications.
- Flexible, easy to handle and terminate.
- Twisted with 100% shield coverage to reduce electromagnetic pick-up.
- OSHA Acceptable.
- Suitable for installation in low temperature installations to -40°C.

Okoseal-N Type P-OS Type TC Instrumentation Cable

Single Pair or Triad - Overall Shield
600V - 90°C Rating Wet or Dry



Product Data Section 5: Sheet 29

Okoseal Insulation: 15 mils
Nylon Jacket: 4 mils

Catalog Number	Size AWG	Number of Pairs	Number of Triads	Jacket Thickness-(mils)	Nominal Cable O.D. - (in.)	Cross-Sectional Area † (sq in)	Approx Net Weight (lbs/1000')	Approx Ship Weight (lbs/1000')
▲ 264-60-3301	18	1	45	0.27	0.06	48	53	
264-65-3301	18	1		0.29	0.07	54	59	
▲ 264-60-4401	16	1		0.29	0.07	56	61	
▲ 264-65-4401	16	1		0.31	0.08	69	80	
▲ 264-60-5501	14	1		0.32	0.09	75	86	
264-65-5501	14	1		0.34	0.10	94	105	

ELECTRICAL SPECIFICATIONS Per UL Standard 1277

Conductor Resistance, maximum ohms/1000 ft.

..... @20°C @25°C
18 AWG	6.09.....7.04
16 AWG	4.34.....4.43
14 AWG	2.72.....2.78

Insulation Test Voltage (spark test)

18 - 16 AWG	6000 volts ac
14 AWG	7500 volts ac

Dielectric Test Voltage

18-16 AWG	1500 volts ac for 1 minute
14 AWG	2000 volts ac for 1 minute

Shield Isolation Test

Pair to Cable Shield . . . exceeds 100 Megohms/1000 ft.

Insulation Resistance Constant @60°F minimum
(natural material typical value)2000 Ohms-1000 ft.

Loop Resistance, nominal (2 conductor)ohms-1000 ft
..... @20°C @25°C

18 AWG	12.18.....14.08
16 AWG	8.68.....8.86
14 AWG	5.44.....5.56

† **Cross-sectional** area for calculation of cable tray fill in accordance with NEC Section 392-22

Length Tolerance: Cut lengths of 1000 feet or longer are subject to a tolerance of ± 10%; less than 1000 feet ± 15%.

▲ **Authorized Stock Item:** Available from our Customer Service Centers.

Mutual Capacitance	18 AWG	49 pF/ft
	16 AWG	56 pF/ft
	14 AWG	64 pF/ft
L/R ratio	18 AWG	14 micro Henry/ohm
	16 AWG	21 micro Henry/ohm
	14 AWG	31 micro Henry/ohm
Inductance	18 AWG	0.19 micro Henry/ft
	16 AWG	0.18 micro Henry/ft
	14 AWG	0.17 micro Henry/ft





Okoseal-N[®] Type SP-OS

Type TC Instrumentation Cable

Multiple Shielded Pairs or Triads - Overall Shield
600 Volts - 90°C Rating Wet or Dry



- A** Stranded Bare Copper Conductor
- B** Okoseal Insulation with Nylon Jacket
- C** Tinned Stranded Copper Group Drain Wire
- D** Double Faced Aluminum/Synthetic Polymer Backed Tape
- E** Twisted, Shielded Pairs/Triads
- F** Double Faced Aluminum/Synthetic Polymer Backed Tape
- G** Stranded Tinned Copper Drain Wire
- H** Rip Cord
- J** Black Okoseal Jacket

Specifications

Conductors: Bare soft annealed copper, Class B, 7-strand concentric per ASTM B-8.

Insulation: Flame-retardant Okoseal[®] (PVC), 15 mils nominal thickness, nylon jacket, 4 mil nominal thickness, 90°C temperature rating, per UL Standard 1277.

Conductor Identification: Pigmented black and white in pairs; black, white and red in triads.

Group Shield: Aluminum/Polyester tape overlapped to provide 100% coverage, and a 7-strand tinned copper drain wire, two sizes smaller than the conductor. All group shields are completely isolated from each other.

Assembly: Pairs or triads assembled with 1 left-hand lay. Flame-retardant, non-wicking fillers included where required to provide a round cable.

Cable Shield: Aluminum/Polyester tape overlapped to provide 100% coverage, and a 7-strand tinned copper drain wire, same size as conductor.

Jacket: Black, flame-retardant, low temperature Okoseal per UL Standard 1277, 90°C temperature rating. A rip cord is laid longitudinally under the jacket to facilitate removal.

Classification: UL Listed as Type TC Article 336 of the National Electrical Code.

Applications

Okonite's Type SP-OS (Shielded pairs or triads - Overall Shield) instrumentation cables are designed for use on Class 1 Remote-Control Signaling circuits or where a 600V cable is desired, as instrumentation, process control, or computer cable transmitting signals at levels above 100 milli-volts in circuits where maximum noise protection is required. Protection from interference among groups as well as external sources is provided by individual group shields as well as an overall cable shield. For use indoors or outdoors; wet or dry locations; in raceways; supported by a messenger wire; for direct burial; in Class I, Division 2, Class II, Division 2 or Class III, Division 2 hazardous locations. Also for use as non power limited fired protective signaling cable (NPLF) per NEC Code 760. As an option, type TC cables can be labeled Okomarine to be used in ABS and Coast Guard approved marine applications, on special order.

Product Features

- Passes the UL 1277 and IEEE 383-1974 vertical tray flame tests.
- Passes IEEE 1202 vertical tray flame test (8 pr #18 and 4 pr #16 & larger).
- May be combined with 600 volt power and control cables in the same tray.
- Sunlight resistant and oil resistant.
- UL listed for direct burial (8/pr #16 AWG and larger)
- Individual pairs or triads are numbered and color-coded for simplified hook-up.
- Individual pairs or triads are completely isolated.
- 100% shield coverage for reduced electromagnetic noise pick-up.
- Good external noise rejection.
- Excellent weathering characteristics.
- OSHA Acceptable.
- Flexible, easy to handle and terminate.
- Suitable for installation at low temperatures to -40°C.

Okoseal-N Type SP-OS

Type TC Instrumentation Cable

Single Pairs or Triads - Individual and Overall Shield
600V - 90°C Rating Wet or Dry



Product Data

Section 5: Sheet 31

Okoseal Insulation - 15 mils; Nylon Jacket - 4 mils

Catalog Number	Size AWG Strands	Number of Pairs	Number of Triads	Jacket Thickness (mils)	Nominal Cable O.D. - (In.)	Cross-Sectional Area † (sq in)	Approx Net Weight (lbs/1000')	Approx Ship Weight (lbs/1000')						
261-60-3304	4	4	45	0.50	0.20	138	161	261-60-3308						
261-60-3308									8	60	0.67	0.35	258	297
261-60-3310	10	80	60	0.77	0.46	316	355	261-60-3312						
261-60-3312									12	80	0.81	0.51	395	459
261-60-3316									16	80	0.93	0.67	496	559
261-60-3320									20	80	1.07	0.90	597	677
261-60-3324	18 (7x)	80	80	1.09	0.93	699	779	261-60-3336						
261-60-3324									24	80	1.09	0.93	699	779
261-60-3336									36	80	1.28	1.29	974	1080
261-60-3350									50	80	1.55	1.89	1307	1450
261-65-3304	4	60	60	0.61	0.29	196	220	261-65-3308						
261-65-3308									8	60	0.75	0.44	317	356
261-65-3312									12	80	0.95	0.71	516	580
261-65-3316	16	80	80	1.09	0.93	652	732	261-65-3324						
261-65-3324									24	80	1.34	1.41	940	1046
261-65-3336									36	80	1.53	1.84	1319	1462
▲ 261-60-4402	2	45	45	0.44	0.15	114	137	▲ 261-60-4404						
▲ 261-60-4404									4	60	0.58	0.26	198	222
▲ 261-60-4408									8	60	0.72	0.47	337	376
261-60-4410	10	80	80	0.94	0.69	452	516	▲ 261-60-4412						
261-60-4412									12	80	0.91	0.65	515	579
261-60-4416									16	80	1.04	0.85	650	730
261-60-4420	16 (7x)	80	80	1.19	1.11	787	867	▲ 261-60-4424						
261-60-4424									24	80	1.18	1.09	925	1031
261-60-4436									36	80	1.40	1.54	1304	1410
261-60-4450									50	110	1.79	2.52	1866	2053
261-65-4404	4	60	60	0.61	0.29	252	291	▲ 261-65-4408						
261-65-4408									8	80	0.79	0.49	478	542
261-65-4412									12	80	1.00	0.79	674	754
261-65-4416	16	80	80	1.12	0.99	858	964	261-65-4424						
261-65-4424									24	80	1.50	1.77	1245	1388
261-65-4436									36	80	1.71	2.30	1761	1948
261-60-5504	4	60	60	0.68	0.36	272	311	261-60-5508						
261-60-5508									8	80	0.91	0.65	511	575
261-60-5510	10	80	80	1.06	0.88	627	707	261-60-5512						
261-60-5512									12	80	1.09	0.93	721	801
261-60-5516									16	80	1.20	1.13	919	1025
261-60-5520	14 (7x)	80	80	1.34	1.41	1120	1226	261-60-5524						
261-60-5524									24	80	1.48	1.72	1322	1428
261-60-5536									36	80	1.67	2.19	1886	2029
261-60-5550									50	110	2.02	3.20	2681	2973
261-65-5504	4	60	60	0.75	0.44	351	390	261-65-5512						
261-65-5512									12	80	1.23	1.19	954	1060
261-65-5516	16	80	80	1.36	1.45	1225	1331	261-65-5524						
261-65-5524									24	80	1.69	2.24	1794	1987
261-65-5536									36	110	2.00	3.14	2683	2975

ELECTRICAL SPECIFICATIONS Per UL Standard 1277			
Conductor Resistance, maximumohms/1000 ft.			
		@20°C	@25°C
18 AWG	6.09		7.04
16 AWG	4.34		4.43
14 AWG	2.72		2.78
Insulation Test Voltage (spark test)			
18 - 16 AWG	6000 VOLTS AC		
14 AWG	7500 VOLTS AC		
Dielectric Test Voltage2000 Volts ac for 1 minute			
Insulation Resistance Constant @ 60F, minimum			
(natural material typical value) 2000 ohms/1000 ft.			
Loop Resistance, maximum (2 conductor)ohms-1000 ft			
		@20°C	@25°C
18 AWG.....	12.18		14.08
16 AWG	8.68		8.86
14 AWG	5.44		5.56

† Cross-sectional area for calculation of cable tray fill in accordance with NEC Section 392.22

Length Tolerance: Cut lengths of 1000 feet or longer are subject to a tolerance of ± 10%; less than 1000 feet ± 15%.

▲ Authorized Stock Item: Available from our Customer Service Centers.



THE OKONITE COMPANY

Ramsey, New Jersey 07446



C-L-X[®] Okoseal-N[®] P-OS

UL Type MC-HL and cUL Type ACIC-TC Instrumentation Cable

Single Pair or Triad-Overall Shield

600 Volts 90°C Rating 600/1000V Marine Cable

For Cable Tray Use - Sunlight Resistant - For Direct Burial

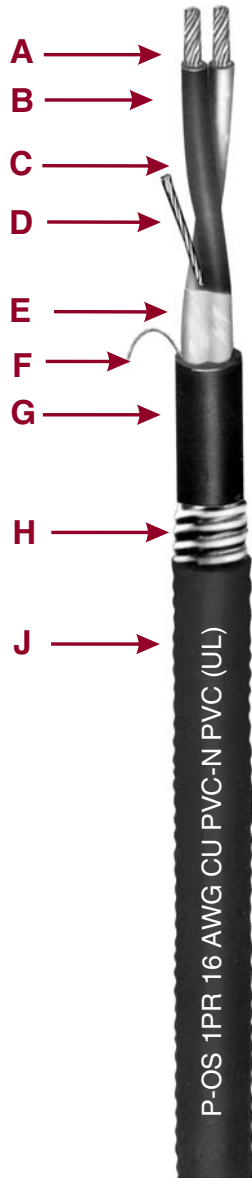

- A** Bare Stranded Copper Conductor
- B** Okoseal Insulation/Nylon Jacket
- C** Twisted, Shielded Pairs/Triads
- D** Tinned Stranded Copper Drain Wire
- E** Aluminum/Synthetic Polymer Tape
- F** Rip Cord
- G** Inner Black Okoseal Jacket
- H** Impervious, Continuous, Corrugated Aluminum C-L-X Sheath
- J** Outer Black Okoseal Jacket

Specifications

Conductors: Bare soft annealed copper, Class B, 7-strand concentric per ASTM B-8.

Insulation: Flame-retardant Okoseal (PVC) per UL 83, 15 mils nominal thickness, 90°C temperature rating.

Jacket: Nylon per UL 83, 4 mils nominal thickness.

Conductor Identification: Pigmented black and white in pairs; black, white and red in triads.

Assembly: Pairs or triads assembled with left-hand lay. Non-wicking fillers included where required to provide a round cable.

Cable Shield: Aluminum/Polyester tape overlapped to provide 100% coverage, and a #16 AWG stranded tinned copper drain wire.

Inner Jacket: Black, flame-retardant Okoseal per UL Standard 1569. A rip cord is laid longitudinally under the jacket to facilitate removal.

C-L-X Sheath: A close-fitting, impervious, continuously welded and corrugated, aluminum sheath meeting UL 1569 provides complete protection against moisture, liquids, and gases, has excellent mechanical strength, and provides equipment grounding through the sheath.

Outer Jacket: Black, flame-retardant Okoseal per UL Standard 1569.

Applications

Okonite C-L-X Single pair or triad type P-OS instrumentation cables are designed for use on Class 1 Remote-Control Signaling circuits or where a 600V cable is desired, as instrumentation, process control, or computer cable transmitting signals at levels above 100 milli-volts in circuits where shielding against external interference is required, but shielding against interference among groups is not required. For use indoors or outdoors; wet or dry locations; in cable trays; in raceways; supported by a messenger wire; for direct burial; in Classes I, II, and III, Divisions 1 and 2 hazardous locations per NEC Articles 501, 502, 503, 504 and 505; in Zone 2, Class II Div 2, Class III Div 1 and Class III Div 2 per CEC.

The overall shield eliminates most of the static interference from the electric field radiated by power cables and other electrical equipment.

The C-L-X sheath provides the physical protection against mechanical damage as required in NEC Section 725-8 as well as complete protection against moisture or gases entering the cable.

For dc service in wet locations, X-Olene insulation is recommended.

These cables also comply with UL requirements for Types CL2 and CL3.

Product Features

Complete pre-packaged, factory-tested wiring system—color coded.

C-L-X enclosure permits installation in cable tray containing light and power cables without a barrier separator.

Impervious, continuous sheath excludes moisture, gases and liquids.

C-L-X sheath exceeds equipment grounding conductor requirements of NEC Section 250-122, for Non-HL locations.

Excellent compression and impact resistance.

Lower installed system cost than conduit or EMT systems.

Suitable for low temperature installation to -40°C.

Applicable Standards

- UL listed for cable tray use, direct burial and sunlight resistant.
- Vertical Tray Flame Tests.
IEEE 383-1974, FT4/IEEE 1202, ICEA T-29-520 (210,000 BTU)
- American Bureau of Shipping Type approved as CWCMC Type MC-HL.
- API Standards 14F and 14FZ.
- ASTM B-8.
- OSHA Acceptable
- UL 2225 Type MC-HL
- UL 83
- UL 1309 (CWCMC) Marine Shipboard
- UL 1569
- UL certified as Marine Shipboard in accord with IEEE 1580, Marine Shipboard Cable rated 600/1000 volts.
- NEC Articles 501, 502, 503, 504 and 505 for Classes I, II and III, Divisions 1 and 2 Hazardous Locations.
- NPLF per NEC Code Article 760.
- CSA C22.2 No. 230 Type TC
- CSA C22.2 No. 239 Type ACIC
- cUL Type ACIC-TC complies with CEC Zone 2, Class II Div 2, Class III Div 1 and Class III Div 2 Hazardous Locations.

C-L-X Okoseal-N P-OS

UL Type MC-HL and cUL Type ACIC-TC Instrumentation Cable

Single Pair or Triad-Overall Shield
600 Volts 90°C Rating 600/1000V Marine Cable

For Cable Tray Use - Sunlight Resistant - For Direct Burial

Conductors: #16 AWG; Okoseal Insulation: 15 mils; Nylon Jacket: 4 mils

Product Data Section 5: Sheet 40



#16 AWG — Single Pair & Triad (P-OS) Type MC-HL

Catalog Number	Number of Pairs	Number of Triads	Inner Jacket Thickness - mils	Inner Jacket Nominal O.D. - inches	C-L-X O.D. - inches	Outer Jacket Thickness, mils	Nominal Cable O.D. - inches	Cross-Sectional Area * Sq. In.	Net Weight Lbs./1000'	Ship Weight Lbs./1000'
▲ 564-60-3401	1		66	.35	.53	50	.64	0.32	182	221
▲ 564-65-3401		1	58	.35	.53	50	.64	0.32	190	229

ELECTRICAL SPECIFICATIONS

Conductor Resistance, maximum	ohms/1000 ft.	
	@20°C	@25°C
16 AWG	4.34	4.43
Insulation Test Voltage (spark test)	6000 Volts ac	
Dielectric Test Voltage	2000 Volts ac.	
Shield Isolation Test		
Pair to Cable Shield	exceeds 100 Megohms-1000 ft.	
Insulation Resistance Constant @60°F minimum	(natural material typical value) 2000 Ohms-1000 ft.	
Loop Resistance, nominal (2 conductor)	ohms/1000 ft	
	@20°C	@25°C
16 AWG	8.68	8.86
Mutual Capacitance (PF/ft.)*		
#16	.60	

*Typical Value

▲ Authorized Stock Item: Available from our Customer Service Centers.

*Cross-sectional area for calculation of cable tray fill in accordance with NEC Section 392.22.

Jackets: Optional jacket types available - consult local sales office.

Copper or bronze C-L-X available on special order.

To order C-L-X Type P-OS without the outer Okoseal jacket (not "HL" listed), change the sixth digit of the catalog number from 3 to 1, for example to order 1 pr. 20 AWG with a bare aluminum C-L-X, the catalog number would be 564-10-1212.

Length Tolerance: Cut lengths of 1000 ft. or longer are subject to a tolerance of +\ -10%; less than 1000 ft. +\ -15%



C-L-X® Okoseal-N® SP-OS

UL Type MC-HL and cUL Type ACIC-TC Instrumentation Cable

Multiple Shielded Pairs or Triads - Individual and Overall Shield
600 Volts 90°C Rating MC-HL — 600/1000V Marine Cable
For Cable Tray Use - Sunlight Resistant - For Direct Burial



- A Bare Stranded Copper Conductor
- B Okoseal Insulation/Nylon Jacket
- C Tinned Stranded Copper Group Drain Wire
- D Aluminum/Polyester Tape
- E Twisted, Shielded Pairs/Triads
- F Tinned Stranded Copper Drain Wire
- G Aluminum/Polyester Tape
- H Rip Cord
- J Inner Black Okoseal Jacket
- K Impervious, Continuous, Corrugated Aluminum C-L-X Sheath
- L Outer Black Okoseal Jacket

Specifications

Conductors: Bare soft annealed copper, Class B, 7-strand concentric per ASTM B-8.

Insulation: Flame-retardant Okoseal (PVC) per UL 83, 15 mils nominal thickness, 90°C temperature rating.

Insulation Jacket: Nylon per UL 83, 4 mils nominal thickness.

Conductor Identification: Pigmented black and white in pairs, black, white and red in triads.

Group Shield: Aluminum polyester tape overlapped to provide 100% coverage, and a 7-strand tinned copper drain wire, two sizes smaller than the conductor. All group shields are completely isolated from each other.

Assembly: Pairs or triads assembled with left-hand lay. Non-wicking fillers included where required to provide a round cable.

Cable Shield: Aluminum/polyester tape overlapped to provide 100% coverage, and a 7-strand tinned copper drain wire, same size as conductor.

Inner Jacket: Black, flame-retardant Okoseal per UL Standard 1569. A rip cord is laid longitudinally under the jacket to facilitate removal.

C-L-X Sheath: A close-fitting, impervious, continuously welded and corrugated, aluminum sheath provides physical protection against mechanical damage as required in NEC Section 725-8.

Additionally, C-L-X meets UL 1569 provides complete protection against moisture, liquids, and gases, has excellent mechanical strength, and provides equipment grounding through the sheath.

Outer Jacket: Black, flame-retardant Okoseal per UL Standard 1569.

Classifications: UL Listed as Type MC-HL Articles 501, 502, and 503 of the National Electrical Code.

Applications

Okonite C-L-X type SP-OS (shielded pairs or triads - overall shield) instrumentation cables are designed for use on Class 1 Remote-Control Signaling circuits or where a 600V cable is desired, as instrumentation, process control, or computer cable transmitting signals at levels above 100 milli-volts in circuits where maximum noise protection is required. Protection from interference among groups as well as external sources is provided by individual group shields as well as an overall cable shield. For use indoors or outdoors; wet or dry locations; in cable trays in raceways; supported by a messenger wire; for direct burial; in Classes I, II, and III, Divisions 1 and 2 and Class I, Zones 1 and 2 hazardous locations per NEC Articles 501, 502, 503 and 505; in Zone 2,

Class II Div 2, Class III Div 1 and Class III Div 2 per CEC.

The isolated individual shields over each pair, when properly grounded, prevent crosstalk or capacitive coupling between adjacent pairs which occurs with ac signals, particularly the pulse type.

The overall shield eliminates most of the static interference from the electric field radiated by power cables and other electrical equipment.

The C-L-X sheath provides physical protection against mechanical damage as required in NEC Section 725-8 as well as complete protection against moisture or gases entering the cable.

For dc service in wet locations, X-Olene insulation is recommended.

Product Features

Individual units are completely isolated for maximum noise rejection.

C-L-X enclosure permits installation in cable tray containing light and power cables without a barrier separator.

C-L-X sheath exceeds equipment grounding conductor requirements of NEC Section 250-122, non-HL locations.

Lower installed system cost than conduit or EMT systems.

Suitable for low temperature installation to -40°C.

Applicable Standards

- UL listed for cable tray use, direct burial, in ducts, and sunlight resistant.
- Vertical Tray Flame Tests; IEEE 383-1974, FT4/ IEEE 1202, ICEA T-29-520 (210,000 BTU).
- American Bureau of Shipping Type approved as CWCMC Type MC-HL.
- API Standards 14F and 14FZ.
- ASTM B-8
- OSHA Acceptable
- UL 2225 Type MC-HL, UL 83, UL 1309 (CWCMC) Marine Shipboard, UL 1569
- UL certified to IEEE 1580 - Marine Shipboard Cable rated 600/1000V.
- NEC Articles 501, 502, 503, 504 and 505 for Classes I, II, and III, Divisions 1 and 2 Hazardous Locations.
- NPLF pr NEC Code Article 760.
- CSA C22.2 No. 230 Type TC
- CSA C22.2 No. 239 Type ACIC
- cUL Type ACIC-TC Complies with CEC Zone 2, Class II Div 2, Class III Div 1, Class III Div 2 Hazardous Locations.

C-L-X Okoseal-N SP-OS



Product Data Section 5: Sheet 42

UL Type MC-HL and cUL Type ACIC-TC Instrumentation Cable

Multiple Shielded Pairs or Triads - Individual and Overall Shield

600V 90°C Rating MC-HL — 600/1000V Marine Cable

For Cable Tray Use - Sunlight Resistant - For Direct Burial

Conductors: #16 AWG; Okoseal Insulation: 15 mils; Nylon Jacket: 4 mils

Catalog Number	Number of Pairs	Number of Triads	Inner Jacket Thickness - mils	Nominal Core O.D. - Inches	C-L-X O.D. - Inches	Outer Jacket mils	Nominal Cable O.D. - Inches	Cross-Sectional Area* Sq. In.	Net Weight Lbs./1000'	Ship Weight Lbs./1000'
▲ 561-60-3402	2	40	0.45	0.67	50	0.76	0.45	234	314	
▲ 561-60-3404	4	50	0.56	0.80	50	0.91	0.65	335	415	
561-60-3406	6	50	0.66	0.89	50	1.00	0.79	421	501	
▲ 561-60-3408	8	50	0.70	0.93	50	1.04	0.85	492	572	
561-60-3410	10	50	0.79	1.06	50	1.17	1.08	601	681	
▲ 561-60-3412	12	50	0.85	1.11	50	1.22	1.17	674	780	
561-60-3416	16	50	0.98	1.29	50	1.40	1.54	842	948	
561-60-3420	20	50	1.06	1.34	50	1.45	1.65	977	1120	
▲ 561-60-3424	24	50	1.12	1.42	50	1.53	1.84	1118	1261	
▲ 561-60-3436	36	50	1.37	1.69	60	1.82	2.60	1586	1773	
561-60-3450	50	50	1.57	1.92	60	2.05	3.30	2124	2416	
▲ 561-65-3404	4	50	0.61	0.84	50	0.95	0.71	395	475	
▲ 561-65-3408	8	50	0.82	1.06	50	1.17	1.08	637	717	
▲ 561-65-3412	12	50	0.98	1.29	50	1.40	1.54	863	969	
561-65-3416	16	50	1.10	1.37	50	1.48	1.72	1058	1201	
561-65-3424	24	50	1.33	1.64	60	1.78	2.49	1485	1672	
561-65-3436	36	50	1.58	1.96	60	2.09	3.43	2141	2426	

ELECTRICAL SPECIFICATIONS

Conductor Resistance, nominalohms/1000 ft. @20°C
 16 AWG4.1
 Insulation Test Voltage (spark test)6000 Volts ac
 Dielectric Test Voltage2000 Volts ac for 60 sec.
 Insulation Resistance Constant @60°F minimum
 (natural material typical value) ..2000 Megohms-1000 ft.
 Loop Resistance, nominal (2 conductor).....ohms-1000 ft @20°C
 16 AWG8.2
 Mutual Capacitance (PF/ft.)*
 #1660
 *Typical Value

▲ **Authorized Stock Item:** Available from our Customer Service Centers.

***Cross-sectional area** for calculation of cable tray fill in accordance with NEC Section 392.22.

Jackets - Optional jacket types available - consult local sales office.

Copper or bronze C-L-X available on special order.

To order C-L-X Type SP-OS without the outer Okoseal jacket (not "HL" listed), change the sixth digit of the catalog number from 3 to 1, for example to order 1 pr. 20 AWG with a bare aluminum C-L-X, the catalog number would be 564-10-1212.

Length Tolerance: Cut lengths of 1000 ft. or longer are subject to a tolerance of + \ -10%; less than 1000 ft. + \ -15%





Okobus

Single Pair: Type P-OS — Multi Pair: Type SP-OS Type PLTC & Type ITC-ER Fieldbus Cable

Single Pair or Multiple Shielded Pairs - Overall Shield
300 Volts 75°C Rating



- A** Tinned Copper Stranded Conductor
- B** Polypropylene Insulation
- C** Tinned Stranded Copper Group Drain Wire
- D** Aluminum/Polyester Tape
- E** Twisted, Shielded Pairs
- F** Aluminum/Polyester Tape
- G** Tinned Stranded Copper Drain Wire
- H** Rip Cord
- J** Orange Okoseal Jacket

Specifications

Conductors: #18 AWG tinned copper, Class M, stranded per ASTM B-174.

Insulation: Okolene® (Polypropylene) per UL 13 and 2250, 32 mils nominal thickness, 75°C temperature rating.

Conductor Identification: Pigmented orange and blue in pairs, orange conductor numerically printed for group identification.

Pair Shield: Aluminum/Polyester tape overlapped to provide 100% coverage, and a Class M tinned copper drain wire, two sizes smaller than the conductor. All multi-pair shields are isolated from each other.

Multiple Pair Assembly: Pairs assembled with a left-hand lay. Cable fillers included where required to provide a round cable.

Multiple Pair Cable Shield: Aluminum/Polyester tape overlapped to provide 100% coverage, and a class M strand tinned copper drain wire, same size as conductor.

Jacket: Orange, flame-retardant, Okoseal per UL 13 and 2250. A rip cord is laid longitudinally under the jacket to facilitate removal.

Classifications: UL Listed as PLTC-Power Limited Tray Cable and as ITC-ER - Instrument Tray Cable/Exposed Run for use in accordance with Article 727 and Article 725 of the National Electrical Code.

Cables comply with ISA-S-50-02, UL 2250 and UL 13 for Fieldbus circuits and CL2 and CL3.

Applications

Okonite® OKOBUS® cables are designed for use in rugged plant environments utilizing networked discrete or process automation and control. ITC-ER (Instrument Tray Cable - Exposed Run) eliminated the need for conduit when installed in accordance with NEC Article 727.4(6). Fully complies with ANSI/ISA 50.02 part 2 for Fieldbus Cable.

The isolated individual shields over each pair, when properly grounded,

prevent crosstalk or capacitive coupling between adjacent pairs which occurs with ac signals, particularly the pulse type.

The overall shield or multi pair cables eliminates most of the static interference from the electrical field radiated by power cables and other electrical equipment.

Product Features

- Passes the UL 13 and IEEE 383 vertical tray flame tests.
- Single pair passes IEEE 1202 vertical tray flame test.
- Sunlight & oil resistant.
- UL listed for direct burial.
- Individual pairs are completely isolated.
- 100% shield coverage for reduced electromagnetic noise pick-up.
- Excellent external noise rejection.
- Excellent weathering characteristics.
- OSHA Acceptable.
- Flexible, easy to handle and terminate.



Single Pair or Multiple Shielded Pairs - Overall Shield 300 V 75°C Rating

#18 AWG

Catalog Number	Number of Pairs	Jacket Thickness-mils	Nominal Cable O.D. - Inches	Cross-Sectional Area † (sq in)	Approx Net Weight (lbs/1000')	Approx Ship Weight (lbs/1000')
▲ 264-92-3901	1	45	0.34	0.09	62	73
261-92-3302	2	50	0.55	0.24	148	172
261-92-3304	4	60	0.71	0.40	212	251
261-92-3063	6	60	0.80	0.50	264	303
261-92-3308	8	70	0.91	0.65	340	404
261-92-3312	12	70	1.04	0.85	474	554
261-92-3316	16	70	1.17	1.08	580	660
261-92-3320	20	80	1.32	1.37	722	828
261-92-3324	24	80	1.46	1.67	880	1023

† **Cross-sectional** area for calculation of cable tray fill in accordance with NEC Section 392.22

Length Tolerance: Cut lengths of 1000 feet or longer are subject to a tolerance of $\pm 10\%$; less than 1000 feet $\pm 15\%$.

▲ **Authorized Stock Item:** Available from our Customer Service Centers.

CHARACTERISTICS

- a) Characteristic Impedance, z_0 , at fr (31.25kHz), minimum100 ohms
- b) Maximum attenuation at 1.25 fr (39 kHz)3.0 dB/km
- c) Maximum capacitive unbalance to shield2 nF/km
- d) Maximum DC resistance (per conductor)24 ohms/km
- e) Maximum propagation delay change 0.25 fr to 1.25 fr1.7 μ s/km
- f) conductor cross-sectional area nominal (wire size)0.8 mm² (#18 AWG)
- g) Minimum shield coverage100%





Okobus C-L-X

Single Pair: Type P-OS - Multi Pair: Type SP-OS

Type PLTC & Type ITC-HL Fieldbus Cable

Single Pair or Multiple Shielded Pairs - Overall Shield

300 Volts 75°C Rating



- A Tinned Copper Stranded Conductor
- B Polypropylene Insulation
- C Tinned Stranded Copper Group Drain Wire
- D Aluminum/Polyester Tape
- E Twisted, Shielded Pairs
- F Aluminum/Polyester Tape
- G Tinned Stranded Copper Drain Wire
- H Rip Cord
- J Inner Orange Okoseal Jacket
- K Impervious, Continuous, Corrugated Aluminum C-L-X Sheath
- L Outer Orange Okoseal Jacket

Specifications

Conductors: #18 AWG tinned copper, Class M, stranded per ASTM B-174.

Insulation: Okolene® (Polypropylene) per UL 13 and 2250, 32 mils nominal thickness, 75°C temperature rating.

Conductor Identification: Pigmented orange and blue in pairs, orange conductor numerically printed for group identification.

Pair Shield: Aluminum/Polyester tape overlapped to provide 100% coverage, and a Class M tinned copper drain wire, two sizes smaller than the conductor. All multi-pair shields are isolated from each other.

Multiple Pair Assembly: Pairs assembled with a left-hand lay. Cable fillers included where required to provide a round cable.

Multiple Pair Cable Shield: Aluminum/Polyester tape overlapped to provide 100% coverage, and a class M strand tinned copper drain wire, same size as conductor.

Inner Jacket: Orange, flame-retardant, Okoseal per UL 13 and 2250. A rip cord is laid longitudinally under the jacket to facilitate removal.

C-L-X Sheath: A close-fitting, impervious, continuously welded and corrugated, aluminum sheath provides complete protection against moisture, liquids, and gases, has excellent mechanical strength, and provides equipment grounding through the sheath.

Outer Jacket: Orange, flame-retardant, Okoseal per UL 13 and 2250.

Classifications: UL Listed as PLTC-Power Limited Tray Cable and as ITC-HL - Instrument Tray Cable/Hazardous Locations for use in accordance with Article 727 and Article 725 of the National Electrical Code.

Cables comply with ISA-S-50-02, UL 2250 and UL 13 for Fieldbus circuits and CL2 and CL3.

Applications

C-L-X OKOBUS® cables are designed for use in rugged plant and off-shore marine

environments utilizing networked discrete or process automation and control. ITC-HL (Instrument Tray Cable - Hazardous Locations) eliminates the need for conduit when installed in accordance with NEC Article 501.10(A)(1)(d) "ITC-HL" installations. Fully complies with ANS/ISA 50.02 Part 2 Fieldbus Cable.

The isolated individual shields over each pair, in SP-OS cables, when properly grounded, prevent crosstalk or capacitive coupling between adjacent pairs which occurs with ac signals, particularly the pulse type.

The overall shield eliminates most of the static interference from the electrical field radiated by power cables and other electrical equipment.

The C-L-X sheath provides additional electrical shielding and physical protection against mechanical damage as well as complete protection against moisture or gases entering the cable.

Product Features

- Passes the UL 13 and IEEE 383 vertical tray flame tests.
- Passes IEEE 1202 vertical tray flame test.
- Sunlight & oil resistant.
- UL listed for direct burial.
- Complete pre-packaged, factory-tested wiring system-color coded.
- C-L-X enclosure permits installation in cable tray containing lighting and power cables without a barrier separator.
- Individual pairs are completely isolated.
- Impervious, continuous sheath excludes moisture, gases and liquids.
- C-L-X sheath exceeds equipment grounding conductor requirements of NEC Article 250.
- Lower installed system cost than conduit or EMT systems.

Okobus — C-L-X

Single Pair Type P-OS - Multi Pair Type SP-OS Type PLTC & Type ITC-HL Fieldbus Cable

Single Pair or Multiple Shielded Pairs - Overall Shield 300 V 75°C Rating

#18 AWG



Product Data Section 5: Sheet 48

Catalog Number	Number of Pairs	Inner Jacket Thickness - mils	Nominal Core O.D. Inches	C-L-X O.D. Inches	Outer Jacket mils	Nominal Cable O.D. - Inches	Cross-Sectional Area † (sq in)	Approx Net Weight (lbs/1000')	Approx Ship Weight (lbs/1000')
▲ 564-92-3301	1	45	0.34	0.53	40	0.62	0.30	155	194
561-92-3302	2	50	0.55	0.80	50	0.91	0.65	311	391
561-92-3304	4	60	0.71	0.93	50	1.04	0.85	400	480
561-92-3306	6	60	0.81	1.06	50	1.17	1.08	493	573
561-92-3308	8	70	0.91	1.15	50	1.26	1.25	587	693
561-92-3312	12	70	1.04	1.34	50	1.45	1.65	759	902
561-92-3316	16	70	1.17	1.47	50	1.58	1.96	902	1045
561-92-3320	20	80	1.33	1.64	50	1.75	2.41	1072	1236
561-92-3324	24	80	1.46	1.78	50	1.89	2.81	1308	1495

† Cross-sectional area for calculation of cable tray fill in accordance with NEC Section 392.22.

Copper or bronze C-L-X available on special order.

Length Tolerance: Cut lengths of 1000 feet or longer are subject to a tolerance of ± 10%; less than 1000 feet ± 15%.

▲ **Authorized Stock Item:** Available from our Customer Service Centers.

CHARACTERISTICS

- a) Characteristic Impedance, Z_0 , at fr (31.25kHz), minimum100 ohms
- b) Maximum attenuation at 1.25 fr (39 kHz).....3.0 dB/km
- c) Maximum capacitive unbalance to shield.....2 nF/km
- d) Maximum DC resistance (per conductor)24 ohms/km
- e) Maximum propagation delay change 0.25 fr to 1.25 fr.....1.7 μ s/km
- f) conductor cross-sectional area nominal (wire size)0.8 mm² (#18 AWG)
- g) Minimum shield coverage100%





C-L-X X-Olene® P-OS, SP-OS

UL Type MC-HL, PLTC, ITC-HL and cUL ACIC-TC Instrumentation Cable
 Single Pair/Triads or Multiple Shielded Pairs/Triads - Overall Shield
 600 Volts 90°C Rating: UL MC-HL and cUL ACIC-TC
 300 Volts 90°C Rating: UL PLTC & ITC-HL
For Cable Tray Use Sunlight Resistant For Direct Burial -50°C



- A Copper Stranded Conductor
- B X-Olene Insulation
- C Tinned Stranded Copper Group Drain Wire
- D Aluminum/Polyester Tape
- E Twisted, Shielded Pairs
- F Aluminum/Polyester Tape
- G Tinned Stranded Copper Drain Wire
- H Rip Cord
- J Inner Okoseal Jacket
- K Impervious, Continuous, Corrugated Aluminum C-L-X Sheath
- L Outer Okoseal Jacket

Specifications

Conductors: Bare copper, Class B, stranded per ASTM B-8.

Insulation: X-Olene (XLPE), per UL 13, 2250 & 1569, 30 mils nominal thickness, 90°C temperature rating. Meets MIL-DTL-1377H, section 4.8.4.1.2 Cold Bend at -66°C and ASTM D746-04 brittlepoint at -76°C.

Conductor Identification: Pigmented black and white in pairs, black, red and white in triads; white conductor numerically printed for group identification.

Pair Shield: Aluminum/Polyester tape overlapped to provide 100% coverage, and a Class B tinned copper drain wire, two sizes smaller than the conductor. All multi-pair shields are isolated from each other.

Multiple Pair Assembly: Pairs assembled with a left-hand lay. Cable fillers included where required to provide a round cable.

Multiple Pair Cable Shield: Aluminum/Polyester tape overlapped to provide 100% coverage, and a class B strand tinned copper drain wire, same size as conductor.

Inner Jacket: Black, flame-retardant, low temperature Okoseal® (PVC) per UL 13 and UL Standard 2250. The inner jacket meets the thickness requirements of UL standard 1277. A rip cord is laid longitudinally under the jacket to facilitate removal.

C-L-X Sheath: A close-fitting, impervious, continuously welded and corrugated, aluminum sheath provides complete protection against moisture, liquids, and gases, has excellent mechanical strength, and provides equipment grounding through the sheath.

Outer Jacket: Black, flame-retardant, low temperature Okoseal per UL 13 and UL Standard 2250.

Applications

ITC-HL and MC-HL cables eliminate the need for conduit when installed in accordance with NEC Article 501.10(A)(1)(d) "ITC-HL" or 501.10(A)(1)(C) "MC-HL" installations. UL listed as PLTC-Power Limited Tray Cable and as ITC-HL - Instrument Tray Cable/Hazardous Locations for use in accordance with Article 725 (Class 1, 2 & 3) and Article 727 of the National Electrical Code.

UL listed as MC-HL for use in Class I, II, and III, Divisions 1 and 2 hazardous location in accordance with NEC Articles 501, 502, 503, 504 & 505; in Zone 2, Class II Div 2, Class III Div 1 and Class III Div 2 per CEC.

The isolated individual shields over each pair, in SP-OS cables, when properly grounded, prevent crosstalk or capacitive coupling between adjacent pairs while the overall shield eliminates most of the static interference from the electrical field radiated by power cables and other electrical equipment.

Product Features

Complete pre-packaged, factory-tested wiring system-color coded.

C-L-X enclosure permits installation in cable tray containing lighting and power cables without a barrier separator.

Lower installed system cost than conduit or EMT systems.

Applicable Standards

- UL listed for cable tray use, direct burial, in ducts, and sunlight resistant.
- Vertical Tray Flame Tests; IEEE 383-1974 & FT4/IEEE 1202.
- UL listed at -50°C. Also, meets the CSA 22.2 No.3 Cold Impact Test at -45°C.
- API Standards 14F and 14FZ.
- ASTM B-8.
- OSHA Acceptable
- UL 2225 Type MC-HL & UL 1569
- NEC Articles 501, 502, 503, 504 and 505 for Classes I, II, and III, Divisions 1 and 2 Hazardous Locations.
- UL listed as PLTC-Power Limited Tray Cable and as ITC-HL - Instrument Tray Cable/Hazardous Locations for use in accordance with Article 725 (Class 1, 2 & 3) and Article 727 of the National Electrical Code.
- NPLF per NEC Code Article 760.
- CSA C22.2 No. 230 Type TC
- CSA C22.2 No. 239 type ACIC
- cUL listed as Type ACIC-TC complies with CEC Zone 2, Class II Div 2, Class III Div 1, Class III Div 2 Hazardous Locations.

C-L-X X-Olene P-OS, SP-OS



Product Data Section 5: Sheet 49

UL Type MC-HL, PLTC, ITC-HL and cUL ACIC-TC Instrumentation Cable
 Single Pair/Triads or Multiple Shielded Pairs/Triads - Overall Shield
 600 Volts 90°C Rating: UL MC-HL and cUL ACIC-TC
 300 Volts 90°C Rating: UL PLTC & ITC-HL
For Cable Tray Use Sunlight Resistant For Direct Burial -50°C
#16 AWG

Catalog Number	Number of Pairs	Number of Triads	Inner Jacket Thickness - mils	Nominal Core O.D. Inches	C-L-X O.D. Inches	Outer Jacket mils	Nominal Cable O.D. - Inches	Cross-Sectional Area † (sq in)	Approx Net Weight (lbs/1000')	Approx Ship Weight (lbs/1000')
567-75-3401	1		45	0.35	0.58	50	0.69	0.37	180	219
567-70-3402	2		60	0.58	0.80	50	0.91	0.65	325	405
567-70-3404	4		60	0.70	0.93	50	1.04	0.85	424	504
567-70-3408	8		80	0.92	1.19	50	1.30	1.33	650	752
567-70-3412	12		80	1.10	1.37	50	1.48	1.73	842	985
567-70-3424	24		80	1.44	1.78	60	1.91	2.87	1450	1640
567-70-3436	36		110	1.82	2.19	60	2.32	4.23	2145	2480
567-76-3401		1	45	0.37	0.58	50	0.69	0.37	195	234
567-71-3402		2	60	0.64	0.89	50	1.00	0.79	376	456
567-71-3404		4	60	0.75	1.02	50	1.13	1.00	500	580
567-71-3408		8	80	1.06	1.34	50	1.45	1.64	800	945
567-71-3412		12	80	1.26	1.56	60	1.69	2.24	1090	1235

#18 AWG

567-70-3302	2		45	0.50	0.71	50	0.82	0.53	253	333
567-70-3304	4		60	0.67	0.89	50	1.00	0.79	365	445
567-70-3308	8		60	0.83	1.06	50	1.17	1.08	503	583
567-70-3312	12		80	1.00	1.29	50	1.40	1.54	693	799
567-70-3324	24		80	1.34	1.64	60	1.78	2.48	1125	1290
567-70-3336	36		80	1.55	1.92	60	2.05	3.29	1545	1835
567-71-3302		2	60	0.62	0.84	50	0.95	0.71	326	406
567-71-3304		4	60	0.73	0.97	50	1.08	0.92	428	508
567-71-3308		8	80	0.98	1.24	50	1.35	1.43	658	764
567-71-3312		12	80	1.15	1.47	50	1.58	1.96	860	1003
567-71-3324		24	80	1.58	1.96	60	2.09	3.42	1505	1760

ELECTRICAL SPECIFICATIONS

Conductor Resistance, nominal - ohms/1000 ft.@20°C@25°C	
16 AWG	4.344.43
18 AWG	6.937.07
Insulation Test Voltage (spark test)	7500 Volts ac
Dielectric Test Voltage	3000 Volts ac
Insulation Resistance Constant @60°F minimum ...	10,000 ohms-1000 ft.
Loop Resistance, nominal (2 cdr.) - ohms/1000 ft .@20°C@25°C	
16 AWG	8.688.86
18 AWG	13.914.2
Mutual Capacitance (PF/ft.)*	
#16	23
#18	21

*Typical Value

† **Cross-sectional** area for calculation of cable tray fill in accordance with NEC Section 392.9.

Jackets - Optional jacket types available - consult local sales office.

Copper or bronze C-L-X available on special order.

To order without the outer Okoseal jacket (not "HL" listed), change the sixth digit of the catalog number from 3 to 1, for example to order 1 pr. 16 AWG with a bare aluminum C-L-X, the catalog number would be 567-75-1401.

Length Tolerance: Cut lengths of 1000 feet or longer are subject to a tolerance of ± 10%; less than 1000 feet ± 15%.





Okonite X-Ray/Hi-Voltage Cable

Low Noise

65kV, 75kV, 100kV, 230kV and 250kV dc Rating
Three Conductor or Four Conductor

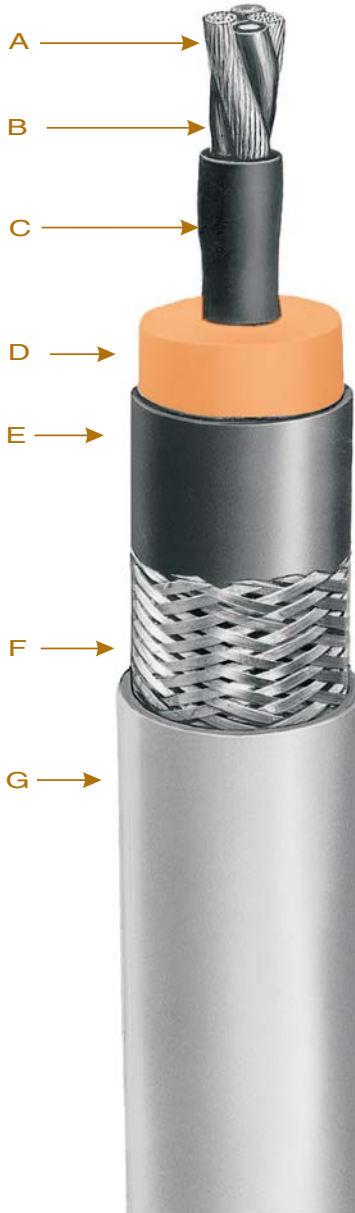

- A Coated Stranded Copper Conductors
- B Polyester Insulation
- C Extruded Semiconducting Layer
- D Primary Insulation – Okoguard
- E Extruded Insulation Shield
- F Coated Copper Braid
- G Jacket – Okoseal

Applications

Okonite X-Ray cables are suitable for use on X-Ray apparatus for medical, industrial, research and control applications. They give trouble-free performance where pulse type high voltages are required. Although primarily used with medical diagnostic imaging equipment, Okonite X-Ray cables are also used with equipment in industrial applications as well as in research projects where high voltages, low power are required.

Okonite LOW NOISE X-Ray cables have specifically been designed for use where sensitive measurements are required. These LOW NOISE cables are manufactured and assurance tested to meet less than 10 picocoulomb discharge thereby reducing noise to a minimum.

Okonite LOW NOISE X-Ray cables are offered at 65kV, 75kV, 100kV, 230kV and 250kV dc ratings.

Typically, Okonite X-Ray cables are used to supply the anode and cathode voltages to the X-Ray tube. Since one terminal operates at a negative potential and the other at a positive potential, the voltage across the X-Ray tube is twice (2X) the rated voltage of the cable.

The two usual constructions are (1) three conductor (3/C) used on typical cathode cable installations, and (2) four conductor (4/C) utilized on installations with a grid controlled lead. Upon request, designs and constructions can be developed for special applications.

Product Features

- Low Noise - < 10 pC @ 200 Vac/mil of insulation to 42 kV max.
- Performance tested for long trouble-free service.
- Small diameter.
- Flexible construction.
- Excellent flexing endurance.
- Mechanically rugged.
- Easy to strip and terminate.
- Resistant to most oils and chemicals.
- Complies with NEMA Standard XR-7 where applicable.

Installation

The minimum bending radius for permanent installation or flexing in service is four times the cable diameter.

Specifications

Cable Core: Each Low Noise cable core contains two insulated filament conductor. In 65, 75, and 100kV cable filament conductors are #15 AWG (19x) [1.65mm²] tinned copper insulated with heat sealed color coded polyester tape. In 230kV cables, the filament wires are #16 AWG (19x) [1.31mm²] tinned copper. The 250 kV cable filaments are #14 AWG (19x) [2.08mm²] tinned copper. Both the 230 and 250kV filament wires are insulated with an extrusion of ETFE. Four conductor cables include one #20 AWG (7x) [0.52mm²] copperweld conductor per ASTM B-45 insulated with heat sealed polyester and shielded with metalized red polyester.

The tinned copper uninsulated conductor in 3/C 65, 75, 100 and 230kV cables is segmented into two #18 AWG [0.83mm²] flex stranded wires. The 4/C uninsulated conductor is segmented into three #18 AWG wires. A single #12 AWG (19x) wire is used in the 250kV cable.

Core Shield: An extruded layer of semiconducting compound encapsulates the composite core assembly.

High Voltage Insulation: Okonite's premium EPR (ethylene-propylene rubber) insulation. This ozone resistant high voltage dielectric is extruded in tandem with the semiconducting layers which insures an intimate and contaminant free interface between the layers.

Insulation Shield: A strippable extruded layer of semiconducting EPR compound is applied directly over the insulation.

Shield: A braid of tinned copper wires is applied directly over the insulation shield. Minimum coverage indicated in table.

Jacket: A flexible Okoseal (specially compounded PVC) jacket is extruded over the shield to provide additional mechanical strength and resistance to most oils and chemicals.

Okonite X-Ray/Hi-Voltage Cable

Low Noise

65kV, 75kV, 100kV, 230kV and 250kV dc Rating

Three Conductor or Four Conductor

Product Data Section 6: Sheet 1

	Description	Catalog Number	Tinned Copper Braid Coverage (%)	Cellophane Wrap (1)	Jacket Color	Insulation O.D. Inches ± 0.010	Insulation O.D. mm ± 0.25	Jacket O.D. Inches ± 0.015	Jacket O.D. mm ± 0.38	Net. Wt. (lbs/1000 ft.)	Net. Wt. (kg/100m)	Approx. Ship Weight (lbs/1000')	Approx. Ship Weight (kg/100m)
65kV	3 Conductors 2-#15 AWG insulated 1-(2-#18 AWG) uninsulated	504-22-6436	80	yes	Gray	0.465	11.81	0.605	15.36	219	33	243	36
	3 Conductors 2-#15 AWG insulated 1-(2-#18 AWG) uninsulated	504-22-3437 504-22-3495	80 95	no	Gray	0.510	12.95	0.650	16.50	247 258	37 38	279 297	42 44
75kV	4 Conductors 2-#15 AWG 1-#20 AWG Copperweld, insulated 1-(3-#18 AWG) uninsulated	504-22-4464	80	no	Gray	0.570	14.48	0.715	18.20	296	44	335	50
75kV Extra Small Diameter	3 Conductors 2-#15 AWG insulated 1-(2-#18 AWG) uninsulated	504-22-3415	80	no	Gray	0.490	12.45	0.620	15.75	228	34	267	40
100kV	3 Conductors 2-#15 AWG insulated 1-(2-#18 AWG) uninsulated	▲ 504-22-3436 ▲ 504-22-4437	80	no yes	Gray	0.620	15.75	0.785	19.94	341	51	380	57
	4 Conductors 2-#15 AWG 1-#20 AWG Copperweld, insulated 1-(3#18 AWG) uninsulated	504-22-4436 504-22-4437	80	no yes	Gray	0.660	16.75	0.845	21.46	391	58	446	66
230kV	3 Conductors 2-#16 AWG insulated 1-(2-#18 AWG) uninsulated	▲ 504-22-7410	80	no	Black	0.980 ±.020	24.89 ±.51	1.250 ±.025	31.75 ±.64	759	113	849	126
250kV	3 Conductors 2-#14 AWG insulated 1-(#12 AWG) uninsulated	504-22-9430	80	no	Black	1.280 ±.020	32.51 ±.51	1.505 ±.025	38.23 ±.64	1119	167	1250	186

▲ Authorized stock item. Available from our Customer Service Centers.

(1) Cable is helically wrapped with a cellophane tape to maintain cleanliness during installation and includes a pull cord for ease of removal.

- Designs for special applications upon request.

- Refer to Product Data Section 6 Sheet 1 for X-Ray Cable - Low Noise constructions.

Electrical Characteristics				
Rated Voltage Rectified dc kV (2)	Number of Conductors	Core to Shield Capacitance ± 10%		4/C only: Copperweld grid lead capacitance = 70 pF/ft. (230 pF/m).
		pF/ft.	pF/m	
65	3	52	170	Conductor resistance @ 25°C: #16 AWG (1.31 mm ²) tinned copper = 4.18 ohms/1000 ft (1.37 ohms/100 m) #15 AWG (1.65 mm ²) tinned copper = 3.51 ohms/1000 ft (1.15 ohms/100 m) #18 AWG (0.83 mm ²) tinned copper = 7.16 ohms/1000 ft (2.34 ohms/100 m) 2 X #18 AWG (0.83 mm ²) tinned copper = 3.58 ohms/1000 ft (1.17 ohms/100 m) 3 X #18 AWG (0.83 mm ²) tinned copper = 2.39 ohms/1000 ft (0.78 ohms/100 m) #20 AWG (0.52 mm ²) copperweld = 24.12 ohms/1000 ft (7.91 ohms/100 m) #14 AWG (2.08 mm ²) tinned copper = 2.73 ohms/1000 ft (0.895 ohms/100 m) #12 AWG (3.31 mm ²) tinned copper = 1.72 ohms/1000 ft (0.564 ohms/100 m)
75 (ESD)	3	49.5	162	
75	3	47	154	
75	4	57	187	
100	3	40	131	
100	4	49	159	
230	3	35	115	
250	3	31	101	

(2) Voltage rating is between the conductor and the shielding braid.



Okonite X-Ray/Hi-Voltage Cable

65kV, 75kV and 100kV dc Rating
Three Conductor or Four Conductor

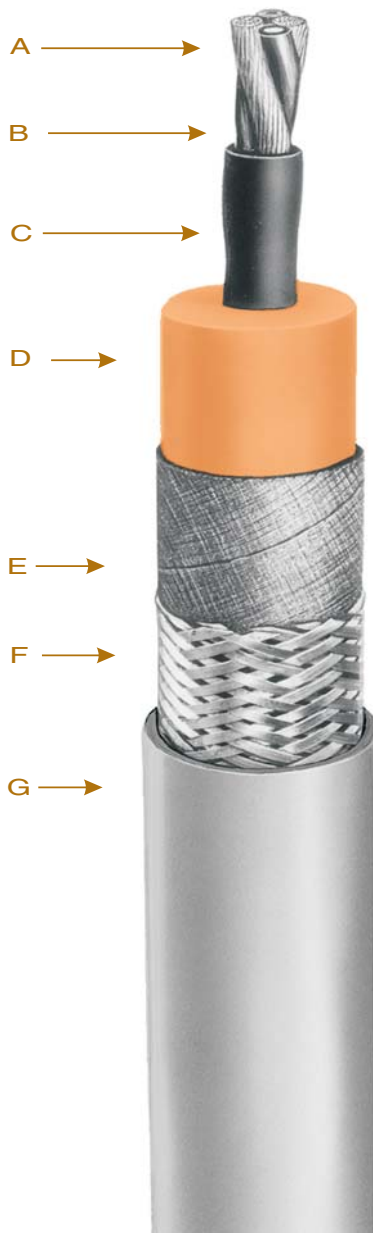

- A Coated Stranded Copper Conductors
- B Polyester Insulation
- C Extruded Semiconducting Layer
- D Insulation - Okoguard
- E Semiconducting Tape
- F Coated Copper Braid
- G Jacket - Okoseal

Applications

Okonite X-Ray cables are suitable for use on X-Ray apparatus for medical, industrial, research and control applications. They give trouble-free performance where pulse type high voltages are required. Although primarily used with medical diagnostic imaging equipment, Okonite X-Ray cables are also used with equipment in industrial applications as well as in research projects where high voltages, low power are required.

Typically, Okonite X-Ray cables are used to supply the anode and cathode voltages to the X-Ray tube. Since one terminal operates at a negative potential and the other at a positive potential, the voltage across the X-Ray tube is twice (2X) the rated voltage of the cable.

The two usual constructions are (1) three conductor (3/C) used on typical cathode cable installations, and (2) four conductor (4/C) utilized on installations with a grid controlled lead. Upon request, designs and constructions can be developed for special applications.

Product Features

- Performance tested for long trouble-free service.
- Small diameter.
- Flexible construction.
- Excellent flexing endurance.
- Mechanically rugged.
- Easy to strip and terminate.
- Resistant to most oils and chemicals.
- Complies with NEMA Standard XR-7 where applicable.

Installation

The minimum bending radius for permanent installation or flexing in service is four times the cable diameter.

Specifications

Cable Core: Each cable contains two #15 AWG (19x) [1.65mm²] tinned copper filament wires insulated with heat sealed color coded polyester tape. Three conductor cores include two uninsulated #18 AWG [0.83mm²] flex stranded tinned copper wires. Four conductor cables include one #20 AWG (7x)

[0.52mm²] copperweld conductor per ASTM - 45 insulated with heat sealed polyester and shielded with metalized red polyester. The four conductor core includes three uninsulated #18 AWG flex stranded tinned copper wires.

All conductors are twisted together into a composite assembly.

Core Shield: An extruded layer of semiconducting compound encapsulates the composite core assembly.

Insulation: Okonite's premium high voltage EPR (ethylene propylene rubber) insulation is extruded in tandem with the semiconducting compound ensuring an intimate contaminant free bond between the layers

Shield: A semiconducting tape is applied over the insulation with a tinned copper wire braid. Minimum coverage indicated in table.

Jacket: A light gray flexible Okoseal (specially compounded PVC) jacket is extruded over the shield to provide additional mechanical strength and resistance to most oils and chemicals.

Okonite X-Ray/Hi-Voltage Cable

65kV, 75kV, 100kV dc Rating

Three Conductor or Four Conductor

Product Data Section 6: Sheet 2

	Description	Catalog Number	#34 AWG T.C. Braid Coverage (%)	Cellophane Wrap (1)	Jacket Color	Insulation O.D. Inches ± 0.010	Insulation O.D. mm ± 0.25	Jacket O.D. Inches ± 0.015	Jacket O.D. mm ± 0.38	Net. Wt. (lbs/1000 ft.)	Net. Wt. (kg/100m)	Approx. Ship Weight (lbs/1000')	Approx. Ship Weight (kg/100m)
65kV	3 Conductors 2-#15 AWG insulated 1-(2-#18 AWG) un-insulated	504-22-6040	80	yes	Gray	0.465	11.81	0.605	15.40	219	33	252	38
		504-22-6041	80	no									
75kV	3 Conductors 2-#15 AWG insulated 1-(2-#18 AWG) un-insulated	▲ 504-22-3165	80	yes	Gray	0.510	12.95	0.650	16.50	236	35	273	41
		504-22-3164	80	no									
		504-22-3836	95	yes									
	4 Conductors 2-#15 AWG insulated 1-#20 AWG Copperweld, insulated 1-(3-#18 AWG) un-insulated	504-22-2164	80	no	Gray	0.570	14.48	0.715	18.20	289	43	333	50
75kV Extra Small Diameter	3 Conductors 2-#15 AWG insulated 1-(2-#18 AWG) un-insulated	▲ 504-22-3015	80	no	Gray	0.490	12.45	0.600	15.25	224	34	248	37
100kV	3 Conductors 2-#15 AWG insulated 1-(2-#18 AWG) un-insulated	504-22-1033	80	no	Gray	0.620	15.75	0.785	19.90	332	49	371	55
		504-22-1035		yes									
	4 Conductors 2-#15 AWG insulated 1-(#20 AWG) Copperweld, insulated 1-(3-#18 AWG) un-insulated	504-22-2041	80	no	Gray	0.660	16.75	0.845	21.50	380	57	441	66

▲ **Authorized stock item.** Available from our Customer Service Centers.

(1) Cable is helically wrapped with a cellophane tape to maintain cleanliness during installation and includes a pull cord for ease of removal.

- Designs for special applications upon request.

- Refer to Product Data Section 6 Sheet 1 for X-Ray Cable - Low Noise constructions.

Electrical Characteristics				
Rated Voltage Rectified dc kV (2)	Number of Conductors	Core to Shield Capacitance ± 10%		4/C only: Copperweld grid lead capacitance = 70 pF/ft. (230 pF/m).
		pF/ft.	pF/m	
65	3	52	170	Conductor resistance @ 25°C: #16 AWG (1.31 mm ²) tinned copper = 4.18 ohms/1000 ft (1.37 ohms/100 m) #15 AWG (1.65 mm ²) tinned copper = 3.51 ohms/1000 ft (1.15 ohms/100 m) #18 AWG (0.83 mm ²) tinned copper = 7.16 ohms/1000 ft (2.34 ohms/100 m) 2 X #18 AWG (0.83 mm ²) tinned copper = 3.58 ohms/1000 ft (1.17 ohms/100 m) 3 X #18 AWG (0.83 mm ²) tinned copper = 2.39 ohms/1000 ft (0.78 ohms/100 m) #20 AWG (0.52 mm ²) copperweld = 24.12 ohms/1000 ft (7.91 ohms/100 m)
75 (ESD)	3	49.5	162	
75	3	47	154	
75	4	57	187	
100	3	40	131	
100	4	49	159	
160	3	35	115	
250	3	31	101	
(2) Voltage rating is between the conductor and the shielding braid.				



Okoguard® Aerial Jumper Cable

15kV - 90°C Rating

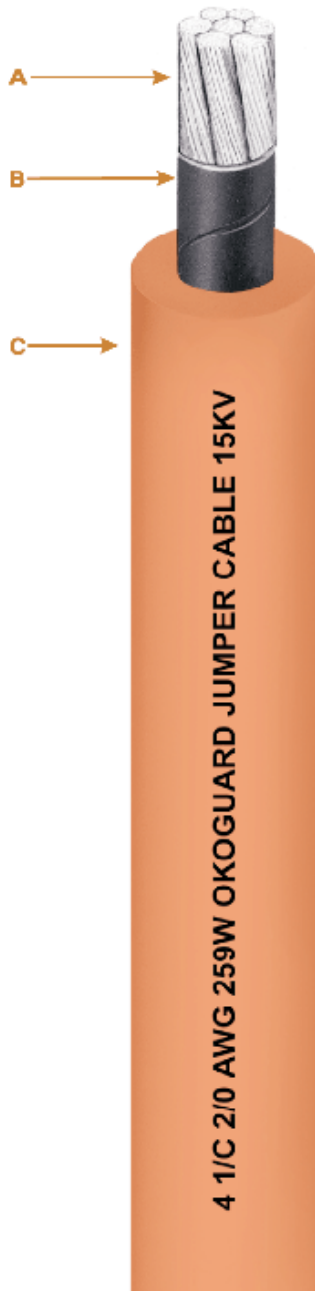

- A Coated, Stranded Copper Conductor
- B Strand Screen
- C Insulation/Jacket-Okoguard

Insulation/Jacket

Okoguard is Okonite's registered trade name for its exclusive ethylene-propylene base, thermosetting compound, whose optimum balance of electrical and physical properties is unequaled in other solid dielectrics.

This durable Okoguard insulation serves as a jacket as well. It is permanently embossed with a legend and has a natural, highly visible, red color.

Applications

Okoguard Portable Jumper cables are designed as flexible power leads for use with tap-off or jumper clamps which permit temporary connections or "by-pass" of energized aerial lines operating at voltages up to and including 15000V (phase to phase).

Specifications

Power Conductors: Extra-flexible rope tin coated copper per ASTM B-33, flexible rope stranded.

Conductor Screen: A taped conductive screen, whose purpose is to improve service life, dielectric strength and eliminate internal corona, meets and exceeds ICEA Standard S-96-639.

Insulation: Okoguard meets and exceeds ICEA Standard S-93-639.

Product Features

- Extra-flexible conductors for ease of handling under adverse conditions.
- Conductor screen for improved voltage stress control.
- Heat, moisture and ozone resistant 90°C Okoguard Insulation/Jacket.
- Okoguard is red for visual attention and it has good color stability even when exposed to strong sunlight.
- Excellent low temperature properties.

Okoguard Aerial Jumper Cable

15kV - 90°C Rating

Product Data

Section 6: Sheet 4

Catalog Number	Conductor Size AWG	Min. No. Strands	Nominal Cdr. Diameter - Inches	Approx. O.D. - Inches	Approx. O.D. - mm	Approx. Net Weight (lbs./1000')	Approx. Ship Weight (lbs./1000')	Amps Per Cdr.
15kV - Okoguard Insulation: #2 AWG Through #4/0 AWG, 210 mils								
▲ 303-21-1934	2	259	0.319	0.780	19.8	425	480	192
▲ 303-21-1938	1/0	259	0.408	0.863	22.0	583	638	258
▲ 303-21-1940	2/0	259	0.450	0.910	23.3	687	752	298
▲ 303-21-1944	4/0	437	0.592	1.052	27.2	997	1092	400

▲ **Authorized Stock Item.** Available from our Customer Service Centers

Minimum Order Quantity is 150 ft.

Standard Package —1000' N.R. Reel. Standard package will be furnished where orders do not specify otherwise.

Ampacities

Ampacity based on 90°C conductor temperature, 40°C ambient temperature.
For ampacity correction factors covering various ambient temperatures:

Ambient Temperature Degrees		Correction Factor
C	F	
10	50	1.26
20	68	1.18
30	86	1.10
40	104	1.00
50	122	0.90



Okoguard®-Okolon® TS-CPE 5kV Airport Lighting Cable*

FAA-L-824 Type B

One Okopact (Compact Stranded) Copper Conductor/90°C Rating Wet or Dry

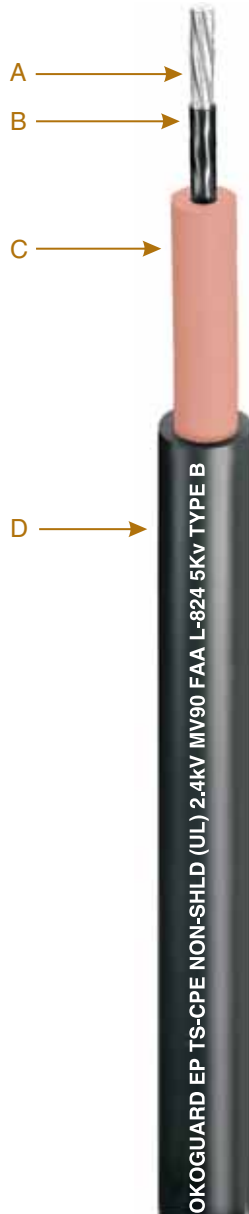

- A Uncoated, Okopact (Compact Stranded) Copper Conductor
- B Strand Screen-Extruded Semiconducting EPR
- C Insulation-Okoguard EPR
- D Jacket-Okolon TS-CPE

Insulation

Okoguard is Okonite's registered trade name for its exclusive medium voltage grade ethylene-propylene rubber (EPR) based, thermosetting compound, whose optimum balance of electrical and physical properties is unequaled in other solid dielectrics.

Okoguard insulation, with the distinctive red color and a totally integrated EPR system, provides the optimum balance for long, problem free service.

Jacket

The Okolon TS-CPE jacket on this cable is a vulcanized chlorinated polyethylene based compound which is mechanically rugged, flame, and oil resistant.

Applications

Okoguard-Okolon TS-CPE cables are heavy duty nonshielded cables designed for use at up to 5kV in wet or dry airport lighting applications.

Okoguard-Okolon TS-CPE nonshielded airport lighting cables are recommended for use in series lighting circuits for runways and control systems. Cables can be installed in metallic or non-metallic conduit, directly buried or aerial application.

Specifications

Meets or exceeds the requirements of FAA Advisory Circular AC 150/5345-7F.

Conductor: Annealed uncoated copper compact Class B stranded per ASTM B-496.

Strand Screen: Extruded semiconducting EPR strand screen. Meets or exceeds electrical and physical requirements of ICEA S-96-659/NEMA WC71.

Insulation: Meets or exceeds electrical and physical requirements of ICEA S-96-659/NEMA WC71. Insulation thickness per Table 4-3 for wet or dry applications.

Jacket: Meets or exceeds electrical and physical requirements of ICEA S-96-659/NEMA WC71 for chlorinated polyethylene jackets.

Product Features

- Resistant to runway and wing de-icers
- 90°C Continuous Rating, 130°C Emergency Overload Rating, 250°C Short Circuit Rating
- Exceptional resistance to surface tracking
- Superior Flexibility
- Constructed for "wet" location applications
- Excellent corona resistance
- Stress cones not required
- Resistant to most oils, acids, and alkalies

*Applications governed by the National Electrical Code limit non-shielded cable to 2.4kV

Catalog Number	Conductor** Size		Insulation Thickness		Jacket Thickness		Approx. O.D.		Approx. Net Wt. Lbs./1000'	Approx. Ship Wt. Lbs./1000'
	AWG	mm ²	mils	mm	mils	mm	inches	mm		
▲ 114-24-2213	8	8.4	125	3.18	80	2.03	0.60	15.1	215	250
▲ 114-24-2217	6	13.3	125	3.18	80	2.03	0.63	16.0	260	295

▲ **Authorized stock item.** Available from our Customer Service Centers.

**Class C stranded conductors are available.





Okonite® Armored Underground Signal Cables

With P.C.F. (Pull Cord Feature)

Heavy Duty Direct Burial Railroad Signal Cable

— AREMA Type I EPR Insulation — 600V

Multiple Copper Conductors/90°C Rating

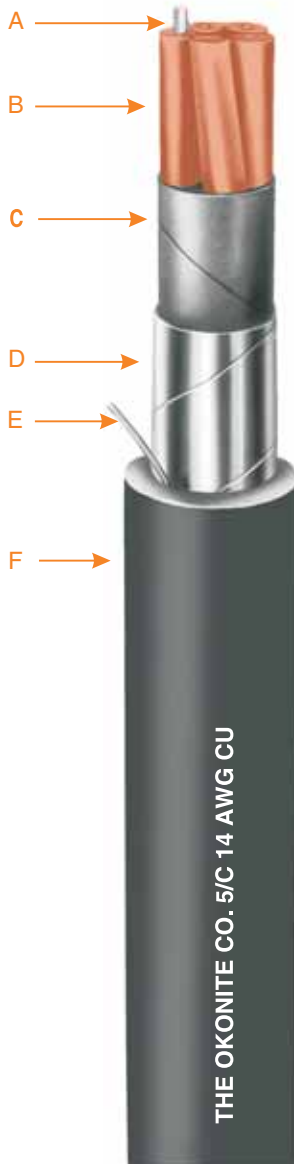

- A Solid or stranded, Uncoated Copper Conductors
- B Insulation—Okonite #14 AWG-#9 AWG 5/64", #6 - #2 AWG 6/64" with printed number code and tracer
- C Cushion Tape Layer
- D Flat Copper Alloy Armor Tape
- E Pull Cord
- F Jacket—Okolene with sequential footage markings

Insulation

Okonite EPR insulation is a heat, moisture and chemical resistant, mechanically rugged compound. The insulation thickness for size #14 AWG through #9 AWG is 5/64" and for #6 AWG through #2 AWG is 6/64". One conductor in each layer is identified as "Tracer". In addition, each conductor is number coded for ease of identification.

Assembly and Finish

Individual conductors are assembled with suitable fillers, where necessary, and a cable cushioning tape. A 7 mil flat copper alloy tape is then helically applied, giving outstanding mechanical protection. The black Okolene® (polyethylene) jacket is then applied overall.

Applications

Okonite Armored Underground Signal Cables are designed for use in all vital railroad signal circuits where security of service and long life are required in all vital circuit and safety related applications. These cables are recommended for use where crush resistance, termite and rodent protection are considerations and in all wet and dry locations.

Specifications

AREMA Signal Manual Part 10.3.17

Conductors: Solid uncoated copper per ASTM B-3, stranded uncoated compact round copper per ASTM B-496.

Insulation: Meets or exceeds electrical and physical requirements of ICEA S-95-658 (NEMA WC70) and AREMA Manual Part 10.3.19, thickness per table 10317-4.

Armor Tape: Copper alloy C19400 per ASTM B-465.

Jacket: Meets or exceeds electrical and physical requirements of ICEA S-95-658, Part 4.1.5.

Product Features

- Mechanically rugged.
- Resistant to aging.
- Easy to install and splice.
- Resistant to environmental hazards.
- Superior moisture resistance.
- Outstanding termite and rodent protection.
- Excellent electrical properties... high dielectric strength, low SIC and power factor and high insulation resistance.
- The Pull Cord feature affords easy and quick accessibility to conductors for splicing and terminating.
- Sequential footage markings on surface of outer jacket.

COMPOSITE CONSTRUCTIONS

Okonite Insulation: #14 AWG through #9 AWG 5/64", #6 AWG 6/64"

Catalog Number	Composite Make-Up	Conductors No. x Size (# Strands)	Conductors No. x Size (# Strands)	Outer Jacket Thickness 64th	Approx Cable O.D. (In.)	Approx Net Wt. Lbs./M'	Approx Ship Wt. Lbs./M
206-11-8974	7/C	2 x 9 (1X)	5 x 14 (1X)	5	0.99	523	574
▲ 206-11-8255	15/C	3 x 6 (1X)	12 x 14 (1X)	6	1.48	1711	1319
▲ 206-11-6283	19/C	6 x 6 (1X)	13 x 14 (1X)	6	1.69	1674	1877

▲ **Authorized Stock Item** - Available from Customer Service Centers.

Composite Cable Constructions are also available with stranded conductors. Consult your Okonite Representative.

Okonite Armored Underground Signal Cables

Product Data Section 7: Sheet 1

Okonite Insulation: #14 AWG Through #9 AWG, 5/64", #6 through #2 AWG, 6/64"

Catalog Number	Size AWG	No. of Strands (1)	No. Condrs.	Outer Jacket Thickness-64th	Approx. Cable O.D. Inches	Net Wt. Lbs./M'	Approx. Ship Wt. Lbs./M'
▲ 206-11-6882	14	Sol.	2	4	.65	208	241
206-11-6883	14	Sol.	3	4	.68	253	286
206-11-6884	14	Sol.	4	4	.74	300	338
▲ 206-11-6885	14	Sol.	5	4	.81	349	408
▲ 206-11-6887	14	Sol.	7	5	.91	451	510
206-11-6889	14	Sol.	9	5	1.05	579	671
206-11-6890	14	Sol.	10	5	1.12	698	790
▲ 206-11-6892	14	Sol.	12	5	1.17	700	792
206-11-6895	14	Sol.	15	6	1.33	871	994
206-11-6896	14	Sol.	16	6	1.33	906	1029
▲ 206-11-6899	14	Sol.	19	6	1.40	1028	1151
206-11-6901	14	Sol.	21	6	1.47	1127	1250
▲ 206-11-6907	14	Sol.	27	6	1.67	1388	1638
▲ 206-11-6910	14	Sol.	37	7	1.89	1834	2076
206-11-6692	12	Sol.	2	4	.68	240	273
206-11-6693	12	Sol.	3	4	.72	292	330
206-11-6694	12	Sol.	4	4	.78	354	392
206-11-6695	12	Sol.	5	4	.85	412	471
206-11-6697	12	Sol.	7	5	.96	535	594
206-11-6699	12	Sol.	9	5	1.11	689	781
206-11-6700	12	Sol.	10	5	1.19	774	866
206-11-6702	12	Sol.	12	5	1.24	847	952
206-11-6812	10	Sol.	2	4	.72	279	317
206-11-6813	10	Sol.	3	4	.76	346	384
206-11-6814	10	Sol.	4	4	.83	424	483
206-11-6815	10	Sol.	5	5	.94	518	577
206-11-6817	10	Sol.	7	5	1.02	654	746
206-11-6819	10	Sol.	9	5	1.18	842	934
206-11-6820	10	Sol.	10	6	1.30	973	1078
206-11-6822	10	Sol.	12	6	1.36	1076	1199
206-11-6922	9	Sol.	2	4	.75	317	350
▲ 206-11-6923	9	Sol.	3	4	.79	384	443
206-11-6924	9	Sol.	4	5	.90	495	554
▲ 206-11-6925	9	Sol.	5	5	.97	581	640
▲ 206-11-6927	9	Sol.	7	5	1.06	737	829
206-11-6928	9	Sol.	8	5	1.14	843	935
206-11-6929	9	Sol.	9	5	1.23	952	1057
▲ 206-11-6930	9	Sol.	10	6	1.35	1098	1221
206-11-6931	9	Sol.	12	6	1.42	1215	1338
▲ 206-11-6242	6	Sol.	2	5	.94	505	564
▲ 206-11-6243	6	Sol.	3	5	1.00	632	724
206-11-6244	6	Sol.	4	5	1.10	789	881
▲ 206-11-6245	6	Sol.	5	5	1.20	952	1044
▲ 206-11-6247	6	Sol.	7	6	1.34	1245	1368
206-11-6248	6	Sol.	8	6	1.45	1429	1552
206-11-6249	6	Sol.	9	6	1.56	1642	1820
▲ 206-11-6070	6	7	3	5	1.01	698	753
▲ 206-11-6042	4	7	2	5	1.02	619	674
▲ 206-11-6045	4	7	5	6	1.34	1266	1356
▲ 206-11-6130	2	7	3	6	1.28	1256	1346

Minimum Manufacturing Quantity is 1000 ft. Standard Package—1000' N.R. Reel.

▲ Authorized Stock Item - Available from Customer Service Centers.

(1) This construction is also available with stranded conductors. Consult your Okonite Representative.

E/14040701



Okonite®-Okolene® Duplex Track Wire 600V

One Copper Conductor/90°C Rating



A Solid Uncoated Copper Conductors
B Insulation - Okonite-Sizes #9 AWG and #8 AWG-5/64", #6 AWG-6/64"
C Jacket-Okolene, Color Coded; 1-Black, 1-Red

Insulation

Okonite EPR is Okonite's trade name for its heat resistant, mechanically rugged ethylene-propylene based insulating compound. The insulation thickness for wire sizes #9 AWG is 5/64" and for #6 AWG is 6/64".

Jackets and Finishes

The Okolene (PE) jacket supplied with this cable provides excellent resistance to mechanical abuse, weathering and most acids, oils and alkalis. Color Coded; 1-Black, 1-Red.

Applications

Okonite-Okolene 600V Duplex Track Wire is recommended for use in track circuits, signal operations, car retarder and switch machine applications. Can be installed in either wet or dry locations, in conduit trays or trough or buried direct.

Specifications

Conductor: Solid uncoated copper per ASTM B-3.

Insulation: Per ICEA S-95-658, and AREMA Signal Manual Part 10.3.19.

Jacket: Meets or exceeds the physical and electrical requirements of ICEA S-95-658, and AREMA Signal Manual Part 10.3.21

Product Features

- Exceptional heat resistance.
- 90°C Continuous Rating
130°C Emergency Overload Rating.
250°C Short Circuit Rating.
- Mechanically rugged.
- Flexible, easy to handle and splice.
- Resistant to most oils, acids, alkalis and effects of weather.
- Stable electrical and physical properties.
- Excellent moisture resistance.

Okonite Insulation: #9 AWG, 5/64", #6 AWG, 6/64"

Catalog Number	Size AWG	No. of Strands	Jacket Thickness 64 th's	Approx. Duplexed O.D. (In.)	Approx. Net Wt. Lbs./M'	Approx. Ship Wt. Lbs./M'
150-12-3931	9	Solid	4	0.83"	199	243
▲ 150-12-3933	6	Solid	4	1.00"	329	404

▲ Authorized Stock Item: Available from our Customer Service Center

Standard Package -1000' Non-Returnable Reel





Okonite® TC Blue Tower and Case Wire

600 Volt

One Copper Conductor/90°C Rating



- A Uncoated, Stranded Copper Conductor
- B Insulation—Okonite
- C Jacket—Blue Okoseal

Insulation

Okonite EPR is Okonite's trade name for its heat resistant, mechanically rugged ethylene-propylene based insulating compound. The insulation thickness for wire sizes are listed below.

Jackets and Finishes

The Blue Okoseal® (PVC) jacket supplied with this cable provides excellent resistance to mechanical abuse, flame, weathering, and most acids, oils, and alkalis.

Applications

Okonite Tower and Case Wire is recommended for use as relay and associated signal apparatus wiring and for connector wire use where a flexible, small diameter wire is required.

Specifications

Conductor: Uncoated stranded copper stranded per ASTM B-8.

Insulation: Per ICEA S-95-658. Meets or exceeds all requirements for EPR insulation.

Jacket: Per ICEA S-95-658. Meets or exceeds all requirements.

Okonite Tower and Case Wire meets or exceeds the requirements of AREMA Manual Part 10.3.15.

Product Features

- Exceptional heat resistance.
- 90°C Continuous Rating
130°C Emergency Overload Rating.
250°C Short Circuit Rating.
- Mechanically rugged.
- Flexible, easy to handle and splice.
- Flame resistant—meets U.L. horizontal flame test.
- Resistant to most oils acids, alkalis and effects of weather.
- Stable electrical and physical properties.

Catalog Number	Size AWG	No. of Strands	Insulation Thickness Mils	Jacket Thickness Mils	Approx. O.D. (In.)	Approx. Net Wt. Lbs./m'	Approx. Ship Wt. Lbs./m'
▲ 152-11-3002	16	19	30	20	.17	20	24
▲ 152-11-3024	14	19	30	20	.20	26	28
152-11-3026	12	19	45	20	.23	42	46
▲ 152-11-3038	10	19	30	20	.23	56	60
152-11-3108	10	37	45	20	.26	58	62
152-11-3010	9	19	45	25	.29	71	75

▲ **Authorized Stock Item** - Available from our Customer Service Centers.

Note: The construction described has a Blue Jacket. Consult your local Okonite Representative for details about alternate colors.

Standard Package - #16 AWG and #14 AWG, 10000 spool; #12 AWG, #10 AWG, and #9 AWG, 500' spool.





Okonite® Okolon® - (TS-CPE) Case Wire 600V

One Copper Conductor/90°C Rating



- A Uncoated, Stranded Copper Conductor
- B Insulation—Okonite—#16 AWG and #14 AWG - 2/64"; #12 AWG thru #6 AWG - 3/64"
- C Jacket - Okolon TS-CPE

Insulation

Okonite EPR is Okonite's trade name for its heat resistant, mechanically rugged ethylene-propylene based insulating compound. The insulation thickness for wire size #16 AWG and #14 AWG is 2/64" and for #12 AWG and #10 AWG it is 3/64".

Jackets and Finishes

The Okolon (TS-CP) jacket supplied with this cable provides excellent resistance to mechanical abuse, flame, weathering and most acids, oils and alkalies.

Applications

Okonite Okolon (TS-CP) 600V Case Wire is recommended for use as relay and associated signal apparatus wiring and for connector wire use where a flexible, small diameter wire is required.

Specifications

Conductor: Uncoated stranded copper per ASTM B-8.

Insulation: Per ICEA S-95-658.

Jacket: Per ICEA S-95-658, Part 4.1.13 and 4.1.3.

Product Features

- Exceptional heat resistance.
- 90°C Continuous Rating
130°C Emergency Overload Rating.
250°C Short Circuit Rating.
- Mechanically rugged.
- Flexible, easy to handle and splice.
- Flame resistant — meets U.L. horizontal flame test.
- Resistant to most oils, acids, alkalies and effects of weather.
- Stable electrical and physical properties.

Okonite Insulation: #16 AWG and #14 AWG - 2/64"; #12 AWG to #6 AWG - 3/64"

Catalog Number	Size AWG	No. of Strands	Jacket Thickness 64 th's	Approx. O.D. (In.)	Approx. Net Wt. Lbs./M'	Approx. Ship Wt. Lbs./M'
151-12-1051	16	19	1	.16	20	24
▲151-12-1081	14	19	1	.18	26	30
151-12-1101	12	19	1	.23	42	46
151-12-1140	10	19	1	.25	58	62
151-12-1171	9	19	1	.26	67	75
▲151-12-1201	6	19	1	.31	112	122

▲ Authorized Stock Item - Available from Customer Service Centers.

Standard Package — #16 AWG and #14 AWG, 1000' spool; #12 AWG thru #6 AWG, 500' spool.



THE OKONITE COMPANY

Ramsey, New Jersey 07446



Okonite®-Nylon Braid Case Wire

600V

One Copper Conductor/90°C Rating



A Uncoated, Stranded Copper Conductor
B Insulation—Okonite #16 and #14 AWG 2/64"; #12 AWG through #9 AWG 3/64"
C Finish—Nylon Braid with Lacquer Overall

Insulation

Okonite EPR is Okonite's trade name for its heat resistant, mechanically rugged ethylene-propylene based insulating compound. The insulation thickness for wire sizes #16 AWG and #14 AWG is 2/64" and for #12 AWG through #9 AWG it is 3/64".

Finish

The nylon braid and lacquer finish supplied with this cable provides excellent resistance to mechanical abuse, weathering and most oils, acids and alkalis.

Applications

Okonite-Nylon Braid 600V Case Wire is recommended for use as relay and associated signal apparatus wiring, and for connector wire use where a flexible, small diameter wire is required.

Specifications

Conductor: Uncoated, stranded copper conductor per ASTM B-8.

Insulation: Per ICEA S-95-658.

Finish: Black nylon braid (100% coverage) with clean lacquer finish.

Product Features

- Mechanically rugged.
- 90°C Continuous Rating
130°C Emergency Overload Rating.
250°C Short Circuit Rating.
- Mechanically rugged.
- Flexible, easy to handle and splice.
- Resists most oils, acids, alkalis and effects of weather.
- Stable electrical and physical properties.

Nominal Finish Thickness: 5 mils

Catalog Number	Size AWG	No. of Strands	Insulation Thickness 64 th's	Approx. O.D. (In.)	Approx. Net Wt. Lbs./M'	Approx. Ship Wt. Lbs./M'
▲ 151-12-9051	16	19	2	.14	16	20
151-12-9081	14	19	2	.15	22	26
151-12-9111	12	19	3	.20	38	42
151-12-9145	10	19	3	.22	50	54
▲ 151-12-9161	10	37	3	.23	51	55
151-12-9181	9	19	3	.24	62	66

▲ **Authorized Stock Item** — Available from our Customer Service Centers

Standard Package — #16 AWG and #14 AWG, 1000' spool;
#12 AWG, #10 AWG, and #9 AWG, 500' spool.





Type DEL

600-2000V Diesel-Electric Locomotive, Motor Traction and Car Wire

One Copper Conductor/90°C — 110°C Hot Spot Rating



- A Coated Stranded Copper Conductor
- B Separator (sizes 36,700 CM and larger)
- C Insulation - Okonite
- D Jacket - Okolon TS-CPE

Insulation

Okonite EPR® is Okonite's trade name for its heat resistant, mechanically rugged ethylene-propylene based insulating compound. The insulation thickness for DEL numbers 002 and 004 is 2/64", for 008 through 016 is 3/64", 018 through 026 is 4/64", 030 through 040 is 5/64", 044 and 048 is 6/64", 050 through 056 is 7/64" and for 058 it is 8/64".

Jackets and Finishes

The Okolon TS-CPE jacket supplied with this cable provides excellent resistance to mechanical abuse, flame, weathering, most oils, acids and alkalis.

Applications

Okonite Type DEL, Diesel-Electric Locomotive Traction and Car Wires is designed for use in locomotives and car equipment circuits where reliability is for prime consideration. DEL can also be used in other low voltage applications where flexibility is important. It is suitable for use in wet or dry locations, in conduits, ducts, cable troughs or trays.

Specifications

Conductor: Coated copper stranded per AREMA Recommended Practice, Section M, RP-588, as applicable and ICEA S-95-658.

Insulation: Per AREMA Recommended Practice, Section M, RP-588, as applicable and ICEA S-95-658.

Jacket: Per AREMA Recommended Practice, Section M, RP-588, as applicable and ICEA S-95-658.

Product Features

- Extreme heat resistance.
- Extra flexible conductor.
- 90°C Continuous Rating, 110°C Hot Spot Rating, 130°C emergency Overload Rating, 300°C Short Circuit Rating.
- Mechanically rugged.
- Exceptional resistance to deformation and cut through at high temperature.
- Excellent flame resistance. Meets both UL vertical and horizontal flame test requirements.
- Resistant to oils, weather and most chemicals and alkalis.
- Stable electrical properties at high temperatures.
- Meets the RHH/RHW requirements of NEC/UL and can be labeled as such on special orders.

Type DEL

600-2000V Diesel - Electric Locomotive, Motor Traction and Car Wire

One Copper Conductor/90°C - 110°C Hot Spot Rating

Product Data Section 7: Sheet 17

Catalog Number	DEL Number	Size AWG or MCM	No. of Strands	Thickness 64ths		Voltage Rating	Approx. O.D. In.	Approx. Wt. Lbs./M'		Ampacity ac or dc		Conduit Size Inches ³	DC Resis @ 25°C ohms/1000'
				Ins.	Jkt.			Net	Ship	1/C in Air ¹	3/C in Duct ²		
▲ 112-11-1702	002	16	19 X .0117	2	1	600	.16	19	23	—	18	1/2"	4.490
112-11-1704	004	14	19 X .0142	2	1	600	.17	24	28	—	22	1/2"	2.790
112-11-1708	008	14	19 X .0147	3	1	2000	.21	31	35	—	23	1/2"	2.790
112-11-1710	010	12	19 X .0179	3	1	2000	.22	40	44	—	26	1/2"	1.720
▲ 112-11-1714	014	10	27 X .0201	3	1	2000	.26	58	60	55	37	3/4"	1.100
112-11-1716	016	8	37 X .0201	3	1	600	.28	74	78	83	42	3/4"	0.690
112-11-1718	018	6	61 X .0201	4	2	2000	.38	133	141	109	73	1"	0.440
112-11-1720	020	5	91 X .0201	4	2	2000	.44	182	200	122	91	1 1/4"	0.350
112-11-1722	022	4	105 X .0201	4	2	2000	.46	204	222	145	98	1 1/4"	0.280
112-11-1724	024	3	125 X .0201	4	2	2000	.48	223	241	167	107	1 1/4"	0.220
112-11-1726	026	2	150 X .0201	4	2	2000	.53	278	298	192	125	1 1/2"	0.180
112-11-1730	030	1	225 X .0201	5	3	2000	.68	459	497	223	160	2"	0.140
112-11-1732	032	1/0	275 X .0201	5	3	2000	.71	504	550	258	184	2"	0.110
112-11-1734	034	2/0	325 X .0201	5	3	2000	.75	579	633	298	202	2"	0.090
112-11-1738	038	3/0	450 X .0201	5	3	2000	.85	769	842	345	252	2 1/2"	0.070
112-11-1740	040	4/0	550 X .0201	5	3	2000	.90	912	985	400	285	2 1/2"	0.060
112-11-1744	044	313.1	775 X .0201	6	3	2000	1.06	1263	1371	515	364	3"	0.040
112-11-1748	048	444.4	1100 X .0201	6	3	2000	1.20	1722	1830	645	450	3 1/2"	0.030
112-11-1750	050	535.3	1325 X .0201	7	4	2000	1.36	2118	2263	725	493	4"	0.020
112-11-1752	052	646.4	1600 X .0201	7	4	2000	1.45	2490	2700	815	555	4"	0.018
112-11-1754	054	777.7	1925 X .0201	7	4	2000	1.55	2938	3148	910	608	5"	0.016
112-11-1756	056	929.2	2300 X .0201	7	4	2000	1.65	3350	3560	1025	664	5"	0.013
112-11-1758	058	1111.1	2750 X .0201	8	4	2000	1.80	3786	4072	1145	728	5"	0.011

▲ **Authorized Stock Item** - Available from Customer Service Centers.

Standard Package - 1000' Non-Returnable Reel; #16 #8 - 1000' coil in carton; #6 - 500' coil in carton; #5 - #4/0 - 2000' N.R. Reel; #313.1 MCM and Larger - 1000' N.R. Reel

¹ Ampacities based on single conductor in free air, 90°C conductor temperature, 40°C ambient air temperature per ICEA S-75-381.

² Three (3) conductors in a single enclosed or exposed conduit. Ampacities based on 90°C conductor temperature and 40°C ambient using ICEA methods. For 30°C ambient multiply values by 1.10; for 50°C multiply by 0.90. For other ambients or installation conditions, refer to Engineering Data Book.

³ Based on three (3) conductors in conduit with a fill of 40% or less.



C-L-X Terminating Tool Kit



C-L-X TERMINATING TOOL KIT CONTENTS

- | | |
|--|---------------------------|
| 1 Cable Slitting Saw | 1 5/16" x 11" Screwdriver |
| 1 Small Cable Guide | 1 Cable Knife, 4" blade |
| 12 2" dia. High Speed Steel Saw Blades | 1 Hacksaw Blade Holder |
| 1 Tubing Cutter | 3 10" Hacksaw Blades |
| 1 Channel Lock Pliers | 1 Tool Case |
| 1 10" Retractable Tape | 1 Padlock with 2 keys |

PACKAGING

Catalog Number	Description	Net Weight (lbs.)	Shipping Weight (lbs.)
C-L-X Terminating Tool Kit			
▲ 606-01-1026	Electric - 120 Volt ac	15 1/2	16
▲ 606-01-1526	Pneumatic - 90psi	15 1/2	16
Cable Slitting Saw, Small Cable Guide and 12 High Speed steel saw Blades			
▲ 606-01-0026	Electric - 120 Volt ac	13 1/2	14
▲ 606-01-0526	Pneumatic - 90psi	13 1/2	14
12 High Speed Steel Saw Blades			
▲ 606-01-5754	2" diameter, 7 teeth per inch, packaged in a round tin container	1/2	1/2

▲ Authorized Stock Item

Applications

The C-L-X Terminating Tool Kit contains all the tools required to remove the overall jacket and aluminum sheath from C-L-X power, control, and instrumentation cables. The Cable Slitting Saw may also be used on interlocked armor and lead sheathed cables. The Cable Slitting Saw provides a simple and efficient means of removing the aluminum C-L-X sheath. It is available in either an electric or a pneumatic model. Both models have a retractable blade guard to protect the user.

The electric model is powered by a 2500 rpm, 120 Volt ac double insulated motor. A 220 Volt ac model is also available.

The lightweight pneumatic model is powered by a 2200 rpm motor which requires 90 psi of air pressure for maximum efficiency. The Small Cable Guide keeps the saw centered on the cable when slitting cables of 1" diameter or less.

The High Speed Steel Saw Blades provide a smooth cut in the aluminum sheath and have a cutting depth of 3/8" without the cable guide.

Removing the C-L-X Armor

This procedure applies to all types of C-L-X armor - aluminum, copper, bronze and stainless steel. Safe working practices are to be observed, e.g., safety glasses and work gloves. Practice sessions are recommended to familiarize all concerned with the procedures and equipment.

1. Remove the jacket to expose the desired length of un-armored cable within the enclosure.
2. Refer to the C-L-X fitting instructions for the length of C-L-X armor to be exposed beyond the end of the jacket and mark the C-L-X armor at the top of the crown nearest to that point.

- For C-L-X Diameters 1 5/8" and Smaller, Go To Steps 10 through 12.

- For C-L-X Diameters greater than 1 5/8" Follow Steps 3. Through 9.

C-L-X Terminating Tool Kit

3. First the C-L-X armor will be circumferentially cut using a hacksaw blade, (note the C-L-X saw tool kit is supplied with a hacksaw blade and blade holder) cut through the crown (high point) of the C-L-X at an angle so as to connect (or bridge) the valleys (low points) on both sides of the crown.
4. Again using a hacksaw blade, make a circumferential score in the valleys adjacent to the cut crown connecting both sides of the crown cut to the valleys. Do not cut through armor in valleys.
5. Holding the score area rigid, flex the cable by moving the free end so as to break the score around the circumference of the cable.
6. Next the C-L-X will be longitudinally cut by performing the following:

Note on the C-L-X Saw - The longitudinal cut is made with the C-L-X saw, which has an adjustable positive depth stop that can be set so the saw blade cuts through the crowns and partially cuts through the valleys. A proper saw depth is achieved when 80 to 95 % of the metal in the valley is removed. Use an extra piece of the cable being terminated to adjust the blade depth and practice.

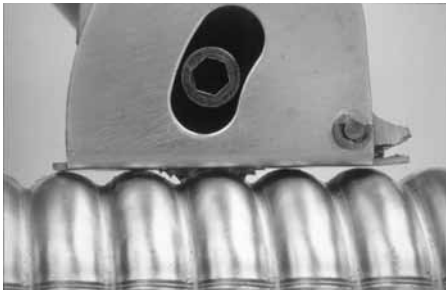

Set blade to remove 80 to 95% of the metal thickness in the valley.

7. With cable secured, start at the free end of the cable and advance the Kett saw, making sure to use slight downward pressure to maintain the depth of cut along the cable, to the ring cut. When advancing the saw, be sure maintain a straight line by cutting along the high point of the cable; this affects the cut depth also. See following:

Proper Saw Position

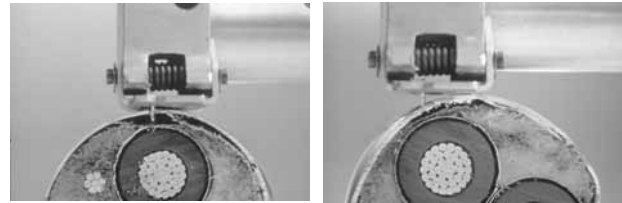

Correct

Incorrect

If it is necessary to stop cutting or if a portion of the cut is to be repeated, use caution when reinserting the blade as kickback may occur.

8. At the completion of the longitudinal cut, starting at the free end, insert a wide blade screwdriver into the cut and twist. Repeat until the ring cut is reached. This will cause the remaining metal in the valleys to break open and the armor to loosen on the cable. Do not drive the screwdriver into the cut with excessive force as this may damage the underlying conductors.
9. Slide the armor off the cable. In the event that the armor is tight around the cable, pliers may be used to grab the armor at the split and pull it away from the cable. For large diameter cables, where long lengths of armor are to be removed, two cuts spaced 180° apart are recommended so that the armor may be removed in two pieces.
 - For C-L-X Diameters 1 5/8" and Smaller Follow Steps 10. Through 13.
10. Using a hacksaw blade or tubing cutter, circumferentially score the C-L-X armor. Grip the cable in both hands with the score centered between hands, and flex the cable at the score line until it opens. Slide the sheath off the cable.
11. For C-L-X cables with an inner jacket or cable constructions where the C-L-X armor is tight fitting around the insulated conductors, the C-L-X saw should be used with the optional red colored cable guide. This guide assists in centering the saw on small diameter cable. The procedures and precautions of steps 3 to 9 apply here also.
12. Remove the cable fillers and marker tape and install the C-L-X fitting as per the manufacturer's instructions. The cable is now ready to be terminated into the enclosure.

CONDUCTOR COLOR CODING SEQUENCE

ICEA S-73-532 TABLE E-2
Color Sequence (No Green or White Conductors)

Conductor Number	Base Color	Tracer Color
1	Black	—
2	Red	—
3	Blue	—
4	Orange	—
5	Yellow	—
6	Brown	—
7	Red	Black
8	Blue	Black
9	Orange	Black
10	Yellow	Black
11	Brown	Black
12	Black	Red
13	Blue	Red
14	Orange	Red
15	Yellow	Red
16	Brown	Red
17	Black	Blue
18	Red	Blue
19	Orange	Blue
20	Yellow	Blue
21	Brown	Blue
22	Black	Orange
23	Red	Orange
24	Blue	Orange
25	Yellow	Orange
26	Brown	Orange
27	Black	Yellow
28	Red	Yellow
29	Blue	Yellow
30	Orange	Yellow
31	Brown	Yellow
32	Black	Brown
33	Red	Brown
34	Blue	Brown
35	Orange	Brown
36	Yellow	Brown
37	Black	

Color Coding per ICEA
Method 1, E-2
Sizes 8 AWG and larger:
Surface Printing of Numbers per
ICEA Method 4

Special Order: Any or all of the following conductors may be added when specifically requested by the customer to meet his specific application requirements. These conductor codings comply with UL and NEC requirements

Purpose	Base Color	Tracer Color
Equipment Grounding	Uninsulated	
	Green	
	Green	1 or more continuous yellow stripes
Grounded	White	
	White	Black continuous stripe
	White	Red continuous stripe
	White	Blue continuous stripe
	White	Orange continuous stripe
	White	Brown continuous stripe
	White	Numeric Printing

CONDUCTOR COLOR CODING SEQUENCE

ICEA S-73-532 TABLE E-1
Color Sequence (INCLUDES GREEN AND WHITE CONDUCTORS)

Conductor Number	Base Color	Tracer Color
1	Black	—
2	White	—
3	Red	—
4	Green	—
5	Orange	—
6	Blue	—
7	White	Black
8	Red	Black
9	Green	Black
10	Orange	Black
11	Blue	Black
12	Black	White
13	Red	White
14	Green	White
15	Blue	White
16	Black	Red
17	White	Red
18	Orange	Red
19	Blue	Red
20	Red	Green
21	Orange	Green

CONDUCTOR IDENTIFICATION INFORMATION

E-1 Color sequences for utility conductor identification, see Appendix E, Table E-1, ICEA Standard S-73-532, includes green and white.

E-2 Color sequence for industrial conductor identification, see Appendix E, Table E-2, ICEA Standard S-73-532, excludes green and white.

METHOD-1 Conductor identification, colored compounds with tracers in accordance with the ICEA standard.

METHOD-2 Conductor identification, neutral compounds with tracers in accordance with the ICEA Standard.

METHOD-3 Conductor identification, neutral or single colored compounds with surface printing of numbers and color designations in accordance with the ICEA Standard.

METHOD-4 Conductor identification, neutral or single colored compounds with surface printing of numbers in accordance with the ICEA Standard.

METHOD-5 Conductor identification, individual color coding with braids in accordance with the ICEA Standard.

MISCELLANEOUS INFORMATION

Decimal equivalents of one inch

Table 9-2

8ths	16ths	32nds	64ths	Decimal
—	—	—	1	.015625
—	—	1	2	.03125
—	—	—	3	.046875
—	1	2	4	.0625
—	—	—	5	.078125
—	—	3	6	.09375
—	—	—	7	.109375
1	2	4	8	.125
—	—	—	9	.140625
—	—	5	10	.15625
—	—	—	11	.171875
—	3	6	12	.1875
—	—	—	13	.203125
—	—	7	14	.21875
—	—	—	15	.234375
2	4	8	16	.25
—	—	—	17	.265625
—	—	9	18	.28125
—	—	—	19	.296875
—	5	10	20	.3125

Useful Identities, Equations and Conversion Factors

1 mil = 0.001"

1 circular mil = (1 mil)²

Area of a circle = Πr^2 or $\Pi D^2/4$

where,

$\Pi = 3.1416$

r = radius

D = diameter

1 mm = 39.4 mils

1 mile = 5280 ft

1 km = 0.6214 miles

1 km = 3281 ft

1 mile = 1.609 km

1 inch = 25.4 mm

1 meter = 3.281 ft

1 meter = 39.37 inches

1 ton (US) = 2000 lbs

To Convert	Multiply by	To Obtain
mils	0.0254	millimeters
circular mils	5.07×10^{-4}	square millimeters
inches	1.0×10^3	mils
inches	25.4	millimeters
feet	3.048×10^{-4}	kilometers
miles	1.609	kilometers
kilometers	0.6214	miles
kilometers	3.281×10^3	feet
pounds	0.4536	kilograms
pounds	4.448	Newtons (joules/meter)
pounds/ft	1.488	kilograms/meter
tons (US)	0.9078	tons (metric)
psi	0.00689	megapascals (Mpa)
volts/mil	0.03937	kV/mm
ohms/1000 ft	3.28	ohms/km
gigaohms - 1000 ft	305	gigaohms-meter

Temperature conversion table

Table 9-3

TO CONVERT DEGREES		
To C	F or C	To F
-65.	-85	-121
-62.22	-80	-112
-59.45	-75	-103
-56.67	-70	-94
-53.89	-65	-85
-51.11	-60	-76
-48.34	-55	-67
-45.56	-50	-58
-42.78	-45	-49
-40.	-40	-40
-37.22	-35	-31
-34.44	-30	-22
-31.67	-25	-13
-28.89	-20	-4
-26.11	-15	5
-23.33	-10	14
-20.56	-5	23
-17.78	0	32
-15.	5	41
-12.22	10	50
-9.44	15	59
-6.67	20	68
-3.89	25	77
-1.11	30	86
1.67	35	95
4.44	40	104
7.22	45	113
10.	50	122
12.78	55	131
15.56	60	140
18.33	65	149
21.11	70	158
23.89	75	167
26.67	80	176
29.44	85	185
32.22	90	194
35.	95	203
37.78	100	212
40.56	105	221
43.33	110	230
46.11	115	239
48.89	120	248
51.67	125	257
54.44	130	266
57.22	135	275
60.	140	284
62.78	145	293
65.56	150	302
68.33	155	311
71.11	160	320
73.89	165	329
76.67	170	338
79.44	175	347
82.22	180	356
85.	185	365
87.78	190	374
90.56	195	383
93.33	200	392
96.11	205	401
98.89	210	410
101.67	215	419
104.44	220	428
107.22	225	437
110.	230	446
112.78	235	455
115.56	240	464
118.33	245	473
121.11	250	482
123.89	255	491
126.67	260	500
129.44	265	509
132.22	270	518
135.	275	527

NOTES

NOTES

OKONITE CABLES

STOCK CATALOG

“▲” *In Stock for Immediate Delivery*



**THE
OKONITE
COMPANY**



INDEX

Data Sheet
Section:Sheet

GLOSSARY OF TERMS AND DEFINITIONS

MEDIUM VOLTAGE POWER CABLES 2.4kV AND ABOVE

Single Conductor Cable

Okoguard Non-Shielded Okolon TS-CPE Type MV-90 (CT USE) 2.4kV	2:2
Okoguard Shielded Okoseal Type MV-105 (CT USE) 5/8kV	2:3
Okoguard Shielded Okoseal Type MV-105 5/8 kV	2:4
Okoguard Shielded Okoseal Type MV-105 (CT USE) 15kV	2:8
Okoguard Shielded Okoseal Type MV-105 15kV	2:9
Okoguard Shielded Okolon TS-CPE Type MV-105 (CT USE) 15kV	2:11
Okoguard Shielded Okoseal Type MV-105 35kV	2:16
Okoguard Shielded Okoseal 69kV	2:18

Multi-Conductor Cable

Okoguard Shielded Okoseal Type MV-105 (CT USE) 3/C 5/8kV	2:19
Okoguard Shielded Okoseal Type MV-105 (CT USE) 3/C 15kV	2:20
Okoguard Non-Shielded C-L-X Type MV-90 or MC-HL (CT USE) 2.4kV	2:21
Okoguard Shielded C-L-X Type MV-105 or MC-HL (CT USE) 5/8kV	2:22
Okoguard Shielded C-L-X Type MV-105 or MC-HL (CT USE) 15kV	2:24
Solid Type PILC 3/C 15kV	2:31

UNDERGROUND RESIDENTIAL DISTRIBUTION CABLE

Okoguard URO-J 15kV	2:35
Okoguard URO-J 15kV Filled Strand	2:36
Okoguard URO-J 25kV	2:39
Okoguard URO-J 35kV	2:40

LOW VOLTAGE CABLES TO 2kV

Single Conductor Cable

Okoguard Okolon TS-CPE Type RHH or RHW-2 or USE-2, VW-1 600V RW-90	3:1
Okoguard Okolon TS-CPE Type RHH or RHW-2, 2000V	3:10

Multi-Conductor Cable

C-L-X Type MC-HL for CT USE (XHHW-2) 600V	4:1
C-L-X Type MC (XHHW-2) 600V	4:2
Okonite-FMR Okoseal Type TC 600V	4:5
X-Olene - Okoseal Type TC-ER Control Cable (XHHW-2) 600V	4:8
C-L-X Type MC for CT USE (XHHW-2) 600V Control Cable	4:14
C-L-X Type MC-HL for CT USE (XHHW-2) 600V Control Cable	4:15

INDEX

Data Sheet
Section:Sheet

INSTRUMENTATION CABLES

Okoseal Type P-OS 300V5:2
Okoseal Type P-OS C-L-X 300V5:3
Type SP-OS Instrumentation Cable5:13
Okoseal Type SP-OS C-L-X 300V5:14
Okoseal Type P-OS Thermocouple 300V5:18
C-L-X Okoseal Type P-OS Thermocouple 300V5:19
Okoseal-N Type P-OS 600V5:29
Okoseal-N Type SP-OS 600V5:31
Okoseal-N Type P-OS C-L-X Type MC-HL 600V5:40
Okoseal-N Type SP-OS C-L-X Type MC-HL 600V5:42
Okobus Type PLTC & Type ITC-ER Fieldbus Cable
Single Pair Type P-OS — Multi Pair Type SP-OS.....5:47
Okobus C-L-X.....5:48
C-L-X X-Olene P-OS, SP-OS5:49

SPECIAL PURPOSE CABLES

X-Ray Low Noise 65-250kV DC6:1
X-Ray 65-1000kV DC6:2
Okoguard Aerial Jumper Cable 15kV6:4
Okoguard-Okolon TS-CPE 5kV Airport Lighting Cable6:6

RAILROAD AND TRANSIT SYSTEM CABLES

Armored Signal Cable7:1
Track Wire7:6
Tower and Case Wire7:10
Case Wire7:11
Nylon Braid Case Wire7:12
Type DEL.....7:17

SPLICING AND TERMINATING PRODUCTS

C-L-X Terminating Tool Kit 6:5
Color Code Tables OSL
Miscellaneous Information OSL

INDEX

Data Sheet
Section:Sheet

INSTRUMENTATION CABLES

Okoseal Type P-OS 300V	5:2
Okoseal Type P-OS C-L-X 300V	5:3
Type SP-OS Instrumentation Cable	5:13
Okoseal Type SP-OS C-L-X 300V	5:14
Okoseal Type P-OS Thermocouple 300V	5:18
C-L-X Okoseal Type P-OS Thermocouple 300V	5:19
Okoseal-N Type P-OS 600V	5:29
Okoseal-N Type SP-OS 600V	5:31
Okoseal-N Type P-OS C-L-X Type MC-HL 600V	5:40
Okoseal-N Type SP-OS C-L-X Type MC-HL 600V	5:42
Okobus Type PLTC & Type ITC-ER Fieldbus Cable Single Pair Type P-OS — Multi Pair Type SP-OS.....	5:47
Okobus C-L-X.....	5:48

SPECIAL PURPOSE CABLES

X-Ray Low Noise 65-250kV DC	6:1
X-Ray 65-100kV DC	6:2
Okoguard Aerial Jumper Cable 15kV	6:4
Okoguard-Okolon TS-CPE 5kV Airport Lighting Cable	6:6

RAILROAD AND TRANSIT SYSTEM CABLES

Armored Signal Cable	7:1
Track Wire	7:6
Tower and Case Wire	7:10
Case Wire	7:11
Nylon Braid Case Wire	7:12
Type DEL.....	7:17

SPLICING AND TERMINATING PRODUCTS

C-L-X Terminating Tool Kit	6:5
Color Code Tables	OSL
Miscellaneous Information	OSL

GLOSSARY

INDUSTRY ASSOCIATIONS

ABS American Bureau of Shipping.

AEIC Association of Edison Illuminating Companies.

ANSI American National Standards Institute.

AREMA American Railway Engineering and Maintenance of Way Association

ASTM American Society for Testing and Materials.

ICEA Insulated Cable Engineers Association (formerly IPCEA).

IEC International Electrotechnical Commission

IEEE Institute of Electrical and Electronics Engineers.

NEC National Electrical Code.

NEMA National Electrical Manufacturers Association.

NFPA National Fire Protection Association.

GOVERNMENT AGENCIES

OSHA Occupational Safety and Health Act administered by U.S. Dept. of Labor which establishes employee safety standards in all industrial and commercial establishments.

RUS Rural Utility Systems of the U.S. Department of Agriculture, formerly REA.

FAA Federal Aviation Administration

EPA Environmental Protection Agency

DOE Department of Energy

FERC Federal Energy Regulatory Commission

OKONITE REGISTERED TRADE NAMES

C-L-X® Continuous-Lightweight-Exterior. Welded and corrugated, impervious metallic sheathed cables.

LOXARMOR® An interlocked "S" shaped armor cable covering, normally galvanized steel or aluminum.

OKOBON® A moisture resistant cable finish consisting of an aluminum/copolymer tape fused to itself and to an overall jacket.

OKOBUS Fieldbus instrumentation cable.

OKOCLEAR TP® (TPPO) Thermoplastic Polyolefin low smoke/zero halogen jacket compound.

OKOCLEAR TS® Thermosetting Polyolefin low smoke/zero halogen jacket compound.

OKOGUARD® Okonite's exclusive ethylene-propylene rubber (EPR) based, thermosetting insulation, with an optimum balance of electrical and physical properties unequalled in other solid dielectrics, used on power cables rated 600 V and above. (43rd Anniversary - 2011)

OKOLENE® Thermoplastic polyethylene or polypropylene based insulation or jacket compound.

OKONITE® Okonite's exclusive ethylene propylene rubber (EPR) based, thermosetting insulation used up to 2000V.

OKONITE-FMR® Okonite's exclusive flame and moisture resistant ethylene propylene rubber (EPR) insulation used up to 2000V.

OKOGUARD-OKOLON® Composite insulation system consisting of a layer of EPR and covered with a chlorinated thermoset compound.

OKO-PACK® Okonite's unique compact round conductor shape and design.

OKOSEAL® A PVC insulation or jacketing compound with excellent resistance to flame and most chemicals.

OKOSEAL-N® PVC insulated and nylon jacketed low voltage conductors, Type THHN, THWN-2 and TFN.

OKOLON TP-CPE® Thermoplastic moisture resistant CPE compound serving as an outer jacket.

OKOLON TS-CPE® Thermoset moisture resistant flame retardant CPE outer jacket.

OKOTHERM® Heat resistant silicone rubber based insulation for use in high temperature locations.

OKOZEL® Okonite's name for its ETFE based flame and radiation resistant insulating and jacketing compound.

P-30® Okolene-Okoseal insulated 600V multiple and single conductor control cable.

P-45® Okolene-Okoseal Insulated 1000V Multiple Conductor Control Cable.

X-OLENE® Okonite's name for its XLPE insulation and jacket.

STANDARD TERMS

AWG American Wire Gauge, based on the circular mil system where 1 mil equals 0.001 inch.

CIC Cable in Conduit for buried distribution systems.

CIC Circuit Integrity flame retardant cables

C-L-X-M C-L-X Marine Shipboard Cable

CPE Chlorinated Polyethylene jacketing material.

CSA Canadian Standards Association. An independent organization which implements and monitors the commercial and consumer electrical product standards. The CSA assures compliance to the various Canadian Electrical Code requirements.

CT Designation given to cables meeting UL requirements for cable tray use.

CTC Designation for Centralized Traffic Control Code Line cable.

CWCMC UL's designation for 600 volt C-L-X marine shipboard cable - "continuously welded corrugated MC" cable.

DEL Diesel Electric Locomotive and car wiring with Okonite insulation and Okolon jacket.

EPR Ethylene Propylene Rubber insulating compound ingredient.

ER Exposed Run, UL term designating cables approved for open wire applications.

ETFE Modified Ethylene Tetrafluoroethylene compound (Okozel) used for insulation and jackets.

FIELDBUS CABLE - High Speed digital signal transmission instrumentation cable having specific electrical characteristics.

FPL Power limited Fire Protective Signal Cable (NEC Art. 760). 300V rated

FMR Flame and Moisture Retardant.

HL Designation given to MC and ITC cables meeting NEC and UL requirements for use in Division 1 hazardous locations.

INSULATION LEVEL-100% Cable for use on grounded systems or where the system is provided with relay protection such that grounds faults will be cleared as rapidly as possible but in any case within one minute.

INSULATION LEVEL-133% Cable for use on ungrounded or grounded systems or where the faulted section will be de-energized in a time not exceeding one hour.

ITC Instrumentation Tray Cable for instrumentation & control circuits operating $\leq 150V$ and ≤ 5 amps., per NEC Article 727.

kcmil A unit of conductor area in thousands of circular mils. (Formerly MCM).

LOCA Loss of Coolant Accident, IEEE 383 defines test requirements.

LCS Longitudinal Corrugated Shield.

GLOSSARY (continued)

MC Metal-Clad cable. NEC type designation for power and control cables enclosed in a welded and corrugated metallic sheath (C-L-X), or an interlocking tape armor (Loxarmor). (Article 330)

MC-HL Metal-Clad cable listed for hazardous locations

mil 0.001 inch.

MV Medium Voltage cable. NEC designation for single & multiple conductor insulated cable rated 2001 to 35,000 volts. (NEC Article 328)

NPLF Non-Power Limited Fire Protective Signal Cable (NEC Art. 760). 600V rated

OKO-MARINE UL designation for non-armored Marine Shipboard Cable.

PLTC Type designation for Power-Limited Tray Cable for use in Class 2 or 3 power-limited circuits; instrumentation, supervisory control, and thermocouple extension.

P-NS Single pair or triad, Non Shielded, instrumentation or thermocouple extension cable.

P-OS Single or multi Pairs or Triads with Overall Shield, instrumentation or thermocouple extension cable.

POWER-LIMITED CIRCUIT Circuit either inherently limited requiring no overcurrent protection or limited by a combination of a power source and overcurrent protection.

PVC Polyvinyl Chloride insulating and jacketing material which is usually flame retardant and resistant to many chemicals.

P-104 Okonite's identification number issued by the Pennsylvania Department of Environmental Resources.

RHH NEC conductor type designation for conductors with Heat resistant rubber or XLPE insulation, for use in dry locations.

RHW-2 NEC conductor type designation for conductors with Heat and Moisture resistant rubber or XLPE insulation, for use in 90°C wet or dry locations.

RTA Thermoplastic insulated, aluminum shielded, polyethylene jacketed communication cable.

SCREEN A semiconducting nonmetallic layer used under and over the insulation of

power cables rated over 2kV to reduce electrical stresses and corona

SEMICONDUCTING An extruded layer or tape of such resistance that when applied between two elements of a cable the adjacent surfaces of the two elements will maintain substantially the same potential.

SHIELD A nonmagnetic, metallic material applied over an insulated conductor(s) to confine the electric field to the insulation.

SP-OS Multiple Shielded Pairs or Triads with Overall Shield, instrumentation or thermocouple extension cable.

TC NEC type designation for power and control tray cable. (Article 336)

TFN NEC conductor type designation for PVC insulated nylon jacketed conductors in sizes #18 and 16 AWG for use in dry locations.

THERMOCOUPLE CABLE - A cable consisting of two dissimilar metals or alloys that, when electrically joined at one end can be used to measure temperature. These cables have no voltage rating.

THHN NEC conductor type designation for PVC insulated nylon jacketed conductors for use in dry locations.

THWN-2 NEC conductor type designation for PVC insulated nylon jacketed conductors for use in 90°C wet or dry locations.

TPPO Thermoplastic Polyolefin, a thermoplastic jacket material with low smoke characteristics and is free of halogens.

UL Underwriters Laboratories. An independent organization which examines, tests, lists and periodically inspects equipment to appropriate standards.

URO-J Underground Residential distribution-Okoguard (EPR) insulation-Okolene Jacket employing a concentric neutral.

USE Underground Service Entrance cable. (NEC Article 338)

VERTICAL TRAY FLAME TEST

Conducted per UL, IEEE or ICEA procedures to demonstrate that a single conductor (1/0 AWG and larger) or multi-conductor cable will not propagate a fire in the defined test.

VOLTAGE LEVELS

Power-Limited - 0-300 Volts

Low Voltage - 600-2000 Volts

Medium Voltage - 2400-46000 Volts

High Voltage - >46 to 345kV

VOLTAGE RATING kV, industry convention to identify voltage levels, phase to phase voltage.

VW-1 Basic flammability test for single conductors; employs a tirrill burner applied intermittently to a Vertical Wire.

XHHW-2 NEC conductor type designation for conductors with Heat and Moisture resistant thermoset insulation for use in 90°C wet or dry locations.

XLPE Cross-Linked Polyethylene insulating compound.

XLPO Cross Linked Polyolefin, a thermoset jacket material with low smoke characteristics and is free of halogens.

Z NEC conductor type designation for conductors with ETFE insulation for use in dry locations.

ZW NEC conductor type designation for conductors with ETFE insulation for use in wet or dry locations.

CONDUCTOR IDENTIFICATION INFORMATION

E-1 Color sequences for utility conductor identification, see Appendix E, Table E-1, ICEA Standard S-73-532, includes green and white.

E-2 Color sequence for industrial conductor identification, see Appendix E, Table E-2, ICEA Standard S-73-532, excludes green and white.

METHOD-1 Conductor identification, colored compounds with tracers in accordance with the ICEA standard.

METHOD-2 Conductor identification, neutral compounds with tracers in accordance with the ICEA Standard.

METHOD-3 Conductor identification, neutral or single colored compounds with surface printing of numbers and color designations in accordance with the ICEA Standard.

METHOD-4 Conductor identification, neutral or single colored compounds with surface printing of numbers in accordance with the ICEA Standard.

METHOD-5 Conductor identification, individual color coding with braids in accordance with the ICEA Standard.



Okoguard®-Okolon® TS-CPE Type MV-90

2.4 kV Nonshielded Power Cable

One Okopact® (Compact Stranded)
Copper Conductor/90°C Rating Wet or Dry
For Cable Tray Use-Sunlight Resistant



- A Uncoated, Okopact (Compact Stranded) Copper Conductor
- B Strand Screen-Extruded Semiconducting EPR
- C Insulation-Okoguard EPR
- D Jacket-Okolon TS-CPE

Insulation

Okoguard is Okonite's registered trade name for its exclusive ethylene-propylene rubber (EPR) based, thermosetting compound, whose optimum balance of electrical and physical properties is unequalled in other solid dielectrics. Okoguard insulation, with the distinctive red color and a totally integrated EPR system, provides the optimum balance for long, problem free service.

Jacket

The Okolon TS-CPE jacket on this cable is a vulcanized chlorinated polyethylene based compound which is mechanically rugged, flame, radiation and oil resistant.

Applications

Okoguard-Okolon TS-CPE 2.4 kV cables are heavy duty nonshielded cables designed for use at up to 2.4 kV phase-to-phase in wet or dry locations in accordance with NEC Section 310.10.

Okoguard-Okolon TS-CPE nonshielded cables are recommended for power distribution and motor circuits in generating plants and substations; in industrial and commercial buildings.

Single conductors may be installed in industrial or commercial occupancies in triplexed or random lay in any raceway or duct in wet or dry locations, or in open runs as permitted by NEC Article 396.

Sizes 1/0 AWG and larger, may be installed in cable trays where permitted by NEC Section 392.10.

Specifications

Conductor: Annealed uncoated copper compact stranded per ASTM B-496.

Strand Screen: Extruded semiconducting EPR strand screen. Meets or exceeds electrical and physical requirements of ICEA S-96-659/NEMA WC71 and UL 1072.

Insulation: Meets or exceeds electrical and physical requirements of ICEA S-96-659/NEMA WC71 and UL 1072.

Jacket: Meets or exceeds electrical and physical requirements of ICEA S-96-659/NEMA WC71 for chlorinated polyethylene jackets.

UL listed as Type MV-90, sunlight resistant, -40°C and for use in cable tray in accordance

with UL 1072. CSA listed as RW90 as 5kV non-shielded (FT4 1/0 and larger) -40°C in accordance with CSA C22.2 No 38.

1/C non-shielded cables can surface discharge in service when in a random phase spacing or when in contact with grounded surfaces.

Product Features

- Okoguard cables meet or exceed all recognized industry standards (UL, CSA, NEMA/ICEA, IEEE).
- 90°C continuous operating temperature.
- 130°C emergency rating.
- 250°C short circuit rating
- Passes UL and IEEE 383 and 1202 (1/0 and larger) Vertical Tray Flame Test.
- Sizes 1/0 and larger meet CSA FT4 Vertical Tray Flame Test.
- Sizes #1 and smaller meet CSA FT1.
- Excellent corona resistance.
- Radiation resistant.
- Exceptional resistance to "treeing".
- Stress cones not required.
- Moisture resistant.
- Resistant to most oils, acids, and alkalis.
- Sunlight Resistant.
- Sizes #6 and #8 AWG are identified as FAA-L-824, Type B 5kV rated.

Okoguard-Okolon TS-CPE Type MV-90

2.4 kV Nonshielded Power Cable

One Okopact (Compact Stranded)

Copper Conductor/90°C Rating Wet or Dry

For Cable Tray Use-Sunlight Resistant



Product Data Section 2: Sheet 2

Catalog Number (1)	Conductor Size AWG or kcmil		Conductor Size -mm ²		Insulation Thickness -mils		Jacket Thickness - mm		Jacket Thickness - mils		Approx. O.D. - mm		Approx. O.D. - Inches		Approx. Net Weight lbs./1000'		Approx. Ship Weight lbs./1000'		Ampacities (2) Conduit in Air		Ampacities (3) Underground Duct		Ampacities (4) Cable Tray		Conductor Size Inches (5)*		
*▲ 114-24-2213	8	8.4	125	3.18	80	2.03	0.60	15.1	215	250	55	64	-	2													
*▲ 114-24-2217	6	13.3	125	3.18	80	2.03	0.63	16.0	260	295	75	85	-	2													
▲ 114-24-2219	4	21.2	125	3.18	80	2.03	0.67	17.1	328	368	97	110	-	2													
▲ 114-24-2221	2	33.6	125	3.18	80	2.03	0.73	18.6	427	492	130	145	-	2													
114-24-2223	1	42.4	125	3.18	80	2.03	0.76	19.4	493	558	155	170	-	2½													
▲ 114-24-2225	1/0	53.5	125	3.18	80	2.03	0.80	20.3	580	645	180	195	195	2½													
▲ 114-24-2227	2/0	67.4	125	3.18	80	2.03	0.88	22.4	682	742	205	220	225	2½													
114-24-2229	3/0	85.0	125	3.18	95	2.41	0.96	24.5	838	908	240	250	260	3													
▲ 114-24-2231	4/0	107.0	125	3.18	95	2.41	0.97	24.6	991	1086	280	290	300	3													
114-24-2233	250	127.0	140	3.56	110	2.79	1.08	27.4	1198	1293	315	320	335	3													
▲ 114-24-2237	350	177.0	140	3.56	110	2.79	1.18	29.9	1555	1660	385	385	410	3½													
▲ 114-24-2243	500	253.0	140	3.56	110	2.79	1.29	32.9	2075	2205	475	470	520	3½													
▲ 114-24-2249	750	380.0	155	3.94	125	3.18	1.54	39.0	3034	3224	600	585	675	5													
114-24-2251	1000	507.0	155	3.94	125	3.18	1.70	43.0	3891	4141	690	670	805	5													

* Marked "FAA L-824 5kV Type B".

Visit Okonite's web site, www.okonite.com for the most up to date dimensions.

▲ **Authorized stock item.** Available from our Customer Service Center.

Aluminum Okopact Conductors

(1) Aluminum conductors are available on special order.

Ampacities

(2) Ampacities are in accordance with Table 310.60(C)(73) of the NEC for three single Type MV-90 conductors, or single conductors twisted together (triplexed) and installed in an isolated conduit in air at an ambient temperature of 40°C and a conductor temperature of 90°C.

(3) Ampacities are in accordance with Table 310.60(C)(77) of the NEC for three single conductors or triplexed cable in one underground raceway, three feet deep with a conductor temperature of 90°C, 100% Load Factor, an ambient earth temperature of 20°C, and thermal resistance (RHO) of 90.

(4) Ampacities based on single Type MV-90 conductors, or single conductors twisted together (triplexed, quadruplexed, etc.), size 1/0 Awg and larger, installed in uncovered cable tray in accordance with Section 392.80(B) of the NEC at an ambient temperature of 40°C and a conductor temperature rating of 90°C.

In accordance with NEC Section 392.80(B)(2)(a), the ampacities are 75% of the values given in NEC Table 310.60(C)(69) (copper conductors). Where the cable tray is covered for more than six feet with solid unventilated covers, the ampacities shall not exceed 93% of the values shown above.

Refer to the NEC, IEEE/ICEA-S-135 Power Cable Ampacities, or the Okonite Engineering Data Bulletin for other ambient temperatures, circuit configurations or installation requirements.

(5) Recommended size of rigid or nonmetallic conduit for three conductors based on 40% maximum fill.

*The jam ratio, conduit I.D. to cable O.D. should be checked to avoid possible jamming.



Okoguard®-Okoseal® Type MV-105

5/8kV Shielded Power Cable

One Okopact® (Compact Stranded) Copper Conductor/105°C Rating
5kV-133% or 8kV-100% Insulation Level

For Cable Tray Use - Sunlight Resistant



- A Uncoated, Okopact (Compact Stranded) Copper Conductor
- B Strand Screen-Extruded Semiconducting EPR
- C Insulation-Okoguard EPR
- D Insulation Screen-Extruded Semiconducting EPR
- E Shielding-CopperTape
- F Jacket-Okoseal

Insulation

Okoguard is Okonite's registered trade name for its exclusive ethylene-propylene rubber (EPR) based, thermosetting compound, whose optimum balance of electrical and physical properties is unequalled in other solid dielectrics.

Okoguard insulation, with the distinctive red color and a totally integrated EPR system, provides the optimum balance of electrical and physical properties for long, problem free service.

The triple tandem extrusion of the screens with the insulation provides optimum electrical characteristics.

Jacket

The Okoseal (PVC) jacket supplied with this cable is mechanically rugged and has excellent resistance to oil, acids and most chemicals.

Applications

Okoguard shielded Okoseal Type MV-105 power cables are recommended for use as feeder circuits, in electric utility generating stations, for distribution circuits, and for feeders or branch circuits in industrial and commercial installations.

Type MV cables may be installed in wet or dry locations, indoors or outdoors (exposed to sunlight), in any raceway or underground duct, directly buried if installed in a system with a grounding conductor in close proximity that conforms with NEC Section 250.4(A)(5), or messenger supported in industrial establishments and electric utilities. Sizes 1/0 AWG and larger may also be installed in cable tray.

Specifications

Conductor: Annealed uncoated copper compact stranded per ASTM B-496.

Strand Screen: Extruded semiconducting EPR strand screen. Meets or exceeds electrical and physical requirements of ICEA S-93-639/NEMA WC74 & S-97-682, AEIC CS8, CSA C68.3 and UL 1072.

Insulation: Meets or exceeds electrical and physical requirements of ICEA S-93-639/NEMA WC74 & S-97-682, AEIC CS8, CSA C68.3 and UL 1072.

Insulation Screen: Extruded semiconducting EPR insulation screen applied directly over the insulation. Meets or exceeds electrical and physical requirements of ICEA S-93-639/NEMA WC74 & S-97-682, AEIC CS8, CSA C68.3 and UL 1072.

Shield: 5 mil bare copper tape helically applied with 25% minimum overlap.

Jacket: Meets or exceeds electrical and physical requirements of ICEA S-93-639/NEMA WC74 & S-97-682, CSA C68.3 and UL 1072 for polyvinyl chloride jackets.

UL Listed as Type MV-105 and sunlight resistant, in accordance with UL 1072.

CSA C68.3 listed and rated FT4.

Product Features

- Triple tandem extruded, all EPR system.
- Okoguard cables meet or exceed all recognized industry standards (UL, AEIC, NEMA/ICEA, IEEE).
- 105°C continuous operating temperature.
- 140°C emergency rating.
- 250°C short circuit rating.
- Passes UL and IEEE 383 and 1202 (1/0 AWG and larger) Vertical Tray Flame Test.
- Excellent corona resistance.
- Screens are clean stripping.
- Exceptional resistance to "treeing".
- Exceptional resistance to moisture.
- Resistant to most oils, acids, and alkalis.
- Sunlight resistant.
- For Cable Tray Use.
- CSA FT4.
- CSA ≤ 350: LTDD (-25C)
- CSA ≥ 500: LTGG (-40C)
- Improved Temperature Rating.

Okoguard-Okoseal Type MV-105

5/8kV Shielded Power Cable

One Okopact (Compact Stranded)

Copper Conductor/ 105°C Rating

5kV-133% or 8kV-100% Insulation Level

For Cable Tray Use - Sunlight Resistant



Product Data Section 2: Sheet 3

Okoguard Insulation: 115 mils (2.92mm), 5kV—133% or 8kV—100% Insulation Level

Catalog Number (1)	Conductor Size AWG or kcmil		Conductor Size -mm ²		Approx. Dia. over Insulation (in.)	Approx. Dia. over Screen (in.)	Jacket Thickness - mils	Jacket Thickness - mm	Approx. O.D. - Inches	Approx. O.D. - mm	Approx. Net Weight lbs./1000'	Approx. Ship Weight lbs./1000'			Ampacities Conduit in Air (2)	Ampacities Underground Duct (3)	Ampacities Cable Tray (4)	Conduit Size Inches (5)*
▲ 114-23-3824	1/0	53.5	0.61	0.67	60	1.52	0.81	20.6	615	655	200	210	220	2 1/2				
▲ 114-23-3826	2/0	67.4	0.65	0.71	60	1.52	0.85	21.6	720	775	225	235	245	2 1/2				
114-23-3865	3/0	85.0	0.70	0.76	80	2.03	0.95	24.1	895	950	270	270	290	3				
▲ 114-23-3832	4/0	107.0	0.75	0.81	80	2.03	0.99	25.2	1030	1090	305	310	335	3				
▲ 114-23-3834	250	127.0	0.80	0.86	80	2.03	1.05	26.7	1185	1250	355	345	370	3				
▲ 114-23-3838	350	177.0	0.89	0.95	80	2.03	1.14	29.0	1540	1625	430	415	460	3 1/2				
▲ 114-23-3846	500	253.0	1.01	1.07	80	2.03	1.26	32.0	2055	2155	530	505	580	3 1/2				
▲ 114-23-3873	750	380.0	1.19	1.26	80	2.03	1.45	36.9	2940	3120	665	630	750	4				
114-23-3855	1000	507.0	1.34	1.40	80	2.03	1.59	40.4	3781	3960	770	720	900	4				

Visit www.okonite.com for the most current cable data.

▲ **Authorized stock item.** Available from our Customer Service Center.

Aluminum Conductors

(1) Aluminum conductors are available on special order.

Ampacities

(2) Ampacities are in accordance with Table 310.60(C)(73) of the NEC for three single Type MV-105 5kV conductors or single conductors twisted together (triplexed) and installed in an isolated conduit in air at an ambient temperature of 40°C and a conductor temperature of 105°C. Refer to Table 310.60(C)(73) for 8kV ampacities

(3) Ampacities are in accordance with Table 310.60(C)(77) of the NEC for three single 5kV conductors or triplexed cable in one underground raceway, three feet deep with a conductor temperature of 105°C, 100% Load Factor, an ambient earth temperature of 20°C and thermal resistance (RHO) of 90. Refer to Table 310.60(C)(77) for 8kV ampacities.

(4) Ampacities based on single Type MV-105 5kV conductors, or single conductors twisted together (triplexed, quadruplexed, etc.) size 1/0 AWG and larger, installed in uncovered cable tray in accordance with Section 392.80(B) of the NEC at an ambient temperature of 40°C and a conductor temperature rating of 105°C. In accordance with NEC Section 392.80(B)(2)(a) the ampacities are 75% of the values given in NEC Table 310.60(C)(69) (copper conductors). Where the cable tray is covered for more than six feet with solid unventilated covers, the ampacities shall not exceed 93% of the values shown above. Refer to Table 310.60(C)(69) for 8kV ampacities.

Refer to the NEC, IEEE/ICEA S-135 Power Cable Ampacities, or the Okonite Engineering Data Bulletin for installation in duct banks, multiple point grounded shields, other ambient temperatures, circuit configurations or installation requirements.

(5) Recommended size of rigid or nonmetallic conduit for three conductors based on 40% maximum fill.

*The jam ratio, conduit I.D. to cable O.D. should be checked to avoid possible jamming.



Okoguard®-Okoseal® Type MV-105

5/8kV Shielded Power Cable

One Okopact® (Compact Stranded) Copper Conductor/105°C Rating
5kV-133% or 8kV-100% Insulation Level



- A Uncoated, Okopact (Compact Stranded) Copper Conductor
- B Strand Screen-Extruded Semiconducting EPR
- C Insulation-Okoguard EPR
- D Insulation Screen-Extruded Semiconducting EPR
- E Shielding-CopperTape
- F Jacket-Okoseal

Insulation

Okoguard is Okonite's registered trade name for its exclusive ethylene-propylene rubber (EPR) based, thermosetting compound, whose optimum balance of electrical and physical properties is unequalled in other solid dielectrics. Okoguard insulation, with the distinctive red color and a totally integrated EPR system, provides the optimum balance of electrical and physical properties for long, problem free service.

The triple tandem extrusion of the screens with the insulation provides optimum electrical characteristics.

Jacket

The Okoseal (PVC) jacket supplied with this cable is mechanically rugged and has excellent resistance to oil, acids and most chemicals.

Applications

Okoguard shielded Okoseal Type MV-105 power cables are recommended for distribution circuits, and for feeders or branch circuits.

Type MV cables may be installed in wet or dry locations, indoors or outdoors (exposed to sunlight), in any raceway or underground duct, directly buried if installed in a system with a grounding conductor in close proximity that conforms with NEC Section 250.4(A)(5), or messenger supported in industrial establishments and electric utilities.

Specifications

Conductor: Annealed uncoated copper compact stranded per ASTM B-496.

Strand Screen: Extruded semiconducting EPR strand screen. Meets or exceeds electrical and physical requirements of ICEA S-93-639/NEMA WC74 & S-97-682, AEIC CS8 and UL 1072.

Insulation: Meets or exceeds electrical and physical requirements of ICEA S-93-639/NEMA WC74 & S-97-682, AEIC CS8 and UL 1072.

Insulation Screen: Extruded semiconducting EPR insulation screen applied directly over the insulation. Meets or exceeds electrical and physical requirements of ICEA S-93-639/NEMA WC74 & S-97-682, AEIC CS8 and UL 1072.

Shield: 5 mil bare copper tape helically applied with 12.5% nominal overlap.

Jacket: Meets or exceeds electrical and physical requirements of ICEA S-93-639/NEMA WC74 & S-97-682, and UL 1072 for polyvinyl chloride jackets.

UL Listed as Type MV-105 and sunlight resistant, in accordance with UL 1072.

Cables listed to CSA C68.3 are also available.

Product Features

- Triple tandem extruded, all EPR system.
- Okoguard cables meet or exceed all recognized industry standards (UL, AEIC, NEMA/ICEA, IEEE).
- 105°C continuous operating temperature.
- 140°C emergency rating.
- 250°C short circuit rating.
- Excellent corona resistance.
- Screens are clean stripping.
- Exceptional resistance to "treeing".
- Exceptional resistance to moisture.
- Resistant to most oils, acids, and alkalis.
- Sunlight resistant.
- Improved Temperature Rating.

Okoguard-Okoseal Type MV-105

5/8kV Shielded Power Cable

One Okopact (Compact Stranded)

Copper Conductor/ 105°C Rating

5kV-133% or 8kV-100% Insulation Level



Product Data Section 2: Sheet 4

Okoguard Insulation: 115 mils (2.92mm), 5kV—133% or 8kV—100% Insulation Level

Catalog Number (1)	Conductor Size AWG or kcmil		Conductor Size -mm ²		Approx. Dia. over Insulation (in.)		Approx. Dia. over Screen (in.)		Jacket Thickness - mils		Approx. O.D. - mm		Approx. O.D. - Inches		Approx. Net Weight lbs./1000'		Approx. Ship Weight lbs./1000'		Ampacities Conduit in Air (2)		Ampacities Underground Duct (3)		Conduit Size Inches (4)*		
▲ 114-23-3817	6	13.3	0.44	0.50	60	1.52	0.64	16.3	285	320	84	92	2												
▲ 114-23-3819	4	21.2	0.48	0.54	60	1.52	0.69	17.5	355	385	110	120	2												
▲ 114-23-3821	2	33.6	0.54	0.60	60	1.52	0.74	18.8	455	495	145	155	2												
114-23-3823	1	42.4	0.58	0.63	60	1.52	0.77	19.5	530	570	175	180	2½												
▲ 114-23-3825	1/0	53.5	0.61	0.67	60	1.52	0.81	20.6	610	645	200	210	2½												
▲ 114-23-3827	2/0	67.4	0.65	0.71	60	1.52	0.85	12.6	710	765	225	235	2½												
114-23-3829	3/0	85.0	0.70	0.75	80	2.03	0.93	23.6	880	935	270	270	3												
▲ 114-23-3831	4/0	107.0	0.75	0.81	80	2.03	0.99	25.1	1035	1100	305	310	3												
▲ 114-23-3833	250	127.0	0.80	0.86	80	2.03	1.04	26.4	1180	1245	355	345	3												
▲ 114-23-3837	350	177.0	0.89	0.95	80	2.03	1.14	29.0	1535	1625	430	415	3½												
▲ 114-23-3843	500	253.0	1.01	1.07	80	2.03	1.25	31.8	2050	2150	530	505	3½												
▲ 114-23-3849	750	380.0	1.19	1.25	80	2.03	1.43	36.8	2935	3110	665	630	4												
114-23-3851	1000	507.0	1.33	1.39	80	2.03	1.57	39.9	3650	3825	770	720	5												

Visit www.okonite.com for the most current cable data.

▲ **Authorized stock item** Available from our Customer Service Center.

Minimum Manufacturing Quantity for non-stock items is 5000'.

Aluminum Conductors

(1) Aluminum conductors are available on special order.

Ampacities

(2) Ampacities are in accordance with Table 310.60(C)(73) of the NEC for three single Type MV-105 5kV conductors or single conductors twisted together (triplexed) and installed in an isolated conduit in air at an ambient temperature of 40°C and a conductor temperature of 105°C. Refer to Table 310.60(C)(73) for 8kV ampacities

(3) Ampacities are in accordance with Table 310.60(C)(77) of the NEC for three single 5kV conductors or triplexed cable in one underground raceway, three feet deep with a conductor temperature of 105°C, 100% Load Factor, an ambient earth temperature of 20°C and thermal resistance (RHO) of 90. Refer to Table 310.60(C)(77) for 8kV ampacities.

Refer to the NEC, IEEE/ICEA S-135 Power Cable Ampacities, or the Okonite Engineering Data Bulletin for installation in duct banks, multiple point grounded shields, other ambient temperatures, circuit configurations or installation requirements.

(4) Recommended size of rigid or nonmetallic conduit for three conductors based on 40% maximum fill.

*The jam ratio, conduit I.D. to cable O.D. should be checked to avoid possible jamming.



Okoguard®-Okoseal® Type MV-105

15kV Shielded Power Cable

One Okopact® (Compact Stranded) Copper Conductor/105°C Rating
100% and 133% Insulation Level

For Cable Tray Use-Sunlight Resistant



- A Uncoated, Okopact (Compact Stranded) Copper Conductor
- B Strand Screen-Extruded Semiconducting EPR
- C Insulation-Okoguard EPR
- D Insulation Screen-Extruded Semiconducting EPR
- E Shield- Copper Tape
- F Jacket-Okoseal

Insulation

Okoguard is Okonite's registered trade name for its exclusive ethylene-propylene rubber (EPR) based, thermosetting compound, whose optimum balance of electrical and physical properties is unequaled in other solid dielectrics. Okoguard insulation, with the distinctive red color and a totally integrated EPR system, provides the optimum balance of electrical and physical properties for long, problem free service.

The triple tandem extrusion of the screens with the insulation provides optimum electrical characteristics.

Jacket

The Okoseal (PVC) jacket supplied with this cable is mechanically rugged and has excellent resistance to flame, oil, acids and most chemicals.

Applications

Okoguard shielded Okoseal Type MV-105 power cables are recommended for use as feeder circuits, in electric utility generating stations, for distribution circuits, and for feeders or branch circuits in industrial and commercial installations.

Type MV cables may be installed in wet or dry locations, indoors or outdoors (exposed to sunlight), in any raceway or underground duct, directly buried if installed in a system with a grounding conductor in close proximity that conforms with NEC Section 250.4(A)(5), or messenger supported in industrial establishments and electric utilities. Sizes 1/0 AWG and larger may also be installed in cable tray.

Specifications

Conductor: Annealed uncoated copper compact stranded per ASTM B-496.

Strand Screen: Extruded EPR semiconducting strand screen. Meets or exceeds electrical and physical requirements of ICEA S-93-639/NEMA WC74 & S-97-682, AEIC CS8, CSA C68.3 and UL 1072.

Insulation: Meets or exceeds electrical and physical requirements of ICEA S-93-639/NEMA WC74 & S-97-682, AEIC CS8, CSA C68.3 and UL 1072.

Insulation Screen: Extruded EPR semiconducting insulation screen applied directly over the insulation. Meets or exceeds electrical and physical requirements of ICEA

S-93-639/NEMA WC74 & S-97-682, AEIC CS8, CSA C68.3 and UL 1072.

Shield: 5 mil bare copper tape helically applied with 25% minimum overlap.

Jacket: Meets or exceeds electrical and physical requirements of ICEA S-93-639/NEMA WC74 & S-97-682, CSA C68.3 and UL 1072 for polyvinyl chloride jackets.

UL listed as Type MV-105, sunlight resistant and for use in cable tray in accordance with UL 1072.

CSA C68.3 listed and rated FT4.

Product Features

- Triple tandem extruded, all EPR system.
- Okoguard cables meet or exceed all recognized industry standards (UL, CSA, AEIC, NEMA/ICEA, IEEE).
- 105°C continuous operating temperature.
- 140°C emergency rating.
- 250°C short circuit rating.
- Passes the Vertical Tray Flame Test requirements of UL 1072 and IEEE 383 and 1202.
- Excellent corona resistance.
- Screens are clean stripping.
- Exceptional resistance to "treeing".
- Exceptional resistance to moisture.
- Resistant to most oils, acids, and alkalies.
- Sunlight resistant.
- For Cable Tray Use.
- CSA FT4.
- CSA ≤ 350: LTDD (-25C)
- CSA ≥ 500: LTGG (-40C)
- Improved Temperature Rating.

Okoguard-Okoseal Type MV-105

15kV Shielded Power Cable

One Okopact (Compact Stranded)

Copper Conductor/105°C Rating

100% and 133% Insulation Level

For Cable Tray Use-Sunlight Resistant



Product Data Section 2: Sheet 8

Catalog Number (1)	Conductor Size AWG or kcmil	Conductor Size -mm ²	Approx. Dia. over Insulation (in.)	Approx. Dia. over Screen (in.)	Jacket Thickness - mils	Jacket Thickness - mm	Approx. O.D. - Inches	Approx. O.D. - mm	Approx. Net Weight lbs./1000'	Approx. Ship Weight lbs./1000'	Ampacities (2)	Conduit in Air	Ampacities (3)	Underground Duct Ampacities (4)	Cable Tray Conduit Size Inches (5)*
--------------------	--------------------------------	---------------------------------	---------------------------------------	-----------------------------------	-------------------------	-----------------------	-----------------------	-------------------	----------------------------------	-----------------------------------	----------------	----------------	----------------	------------------------------------	---

Okoguard Insulation: 175 mils (4.45mm), 100% Insulation Level

115-23-3064	1/0	53.5	0.74	0.80	80	2.03	0.98	24.8	760	825	215	215	220	3
115-23-3066	2/0	67.4	0.78	0.84	80	2.03	1.02	25.8	870	935	255	245	250	3
115-23-3067	3/0	85.0	0.83	0.89	80	2.03	1.07	27.1	1005	1070	290	275	290	3
115-23-3069	4/0	107.0	0.88	0.94	80	2.03	1.12	28.4	1160	1240	330	315	335	3
115-23-3074	250	127.0	0.93	0.98	80	2.03	1.17	29.7	1330	1415	365	345	370	3½
115-23-3076	350	177.0	1.03	1.07	80	2.03	1.26	32.0	1700	1800	440	415	460	3½
115-23-3090	500	253.0	1.14	1.19	80	2.03	1.38	35.1	2230	2275	535	500	575	4
115-23-3091	750	380.0	1.32	1.37	80	2.03	1.55	39.4	3105	3340	655	610	745	5
115-23-3092	1000	507.0	1.47	1.52	80	2.03	1.71	43.4	3960	4215	755	690	890	5

Okoguard Insulation: 220 mils (5.59mm), 133% Insulation Level

▲ 115-23-3230	1/0	53.5	0.83	0.88	80	2.03	1.10	28.0	905	975	215	215	220	3
▲ 115-23-3232	2/0	67.4	0.87	0.92	80	2.03	1.11	28.2	970	1030	255	245	250	3
115-23-3234	3/0	85.0	0.92	0.98	80	2.03	1.16	29.4	1100	1185	290	275	290	3½
▲ 115-23-3236	4/0	107.0	0.96	1.02	80	2.03	1.21	30.7	1280	1370	330	315	335	3½
▲ 115-23-3238	250	127.0	1.01	1.07	80	2.03	1.26	32.0	1435	1520	365	345	370	3½
▲ 115-23-3240	350	177.0	1.11	1.17	80	2.03	1.35	34.3	1810	1940	440	415	460	4
▲ 115-23-3242	500	253.0	1.22	1.28	80	2.03	1.47	37.3	2350	2535	535	500	575	4
▲ 115-23-3243	750	380.0	1.40	1.46	80	2.03	1.65	41.9	3240	3480	655	610	745	5
▲ 115-23-3244	1000	507.0	1.55	1.60	110	2.79	1.86	47.1	4220	4490	755	690	890	6

Visit Okonite's web site, www.okonite.com for the most up to date dimensions.

▲ **Authorized Stock Item.** Available from our Customer Service Centers. Minimum Manufacturing Quantity for non-stock items is 5000'.

Aluminum Conductors

(1) Aluminum conductors are available on special order. To order aluminum conductors, change the first three digits of the catalog number from 115 to 135.

Ampacities

(2) Ampacities are in accordance with Table 310.60(C)(73) of the NEC for three single Type MV-105 conductors, or single conductors twisted together (triplexed) and installed in an isolated conduit in air at an ambient temperature of 40°C and a conductor temperature of 105°C.

(3) Ampacities are in accordance with Table 310.60(C)(77) of the NEC for three single conductors or triplexed cable in one underground raceway, three feet deep with a conductor temperature of 105°C, 100% Load Factor, an ambient earth temperature of 20°C, and thermal resistance (RHO) of 90.

Refer to the NEC, IEEE/ICEA S-135 Power Cable Ampacities, or the Okonite Engineering Data Bulletin EHB for installation in duct banks, multiple point

ground shields, other ambient temperatures, circuit configurations or installation requirements.

(4) Ampacities based on single Type MV-105 conductors, or single conductors twisted together (triplexed, quadruplexed, etc.) size 1/0 AWG and larger, installed in uncovered cable tray in accordance with Section 392.80(B) of the NEC at an ambient temperature of 40°C and a conductor temperature rating of 105°C. In accordance with NEC Section 392.80(B)(2)(a) (copper conductors), the values are 75% of the values given in table 310.69. Where the cable tray is covered for more than six feet with solid unventilated covers, the ampacities shall not exceed 93% of the values shown above.

(5) Recommended size of rigid or nonmetallic conduit for three conductors based on 40% maximum fill.

*The jam ratio, conduit I.D. to cable O.D. should be checked to avoid possible jamming.



Okoguard®-Okoseal® Type MV-105



15kV Shielded Power Cable

One Okopact® (Compact Stranded) Copper Conductor/105°C Rating
100% and 133% Insulation Level



- A Uncoated, Okopact (Compact Stranded) Copper Conductor
- B Strand Screen- Extruded Semiconducting EPR
- C Insulation-Okoguard EPR
- D Insulation Screen- Extruded semi-conducting EPR
- E Shield-Copper Tape
- F Jacket Okoseal

Insulation

Okoguard is Okonite's registered trade name for its exclusive ethylene-propylene rubber (EPR) based, thermosetting compound, whose optimum balance of electrical and physical properties is unequalled in other solid dielectrics. Okoguard insulation, with the distinctive red color and a totally integrated EPR system, provides the optimum balance of electrical and physical properties for long, problem free service.

The triple tandem extrusion of the screens with the insulation provides optimum electrical characteristics.

Jacket

The Okoseal (PVC) jacket supplied with this cable is mechanically rugged and has excellent resistance to oil, acids and most chemicals.

Applications

Okoguard shielded Okoseal Type MV-105 power cables are recommended for distribution circuits, and for feeders or branch circuits.

Type MV cables may be installed in wet or dry locations, indoors or outdoors (exposed to sunlight), in any raceway or underground duct, directly buried if installed in a system with a grounding conductor in close proximity that conforms with NEC Section 250.4(A)(5), or messenger supported in industrial establishments and electric utilities.

Specifications

Conductor: Annealed uncoated copper compact stranded per ASTM B-496.

Strand Screen: Extruded semiconducting EPR strand screen. Meets or exceeds electrical and physical requirements of ICEA S-93-639/NEMA WC74, AEIC CS8 and UL 1072.

Insulation: Meets or exceeds electrical and physical requirements of ICEA S-93-639/NEMA WC74 & S-97-682, AEIC CS8 and UL 1072.

Insulation Screen: Extruded semiconducting EPR insulation screen. Meets or exceeds electrical and physical requirements of ICEA S-93-639/NEMA WC74 & S-97-682, AEIC CS8 and UL 1072.

Shield: 5 mil bare copper tape helically applied with 12.5% nominal overlap.

Jacket: Meets or exceeds electrical and physical requirements of ICEA S-93-639/NEMA WC74 & S-97-682 and UL 1072 for polyvinyl chloride jackets. UL Listed as Type MV-105 and sunlight resistant in accordance with UL 1072. Cables listed to CSA C68.3 are also available.

Product Features

- Triple tandem extruded, all EPR system.
- Okoguard cables meet or exceed all recognized industry standards (UL, AEIC, NEMA/ICEA, IEEE).
- 105°C continuous operating temperature.
- 140°C emergency rating.
- 250°C short circuit rating.
- Excellent corona resistance.
- Screens are clean stripping.
- Exceptional resistance to "treeing".
- Moisture resistant.
- Resistant to most oils, acids, and alkalies.
- Sunlight resistant.
- Improved Temperature Rating.

Okoguard-Okoseal Type MV-105

15kV Shielded Power Cable

One Okopact (Compact Stranded)

Copper Conductor/105°C Rating



Product Data Section 2: Sheet 9

Catalog Number (1)	Conductor Size AWG or kcmil	Conductor Size - mm ²	Approx. Dia. over Insulation (in.)	Approx. Dia. over Screen (in.)	Jacket Thickness - mills	Jacket Thickness - mm	Approx. O.D. - Inches	Approx. O.D. - mm	Approx. Net Weight lbs./1000'	Approx. Ship Weight lbs./1000'	Ampacities (2) Conduit in Air	Ampacities (3) Direct Burial	Ampacities (4) Underground Duct	Conduit Size Inches (5)*
--------------------	--------------------------------	----------------------------------	---------------------------------------	-----------------------------------	--------------------------	-----------------------	-----------------------	-------------------	----------------------------------	-----------------------------------	----------------------------------	---------------------------------	------------------------------------	-----------------------------

Okoguard Insulation: 175 mils (4.45mm), 100% Insulation Level

115-23-3011	2	33.6	0.67	0.73	60	1.52	0.87	22.1	555	610	165	225	165	3
115-23-3013	1	42.4	0.70	0.76	80	2.03	0.94	23.9	665	720	190	260	185	3
115-23-3015	1/0	53.5	0.74	0.80	80	2.03	0.98	24.8	755	820	215	295	215	3
115-23-3017	2/0	67.4	0.78	0.84	80	2.03	1.02	25.8	865	930	255	335	245	3
115-23-3019	3/0	85.0	0.83	0.89	80	2.03	1.07	27.2	1000	1070	290	380	275	3
115-23-3021	4/0	107.0	0.88	0.94	80	2.03	1.12	28.3	1170	1250	330	435	315	3
115-23-3023	250	127.0	0.93	0.99	80	2.03	1.18	30.0	1325	1405	365	475	345	3½
115-23-3027	350	177.0	1.03	1.07	80	2.03	1.26	32.0	1700	1800	440	575	415	3½
115-23-3031	500	253.0	1.14	1.19	80	2.03	1.38	35.1	2240	2385	535	700	500	4
115-23-3035	750	380.0	1.32	1.37	80	2.03	1.55	39.4	3105	3340	655	865	610	5
115-23-3037	1000	507.0	1.47	1.52	80	2.03	1.71	43.4	3950	4185	755	1005	690	5

Okoguard Insulation: 220 mils (5.59mm), 133% Insulation Level

▲ 115-23-3111	2	33.6	0.76	0.81	80	2.03	1.00	25.4	670	720	165	225	165	3
115-23-3113	1	42.4	0.79	0.85	80	2.03	1.04	26.4	755	820	190	260	185	3
▲ 115-23-3115	1/0	53.5	0.83	0.89	80	2.03	1.07	27.1	845	915	215	295	215	3
▲ 115-23-3117	2/0	67.4	0.87	0.92	80	2.03	1.11	28.2	950	1020	255	335	245	3
115-23-3119	3/0	85.0	0.92	0.98	80	2.03	1.16	29.3	1100	1180	290	380	275	3½
▲ 115-23-3121	4/0	107.0	0.96	1.02	80	2.03	1.20	30.5	1260	1360	330	435	315	3½
▲ 115-23-3123	250	127.0	1.01	1.07	80	2.03	1.26	32.0	1415	1500	365	475	345	3½
▲ 115-23-3127	350	177.0	1.11	1.16	80	2.03	1.35	34.3	1790	1920	440	575	415	4
▲ 115-23-3131	500	253.0	1.22	1.28	80	2.03	1.47	37.3	2325	2510	535	700	500	4
▲ 115-23-3135	750	380.0	1.40	1.46	80	2.03	1.64	41.7	3220	3455	655	865	610	5
▲ 115-23-3139	1000	507.0	1.54	1.60	110	2.79	1.84	46.7	4075	4340	755	1005	690	6

Visit Okonite's web site, www.okonite.com for the most up to date dimensions.

▲ **Authorized stock item.** Available from our Customer Service Centers.

Aluminum Conductors

(1) Aluminum conductors are available on special order.

Ampacities

(2) Ampacities are in accordance with Table 310.60(C)(73) of the NEC for three single Type MV-105 conductors, or single conductors twisted together (triplexed) and installed in an isolated conduit in air at an ambient temperature of 40°C and a conductor temperature of 105°C.

(3) Ampacities are in accordance with Table 310.60(C)(81) of the NEC for an insulated single conductor directly buried with a conductor temperature rating of 105°C, ambient earth temperature of 20°C, 100% Load Factor, thermal resistance (RHO) of 90, 7 1/2 inch spacing between conductor center lines, and 24 inch spacing between circuits.

(4) Ampacities are in accordance with Table 310.60(C)(77) of the NEC for three single conductors or triplexed cable in one underground raceway, three feet

deep with a conductor temperature of 105°C, 100% Load Factor, an ambient earth temperature of 20°C, and thermal resistance (RHO) of 90.

Refer to the NEC, IEEE/ICEA S-135 Power Cable Ampacities, or the Okonite Engineering Data Bulletin for installation in duct banks, multiple point grounded shields, other ambient temperatures, circuit configurations or installation requirements.

(5) Recommended size of rigid or nonmetallic conduit for three conductors based on 40% maximum fill.

*The jam ratio, conduit I.D. to cable O.D. should be checked to avoid possible jamming.

 **THE OKONITE COMPANY**
Ramsey, New Jersey 07446



Okoguard®-Okolon® TS-CPE Type MV-105

15kV Shielded Power Cable

One Okopact® (Compact Stranded) Copper Conductor/105°C Rating
100% and 133% Insulation Level

For Cable Tray Use-Sunlight Resistant



- A Uncoated, Okopact (Compact Stranded) Copper Conductor
- B Strand Screen-Extruded Semiconducting EPR
- C Insulation-Okoguard EPR
- D Insulation Screen-Extruded Semiconducting EPR
- E Shield Copper Tape
- F Jacket-Okolon TS-CPE

Insulation

Okoguard is Okonite's registered trade name for its exclusive ethylene-propylene (EPR) based, thermosetting compound, whose optimum balance of electrical and physical properties is unequalled in other solid dielectrics. Okoguard insulation, with the distinctive red color and a totally integrated EPR system, provides the optimum balance of electrical and physical properties for long, problem free service.

The triple tandem extrusion of the screens with the insulation provides optimum electrical characteristics.

Jacket

The Okolon TS-CPE jacket on this cable is a vulcanized chlorinated polyethylene base compound which is mechanically rugged, flame, radiation, and oil resistant.

Applications

Okoguard shielded Okolon TS-CPE Type MV-105 power cables are recommended for use as feeder circuits in electric utility generating stations, for distribution circuits, and for feeders or branch circuits in industrial and commercial installations. Type MV cables may be installed in wet or dry locations, indoors or outdoors (exposed to sunlight), in any raceway or underground duct, directly buried if installed in a system with a grounding conductor in close proximity that conforms with NEC Section 250.4(A)(5), or messenger supported in industrial establishments and electric utilities. Sizes 1/0 AWG and larger may also be installed in cable tray.

Specifications

Conductor: Annealed uncoated copper compact stranded per ASTM B-496.

Strand Screen: Extruded semiconducting EPR strand screen. Meets or exceeds electrical and physical requirements of ICEA S-93-639/NEMA WC74 & S-97-682, AEIC CS8, CSA C68.3 and UL 1072.

Insulation: Meets or exceeds electrical and physical requirements of ICEA S-93-639/NEMA WC74 & S-97-682, AEIC CS8, CSA C68.3 and UL 1072.

Insulation Screen: Extruded semiconducting EPR insulation screen. Meets or exceeds

electrical and physical requirements of ICEA S-93-639/NEMA WC74 & S-97-682, AEIC CS8, CSA C68.3 and UL 1072.

Shield: 5 mil bare copper tape helically applied, with 25% minimum overlap.

Jacket: Meets or exceeds electrical and physical requirements of ICEA S-93-639/NEMA WC74 & S-97-682, CSA C68.3 and UL 1072 for chlorinated polyethylene jackets.

UL listed as Type MV-105, sunlight resistant and for use in cable tray in accordance with UL 1072.

CSA listed meeting the requirements of C68.3 and rated FT4 (1/0 AWG and larger) and -40°C.

Product Features

- Triple tandem extruded, all EPR system.
- Okoguard cables meet or exceed all recognized industry standards (UL, CSA, AEIC, NEMA/ICEA, IEEE).
- 105°C continuous operating temperature.
- 140°C emergency rating.
- 250°C short circuit rating.
- Passes UL and IEEE 383 and 1202 (1/0 AWG & larger) Vertical Tray Flame Tests.
- Excellent corona resistance.
- Screens are clean stripping.
- Exceptional resistance to "treeing."
- Moisture resistant.
- Resistant to most oils, acids, and alkalis.
- Sunlight resistant.
- For Cable Tray Use; 1/0 AWG and larger.
- CSA FT4 and -40°C.
- Improved Temperature Rating.

Okoguard-Okolon TS-CPE Type MV-105

15kV Shielded Power Cable

One Okopact (Compact Stranded)

Copper Conductor/ 105°C Rating

100% and 133% Insulation Level

For Cable Tray Use-Sunlight Resistant



Product Data Section 2: Sheet 11

Catalog Number (1)	Conductor Size AWG or kcmil		Conductor Size - mm ²		Approx. Dia. over Insulation (in.)		Approx. Dia. over Screen (in.)		Jacket Thickness - mils		Approx. O.D. - mm		Approx. O.D. - Inches		Approx. Net Weight (lbs./1000')		Approx. Ship Weight (lbs./1000')		Ampacities (2) Conduit in Air		Ampacities (3) Underground		Ampacities (4) Cable Tray		Conduit (5) Size Inches*	
--------------------	--------------------------------	--	----------------------------------	--	---------------------------------------	--	-----------------------------------	--	----------------------------	--	-------------------	--	-----------------------	--	------------------------------------	--	-------------------------------------	--	----------------------------------	--	-------------------------------	--	------------------------------	--	-----------------------------	--

Okoguard Insulation: 175 mils (4.45mm), 100% Insulation Level

115-23-2011	2	33.6	0.67	0.73	60	1.52	0.89	22.5	585	640	165	165	—	3
115-23-2013	1	42.4	0.70	0.76	80	2.03	0.96	24.4	700	765	190	185	—	3
115-23-2015	1/0	53.5	0.73	0.79	80	2.03	1.00	25.3	790	855	215	215	220	3
115-23-2017	2/0	67.4	0.77	0.83	80	2.03	1.04	26.4	905	965	255	245	250	3
115-23-2019	3/0	85.0	0.82	0.88	80	2.03	1.09	27.6	1040	1110	290	275	290	3
115-23-2021	4/0	107.0	0.87	0.93	80	2.03	1.13	28.7	1200	1280	330	315	335	3½
115-23-2023	250	127.0	0.93	0.99	80	2.03	1.19	30.3	1370	1450	365	345	370	3½
115-23-2027	350	177.0	1.01	1.07	80	2.03	1.28	32.4	1725	1825	440	415	460	4
115-23-2031	500	253.0	1.13	1.19	80	2.03	1.39	35.4	2255	2370	535	500	575	4
115-23-2035	750	380.0	1.31	1.37	80	2.03	1.57	39.9	3140	3320	655	610	745	5
115-23-2038	1000	507.0	1.46	1.52	80	2.03	1.73	43.9	4020	4255	755	690	890	5

Okoguard Insulation: 220 mils (5.59mm), 133% Insulation Level

115-23-2111	2	33.6	0.75	0.81	80	2.03	1.01	25.8	710	775	165	165	—	3
115-23-2113	1	42.4	0.79	0.85	80	2.03	1.05	26.7	790	860	190	185	—	3
115-23-2115	1/0	53.5	0.82	0.88	80	2.03	1.08	27.5	880	945	215	215	220	3½
115-23-2117	2/0	67.4	0.86	0.92	80	2.03	1.12	28.5	995	1075	255	245	250	3½
115-23-2119	3/0	85.0	0.91	0.97	80	2.03	1.18	29.9	1145	1225	290	275	290	3½
115-23-2121	4/0	107.0	0.96	1.02	80	2.03	1.22	31.1	1310	1400	330	315	335	3½
115-23-2123	250	127.0	1.01	1.07	80	2.03	1.28	32.4	1465	1565	365	345	370	4
115-23-2127	350	177.0	1.10	1.16	80	2.03	1.37	34.7	1840	1940	440	415	460	4
▲ 115-23-2131	500	253.0	1.22	1.28	80	2.03	1.49	37.7	2385	2570	535	500	575	5
▲ 115-23-2135	750	380.0	1.40	1.46	80	2.03	1.66	42.2	3285	3540	655	610	745	5
115-23-2138	1000	507.0	1.54	1.60	110	2.79	1.87	47.5	4275	4540	755	690	890	6
115-23-2144	1250	633.5	1.75	1.81	110	4.33	2.08	52.7	5255	5645	845	770	995	6
115-23-2145	1500	760.2	1.88	1.94	110	4.33	2.20	56.0	6140	6540	925	845	1090	8

Visit Okonite's web site, www.okonite.com for the most up to date dimensions.

▲ **Authorized Stock Item.** Available from our Customer Service Centers.

Aluminum Conductors

(1) Aluminum conductors are available on special order.

Ampacities

(2) Ampacities are in accordance with Table 310.60(C)(73) of the NEC for three single Type MV-105 conductors, or single conductors twisted together (triplexed) and installed in an isolated conduit in air at an ambient temperature of 40°C and a conductor temperature of 105°C.

(3) Ampacities are in accordance with Table 310.60(C)(77) of the NEC for three single conductors or triplexed cable in one underground raceway, three feet deep with a conductor temperature of 105°C, 100% Load Factor, an ambient earth temperature of 20°C and thermal resistance (RHO) of 90.

(4) Ampacities based on single Type MV-105 conductors, or single conductors twisted together (triplexed, quadruplexed, etc.), size 1/0 AWG and larger, installed in uncovered cable tray in accordance with Section 392.80(B) of the NEC at an ambient temperature of 40°C and a conductor temperature rating of

105°C. In accordance with NEC Section 392.80(B)(2)(a), the ampacities are 75% of the values given in NEC Table 310.60(C)(69) (copper conductors). Where the cable tray is covered for more than six feet with solid unventilated covers, the ampacities shall not exceed 93% of the values shown above.

Refer to the NEC, IEEE/ICEA-S-135 Power Cable Ampacities, or the Okonite Engineering Data Bulletin for installation in duct banks, multiple point grounded shields, other ambient temperatures, circuit configurations or installation requirements.

(5) Recommended size of rigid or nonmetallic conduit for three conductors based on 40% maximum fill.

*The jam ratio conduit I.D. to cable O.D. should be checked to avoid possible jamming.



Okoguard®-Okoseal® Type MV-105



35kV Shielded Power Cable

One Okopact® (Compact Stranded) Copper Conductor/105°C Rating
100% and 133% Insulation Level



- A Uncoated, Okopact (Compact Stranded) Copper Conductor
- B Strand Screen- Extruded Semiconducting EPR
- C Insulation-Okoguard EPR
- D Insulation Screen -Extruded Semiconducting EPR
- E Shield-Copper Tape
- F Jacket-Okoseal

Insulation

Okoguard Okonite's registered trade name for its exclusive ethylene-propylene rubber (EPR) based, thermosetting compound, whose optimum balance of electrical and physical properties is unequalled in other solid dielectrics. Okoguard insulation, with the distinctive red color and a totally integrated EPR system, provides the optimum balance of electrical and physical properties for long, problem free service. The triple tandem extrusion of the screens with the insulation provides optimum electrical characteristics.

Jacket

The Okoseal (PVC) jacket supplied with this cable is mechanically rugged and has excellent resistance to oil and most chemicals.

Applications

Okoguard shielded Okoseal Type MV-105 power cables are recommended for distribution circuits, and for feeders or branch circuits in industrial and commercial installations.

Type MV cables may be installed in wet or dry locations, indoors or outdoors (exposed to sunlight), in any raceway or underground duct, directly buried if installed in a system with a grounding conductor in close proximity that conforms with NEC Section 250.4(A)(5), or messenger supported in industrial establishments and electric utilities.

Specifications

Conductor: Annealed uncoated copper compact stranded per ASTM B-496.

Strand Screen: Extruded semiconducting EPR strand screen. Meets or exceeds electrical and physical requirements of ICEA S-93-639/NEMA WC7 & S-97-682, AEIC CS8 and UL 1072.

Insulation: Meets or exceeds electrical and physical requirements of ICEA S-93-639/NEMA WC74, & S-97-682 AEIC CS8 and UL 1072.

Insulation Screen: Extruded semiconducting EPR insulation screen. Meets or exceeds electrical and physical requirements of ICEA S-93-639/NEMA WC74 & S-97-682, AEIC CS8 and UL 1072.

Shield: 5 mil bare copper tape helically applied with 12.5% nominal overlap.

Jacket: Meets or exceeds electrical and physical requirements of ICEA S-93-639/NEMA WC74 & S-97-682 and UL 1072 for polyvinyl chloride jackets.

UL Listed as Type MV-105 and sunlight resistant, in accordance with UL 1072.

A flame retardant construction, size 1/0 AWG and larger, for installation in cable tray is available on special order. This construction is UL labeled "MV-105 FOR CT USE." Cables listed to CSA C68.3 and rated FT4 and -25°C are available on special orders.

Product Features

- Triple tandem extruded all EPR system.
- Okoguard cables meet or exceed all recognized industry standards (UL, AEIC, NEMA/ICEA, IEEE).
- 105°C continuous operating temperature.
- 140°C emergency rating.
- 250°C short circuit rating.
- Excellent corona resistance.
- Screens are clean stripping.
- Exceptional resistance to "treeing."
- Moisture resistant.
- Resistant to most oils, acids, and alkalis.
- Sunlight resistant.
- Improved Temperature Rating

Okoguard-Okoseal Type MV-105

35kV Shielded Power Cable

One Okopact (Compact Stranded)

Copper Conductor/105°C Rating

100% and 133% Insulation Level



Product Data

Section 2: Sheet 16

Catalog Number (1)	Conductor Size AWG or kcmil		Conductor Size - mm ²		Approx. Dia. over Insulation (in.)		Approx. Dia. over Screen (in.)		Jacket Thickness - mils		Jacket Thickness - mm		Approx. O.D. - Inches		Approx. O.D. - mm		Approx. Net Weight lbs./1000'		Approx. Ship Weight lbs./1000'		Ampacities (2) Conduit in Air		Ampacities (3) Direct Burial		Ampacities (4) Underground Duct		Conduit Size Inches (5)*	
--------------------	--------------------------------	--	----------------------------------	--	---------------------------------------	--	-----------------------------------	--	-------------------------	--	-----------------------	--	-----------------------	--	-------------------	--	----------------------------------	--	-----------------------------------	--	----------------------------------	--	---------------------------------	--	------------------------------------	--	-----------------------------	--

Okoguard Insulation: 345 mils (8.76mm), 100% Insulation Level

▲ 115-23-3516	1/0	53.5	1.09	1.15	80	2.03	1.33	34.0	1140	1275	215	295	215	4
115-23-3517	2/0	67.4	1.12	1.19	80	2.03	1.37	35.0	1270	1380	255	335	245	4
115-23-3519	3/0	85.0	1.17	1.23	80	2.03	1.42	36.1	1420	1605	290	380	275	4
▲ 115-23-3521	4/0	107.0	1.23	1.29	80	2.03	1.47	37.4	1595	1800	330	435	315	5
115-23-3523	250	127.0	1.27	1.33	80	2.03	1.52	38.7	1760	1950	365	475	345	5
115-23-3527	350	177.0	1.36	1.43	80	2.03	1.61	41.2	2150	2420	440	575	415	5
▲ 115-23-3531	500	253.0	1.48	1.54	80	2.03	1.73	43.9	2720	3014	535	700	500	5
115-23-3535	750	380.0	1.66	1.72	110	2.79	1.97	50.1	3765	4240	655	865	610	6
115-23-3537	1000	507.0	1.81	1.86	110	2.79	2.12	53.9	4671	5300	755	1005	690	6

Okoguard Insulation: 420 mils (10.7mm), 133% Insulation Level

▲ 115-23-3656	1/0	53.5	1.24	1.30	80	2.03	1.49	37.9	1350	1535	215	295	215	5
115-23-3657	2/0	67.4	1.28	1.34	80	2.03	1.53	39.0	1470	1665	255	335	245	5
115-23-3659	3/0	85.0	1.32	1.39	80	2.03	1.57	40.0	1630	1825	290	380	275	5
▲ 115-23-3661	4/0	107.0	1.39	1.45	80	2.03	1.64	41.9	1840	2085	330	435	315	5
115-23-3663	250	127.0	1.42	1.48	80	2.03	1.69	42.9	1985	2250	365	475	345	5
115-23-3667	350	177.0	1.52	1.58	110	2.79	1.83	46.5	2495	2770	440	575	415	5
115-23-3671	500	253.0	1.63	1.69	110	2.79	1.94	49.3	3085	3555	535	700	500	6
115-23-3675	750	380.0	1.81	1.87	110	2.79	2.12	53.9	4055	4680	655	865	610	6
115-23-3677	1000	507.0	1.97	2.02	110	2.79	2.27	57.6	5980	5630	755	1005	690	8

Visit Okonite's web site, www.okonite.com for the most up to date dimensions.

▲ Authorized stock item. Available from our Customer Service Centers.

Aluminum Conductors

(1) Aluminum Conductors are available on special orders.

Ampacities

(2) Ampacities are in accordance with Table 310.60(C)(73) of the NEC for three single Type MV-105 conductors, or single conductors twisted together (triplexed) and installed in an isolated conduit in air at an ambient temperature of 40°C and a conductor temperature of 105°C.

(3) Ampacities are in accordance with Table 310.60(C)(81) of the NEC for an insulated single conductor directly buried with a conductor temperature rating of 105°C, ambient earth temperature of 20°C, 100% Load Factor, thermal resistance (RHO) of 90, 7 1/2 inch spacing between conductor center lines, and 24 inch spacing between circuits.

(4) Ampacities are in accordance with Table 310.60(C)(77) of the NEC for three single conductors or triplexed cable in one underground raceway, three feet deep with a conductor temperature of 105°C, 100% Load Factor, an ambient earth temperature of 20°C, and thermal resistance (RHO) of 90.

Refer to the NEC, IEEE/ICEA S-135 Power Cable Ampacities, or the Okonite Engineering Data Bulletin for installation in duct banks, multiple point grounded shields, other ambient temperatures, circuit configurations or installation requirements.

(5) Recommended size of rigid or nonmetallic conduit for three conductors based on 40% maximum fill.

*The jam ratio conduit I.D. to cable O.D. should be checked to avoid possible jamming.



Okoguard®-Okoseal®

69kV Shielded Power Cable

Conductor/105°C Rating — 100% Insulation Level



- A Uncoated, Okopact (Compact) or Compress Stranded Copper or Aluminum Conductor
- B Strand Screen-Extruded Semiconducting EPR
- C Insulation-Okoguard EPR
- D Insulation Screen-Extruded Semiconducting EPR
- E Shield- 5 Mil Uncoated Copper Tape
- F Jacket-Okoseal

Insulation

Okoguard is Okonite's registered trade name for its exclusive ethylene-propylene rubber (EPR) based, thermo-setting compound, whose optimum balance of electrical and physical properties is unequalled in other solid dielectrics. Okoguard insulation, with the distinctive red color and a totally integrated EPR system, provides the optimum balance of electrical and physical properties for long, problem free service.

The triple tandem extrusion of the screens with the insulation provides optimum electrical characteristics.

Jacket

The Okoseal (PVC) jacket supplied with this cable is mechanically rugged and has excellent resistance to oil and most chemicals.

Applications

Okoguard-Shielded-Okoseal 69kV Cables are designed for use as primary circuits in electrical utility and industry applications where they provide maximum circuit security and economical installation. Rated 105°C for continuous operating temperature, Okoguard 69kV cables may be installed in wet or dry locations indoors or outdoors (exposed to sunlight) in underground ducts, conduits or direct burial.

Specifications

Conductors: Uncoated copper sizes 350 through 1000 kcmil compact round stranding per ASTM B-496. Uncoated copper sizes larger than 1000 kcmil compress round stranding per ASTM B-8. EC Aluminum per ASTM B609, Class B stranded per B-231.

Strand Screen: Extruded semiconducting EPR strand screen. Meets or exceeds electrical and physical requirements of ICEA S-108-720, AEIC CS9.

Insulation: Meets or exceeds electrical and physical requirements of ICEA S-108-720 and AEIC CS9.

Insulation Screen: Extruded semiconducting EPR insulation screen. Meets or exceeds electrical and physical requirements of ICEA S-108-720 and AEIC CS9.

Shield: 5 mil bare copper tape helically applied with 25% nominal overlap.

Jacket: Meets or exceeds electrical and physical requirements of ICEA S-108-720 for polyvinyl chloride jackets.

Optional jackets include Okolene, Okolon TS-CPE, Okoclear and, when specified, a semi-conducting outer layer.

Optional shields include neutral wires, LCS and a combination of copper tape and wires. A CLX armor covering is also available.

Product Features

- Triple tandem extruded, all EPR system.
- Okoguard cables meet or exceed recognized industry standards (AEIC, NEMA/ ICEA).
- 105°C continuous operating temperature.
- 140°C emergency rating.
- 250°C short circuit rating.
- Excellent corona resistance.
- Exceptional resistance to "treeing."
- Low shield resistance.
- Moisture resistant.
- Resistant to most oils, acids, and alkalis.
- Sunlight resistant.
- Improved Temperature Rating.
- Screens are clean stripping.

Okoguard-Okoseal

69kV Shielded Power Cable

Conductor/ 105°C Rating

100% Insulation Level

Product Data

Section 2: Sheet 18

Okoguard Insulation: 650 mils (16.5mm)

Catalog Number	Conductor Size AWG or kcmil	Conductor Size -mm ²	Approx. Dia. over Insulation (in.)	Approx. Dia. over Screen (in.)	Jacket Thickness - mils	Jacket Thickness - mm	Approx. O.D. - Inches	Approx. O.D. - mm	Approx. Net Weight lbs./1000'	Approx. Ship Weight lbs./1000'	Ampacities (1) Direct Burial	Ampacities (1) Underground Duct	Conduit Size Inches (2)*
Copper Conductor - Compact Round													
115-22-3767	350*	177	2.01	2.11	110	2.79	2.36	59.9	3538	3873	550	495	3 ½
▲ 115-22-3771	500	253	2.12	2.22	110	2.79	2.47	62.7	4179	4514	667	599	3 ½
115-22-3775	750	380	2.30	2.40	110	2.79	2.64	67.1	5213	5805	825	742	4
▲ 115-22-3777	1000	507	2.44	2.54	140	3.56	2.85	72.4	6389	7151	957	861	4
Copper Conductor - Compress Round													
115-22-3778	1250	633	2.68	2.78	140	3.56	3.09	78.5	7582	8344	1066	959	5
115-22-3779	1500	761	2.78	2.88	140	3.56	3.19	81.0	8527	9447	1157	1042	5
Aluminum Conductor - Compress Round													
135-22-3767	350*	177	2.06	2.16	110	2.79	2.41	61.2	2888	3223	429	386	3 ½
135-22-3771	500	253	2.19	2.29	110	2.79	2.54	64.5	3244	3579	523	469	3 ½
135-22-3775	750	380	2.37	2.47	110	2.79	2.72	69.1	3778	4175	650	584	4
135-22-3777	1000	507	2.52	2.62	140	3.56	2.93	74.4	4433	4904	759	683	4
135-22-3778	1250	633	2.68	2.78	140	3.56	3.09	78.5	4954	5716	853	768	5
135-22-3779	1500	761	2.80	2.90	140	3.56	3.21	81.5	5381	6034	936	842	5

Visit Okonite's web site, www.okonite.com for the most up to date dimensions.

▲ Authorized Stock Item. Available from our Customer Service Centers.

Additional conductor sizes are available.

Ampacities

(1) Ampacities are in accordance with ICEA P-53-426 for three single 69kV conductors directly buried or in individual ducts underground, 36" deep with 7 1/2" spacing between conductors, 105°C maximum conductor temperature, 25°C earth temperature, soil resistivity of 90 Rho, 100% load factor, and open circuit shields.

(2) Recommended size of rigid nonmagnetic or nonmetallic conduit for a single conductor based on 53% maximum fill

* Minimum conductor size per, (1) AEIC CS-9 is 500 kcmil; (2) ICEA S-108-720 is 250 kcmil.



Okoguard® Okoseal® Type MV-105



5/8kV Okoguard Shielded Power Cable

3 Okopact® (Compact Stranded) Copper Conductors/105°C Rating
5kV-133% or 8kV-100% Insulation Level

For Cable Tray Use-Sunlight Resistant-For Direct Burial



- A Uncoated Okopact (Compact Stranded) Copper Conductors
- B Extruded Semiconducting EPR Strand Screen
- C Okoguard Insulation (EPR)
- D Extruded Semiconducting EPR Insulation Screen
- E Phase Identification Tape
- F Okopact Compact Copper Grounding Conductor
- G Uncoated Copper Shield
- H Fillers and Binder Tape
- J Jacket-Black Okoseal

Insulation

Okoguard is Okonite's registered trade name for its exclusive ethylene-propylene rubber (EPR) base, thermosetting compound, whose optimum balance of electrical and physical properties is unequalled in other solid dielectrics. Okoguard insulation, with the distinctive red color and a totally integrated EPR system, provides the optimum balance of electrical and physical properties for long, problem free service.

Assembly

The Type MV-105 conductors are assembled with fillers and a binder tape overall. One bare stranded copper ground conductor is placed in one of the outer interstices.

Jacket

The Okoseal (PVC) jacket supplied with this cable is mechanically rugged and has excellent resistance to oil and most chemicals.

Applications

Okoguard shielded three conductor Type MV-105 power cables are recommended for distribution circuits, and for feeders or branch circuits in industrial & utility power distribution systems. Type MV cables may be installed in wet or dry locations, indoors or outdoors (exposed to sunlight), in any raceway or underground duct, directly buried, cable tray, or messenger supported in industrial establishments and electric utilities.

Specifications

Conductors: Uncoated copper compact stranded per ASTM B-496.

Strand Screen: Extruded semiconducting EPR strand screen meets or exceeds electrical and physical requirements of ICEA S-93-639/NEMA WC74 and UL 1072.

Insulation: Okoguard meets or exceeds the electrical and physical requirements of ICEA S-93-639/NEMA WC74 and UL 1072. The insulated conductors are tested in accordance with AEIC CS8.

Insulation Screen: Extruded semiconducting EPR insulation screen per ICEA S-93-639/NEMA WC74, AEIC CS8 and UL 1072.

Shield: 5 mil uncoated copper tape helically applied with 12.5% nominal overlap.

Phase Identification: Color coded (black, red, blue) polyester ribbon laid longitudinally under the copper shield.

Grounding Conductor: Uncoated copper compact stranded per ASTM B-496 and sized in accordance with UL 1072.

Assembly: Cabled with fillers and ground wire in the interstices, binder tape overall.

Jacket: Meets or exceeds electrical and physical requirements of ICEA S-93-639/NEMA WC74 and UL 1072 for polyvinyl chloride jackets.

UL Listed as Type MV-105, sunlight resistant for use in cable tray, and for direct burial in accordance with UL 1072.

Cables listed to CSA C68.3 are also available.

Product Features

- Triple tandem extruded, all EPR system.
- Complete prepackaged, color coded, factory tested wiring system.
- Passes the vertical tray flame test requirements of IEEE 383 and UL 1072.
- Complies with NEC Sections 310-7 and 710-4(b) for direct burial.
- Excellent corona resistance.
- Screens are clean stripping.
- Exceptional resistance to "treeing".
- Improved Temperature Rating.



Okoguard® Okoseal® Type MV-105

15kV Okoguard Shielded Power Cable

3 Okopact® (Compact Stranded) Copper Conductors/105°C Rating
100% & 133% Insulation Level

For Cable Tray Use-Sunlight Resistant-For Direct Burial



- A Uncoated Okopact (Compact Stranded) Copper Conductors
- B Extruded Semiconducting EPR Strand Screen
- C Okoguard Insulation (EPR)
- D Extruded Semiconducting EPR Insulation Screen
- E Phase Identification Tape
- F Okopact Copper Grounding Conductor
- G Uncoated Copper Shield
- H Fillers and Binder Tape
- J Jacket-Black Okoseal

Insulation

Okoguard is Okonite's registered trade name for its exclusive ethylene-propylene rubber (EPR) base, thermosetting compound, whose optimum balance of electrical and physical properties is unequalled in other solid dielectrics. Okoguard insulation, with the distinctive red color and a totally integrated EPR system, provides the optimum balance of electrical and physical properties for long, problem free service.

Assembly

The Type MV-105 conductors are assembled with fillers and a binder tape overall. One bare stranded copper ground conductor is placed in one of the outer interstices.

Jacket

The Okoseal (PVC) jacket supplied with this cable is mechanically rugged and has excellent resistance to oil and most chemicals.

Applications

Okoguard shielded three conductor Okoseal Type MV-105 power cables are recommended for distribution circuits, and for feeders or branch circuits in industrial and utility power distribution systems. Type MV cables may be installed in wet or dry locations, indoors or outdoors (exposed to sunlight), in any raceway or underground duct, directly buried, cable tray, or messenger supported in industrial establishments and electric utilities.

Specifications

Conductors: Uncoated copper compact stranded per ASTM B-496.

Strand Screen: Extruded semiconducting EPR strand screen meets or exceeds electrical and physical requirements of ICEA S-93-639/NEMA WC74 and UL 1072.

Insulation: Okoguard meets or exceeds the electrical and physical requirements of ICEA S-93-639/NEMA WC74 and UL 1072. The insulated conductors are tested in accordance with AEIC CS8.

Insulation Screen: Extruded semiconducting EPR insulation screen per ICEA S-93-639/NEMA WC74, AEIC CS8 and UL 1072.

Shield: 5 mil uncoated copper tape helically applied with 12.5% nominal overlap.

Phase Identification: Color coded (black, red, blue) polyester ribbon laid longitudinally under the copper tape shield.

Grounding Conductor: Uncoated copper compact stranded per ASTM B-496 and sized in accordance with UL 1072.

Assembly: Cabled with fillers and ground wire in the interstices, binder tape overall.

Jacket: Meets or exceeds electrical and physical requirements of ICEA S-93-639/NEMA WC74 and UL 1072 for polyvinyl chloride jackets. UL Listed as Type MV-105, sunlight resistant for use in cable tray, and for direct burial in accordance with UL 1072.

Cables listed to CSA C68.3 are also available.

Product Features

- Triple tandem extruded, all EPR system.
- Complete prepackaged, color coded, factory tested wiring system.
- Passes the UL 1072 & IEEE 383 vertical tray flame test requirements.
- Complies with NEC Sections 310-7 and 710-4(b) for direct burial.
- Excellent corona resistance.
- Screens are clean stripping.
- Exceptional resistance to "treeing".
- Improved Temperature Rating.

Okoguard Okoseal Type MV-105



Product Data Section 2: Sheet 20

15kV Okoguard Shielded Power Cable

3 Okopact (Compact Stranded) Copper Conductors/105°C Rating
100% & 133% Insulation Level

For Cable Tray Use-Sunlight Resistant-For Direct Burial

Catalog Number (1)	Conductor Size AWG/kcmil	Conductor Size - mm ²	Approx. Diameter over Insulation (in.)	Grounding Conductor Size - AWG/kcmil	Grounding Conductor Size -mm ²	Approx. Core O.D.	Approx. Core O.D. - Inches	Jacket Thickness - mm	Jacket Thickness - mils	Approx. O.D. - mm	Approx. O.D. - Inches	Approx. Net Weight lbs./1000'	Approx. Ship Weight lbs./1000'	Ampacities in Air (2)	Ampacities Cable Tray (3)	Ampacities Direct Burial (4)
Okoguard Insulation: 175 mils (4.45mm), 100% Insulation Level																
115-23-3766	2 33.6	0.67	6 13.3	1.59 40.4	110 2.79	1.83 46.5	1985 2130	185 165 200								
115-23-3768	1/0 53.5	0.74	4 21.2	1.74 44.2	110 2.79	1.97 50.0	2560 2770	240 215 255								
115-23-3770	2/0 67.4	0.78	4 21.2	1.82 42.2	110 2.79	2.06 52.3	2890 3150	275 245 290								
115-23-3772	4/0 107.0	0.88	3 26.7	2.04 51.8	110 2.79	2.28 57.9	3905 4190	360 320 375								
115-23-3774	250 127.0	0.93	3 26.7	2.15 54.6	110 2.79	2.39 60.7	4390 4930	400 350 410								
115-23-3776	350 177.0	1.03	2 33.6	2.36 59.9	110 2.79	2.59 65.8	5608 6210	490 430 495								
115-23-3778	500 253.0	1.14	1 42.4	2.61 66.3	140 3.56	2.91 73.9	7480 8255	600 525 590								
115-23-3780	750 380.0	1.32	1/0 53.5	2.99 75.9	140 3.56	3.29 83.6	10320 11330	745 635 720								

Okoguard Insulation: 220 mils (5.59mm), 133% Insulation Level																
▲ 115-23-3802	2 33.6	0.76	6 13.3	1.79 45.5	110 2.79	2.02 51.3	2280 2575	185 165 200								
115-23-3804	1/0 53.5	0.83	4 21.2	1.93 49.0	110 2.79	2.17 55.1	2857 3145	240 215 255								
▲ 115-23-3806	2/0 67.4	0.87	4 21.2	2.02 51.3	110 2.79	2.26 57.4	3260 3570	275 245 290								
▲ 115-23-3808	4/0 107.0	0.97	3 26.7	2.24 56.9	110 2.79	2.48 63.0	4285 4640	360 320 375								
115-23-3810	250 127.0	1.03	3 26.7	2.36 60.0	110 2.79	2.59 65.8	4795 5295	400 350 410								
▲ 115-23-3812	350 177.0	1.12	2 33.6	2.56 65.0	140 3.56	2.85 72.4	6168 7000	490 430 495								
▲ 115-23-3814	500 253.0	1.24	1 42.4	2.81 71.4	140 3.56	3.10 78.7	7895 8945	600 525 590								
115-23-3816	750 380.0	1.41	1/0 53.5	3.19 81.0	140 3.56	3.49 88.7	10805 11800	745 635 720								

Visit Okointe's web site, www.okonite.com for the most up to date dimensions.

▲ Authorized stock item. Available from our Customer Service Centers.

Aluminum Conductors

(1) Aluminum conductors available on special orders.

Ampacities

(2) Ampacities are in accordance with Table 310.60(C)(71) of the NEC for an insulated three conductor cable, isolated in air, with a conductor operating temperature of 105°C and an ambient air temperature of 40°C.

(3) Ampacities are in accordance with Table 310.60(C)(75) of the NEC for a three conductor Type MV-105 cable installed in uncovered cable tray in accordance with Section 392.80(B) of the NEC with a conductor operating temperature of 105°C and ambient air temperature of 40°C. Where the cable tray is covered for more than six feet with solid unventilated covers, the ampacities shall not be more than 95% of the values shown above.

(4) Ampacities are in accordance with Table 310.60(C)(83) of the NEC for an insulated three conductor cable directly buried in the earth with a conductor operating temperature of 105°C, ambient earth temperature of 20°C, 100% load factor, thermal resistance (RHO) of 90.

Refer to the NEC, IEEE/ICEA S-135 Power Cable Ampacities or the Okonite Engineering Data Bulletin for installation in duct banks, other ambient temperatures, circuit configurations or installation requirements.



C-L-X[®] Type MV-90 or MC-HL

2.4 kV Okoguard[®] Nonshielded Power Cable-Aluminum Sheath 5000V CSA RA90

3 Okopact[®] (Compact Stranded) Copper Conductors/90°C Rating
100% and 133% Insulation Level
For Cable Tray Use-Sunlight Resistant-For Direct Burial



- A Uncoated, Okopact (Compact Stranded) Copper Conductor
- B Extruded Semiconducting EPR Strand Screen
- C Okoguard (EPR) Insulation
- D Three Copper Grounding Conductors
- E Phase Identification
- F Fillers and Binder Tape
- G Impervious, Continuous, Corrugated Aluminum C-L-X Sheath
- H Jacket- Low Temperature Yellow Okoseal

Insulation

Okoguard is Okonite's registered trade name for its exclusive ethylene-propylene rubber (EPR) base, thermosetting compound, whose optimum balance of electrical and physical properties is unequalled in other solid dielectrics. Okoguard insulation, with the distinctive red color and a totally integrated EPR system, provides the optimum balance of electrical and physical properties for long, problem free service.

Assembly

The Type MV-90 conductors are assembled with fillers and a binder tape into a round core. Three bare stranded copper grounding conductors, located in the outer interstices, is provided for grounding. A continuously corrugated welded aluminum sheath C-L-X encases the cable core. The C-L-X sheath is protected with a low temperature yellow Okoseal[®] (PVC) jacket. The impervious, continuous, corrugated aluminum C-L-X sheath provides complete protection against moisture, liquids and gases in addition to its excellent mechanical strength. Also, the aluminum C-L-X sheath has adequate ampacity capability to be used as a grounding conductor. The overall Okoseal (PVC) jacket allows the cable to be direct buried in the ground, embedded in concrete or areas subjected to a corrosive atmosphere.

Applications

C-L-X power cables are recommended as an economical alternate to a wire in conduit system. They are designed specifically for use on feeders and branch circuits in industrial power distribution systems. C-L-X power cables may be installed in both exposed and concealed work, wet and dry locations, direct burial in the earth, or embedded in concrete. They may be installed on metal racks, troughs, in cable trays or secured to supports not greater than 6 feet apart. C-L-X power cables are also approved for Classes I, II and III. Divisions 1 and 2 and Class I, Zones 1 and 2 hazardous locations - NEC Articles 501, 502, 503 and 505.

Medium voltage Non-Shielded cables discharge normally in service when spacing between phases is non-uniform or when phases are in close proximity to a grounded surface.

Specifications

Conductors: Annealed uncoated copper compact stranded per ASTM B-496.

Strand Screen: Extruded semiconducting EPR strand screen meets or exceeds electrical and

physical requirements of ICEA S-96-659/NEMA WC71 and UL 1072.

Insulation: Okoguard meets or exceeds the electrical and physical requirements of ICEA S-96-659/NEMA WC71 and UL 1072.

Phase Identification: Print color code (black, red and blue).

Grounding Conductors: Three uncoated copper Class B in accordance with UL 1072.

Assembly: Cabled with fillers and ground wires, in the interstices, binder tape overall.

Sheath: Close fitting, impervious, continuous, corrugated aluminum C-L-X per UL 1072. C-L-X is recognized as a grounding conductor by NEC.

Jacket: A low temperature sunlight resistant, yellow PVC jacket in accordance with UL 1072. Other color jackets are available. UL Listed as type MV-90 or MC-HL, sunlight resistant, for use in cable tray, and for direct burial in accordance with UL 1072 and 2225.

Product Features

- Tandem extruded, all EPR system.
- Complete prepackaged, color coded, factory tested wiring system.
- Okoguard C-L-X cables meet or exceed electrical and physical requirements of all recognized industry standards (UL, AEIC, NEMA/ICEA, IEEE).
- Passes the vertical tray flame test requirements of IEEE 383 and 1202, UL 1072, ICEA T-29-520(210,000 BTU/hr.)
- Complies with NEC Sections 310-7 and 300-50 for direct burial.
- Complies with NEC Articles 501, 502, 503 and 505 for hazardous locations.
- Continuous sheath provides grounding safety.
- Excellent corona resistance.
- Exceptional resistance to "treeing."
- Stress cones not required.
- Minimum installation temperature of -40°C.
- Three symmetrical grounding conductors for PWM/VFD and other modern AC drive/motor applications.
- ABS listed as CWCMC Type MC-HL.
- CSA listed as RA90, FT4, SR, HL, -40°C and 5000V.

C-L-X Type MV-90 or MC-HL

2.4 kV Okoguard Nonshielded Power Cable-
Aluminum Sheath — 5000V CSA RA90

3 Okopact® (Compact Stranded) Copper Conductors/90°C Rating
100% and 133% Insulation Level

For Cable Tray Use-Sunlight Resistant-For Direct Burial



Product Data Section 2: Sheet 21

Okoguard Insulation: 90 mils (2.29mm)

Catalog Number (1)	Conductor Size (AWG/kcmil)		Conductor Size - mm ²	Approx. Diameter over Insulation (in.)	Grounding Conductors No. x Size (AWG/kcmil)		Approx. Core O.D. - Inches	C-L-X O.D. - Inches		Jacket Thickness mils		Approx. O.D. - Inches		Approx. Net Weight lbs./1000'		Approx. Ship Weight lbs./1000'		Ampacities In Air (2)		Ampacities Cable Tray (3)		Ampacities Direct Burial (4)		
With Yellow Okoseal Jacket																								
571-21-3193	8	8.4	0.36	3x12	0.77	19.6	0.97	50	1.27	1.08	27.4	565	630	59	52	85								
571-21-3196	6	13.3	0.39	3x10	0.85	21.6	1.06	50	1.27	1.17	29.7	740	820	79	69	105								
▲ 571-21-3200	4	21.2	0.44	3x10	0.97	24.6	1.19	50	1.27	1.30	33.0	960	1050	105	91	135								
▲ 571-21-3204	2	33.6	0.50	3x10	1.10	27.9	1.34	50	1.27	1.45	36.8	1270	1470	140	125	180								
571-21-3208	1	42.4	0.52	3x8	1.16	29.4	1.42	50	1.27	1.53	38.9	1520	1660	160	140	200								
571-21-3212	1/0	53.5	0.56	3x8	1.23	31.2	1.51	60	1.52	1.65	41.9	1835	1980	185	165	230								
▲ 571-21-3217	2/0	67.4	0.60	3x8	1.33	33.8	1.60	60	1.52	1.73	43.9	2160	2325	215	190	260								
▲ 571-21-3224	4/0	107.0	0.70	3x7	1.53	38.9	1.83	60	1.52	1.96	49.8	3075	3340	285	255	335								
571-21-3228	250	127.0	0.75	3x6	1.64	41.7	1.96	60	1.52	2.09	53.1	3470	3725	320	280	365								
▲ 571-21-3236	350	177.0	0.85	3x6	1.86	47.2	2.19	60	1.52	2.32	58.9	4705	5265	395	350	440								
▲ 571-21-3244	500	253.0	0.96	3x5	2.10	53.3	2.45	75	1.91	2.61	66.3	6405	6965	485	425	530								
571-21-3248	750	380.0	1.14	3x4	2.51	63.8	2.93	75	1.91	3.10	78.7	9220	9980	615	525	650								
571-21-3252	1000	507.0	1.29	3x4	2.90	73.7	3.41	85	2.16	3.59	91.2	12075	13155	705	590	730								

Visit Okonite's web site, www.okonite.com for the most up to date dimensions.

▲ **Authorized stock item.** Available from our Customer Service Centers.
Copper or bronze and non-jacketed C-L-X is available on special order.

Jackets

Optional jacket types available - consult local sales office.

Aluminum Conductors

(1) Aluminum conductors are available on special order.

Ampacities

(2) Ampacities are in accordance with Table 310.71 of the NEC for an insulated three conductor cable, isolated in air, with a conductor operating temperature of 90°C and an ambient air temperature of 40°C.

(3) Ampacities are in accordance with Table 310.75 of the NEC for a three conductor Type MV-90 or MC cable installed in uncovered cable tray in accordance with Section 392.13 of the NEC with a conductor operating temperature of 90°C and ambient air temperature of 40°C. Where the cable tray is covered for more than six feet with solid unventilated covers, the ampacities shall not be more than 95% of the values shown above.

(4) Ampacities are in accordance with Table 310.83 of the NEC for an insulated three conductor cable directly buried in the earth with a conductor operating temperature of 90°C, ambient earth temperature of 20°C, 100% load factor and thermal resistance (RHO) of 90.

Refer to the NEC, IEEE/ICEA S-135 Power Cable Ampacity Tables, or the Okonite Engineering Data Bulletin for installation in duct banks, other ambient temperatures, circuit configurations or installation requirements.

C-L-X® The Okonite Company



C-L-X[®] Type MV-105 or MC-HL

5/8kV Okoguard[®] Shielded Power Cable-Aluminum Sheath

3 Okopact (Compact Stranded) Copper Conductors/105°C Rating

5kV-133% or 8kV-100% Insulation Level

For Cable Tray Use-Sunlight Resistant-For Direct Burial



- A Uncoated (Compact Stranded) Copper Conductors
- B Extruded Semiconducting EPR Strand Screen
- C Okoguard Insulation (EPR)
- D Extruded Semiconducting EPR Insulation Screen
- E Phase Identification Tape
- F Three Copper Grounding Conductors
- G Uncoated Copper Shield
- H Fillers and Binder Tape
- J Impervious, continuous, Corrugated Aluminum C-L-X Sheath
- K Jacket-Yellow Okoseal

Insulation

Okoguard is Okonite's registered trade name for its exclusive ethylene-propylene rubber (EPR) base, thermosetting compound, whose optimum balance of electrical and physical properties is unequalled in other solid dielectrics. Okoguard insulation, with the distinctive red color and a totally integrated EPR system, provides the optimum balance of electrical and physical properties for long, problem free service.

Assembly

Type MV-105 conductors are assembled with fillers, three bare stranded grounding conductors and a binder tape into a round core. A continuously corrugated welded aluminum sheath (C-L-X) encases the cable core. The C-L-X sheath is protected with a low temperature yellow Okoseal[®] jacket. The impervious, continuous, corrugated aluminum C-L-X sheath provides complete protection against moisture, liquids and gases in addition to its excellent mechanical strength. In addition, the aluminum sheath has adequate ampacity capability to be used as a grounding conductor in non HL areas. The Okoseal jacket allows the cable to be direct buried in the ground, embedded in concrete or areas subjected to corrosive atmospheres.

Applications

C-L-X power cables are recommended as an economical alternate to a wire in conduit system. They are designed specifically for use as feeders or branch circuits in industrial and utility power distribution systems. C-L-X power cables may be installed in both exposed and concealed work, wet and dry locations, directly buried in the earth, or embedded in concrete. They may be installed on metal racks, troughs, in cable trays or secured to supports not greater than 6 feet apart.

C-L-X Type MC-HL cables are also approved for Classes I, II, and III, Division 1 and 2 and Class I, Zones 1 and 2 hazardous locations - NEC Articles 501, 502, 503 and 505.

Specifications

Conductors: Uncoated copper compact stranded per ASTM B-496.

Strand Screen: Extruded semiconducting EPR strand screen meets or exceeds electrical and physical requirements of ICEA S-93-639/NEMA WC74 and UL 1072.

Insulation: Okoguard meets or exceeds the electrical and physical requirements of ICEA S-93-639/NEMA WC74 and UL 1072. The insulated conductors are tested in accordance with AEIC CS8.

Insulation Screen: Extruded semiconducting EPR insulation screen per ICEA S-93-639/NEMA WC74, AEIC CS8 and UL 1072.

Shield: 5 mil uncoated copper tape helically applied with 12.5% nominal overlap.

Phase Identification: Color coded (black, red, blue) polyester ribbon laid longitudinally under the copper shield tape.

Grounding Conductors: Three uncoated copper in accordance with UL 1072.

Assembly: Cabled with fillers and ground wires in the interstices, binder tape overall.

Sheath: Close fitting, impervious, continuous, corrugated aluminum C-L-X per UL 1072; C-L-X is recognized as a grounding conductor by NEC.

Jacket: A low temperature, sunlight resistant, yellow PVC jacket in accordance with UL 1072. Other color jackets are available. UL Listed as type MV-105 or MC-HL, sunlight resistant for use in cable tray, and for direct burial in accordance with UL 1072 & 2225. CSA Listed to C68.3.

Product Features

- Triple tandem extruded, all EPR system.
- Complete prepackaged, color coded, factory tested wiring system.
- Okoguard C-L-X cables meet or exceed all recognized industry standards (UL, AEIC, NEMA/ICEA, IEEE).
- Passes the vertical tray flame test requirements of IEEE 383 and 1202, UL 1072, ICEA T-29-520 (210,000 BTU/hr.).
- Complies with NEC Sections 310.7 and 300.50 for direct burial.
- Complies with NEC Articles 501, 502, 503 and 505 for hazardous locations.
- Continuous sheath provides grounding safety.
- Excellent corona resistance.
- Screens are clean stripping.
- Exceptional resistance to "treeing".
- Minimum installation temperature of -40°C.
- Improved Temperature Rating.
- Three symmetrical grounding conductors for PWM/VFD and other modern AC drive/motor applications.
- ABS listed as CWCMC Type MC-HL.
- CSA listed as FT4 and LTGG (-40°C).

C-L-X Type MV-105 or MC-HL

5/8kV Okoguard Shielded Power Cable-Aluminum Sheath
 3 Okopact (Compact Stranded) Copper Conductors/105°C Rating
 100% and 133% Insulation Level

Product Data Section 2: Sheet 22

For Cable Tray Use-Sunlight Resistant-For Direct Burial



Okoguard Insulation: 115 mils (2.92mm), 5kV-133% or 8kV-100% Insulation Level

Catalog Number (1)	Conductor Size (AWG/kcmil)		Conductor Size - mm ²	Approx. Diameter over Insulation (in.)	Grounding Conductors No. x Size (AWG/kcmil)		Approx. Core O.D. - Inches	Approx. Core O.D. - mm	C-L-X O.D. - Inches		Jacket Thickness mils		Jacket Thickness mm		Approx. O.D. - Inches	Approx. O.D. - mm	Approx. Net Weight lbs./1000'	Approx. Ship Weight lbs./1000'	Ampacities In Air (2)	Ampacities Cable Tray (3)	Ampacities Direct Burial(4)
With Yellow Okoseal Jacket																					
*571-22-3694	8	8.4	0.40	3x12	1.04	26.4	1.29	50	1.27	1.40	35.6	907	1056	66	58	90					
571-22-3696	6	13.3	0.44	3x10	1.12	28.4	1.37	50	1.27	1.48	37.6	1090	1259	88	77	115					
571-22-3698	4	21.2	0.48	3x10	1.21	30.7	1.51	60	1.52	1.65	41.9	1398	1556	115	100	150					
▲ 571-22-3706	2	33.6	0.54	3x10	1.34	34.0	1.64	60	1.52	1.78	45.2	1732	1890	154	135	190					
571-22-3708	1	42.4	0.58	3x8	1.40	35.6	1.69	60	1.52	1.82	46.2	1992	2137	180	155	215					
571-22-3710	1/0	53.5	0.61	3x8	1.48	37.6	1.78	60	1.52	1.91	48.5	2273	3012	205	185	245					
▲ 571-22-3717	2/0	67.4	0.65	3x8	1.57	39.9	1.92	60	1.52	2.00	50.8	2616	4171	240	210	280					
▲ 571-22-3725	4/0	107.0	0.75	3x7	1.78	45.2	2.15	60	1.52	2.29	58.2	3613	3980	320	285	360					
571-22-3727	250	127.0	0.80	3x6	1.90	48.3	2.28	60	1.52	2.44	62.0	4175	4390	355	315	395					
▲ 571-22-3838	350	177.0	0.89	3x6	2.10	53.3	2.45	75	1.91	2.61	66.3	5328	5435	440	390	475					
▲ 571-22-3846	500	253.0	1.01	3x5	2.35	57.6	2.75	75	1.91	2.91	73.9	7095	7603	545	475	570					
571-22-3748	750	380.0	1.19	3x4	2.73	69.3	3.24	85	2.16	3.42	86.9	10134	11021	685	585	700					
571-22-3751	1000	507.0	1.34	3x4	3.06	77.7	3.64	85	2.16	3.81	96.8	12966	14596	790	660	785					

* This cable is only rated 5kV (133%), due to UL limitations, it cannot be rated 8kV.

Visit Okonite's web site, www.okonite.com for the most up to date dimensions.

For 8kV ampacities refer to the NEC tables referenced below in the columns listed 5001-35,000 Volts

▲ **Authorized stock item.** Available from our Customer Service Centers.
 Copper or bronze C-L-X and non-jacketed C-L-X are available on special order.

Jackets

Optional jacket types available - consult local sales office.

Aluminum Conductors

(1) Aluminum conductors are available on special order.

Ampacities

(2) Ampacities are in accordance with Table 310.60(C)(71) of the NEC for an insulated three conductor cable, isolated in air, with a conductor operating temperature of 105°C and an ambient air temperature of 40°C.

(3) Ampacities are in accordance with Table 310.60(C)(75) of the NEC for a three conductor Type MV-105 or MC cable installed in uncovered cable tray in

accordance with Section 392.80(B) of the NEC with a conductor operating temperature of 105°C and ambient air temperature of 40°C. Where the cable tray is covered for more than six feet with solid unventilated covers, the ampacities shall not be more than 95% of the values shown above.

(4) Ampacities are in accordance with Table 310.60(B)(83) of the NEC for an insulated three conductor cable directly buried in the earth with a conductor operating temperature of 105°C, ambient earth temperature of 20°C, 100% load factor and thermal resistance (RHO) of 90.

Refer to the NEC, IEEE/ICEA S-135 Power Cable Ampacity Tables, or the Okonite Engineering Data Bulletin for installation in duct banks, other ambient temperatures, circuit configurations or installation requirements.

C-L-X® The Okonite Company



C-L-X® Type MV-105 or MC-HL



15kV Okoguard® Shielded Power Cable-Aluminum Sheath

3 Okopact® (Compact Stranded) Copper Conductors/105°C Rating
133% Insulation Level

For Cable Tray Use-Sunlight Resistant-For Direct Burial

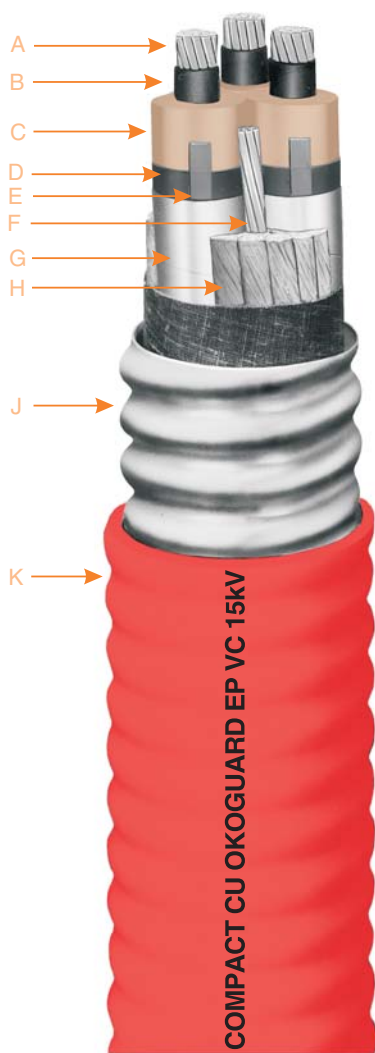

- A Uncoated Okopact (Compact Stranded) Copper Conductors
- B Extruded Semiconducting EPR Strand Screen
- C Okoguard Insulation (EPR)
- D Extruded Semiconducting EPR Insulation Screen
- E Phase Identification Tape
- F Copper Grounding Conductor
- G Uncoated Copper Shield
- H Fillers and Binder Tape
- J Impervious, Continuous, Corrugated Aluminum C-L-X Sheath
- K Jacket-Red Low Temperature Okoseal

Insulation

Okoguard is Okonite's registered trade name for its exclusive ethylene-propylene rubber (EPR) base, thermosetting compound, whose optimum balance of electrical and physical properties is unequalled in other solid dielectrics. Okoguard insulation, with the distinctive red color and a totally integrated EPR system, provides the optimum balance of electrical and physical properties for long, problem free service.

Assembly

The Type MV-105 conductors are assembled with fillers, one bare stranded grounding conductor and a binder tape into a round core. A continuously corrugated welded aluminum sheath (C-L-X) encases the cable core. The C-L-X sheath is protected with a low temperature red Okoseal® jacket. The impervious, continuous, corrugated aluminum C-L-X sheath provides complete protection against moisture, liquids and gases in addition to its excellent mechanical strength. In addition, the aluminum sheath has adequate ampacity capability to be used as a grounding conductor in non HL areas. The Okoseal jacket allows the cable to be direct buried in the ground, embedded in concrete or areas subjected to corrosive atmospheres.

Applications

C-L-X power cables are recommended as an economical alternate to a wire in conduit system. They are designed specifically for use as feeders or branch circuits in industrial and utility power distribution systems. C-L-X power cables may be installed in both exposed and concealed work, wet and dry locations, direct burial in the earth, or embedded in concrete. They may be installed on metal racks, troughs, in cable trays or secured to supports not greater than 6 feet apart.

C-L-X Type MC-HL cables are also approved for Classes I, II, and III, Divisions 1 and 2 and Class I, Zones 1 and 2 hazardous locations - NEC Articles 501, 502, 503 and 505.

Specifications

Conductors: Uncoated copper compact stranded per ASTM B-496.

Strand Screen: Extruded semiconducting EPR strand screen meets or exceeds electrical and physical requirements of ICEA S-93-639/NEMA WC74 and UL 1072.

Insulation: Okoguard meets or exceeds the electrical and physical requirements of ICEA S-93-639/NEMA WC74 and UL 1072. The insulated conductors are tested in accordance with AEIC CS8.

Insulation Screen: Extruded semiconducting EPR insulation screen meets or exceeds electrical and physical requirements of ICEA S-93-639/NEMA WC74 and UL 1072.

Shield: 5 mil uncoated copper tape helically applied with 12.5% nominal overlap.

Phase Identification: Color coded (black, red, blue) polyester ribbon laid longitudinally under the copper shield tape.

Grounding Conductor: Uncoated copper in accordance with UL 1072.

Assembly: Cabled with fillers and ground wire in the interstices, binder tape overall.

Sheath: Close fitting, impervious, continuous, corrugated aluminum C-L-X per UL 1072; C-L-X is recognized as a grounding conductor by NEC.

Jacket: A low temperature, sunlight resistant, red PVC jacket in accordance with UL 1072. Other color jackets are available.

UL Listed as type MV-105 or MC-HL, sunlight resistant, for use in cable tray, and for direct burial in accordance with UL 1072 and 2225. UL certified to IEEE 1580. CSA Listed to C68.3.

Product Features

- Triple tandem extruded, all EPR system.
- Complete prepackaged, color coded, factory tested wiring system.
- Okoguard C-L-X cables meet or exceed all recognized industry standards (UL, AEIC, NEMA/ICEA, IEEE).
- Passes the vertical tray flame test requirements of IEEE 383 and 1202, UL 1072, ICEA T-29-520 (210,000 BTU/hr.)
- Complies with NEC Sections 310.7 and 300.50 for direct burial.
- Complies with NEC Articles 501, 502, 503 and 505 for hazardous locations.
- Continuous sheath provides grounding safety.
- Excellent corona resistance.
- Screens are clean stripping.
- Exceptional resistance to "treeing".
- Minimum installation temperature of -40°C.
- Improved Temperature Rating.
- ABS listed as CWCMC Type MC-HL.
- CSA listed as FT4 and LTGG (-40°C).

C-L-X Type MV-105 or MC-HL

Product Data Section 2: Sheet 24

15kV Okoguard Shielded Power Cable-Aluminum Sheath
3 Okopact (Compact Stranded) Copper Conductors/105°C Rating
133% Insulation Level
For Cable Tray Use-Sunlight Resistant-For Direct Burial
Okoguard Insulation: 220 mils (5.59mm)



Catalog Number (1)	Conductor Size (AWG/kcmil)		Conductor Size - mm ²	Approx. Diameter over Insulation (In.)	Grounding Conductor Size (AWG/kcmil)		Approx. Core O.D. - Inches	Approx. Core O.D. - mm	C-L-X O.D. - Inches	Jacket Thickness (mils)	Jacket Thickness mm	Approx. O.D. - Inches	Approx. O.D. - mm	Approx. Net Weight lbs./1000'	Approx. Ship Weight lbs./1000'	Ampacities In Air (2)	Ampacities Cable Tray (3)	Ampacities Direct Burial (4)
With Red Okoseal Jacket																		
▲ 571-23-3504	2	33.6	0.76	6	1.79	45.5	2.15	60	1.52	2.28	57.9	2420	3147	185	165	200		
571-23-3508	1	42.4	0.79	4	1.86	47.3	2.23	60	1.52	2.36	60.0	2706	3404	210	185	225		
571-23-3512	1/0	53.5	0.83	4	1.94	49.3	2.32	75	1.91	2.48	63.0	3076	3674	240	215	255		
▲ 571-23-3516	2/0	67.4	0.87	4	2.03	51.6	2.41	75	1.91	2.57	65.3	3434	4219	275	245	290		
▲ 571-23-3524	4/0	107.0	0.97	3	2.24	57.0	2.63	75	1.91	2.79	70.9	4460	5385	360	320	345		
571-23-3528	250	127.0	1.03	2	2.36	60.0	2.76	75	1.91	2.92	74.2	5078	5845	400	350	410		
▲ 571-23-3536	350	177.0	1.12	2	2.56	65.0	2.98	75	1.91	3.14	79.8	6264	7305	490	430	495		
▲ 571-23-3544	500	253.0	1.24	1	2.81	71.4	3.28	75	1.91	3.46	89.2	8221	9653	600	525	590		
▲ 571-23-3548	750	380.0	1.41	1/0	3.19	81.0	3.76	85	2.16	3.94	100.0	11317	13087	745	635	720		

Visit Okonite's web site, www.okonite.com for the most up to date dimensions.

▲ **Authorized stock item.** Available from our Customer Service Centers.

Jackets

Optional jacket types available - consult local sales office.

Copper or bronze C-L-X and non-jacketed C-L-X are available on special order.

Aluminum Conductors

(1) Aluminum conductors are available on special order.

Ampacities

(2) Ampacities are in accordance with Table 310.60(B)(71) of the NEC for an insulated three conductor cable, isolated in air, with a conductor operating temperature of 105°C and an ambient air temperature of 40°C.

(3) Ampacities are in accordance with Table 310.60(B)(75) of the NEC for a three conductor Type MV-105 or MC cable installed in uncovered cable tray in accordance with Section 392.80(B) of the NEC with a conductor operating temperature of 105°C and ambient air temperature of 40°C. Where the cable tray

is covered for more than six feet with solid unventilated covers, the ampacities shall not be more than 95% of the values shown above.

(4) Ampacities are in accordance with Table 310.60(B)(83) of the NEC for an insulated three conductor cable directly buried in the earth with a conductor operating temperature of 105°C, ambient earth temperature of 20°C, 100% load factor, thermal resistance (RHO) of 90.

Refer to the NEC, IEEE/ICEA S-135 Power Cable Ampacity Tables, or the Okonite Engineering Data Bulletin for installation in duct banks, other ambient temperatures, circuit configurations or installation requirements.

C-L-X® The Okonite Company



Solid Type PILC

15kV Paper Insulated Lead Covered Power Cable

Three Copper Conductors/90°C Rating
100% Insulation Level

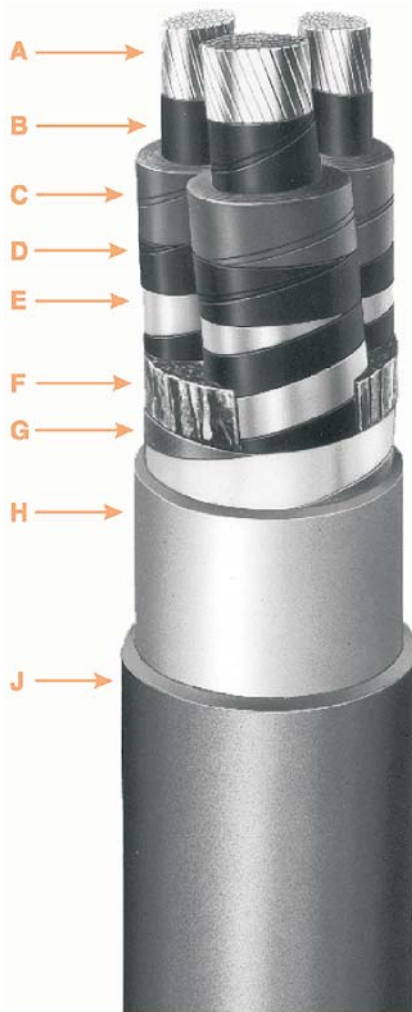

- A Conductors-Stranded Compact Sector, Pre-twisted
- B Strand Screen-Carbon Black Paper Tapes
- C Insulation- Impregnated Paper Tapes
- D Insulation Screen-Carbon Black Paper Tape
- E Shield Copper Tape
- F Fillers-Impregnated Paper
- G Binder Copper Tape
- H Sheath-Copper Bearing Lead
- J Jacket-Okolene (PE)

Insulation

Okonite's impregnated paper insulation consists of the finest electrical grade paper made from coniferous wood pulp and the purest grade polybutene dielectric fluid. The paper is manufactured to Okonite's specifications to produce the necessary mechanical and physical properties to resist tearing and wrinkling during manufacture and subsequent handling during installation conditions; and in addition, to assure properties of low dielectric loss with high dielectric strength. Okonite pretwists the sectors of 3/C cables before taping to virtually eliminate wrinkles at the cabling machine. To maintain a smooth, wrinkle-free precisely gapped tape insulation, Okonite carefully slits its own taping pads into widths tailored for each conductor size and wall thickness. Most important, Okonite has the latest taping machines with the most precise tape tension controls available today.

The impregnating fluids used are of medium viscosity (high viscosity optional) polybutene types, also manufactured to Okonite specifications. Polybutene dielectric fluids are better than natural petroleum based insulating fluids because they resist aging, have lower and more stable power factor values and possess an inherent tackiness which resists draining out of the paper tapes. Okonite's impregnation facilities clay-filter and degas the dielectric fluids to provide low power factors and stable ionization levels from voltage stress.

Sheath & Jacket

Okonite's copper bearing lead sheath provides an impervious barrier from the environment; in addition, it provides mechanical protection for the insulation and encapsulation of the impregnant. All lead sheaths have the inherent capacity for substantial electrical conductivity, even under short circuit conditions without requiring a separate ground. Okonite's lead sheaths are applied with a continuous lead extruder under the control of a thickness gauge for uniform wall thickness and concentricity of extrusion.

The Okolene jacket provides mechanical and corrosion protection for the lead sheath and is used in most installations. (Indoor and aerial installations may not require a jacket). Okolene is a thermoplastic polyethylene material that resists most chemicals and moisture; it is unaffected by oils below 60°C and has a low

coefficient of friction which aids pulling through ducts and conduits.

Applications

Okonite Paper Insulated Lead Covered 3/C cable is recommended for use in underground ducts, direct buried, and aerially when lashed to a messenger. PILC cables are used in any circuit that requires the highest reliability, the longest uninterrupted service life, and where the greatest surge, impulse and AC dielectric strength is desired. An added advantage is that a 3/C PILC cable permits the largest amount of power to be transmitted in the smallest diameter space because of its unique triangle shaped and nested design.

Although not shown as an insulation above 600 Volts in the National Electrical Code, it is readily approved for use by local inspectors because of its extensive safe use by utilities. Therefore, PILC cables can be used in industrial or commercial applications with prior notification and approval by the local inspector.

Also available in other voltage ratings.

Specifications

Okonite PILC cables are manufactured in accordance with and meet the requirements of AEIC CS1-12 12th Edition.

Product Features

- Pre-twisted conductors.
- Polybutene impregnating fluid.
- 90°C continuous operating temperature.
- 110°C emergency rating.
- 200°C short circuit rating.
- High impulse strength.
- Proven service life of over 60 years.
- Impervious to environment.
- Also available with LS/ZH Okoclear TP (TPPO) Okoseal (PVC) and ROC (Reinforced Okonite Covering).

Solid Type PILC

15kV Paper Insulated Lead Covered Power Cable
 Three Copper Conductors/90°C Rating
 100% Insulation Level

Product Data Section 2: Sheet 31

Catalog Number	Conductor Size AWG/kcmil	Conductor Size - mm ²	Insulation Thickness - mils	Insulation Thickness - mm	Lead Thickness - mils	Jacket Thickness - mils	Cable Diameter - mils	Net Weight - lbs./ft.	Ampacities Duct (1)	Ampacities in Air (2)
Concentric Round										
101-63-4120	2	33.6	180	4.6	90	90	1.92	4.34	146	149
101-63-4175	1	42.4	165	4.2	90	90	1.94	4.53	167	171
Compact Round										
101-63-4243	1/0	53.5	165	4.2	90	90	1.97	4.83	191	197
Compact Sector										
101-63-4277	2/0	67.4	165	4.2	90	90	1.92	4.80	215	222
101-63-4335	3/0	85.0	165	4.2	90	90	2.00	5.32	245	256
101-63-4373	4/0	107.0	165	4.2	95	90	2.12	6.13	280	295
101-63-4436	250	127.0	165	4.2	95	90	2.19	6.67	307	327
101-63-4553*	350	177.0	165	4.2	100	90	2.37	8.14	371	402
▲ 101-63-4544	350	177.0	165	4.2	100	90	2.37	8.19	371	402
101-63-4666*	500	253.0	165	4.2	105	110	2.64	10.31	450	498
▲ 101-63-4665	500	253.0	165	4.2	105	110	2.64	10.37	450	498
101-63-4904	750	380.0	165	4.2	110	110	2.94	13.71	555	631
101-63-4986	1000	507.0	165	4.2	120	110	3.29	17.33	636	740

*Zinc Shielding Tape in lieu of Copper

▲ **Authorized Stock Item.** Stock Items with copper shield tapes, copper binder tape and high viscosity polybutene impregnating fluid. Available from our Customer Service Centers.

Ampacities

- (1) One circuit, 90°C conductor, RHO 90 and 20°C earth ambient temperatures, 100% load factor.
- (2) One circuit or multiple circuits spaced a cable diameter or more apart, 40°C ambient air temperature, 40 to 100% load factor.



Okoguard® URO-J 15kV Underground Primary Distribution Cable-Jacketed Red Identification Stripes

Aluminum Conductor/105°C Rating
100% and 133% Insulation Levels



- A Conductor-Stranded Aluminum
- B Strand Screen-
Extruded Semiconducting EPR
- C Insulation-Okoguard-EPR
- D Insulation Screen-
Extruded Semiconducting EPR
- E Concentric Conductor-Bare
Copper Wires
- F Encapsulating Jacket-Okolene
with 3 extruded red ID stripes
and NESC lightning bolt

Insulation

Okoguard is Okonite's registered trade name for its exclusive ethylene-propylene rubber (EPR) based, thermosetting compound, whose optimum balance of electrical and physical properties is unequalled in other solid dielectrics.

Okoguard insulation, with the distinctive red color and a totally integrated EPR system, provides the optimum balance of electrical and physical properties for long, problem free service.

The triple tandem extrusion of the screens with the insulation provides optimum electrical characteristics.

An insulation screen of ethylene-propylene rubber is extruded over the insulation. The bare copper concentric wires are uniformly spaced around the insulation screen. The overall polyethylene jacket provides protection against mechanical damage and corrosion.

Product identification is provided through the use of three red stripes placed 120° apart in the black jacket with an NESC lightning bolt.

Applications

Okoguard URO-J cables provide maximum circuit longevity in underground residential distribution systems. They can be buried directly or installed in underground ducts or conduits.

Specifications

Central Conductor: Aluminum per ASTM B-609, Class B stranded per B-231.

Conductor Screen: Extruded semiconducting ethylene-propylene rubber meets or exceeds the requirements of ICEA S-94-649 and AEIC CS8.

Insulation: Extruded Okoguard meets or exceeds the requirements of ICEA S-94-649 for ethylene-propylene rubber and AEIC CS8.

Insulation Screen: Extruded semiconducting ethylene-propylene rubber meets or exceeds the requirements of ICEA S-94-649 and AEIC CS8.

Concentric Conductor: Bare copper wires.

Jacket: Black Okolene with red extruded stripes meets or exceeds the requirements of ICEA S-94-649 for polyethylene jackets.

Product Features

- Triple tandem extruded, all EPR system
 - Okoguard cables meet or exceed ICEA and RUS 7CFR 1728.204 standards.
 - 105°C continuous operating temperature.
 - 140°C emergency rating.
 - 250°C short circuit rating.
 - Excellent corona resistance.
 - Low dielectric constant and power factor.
 - Screens are clean stripping.
 - Exceptional resistance to "treeing".
 - Moisture resistant.
 - Overall jacket provides extended life.
 - Red extruded stripes.
 - Excellent resistance to most chemicals.
 - Can be listed as Type MV-90 for use in accordance with Article 328 of the NEC on special orders.
 - Cable CSA Listed to C68.5 on special orders.
 - Design Options:
 - Additional conductor sizes
 - Filled strand
 - Copper central conductor
 - Copper flat strap concentric neutral
 - Product identification via colored jackets.
 - Semiconducting jacket
 - Improved Temperature Rating.
- Okoguard insulation system has been tested and qualified for operation at 105°C continuous and 140°C emergency operating temperature.
- Minimum installation temperature of -40°C.

Okoguard URO-J

15kV Underground Primary Distribution Cable-Jacketed
 Red Identification Stripes
 Aluminum Conductor/105°C Rating
 100% Insulation Level

Product Data Section 2: Sheet 35

Okoguard Insulation: 175 mils 100% Insulation Level

Catalog Number	Conductor Size AWG/kcmil	Nominal Dia. over Insulation (in.)	Nominal Dia. over Insulation Screen (in.)	Copper Neutral No. x AWG (1)	Nominal O.D. (in.)	Approx. Net Weight lbs./1000'	Approx. Ship Weight lbs./1000'	90° Ampacity Direct Burial (2)	90° Ampacity Duct (2)	105° Ampacity Direct Burial (2)	105° Ampacity Duct (2)
FULL NEUTRAL											
161-23-2057	2(1x)	0.66	0.73	10 x 14	0.97	513	603	165	120	180	130
▲ 161-23-2060	2(7x)	0.67	0.75	10 x 14	0.98	517	568	165	120	180	130
161-23-2066	1(19x)	0.72	0.80	13 x 14	1.03	608	698	185	135	205	150
161-23-2069	1/0(1x)	0.72	0.80	16 x 14	1.04	657	747	210	155	235	170
▲ 161-23-2072	1/0(19x)	0.75	0.83	16 x 14	1.06	667	725	235	170	235	170
161-23-2075	2/0(19x)	0.81	0.88	13 x 12	1.15	820	910	240	175	270	200
161-23-2078	3/0(19x)	0.86	0.93	16 x 12	1.20	939	1029	270	200	305	225
161-23-2081	4/0(19x)	0.91	0.99	13 x 10	1.30	1138	1238	310	230	650	260
161-23-2084	250(37x)	0.97	1.04	16 x 10	1.36	1302	1418	340	255	385	285
161-23-2090	350(37x)	1.07	1.17	20 x 10	1.49	1615	1793	405	300	455	340
1/3 NEUTRAL											
160-23-2057	2(1x)	0.66	0.73	6 x 14	0.97	467	528	155	135	165	130
160-23-2060	2(7x)	0.68	0.76	6 x 14	1.00	489	579	155	135	165	130
160-23-2066	1(19x)	0.72	0.80	6 x 14	1.03	527	617	175	155	190	150
160-23-2069	1/0(1x)	0.72	0.80	6 x 14	1.04	541	663	200	175	215	175
160-23-2072	1/0(19x)	0.76	0.84	6 x 14	1.07	572	662	200	175	215	175
160-23-2075	2/0(19x)	0.81	0.88	7 x 14	1.12	636	726	230	200	245	195
160-23-2078	3/0(19x)	0.86	0.93	9 x 14	1.17	722	889	260	230	280	225
160-23-2081	4/0(19x)	0.91	0.99	11 x 14	1.23	822	922	290	240	315	225
160-23-2084	250(37x)	0.97	1.04	13 x 14	1.28	918	1018	320	260	345	280
160-23-2090	350(37x)	1.07	1.17	18 x 14	1.41	1166	1315	380	320	415	345
160-23-2093	500(37x)	1.20	1.30	16 x 12	1.57	1513	1691	455	385	495	415
160-23-2096	750(61x)	1.39	1.49	15 x 10	1.87	2152	2402	555	470	600	510
160-23-2099	1000(61x)	1.54	1.68	18 x *(A)	2.06	2711	3059	645	550	685	585

* - Special Conductor Size (A) Wire O.D. =0.1066"

(1) Individual wire size and count may vary. The resulting combination meets the 1/3 or full neutral, size requirement.

Visit Okonite's web site www.okonite.com for the most up to date dimensions.

▲ **Authorized stock item.** Available from our Customer Service Centers.

Ampacities

(2) Full neutral, single phase ampacities are based on 90°C or 105°C conductor temperature, 20°C ambient temperature, 100% load factor, and earth thermal resistivity of RHO 90. One third neutral ampacities are based on ICEA P-53-426 triplexed or triangular configuration for the same conditions stated above.

Okoguard URO-J

15kV Underground Primary Distribution Cable-Jacketed
 Red Identification Stripes
 Aluminum Conductor/105°C Rating
 133% Insulation Levels

Product Data Section 2: Sheet 35

Okoguard Insulation: 220 mils 133% Insulation Level

Catalog Number	Conductor Size AWG/kcmil	Nominal Dia. over Insulation (in.)	Nominal Dia. over Insulation Screen (in.)	Copper Neutral No. x AWG (1)	Nominal O.D. (in.)	Aprox. Net Weight lbs./1000'	Aprox. Ship Weight lbs./1000'	90° Ampacity Direct Burial (2)	90° Ampacity Duct (2)	105° Ampacity Direct Burial (2)	105° Ampacity Duct (2)
FULL NEUTRAL											
▲ 161-23-3057	2(1x)	0.74	0.82	10 x 14	1.06	577	635	165	120	180	130
▲ 161-23-3060	2(7x)	0.77	0.84	10 x 14	1.08	595	662	165	120	180	130
161-23-3066	1(19x)	0.81	0.89	13 x 14	1.13	691	781	185	135	205	150
▲ 161-23-3069	1/0(1x)	0.81	0.89	16 x 14	1.12	726	792	210	170	235	170
▲ 161-23-3072	1/0(19x)	0.84	0.92	16 x 14	1.15	752	818	210	170	235	170
161-23-3075	2/0(19x)	0.90	0.97	13 x 12	1.24	912	1012	240	175	270	200
161-23-3078	3/0(19x)	0.95	1.02	16 x 12	1.29	1036	1136	270	200	305	225
161-23-3081	4/0(19x)	1.01	1.08	13 x 10	1.39	1241	1357	310	230	650	260
161-23-3084	250(37x)	1.06	1.16	16 x 10	1.48	1441	1619	340	255	385	285
161-23-3090	350(37x)	1.17	1.27	20 x 10	1.58	1734	1912	405	300	455	340
1/3 NEUTRAL											
160-23-3057	2(1x)	0.75	0.82	6 x 14	1.06	544	621	155	135	165	130
160-23-3060	2(7x)	0.78	0.85	6 x 14	1.09	569	659	155	135	165	130
160-23-3066	1(19x)	0.81	0.89	6 x 14	1.13	610	700	175	155	190	150
160-23-3069	1/0(1x)	0.82	0.89	6 x 14	1.13	625	715	200	175	215	175
160-23-3072	1/0(19x)	0.85	0.93	6 x 14	1.17	658	748	200	175	215	175
160-23-3075	2/0(19x)	0.90	0.97	7 x 14	1.21	726	826	230	200	245	195
160-23-3078	3/0(19x)	0.95	1.02	9 x 14	1.26	816	916	260	230	280	225
▲ 160-23-3081	4/0(19x)	0.99	1.06	11 x 14	1.30	889	1002	290	240	315	255
160-23-3084	250(37x)	1.06	1.16	13 x 14	1.40	1052	1168	320	260	345	280
160-23-3090	350(37x)	1.17	1.27	18 x 14	1.50	1280	1458	380	320	415	345
160-23-3093	500(37x)	1.29	1.39	16 x 12	1.73	1709	1959	455	385	495	415
▲ 160-23-3096	750(61x)	1.48	1.58	15 x 10	1.96	2237	2518	555	470	600	510
160-23-3099	1000(61x)	1.64	1.77	18 x *(A)	2.15	2875	3223	645	550	685	585
160-23-9592	1100(61x)	1.62	1.75	12 x 14	2.05	2307	2593	700	590	760	645

* - Special Conductor Size (A) Wire O.D. = 0.1066"

** - Special design 7% neutral, Compact Conductor

(1) Individual wire size and count may vary. The resulting combination meets the 1/3 or full neutral, size requirement.

Visit Okonite's web site www.okonite.com for the most up to date dimensions.

Ampacities

(2) Full neutral, single phase ampacities are based on 90°C conductor temperature, 20°C ambient temperature, 100% load factor, earth thermal resistivity of RHO 90 and 36" depth of burial.

One third neutral ampacities are based on ICEA P-53-426 triplexed or triangular configuration for the same conditions stated above.



Okoguard® URO-J

15kV Underground Primary Distribution Cable-Jacketed Red Identification Stripes

Filled Strand Aluminum Conductor/105°C Rating
100% and 133% Insulation Levels



- A Conductor - Stranded Aluminum with Filled Strand - Water Swellable Power
- B Strand Screen - Extruded Semi-conducting EPR
- C Insulation - Okoguard EPR
- D Insulation Screen - Extruded Semi-conducting EPR
- E Concentric Conductor-Bare Copper Wires
- F Encapsulating Jacket-Okolene with Extruded ID Stripes & NESC lightning bolt

Insulation

Okoguard is Okonite's registered trade name for its exclusive ethylene-propylene rubber (EPR) based, thermosetting compound, whose optimum balance of electrical and physical properties is unequalled in other solid dielectrics. Okoguard insulation, with the distinctive red color and a totally integrated EPR system, provides the optimum balance of electrical and physical properties for long, problem free service.

The triple tandem extrusion of the screens with the insulation provides optimum electrical characteristics.

The compressed conductors are filled with water swellable powder. This construction slows the migration of water through the strands in the event of a mechanical dig-in followed by external exposure to water.

An insulation screen of ethylene-propylene rubber is extruded over the insulation. The copper concentric wires are uniformly spaced around the insulation screen. The overall polyethylene jacket provides protection against mechanical damage and corrosion.

Product identification is provided through the use of three red stripes placed 120° apart in the black jacket, with an NESC lightning bolt.

Applications

Okoguard URO-J cables provide maximum circuit longevity in underground residential distribution systems. They can be buried directly or installed in underground ducts or conduits.

Specifications

Central Conductor: Aluminum per ASTM B-609, Class B stranded per B-231.

Filled Strand: Water swellable powder meets or exceeds ICEA T-31-610 water penetration resistance and ANSI/NEMA class A connectorability requirements.

Conductor Screen: Extruded semiconducting ethylene-propylene rubber meets or exceeds the requirements of ICEA S-94-649 and AEIC CS8.

Insulation: Extruded Okoguard meets or exceeds the requirements of ICEA S-94-649 and AEIC CS8.

Insulation Screen: Extruded semiconducting ethylene-propylene rubber meets or exceeds the requirements of ICEA S-94-649 and AEIC CS8.

Concentric Conductor: Bare copper wires.

Jacket: Black Okolene with red extruded stripes meets or exceeds the requirements of ICEA S-94-649 for polyethylene jackets.

Product Features

- Triple tandem extruded, all EPR system.
- Okoguard cables meet or exceed NEMA/ICEA and RUS 7CFR 1728.204 standards.
- 105°C continuous operating temperature.
- 140°C emergency rating.
- 250°C short circuit rating.
- Excellent corona resistance.
- Low dielectric constant and power factor.
- Screens are clean stripping.
- Exceptional resistance to "treeing".
- Filled strand conductor.
- Moisture resistant.
- Overall jacket provides extended life.
- Excellent resistance to most chemicals.
- Can be listed by UL as Type MV-90 on special orders.
- Cable listed by CSA to C68.5 on special orders.
- Design Options:
 - Additional conductor sizes
 - Copper central conductor
 - Copper flat strap concentric neutral
 - Product identification via colored jackets.
 - Semiconducting jackets.
- Improved Temperature Rating. Okoguard insulation system has been tested and qualified for operation at 105°C continuous and 140°C emergency operating temperature.
- Minimum installation temperature of -40°C.

Okoguard URO-J

15kV Underground Primary Distribution Cable-Jacketed
 Red Identification Stripes
 Filled Strand Aluminum Conductor/105°C Rating
 100% Insulation Level

Product Data Section 2: Sheet 36

Okoguard Insulation: 175 mils 100% Insulation Level

Catalog Number	Conductor Size AWG/kcmil	Nominal Dia. over Insulation (in.)	Nominal Dia. over Insulation Screen (in.)	Copper Neutral, No. x AWG (1)	Nominal O.D. (in.)	Approx. Net Weight lbs./1000'		Approx. Ship Weight lbs./1000'		90° Ampacity Direct Burial (2)	90° Ampacity Duct (2)	105° Ampacity Direct Burial (2)	105° Ampacity Duct (2)
FULL NEUTRAL													
163-23-2060	2(7x)	0.68	0.76	10 x 14	1.00	536	626	165	120	180	130		
163-23-2066	1(19x)	0.72	0.80	13 x 14	1.03	608	698	185	135	205	150		
**163-23-2072	1/0(19x)	0.76	0.84	16 x 14	1.07	688	778	210	155	235	170		
163-23-2075	2/0(19x)	0.81	0.88	13 x 12	1.15	820	910	240	175	270	200		
163-23-2078	3/0(19x)	0.86	0.93	16 x 12	1.20	939	1029	270	200	305	225		
163-23-2081	4/0(19x)	0.91	0.99	13 x 10	1.30	1138	1238	310	230	350	260		
163-23-2084	250(37x)	0.97	1.04	16 x 10	1.36	1302	1418	340	255	385	285		
163-23-2090	350(37x)	1.07	1.17	20 x 10	1.49	1615	1793	405	300	455	340		
1/3 NEUTRAL													
162-23-2060	2(7x)	0.68	0.76	6 x 14	1.00	489	579	155	135	165	130		
162-23-2066	1(19x)	0.72	0.80	6 x 14	1.03	527	617	175	155	190	150		
162-23-2072	1/0(19x)	0.76	0.84	6 x 14	1.07	572	662	200	175	215	175		
162-23-2075	2/0(19x)	0.81	0.88	7 x 14	1.12	636	726	230	200	245	195		
162-23-2078	3/0(19x)	0.86	0.93	9 x 14	1.17	722	889	260	230	280	225		
162-23-2081	4/0(19x)	0.91	0.99	11 x 14	1.23	822	922	290	240	315	255		
162-23-2084	250(37x)	0.97	1.04	13 x 14	1.28	918	1018	320	260	345	280		
162-23-2090	350(37x)	1.07	1.17	18 x 14	1.41	1166	1315	380	320	415	345		
162-23-2093	500(37x)	1.20	1.30	16 x 12	1.57	1513	1691	455	385	495	415		
162-23-2096	750(61x)	1.39	1.49	15 x 10	1.87	2152	2402	555	470	600	510		
162-23-2099	1000(61x)	1.54	1.68	18 x *(B)	2.06	2711	3059	645	550	685	585		

* - Special Conductor Size (A) Wire O.D. =0.1066"

** Stocked as unfilled strand as 161-23-2072, see Sec 2, Sheet 35.

(1) Individual wire size and count may vary. The resulting combination meets the 1/3 or full neutral, size requirement.

Visit Okonite's web site www.okonite.com for the most up to date dimensions.

Ampacities

(2) Full neutral, single phase ampacities are based on 90°C or 105°C conductor temperature, 20°C ambient temperature, 100% load factor, and earth thermal resistivity of RHO 90. One third neutral ampacities are based on ICEA P-53-426 triplexed or triangular configuration for the same conditions stated above.

Okoguard URO-J

15kV Underground Primary Distribution Cable-Jacketed
 Red Identification Stripes
 Filled Strand Aluminum Conductor/105°C Rating
 133% Insulation Level

Product Data Section 2: Sheet 36

Okoguard Insulation: 220 mils 133% Insulation Level

Catalog Number	Conductor Size AWG/kcmil	Nominal Dia. over Insulation (in.)	Nominal Dia. over Insulation Screen (in.)	Copper Neutral, No. x AWG (1)	Nominal O.D. (in.)	Aprox. Net Weight lbs./1000'	Aprox. Ship Weight lbs./1000'	90° Ampacity Direct Burial (2)	90° Ampacity Duct (2)	105° Ampacity Direct Burial (2)	105° Ampacity Duct (2)
FULL NEUTRAL											
▲ 163-23-3060	2(7x)	0.77	0.85	10 x 14	1.08	602	669	165	120	180	130
163-23-3066	1(19x)	0.82	0.90	13 x 14	1.14	694	766	185	135	205	150
▲ 163-23-3072	1/0(19x)	0.84	0.92	16 x 14	1.15	753	820	210	155	235	170
163-23-3075	2/0(19x)	0.91	0.98	13 x 12	1.25	916	996	240	175	270	200
163-23-3078	3/0(19x)	0.96	1.04	16 x 12	1.31	1045	1125	270	200	305	225
163-23-3081	4/0(19x)	1.02	1.09	13 x 10	1.41	1252	1347	310	230	350	260
163-23-3084	250(37x)	1.07	1.17	16 x 10	1.48	1456	1606	340	255	385	285
163-23-3090	350(37x)	1.18	1.28	20 x 10	1.59	1762	1912	405	300	455	340
1/3 NEUTRAL											
162-23-3060	2(7x)	0.78	0.85	6 x 14	1.09	562	627	155	135	165	130
162-23-3066	1(19x)	0.82	0.90	6 x 14	1.14	612	684	175	155	190	150
162-23-3072	1/0(19x)	0.86	0.94	6 x 14	1.18	661	733	200	175	215	175
162-23-3075	2/0(19x)	0.91	0.98	7 x 14	1.22	730	810	230	200	245	195
162-23-3078	3/0(19x)	0.96	1.04	9 x 14	1.27	825	905	260	230	280	225
▲ 162-23-3081	4/0(19x)	0.99	1.06	11 x 14	1.30	891	1005	290	240	315	255
162-23-3084	250(37x)	1.07	1.17	13 x 14	1.41	1069	1164	320	260	345	280
▲ 162-23-3090	350(37x)	1.16	1.26	18 x 14	1.50	1254	1425	380	320	415	345
▲ 162-23-3093	500(37x)	1.29	1.39	16 x 12	1.72	1666	1853	455	385	495	415
▲ 162-23-3096	750(61x)	1.48	1.58	15 x 10	1.95	2244	2468	555	470	600	510
▲ 162-23-3099	1000(61x)	1.63	1.77	18 x *(A)	2.15	2808	3093	645	550	685	585

* - Special Conductor Size (A) Wire O.D. = 0.1066"

(1) Individual wire size and count may vary. The resulting combination meets the 1/3 or full neutral, size requirement.

Visit Okonite's web site www.okonite.com for the most up to date dimensions.

▲ **Authorized Stock Item** - Available from Customer Service centers.

Ampacities

(2) Full neutral, single phase ampacities are based on ICEA's S-94-649, Appendix F for 90°C conductor temperature, 20°C ambient temperature, 100% load factor, and earth thermal resistivity of RHO 90 and modified for jacketed cable.

One third neutral ampacities are based on ICEA P-53-426 triplexed or triangular configuration for the same conditions stated above.



Okoguard® URO-J

25kV Underground Primary Distribution Cable-Jacketed Red Identification Stripes

Aluminum Conductor/105°C Rating
100% and 133% Insulation Levels



- A Conductor-Stranded Aluminum
- B Strand Screen-
Extruded Semiconducting EPR
- C Insulation-Okoguard EPR
- D Insulation Screen-
Extruded Semiconducting EPR
- E Concentric Conductor-Bare
Copper Wires
- F Encapsulating Jacket-Okolene with
three extruded red ID stripe, and
NESC lightning bolt

Insulation

Okoguard is Okonite's registered trade name for its exclusive ethylene-propylene rubber (EPR) based, thermosetting compound, whose optimum balance of electrical and physical properties is unequalled in other solid dielectrics. Okoguard insulation, with the distinctive red color and a totally integrated EPR system, provides the optimum balance of electrical and physical properties for long, problem free service.

The triple tandem extrusion of the screens with the insulation provides optimum electrical characteristics.

An insulation screen of ethylene-propylene rubber is extruded over the insulation. The bare copper concentric wires are uniformly spaced around the insulation screen. The overall polyethylene jacket provides protection against mechanical damage and corrosion.

Product identification is provided through the use of three red stripes placed 120° apart in the black jacket with an NESC lightning bolt.

Applications

Okoguard URO-J cables provide maximum circuit longevity in underground residential distribution systems. They can be buried directly or installed in underground ducts or conduits.

Specifications

Central Conductor: Aluminum per ASTM B-609, Class B stranded per B-231.

Conductor Screen: Extruded semiconducting ethylene-propylene rubber meets or exceeds the requirements of ICEA S-94-649 and AEIC CS8.

Insulation: Extruded Okoguard meets or exceeds the requirements of ICEA S-94-649 and AEIC CS8.

Insulation Screen: Extruded semiconducting ethylene-propylene rubber meets or exceeds the requirements of ICEA S-94-649 and AEIC CS8.

Concentric Conductor: Bare copper wires.

Jacket: Black Okolene® with red extruded stripes, meets or exceeds the requirements of ICEA S-94-649 for polyethylene jackets.

Product Features

- Triple tandem extruded, all EPR system.
- Okoguard cables meet or exceed ICEA and RUS 7CFR 1728.204 standards.
- 105°C continuous operating temperature
- 140°C emergency rating
- 250°C short circuit rating
- Excellent corona resistance.
- Low dielectric constant and power factor.
- Screens are clean stripping.
- Exceptional resistance to “treeing”.
- Moisture resistant.
- Overall jacket provides extended life.
- Red extruded stripes
- Excellent resistance to most chemicals.
- Can be UL Listed as MV90 for use in accordance with Art 328 of the NEC on special orders.
- Can be CSA Listed to C68.5 on special orders.
- Design Options:
 - Additional conductor sizes
 - Filled strand
 - Copper central conductor
 - Copper flat strap concentric neutral
 - Product identification via colored jackets
 - Semiconducting jackets
- Improved Temperature Rating.
Okoguard insulation system has been tested and qualified for operation at 105°C continuous and 140°C emergency operating temperature.
- Minimum installation temperature of -40°C.

Okoguard URO-J

25kV Underground Primary Distribution Cable-Jacketed

Red Identification Stripes

Aluminum Conductor/105°C Rating

100% Insulation Levels

Product Data Section 2: Sheet 39

Okoguard Insulation: 260 mils 100% Insulation Level

Catalog Number	Conductor Size AWG/kcmil	Nominal Dia. over Insulation (in.)	Nominal Dia. over Insulation Screen (in.)	Copper Neutral No. x AWG (1)	Nominal O.D. (in.)	Aprox. Net Weight lbs./1000'	Aprox. Ship Weight lbs./1000'	90° Ampacity Direct Burial (2)	90° Ampacity Duct (2)	105° Ampacity Direct Burial (2)	105° Ampacity Duct (2)
FULL NEUTRAL											
161-23-4066	1 (19x)	0.90	0.97	13 x 14	1.21	772	872	185	135	205	150
▲ 161-23-4069	1/0 (1x)	0.89	0.97	16 x 14	1.20	803	870	210	150	235	170
161-23-4072	1/0 (19x)	0.92	1.00	16 x 14	1.23	832	898	210	150	235	170
▲ 163-23-4072*	1/0 (19x)	0.92	1.00	16 x 14	1.23	833	899	210	150	235	170
161-23-4075	2/0 (19x)	0.98	1.05	13 x 12	1.33	1001	1117	240	175	270	200
161-23-4078	3/0 (19x)	1.03	1.13	16 x 12	1.40	1157	1273	270	200	305	225
161-23-4081	4/0 (19x)	1.09	1.19	13 x 10	1.50	1372	1550	305	225	345	260
161-23-4084	250 (37x)	1.14	1.24	16 x 10	1.56	1546	1724	335	250	380	285
161-23-4090	350 (37x)	1.25	1.35	20 x 10	1.73	1916	2166	405	300	450	345

1/3 NEUTRAL											
160-23-4066	1 (19x)	0.90	0.97	6 x 14	1.21	691	791	175	155	190	150
160-23-4072	1/0 (19x)	0.94	1.01	6 x 14	1.25	741	841	200	175	215	175
160-23-4075	2/0 (19x)	0.98	1.05	7 x 14	1.29	812	912	230	200	245	200
160-23-4078	3/0 (19x)	1.03	1.13	9 x 14	1.37	935	1051	260	230	280	230
160-23-4081	4/0 (19x)	1.07	1.17	11 x 14	1.40	1010	1128	290	245	315	260
▲ 162-23-4081*	4/0 (19x)	1.07	1.17	11 x 14	1.40	1011	1129	290	245	315	260
160-23-4084	250 (37x)	1.14	1.24	13 x 14	1.48	1152	1330	315	265	340	285
160-23-4090	350 (37x)	1.25	1.35	18 x 14	1.59	1388	1566	375	325	410	350
160-23-4093	500 (37x)	1.37	1.47	16 x 12	1.80	1782	1986	450	390	495	415
▲ 162-23-4093*	500 (37x)	1.37	1.47	16 x 12	1.80	1784	1988	450	390	495	415
160-23-4096	750 (61x)	1.56	1.70	15 x 10	2.06	2450	2754	550	480	600	515
▲ 162-23-4096*	750 (61x)	1.56	1.70	15 x 10	2.08	2450	2754	550	480	600	515
160-23-4099	1000 (61x)	1.71	1.85	18 x **(A)	2.23	3027	3533	640	565	680	585
▲ 162-23-4099*	1000 (61x)	1.71	1.85	18 x **(A)	2.23	3024	3535	640	565	680	585

* These items include filled strand

** Special Conductor Size, (A) Wire O.D. =0.1066"

(1) Individual wire size and count may vary. The resulting combination meets the 1/3 or full neutral, size requirement.

Visit Okonite's web site www.okonite.com for the most up to date dimensions.

▲ Authorized Stock Item - Available from Customer Service centers.

Ampacities

(2) Full neutral, single phase ampacities are based on 90°C or 105°C conductor temperature, 20°C ambient temperature, 100% load factor, and earth thermal resistivity of RHO 90.

One third neutral ampacities are based on ICEA P-53-426 triplexed or triangular configuration for the same conditions stated above.

Okoguard URO-J

25kV Underground Primary Distribution Cable-Jacketed

Red Identification Stripes

Aluminum Conductor/105°C Rating

133% Insulation Levels

Product Data Section 2: Sheet 39

Okoguard Insulation: 320 mils 133% Insulation Level

Catalog Number	Conductor Size AWG/komil	Number of Strands	Nominal Dia. over Insulation (in.)	Nominal Dia. over Insulation Screen (in.)	Copper Neutral No. x AWG (1)	Nominal O.D. (in.)	Approx. Net Weight lbs./1000'	Approx. Ship Weight lbs./1000'	90° Ampacity Direct Burial (2)	90° Ampacity Duct (2)	105° Ampacity Direct Burial (2)	105° Ampacity Duct (2)
FULL NEUTRAL												
161-23-5066	1 (19x)	1.02	1.12	13 x 14	1.36	931	1047	185	135	205	150	
161-23-5072	1/0 (19x)	1.06	1.16	16 x 14	1.40	1022	1138	210	150	235	170	
161-23-5075	2/0 (19x)	1.10	1.20	13 x 12	1.47	1175	1353	240	175	270	200	
161-23-5078	3/0 (19x)	1.15	1.25	16 x 12	1.52	1308	2503	270	200	305	225	
161-23-5081	4/0 (19x)	1.21	1.31	13 x 10	1.69	1600	1819	305	225	345	260	
161-23-5084	250 (37x)	1.27	1.37	16 x 10	1.74	1782	2032	335	250	380	285	
161-23-5090	350 (37x)	1.37	1.47	20 x 10	1.85	2099	2349	405	300	450	345	
1/3 NEUTRAL												
160-23-5066	1 (19x)	1.02	1.12	6 x 14	1.36	850	966	175	155	190	150	
160-23-5072	1/0 (19x)	1.06	1.16	6 x 14	1.40	906	1022	200	175	215	175	
160-23-5075	2/0 (19x)	1.10	1.20	7 x 14	1.44	983	1099	230	200	245	200	
160-23-5078	3/0 (19x)	1.15	1.25	9 x 14	1.49	1083	1261	260	230	280	230	
160-23-5081	4/0 (19x)	1.21	1.31	11 x 14	1.55	1200	1378	290	245	315	260	
160-23-5084	250 (37x)	1.27	1.37	13 x 14	1.60	1312	1490	315	265	340	285	
160-23-5090	350 (37x)	1.37	1.47	18 x 14	1.77	1631	1881	375	325	410	350	
160-23-5093	500 (37x)	1.50	1.60	16 x 12	1.93	2025	2275	450	390	495	415	
160-23-5096	750 (61x)	1.69	1.83	15 x 10	2.20	2722	3122	550	480	600	515	
160-23-5099	1000 (61x)	1.84	1.98	18 x ** (A)	2.35	3265	3771	640	565	680	585	

(1) Individual wire size and count may vary. The resulting combination meets the 1/3 or full neutral, size requirement.

** Special Conductor Size, (A) Wire O.D. = 0.1066"

Visit Okonite's web site www.okonite.com for the most up to date dimensions.

Ampacities

(2) Full neutral, single phase ampacities are based on 90°C or 105°C conductor temperature, 20°C ambient temperature, 100% load factor, and earth thermal resistivity of RHO 90.

One third neutral ampacities are based on ICEA P-53-426 triplexed or triangular configuration for the same conditions stated above.



Okoguard® URO-J

35kV Underground Primary Distribution Cable-Jacketed Red Identification Stripes

Aluminum Conductor/105°C Rating
100% and 133% Insulation Levels



- A Conductor-Stranded Aluminum
- B Strand Screen- Extruded Semiconducting EPR
- C Insulation-Okoguard EPR
- D Insulation Screen- Extruded Semiconducting EPR
- E Concentric Conductor-Bare Copper Wires
- F Encapsulating Jacket-Okolene with three extruded red ID stripes and NESC lightning bolt

Insulation

Okoguard is Okonite's registered trade name for its exclusive ethylene-propylene rubber (EPR) based, thermosetting compound, whose optimum balance of electrical and physical properties is unequalled in other solid dielectrics. Okoguard insulation, with the distinctive red color and a totally integrated EPR system, provides the optimum balance of electrical and physical properties for long, problem free service.

The triple tandem extrusion of the screens with the insulation provides optimum electrical characteristics.

An insulation screen of ethylene-propylene rubber is extruded over the insulation. The bare copper concentric wires are uniformly spaced around the insulation screen. The overall polyethylene jacket provides protection against mechanical damage and corrosion.

Product identification is provided through the use of three red stripes placed 120° apart in the black jacket, with an NESC lightning bolt.

Applications

Okoguard URO-J cables provide maximum circuit longevity in underground residential distribution systems. They can be buried directly or installed in underground ducts or conduits.

Specifications

Central Conductor: Aluminum per ASTM B-609, Class B stranded per B-231.

Conductor Screen: Extruded semiconducting ethylene-propylene rubber meets or exceeds the requirements of ICEA S-94-649 and AEIC CS8.

Insulation: Extruded Okoguard meets or exceeds the requirements of ICEA S-94-649 and AEIC CS8.

Insulation Screen: Extruded semiconducting ethylene-propylene rubber meets or exceeds the requirements of ICEA S-94-649 and AEIC CS8.

Concentric Conductor: Bare copper wires.

Jacket: Black Okolene with red extruded stripes meets or exceeds the requirements of ICEA S-94-649 for polyethylene jackets.

Product Features

- Triple tandem extruded, all EPR system.
 - Okoguard cables meet or exceed ICEA and RUS 7CFR 1728.204 standards.
 - 105°C continuous operating temperature
 - 140°C emergency rating
 - 250°C short circuit rating
 - Excellent corona resistance.
 - Low dielectric constant and power factor.
 - Screens are clean stripping.
 - Exceptional resistance to "treeing".
 - Moisture resistant.
 - Overall jacket provides extended life.
 - Excellent resistance to most chemicals.
 - Can be UL listed to MV90 for use in accordance with Article 328 of the NEC on special orders.
 - Can be CSA listed to C68.5 on special orders
 - Design Options:
 - Additional conductor sizes
 - Filled strand
 - Copper central conductor
 - Copper flat strap concentric neutral
 - Product identification via colored jackets
 - Semiconducting jackets
 - Improved Temperature Rating.
- Okoguard insulation system has been tested and qualified for operation at 105°C continuous and 140°C emergency operating temperature. Appropriate jacket should be selected when cable is to be operated at these higher temperatures.
- Minimum installation temperature of -40°C.

Okoguard URO-J

35kV Underground Primary Distribution Cable-Jacketed

Red Identification Stripes

Aluminum Conductor/105°C Rating

100% Insulation Level

Product Data Section 2: Sheet 40

Okoguard Insulation: 345 mils 100% Insulation Level

Catalog Number	Conductor Size AWG/kcmil	Nominal Dia. Over Insulation	Nominal Dia. Over Insulation Screen	Copper Neutral Number x AWG (1)	Nominal O.D. (In.)	Approx. Net Weight lbs./1000'	Approx. Ship Weight lbs./1000'	90°C Ampacity (2) Direct Burial	90°C Ampacity (2) Duct	105°C Ampacity (2) Direct Burial	105°C Ampacity (2) Duct
FULL NEUTRAL											
▲ 161-23-6072	1/0 (19x)	1.10	1.20	16 x 14	1.44	1061	1179	210	150	235	170
▲ 163-23-6072*	1/0 (19x)	1.10	1.20	16 x 14	1.44	1063	1181	210	150	235	170
161-23-6075	2/0 (19x)	1.15	1.25	13 x 12	1.52	1238	1416	240	175	270	200
161-23-6078	3/0 (19x)	1.20	1.30	16 x 12	1.57	1374	1552	270	200	305	225
161-23-6081	4/0 (19x)	1.26	1.36	13 x 10	1.74	1671	1921	305	225	345	260
161-23-6084	250 (37x)	1.32	1.42	16 x 10	1.79	1856	2106	335	250	380	285
161-23-6090	350 (37x)	1.42	1.52	20 x 10	1.90	2177	2525	405	300	450	345

1/3 NEUTRAL

160-23-6072	1/0 (19x)	1.11	1.21	6 x 14	1.45	966	1082	200	175	215	175
160-23-6075	2/0 (19x)	1.15	1.25	7 x 14	1.49	1045	1223	230	200	245	200
160-23-6078	3/0 (19x)	1.20	1.30	9 x 14	1.54	1148	1326	260	230	280	230
160-23-6081	4/0 (19x)	1.26	1.36	11 x 14	1.60	1267	1445	290	245	315	260
160-23-6084	250 (37x)	1.32	1.42	13 x 14	1.72	1451	1701	315	265	340	285
160-23-6090	350 (37x)	1.42	1.52	18 x 14	1.82	1707	1957	375	325	410	350
160-23-6093	500 (37x)	1.55	1.68	16 x 12	2.02	2167	2515	450	390	495	415
160-23-6096	750 (61x)	1.74	1.88	15 x 10	2.25	2817	3323	550	480	600	515
160-23-6099	1000 (61x)	1.89	2.03	18 x **(A)	2.40	3366	3872	640	565	680	585

* These items include filled strand.

** Special Conductor Size, (A) wire OD=0.1066"

Visit Okonite's web site www.okonite.com for the most up to date dimensions.

▲ **Authorized Stock Item** - Available from Customer Service centers.

(1) Individual wire size and count may vary. The resulting combination meets the 1/3 or full neutral, size requirement.

Ampacities

(2) Full neutral, single phase ampacities are based on 90°C or 105°C conductor temperature, 20°C ambient temperature, 100% load factor, and earth thermal resistivity of RHO 90.

One third neutral ampacities are based on ICEA P-53-426 triplexed or triangular configuration for the same conditions stated above.

Okoguard URO-J

35kV Underground Primary Distribution Cable-Jacketed

Red Identification Stripes

Aluminum Conductor/105°C Rating

133% Insulation Level

Product Data Section 2: Sheet 40

Okoguard Insulation: 420 mils 133% Insulation Level

Catalog Number	Conductor Size AWG/kcmil	Number of Strands	Nominal Dia. Over Insulation	Nominal Dia. Over Insulation Screen	Copper Neutral Number x AWG (1)	Nominal O.D. (In.)	Approx. Net Weight lbs./1000'	Approx. Ship Weight lbs./1000'	90°C Ampacity (2) Direct Burial	90°C Ampacity Duct (2)	105°C Ampacity (2) Direct Burial	105°C Ampacity Duct (2)
FULL NEUTRAL												
161-23-7072	1/0 (19x)	1.26	1.36	16 x 14	1.60	1285	1463	205	150	230	175	
161-23-7075	2/0 (19x)	1.31	1.41	13 x 12	1.74	1520	1770	235	170	265	200	
161-23-7078	3/0 (19x)	1.36	1.46	16 x 12	1.79	1666	1916	265	200	300	230	
161-23-7081	4/0 (19x)	1.42	1.52	13 x 10	1.89	1909	2159	305	225	340	260	
161-23-7084	250 (37x)	1.47	1.57	16 x 10	1.95	2102	2352	335	245	375	290	
161-23-7090	350 (37x)	1.58	1.71	20 x 10	2.09	2498	2846	400	295	445	350	
1/3 NEUTRAL												
160-23-7072	1/0 (19x)	1.26	1.36	6 x 14	1.60	1169	1347	200	175	210	175	
160-23-7075	2/0 (19x)	1.31	1.41	8 x 14	1.71	1323	1573	225	200	240	205	
160-23-7078	3/0 (19x)	1.36	1.46	9 x 14	1.76	1434	1684	255	230	275	235	
160-23-7081	4/0 (19x)	1.42	1.52	11 x 14	1.82	1564	1814	280	245	310	265	
160-23-7084	250 (37x)	1.47	1.57	13 x 14	1.87	1689	1939	315	265	340	290	
160-23-7090	350 (37x)	1.58	1.71	18 x 14	2.01	2019	2367	375	325	405	350	
160-23-7093	500 (37x)	1.70	1.84	16 x 12	2.18	2446	2846	450	390	490	420	
160-23-7096	750 (61x)	1.90	2.03	15 x 10	2.41	3126	3632	550	480	595	515	
160-23-7099	1000 (61x)	2.05	2.18	18 x **(A)	2.56	3696	4202	640	565	680	600	

** Special Conductor Size, (A) wire OD-0.1066"

Visit Okonite's web site www.okonite.com for the most up to date dimensions.

(1) Individual wire size and count may vary. The resulting combination meets the 1/3 or full neutral, size requirement.

Ampacities

(2) Full neutral, single phase ampacities are based on 90°C or 105°C conductor temperature, 20°C ambient temperature, 100% load factor, and earth thermal resistivity of RHO 90.
One third neutral ampacities are based on ICEA P-53-426 triplexed or triangular configuration for the same conditions stated above.



Okoguard-Okolon[®] TS-CPE Type RHH or RHW-2 or USE-2, VW-1, FT-4, CSA RW-90

600V Power and Control

Copper Conductor/90°C Wet or Dry

For Cable Tray Use-Sunlight Resistant-For Direct Burial



A Uncoated, Copper Conductor
B Composite Okoguard/Okolon
TS-CPE Insulation

Composite Insulation

Okoguard-Okolon TS-CPE is Okonite's trade name for its composite insulation system consisting of a layer of EPR and covered with a chlorinated polyethylene (CPE) thermoset compound.

The advantages of Okoguard EPR, with a proven track record of over 40 years as a medium voltage insulation, are now offered in low voltage cables. Okolon TS-CPE is Okonite's trade name for its chlorinated polyethylene (CPE) thermoset compound.

Applications

Okoguard-Okolon TS-CPE 600 Volt Power and Control Cables are recommended for use in all low voltage circuits where continuity of service is the prime consideration. These cables may be installed in wet or dry locations, indoors or outdoors, in raceways, underground ducts, directly buried in the earth, or lashed to a messenger for aerial installation. These cables may also be installed in cable tray (size 1/0 AWG and larger per NEC 392.2).

Specifications

Conductor: Uncoated soft copper per ASTM B-3. Solid per ASTM B-3. Sizes smaller than #8 are compact stranded per ASTM B-8. Sizes #8 and larger are compact stranded per ASTM B-496.

Insulation: Meets or exceeds all requirements of ICEA S-95-658, NEMA WC-70 and UL Standards 44 and 854.

Listed by Underwriters Laboratories, Inc. as Type RHH or RHW-2 or USE-2, VW-1. Sizes 1/0 AWG and larger are also marked sunlight resistant, for use in cable tray.

Listed by CSA as RW-90, -40C, FT1 (1/0 and larger: FT4), sunlight resistant.

Product Features

- Sizes 1/0 AWG and larger pass the Vertical Tray Flame Test requirements of UL 1581 for use in cable tray.
- Passes the IEEE 383-1974 Vertical Tray Flame Test. (sizes #6 AWG and larger)
- Passes the IEEE 1202 Vertical Tray Flame Test. (sizes 1/0 AWG & larger)
- Extreme heat resistance; 90°C continuous rating, wet or dry 130°C emergency overload rating 250°C short circuit rating
- Exceptional resistance to deformation at high temperature.
- Stable electrical properties.
- Low SIC and power factor.
- Low moisture absorption.
- Mechanically rugged.
- Resistant to weather, most oils, acids and alkalis.
- More flexible, easier to install and terminate than XLPE insulation.
- UL and CSA Listed.

Conductor (AWG/kcmil)	Composite Insulation Thickness (mils)	
	Okoguard	Okolon TS-CPE
14-9	30	15
8	45	15
6-2	45	30
1-4/0	55	45
250-500	65	65
750-1000	80	65

Okoguard-Okolon TS-CPE Type RHH or RHW-2 or USE-2, VW-1, FT-4, CSA RW-90

600V Power and Control

Copper Conductor/90°C Wet or Dry

For Cable Tray Use - Sunlight Resistant - For Direct Burial

Product Data Section 3: Sheet 1



Catalog Number	Conductor Size AWG kcmil		Number of Strands	Composite Insulation Thickness - mils		Approx. O.D. - Inches	Approx. O.D. -mm		Approx. Net Weight lbs./1000'		Approx. Ship Weight lbs./1000'		90°C Wet (1)	75°C Wet (1)	ICEA Ampacity (2)
112-24-2061	14	1	45	1.14	0.16	4.06	23	28	15	15	24				
▲ 112-24-2071	14	7	45	1.14	0.17	4.57	25	30	15	15	24				
112-24-2091	12	1	45	1.14	0.18	4.57	32	37	20	20	30				
▲ 112-24-2101	12	7	45	1.14	0.19	4.83	34	39	20	20	30				
112-24-2121	10	1	45	1.14	0.20	5.08	46	51	30	30	42				
▲ 112-24-2131	10	7	45	1.14	0.21	5.33	49	54	30	30	42				
112-24-2171	9	19	45	1.14	0.23	5.84	58	63	30	30	48				
▲ 112-24-2191	8	7	60	1.52	0.27	6.86	75	82	55	50	55				
▲ 112-24-2221	6	7	75	1.91	0.33	8.38	119	130	75	65	75				
▲ 112-24-2251	4	7	75	1.91	0.38	9.75	173	184	95	85	97				
▲ 112-24-2311	2	7	75	1.91	0.43	11.00	257	280	130	115	130				
112-24-2331	1	19	100	2.54	0.52	13.16	340	372	150	130	156				
▲ 112-24-2351	1/0	19	100	2.54	0.56	14.10	414	446	170	150	179				
▲ 112-24-2371	2/0	19	100	2.54	0.60	15.14	507	539	195	175	204				
112-24-2391	3/0	19	100	2.54	0.64	16.33	622	654	225	200	242				
▲ 112-24-2411	4/0	19	100	2.54	0.70	17.68	766	805	260	230	278				
▲ 112-24-2431	250	37	130	3.30	0.80	20.32	938	993	290	255	317				
▲ 112-24-2471	350	37	130	3.30	0.89	22.61	1265	1320	350	310	384				
▲ 112-24-2531	500	37	130	3.30	1.01	25.65	1750	1827	430	380	477				
▲ 112-24-2591	750	61	145	3.68	1.21	30.73	2590	2690	535	475	598				
▲ 112-24-2651	1000	61	145	3.68	1.36	34.54	3391	3568	615	545	689				

Visit Okonite's web site, www.okonite.com, for the most up to date dimensions.

▲ **Authorized stock item.** Available from our Customer Service Centers.

(1) **Ampacities** are based on Table 310.16 of the National Electrical Code for these 90°C rated conductors at an ambient temperature of 30°C. The 75°C wet column is provided for additional information.

The ampacities shown apply to open runs of cable, installation in any approved raceway, direct burial in the earth, or as aerial cable on a messenger. Derating for more than three current carrying conductors within a raceway is in accordance with NEC Section 310.15.B.2.

(2) Based on three (3) conductors in a single enclosed or exposed conduit. Capacities based on 40°C air ambient using ICEA methods. For 30°C ambient multiply values by 1.10; for 50°C multiply by .90. For other ambients or installation conditions refer to Engineering Data Book EHB.

For ampacities in cable tray, see NEC Section 392.11.B.

To order a color other than black, change the last digit of the catalog number as follows:			
White	2	Orange	5
Red	3	Blue	6
Green	4	Yellow	7
Example: To order #14/Sol - Red, the catalog number would be 112-24-2063.			



Okoguard-Okolon® TS-CPE Type RHH or RHW-2, VW-1, FT-4

2kV Power Cable

Copper Conductors/90°C Wet or Dry
For Cable Tray Use - Sunlight Resistant



A Uncoated Copper Conductor
B Composite Okoguard—Okolon
TS-CPE Insulation

Composite Insulation

Okoguard-Okolon® TS-CPE is Okonite's trade name for its composite insulation system consisting of a layer of EPR and covered with a chlorinated polyethylene (CPE) thermoset compound. The combination of the two materials provides a dielectric which has excellent resistance to heat, mechanical abuse, flame, weathering, most oils, acids and alkalies.

The advantages of Okoguard EPR, with a proven track record of over 40 years as a medium voltage insulation, are now offered in low voltage cables. Okolon TS-CPE is Okonite's trade name for its chlorinated polyethylene (CPE) thermoset compound.

Applications

Okoguard-Okolon TS-CPE 2000 volt power cables are recommended for use in all low voltage circuits where continuity of service is the prime consideration. They can be installed in wet or dry locations, indoors or outdoors in conduit, underground ducts, approved raceways. These cables may also be installed in cable tray (size 1/0 AWG kcmil and larger per NEC 392.3).

Specifications

Conductors: Uncoated soft copper per ASTM B-3. Solid per ASTM B-3. Sizes smaller than #8 are compress stranded per ASTM B-8. Sizes #8 and larger are compact stranded per ASTM B-496.

Composite Insulation: Meets or exceeds all requirements of ICEA S-95-658, NEMA WC-70 and UL Standard 44.

Listed by Underwriters Laboratories, Inc. as Type RHH or RHW-2, VW-1. Sizes 1/0 AWG and larger are also marked sunlight resistant, for use in cable tray. All sizes meet FT-1. Sizes 1/0 and larger meet FT-4.

Product Features

- Sizes 1/0 AWG and larger pass the Vertical Tray Flame Test requirements of UL 1581 for use in cable tray.
- Passes the IEEE 383-1974 Vertical Tray Flame Test (size #8 AWG and larger).
- Passes the IEEE 1202 Vertical Tray Flame Test (sizes 1/0 AWG and larger).
- Extreme heat resistance
90°C continuous rating, wet or dry
130°C emergency overload rating
250°C short circuit rating
- Exceptional resistance to deformation at high temperature.
- Stable electrical properties.
- Low SIC and power factor.
- Low moisture absorption.
- Mechanically rugged.
- Resistant to weather, most oils, acids and alkalies.
- Smaller diameter than RHW jacketed cables.
- More flexible, easier to install, terminate or splice than XLPE insulation.
- UL Listed.
- OSHA acceptable.
- UL E1138.
- FT-1 all sizes.
- FT-4 - 1/0 and larger.

Composite Insulation Thickness (mils)		
Conductor (AWG/kcmil)	Okoguard	Okolon TS-CPE
14-10	45	15
9	55	15
8-2	55	30
1-4/0	65	45
250-500	75	65
750-1000	90	65

Okoguard-Okolon TS-CPE Type RHH or RHW-2, VW-1, FT-4 2kV Power Cable



Product Data Section 3: Sheet 10

Copper Conductor/90°C Wet or Dry
For Cable Tray Use - Sunlight Resistant

Catalog Number	Conductor Size AWG or kcmil		Number of Strands	Composite Insulation Thickness - mils	Composite Insulation Thickness - mm	Approx. O.D. - Inches	Approx. O.D. - mm	Approx. Net Weight lbs./1000'	Approx. Ship Weight lbs./1000'	90°C Wet (1) NEC Ampacity	75°C Wet (1) NEC Ampacity	ICEA Ampacity (2)
113-24-2061	14	1	60	1.52	0.19	4.83	28	33	15	15	24	
▲ 113-24-2071	14	7	60	1.52	0.20	5.08	30	35	15	15	24	
113-24-2091	12	1	60	1.52	0.21	5.33	38	43	20	20	30	
▲ 113-24-2101	12	7	60	1.52	0.22	5.59	40	45	20	20	30	
113-24-2121	10	1	60	1.52	0.23	5.84	52	57	30	30	42	
▲ 113-24-2131	10	7	60	1.52	0.24	6.10	55	60	30	30	42	
113-24-2171	9	19	70	1.79	0.28	7.11	70	75	30	30	48	
▲ 113-24-2191	8	7	85	2.16	0.32	8.13	90	101	55	50	55	
▲ 113-24-2221	6	7	85	2.16	0.35	8.89	126	137	75	65	75	
▲ 113-24-2251	4	7	85	2.16	0.40	10.26	180	191	95	85	97	
▲ 113-24-2311	2	7	85	2.16	0.45	11.43	265	278	130	115	130	
113-24-2331	1	19	110	2.79	0.54	13.72	348	367	150	130	156	
▲ 113-24-2351	1/0	19	110	2.79	0.57	14.48	424	442	170	150	179	
▲ 113-24-2371	2/0	19	110	2.79	0.61	15.49	517	537	195	175	204	
113-24-2391	3/0	19	110	2.79	0.66	16.76	633	657	225	200	242	
▲ 113-24-2411	4/0	19	110	2.79	0.71	18.03	777	813	260	230	278	
▲ 113-24-2431	250	37	140	3.56	0.83	21.08	957	1004	290	255	317	
▲ 113-24-2471	350	37	140	3.56	0.92	23.37	1286	1355	350	310	384	
▲ 113-24-2531	500	37	140	3.56	1.04	26.42	1773	1915	430	380	477	
▲ 113-24-2591	750	61	155	3.94	1.24	31.50	2618	2805	535	475	598	
113-24-2651	1000	61	155	3.94	1.38	35.05	3423	3674	615	545	689	

Visit Okonite's web site, www.okonite.com, for the most up to date dimensions.

▲ **Authorized stock item.** Available from our Customer Service Centers.

To order a color other than black, change the last digit of the catalog number as follows:			
White	2	Orange	5
Red	3	Blue	6
Green	4	Yellow	7
Example: To order #14 - Red, the catalog number would be 113-24-2073.			

Ampacities

(1) Ampacities are based on Table 310.15(B)(16) of the National Electrical Code for these 90°C rated conductors at an ambient temperature of 30°C. The 75°C wet column is provided for additional information.

The ampacities shown apply to open runs of cable, installation in any approved raceway, direct burial in the earth, or as aerial cable on a messenger. Derating for more than three current carrying conductors within a raceway is in accordance with NEC 310.15(B)(3).

(2) Based on three (3) conductors in a single enclosed or exposed conduit. Capacities based on 40°C air ambient using ICEA method. For 30°C ambient multiply values by 110; for 50°C multiply by 90. For other ambients or installation conditions refer to Okonite's Engineering Data Book EHB.

For ampacities in cable tray see NEC Section 392.80.



C-L-X[®] Type MC-HL (XHHW-2) 600V Power MC-HL Cable—Aluminum Sheath 600/1000V Marine Cable

Multiple Copper Conductors/90°C Wet or Dry Rating
For Cable Tray Use - Sunlight Resistant - For Direct Burial

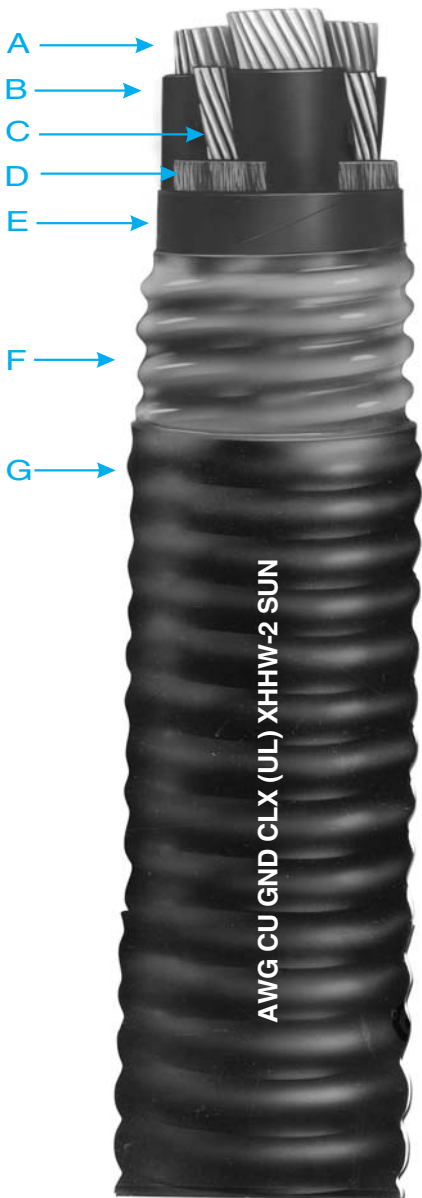

- A Bare, Stranded Copper Conductors
- B X-Olene Insulation —Color Coded for Identification
- C Bare, Stranded Copper Grounding Conductor(s)
- D Non-Hygroscopic Fillers, as necessary
- E Binder Tape
- F Impervious, Continuous, Welded Corrugated, Aluminum C-L-X Sheath
- G Black Okoseal Jacket

Insulation

X-Olene[®] is Okonite's trade name for its chemically cross-linked polyethylene, with high dielectric strength.

Color Coding

Conductors 6 AWG and smaller are color coded using base colors and tracers in accordance with the Conductor Identification Table on the back of this Data Sheet. Sizes 4 AWG and larger are printed number/color coded.

Assembly and Coverings

The individual conductors are cabled together with non-hygroscopic fillers and a binder tape overall. The C-L-X sheath exceeds the grounding conductor requirements of Table 250.122 of the NEC and UL 1569. A bare stranded copper grounding conductor(s), located in the outer interstices, is provided for grounding. The impervious, continuous, welded, corrugated aluminum C-L-X sheath provides complete protection against moisture, liquids and gases and has excellent mechanical strength. For direct burial in the ground, embedment in concrete, or for areas subjected to corrosive atmospheres, the C-L-X sheath is protected with a low temperature black Okoseal[®] (PVC) jacket.

Applications

C-L-X Type MC-HL cables with the impervious, continuous, corrugated aluminum sheath are recommended as an economical alternate to a wire in conduit system.

They are authorized for use on services, feeders and branch circuits for power, lighting, control and signaling circuits in accordance with Article 330 and 725 of the NEC.

C-L-X Type MC-HL cables may be installed indoors or outdoors, in wet or dry locations, as open runs of cable secured to supports spaced not more than six feet apart, in cable tray, as aerial cable on a messenger, in any approved raceway, direct burial, or encased in concrete. C-L-X type MC-HL cables are also approved for Classes I, II and III, Division 1 and 2 and Class I, Zones 1 and 2 hazardous locations per NEC Articles 501, 502, 503 and 505; in Zone 1, Zone 2, Class II Div 2, Class III Div 1 and Class III Div 2 per CEC.

Specifications

Conductors: Uncoated soft copper per ASTM B-3. Sizes smaller than #8 are compact stranded per ASTM B-8. Sizes #8 and larger are compact stranded per ASTM B-496.

Insulation: X-Olene per ICEA S-95-658/ NEMA WC70 and UL 44, Listed UL Type XHHW-2. Meets MIL-DTL-1377H, section 4.8.4.1.2 cold bend at -66°C and ASTM D746-04 brittle point at -76°C.

Conductor Identification: Control Sizes, #9 AWG and smaller, color coded insulation. Power Sizes, #8 AWG and larger, black with printed words of number and color.

Grounding Conductor(s): One or three bare soft copper per ASTM B-3. Stranded in accordance with UL 1581. Meets or exceeds requirements of NEC Table 250.122.

Sheath: Close fitting, impervious, continuous, welded, corrugated aluminum C-L-X per UL 1569. Exceeds grounding conductor requirements of NEC Table 250.122.

Jacket: Black Okoseal (PVC) per UL1569. Meets ASTM D746-04 brittle point at -40°C.

Product Features

- UL Listed as Type MC-HL cable per E38916
- UL Listed for cable tray use, direct burial and sunlight resistant.
- UL 1309 (CWCMC) listed & UL classified in accord with IEEE 1580 as Marine Shipboard Cable rated 600/1000 volts.
- CSA listed as RA90, FT4, HL and LTGG (-40°C).
- Passes the IEEE 383-1974 and IEEE 1202 vertical tray flame tests.
- Passes the 210,000 BTU ICEA T-29-520 Vertical Tray Flame Test.
- Complete pre-packaged, factory-tested wiring system; color coded.
- C-L-X cables are quality control inspected to meet or exceed applicable UL standards.
- 90°C continuous operating temperature in all types of installations.
- 130°C emergency rating.
- 250°C short circuit rating.
- Good EMI shielding characteristics.
- Impervious, continuous metallic sheath excludes moisture, gases and liquids.
- Lower installed system cost than conduit or EMT systems.
- Provides excellent grounding safety.
- Excellent compression and impact resistance.
- Continuous long lengths.
- Installation temperature of -40°C or °F.
- Complies with NEC Articles 501, 502 and 503 for hazardous locations.
- American Bureau of Shipping Type approved as CWCMC Type MC-HL.
- Three symmetrical grounding conductors for PWM/VFD and other modern AC drive/motor applications.
- CSA Type RA90-HL complies with CEC Zone 1, Zone 2, Class II Div 2, Class III Div 1 and Class III Div 2 Hazardous Locations.

C-L-X Type MC-HL (XHHW-2)

600V Power MC-HL Cable—Aluminum Sheath

600/1000V Marine Cable

Multiple Copper Conductors/90°C Wet or Dry Rating

For Cable Tray Use - Sunlight Resistant - For Direct Burial



Product Data Section 4: Sheet 1

Catalog Number	Conductor Size AWG	Number of Conductors	Insulation Thickness - mils	Grounding Conductor(s) AWG	Core O.D. - Inches	Core O.D. - mm	C-L-X O.D. - Inches	C-L-X O.D. - mm	Jacket Thickness - mils	Jacket Thickness - mm	Approx. O.D. - mm	Approx. O.D. - Inches	Cross-Sectional Area (sq. in.) †	Approx. Net Weight lbs./1000'	Approx. Ship Weight lbs./1000'	90°C Wet or Dry NEC Ampacity	75°C Wet NEC Ampacity
▲ 546-31-3403	14(7X)	3		3 #18	0.33	8.4	0.53	13.5	50	1.27	0.64	16.3	0.32	160	190	15	15
▲ 546-31-3404	(2.08mm ²)	4	30	3 #18	0.37	9.3	0.58	14.7	50	1.27	0.69	17.5	0.37	222	261	15	15
▲ 546-31-3453	12(7X)	3		3 #16	0.37	9.3	0.58	14.7	50	1.27	0.69	17.5	0.37	239	278	20	20
▲ 546-31-3454	(3.31mm ²)	4	30	3 #16	0.45	11.4	0.67	16.9	50	1.27	0.78	19.7	0.47	286	320	20	20
▲ 546-31-3503	10(7X)	3		3 #14	0.41	10.4	0.62	15.8	50	1.27	0.73	18.6	0.42	300	380	30	30
▲ 546-31-3504	(5.26mm ²)	4	30	3 #14	0.45	11.4	0.67	16.9	50	1.27	0.78	19.7	0.47	348	428	30	28
▲ 571-31-3190	8(7X)	3		3#14	0.50	12.7	0.71	18.0	50	1.27	0.81	20.6	0.52	385	420	55	50
▲ 571-31-3263	(8.36mm ²)	4	45	10	0.58	14.7	0.80	20.3	50	1.27	0.90	22.9	0.64	465	495	44	40
▲ 571-31-3191	6(7X)	3		3#12	0.58	14.7	0.80	20.3	50	1.27	0.90	22.9	0.64	525	595	75	65
▲ 571-31-3270	(13.3mm ²)	4	45	8	0.66	16.8	0.89	22.5	50	1.27	0.99	25.1	0.77	630	685	60	52
▲ 571-31-3200	4(7X)	3		3#12	0.68	17.3	0.89	22.5	50	1.27	0.99	25.1	0.77	704	820	95	85
▲ 571-31-3272	(21.2mm ²)	4	45	8	0.77	19.6	0.97	24.7	50	1.27	1.08	27.5	0.92	845	930	76	68
▲ 571-31-3204	2(7X)	3		3#10	0.80	20.3	1.02	25.9	50	1.27	1.13	28.7	1.00	995	1050	130	115
▲ 571-31-3276	(33.6mm ²)	4	45	6	0.92	23.4	1.15	29.2	50	1.27	1.26	32.0	1.25	1245	1370	104	92
571-31-3208	1(19X)	3		3#10	0.92	23.4	1.15	29.2	50	1.27	1.26	32.0	1.25	1100	1181	150	130
571-31-3280	(42.4mm ²)	4	55	6	1.04	26.4	1.29	32.8	50	1.27	1.40	35.6	1.54	1500	1620	120	104
▲ 571-31-3213	1/0(19X)	3		3#10	1.00	25.5	1.24	31.4	50	1.27	1.34	34.0	1.41	1470	1560	170	150
571-31-3285	(53.5mm ²)	4	55	6	1.12	28.4	1.37	34.9	50	1.27	1.48	37.6	1.72	1830	1975	136	120
▲ 571-31-3216	2/0(19X)	3		3#10	1.09	27.7	1.34	34.0	50	1.27	1.44	36.6	1.63	1770	2020	195	175
▲ 571-31-3289	(67.4mm ²)	4	55	6	1.23	31.2	1.51	38.5	60	1.52	1.64	41.7	2.11	2310	2545	156	140
▲ 571-31-3224	4/0(19X)	3		3#8	1.33	33.8	1.60	40.6	60	1.52	1.73	44.0	—	2675	2880	260	230
▲ 571-31-3296	(107mm ²)	4	55	4	1.49	37.8	1.78	45.2	60	1.52	1.91	48.6	—	3430	3710	208	184
▲ 571-31-3228	250(37X)	3		3#8	1.48	37.6	1.74	44.2	60	1.52	1.87	47.5	—	3140	3420	290	255
571-31-3300	(127mm ²)	4	65	4	1.64	41.6	1.96	49.7	60	1.52	2.09	53.0	—	4070	4330	232	185
▲ 571-31-3236	350(37X)	3		3#7	1.66	42.2	1.96	49.7	60	1.52	2.09	53.0	—	4210	4300	350	310
▲ 571-31-3308	(177mm ²)	4	65	3	1.89	48.0	2.19	55.6	75	1.90	2.35	59.8	—	5440	6000	280	248
▲ 571-31-3244	500(37X)	3		3#6	1.94	59.3	2.28	57.9	75	1.90	2.44	62.0	—	5930	6420	430	380
▲ 571-31-3316	(253mm ²)	4	65	2	2.14	54.4	2.49	63.2	75	1.90	2.65	67.4	—	7570	8120	344	304
▲ 571-31-3248	750(61X)	3		3#5	2.37	60.2	2.75	69.8	75	1.90	2.92	74.1	—	8700	9400	535	475
571-31-3320	(380mm ²)	4	80	1	2.61	66.2	3.03	76.9	85	2.16	3.21	81.6	—	11250	12190	428	380
571-31-3252	1000(61X)	3		1/0	2.67	67.7	3.11	79.0	85	2.16	3.30	83.8	—	11410	12430	615	545
571-31-3324	(507mm ²)	4	80	1/0	3.07	78.0	3.63	92.1	85	2.16	3.81	96.8	—	15110	17510	492	436

Visit Okonite's web site, www.okonite.com for the most up to date dimensions.

C-L-X Type MC-HL (XHHW-2)

600V Power MC-HL Cable—Aluminum Sheath

600/1000V Marine Cable

Multiple Copper Conductors/90°C Wet or Dry Rating

For Cable Tray Use - Sunlight Resistant - For Direct Burial



600V Composite Power and Control Cable — Aluminum Sheath

Okoseal Jacket: 50 mils (1.27mm)

Catalog Number	Power Conductors Number x Size	Insulation Thickness - mils	Control Conductors Number X Size	Insulation Thickness - mils	Grounding Conductor (AWG)	C-L-X O.D. - Inches	C-L-X O.D. - mm	Cable O.D. - Inches	Cable O.D. - mm	Cross-Sectional Area (sq. in.) †	Approx. Net Weight lbs./1000'	Approx. Ship Weight lbs./1000'	90°C Wet or Dry NEC Ampacity (1)	75°C Wet NEC Ampacity
▲ 546-31-3984	3X10	30	4X12	30	10	0.75	19.0	0.86	21.9	0.58	425	460	30	30
▲ 571-31-3657	3X8	45	4X12	30	10	0.89	22.6	0.99	25.1	0.77	530	585	55	50
▲ 571-31-3667	3X6	45	4X12	30	8	0.93	23.6	1.03	26.2	0.83	655	720	75	65
▲ 571-31-3677	3X4	45	4X12	30	8	0.97	24.7	1.08	27.5	0.92	810	895	95	85

Visit Okonite's web site, www.okonite.com for the most up to date dimensions.

▲ **Authorized Stock Item** - Available from our Service Centers.

Copper or Bronze C-L-X is available on special order.

Jackets

Optional jacket types available - consult local sales office.

† **Cross-sectional** area for calculation of cable tray fill in accordance with NEC Section 392.22.

(1) Ampacities

Ampacities are based on Table 310.15(B)(16) of the National Electrical Code for XHHW-2 conductors rated 90°C, in a multi-conductor cable, at an ambient temperature of 30°C (86F). The 75°C column is provided for additional information.

The ampacities shown apply to open runs of cable, installation in any approved raceway, direct burial in the earth, or as aerial cable on a messenger. Derating for more than three current carrying conductors within the cable is in accordance with NEC Section 310.15(B)(3)(a).

The ampacities shown also apply to cables installed in cable tray in accordance with NEC Section 392.80.

C-L-X Type MC-HL (XHHW-2)

600V Power MC-HL Cable—Aluminum Sheath

600/1000V Marine Cable

Multiple Copper Conductors/90°C Wet or Dry Rating

For Cable Tray Use - Sunlight Resistant - For Direct Burial



Product Data Section 4: Sheet 1

Conductor Color Coding Sequence

Conductor Number	Base Color
1	Black
2	Red
3	Blue
4	Orange

Special Order: Any or all of the following conductors may be added when specifically requested by the customer to meet his specific application requirements. These conductor codings comply with UL and NEC requirements.

Purpose	Base Color	Tracer Color
Equipment Grounding	Uninsulated Green Green	1 or more continuous yellow stripes
Grounded	White White White White White White White	Black continuous stripe Red continuous stripe Blue continuous stripe Orange continuous stripe Brown continuous stripe Numeric Printing

Sizes 14, 12 & 10 AWG:
Color Coding per ICEA Method 1, E-2 color sequence.

Sizes 8 AWG and larger:
Surface Printing of Numbers and color descriptions per ICEA Method , E-2 color sequence



C-L-X® Type MC (XHHW-2)

**600V Composite Power and Control MC Cable—Aluminum Sheath
600/1000V Marine Cable**

Multiple Copper Conductors/90°C Wet or Dry Rating
For Cable Tray Use - Sunlight Resistant - For Direct Burial

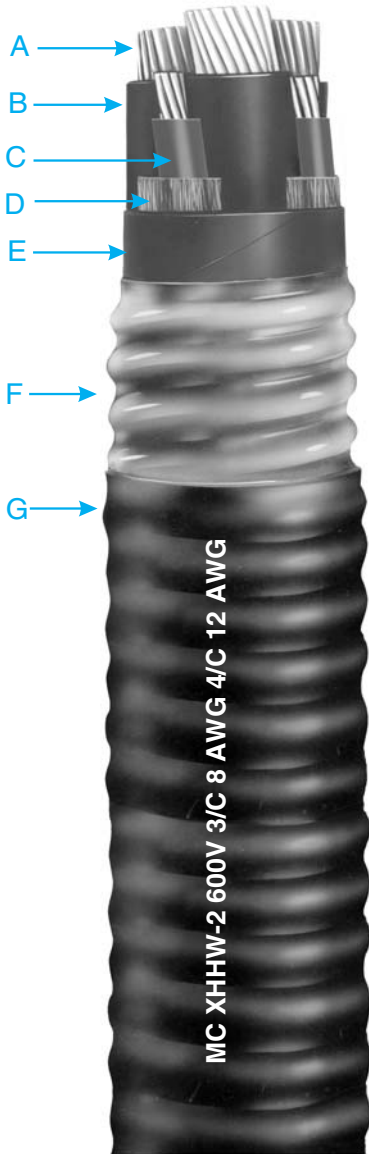

- A** Bare, Stranded Copper Power Conductors
- B** X-Olene Insulation—Color Coded for Identification
- C** Stranded Control Conductors
- D** Non-Hygroscopic Fillers, as necessary
- E** Binder Tape
- F** Impervious, Continuous, Welded Corrugated, Aluminum Sheath
- G** Black Okoseal Jacket

Insulation

X-Olene® is Okonite's trade name for its chemically cross-linked polyethylene, with high dielectric strength.

Color Coding

Conductors 6 AWG and smaller are color coded black, red, blue, orange. Power conductors #4 AWG and larger are printed number/color coded. Control conductors are color coded black, red, blue, yellow. When the control conductors are within one standard AWG size of the power conductors, the control conductors have an additional tracer to facilitate identification.

Assembly and Coverings

The individual conductors are cabled together with non-hygroscopic fillers, bare copper equipment grounding conductor, where indicated, and a binder tape overall. The C-L-X sheath exceeds the grounding conductor requirements of Table 250.122 of the NEC and UL 1569. The impervious, continuous, welded, corrugated aluminum C-L-X sheath provides complete protection against moisture, liquids and gases and has excellent mechanical strength. For direct burial in the ground, embedment in concrete, or for areas subjected to corrosive atmospheres, the C-L-X sheath is protected with a low temperature black Okoseal® (PVC) jacket.

Applications

C-L-X Type MC cables with the impervious, continuous, corrugated aluminum sheath are recommended as an economical alternate to a wire in conduit system.

They are authorized for use on feeders and branch circuits for power, lighting, control and signaling circuits in accordance with Article 330 and 725 of the NEC.

C-L-X Type MC cables may be installed indoors or outdoors, in wet or dry locations, as open runs of cable secured to supports spaced not more than six feet apart, in cable tray, as aerial cable on a messenger, in any approved raceway, direct burial, or encased in concrete. C-L-X type MC cables are also approved for use in Class I & II, Division 2, Class III, Divisions 1 and 2 and Class I, Zone 2 hazardous locations per NEC Articles 501, 502, 503 and 505; in Zone 2, Class II Div 2, Class III Div 1 and Class III Div 2 per CEC.

Specifications

Conductors: Uncoated soft copper per ASTM B-3. Sizes smaller than #8 are compressed stranded per ASTM B-8. Sizes #8 and larger are compact stranded per ASTM B-496.

Insulation: X-Olene per ICEA S-95-658/ NEMA WC-70, ICEA S-73-532/NEMA WC57, and UL 44, Listed UL Type XHHW-2. Meets MIL-DTL-1377H, section 4.8.4.1.2 cold bond at -66°C and ASTM D746-04 brittle point at -76°C.

Conductor Identification: Base color and tracer or printed numbers & color.

Grounding Conductor: Where indicated, bare soft copper per ASTM B-3. Stranded in accordance with UL 1581. Meets or exceeds requirements of NEC Table 250.122.

Sheath: Close fitting, impervious, continuous, welded, corrugated aluminum C-L-X per UL 1569. Exceeds grounding conductor requirements of NEC Table 250-122.

Jacket: Black Okoseal (PVC) per UL 1569. Meets ASTM D746-04 brittle point at -40°C.

Product Features

- UL Listed as Type MC cable per E38916.*
- UL 1309 (CWCMC) listed & UL classified in accord with IEEE 1580 as Marine Shipboard Cable rated 600/1000 volts.
- CSA C22.2 No. 123 listed as RA90, FT4 and LTGG (-40°C).
- UL Listed for cable tray use, direct burial and sunlight resistant.
- Passes the IEEE 383-1974 and IEEE 1202-1991 vertical tray flame tests.
- Passes the 210,000 BTU ICEA T-29-520 Vertical Tray Flame Test.
- Complete pre-packaged, factory-tested wiring system — color coded.
- C-L-X cables are quality control inspected to meet or exceed applicable UL standards.
- 90°C continuous operating temperature in all types of installations.
- 130°C emergency rating.
- 250°C short circuit rating.
- Good EMI shielding characteristics.
- Impervious, continuous metallic sheath excludes moisture, gases and liquids.
- Lower installed system cost than conduit or EMT systems.
- Provides excellent grounding safety.
- Excellent compression and impact resistance.
- Continuous long lengths
- Installation temperature of -40°C or °F.
- American Bureau of Shipping Type approved as CWCMC Type MC.
- CSA Type RA90 complies with CEC Zone 2, Class II Div 2, Class III Div 1 and Class III Div 2 Hazardous Locations.

* Stock items are listed MC-HL

C-L-X Type MC (XHHW-2)

600V Composite Power and Control MC Cable—Aluminum Sheath — 600/1000V Marine Cable

Product Data Section 4: Sheet 2

Multiple Copper Conductors/90°C Wet or Dry Rating



For Cable Tray Use - Sunlight Resistant - For Direct Burial

X-Olene Insulation: #14 Through #10 Awg, 30 mils (0.76mm); #8 Through #2 Awg, 45 mils (1.14mm)

Okoseal Jacket: 50 mils (1.27mm)

Catalog Number	Power Conductors Number X Size	Control Conductors Number X Size	Grounding Conductor AWG	C-L-X O.D. - Inches	C-L-X O.D. - mm	Cable O.D. - Inches	Cable O.D. - mm	Cross-Sectional Area (sq. in.)†	Approx. Net Weight lbs./1000'	Approx. Ship Weight lbs./1000'	90°C Wet or Dry NEC Ampacity (1)	75°C Wet NEC Ampacity
546-31-3983	3X12	3X14	—	0.71	18.0	0.82	20.8	0.53	304	374	20	20
546-31-3927	3X12	4X14	—	0.71	18.0	0.82	20.8	0.53	320	390	20	20
546-31-3950	4X12	3X14	—	0.71	19.1	0.82	20.8	0.53	328	309	20	20
546-31-3925	4X12	4X14	—	0.75	19.1	0.86	21.8	0.58	281	351	20	20
546-31-3758	3X10	3X14	—	0.75	19.1	0.86	21.8	0.58	358	428	30	20
546-31-3992	3X10	4X14	—	0.80	20.3	0.91	23.1	0.65	388	453	30	30
546-31-3990	3X10	3X12	—	0.75	19.1	0.86	21.8	0.58	296	366	30	30
▲ 546-31-3984	3X10	4X12	10	0.75	19.1	0.86	21.8	0.58	430	465	30	30
546-31-3956	4X10	3X14	—	0.80	20.3	0.91	23.1	0.65	408	473	30	28
546-31-3987	4X10	4X14	—	0.80	20.3	0.91	23.1	0.65	424	489	30	28
546-31-3988	4X10	3X12	—	0.80	20.3	0.91	23.1	0.65	432	497	30	28
546-31-3958	4X10	4X12	—	0.80	20.3	0.91	23.1	0.65	455	520	30	28
571-31-3192	3X8	3X14	—	0.80	20.3	0.91	23.1	0.65	420	500	55	50
571-31-3661	3X8	4X14	—	0.84	21.3	0.95	24.1	0.71	450	530	55	50
571-31-3664	3X8	3X12	—	0.80	20.3	0.91	23.1	0.65	450	530	55	50
571-31-3665	3X8	4X12	—	0.84	21.3	0.95	24.1	0.71	490	570	55	50
▲ 571-31-3657	3X8	4X12	10	0.89	22.6	0.99	25.1	0.77	530	585	55	50
571-31-3682	4X8	3X14	—	0.84	21.3	0.95	24.1	0.71	500	580	44	40
571-31-3960	4X8	4X14	—	0.89	22.6	1.00	25.4	0.79	525	605	44	40
571-31-3683	4X8	3X12	—	0.89	22.6	1.00	25.4	0.79	530	615	44	40
571-31-3680	4X8	4X12	—	0.93	23.6	1.04	26.4	0.85	570	650	44	40
571-31-3686	3X6	3X14	—	0.84	21.3	0.95	24.1	0.71	520	600	75	65
571-31-3666	3X6	4X14	—	0.84	21.3	0.95	24.1	0.71	540	620	75	65
571-31-3673	3X6	3X12	—	0.84	21.3	0.95	24.1	0.71	550	630	75	65
571-31-3668	3X6	4X12	—	0.93	23.6	1.03	26.2	0.83	600	680	75	65
▲ 571-31-3667	3X6	4X12	8	0.93	23.6	1.03	26.2	0.83	655	720	75	65
571-31-3968	4X6	3X14	—	0.93	23.6	1.04	26.4	0.85	650	730	60	52
571-31-3684	4X6	4X14	—	0.93	23.6	1.04	26.4	0.85	660	740	60	52
571-31-3685	4X6	3X12	—	0.97	24.6	1.08	27.4	0.92	680	760	60	52
571-31-3965	4X6	4X12	—	0.97	24.6	1.08	27.4	0.92	710	790	60	52
571-31-3655	3X4	3X14	—	0.93	23.6	1.04	26.4	0.85	700	780	95	85
571-31-3970	3X4	4X14	—	0.93	23.6	1.04	26.4	0.85	720	800	95	85
571-31-3671	3X4	3X12	—	0.93	23.6	1.04	26.4	0.85	720	800	95	85
571-31-3974	3X4	4X12	—	0.97	24.6	1.08	27.4	0.92	760	840	95	85
▲ 571-31-3677	3X4	4X12	8	0.97	24.7	1.08	27.5	0.92	810	895	95	85
571-31-3688	4X4	3X14	—	1.06	26.9	1.17	29.7	1.08	890	970	76	68
571-31-3669	4X4	4X14	—	1.06	26.9	1.17	29.7	1.08	920	1000	76	68
571-31-3670	4X4	3X12	—	1.06	26.9	1.17	29.7	1.08	920	1000	76	68
571-31-3672	4X4	4X12	—	1.06	26.9	1.17	29.7	1.08	950	1030	76	68
571-31-3203	3X2	3X14	—	1.06	26.9	1.17	29.7	1.08	985	1065	130	115
571-31-3674	3X2	4X14	—	1.06	26.9	1.17	29.7	1.08	1000	1080	130	115
571-31-3675	3X2	3X12	—	1.06	26.9	1.17	29.7	1.08	1010	1090	130	115
571-31-3505	3X2	4X12	—	1.06	26.9	1.17	29.7	1.08	1040	1115	130	115
571-31-3506	4X2	3X14	—	1.15	29.2	1.26	32.0	1.25	1230	1320	104	92
571-31-3507	4X2	4X14	—	1.15	29.2	1.26	32.0	1.25	1250	1340	104	92
571-31-3508	4X2	3X12	—	1.15	29.2	1.26	32.0	1.25	1260	1350	104	92
571-31-3509	4X2	4X12	—	1.15	29.2	1.26	32.0	1.25	1280	1370	104	92

Visit Okonite's web site, www.okonite.com for the most up to date dimensions.

▲ **Authorized Stock Item** - Available from our Service Centers. These stock items are listed as MC-HL.

Copper or Bronze C-L-X is available on special order.

Jackets

Optional jacket types available - consult local sales office.

†**Cross-sectional** area for calculation of cable tray fill in accordance with NEC Section 392.22.

(1) Ampacities

Ampacities are based on Table 310.15(B)(16) of the National Electrical Code for XHHW-2 conductors rated 90°C, in a multi-conductor cable, at an ambient temperature of 30°C (86°F). The 75°C column is provided for additional information.

The ampacities shown apply to open runs of cable, installation in any approved raceway, direct burial in the earth, or as aerial cable on a messenger. Derating for more than three current carrying conductors within the cable is in accordance with NEC Section 310.15(B)(3)(a).

The ampacities shown also apply to cable installed in cable tray in accordance with NEC Section 392.80



Okonite-FMR® Okoseal® Type



UL Type TC/TC-ER and cUL CIC 600V Power & Control Tray Cable or Oko-Marine Cable 600/1000V

Multiple Copper Conductors With or Without
Grounding Conductor/90°C Wet or Dry

For Cable Tray Use - Sunlight Resistant - For Direct Burial

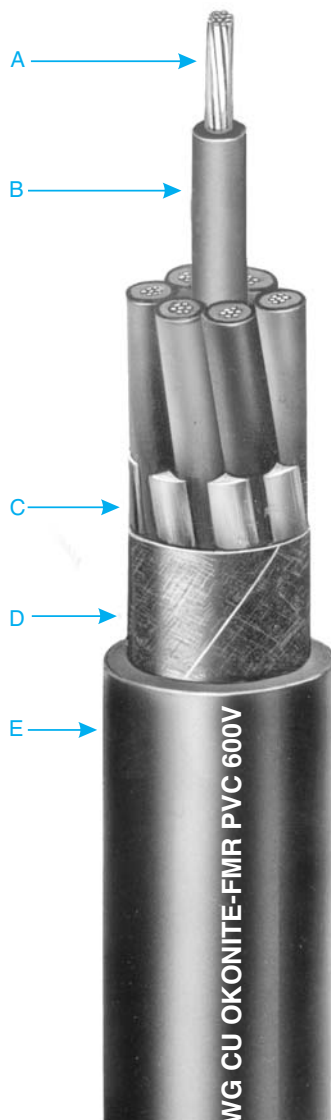

- A Stranded Copper Conductors
- B Okonite-FMR Insulation
- C Fillers, as necessary
- D Binder Tape
- E Okoseal Jacket — Black

Insulation

Okonite-FMR is Okonite's trade name for its heat, moisture, flame and chemical resistant, mechanically rugged ethylene-propylene insulating compound.

The properties of Okonite-FMR insulation substantially enhance the well known features of ethylene-propylene rubber insulations.

Overall Jacket

The Okoseal (PVC) jacket is mechanically rugged and has excellent resistance to most chemicals.

Applications

Okonite-FMR Okoseal Type TC-ER tray cable is permitted for use on power, lighting, control, and signal circuits; indoors or outdoors; in cable trays, raceways, direct burial in the ground, or where supported in outdoor locations by a messenger wire; for Class 1 circuits as permitted in Article 725 of the NEC; and in cable trays in Class I, Division 2 hazardous locations in industrial establishments where the conditions of maintenance and supervision assure that only qualified persons will service the installation. Cables marked TC-ER may also be used between a cable tray and the utilization equipment or device, when installed in accordance with NEC 336.10(7).

As Type Oko-Marine cable, it is suitable for use in marine shipboard and off-shore platform applications in accordance with API and ABS requirements.

Specifications

Conductors: Uncoated soft copper per ASTM B-3. Sizes smaller than #8 are compress stranded per ASTM B-8. Sizes #8 and larger are compact stranded per ASTM B-496.

Insulation: Okonite-FMR meets or exceeds requirements of UL 1581, ICEA S-73-532 (NEMA WC57) and ICEA S-95-658 NEMA WC70 Type II insulation.

Color Coding: Base colors and tracers as shown on reverse of Data Sheet and for sizes #8 AWG and larger black conductors with surface printing of numbers per ICEA S-73-532 NEMA/WC57 Method 4.

Grounding Conductor: Where indicated, bare stranded copper per ASTM B-8, or compact round per ASTM B-496, Class B & NEC Table 250.122.

Assembly: Conductors cabled in accordance with UL 1277 and 1309 using fillers, as necessary, with a cable tape overall.

Overall Jacket: Complies with UL 1277 and 1309. The Okoseal compound meets or exceeds the requirements of UL 1581. UL Listed as Type TC or TC-ER cable with a sunlight resistant low temperature jacket and for direct burial and Type Oko-Marine cable.

Sizes 4 AWG and larger without a grounding conductor are Type TC only (not ER).

Product Features

Insulated conductors are UL rated VW-1. 90°C continuous rating in wet or dry 130°C emergency overload rating 250°C short circuit rating.

Okonite-FMR Okoseal Type TC-ER and Oko-Marine cables are quality control inspected to meet or exceed applicable industry standards.

Resistant to moisture and most chemical atmospheres.

Thermal stability at elevated temperatures.

Flexible, easy to install and terminate.

High dielectric strength.

Installation Temperature -35°C.

Applicable Standards

- UL listed for cable tray use, direct burial, in ducts, and sunlight resistant.
- Vertical Tray Flame Tests; IEEE 383-1974, FT4/IEEE 1202, UL 1277, Sizes 250 kcmil and larger meet ICEA T-29-520 (210,000 BTU/hr).
- OSHA Acceptable
- UL 1309-Oko-Marine
- UL certified to IEEE 1580 - Marine Shipboard Cable rated 600/1000V.
- ABS Type approved; API-RP-14F, IEEE 45 & 1202, 46 CFR 111.60.
- CSA C22.2 No. 239 Type CIC for sizes 4/0 AWG and smaller.
- CSA C22.2 No. 245 Type Marine Shipboard.

Okonite-FMR Okoseal®

UL Type TC/TC-ER and cUL CIC 600V Power & Control Tray Cable or Oko-Marine Cable 600/1000V

Multiple Copper Conductors With or Without Grounding Conductor/90°C Wet or Dry Rating

For Cable Tray Use - Sunlight Resistant - for Direct Burial

Product Data Section 4: Sheet 5



Catalog Number	Conductor Size AWG/kcmil	Number of Conductors	Insulation Thickness (mils)	Grounding Conductor AWG	Jacket Thickness (mils)	Jacket Thickness (mm)	Approx. O.D. (In.)	Approx. O.D. (mm)	Cross-Sectional Area (sq. In.) †	Approx. Net Weight lbs./1000'	Approx. Ship Weight lbs./1000'	90°C Wet or Dry NEC Ampacity (1)	75°C Wet NEC Ampacity (1)
UL TYPE: TC-ER													
▲ 202-10-3203	14(7X)	3	—	45	1.14	0.40	10.2	0.13	104	127	15	15	
▲ 202-10-3204		4	—	45	1.14	0.44	11.2	0.16	126	149	15	15	
▲ 202-10-3205		5	—	45	1.14	0.48	12.2	0.18	151	174	15	15	
▲ 202-10-3207		7	—	45	1.14	0.52	13.2	0.22	195	218	15	14	
202-10-3209		9	—	60	1.52	0.63	16.0	0.32	260	292	15	14	
▲ 202-10-3212		12	—	60	1.52	0.71	18.0	0.40	332	364	12	10	
▲ 202-10-3219		19	—	60	1.52	0.82	20.8	0.54	480	519	12	10	
▲ 202-10-3237		37	—	80	2.03	1.14	29.0	1.03	925	1005	10	8	
▲ 202-10-3403		12(7X)	3	—	45	1.14	0.44	11.2	0.16	134	157	20	20
▲ 202-10-3443			3	12*	45	1.14	0.48	12.2	0.18	162	185	20	20
▲ 202-10-3404			4	—	45	1.14	0.48	12.2	0.19	167	190	20	20
▲ 202-10-3405			5	—	45	1.14	0.52	13.2	0.22	202	225	20	20
▲ 202-10-3407	7		—	60	1.52	0.60	15.2	0.29	281	305	20	17	
▲ 202-10-3409	9		—	60	1.52	0.70	17.8	0.39	363	395	20	17	
▲ 202-10-3412	12		—	60	1.52	0.78	19.8	0.49	446	485	15	12	
▲ 202-10-3419	19		—	80	2.03	0.95	24.1	0.73	697	752	15	12	
202-10-3437	37		—	80	2.03	1.26	32.0	1.27	1266	1266	12	10	
▲ 202-10-3503	10(7X)		3	—	45	1.14	0.49	12.4	0.20	183	206	30	30
▲ 202-10-3543			3	10*	45	1.14	0.53	13.5	0.23	223	247	30	30
▲ 202-10-3504			4	—	60	1.52	0.57	14.5	0.26	243	267	30	28
202-10-3505		5	—	60	1.52	0.62	15.7	0.31	294	318	30	28	
202-10-3507		7	—	60	1.52	0.67	17.0	0.37	384	416	28	24	
202-10-3509		9	—	60	1.52	0.78	19.8	0.49	494	533	28	24	
202-10-3512		12	—	80	2.03	0.92	23.4	0.68	669	724	20	17	

Visit Okonite's web site, www.okonite.com, for the most up to date dimensions.

▲ Authorized stock item — Available from our Service Centers.

Equipment Grounding Conductor: Any conductor in these cables may be permanently re-identified during installation as the equipment grounding conductor in accordance with Section 250.119.B of the NEC.

† **Cross-sectional** area for calculation of cable tray fill in accordance with Section 392.22 of the NEC.

(1) Ampacities

Ampacities are based on Table 310-15(B)(16) of the National Electrical Code for conductors rated 90°C, in a multi-conductor cable, at an ambient temperature of 30°C (86°F). The 75°C column is provided for additional information.

The ampacities shown apply to open runs of cable, installation in any approved raceway, direct burial in the earth, or as aerial cable on a messenger. Derating for more than three current carrying conductors within the cable is in accordance with NEC Section 310.15(B)(3)(a)

The ampacities shown also apply to cables installed in cable tray in accordance with NEC Section 392.80.

Product Data

Section 4: Sheet 5

Catalog Number	Conductor Size AWG/kcmil	UL TC TYPE	Number of Conductors	Insulation Thickness (mils)	Grounding Conductor AWG**	Jacket Thickness (mils)	Jacket Thickness (mm)	Approx. O.D. (In.)	Approx. O.D. (mm)	Cross-Sectional Area (sq. In.) +	Approx. Net Weight lbs./1000'	Approx. Ship Weight lbs./1000'	90°C Wet or Dry NEC Ampacity (1)	75°C Wet NEC Ampacity (1)
112-10-3842	8(7X)	TC-ER	3	45	—	60	1.52	0.64	16.3	0.32	273	305	55	50
▲ 112-10-3844			3		10*	60	1.52	0.70	17.8	0.38	349	388	55	50
112-10-3845			4		—	60	1.52	0.70	17.8	0.38	352	391	45	40
112-10-3847			4		10*	60	1.52	0.73	18.5	0.42	412	451	45	40
112-10-3852	6(7X)	TC-ER	3	45	—	60	1.52	0.72	18.3	0.41	382	421	75	65
▲ 112-10-3854			3		8*	60	1.52	0.76	19.3	0.45	437	469	75	65
112-10-3855			4		—	60	1.52	0.79	20.1	0.49	493	532	60	52
112-10-3857			4		8*	60	1.52	0.83	21.1	0.54	582	637	60	52
112-10-3862	4(7X)	TC	3	45	—	60	1.52	0.81	20.6	0.52	549	588	95	85
▲ 112-10-3864		TC-ER	3		8*	80	2.03	0.84	21.3	0.55	696	751	95	85
112-10-3865		TC	4		—	80	2.03	0.94	23.9	0.69	750	805	76	68
112-10-3867		TC-ER	4		8*	80	2.03	1.00	25.4	0.79	891	955	76	68
112-10-3872	2(7X)	TC	3	45	—	80	2.03	0.99	25.1	0.77	888	952	130	115
▲ 112-10-3874		TC-ER	3		6	80	2.03	0.99	25.1	0.77	941	1005	130	115
112-10-3875		TC	4		—	80	2.03	1.09	27.7	0.93	1133	1200	104	92
112-10-3877		TC-ER	4		6	80	2.03	1.12	28.4	0.99	1242	1322	104	92
112-10-3882	1(19X)	TC	3	55	—	80	2.03	1.10	27.9	0.95	1103	1170	150	130
112-10-3884		TC-ER	3		6	80	2.03	1.10	27.9	0.95	1180	1247	150	130
112-10-3885		TC	4		—	80	2.03	1.21	30.7	1.15	1434	1534	120	104
112-10-3887		TC-ER	4		6	80	2.03	1.21	30.7	1.15	1505	1605	120	104
112-10-3892	1/0(19X)	TC	3	55	—	80	2.03	1.18	30.0	1.09	1330	1410	170	150
▲ 112-10-3894		TC-ER	3		6	80	2.03	1.18	30.0	1.09	1410	1490	170	150
112-10-3895		TC	4		—	80	2.03	1.30	33.0	1.33	1741	1841	136	120
112-10-3897		TC-ER	4		6	80	2.03	1.23	31.2	1.19	1812	1912	136	120
112-10-3902	2/0(19X)	TC	3	55	—	80	2.03	1.27	32.3	1.27	1632	1732	195	175
▲ 112-10-3904		TC-ER	3		6	80	2.03	1.27	32.3	1.27	1711	1811	195	175
112-10-3905		TC	4		—	80	2.03	1.40	35.6	1.54	2114	2230	156	140
112-10-3907		TC-ER	4		6	80	2.03	1.40	35.6	1.54	2186	2302	156	140
112-10-3922	4/0(19X)	TC	3	55	—	80	2.03	1.48	39.4	—	2462	2605	260	230
▲ 112-10-3924		TC-ER	3		4	80	2.03	1.48	39.4	—	2576	2719	260	230
112-10-3925		TC	4		—	80	2.03	1.64	50.0	—	3206	3383	208	184
112-10-3927		TC-ER	4		4	80	2.03	1.64	50.0	—	3320	3497	208	184
112-10-3928	250(37X)	TC	3	65	—	80	2.03	1.62	44.7	—	2904	3047	290	255
112-10-3929		TC-ER	3		4	80	2.03	1.62	44.7	—	3029	3206	290	255
112-10-3930		TC	4		—	110	2.79	1.86	49.3	—	3893	4159	232	185
112-10-3931		TC-ER	4		4	110	2.79	1.86	49.3	—	4000	4265	232	185
112-10-3932	350(37X)	TC	3	65	—	110	2.79	1.89	50.3	—	3995	4261	350	310
▲ 112-10-3933		TC-ER	3		3	110	2.79	1.89	50.3	—	4164	4430	350	310
112-10-3934		TC	4		—	110	2.79	2.08	55.6	—	5243	5590	280	248
112-10-3935		TC-ER	4		3	110	2.79	2.08	55.6	—	5394	5741	280	248
112-10-3936	500(37X)	TC	3	65	—	110	2.79	2.14	57.4	—	5549	5939	430	380
▲ 112-10-3937		TC-ER	3		2	110	2.79	2.14	57.4	—	5743	6133	430	380
112-10-3938		TC	4		—	110	2.79	2.37	63.5	—	7237	7796	344	304
112-10-3939		TC-ER	4		2	110	2.79	2.37	63.5	—	7425	7984	344	304
112-10-3940	750(61X)	TC	3	80	—	110	2.79	2.58	68.6	—	8277	8904	535	475
112-10-3941		TC-ER	3		1	110	2.79	2.58	68.6	—	8515	9142	535	475
112-10-3942		TC	4		—	140	3.56	2.92	76.5	—	10942	11704	428	380
112-10-3943		TC-ER	4		1	140	3.56	2.92	76.5	—	11157	11919	428	380
112-10-3944	1000(61X)	TC	3	80	—	140	3.56	2.96	77.2	—	10953	11715	615	545
112-10-3945		TC-ER	3		1/0	140	3.56	2.96	77.2	—	11237	12000	615	545
112-10-3946		TC	4		—	140	3.56	3.28	85.6	—	14337	15270	492	436
112-10-3947		TC-ER	4		1/0	140	3.56	3.28	85.6	—	14632	15565	492	436

Note: Sizes 4 AWG & larger without a grounding conductor are type TC only (not ER rated).

*Ground size marked with asterisk are green insulated. **Grounds may be split.

Visit Okonite's web site, www.okonite.com, for the most up to date dimensions.

Okonite-FMR Okoseal

UL Type TC/TC-ER and cUL CIC 600V Power & Control Tray

Cable or Oko-Marine Cable 600/1000V

Multiple Copper Conductors With or Without

Grounding Conductor/ 90°C Wet or Dry

For Cable Tray Use - Sunlight Resistant - For Direct Burial

Product Data Section 4: Sheet 5



Conductor Color Coding Sequence Sizes 14, 12 & 10 AWG

Conductor Number	Base Color	Tracer Color
1	Black	
2	Red	
3	Blue	
4	Orange	
5	Yellow	
6	Brown	
7	Red	Black
8	Blue	Black
9	Orange	Black
10	Yellow	Black
11	Brown	Black
12	Black	Red
13	Blue	Red
14	Orange	Red
15	Yellow	Red
16	Brown	Red
17	Black	Blue
18	Red	Blue
19	Orange	Blue
20	Yellow	Blue
21	Brown	Blue
22	Black	Orange
23	Red	Orange
24	Blue	Orange
25	Yellow	Orange
26	Brown	Orange
27	Black	Yellow
28	Red	Yellow
29	Blue	Yellow
30	Orange	Yellow
31	Brown	Yellow
32	Black	Brown
33	Red	Brown
34	Blue	Brown
35	Orange	Brown
36	Yellow	Brown
37	Black	

Color Coding per ICEA Method 1, E-2

Sizes 8 AWG and larger:

Surface Printing of Numbers per ICEA Method 4

Special Order: Any or all of the following conductors may be added when specifically requested by the customer to meet his specific application requirements. These conductor codings comply with UL and NEC requirements.

<u>Purpose</u>	<u>Base Color</u>	<u>Tracer Color</u>
Equipment Grounding	Uninsulated Green Green	1 or more continuous yellow stripes
Grounded	White White White White White White White	Black continuous stripe Red continuous stripe Blue continuous stripe Orange continuous stripe Brown continuous stripe Numeric Printing



X-Olene®-Okoseal®

UL Type TC/TC-ER (XHH/XHHW-2) and cUL CIC

600 Volt Power and Control Tray Cable

Multiple Copper Conductors, 90°C Wet or Dry
With or Without Grounding Conductor

For Cable Tray Use - Sunlight Resistant - For Direct Burial



A Uncoated Copper Conductors
B X-Olene Insulation
C Fillers, as required
D Black Okoseal Jacket

Insulation

X-Olene® is Okonite's trade name for its cross-linked polyethylene, with high dielectric strength insulation.

Jacket

The Okoseal (PVC) jacket supplied with this cable is mechanically rugged and has excellent resistance to acids and most chemicals and is rated for low temperature installations.

Applications

Okonite X-Olene Okoseal tray cable is permitted for use on power, lighting, control, and signal circuits; indoors or outdoors; in cable trays, raceways, direct burial in the ground, or where supported in outdoor locations by a messenger wire; for Class 1 circuits as permitted in Article 725 of the NEC; and in cable trays in Class I, Division 2 hazardous locations in industrial establishments where the conditions of maintenance and supervision assure that only qualified persons will service the installation. Cables marked TC-ER may also be used between a cable tray and the utilization equipment or device, when installed in accordance with NEC 336.10(7).

Specifications

Conductors: Uncoated soft copper per ASTM B-3. Sizes smaller than #8 are compress stranded per ASTM B-8. Sizes #8 and larger are compact stranded per ASTM B-496.

Insulation: X-Olene insulation per UL 1581, listed as XHHW-2.

Color Coding: Base colors and tracers as shown on reverse of Data Sheet and, for sizes #8 AWG and larger, black conductors with surface printing of numbers and colors per ICEA S-73-532 NEMA/WC57 Method 3.

Assembly: Conductors cabled in accordance with UL 1277 using fillers and tape, as needed.

Grounding Conductor: Where indicated, bare or insulated stranded copper in accordance with NEC Table 250.122.

Overall Jacket: Complies with UL 1277. The Okoseal compound meets or exceeds the requirements of UL 1581.

Cable passes the Vertical Tray Flame Test requirements of UL 1277 for Type TC Power and Control Tray Cable.

UL Listed as Type TC or TC-ER cable with a sunlight resistant jacket and for direct burial.

Product Features

Insulated conductors are UL Listed Type XHH / XHHW-2.

90°C continuous rating in wet or dry locations.

130°C emergency overload rating.

250°C short circuit rating.

X-Olene Okoseal Type TC or TC-ER cables are quality control inspected to meet or exceed applicable industry standards.

Resistant to moisture and most chemical atmospheres.

Thermal stability at elevated temperatures.

Easy to install and terminate.

Mechanically rugged.

High dielectric strength.

Small diameter, lightweight.

Minimum installation temperature of -40°C.

Applicable Standards

- UL listed for cable tray use, direct burial, in ducts, and sunlight resistant.
- Vertical Tray Flame Tests: IEEE 383-1974, Sizes 4/0 AWG and larger meet FT4/IEEE 1202.
- CSA C22.2 No. 239 Type CIC for sizes 4/0 AWG and smaller.

X-Olene-Okoseal



Product Data Section 4: Sheet 8

UL Type TC/TC-ER (XHH/XHHW-2) and cUL CIC

600V Power and Control Tray Cable

Multiple Copper Conductors, 90°C Wet or Dry

With or Without Grounding Conductor

For Cable Tray Use - Sunlight Resistant - For Direct Burial

Catalog Number	Conductor Size AWG/kcmil	UL TYPE	Number of Conductors	Insulation Thickness - mils	Jacket Thickness - mils	Jacket Thickness - mils	Approx. Thickness - mm	Approx. O.D. - Inches	Approx. O.D. - mm	Approx. Cross-Sectional Area (sq. in.)†	Approx. Net Weight lbs./1000'	Approx. Ship Weight lbs./1000'	90°C Wet or Dry NEC Ampacity (1)	75°C Wet NEC Ampacity (1)	
▲ 202-31-3502	14(7X) (2.08mm ²)	TC	2	30 (0.76mm)	45	1.14	0.37	9.4	0.11	70	85	15	15		
▲ 202-31-3503		TC-ER	3		45	1.14	0.41	10.4	0.13	105	120	15	15		
▲ 202-31-3504		TC-ER	4		45	1.14	0.43	10.9	0.15	120	135	15	15		
▲ 202-31-3505		TC-ER	5		45	1.14	0.47	11.9	0.17	132	148	15	15		
▲ 202-31-3507		TC-ER	7		45	1.14	0.50	12.7	0.20	182	205	15	14		
▲ 202-31-3509		TC-ER	9		60	1.52	0.62	15.7	0.30	254	278	15	14		
▲ 202-31-3512		TC-ER	12		60	1.52	0.69	17.6	0.38	306	338	12	10		
202-31-3519		TC-ER	19		60	1.52	0.80	20.3	0.50	446	485	12	10		
202-31-3537		TC-ER	37		80	2.03	1.11	28.2	0.97	856	936	10	8		
▲ 202-31-3602		12(7X) (3.31mm ²)	TC		2	30 (0.76mm)	45	1.14	0.40	10.2	0.13	92	107	20	20
▲ 202-31-3603			TC-ER		3		45	1.14	0.44	11.2	0.15	139	152	20	20
▲ 202-31-3604			TC-ER		4		45	1.14	0.47	11.9	0.17	171	187	20	20
▲ 202-31-3605	TC-ER		5	45	1.14		0.52	13.1	0.21	179	195	20	20		
▲ 202-31-3607	TC-ER		7	60	1.52		0.59	15.0	0.27	269	293	20	17		
▲ 202-31-3609	TC-ER		9	60	1.52		0.68	17.3	0.36	344	376	20	17		
▲ 202-31-3612	TC-ER		12	60	1.52		0.77	19.6	0.47	425	464	15	12		
202-31-3619	TC-ER		19	80	2.03		0.95	24.1	0.71	640	704	15	12		
202-31-3637	TC-ER		37	80	2.03		1.24	31.5	1.21	1200	1290	12	10		
▲ 202-31-3702	10(7X) (5.26mm ²)		TC	2	30 (0.76mm)		45	1.14	0.45	11.4	0.16	122	138	30	30
▲ 202-31-3703			TC-ER	3			45	1.14	0.48	12.2	0.18	183	199	30	30
▲ 202-31-3704			TC-ER	4			45	1.14	0.53	13.5	0.22	238	254	30	28
202-31-3705		TC-ER	5	60		1.52	0.61	15.5	0.29	294	318	30	28		
202-31-3707		TC-ER	7	60		1.52	0.66	16.8	0.34	378	410	28	24		
202-31-3709		TC-ER	9	60		1.52	0.77	19.6	0.47	485	524	28	24		
202-31-3712		TC-ER	12	80		2.03	0.91	23.1	0.65	643	698	20	17		

Catalog Number	Conductor Size AWG/kcmil	Number of Conductors	Insulation Thickness - mils	Green Insulated Grounding Conductor AWG	Jacket Thickness - mils	Jacket Thickness - mils	Approx. Thickness - mm	Approx. O.D. - Inches	Approx. O.D. - mm	Approx Cross-Sectional Area (sq. in.)†	Approx. Net Weight lbs./1000'	Approx. Ship Weight lbs./1000'	90°C Wet or Dry NEC Ampacity (1)	75°C Wet NEC Ampacity (1)
UL TYPE: TC-ER														
202-31-3813	14(7X)	3	30	1#14	45	1.14	.43	10.9	0.15	120	135	15	15	
▲ 202-31-3823	12(7X)	3	30	1#12	45	1.14	.47	11.9	0.17	171	187	20	20	
▲ 202-31-3833	10(7X)	3	30	1#10	45	1.14	.53	13.5	0.22	238	254	30	30	

▲ Authorized Stock Item - Available from our Service Centers.

Equipment Grounding Conductor: Any conductor in these cables may be permanently re-identified during installation as the equipment grounding conductor in accordance with Section 250.119.B of the NEC.

† Cross-sectional area for calculation of cable tray fill in accordance with NEC Section 392.22.

(1) Ampacities

Ampacities are based on Table 310.15(B)(16) of the National Electrical Code for XHHW-2 conductors rated 90°C, in a multi-conductor cable, at an ambient temperature of 30°C (86°F). Derating for more than three current carrying conductors within the cable is in accordance with NEC Section 310.15(B)(3)(a).

The ampacities shown also apply to cables installed in cable tray in accordance with NEC Section 392.80.

Product Data

Section 4: Sheet 8

Catalog Number	Conductor Size AWG/kcmil	UL TYPE	Number of Conductors	Insulation Thickness - mils	Grounding Conductor AWG	Jacket Thickness - mils	Jacket Thickness - mm	Approx. O.D. - Inches	Approx. O.D. - mm	Approx. Cross-Sectional Area (sq. in./ft	Approx. Net Weight lbs./1000'	Approx. Ship Weight lbs./1000'	90°C Wet or Dry NEC Ampacity (1)	75°C Wet (1) NEC Ampacity
112-31-3734	8(7X) (8.36mm ²)	TC-ER	3	—	60	1.52	0.64	16.3	0.32	259	298	55	50	
▲ 112-31-3735		TC-ER	3	10	60	1.52	0.66	16.7	0.34	313	352	55	50	
112-31-3736		TC-ER	4	—	60	1.52	0.70	17.8	0.39	331	370	44	40	
112-31-3737		TC-ER	4	10	60	1.52	0.72	18.3	0.41	385	424	44	40	
112-31-3746	6(7X) (13.3mm ²)	TC-ER	3	—	60	1.52	0.71	18.0	0.40	365	404	75	65	
▲ 112-31-3747		TC-ER	3	8	60	1.52	0.74	18.8	0.43	440	479	75	65	
112-31-3748		TC-ER	4	—	60	1.52	0.78	19.8	0.48	471	510	60	52	
112-31-3749		TC-ER	4	8	60	1.52	0.82	20.8	0.53	552	616	60	52	
112-31-3758	4(7X) (21.2mm ²)	TC	3	—	60	1.52	0.81	20.6	0.52	527	566	95	85	
▲ 112-31-3759		TC-ER	3	8	60	1.52	0.81	20.6	0.52	662	715	95	85	
112-31-3760		TC	4	—	80	2.03	0.93	23.6	0.68	720	784	76	68	
112-31-3761		TC-ER	4	8	80	2.03	0.96	24.4	0.72	808	872	76	68	
112-31-3764	2(7X) (33.6mm ²)	TC	3	—	80	2.03	0.97	24.6	0.74	816	880	130	115	
▲ 112-31-3765		TC-ER	3	6	80	2.03	0.97	24.6	0.74	1018	1098	130	115	
112-31-3766		TC	4	—	80	2.03	1.07	27.2	0.90	1060	1140	104	92	
112-31-3767		TC-ER	4	6	80	2.03	1.11	28.2	0.97	1196	1276	104	92	
112-31-3770	1(19X) (42.4mm ²)	TC	3	—	80	2.03	1.09	27.7	0.93	1051	1118	150	130	
112-31-3771		TC-ER	3	6	80	2.03	1.09	27.7	0.93	1127	1194	150	130	
112-31-3772		TC	4	—	80	2.03	1.20	30.5	1.13	1355	1435	120	104	
112-31-3773		TC-ER	4	6	80	2.03	1.20	30.5	1.13	1431	1511	120	104	
112-31-3776	1/0(19X) (53.5mm ²)	TC	3	—	80	2.03	1.17	29.7	1.08	1274	1354	170	150	
▲ 112-31-3777		TC-ER	3	6	80	2.03	1.17	20.7	1.08	1350	1430	170	150	
112-31-3778		TC	4	—	80	2.03	1.29	32.8	1.31	1652	1752	136	120	
112-31-3779		TC-ER	4	6	80	2.03	1.29	32.8	1.31	1729	1829	136	120	
112-31-3780	2/0(19X) (67.4mm ²)	TC	3	—	80	2.03	1.26	32.0	1.25	1561	1661	195	175	
▲ 112-31-3781		TC-ER	3	6	80	2.03	1.26	32.0	1.25	1639	1739	195	175	
112-31-3782		TC	4	—	80	2.03	1.39	35.3	1.52	2033	2149	156	140	
112-31-3783		TC-ER	4	6	80	2.03	1.39	35.3	1.52	2109	2225	156	140	
112-31-3784	4/0 (19X) (107mm ²)	TC	3	—	80	2.03	1.47	37.3	—	2361	2504	260	230	
▲ 112-31-3785		TC-ER	3	4	80	2.03	1.47	37.3	—	2488	2631	260	230	
112-31-3786		TC	4	—	80	2.03	1.63	41.4	—	3101	3278	208	184	
112-31-3787		TC-ER	4	4	80	2.03	1.63	41.4	—	3222	3399	208	184	
112-31-3788	250(37X) (127mm ²)	TC	3	—	80	2.03	1.62	41.2	—	2796	2939	290	255	
112-31-3789		TC-ER	3	4	80	2.03	1.62	41.2	—	2917	3060	290	255	
112-31-3790		TC	4	—	110	2.79	1.85	47.0	—	3778	4044	232	185	
112-31-3791		TC-ER	4	4	110	2.79	1.85	47.0	—	3899	4165	232	185	
112-31-3792	350(37X) (177mm ²)	TC	3	—	110	2.79	1.88	47.8	—	3889	4155	350	310	
▲ 112-31-3793		TC-ER	3	3	110	2.79	1.88	47.8	—	4044	4310	350	310	
112-31-3794		TC	4	—	110	2.79	2.08	52.8	—	5091	5438	280	248	
112-31-3795		TC-ER	4	3	110	2.79	2.08	52.8	—	5245	5592	280	248	
112-31-3796	500(37X) (253mm ²)	TC	3	—	110	2.79	2.13	54.1	—	5386	5733	430	380	
▲ 112-31-3797		TC-ER	3	2	110	2.79	2.13	54.1	—	5581	5928	430	380	
112-31-3798		TC	4	—	110	2.79	2.36	59.9	—	7082	7641	344	304	
112-31-3799		TC-ER	4	2	110	2.79	2.36	59.9	—	7276	7835	344	304	
112-31-3800	750(61X) (380mm ²)	TC	3	—	110	2.79	2.56	65.0	—	7961	8520	535	475	
▲ 112-31-3801		TC-ER	3	1	110	2.79	2.56	65.0	—	8206	8833	535	475	
112-31-3802		TC	4	—	140	3.56	2.90	73.7	—	10632	11394	428	380	
112-31-3803		TC-ER	4	1	140	3.56	2.90	73.7	—	10879	11641	428	380	
112-31-3804	1000(61X) (507mm ²)	TC	3	—	140	3.56	2.93	74.4	—	10584	11346	615	545	
112-31-3805		TC-ER	3	1/0	140	3.56	2.93	74.4	—	10894	11656	615	545	
112-31-3806		TC	4	—	140	3.56	3.25	82.6	—	13925	14858	492	436	
112-31-3807		TC-ER	4	1/0	140	3.56	3.25	82.6	—	14235	15168	492	436	

NOTE: Sizes 4AWG & larger without a grounding conductor are Type TC only (Not ER rated).

X-Olene-Okoseal



UL Type TC/TC-ER (XHH/XHHW-2) and cUL CIC

600 Volt Power and Control Tray Cable

Multiple Copper Conductors, 90°C Wet or Dry

With or Without Grounding Conductor

For Cable Tray Use - Sunlight Resistant - For Direct Burial

Product Data

Section 4: Sheet 8

Conductor Color Coding Sequence

Conductor Number	Base Color	Tracer Color
1	Black	
2	Red	
3	Blue	
4	Orange	
5	Yellow	
6	Brown	
7	Red	Black
8	Blue	Black
9	Orange	Black
10	Yellow	Black
11	Brown	Black
12	Black	Red
13	Blue	Red
14	Orange	Red
15	Yellow	Red
16	Brown	Red
17	Black	Blue
18	Red	Blue
19	Orange	Blue
20	Yellow	Blue
21	Brown	Blue
22	Black	Orange
23	Red	Orange
24	Blue	Orange
25	Yellow	Orange
26	Brown	Orange
27	Black	Yellow
28	Red	Yellow
29	Blue	Yellow
30	Orange	Yellow
31	Brown	Yellow
32	Black	Brown
33	Red	Brown
34	Blue	Brown
35	Orange	Brown
36	Yellow	Brown
37	Black	

Color Coding

Sizes 14, 12 & 10 AWG:
per ICEA Method 1, E-2 color sequence

Sizes 8 AWG and larger:
Surface Printing of Numbers and color designation per ICEA Method 3, E-2 color sequence

Special Order: Any or all of the following conductors may be added when specifically requested by the customer to meet his specific application requirements. These conductor codings comply with UL and NEC requirements.

<u>Purpose</u>	<u>Base Color</u>	<u>Tracer Color</u>
Equipment Grounding	Uninsulated Green Green	1 or more continuous yellow stripes
Grounded	White White White White White White White	Black continuous stripe Red continuous stripe Blue continuous stripe Orange continuous stripe Brown continuous stripe Numeric Printing



C-L-X[®] Type MC (XHHW-2)

600V Control Cable — Aluminum Sheath 600/1000V Marine Cable

Multiple Copper Conductors/90°C Wet or Dry Rating

For Cable Tray Use - Sunlight Resistant - For Direct Burial

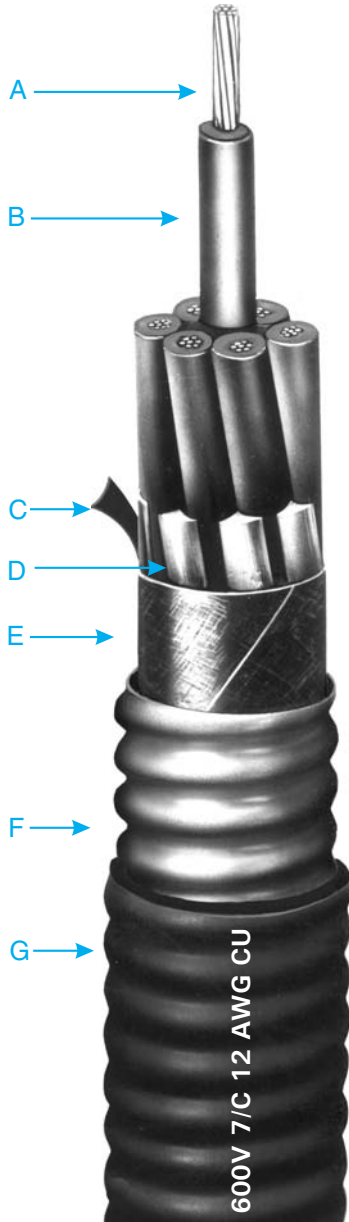

- A Bare, Stranded Copper Conductors
- B X-Olene Insulation - Color Coded for Identification
- C Marker Tape
- D Non-hygroscopic Fillers, as necessary
- E Binder Tape
- F Impervious, Continuous, Corrugated, Aluminum C-L-X Sheath
- G Black Okoseal Jacket

Insulation

X-Olene[®] is Okonite's trade name for its chemically cross-linked polyethylene, with high dielectric strength.

Color Coding

Conductors are color coded using base colors and tracers in accordance with the Conductor Identification Table on the back of this Data Sheet.

Assembly and Coverings

The individual conductors are cabled together with non-hygroscopic fillers and a binder tape overall. The C-L-X sheath exceeds the grounding conductor requirements of Table 250.122 of the NEC and UL 1569.

The impervious, continuous, corrugated aluminum C-L-X sheath provides complete protection against moisture, liquids and gases and has excellent mechanical strength. For direct burial in the ground, embedment in concrete, or for areas subjected to corrosive atmospheres, the C-L-X sheath is protected with a low temperature black Okoseal[®] (PVC) jacket.

Applications

C-L-X Type MC cables with the impervious, continuous, corrugated aluminum sheath are recommended as an economical alternate to a wire in conduit system.

They are authorized for use on services, feeders and branch circuits for power, lighting, control and signaling circuits in accordance with Articles 330 and 725 of the NEC.

C-L-X Type MC cables may be installed indoors or outdoors, in wet or dry locations, as open runs of cable secured to supports spaced not more than six feet apart, in cable tray, as aerial cable on a messenger, in any approved raceway, direct burial, or encased in concrete.

C-L-X Type MC cables are also approved for use in Class I & II, Division 2, Class III, Divisions 1 and 2, and Class I, Zone 2 hazardous locations per NEC articles 501, 502, 503 and 505; in Zone 2, Class II Div 2, Class III Div 1 and Class III Div 2 per CEC.

Specifications

Conductors: Bare soft annealed copper, Class B stranding per ASTM B-8.

Insulation: X-Olene per ICEA S-73-532/ NEMA WC57 and UL 44, Listed UL Type XHHW-2. Meets MIL-DTL-1377H, section 4.8.4.1.2 cold bend at -66°C and ASTM D746-04 brittle point at -76°C.

Conductor Identification: Base Colors and tracers.

Assembly: Per UL 1569 with binder tape overall.

Sheath: Close fitting, impervious, continuous, corrugated aluminum C-L-X per UL 1569.

Exceeds grounding conductor requirements of NEC Table 250.122.

Jacket: Black Okoseal (PVC) per UL requirements for Type MC Cables. Meets ASTM D746-04 brittle point at -40°C.

Product Features

- UL Listed as Type MC cable and Marine Shipboard Cable, E38916 (UL 1596) and E137931 (UL 1309).
- UL Listed for cable tray use, direct burial and sunlight resistant.
- UL 1309 (CWCMC) listed & UL classified in accord with IEEE 1580 as Marine Shipboard Cable rated 600/1000 volts.
- CSA C22.2 No. 123 listed as RA90, FT4 and LTGG (-40°C).
- Passes the IEEE 383-1974 and IEEE 1202 vertical tray flame tests.
- Passes the 210,000 BTU/hr ICEA T-29-520 Vertical Tray Flame Test.
- Complete pre-packaged, factory-tested wiring system — color coded.
- C-L-X cables are quality control inspected to meet or exceed applicable UL standards.
- 90°C continuous operating temperature in all types of installations
- 130°C emergency rating
- 250°C short circuit rating.
- Good EMI shielding characteristics.
- Impervious, continuous metallic sheath excludes moisture, gases and liquids.
- Lower installed system cost than conduit or EMT systems.
- Provides excellent grounding safety
- Excellent compression and impact resistance.
- Continuous long lengths.
- Installation temperature of -40°C or °F.
- UL and American Bureau of Shipping Type approved as CWCMC Type MC.
- CSA Type RA90 complies with CEC Zone 2, Class II Div 2, Class III Div 1, Class III Div 2 Hazardous Locations.

C-L-X Type MC (XHHW-2)



Product Data Section 4: Sheet 14

600V Control Cable—Aluminum Sheath

600/1000V Marine Cable

Multiple Copper Conductors/90°C Wet or Dry Rating

For Cable Tray Use - Sunlight Resistant - For Direct Burial

Catalog Number	Conductor Size AWG	Number of Conductors	Insulation Thickness - mils	Core O.D. - Inches	Core O.D. - mm	C-L-X O.D. - Inches	C-L-X O.D. - mm	Jacket Thickness - mils	Jacket Thickness - mm	Approx. O.D. - Inches	Approx. O.D. - mm	Cross-Sectional Area (sq. in.) †	Approx. Net Weight lbs./1000'	Approx. Ship Weight lbs./1000'	90°C Wet or Dry (1)	75°C Wet	NEC Ampacity			
546-31-3002	14(7X) (2.08mm ²)	2	0.28	7.1	0.49	12.3	50	1.27	0.60	15.1	0.28	142	174	15	15					
▲ 546-31-3003		3	0.30	7.6	0.49	12.4			0.60	15.2	0.32	153	185	15	15					
▲ 546-31-3004		4	0.33	8.4	0.53	13.5			0.64	16.3	0.36	181	214	15	15					
▲ 546-31-3005		5	0.37	9.4	0.58	14.7			0.69	17.5	0.41	210	242	15	15					
▲ 546-31-3007		7	0.41	10.4	0.62	15.7			0.73	18.5	0.46	254	309	15	14					
▲ 546-31-3009		9	0.50	12.7	0.71	18.0			0.82	20.8	0.57	308	363	15	14					
*▲ 546-31-3012		12	0.57	14.4	0.80	20.3			0.91	23.1	0.71	381	448	12	10					
*▲ 546-31-3019		19	0.69	17.5	0.93	23.6			1.04	26.4	0.84	537	604	12	10					
*▲ 546-31-3037		37	0.96	24.4	1.24	31.5			1.35	34.3	1.43	946	1036	10	8					
546-31-3082		12(7X) (3.31mm ²)	2	0.31	7.8	0.53			13.5	50	1.27	0.64	16.3	0.32	164	196	20	20		
▲ 546-31-3083			3	0.34	8.6	0.53			13.5			0.64	16.3	0.32	189	221	20	20		
▲ 546-31-3084			4	0.38	9.6	0.58			14.7			0.69	17.5	0.38	226	258	20	20		
▲ 546-31-3085	5		0.42	10.6	0.62	15.7	0.73	18.5	0.42			262	317	20	20					
▲ 546-31-3087	7		0.47	11.9	0.67	17.0	0.78	19.8	0.48			324	379	20	17					
▲ 546-31-3089	9		0.56	14.2	0.80	20.3	0.91	23.1	0.65			405	472	20	17					
*▲ 546-31-3092	12		0.65	16.5	0.89	22.6	0.99	25.4	0.79			503	570	15	12					
*▲ 546-31-3099	19		0.78	19.8	1.02	25.9	1.13	28.7	1.00			721	801	15	12					
*▲ 546-31-3117	37		1.08	27.4	1.37	34.8	1.48	37.6	1.72			1301	1444	12	10					
546-31-3162	10(7X) (5.26mm ²)		2	0.36	9.1	0.58	14.7	50	1.27			0.69	17.5	0.38	202	234	30	30		
▲ 546-31-3163			3	0.39	9.9	0.58	14.7					0.69	17.5	0.38	238	270	30	30		
▲ 546-31-3164			4	0.44	11.1	0.67	17.0					0.78	19.8	0.48	297	352	30	28		
546-31-3165		5	0.48	12.2	0.71	18.0	0.82			20.8	0.53	348	403	30	28					
▲ 546-31-3167		7	0.54	13.7	0.75	19.1	0.86			21.8	0.58	436	491	28	24					
546-31-3169		9	0.65	16.5	0.89	22.6	1.00			25.4	0.79	544	611	28	24					
546-31-3172*		12	0.74	18.8	0.97	24.6	1.08			27.4	0.85	684	751	20	17					

* These items are not CSA listed. CSA listing available as special order.

Visit Okonite's web site, www.okonite.com for the most up to date dimensions.

▲ **Authorized Stock Item** - Available from our Service Centers.

Copper or Bronze C-L-X - is available on special order.

† **Cross-sectional** area for calculation of cable tray fill in accordance with NEC Section 392.22.

Jackets - Optional jacket types available - consult local sales office.

(1) Ampacities

Ampacities are based on Table 310.15(B)(16) of the National Electrical Code for XHHW-2 conductors rated 90°C, in a multi-conductor cable, at an ambient temperature of 30°C (86F). The 75°C column is provided for additional information.

The ampacities shown apply to open runs of cable, installation in any approved raceway, direct burial in the earth, or as aerial cable on a messenger. Derating for more than three current carrying conductors within the cable is in accordance with NEC Section 310.15(B)(3)(a).

The ampacities shown also apply to cables installed in cable tray in accordance with NEC Section 392.80.

C-L-X Type MC (XHHW-2)



Product Data Section 4: Sheet 14

600V Control Cable — Aluminum Sheath

600/1000V Marine Cable

Multiple Copper Conductors /90°C Wet or Dry Rating

For Cable Tray Use - Sunlight Resistant - For Direct Burial

Conductor Color Coding Sequence

Conductor Number	Base Color	Tracer Color
1	Black	
2	Red	
3	Blue	
4	Orange	
5	Yellow	
6	Brown	
7	Red	Black
8	Blue	Black
9	Orange	Black
10	Yellow	Black
11	Brown	Black
12	Black	Red
13	Blue	Red
14	Orange	Red
15	Yellow	Red
16	Brown	Red
17	Black	Blue
18	Red	Blue
19	Orange	Blue
20	Yellow	Blue
21	Brown	Blue
22	Black	Orange
23	Red	Orange
24	Blue	Orange
25	Yellow	Orange
26	Brown	Orange
27	Black	Yellow
28	Red	Yellow
29	Blue	Yellow
30	Orange	Yellow
31	Brown	Yellow
32	Black	Brown
33	Red	Brown
34	Blue	Brown
35	Orange	Brown
36	Yellow	Brown
37	Black	

Color Coding per ICEA
Method 1, E-2

Special Order: Any or all of the following conductors may be added when specifically requested by the customer to meet his specific application requirements. These conductor codings comply with UL and NEC requirements.

<u>Purpose</u>	<u>Base Color</u>	<u>Tracer Color</u>
Equipment Grounding	Uninsulated Green Green	1 or more continuous yellow stripes
Grounded	White White White White White White	Black continuous stripe Red continuous stripe Blue continuous stripe Orange continuous stripe Brown continuous stripe Numeric printing



C-L-X[®] Type MC-HL (XHHW-2)

600V Control Cable — Aluminum Sheath

600/1000V Marine Cable

Multiple Copper Conductors/90°C Wet or Dry Rating

For Cable Tray Use - Sunlight Resistant - For Direct Burial

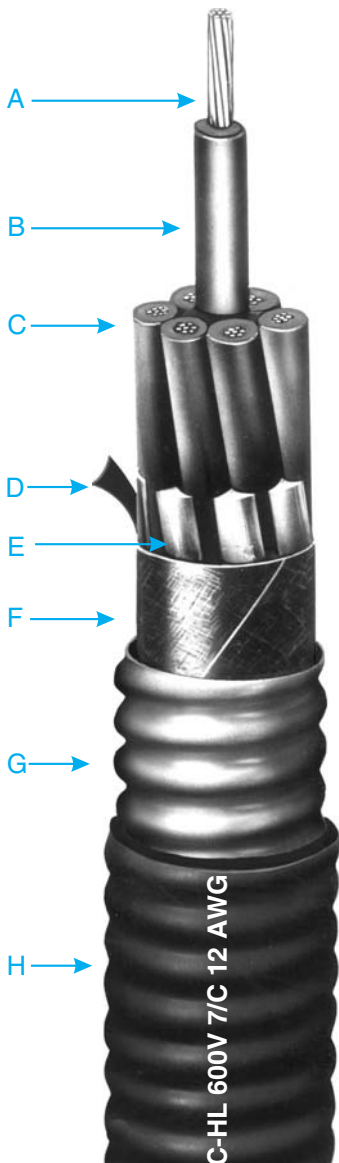

- A Bare, Stranded Copper Conductors
- B X-Olene Insulation - Color Coded for Identification
- C Stranded copper, green insulated grounding conductor
- D Marker Tape
- E Non-hygroscopic Fillers, as necessary
- F Binder Tape
- G Impervious, Continuous, Corrugated, Aluminum C-L-X Sheath
- H Black Okoseal Jacket

Insulation

X-Olene[®] is Okonite's trade name for its chemically cross-linked polyethylene, with high dielectric strength.

Color Coding

Conductors are color coded using base colors and tracers in accordance with the Conductor Identification Table on the back of this Data Sheet.

Assembly and Coverings

The individual conductors are cabled together with non-hygroscopic fillers and a binder tape overall. The C-L-X sheath exceeds the grounding conductor requirements of Table 250.122 of the NEC and UL1569.

The impervious, continuous, corrugated aluminum C-L-X sheath provides complete protection against moisture, liquids and gases and has excellent mechanical strength. For direct burial in the ground, embedment in concrete, or for areas subjected to corrosive atmospheres, the C-L-X sheath is protected with a low temperature black Okoseal[®] (PVC) jacket.

Applications

C-L-X Type MC cables with the impervious, continuous, corrugated aluminum sheath are recommended as an economical alternate to a wire in conduit system.

They are authorized for use on services, feeders and branch circuits for power, lighting, control and signaling circuits in accordance with Articles 330 and 725 of the NEC.

C-L-X Type MC-HL cables may be installed indoors or outdoors, in wet or dry locations, as open runs of cable secured to supports spaced not more than six feet apart, in cable tray, as aerial cable on a messenger, in any approved raceway, direct burial, or encased in concrete. C-L-X Type MC-HL cables are also approved for Classes I, II, and III Division 1 and 2 and Class I, Zones 1 and 2 hazardous locations per NEC Articles 501, 502, and 503 and UL 2225; in Zone Class II Div 2, Class III Div 1 and Class III Div 2 per CEC.

Specifications

Conductors: Bare soft annealed copper, Class B stranding per ASTM B-8.

Insulation: X-Olene per ICEA S-73-532 and UL 44, Listed UL Type XHHW-2. Meets MIL-DTL-1377H, section 4.8.4.1.2, cold bend at -66°C and ASTM D746-04 brittle point at -40°C.

Conductor Identification: Base Colors and tracers.

Grounding Conductor: Green insulated stranded copper per ASTM B-8, Class B. Meets or exceeds requirements of NEC Table 250.122.

Assembly: Per UL 1569 with binder tape overall.

Sheath: Close fitting, impervious, continuous, corrugated aluminum C-L-X per UL 1569.

Exceeds grounding conductor requirements of NEC Table 250.122.

Jacket: Black Okoseal (PVC) per UL requirements for Type MC-HL Cables. Meets ASTM D746-04 brittle point at -40°C.

Product Features

- UL Listed as Type MC-HL cable and Marine Shipboard Cable, E38916 (UL 1569) and E137931 (UL1309).
- UL Listed for cable tray use, direct burial and sunlight resistant.
- UL 1309 listed (CWCMC) & UL classified in accord with IEEE 1580 as Marine Shipboard Cable rated 600/1000V
- CSA C22.2 No. 123 listed as RA90, FT4, HL and LTGG (-40°C).
- Passes the IEEE 383-1974 and IEEE 1202 vertical tray flame tests.
- Passes the 210,000 BTU/hr ICEA T-29-520 Vertical Tray Flame Test.
- Complete pre-packaged, factory-tested wiring system — color coded.
- C-L-X cables are quality control inspected to meet or exceed applicable UL standards.
- 90°C continuous operating temperature in all types of installations.
- 130°C emergency rating
- 250°C short circuit rating.
- Good EMI shielding characteristics.
- Impervious, continuous metallic sheath excludes moisture, gasses and liquids.
- Lower installed system cost than conduit or EMT systems.
- Provides excellent grounding safety.
- Excellent compression and impact resistance.
- Continuous long lengths.
- Installation temperature of -40°C or °F.
- Complies with NEC Articles 501, 502 and 503 for hazardous locations.
- UL and American Bureau of Shipping listed as CWCMC Type MC-HL.
- CSA Type RA 90-HL complies with CEC Zone 1, Zone 2, Class II Div 2, Class III Div 1 and Class III Div 2 Hazardous Locations.

C-L-X Type MC-HL (XHHW-2)



Product Data Section 4: Sheet 15

600V Control Cable—Aluminum Sheath

600/1000V Marine Cable

Multiple Copper Conductors/90°C Wet or Dry Rating

For Cable Tray Use - Sunlight Resistant - For Direct Burial

Catalog Number	Conductor Size AWG	Number of Ungrounded	Green Insulated Grounding Conductor AWG	Core O.D. - Inches	Core O.D. - mm	C-L-X O.D. - Inches	C-L-X O.D. - mm	Jacket Thickness - mils	Jacket Thickness - mm	Approx. O.D. - Inches	Approx. O.D. - mm	Cross-Sectional Area (sq. in.) †	Approx. Net Weight lbs./1000	Approx. Ship Weight lbs./1000	90°C Wet or Dry (1)	75°C Wet NEC Ampacity							
▲ 546-31-3402	14(7X) (2.08mm ²)	2	#14 (7X)	0.30	7.6	0.49	12.4	50	1.27	0.60	15.2	0.28	163	202	15	15							
▲ 546-31-3406		6		0.41	10.4	0.62	15.8										0.73	18.5	0.42	267	347	15	14
▲ 546-31-3408		8		0.49	12.4	0.71	18.0										0.82	20.8	0.53	321	401	15	14
*▲ 546-31-3411		11		0.57	14.5	0.80	20.3																
*▲ 546-31-3418		18		0.69	17.5	0.93	23.6										1.04	26.4	0.85	554	634	12	10
*▲ 546-31-3436		36		0.97	24.6	1.24	31.5										1.35	34.3	1.43	948	1038	10	8
▲ 546-31-3452	12(7X) (3.31mm ²)	2	#12 (7X)	0.34	8.6	0.53	13.5	50	1.27	0.64	16.3	0.32	200	239	20	20							
▲ 546-31-3456		6		0.47	11.9	0.67	17.0										0.78	19.7	0.48	338	418	20	17
▲ 546-31-3458		8		0.56	14.2	0.80	20.3										0.91	23.1	0.65	426	506	20	17
*▲ 546-31-3461		11		0.65	16.5	0.89	22.6																
*▲ 546-31-3468		18		0.78	19.8	1.02	25.9										1.13	28.7	1.00	739	819	15	12
*▲ 546-31-3486		36		1.10	27.9	1.37	34.8										1.48	37.6	1.72	1302	1445	12	10
▲ 546-31-3502	10(7X) (5.26mm ²)	2	#10 (7X)	0.39	9.9	0.58	14.7	50	1.27	0.69	17.5	0.37	253	292	30	30							
▲ 546-31-3506		6		0.54	13.7	0.75	19.1										0.86	21.8	0.58	451	531	28	24
▲ 546-31-3508		8		0.65	16.5	0.89	22.6										1.00	25.4	0.79	568	648	28	24
*▲ 546-31-3511		11		0.75	19.1	0.97	24.6			1.08	27.4	0.92	704	784	20	17							

* These items are not CSA listed. CSA listing available as special order.

Visit Okonite's web site, www.okonite.com for the most up to date dimensions.

▲ **Authorized Stock Item** - Available from our Service Centers.

Copper Or Bronze C-L-X is available on special order.

† **Cross-sectional** area for calculation of cable tray fill in accordance with NEC Section 392.22.

Jacket - Optional jacket types available - consult local sales office.

(1) **Ampacities** are based on 310.15(B)(16) of the National Electrical Code for XHHW-2 conductors rated 90°C, in a multi-conductor cable, at an ambient temperature of 30°C (86°F). The 75°C column is provided for additional information.

The ampacities shown apply to open runs of cable, installation in any approved raceway, direct burial in the earth, or as aerial cable on a messenger. Derating for more than three current carrying conductors within the cable is in accordance with NEC Section 310.15(B)(3)(a).

The ampacities shown also apply to cables installed in cable tray in accordance with NEC Section 392.80.

C-L-X Type MC-HL (XHHW-2)

600V Control Cable — Aluminum Sheath

600/1000V Marine Cable

Multiple Copper Conductors /90°C Wet or Dry Rating

For Cable Tray Use - Sunlight Resistant - For Direct Burial



Product Data Section 4: Sheet 15

Conductor Color Coding Sequence

Ungrounded Conductor Number	Base Color	Tracer Color
1	Black	
2	Red	
3	Blue	
4	Orange	
5	Yellow	
6	Brown	
7	Red	Black
8	Blue	Black
9	Orange	Black
10	Yellow	Black
11	Brown	Black
12	Black	Red
13	Blue	Red
14	Orange	Red
15	Yellow	Red
16	Brown	Red
17	Black	Blue
18	Red	Blue
19	Orange	Blue
20	Yellow	Blue
21	Brown	Blue
22	Black	Orange
23	Red	Orange
24	Blue	Orange
25	Yellow	Orange
26	Brown	Orange
27	Black	Yellow
28	Red	Yellow
29	Blue	Yellow
30	Orange	Yellow
31	Brown	Yellow
32	Black	Brown
33	Red	Brown
34	Blue	Brown
35	Orange	Brown
36	Yellow	Brown
37	Black	

Color Coding per ICEA Method 1, E-2

Special Order: Any or all of the following conductors may be added when specifically requested by the customer to meet his specific application requirements. These conductor codings comply with UL and NEC requirements.

<u>Purpose</u>	<u>Base Color</u>	<u>Tracer Color</u>
Equipment Grounding	Uninsulated Green Green	1 or more continuous yellow stripes
Grounded	White White White White White White	Black continuous stripe Red continuous stripe Blue continuous stripe Orange continuous stripe Brown continuous stripe White stripe Numeric printing



Type P-OS

Type ITC/PLTC Instrumentation Cable

Single Pair or Triad - Overall Shield
300 Volts - 105°C Rating



For Cable Tray Use



- A Bare Stranded Copper Conductor
- B Okoseal Insulation
- C Twisted Pair/Triad
- D Tinned Stranded Copper Drain Wire
- E Aluminum/Polyester Tape
- F Rip Cord
- G Black Okoseal Jacket

Specifications

Conductors: Bare soft annealed copper, Class B, 7-strand concentric per ASTM B-8.

Insulation: Flame-retardant Okoseal® (PVC) per UL 13 and UL 2250, 15 mils nominal thickness, 105°C temperature rating.

Conductor Identification: Pigmented black and white in pairs, black, red and white in triads.

Assembly: Pair or triad assembled with left-hand lay.

Cable Shield: Aluminum/synthetic polymer tape overlapped to provide 100% coverage, and a 7-strand tinned copper drain wire, same size as conductor.

Jacket: Black, flame-retardant, low temperature Okoseal per UL 13 and UL 2250. A rip cord is laid longitudinally under the jacket to facilitate removal.

Classifications

UL Listed as ITC/PLTC — Instrument Tray Cable/Power Limited Tray Cable for use in accordance with Article 727 and Article 725 of the National Electrical Code.

These cables comply with UL 2250 and UL 13 for PLTC, CL2, and CL3.

Applications

Okonite type P-OS (Pair/Triad - Overall Shield) instrumentation cables are designed for use as instrumentation, process control, and computer cables in ITC non-classified or labeled circuits up to 150 volts and 5 amps (750VA) and in Class 2 or 3 Power-Limited circuits where shielding against external interference is required, but shielding against interference among groups is not required; indoors or outdoors; in wet or dry locations with conductor operating temperatures up to 105°C; in cable trays; in raceways; supported by a messenger wire. Suitable Class I, Division 2, Class II, Division 2, or Class III, Division 2 hazardous locations. Also for use

as Power-Limited fire protective signaling cable (FPL) per NEC Code 760.

The overall shield eliminates most of the static interference from the electric field radiated by power cables and other electrical equipment.

For dc service in wet locations, X-Olene® insulation is recommended.

Product Features

- Passes the UL 1581 & IEEE 383-1974 vertical tray flame tests.
- Sunlight resistant and oil resistant.
- Individual pairs or triads are color coded for simplified hook-up.
- Good noise rejection.
- Excellent weathering characteristics.
- OSHA Acceptable.
- Flexible, easy to handle and terminate.
- Twisted with 100% shield coverage to reduce electromagnetic noise pick-up.
- Suitable for low temperature installation of -40°C.

Type P-OS Type ITC/PLTC Instrumentation Cable

Single Pair or Triad - Overall Shield 300V - 105°C Rating
For Cable Tray Use



Product Data Section 5: Sheet 2

Okoseal Insulation 15 mils

Catalog Number	Conductor Size (AWG)	Number of Pairs	Number of Triads	Insulation Thickness (mils)	Jacket Thickness (mils)	Nominal Cable O.D. - (In.)	Cross-Sectional Area † (sq in)	Approx Net Weight (lbs/1000')	Approx Ship Weight (lbs/1000')
264-10-1101 264-15-1101	22	1	1	12	35	0.20 0.21	0.03 0.03	22 26	27 31
264-10-2201 264-15-2201	20	1	1	12		0.22 0.23	0.04 0.04	27 33	32 38
▲ 264-10-3301 ▲ 264-15-3301	18	1	1	15		0.23 0.24	0.05 0.05	35 43	40 48
▲ 264-10-4401 264-10-4901* ▲ 264-15-4401	16	1	1	15		0.25 0.25 0.26	0.05 0.05 0.06	47 47 58	52 52 59

* Tinned Copper Conductor

ELECTRICAL SPECIFICATIONS Per UL Standard 13 & 2250	
Conductor Resistance, nominalohms/1000 ft. @20°C
22 AWG 16.5
20 AWG 10.3
18 AWG 6.5
16 AWG 4.1
Insulation Test Voltage (spark test)5000 Volts ac
Dielectric Test Voltage 1500 Volts ac for 15 sec.
Insulation Resistance Constant @60°F minimum (natural material typical value)2000 Megohms-1000 ft.
Loop Resistance, nominal (2 conductor)	ohms-1000 ft @20°C
22 AWG 33.0
20 AWG 20.8
18 AWG 13.0
16 AWG 8.2
Mutual Capacitance (PF/ft.)*	
#22 34
#20 37
#18 41
#16 44

*Typical Value

▲ Authorized Stock Item: Available from our Customer Service Center.

† Cross-sectional area for calculation of cable tray fill in accordance with NEC Section 392-22

Length Tolerance: Cut lengths of 1000 feet or longer are subject to a tolerance of ± 10%; less than 1000 feet ± 15%.





C-L-X[®] Type P-OS

Type ITC/PLTC Armored Instrumentation Cable

Single Pair or Triad - Overall Shield

300 Volts - 105°C Rating

For Cable Tray Use

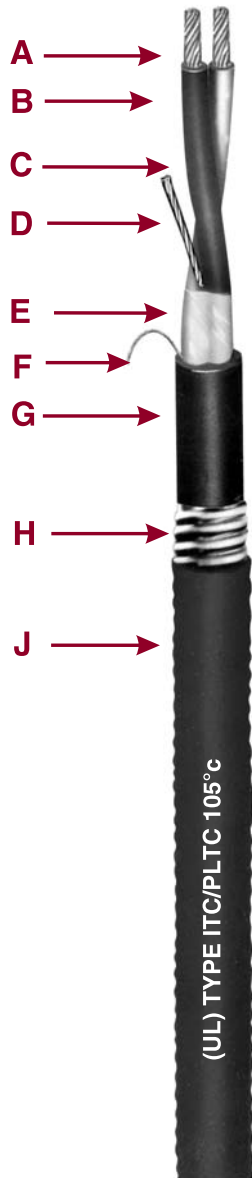

- A Bare Stranded Copper Conductor
- B Okoseal Insulation
- C Twisted Pair/Triad
- D Tinned Stranded Copper Drain Wire
- E Aluminum/Polyester Tape
- F Rip Cord
- G Inner Black Okoseal Jacket
- H Impervious, Continuous Corrugated Aluminum C-L-X Sheath
- J Outer Black Okoseal Jacket

Specifications

Conductors: Bare soft annealed copper, Class B, 7-strand concentric per ASTM B-8.

Insulation: Flame-retardant Okoseal[®] (PVC) per UL Standard 13 and UL 2250, 15 mils nominal thickness, 105°C temperature rating.

Conductor Identification: Pigmented black and white in pairs, black, red and white in triads.

Assembly: Pair or triad assembled with left-hand lay.

Cable Shield: Aluminum/Polyester tape overlapped to provide 100% coverage, and a #18 AWG, 7-strand tinned copper drain wire.

Inner Jacket: Black, flame-retardant Okoseal per UL 13 and UL Standard 2250. A rip cord is laid longitudinally under the jacket to facilitate removal.

C-L-X Sheath: A close-fitting, impervious, continuously welded and corrugated aluminum sheath provides complete protection against moisture, liquids, and gases, has excellent mechanical strength and provides equipment grounding through the sheath.

Outer Jacket: Black, flame-retardant Okoseal per UL 13 and UL Standard 2250.

Classifications

UL Listed as ITC/PLTC — Instrument Tray Cable/Power Limited Tray Cable for use in accordance with Article 727 and Article 725 of the National Electrical Code.

These cables comply with UL 2250 and UL 13 for PLTC, CL2 and CL3.

Applications

Okonite Type C-L-X P-OS (Pair/Triad - Overall Shield) instrumentation cables are designed for use as instrumentation, process control, and computer cables in ITC non-classified or labeled circuits up to 150 volts and 5 amps (750VA) and in Class 2 or 3 Power-Limited circuits where shielding against external interference is required, but shielding against interference among groups is not required; indoors or outdoors; in wet or dry locations with conductor operating temperatures up to 105°C; in cable trays; in raceways; supported by a messenger wire; under raised floors; for direct burial. Suitable Class I, Division 2, and Class I, Zone 2 Class II, Division 2, or Class III, Division 2 and Class I, Zone 2 hazardous locations. Also for use as Power-Limited fire protective signaling cable (FPL) per NEC Code 760. The C-L-X sheath

provides physical protection against mechanical damage. It may be installed in both exposed and concealed work, secured to supports not greater than 6 feet apart.

The overall shield eliminates most of the static interference from the electric field radiated by power cables and other electrical equipment.

For dc service in wet locations, X-Olene[®] insulation is recommended.

Product Features

- Passes the UL 1581, IEEE 383-1974, and IEEE 1202 vertical tray flame tests.
- Passes the 210,000 BTU/hr vertical tray flame test per ICEA T-29-520.
- UL listed as sunlight resistant.
- UL listed for direct burial.
- Complete pre-packaged, factory-tested wiring system-color coded.
- C-L-X enclosure permits installation in cable tray containing light and power cables without a barrier separator.
- Individual pairs or triads are color coded for simplified hook-up.
- Maximum noise rejection.
- Impervious, continuous sheath excludes moisture, gases and liquids.
- C-L-X sheath exceeds equipment grounding conductor requirements of NEC Article 250-118.
- Excellent compression and impact resistance.
- Lower installed system cost than conduit or EMT systems.
- OSHA Acceptable.
- Meets API Standards 14F and 14FZ.
- Suitable for low temperature installation of -40°C.

C-L-X Type P-OS

Type ITC/PLTC Armored Instrumentation Cable

Single Pair or Triad - Overall Shield 300V - 150°C Rating
For Cable Tray Use

Product Data

Section 5: Sheet 3



Conductors: 16 AWG
Okoseal Insulation: 15 mils

Catalog Number	Number of Pairs	Number of Triads	Inner Jacket Thickness-mils	Inner Jacket Nominal O.D. - Inches	Outer Jacket - (mils)	C-L-X O.D. - Inches	Nominal Cable O.D. - Inches	Cross-Sectional Area † (sq in)	Approx Net Weight (lbs/1000')	Approx Ship Weight (lbs/1000')
▲ 564-10-3401	1	1	35	.26	50	.43	.54	.25	134	173
▲ 564-15-3401			35	.28	50	.43	.54	.25	155	194

ELECTRICAL SPECIFICATIONS Per UL Standard 13 & 2250

Conductor Resistance, nominalohms/1000 ft. @20°C
16 AWG..... 4.1
Insulation Test Voltage (spark test).....5000 Volts ac
Dielectric Test Voltage..... 1500 Volts
Insulation Resistance Constant @60°F minimum
(natural material typical value).....2000 Megohms-1000 ft.
Loop Resistance, nominal (2 conductor) ohms-1000 ft @20°C
16 AWG..... 8.2
Mutual Capacitance, typical76 PF/ft.

▲ **Authorized Stock Item:** Available from our Customer Service Center

† **Cross-sectional** area for calculation of cable tray fill in accordance with NEC Section 392.22.

Jackets- Optional jacket types available - consult local sales office.

Copper or bronze C-L-X available on special order.

To order C-L-X Type P-OS without the outer Okoseal jacket, change the sixth digit of the catalog number from 3 to 1, for example to order 1 pr. 16 AWG with a bare aluminum C-L-X, the catalog number would be 564-10-1401.

C-L-X products manufactured in the United States under license granted by Kabelmetal of Hanover, Germany.

Length Tolerance: Cut lengths of 1000 feet or longer are subject to a tolerance of ± 10%; less than 1000 feet ± 15%.





Type SP-OS

Type ITC/PLTC Instrumentation Cable

Multiple Shielded Pairs or Triads - Overall Shield
300 Volts - 105°C Rating



For Cable Tray Use

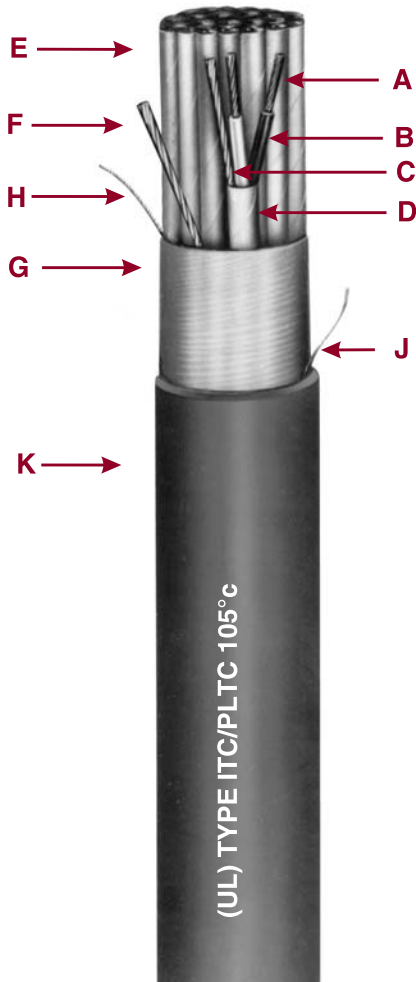

- A** Bare Stranded Copper Conductor
- B** Okoseal Insulation
- C** Tinned Stranded Copper Group Drain Wire
- D** Aluminum/Polyester Tape
- E** Twisted, Shielded Pairs/Triads
- F** Tinned Stranded Copper Drain Wire
- G** Aluminum/Polyester Tape
- H** Communication Wire
- J** Rip Cord
- K** Black Okoseal Jacket

Specifications

Conductors: Bare soft annealed copper, Class B, 7-strand concentric per ASTM B-8.

Insulation: Flame-retardant Okoseal® (PVC) per UL 13 and 2250, 15 mils nominal thickness, 105°C temperature rating.

Conductor Identification: Pigmented black and white in pairs, black, red and white in triads; white conductor numerically printed for group identification.

Group Shield: Aluminum/Polyester tape overlapped to provide 100% coverage, and a 7-strand tinned copper drain wire, two sizes smaller than the conductor. All group shields are completely isolated from each other.

Communications Wire: 22 AWG, solid, bare copper conductor, 12 mils nominal flame-retardant Okoseal insulation, 105°C rating.

Assembly: Pairs or triads assembled with a left-hand lay. Flame-retardant, non-wicking fillers included where required to provide a round cable.

Cable Shield: Aluminum/Polyester tape overlapped to provide 100% coverage, and a 7-strand tinned copper drain wire, same size as conductor.

Jacket: Black, flame-retardant, low temperature Okoseal per UL Subject 13 and 2250. A rip cord is laid longitudinally under the jacket to facilitate removal.

Classifications: UL Listed as ITC/PLTC - Instrument Tray Cable/Power Limited Tray Cable for use in accordance with Article 727 and Article 725 of the National Electrical Code.

Cables comply with UL 2250 and UL 13 for PLTC, CL2 and CL3.

Applications

Okonite® Type SP-OS (Pair/triad - Individual and Overall Shield) instrumentation cables are designed for use as instrumentation, process control, in ITC non-classified or labeled circuits up to 150 volts and 5 amps (750VA) and in Class 2 or 3 Power-Limited circuits where maximum shielding against external interference is required, as well as shielding among groups, particularly where the cable may be

subject to abnormally high current or voltage interference; indoors or outdoors; in wet or dry locations with conductor operating temperatures up to 105°C; in cable trays; in raceways; supported by a messenger wire; under raised floors. Suitable Class I, Division 2, Class II, Division 2, or Class III, Division 2 hazardous locations. Also for use as Power-Limited fire protective signaling cable (FPL) per NEC Code 760.

The isolated individual shields over each pair, when properly grounded, prevent crosstalk or capacitive coupling between adjacent pairs which occurs with ac signals, particularly the pulse type.

The overall shield eliminates most of the static interference from the electrical field radiated by power cables and other electrical equipment.

For dc service in wet locations, X-Olene® insulation is recommended.

Product Features

- Passes the UL 13 and IEEE 383-1974 vertical tray flame tests.
- Passes IEEE 1202 vertical tray flame test (8 pr #18 and 4 pr #16 & larger).
- Sunlight & oil resistant.
- Individual pairs or triads are completely isolated.
- 100% shield coverage for reduced electromagnetic noise pick-up.
- Good external noise rejection.
- Excellent weathering characteristics.
- OSHA Acceptable.
- Flexible, easy to handle and terminate.
- Communication wire included in each cable for voice communication during installation or instrument calibration.
- Suitable for low temperature installation of -40°C.

Type SP-OS Type ITC/PLTC Instrumentation Cable



Product Data Section 5: Sheet 13

Multiple Shielded Pairs or Triads - Overall Shield 300V - 105°C Rating
For Cable Tray Use

Okoseal Insulation: 15 mils

Catalog Number	Strand Size (AWG)	Insulation Thickness (mils)	Number of Pairs	Number of Triads	Jacket Thickness-mils	Nominal Cable O.D. - inches	Cross-Sectional Area † (sq in)	Approx Net Weight (lbs/1000')	Approx Ship Weight (lbs/1000')	
261-10-2202	20(7X)	15	2	40	0.35	0.10	63	74		
261-10-2204			4	50	0.42	0.15	103	126		
261-10-2206			6	50	0.51	0.20	138	161		
261-10-2208			8	50	0.53	0.25	169	193		
261-10-2210			10	60	0.66	0.34	219	258		
261-10-2212			12	60	0.66	0.37	248	287		
261-10-2216			16	60	0.76	0.45	311	350		
261-10-2220			20	60	0.82	0.53	374	413		
261-10-2224			24	70	0.90	0.69	457	521		
261-10-2236			36	70	1.06	0.88	632	696		
261-10-2250			50	70	1.23	1.19	845	951		
261-15-2204			4	50	0.48	0.18	126	149		
261-15-2208			8	50	0.62	0.30	212	236		
261-15-2212			12	60	0.77	0.47	314	353		
261-15-2216			16	60	0.79	0.49	397	436		
261-15-2224			24	70	0.99	0.77	587	651		
261-15-2236			36	70	1.11	0.97	825	905		
261-10-3302			18(7X)	15	2	50	0.38	0.11	89	112
▲ 261-10-3304					4	50	0.47	0.19	133	156
261-10-3306					6	50	0.57	0.25	181	205
▲ 261-10-3308	8	50			0.56	0.29	223	247		
261-10-3310	10	60			0.73	0.42	289	328		
▲ 261-10-3312	12	60			0.69	0.44	330	369		
261-10-3316	16	60			0.83	0.54	417	456		
261-10-3320	20	70			0.94	0.69	523	587		
▲ 261-10-3324	24	70			0.98	0.85	614	678		
▲ 261-10-3336	36	70			1.14	1.11	861	941		
261-10-3350	50	80			1.42	1.58	1188	1294		
▲ 261-15-3304	4	50			0.52	0.23	165	188		
▲ 261-15-3308	8	60			0.68	0.41	301	340		
▲ 261-15-3312	12	60			0.83	0.57	425	464		
261-15-3316	16	60			0.89	0.62	543	607		
261-15-3324	24	70			1.10	0.95	804	884		
261-15-3336	36	70			1.24	1.21	1143	1249		
▲ 261-10-4402	16(7X)	15			2	50	0.43	0.17	116	130
▲ 261-10-4404					4	50	0.51	0.23	179	203
261-10-4406					6	60	0.66	0.34	260	299
▲ 261-10-4408			8	60	0.68	0.40	323	362		
261-10-4410			10	60	0.82	0.53	397	436		
▲ 261-10-4412			12	60	0.81	0.57	456	520		
▲ 261-10-4416			16	70	0.94	0.75	600	664		
261-10-4420			20	70	1.06	0.88	729	809		
▲ 261-10-4424			24	70	1.10	1.07	860	940		
261-10-4436			36	80	1.37	1.47	1250	1356		
261-10-4450			50	80	1.57	1.93	1687	1830		
261-15-4404			4	50	0.55	0.26	227	251		
▲ 261-15-4408			8	60	0.74	0.48	418	457		
▲ 261-15-4412			12	70	0.93	0.74	615	679		
261-15-4416			16	70	1.02	0.82	788	852		
261-15-4424			24	80	1.27	1.27	1167	1273		
261-15-4436			36	80	1.43	1.61	1668	1784		

ELECTRICAL SPECIFICATIONS Per UL Subject 13 & 2250	
Conductor Resistance, nominalohms/1000 ft. @20°C
20 AWG 10.4
18 AWG 6.5
16 AWG 4.1
Insulation Test Voltage (spark test)5000 Volts ac
Dielectric Test Voltage1500 Volts ac for 15 sec.
Insulation Resistance Constant @60°F, minimum (natural material typical value) 2,000 Megohms-1000 ft.
Loop Resistance, nominal (2 conductor) ohms-1000 ft @20°C	
20 AWG 20.8
18 AWG 13.0
16 AWG 8.2
Mutual Capacitance (PF/ft.)*	
20 AWG 59
18 AWG 68
16 AWG 76
*Typical Value	

▲ Authorized Stock Item: Available from our Customer Service Center.

† Cross-sectional area for calculation of cable tray fill in accordance with NEC Section 392.22

Length Tolerance: Cut lengths of 1000 feet or longer are subject to a tolerance of ± 10%; less than 1000 feet ± 15%.



THE OKONITE COMPANY

Ramsey, New Jersey 07446



C-L-X[®] Type SP-OS

Type ITC/PLTC Armored Instrumentation Cable

Multiple Shielded Pairs or Triads - Overall Shield

300 Volts - 105°C Rating

For Cable Tray Use

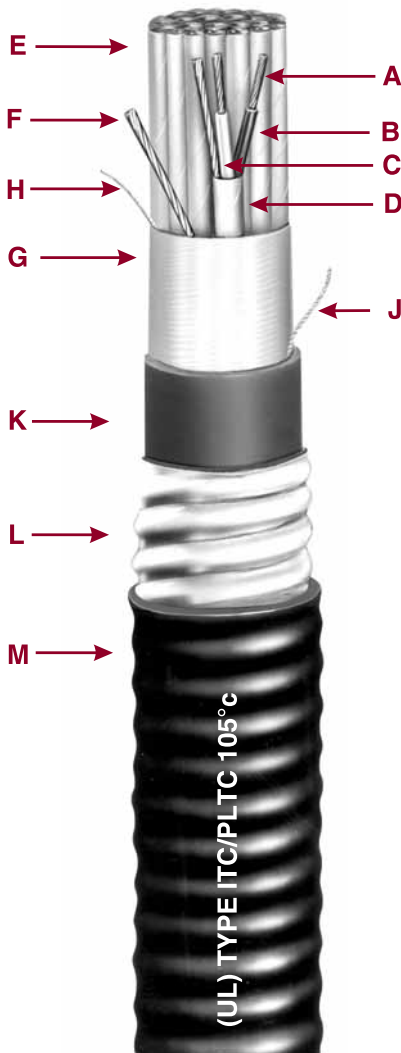

- A Bare Stranded Copper Conductor
- B Okoseal Insulation
- C Tinned Stranded Copper Group Drain Wire
- D Aluminum/Polyester
- E Twisted, Shielded Pairs/Triads
- F Communication Wire
- G Aluminum/Polyester
- H Tinned Stranded Copper Drain Wire
- J Rip Cord
- K Inner Black Okoseal Jacket
- L Impervious, Continuous, Corrugated Aluminum C-L-X Sheath
- M Outer Black Okoseal Jacket

Specifications

Conductors: Bare soft annealed copper, Class B, 7-strand concentric per ASTM B-8.

Insulation: Flame-retardant Okoseal[®] (PVC) per UL 13 and 2250, 15 mils nominal thickness, 105°C temperature rating.

Conductor Identification: Pigmented black and white in pairs, black, red and white in triads; white conductor numerically printed for group identification.

Group Shield: Aluminum/Polyester tape overlapped to provide 100% coverage, and a 7-strand tinned copper drain wire, two sizes smaller than the conductor. All group shields are completely isolated from each other.

Communications Wire: 22 AWG, solid, bare copper conductor, 12 mils nominal flame-retardant Okoseal insulation, 105°C temperature rating.

Assembly: Pairs or triads assembled with left-hand lay. Flame-retardant, non-wicking fillers included where required to provide a round cable.

Cable Shield: Aluminum/Polyester tape overlapped to provide 100% coverage, and a 7-strand tinned copper drain wire, same size as conductor.

Inner Jacket: Black, flame-retardant, low temperature Okoseal per UL 13 and 2250. A rip cord is laid longitudinally under the jacket to facilitate removal.

C-L-X Sheath: A close-fitting, impervious, continuously welded and corrugated, aluminum sheath provides complete protection against moisture, liquids, and gases, has excellent mechanical strength, and provides equipment grounding through the sheath.

Outer Jacket: Black, flame-retardant, low temperature Okoseal per UL 13 and 2250.

Classifications: UL Listed as ITC/PLTC - Instrument Tray Cable/Power Limited Tray Cable for use in accordance with Article 727 and Article 725 of the National Electrical Code.

Cables comply with UL 2250 and UL 13 for PLTC, CL2 and CL3.

Applications

C-L-X Type SP-OS (Pair/triad - Individual and Overall Shield) instrumentation cables are designed for use as instrumentation, process control, in ITC non-classified or labeled circuits up to 150 volts and 5 amps (750VA) and in Class 2 or 3 Power-Limited circuits where maximum shielding against external interference is required, as well as shielding among groups, particularly where the cable may be subject to abnormally high current or voltage interference; indoors or outdoors; in wet or dry locations with conductor operating temperatures up to 105°C; in cable trays; in raceways; supported by a

messenger wire; under raised floors or direct burial. Suitable in Class I & II, Division 2 or Class III, Division 2 and Class I, Zone 2 hazardous locations. Also for use as Power-Limited fire protective signaling cable (FPL) per NEC Code 760. It may be installed in both exposed and concealed work, secured to supports not greater than 6 feet apart.

The isolated individual shields over each pair, when properly grounded, prevent crosstalk or capacitive coupling between adjacent pairs which occurs with ac signals, particularly the pulse type.

The overall shield eliminates most of the static interference from the electric field radiated by power cables and other electrical equipment. The C-L-X sheath provides physical protection against mechanical damage as well as complete protection against moisture or gases entering the cable.

For dc service in wet locations X-Olene[®] insulation is recommended.

Product Features

- Passes the UL 13, IEEE 383-1974 vertical tray flame tests.
- Passes the IEEE 1202 vertical tray flame test (2 pr #18 AWG and larger).
- Passes the 210,000 BTU/hr vertical tray flame test per ICEA T-29-520.
- UL listed for direct burial (2 PR #20 AWG and larger)
- Complete pre-packaged, factory-tested wiring system-color coded.
- C-L-X enclosure permits installation in cable tray containing light and power cables without a barrier separator.
- Individual pairs or triads are completely isolated.
- Impervious, continuous sheath excludes moisture, gases and liquids.
- C-L-X sheath exceeds equipment grounding conductor requirements of NEC Article 250-118.
- Lower installed system cost than conduit or EMT systems.
- Meets API Standards 14F & 14FZ.
- Suitable for low temperature installation to -40°C.

C-L-X Type SP-OS Type ITC/PLTC Armored Instrumentation Cable



Product Data Section 5: Sheet 14

Multiple Shielded Pairs or Triads - Overall Shield 300V - 105°C Rating
For Cable Tray Use

Okoseal Insulation: 15 mils

Catalog Number	Strand Size (AWG)	Number of Pairs	Number of Triads	Inner Jacket Thickness - mils	Nominal Core O.D. (In.)	C-L-X O.D. (In.)	Outer Jacket mils	Nominal Cable O.D. - (In.)	Cross-Sectional Area † (sq in)	Approx Net Weight (lbs/1000')	Approx Ship Weight (lbs/1000')
561-10-3202	2	40	0.36	0.58	50	0.69	.37	198	217		
561-10-3204	4	50	0.43	0.62	50	0.73	.42	234	314		
561-10-3206	6	50	0.48	0.71	50	0.82	.53	286	366		
561-10-3208	8	50	0.53	0.75	50	0.86	.58	317	397		
561-10-3210	10	50	0.57	0.80	50	0.91	.65	393	473		
561-10-3212	12	60	0.63	0.84	50	1.95	.71	430	510		
561-10-3216	16	60	0.72	0.97	50	1.08	.92	501	581		
561-10-3220	20	60	0.81	1.06	50	1.17	1.08	581	661		
561-10-3224	24	70	0.90	1.15	50	1.26	1.25	704	794		
561-10-3236	36	70	1.04	1.34	50	1.45	1.65	907	1013		
561-10-3250	50	70	1.19	1.51	60	1.65	2.14	1230	1373		
561-15-3204	4	50	0.45	0.67	50	0.78	.48	258	338		
561-15-3208	8	50	0.56	0.80	50	0.91	.65	369	439		
561-15-3212	12	60	0.67	0.89	50	1.00	.79	504	584		
561-15-3216	16	60	0.77	1.02	50	1.13	1.00	604	684		
561-15-3224	24	70	0.96	1.24	50	1.35	1.43	852	958		
561-15-3236	36	70	1.11	1.42	50	1.53	1.84	1117	1260		
▲ 561-10-3302	2	40	0.38	0.58	50	0.69	0.37	212	292		
▲ 561-10-3304	4	50	0.49	0.71	50	0.82	0.53	273	353		
561-10-3306	6	50	0.55	0.75	50	0.86	0.58	338	418		
▲ 561-10-3308	8	50	0.60	0.80	50	0.92	0.65	389	469		
561-10-3310	10	60	0.67	0.89	50	1.00	0.79	479	559		
▲ 561-10-3312	12	60	0.71	0.93	50	1.04	0.85	529	609		
561-10-3316	16	60	0.79	1.06	50	1.17	1.08	632	738		
561-10-3320	20	60	0.88	1.15	50	1.26	1.25	778	868		
▲ 561-10-3324	24	70	0.98	1.24	50	1.35	1.43	889	995		
561-10-3336	36	70	1.15	1.47	50	1.58	1.96	1203	1346		
561-10-3350	50	80	1.36	1.69	60	1.82	2.60	1629	1812		
561-15-3304	4	50	0.54	0.75	50	0.86	.58	314	394		
561-15-3308	8	60	0.69	0.93	50	1.04	.85	475	555		
561-15-3312	12	60	0.79	1.06	50	1.17	1.08	632	712		
561-15-3316	16	70	0.90	1.15	50	1.26	1.25	781	861		
561-15-3324	24	70	1.06	1.34	50	1.45	1.65	1097	1240		
561-15-3336	36	80	1.29	1.60	60	1.73	2.35	1539	1682		
▲ 561-10-3402	2	50	0.44	0.67	50	0.78	0.48	255	336		
▲ 561-10-3404	4	50	0.52	0.71	50	0.82	0.53	327	407		
561-10-3406	6	50	0.59	0.84	50	0.95	0.71	434	514		
▲ 561-10-3408	8	60	0.69	0.93	50	1.04	0.85	505	585		
561-10-3410	10	60	0.75	1.02	50	1.13	1.00	604	684		
▲ 561-10-3412	12	60	0.81	1.06	50	1.17	1.08	671	777		
561-10-3416	16	70	0.95	1.24	50	1.35	1.43	855	945		
561-10-3420	20	70	1.03	1.34	50	1.45	1.65	1004	1101		
▲ 561-10-3424	24	70	1.10	1.37	50	1.48	1.72	1245	1388		
561-10-3436	36	80	1.29	1.60	60	1.73	2.35	1678	1842		
561-10-3450	50	80	1.53	1.87	60	2.00	3.14	2172	2428		
▲ 561-15-3404	4	50	0.58	0.80	50	0.91	0.65	384	464		
▲ 561-15-3408	8	60	0.79	1.02	50	1.13	1.00	609	689		
▲ 561-15-3412	12	70	0.95	1.19	50	1.30	1.33	862	952		
561-15-3416	16	70	1.04	1.34	50	1.45	1.65	1053	1159		
561-15-3424	24	80	1.27	1.60	60	1.73	2.35	1574	1738		
561-15-3436	36	80	1.49	1.83	60	1.96	3.02	2119	2306		

ELECTRICAL SPECIFICATIONS	
Conductor Resistance, nominalohms/1000 ft. @20°C
20 AWG.....	10.4
18 AWG.....	6.5
16 AWG.....	4.1
Insulation Test Voltage (spark test).....	5000 Volts ac
Dielectric Test Voltage.....	1500 Volts ac for 15 sec.
Insulation Resistance Constant @60°F minimum (natural material typical value).....	2000 Megohms-1000 ft.
Loop Resistance, nominal (2 conductor) ohms-1000 ft @20°C	
20 AWG.....	20.8
18 AWG.....	13.0
16 AWG.....	8.2
Mutual Capacitance (PF/ft.)*	
#20.....	59
#18.....	68
#16.....	76

*Typical Value

▲ Authorized Stock Item: Available from our Customer Service Center.

Jackets - Optional jacket types available - consult local sales office.

† Cross-sectional area for calculation of cable tray fill in accordance with NEC Section 392.22.

Copper or bronze C-L-X available on special order. To order C-L-X Type SP-OS without the outer Okoseal jacket, change the sixth digit of the catalog number from 3 to 1. For example, to order 12 pr. 20 AWG with a bare aluminum C-L-X, the catalog number would be 561-10-1212.

C-L-X products manufactured in the United States under license granted by Kabelmetal of Hannover, Germany.

Length Tolerance: Cut lengths of 1000 feet or longer are subject to a tolerance of ± 10%; less than 1000 feet ± 15%.



Type P-OS

Type ITC/PLTC Thermocouple Extension Cable

Single Pair - Overall Shield - 105°C Rating
For Cable Tray Use



- A Solid Thermocouple Alloy Conductor
- B Okoseal Insulation
- C Twisted Pair/Triad
- D Tinned Stranded Copper Drain Wire
- E Aluminum/Polyester Tape
- F Rip Cord
- G Okoseal Jacket

Specifications

Conductors: Solid alloys per ANSI MC 96.1

Insulation: Flame-retardant Okoseal® (PVC) per UL Standard 13 and 2250, 15 mils nominal thickness, 105°C temperature rating.

Conductor Identification: Pigmented insulation on individual conductors.

Assembly: Pair assembled with left-hand lay.

Cable Shield: Aluminum/Polyester tape overlapped to provide 100% coverage, and a 7-strand tinned copper drain wire, same size as conductor.

Jacket: Flame-retardant, low temperature Okoseal per UL Standard 13 and 2250. A rip cord is laid longitudinally under the jacket to facilitate removal.

Classifications: UL Listed as Type ITC/PLTC - Instrumentation Tray Cable/Power Limited Tray Cable, for use in accordance with Article 727 and 725 of the National Electrical Code.

Cables comply with UL 2250 and UL Subject 13 for PLTC, CL2 and CL3.

Applications

Okonite Type P-OS (Pair/triad - Overall Shield) thermocouple extension cables are designed for use as instrumentation and process control cables in ITC non-classified or labeled circuits up to 150 volts and 5 amps (750VA) and in Class 2 of 3 Power-Limited circuits where shielding against external interference is required, but shielding against interference among groups is not required; indoors or outdoors; in wet or dry locations with conductor operating temperatures up to 105°C; in cable trays; in raceways; supported by a

messenger wire; under raised floors; for direct burial. Suitable Class I, Division 2, Class II, Division 2, or Class III, Division 2 hazardous locations.

Product Features

- Passes the UL 1581 & IEEE 383-1974 vertical tray flame tests.
- Sunlight resistant & oil resistant.
- UL listed for direct burial.
- Individual pairs or triads are color coded for simplified hook-up.
- Good noise rejection.
- Excellent weathering characteristics.
- OSHA Acceptable.
- Flexible, easy to handle terminate.
- Twisted with 100% shield coverage to reduce electromagnetic noise.
- Suitable for low temperature installation of -40°C.

Type P-OS

Type ITC/PLTC Thermocouple Extension Cable

Single Pair - Overall Shield - 105°C Rating
For Cable Tray Use

Product Data

Section 5: Sheet 18



Conductors: 16 AWG
Okoseal Insulation: 15 mils

ASA/ISA Type	Catalog Number	Number of Pairs	Jacket Thickness (mils)	Nominal Cable O.D. - (in.)	Cross-Sectional Area † (sq in)	Approx Net Weight (lbs/1000')	Approx Ship Weight (lbs/1000')
EX	▲ 284-20-1401	1	35	.24	.05	44	49
JX	▲ 284-20-2401	1	35	.24	.05	44	49
KX	▲ 284-20-3401	1	35	.24	.05	44	49
TX	284-20-4401	1	35	.24	.05	44	49

ASA/ISA COLOR CODE AND LIMITS OF ERROR									
ASA/ISA Type	Positive Wire		Negative Wire		Outer Jacket Color	Temperature Range°C	Limits of Error		Nom. Loop Resistance Per 100' @ 20°C
	Alloy	Color	Alloy	Color			Standard	Special (1)	
EX	Chromel	Purple	Constantan	Red	Purple	0 to 200°C	± 1.7°C		27.8 ohms
JX	Iron	White	Constantan	Red	Black	0 to 200°C	± 2.2°C	± 1.1°C	13.9 ohms
KX	Chromel	Yellow	Alumel	Red	Yellow	0 to 200°C	± 2.2°C		23.6 ohms
TX	Copper	Blue	Constantan	Red	Blue	-60 to 100°C	± 1.0°C	± 0.5°C	12.0 ohms

▲ Authorized Stock Item: Available from our Customer Service Center.

SX available upon request.

(1) Special grade alloy conductors for JX and TX are available on special order.

† Cross-sectional area for calculation of cable tray fill in accordance with NEC Section 392.22

ELECTRICAL SPECIFICATIONS Per UL Standard 13 and 2250	
Insulation Test Voltage (spark test).....	5000 Volts ac
Dielectric Test Voltage.....	1500 Volts ac for 15 sec.
Shield Isolation Test	
Pair to Cable Shield.....	exceeds 100M ohms/1000 ft.
Insulation Resistance Constant @60°F minimum (natural material typical value).....	
	2000 Megohms-1000 ft.



C-L-X[®] Type P-OS Type ITC/PLTC Armored Thermocouple Extension Cable



Single Pair - Overall Shield - 105°C Rating
For Cable Tray Use

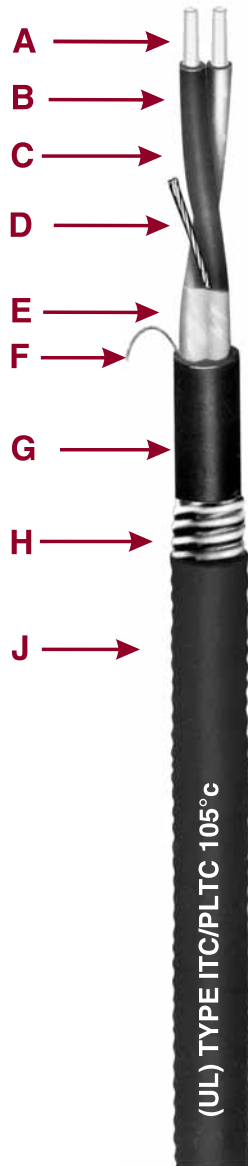

- A** Solid Thermocouple Alloy Conductor
- B** Okoseal Insulation
- C** Twisted Pair
- D** Tinned Stranded Copper Drain Wire
- E** Aluminum/Polyester Tape
- F** Rip Cord
- G** Inner Okoseal Jacket
- H** Impervious, Continuous, Corrugated Aluminum C-L-X Sheath
- J** Outer Okoseal Jacket

Specifications

Conductors: Solid alloys per ANSI MC 96.1.

Insulation: Flame-retardant Okoseal[®] (PVC) per UL Standard 13 and 2250, 15 mils nominal thickness, 105°C temperature rating.

Conductor Identification: Pigmented insulating on individual conductors.

Assembly: Pairs assembled with left-hand lay

Cable Shield: Aluminum/Polyester backed tape overlapped to provide 100% coverage, and a 7-strand tinned copper drain wire, same size as the conductor.

Inner Jacket: Black, flame-retardant, low temperature Okoseal per UL Standard 13 and 2250. A rip cord is laid longitudinally under the jacket to facilitate removal.

C-L-X Sheath: Close fitting, impervious, continuously welded and corrugated aluminum sheath provides complete protection against moisture, liquids, and gases, has excellent mechanical strength and provides equipment grounding through the sheath.

Outer Jacket: Flame-retardant, low temperature Okoseal per UL Standard 13 and 2250.

Classifications: UL Listed as Type ITC/PLTC - Instrumentation Tray Cable/Power Limited Tray Cable, for use in accordance with Article 727 and 725 of the National Electrical Code.

Cables comply with UL 2250 and UL Subject 13 for PLTC, CL2 and CL3.

Applications

Okonite Type C-L-X P-OS (Pair/triad - Overall Shield) Thermocouple Extension cables are designed for use as instrumentation and process control cables in ITC non-classified or labeled circuits up to 150 volts and 5 amps (750VA) and in Class 2 or 3 Power-Limited circuits where shielding against external interference is required, but shielding against interfer-

ence among groups is not required; indoors or outdoors; in wet or dry location with conductor operating temperatures up to 105°C; in cable trays; in raceways; supported by a messenger wire; under raised floors; for direct burial. Suitable Class I, Division 2, Class II, Division 2, or Class III, Division 2 and Class I, Zone 2 hazardous locations. The C-L-X sheath provides physical protection against mechanical damage. It may be installed in both exposed and concealed work, secured to supports not greater than 6 feet apart.

Product Features

- Passes the UL 1581, IEEE 383-1974, & IEEE 1202 vertical tray flame tests.
- Passes the 210,000 BTU/hr vertical tray flame test per ICEA T-29-520.
- Complete pre-packaged, factory-tested wiring system-color coded.
- C-L-X cables are quality control inspected to meet or exceed applicable UL Standards.
- C-L-X enclosure permits installation in cable tray containing light and power cables without a barrier separator.
- Individual pairs or triads are color coded for simplified hook-up.
- Impervious, continuous sheath excludes moisture, gases and liquids.
- C-L-X sheath exceeds equipment grounding conductor requirements of NEC Section 250-118.
- Lower installed system cost than conduit or EMT systems.
- Meets API Standards 14F and 14FZ.
- UL listed for direct burial
- Suitable for low temperature installation of -40°C

C-L-X Type P-OS

Type ITC/PLTC Armored Thermocouple Extension Cable

Single Pair - Overall Shield - 105°C Rating
For Cable Tray Use



Product Data

Section 5: Sheet 19

Conductors: 16 AWG
Okoseal Insulation: 15 mils

ASA/ISA Type	Catalog Number	Number of Pairs	Inner Jacket Thickness - mils	Inner Jacket Nominal O.D. - Inches	C-L-X O.D. - Inches	Outer Jacket - mils	Nominal Cable O.D. - (In.)	Cross-Sectional Area (sq in) †	Approx Net Weight (lbs/1000')	Approx Ship Weight (lbs/1000')
EX	584-20-1401	1	.35	.43	50	.54	.23	128	167	
JX	584-20-2401	1	.35	.43	50	.54	.23	128	167	
KX	▲ 584-20-3401	1	.35	.43	50	.54	.23	128	167	
TX	584-20-4401	1	.35	.43	50	.54	.23	128	167	

ASA/ISA COLOR CODE AND LIMITS OF ERROR

ASA/ISA Type	Positive Wire		Negative Wire		Outer Jacket Color	Temperature Range °C	Limits of Error		Nom. Loop Resistance Per 100' @ 20°C
	Alloy	Color	Alloy	Color			Standard	Special (1)	
EX	Chromel	Purple	Constantan	Red	Purple	0 to 200°C	± 1.7°C		27.8 ohms
JX	Iron	White	Constantan	Red	Black	0 to 200°C	± 2.2°C	± 1.1°C	13.9 ohms
KX	Chromel	Yellow	Alumel	Red	Yellow	0 to 200°C	± 2.2°C		23.6 ohms
TX	Copper	Blue	Constantan	Red	Blue	-60 to 100°C	± 1.0°C	± 0.5°C	12.0 ohms

▲ **Authorized Stock Item:** Available from our Customer Service Centers.

SX available upon request.

(1) Special grade alloy conductors for JX and TX are available on special order.

† **Cross-sectional** area for calculation of cable tray fill in accordance with NEC Section 392.22.

Jackets - Optional jacket types available - consult local sales office.

Copper or bronze C-L-X available on special order.

To order C-L-X Type P-OS without the outer Okoseal jacket, change the sixth digit of the catalog number from 1 to 5 for EX, 2 to 6 for JX, 3 to 7 for KX, and 4 to 8 for TX. For example to order 12 pr. 20 AWG Type KX with a bare aluminum C-L-X, the catalog number would be 584-20-7212.

C-L-X products manufactured in the United States under license granted by Kabelmetal of Hanover, Germany.

Length Tolerance: Cut lengths of 1000 feet or longer are subject to a tolerance of ± 10%; less than 1000 feet ± 15%.

ELECTRICAL SPECIFICATIONS Per UL Standard 2250

Insulation Test Voltage (spark test)	5000 Volts ac
Dielectric Test Voltage	1500 Volts ac for 15 sec.
Shield Isolation Test	
Pair to Cable Shield	exceeds 100M ohms/1000 ft.
Insulation Resistance Constant @60°F, minimum (natural material typical value)	2000 Megohms-1000 ft.



THE OKONITE COMPANY

Ramsey, New Jersey 07446



Okoseal-N[®] Type P-OS Type TC Instrumentation Cable

Single Pair or Triad - Overall Shield
600 Volts - 90°C Rating Wet or Dry



- A** Stranded Bare Copper Conductor
- B** Okoseal Insulation with Nylon Jacket
- C** Twisted Pair/Triad
- D** Stranded Tinned Copper Drain Wire
- E** Aluminum/Synthetic Polymer Tape
- F** Rip Cord
- G** Black Okoseal Jacket

Specifications

Conductors: Bare soft annealed copper, Class B, 7-strand concentric per ASTM B-8.

Insulation & Jacket: Flame-retardant Okoseal[®] (PVC), 15 mils nominal thickness, nylon jacket, 4 mil nominal thickness, 90°C temperature rating, per UL Standard 1277.

Conductor Identification: Pigmented black and white in pairs, black, white and red in triads.

Assembly: Pair or triad assembled with left-hand lay.

Cable Shield: Aluminum/Polyester tape overlapped to provide 100% coverage, and a 7-strand tinned copper drain wire, same size as conductor.

Jacket: Black, flame-retardant, low temperature Okoseal per UL Standard 1277, 90°C temperature rating. A rip cord is laid longitudinally under the jacket to facilitate removal.

Classification: UL Listed as Type TC Article 336 of the National Electrical Code.

Applications

Okonite's single pair or triad Type P-OS instrumentation cables are designed for use on Class 1 Remote-Control Signaling circuits or where a 600V cable is desired, as instrumentation, process control, or computer cable transmitting signals at levels above 100 milli-volts in circuits where shielding against external interference is required, but shielding against interference among groups is not required. For use indoors or outdoors; wet or dry locations; in cable trays; in raceways; supported by a messenger wire; in Class I, Division 2, Class II, Division 2 or Class III, Division 2 hazardous locations. Also for use as non power limited fire protective signaling cable (NPLF) per NEC Code 760. Type TC cables can be labeled Okomarine to be used in ABS and Coast Guard approved marine applications.

Type TC is authorized for use in Class I & II, Division 2 hazardous locations.

Product Features

- Passes the UL 1277 & IEEE 383-1974 vertical tray flame tests.
- May be combined with 600V power and control cables in the same tray.
- Sunlight resistant & oil resistant
- Individual pairs or triads are color coded for simplified hook-up.
- Good noise rejection.
- Excellent weathering characteristics.
- May be used in approved marine applications.
- Flexible, easy to handle and terminate.
- Twisted with 100% shield coverage to reduce electromagnetic pick-up.
- OSHA Acceptable.
- Suitable for installation in low temperature installations to -40°C.

Okoseal-N Type P-OS Type TC Instrumentation Cable

Single Pair or Triad - Overall Shield
600V - 90°C Rating Wet or Dry



Product Data Section 5: Sheet 29

Okoseal Insulation: 15 mils
Nylon Jacket: 4 mils

Catalog Number	Size AWG	Number of Pairs	Number of Triads	Jacket Thickness-(mils)	Nominal Cable O.D. - (in.)	Cross-Sectional Area † (sq in)	Approx Net Weight (lbs/1000')	Approx Ship Weight (lbs/1000')
▲ 264-60-3301	18	1	45	0.27	0.06	48	53	
264-65-3301	18	1		0.29	0.07	54	59	
▲ 264-60-4401	16	1		0.29	0.07	56	61	
▲ 264-65-4401	16	1		0.31	0.08	69	80	
▲ 264-60-5501	14	1		0.32	0.09	75	86	
264-65-5501	14	1		0.34	0.10	94	105	

ELECTRICAL SPECIFICATIONS Per UL Standard 1277

Conductor Resistance, maximum ohms/1000 ft.
..... @20°C @25°C

18 AWG 6.097.04
16 AWG 4.344.43
14 AWG 2.722.78

Insulation Test Voltage (spark test)

18 - 16 AWG 6000 volts ac
14 AWG 7500 volts ac

Dielectric Test Voltage

18-16 AWG 1500 volts ac for 1 minute
14 AWG 2000 volts ac for 1 minute

Shield Isolation Test

Pair to Cable Shield ... exceeds 100 Megohms/1000 ft.

Insulation Resistance Constant @60°F minimum
(natural material typical value)2000 Ohms-1000 ft.

Loop Resistance, nominal (2 conductor)ohms-1000 ft
..... @20°C @25°C

18 AWG 12.1814.08
16 AWG 8.688.86
14 AWG 5.445.56

† **Cross-sectional** area for calculation of cable tray fill in accordance with NEC Section 392-22

Length Tolerance: Cut lengths of 1000 feet or longer are subject to a tolerance of ± 10%; less than 1000 feet ± 15%.

▲ **Authorized Stock Item:** Available from our Customer Service Centers.

Mutual Capacitance	18 AWG49 pF/ft
	16 AWG56 pF/ft
	14 AWG64 pF/ft
L/R ratio	18 AWG14 micro Henry/ohm
	16 AWG21 micro Henry/ohm
	14 AWG31 micro Henry/ohm
Inductance	18 AWG0.19 micro Henry/ft
	16 AWG0.18 micro Henry/ft
	14 AWG0.17 micro Henry/ft





Okoseal-N[®] Type SP-OS

Type TC Instrumentation Cable

Multiple Shielded Pairs or Triads - Overall Shield
600 Volts - 90°C Rating Wet or Dry



- A** Stranded Bare Copper Conductor
- B** Okoseal Insulation with Nylon Jacket
- C** Tinned Stranded Copper Group Drain Wire
- D** Double Faced Aluminum/Synthetic Polymer Backed Tape
- E** Twisted, Shielded Pairs/Triads
- F** Double Faced Aluminum/Synthetic Polymer Backed Tape
- G** Stranded Tinned Copper Drain Wire
- H** Rip Cord
- J** Black Okoseal Jacket

Specifications

Conductors: Bare soft annealed copper, Class B, 7-strand concentric per ASTM B-8.

Insulation: Flame-retardant Okoseal[®] (PVC), 15 mils nominal thickness, nylon jacket, 4 mil nominal thickness, 90°C temperature rating, per UL Standard 1277.

Conductor Identification: Pigmented black and white in pairs; black, white and red in triads.

Group Shield: Aluminum/Polyester tape overlapped to provide 100% coverage, and a 7-strand tinned copper drain wire, two sizes smaller than the conductor. All group shields are completely isolated from each other.

Assembly: Pairs or triads assembled with 1 left-hand lay. Flame-retardant, non-wicking fillers included where required to provide a round cable.

Cable Shield: Aluminum/Polyester tape overlapped to provide 100% coverage, and a 7-strand tinned copper drain wire, same size as conductor.

Jacket: Black, flame-retardant, low temperature Okoseal per UL Standard 1277, 90°C temperature rating. A rip cord is laid longitudinally under the jacket to facilitate removal.

Classification: UL Listed as Type TC Article 336 of the National Electrical Code.

Applications

Okonite's Type SP-OS (Shielded pairs or triads - Overall Shield) instrumentation cables are designed for use on Class 1 Remote-Control Signaling circuits or where a 600V cable is desired, as instrumentation, process control, or computer cable transmitting signals at levels above 100 milli-volts in circuits where maximum noise protection is required. Protection from interference among groups as well as external sources is provided by individual group shields as well as an overall cable shield. For use indoors or outdoors; wet or dry locations; in raceways; supported by a messenger wire; for direct burial; in Class I, Division 2, Class II, Division 2 or Class III, Division 2 hazardous locations. Also for use as non power limited fired protective signaling cable (NPLF) per NEC Code 760. As an option, type TC cables can be labeled Okomarine to be used in ABS and Coast Guard approved marine applications, on special order.

Product Features

- Passes the UL 1277 and IEEE 383-1974 vertical tray flame tests.
- Passes IEEE 1202 vertical tray flame test (8 pr #18 and 4 pr #16 & larger).
- May be combined with 600 volt power and control cables in the same tray.
- Sunlight resistant and oil resistant.
- UL listed for direct burial (8/pr #16 AWG and larger)
- Individual pairs or triads are numbered and color-coded for simplified hook-up.
- Individual pairs or triads are completely isolated.
- 100% shield coverage for reduced electromagnetic noise pick-up.
- Good external noise rejection.
- Excellent weathering characteristics.
- OSHA Acceptable.
- Flexible, easy to handle and terminate.
- Suitable for installation at low temperatures to -40°C.

Okoseal-N Type SP-OS

Type TC Instrumentation Cable

Single Pairs or Triads - Individual and Overall Shield
600V - 90°C Rating Wet or Dry



Product Data

Section 5: Sheet 31

Okoseal Insulation - 15 mils; Nylon Jacket - 4 mils

Catalog Number	Size AWG Strands	Number of Pairs	Number of Triads	Jacket Thickness- (mils)	Nominal Cable O.D. - (In.)	Cross-Sectional Area † (sq in)	Approx Net Weight (lbs/1000')	Approx Ship Weight (lbs/1000')						
261-60-3304	4	4	45	0.50	0.20	138	161	261-60-3308						
261-60-3308									8	60	0.67	0.35	258	297
261-60-3310	10	80	60	0.77	0.46	316	355	261-60-3312						
261-60-3312									12	80	0.81	0.51	395	459
261-60-3316									16	80	0.93	0.67	496	559
261-60-3320									20	80	1.07	0.90	597	677
261-60-3324	18 (7x)	80	80	1.09	0.93	699	779	261-60-3336						
261-60-3324									24	80	1.09	0.93	699	779
261-60-3336									36	80	1.28	1.29	974	1080
261-60-3350									50	80	1.55	1.89	1307	1450
261-65-3304	4	60	60	0.61	0.29	196	220	261-65-3308						
261-65-3308									8	60	0.75	0.44	317	356
261-65-3312									12	80	0.95	0.71	516	580
261-65-3316	16	80	80	1.09	0.93	652	732	261-65-3324						
261-65-3324									24	80	1.34	1.41	940	1046
261-65-3336									36	80	1.53	1.84	1319	1462
▲ 261-60-4402	2	45	45	0.44	0.15	114	137	▲ 261-60-4404						
▲ 261-60-4404									4	60	0.58	0.26	198	222
▲ 261-60-4408									8	60	0.72	0.47	337	376
261-60-4410	10	80	80	0.94	0.69	452	516	▲ 261-60-4412						
▲ 261-60-4412									12	80	0.91	0.65	515	579
261-60-4416									16	80	1.04	0.85	650	730
261-60-4420	16 (7x)	80	80	1.19	1.11	787	867	▲ 261-60-4424						
▲ 261-60-4424									24	80	1.18	1.09	925	1031
261-60-4436									36	80	1.40	1.54	1304	1410
261-60-4450									50	110	1.79	2.52	1866	2053
261-65-4404	4	60	60	0.61	0.29	252	291	▲ 261-65-4408						
▲ 261-65-4408									8	80	0.79	0.49	478	542
▲ 261-65-4412									12	80	1.00	0.79	674	754
261-65-4416	16	80	80	1.12	0.99	858	964	261-65-4424						
261-65-4424									24	80	1.50	1.77	1245	1388
261-65-4436									36	80	1.71	2.30	1761	1948
261-60-5504	4	60	60	0.68	0.36	272	311	261-60-5508						
261-60-5508									8	80	0.91	0.65	511	575
261-60-5510	10	80	80	1.06	0.88	627	707	261-60-5512						
261-60-5512									12	80	1.09	0.93	721	801
261-60-5516									16	80	1.20	1.13	919	1025
261-60-5520	14 (7x)	80	80	1.34	1.41	1120	1226	261-60-5524						
261-60-5524									24	80	1.48	1.72	1322	1428
261-60-5536									36	80	1.67	2.19	1886	2029
261-60-5550									50	110	2.02	3.20	2681	2973
261-65-5504	4	60	60	0.75	0.44	351	390	261-65-5512						
261-65-5512									12	80	1.23	1.19	954	1060
261-65-5516	16	80	80	1.36	1.45	1225	1331	261-65-5524						
261-65-5524									24	80	1.69	2.24	1794	1987
261-65-5536									36	110	2.00	3.14	2683	2975

ELECTRICAL SPECIFICATIONS Per UL Standard 1277			
Conductor Resistance, maximumohms/1000 ft.			
		@20°C	@25°C
18 AWG	6.09		7.04
16 AWG	4.34		4.43
14 AWG	2.72		2.78
Insulation Test Voltage (spark test)			
18 - 16 AWG	6000 VOLTS AC		
14 AWG	7500 VOLTS AC		
Dielectric Test Voltage2000 Volts ac for 1 minute			
Insulation Resistance Constant @ 60F, minimum			
(natural material typical value) 2000 ohms/1000 ft.			
Loop Resistance, maximum (2 conductor)ohms-1000 ft			
		@20°C	@25°C
18 AWG.....	12.18		14.08
16 AWG	8.68		8.86
14 AWG	5.44		5.56

† Cross-sectional area for calculation of cable tray fill in accordance with NEC Section 392.22

Length Tolerance: Cut lengths of 1000 feet or longer are subject to a tolerance of ± 10%; less than 1000 feet ± 15%.

▲ Authorized Stock Item: Available from our Customer Service Centers.



THE OKONITE COMPANY

Ramsey, New Jersey 07446



C-L-X[®] Okoseal-N[®] P-OS

UL Type MC-HL and cUL Type ACIC-TC Instrumentation Cable

Single Pair or Triad-Overall Shield

600 Volts 90°C Rating 600/1000V Marine Cable

For Cable Tray Use - Sunlight Resistant - For Direct Burial

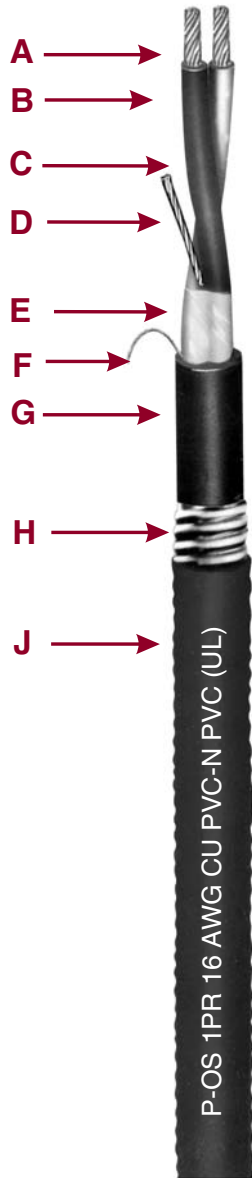

- A** Bare Stranded Copper Conductor
- B** Okoseal Insulation/Nylon Jacket
- C** Twisted, Shielded Pairs/Triads
- D** Tinned Stranded Copper Drain Wire
- E** Aluminum/Synthetic Polymer Tape
- F** Rip Cord
- G** Inner Black Okoseal Jacket
- H** Impervious, Continuous, Corrugated Aluminum C-L-X Sheath
- J** Outer Black Okoseal Jacket

Specifications

Conductors: Bare soft annealed copper, Class B, 7-strand concentric per ASTM B-8.

Insulation: Flame-retardant Okoseal (PVC) per UL 83, 15 mils nominal thickness, 90°C temperature rating.

Jacket: Nylon per UL 83, 4 mils nominal thickness.

Conductor Identification: Pigmented black and white in pairs; black, white and red in triads.

Assembly: Pairs or triads assembled with left-hand lay. Non-wicking fillers included where required to provide a round cable.

Cable Shield: Aluminum/Polyester tape overlapped to provide 100% coverage, and a #16 AWG stranded tinned copper drain wire.

Inner Jacket: Black, flame-retardant Okoseal per UL Standard 1569. A rip cord is laid longitudinally under the jacket to facilitate removal.

C-L-X Sheath: A close-fitting, impervious, continuously welded and corrugated, aluminum sheath meeting UL 1569 provides complete protection against moisture, liquids, and gases, has excellent mechanical strength, and provides equipment grounding through the sheath.

Outer Jacket: Black, flame-retardant Okoseal per UL Standard 1569.

Applications

Okonite C-L-X Single pair or triad type P-OS instrumentation cables are designed for use on Class 1 Remote-Control Signaling circuits or where a 600V cable is desired, as instrumentation, process control, or computer cable transmitting signals at levels above 100 milli-volts in circuits where shielding against external interference is required, but shielding against interference among groups is not required. For use indoors or outdoors; wet or dry locations; in cable trays; in raceways; supported by a messenger wire; for direct burial; in Classes I, II, and III, Divisions 1 and 2 hazardous locations per NEC Articles 501, 502, 503, 504 and 505; in Zone 2, Class II Div 2, Class III Div 1 and Class III Div 2 per CEC.

The overall shield eliminates most of the static interference from the electric field radiated by power cables and other electrical equipment.

The C-L-X sheath provides the physical protection against mechanical damage as required in NEC Section 725-8 as well as complete protection against moisture or gases entering the cable.

For dc service in wet locations, X-Olene insulation is recommended.

These cables also comply with UL requirements for Types CL2 and CL3.

Product Features

Complete pre-packaged, factory-tested wiring system—color coded.

C-L-X enclosure permits installation in cable tray containing light and power cables without a barrier separator.

Impervious, continuous sheath excludes moisture, gases and liquids.

C-L-X sheath exceeds equipment grounding conductor requirements of NEC Section 250-122, for Non-HL locations.

Excellent compression and impact resistance.

Lower installed system cost than conduit or EMT systems.

Suitable for low temperature installation to -40°C.

Applicable Standards

- UL listed for cable tray use, direct burial and sunlight resistant.
- Vertical Tray Flame Tests.
IEEE 383-1974, FT4/IEEE 1202, ICEA T-29-520 (210,000 BTU)
- American Bureau of Shipping Type approved as CWCMC Type MC-HL.
- API Standards 14F and 14FZ.
- ASTM B-8.
- OSHA Acceptable
- UL 2225 Type MC-HL
- UL 83
- UL 1309 (CWCMC) Marine Shipboard
- UL 1569
- UL certified as Marine Shipboard in accord with IEEE 1580, Marine Shipboard Cable rated 600/1000 volts.
- NEC Articles 501, 502, 503, 504 and 505 for Classes I, II and III, Divisions 1 and 2 Hazardous Locations.
- NPLF per NEC Code Article 760.
- CSA C22.2 No. 230 Type TC
- CSA C22.2 No. 239 Type ACIC
- cUL Type ACIC-TC complies with CEC Zone 2, Class II Div 2, Class III Div 1 and Class III Div 2 Hazardous Locations.

C-L-X Okoseal-N P-OS

UL Type MC-HL and cUL Type ACIC-TC Instrumentation Cable

Single Pair or Triad-Overall Shield
600 Volts 90°C Rating 600/1000V Marine Cable

For Cable Tray Use - Sunlight Resistant - For Direct Burial

Conductors: #16 AWG; Okoseal Insulation: 15 mils; Nylon Jacket: 4 mils

Product Data Section 5: Sheet 40



#16 AWG — Single Pair & Triad (P-OS) Type MC-HL

Catalog Number	Number of Pairs	Number of Triads	Inner Jacket Thickness - mils	Inner Jacket Nominal O.D. - inches	C-L-X O.D. - inches	Outer Jacket Thickness, mils	Nominal Cable O.D. - inches	Cross-Sectional Area * Sq. In.	Net Weight Lbs./1000'	Ship Weight Lbs./1000'
▲ 564-60-3401	1		66	.35	.53	50	.64	0.32	182	221
▲ 564-65-3401		1	58	.35	.53	50	.64	0.32	190	229

ELECTRICAL SPECIFICATIONS

Conductor Resistance, maximum	ohms/1000 ft.	
	@20°C	@25°C
16 AWG	4.34	4.43
Insulation Test Voltage (spark test)	6000 Volts ac	
Dielectric Test Voltage	2000 Volts ac.	
Shield Isolation Test		
Pair to Cable Shield	exceeds 100 Megohms-1000 ft.	
Insulation Resistance Constant @60°F minimum (natural material typical value)	2000 Ohms-1000 ft.	
Loop Resistance, nominal (2 conductor)	ohms/1000 ft	
	@20°C	@25°C
16 AWG	8.68	8.86
Mutual Capacitance (PF/ft.)*		
#16	60	

*Typical Value

▲ Authorized Stock Item: Available from our Customer Service Centers.

*Cross-sectional area for calculation of cable tray fill in accordance with NEC Section 392.22.

Jackets: Optional jacket types available - consult local sales office.

Copper or bronze C-L-X available on special order.

To order C-L-X Type P-OS without the outer Okoseal jacket (not "HL" listed), change the sixth digit of the catalog number from 3 to 1, for example to order 1 pr. 20 AWG with a bare aluminum C-L-X, the catalog number would be 564-10-1212.

Length Tolerance: Cut lengths of 1000 ft. or longer are subject to a tolerance of +\ -10%; less than 1000 ft. +\ -15%



C-L-X® Okoseal-N® SP-OS

UL Type MC-HL and cUL Type ACIC-TC Instrumentation Cable

Multiple Shielded Pairs or Triads - Individual and Overall Shield
600 Volts 90°C Rating MC-HL — 600/1000V Marine Cable
For Cable Tray Use - Sunlight Resistant - For Direct Burial



- A Bare Stranded Copper Conductor
- B Okoseal Insulation/Nylon Jacket
- C Tinned Stranded Copper Group Drain Wire
- D Aluminum/Polyester Tape
- E Twisted, Shielded Pairs/Triads
- F Tinned Stranded Copper Drain Wire
- G Aluminum/Polyester Tape
- H Rip Cord
- J Inner Black Okoseal Jacket
- K Impervious, Continuous, Corrugated Aluminum C-L-X Sheath
- L Outer Black Okoseal Jacket

Specifications

Conductors: Bare soft annealed copper, Class B, 7-strand concentric per ASTM B-8.

Insulation: Flame-retardant Okoseal (PVC) per UL 83, 15 mils nominal thickness, 90°C temperature rating.

Insulation Jacket: Nylon per UL 83, 4 mils nominal thickness.

Conductor Identification: Pigmented black and white in pairs, black, white and red in triads.

Group Shield: Aluminum polyester tape overlapped to provide 100% coverage, and a 7-strand tinned copper drain wire, two sizes smaller than the conductor. All group shields are completely isolated from each other.

Assembly: Pairs or triads assembled with left-hand lay. Non-wicking fillers included where required to provide a round cable.

Cable Shield: Aluminum/polyester tape overlapped to provide 100% coverage, and a 7-strand tinned copper drain wire, same size as conductor.

Inner Jacket: Black, flame-retardant Okoseal per UL Standard 1569. A rip cord is laid longitudinally under the jacket to facilitate removal.

C-L-X Sheath: A close-fitting, impervious, continuously welded and corrugated, aluminum sheath provides physical protection against mechanical damage as required in NEC Section 725-8.

Additionally, C-L-X meets UL 1569 provides complete protection against moisture, liquids, and gases, has excellent mechanical strength, and provides equipment grounding through the sheath.

Outer Jacket: Black, flame-retardant Okoseal per UL Standard 1569.

Classifications: UL Listed as Type MC-HL Articles 501, 502, and 503 of the National Electrical Code.

Applications

Okonite C-L-X type SP-OS (shielded pairs or triads - overall shield) instrumentation cables are designed for use on Class 1 Remote-Control Signaling circuits or where a 600V cable is desired, as instrumentation, process control, or computer cable transmitting signals at levels above 100 milli-volts in circuits where maximum noise protection is required. Protection from interference among groups as well as external sources is provided by individual group shields as well as an overall cable shield. For use indoors or outdoors; wet or dry locations; in cable trays in raceways; supported by a messenger wire; for direct burial; in Classes I, II, and III, Divisions 1 and 2 and Class I, Zones 1 and 2 hazardous locations per NEC Articles 501, 502, 503 and 505; in Zone 2,

Class II Div 2, Class III Div 1 and Class III Div 2 per CEC.

The isolated individual shields over each pair, when properly grounded, prevent crosstalk or capacitive coupling between adjacent pairs which occurs with ac signals, particularly the pulse type.

The overall shield eliminates most of the static interference from the electric field radiated by power cables and other electrical equipment.

The C-L-X sheath provides physical protection against mechanical damage as required in NEC Section 725-8 as well as complete protection against moisture or gases entering the cable.

For dc service in wet locations, X-Olene insulation is recommended.

Product Features

Individual units are completely isolated for maximum noise rejection.

C-L-X enclosure permits installation in cable tray containing light and power cables without a barrier separator.

C-L-X sheath exceeds equipment grounding conductor requirements of NEC Section 250-122, non-HL locations.

Lower installed system cost than conduit or EMT systems.

Suitable for low temperature installation to -40°C.

Applicable Standards

- UL listed for cable tray use, direct burial, in ducts, and sunlight resistant.
- Vertical Tray Flame Tests; IEEE 383-1974, FT4/ IEEE 1202, ICEA T-29-520 (210,000 BTU).
- American Bureau of Shipping Type approved as CWCMC Type MC-HL.
- API Standards 14F and 14FZ.
- ASTM B-8
- OSHA Acceptable
- UL 2225 Type MC-HL, UL 83, UL 1309 (CWCMC) Marine Shipboard, UL 1569
- UL certified to IEEE 1580 - Marine Shipboard Cable rated 600/1000V.
- NEC Articles 501, 502, 503, 504 and 505 for Classes I, II, and III, Divisions 1 and 2 Hazardous Locations.
- NPLF pr NEC Code Article 760.
- CSA C22.2 No. 230 Type TC
- CSA C22.2 No. 239 Type ACIC
- cUL Type ACIC-TC Complies with CEC Zone 2, Class II Div 2, Class III Div 1, Class III Div 2 Hazardous Locations.

C-L-X Okoseal-N SP-OS



Product Data Section 5: Sheet 42

UL Type MC-HL and cUL Type ACIC-TC Instrumentation Cable

Multiple Shielded Pairs or Triads - Individual and Overall Shield

600V 90°C Rating MC-HL — 600/1000V Marine Cable

For Cable Tray Use - Sunlight Resistant - For Direct Burial

Conductors: #16 AWG; Okoseal Insulation: 15 mils; Nylon Jacket: 4 mils

Catalog Number	Number of Pairs	Number of Triads	Inner Jacket Thickness - mils	Nominal Core O.D. - Inches	C-L-X O.D. - Inches	Outer Jacket mils	Nominal Cable O.D. - Inches	Cross-Sectional Area* Sq. In.	Net Weight Lbs./1000'	Ship Weight Lbs./1000'
▲ 561-60-3402	2	40	0.45	0.67	50	0.76	0.45	234	314	
▲ 561-60-3404	4	50	0.56	0.80	50	0.91	0.65	335	415	
561-60-3406	6	50	0.66	0.89	50	1.00	0.79	421	501	
▲ 561-60-3408	8	50	0.70	0.93	50	1.04	0.85	492	572	
561-60-3410	10	50	0.79	1.06	50	1.17	1.08	601	681	
▲ 561-60-3412	12	50	0.85	1.11	50	1.22	1.17	674	780	
561-60-3416	16	50	0.98	1.29	50	1.40	1.54	842	948	
561-60-3420	20	50	1.06	1.34	50	1.45	1.65	977	1120	
▲ 561-60-3424	24	50	1.12	1.42	50	1.53	1.84	1118	1261	
▲ 561-60-3436	36	50	1.37	1.69	60	1.82	2.60	1586	1773	
561-60-3450	50	50	1.57	1.92	60	2.05	3.30	2124	2416	
▲ 561-65-3404	4	50	0.61	0.84	50	0.95	0.71	395	475	
▲ 561-65-3408	8	50	0.82	1.06	50	1.17	1.08	637	717	
▲ 561-65-3412	12	50	0.98	1.29	50	1.40	1.54	863	969	
561-65-3416	16	50	1.10	1.37	50	1.48	1.72	1058	1201	
561-65-3424	24	50	1.33	1.64	60	1.78	2.49	1485	1672	
561-65-3436	36	50	1.58	1.96	60	2.09	3.43	2141	2426	

ELECTRICAL SPECIFICATIONS

Conductor Resistance, nominalohms/1000 ft. @20°C
 16 AWG4.1
 Insulation Test Voltage (spark test)6000 Volts ac
 Dielectric Test Voltage2000 Volts ac for 60 sec.
 Insulation Resistance Constant @60°F minimum
 (natural material typical value) ..2000 Megohms-1000 ft.
 Loop Resistance, nominal (2 conductor).....ohms-1000 ft @20°C
 16 AWG8.2
 Mutual Capacitance (PF/ft.)*
 #1660
 *Typical Value

▲ **Authorized Stock Item:** Available from our Customer Service Centers.

***Cross-sectional area** for calculation of cable tray fill in accordance with NEC Section 392.22.

Jackets - Optional jacket types available - consult local sales office.

Copper or bronze C-L-X available on special order.

To order C-L-X Type SP-OS without the outer Okoseal jacket (not "HL" listed), change the sixth digit of the catalog number from 3 to 1, for example to order 1 pr. 20 AWG with a bare aluminum C-L-X, the catalog number would be 564-10-1212.

Length Tolerance: Cut lengths of 1000 ft. or longer are subject to a tolerance of + \ -10%; less than 1000 ft. + \ -15%



Okobus

Single Pair: Type P-OS — Multi Pair: Type SP-OS Type PLTC & Type ITC-ER Fieldbus Cable

Single Pair or Multiple Shielded Pairs - Overall Shield
300 Volts 75°C Rating



- A** Tinned Copper Stranded Conductor
- B** Polypropylene Insulation
- C** Tinned Stranded Copper Group Drain Wire
- D** Aluminum/Polyester Tape
- E** Twisted, Shielded Pairs
- F** Aluminum/Polyester Tape
- G** Tinned Stranded Copper Drain Wire
- H** Rip Cord
- J** Orange Okoseal Jacket

Specifications

Conductors: #18 AWG tinned copper, Class M, stranded per ASTM B-174.

Insulation: Okolene® (Polypropylene) per UL 13 and 2250, 32 mils nominal thickness, 75°C temperature rating.

Conductor Identification: Pigmented orange and blue in pairs, orange conductor numerically printed for group identification.

Pair Shield: Aluminum/Polyester tape overlapped to provide 100% coverage, and a Class M tinned copper drain wire, two sizes smaller than the conductor. All multi-pair shields are isolated from each other.

Multiple Pair Assembly: Pairs assembled with a left-hand lay. Cable fillers included where required to provide a round cable.

Multiple Pair Cable Shield: Aluminum/Polyester tape overlapped to provide 100% coverage, and a class M strand tinned copper drain wire, same size as conductor.

Jacket: Orange, flame-retardant, Okoseal per UL 13 and 2250. A rip cord is laid longitudinally under the jacket to facilitate removal.

Classifications: UL Listed as PLTC-Power Limited Tray Cable and as ITC-ER - Instrument Tray Cable/Exposed Run for use in accordance with Article 727 and Article 725 of the National Electrical Code.

Cables comply with ISA-S-50-02, UL 2250 and UL 13 for Fieldbus circuits and CL2 and CL3.

Applications

Okonite® OKOBUS® cables are designed for use in rugged plant environments utilizing networked discrete or process automation and control. ITC-ER (Instrument Tray Cable - Exposed Run) eliminated the need for conduit when installed in accordance with NEC Article 727.4(6). Fully complies with ANSI/ISA 50.02 part 2 for Fieldbus Cable.

The isolated individual shields over each pair, when properly grounded,

prevent crosstalk or capacitive coupling between adjacent pairs which occurs with ac signals, particularly the pulse type.

The overall shield or multi pair cables eliminates most of the static interference from the electrical field radiated by power cables and other electrical equipment.

Product Features

- Passes the UL 13 and IEEE 383 vertical tray flame tests.
- Single pair passes IEEE 1202 vertical tray flame test.
- Sunlight & oil resistant.
- UL listed for direct burial.
- Individual pairs are completely isolated.
- 100% shield coverage for reduced electromagnetic noise pick-up.
- Excellent external noise rejection.
- Excellent weathering characteristics.
- OSHA Acceptable.
- Flexible, easy to handle and terminate.



Single Pair or Multiple Shielded Pairs - Overall Shield 300 V 75°C Rating

#18 AWG

Catalog Number	Number of Pairs	Jacket Thickness-mils	Nominal Cable O.D. - Inches	Cross-Sectional Area † (sq in)	Approx Net Weight (lbs/1000')	Approx Ship Weight (lbs/1000')
▲ 264-92-3901	1	45	0.34	0.09	62	73
261-92-3302	2	50	0.55	0.24	148	172
261-92-3304	4	60	0.71	0.40	212	251
261-92-3063	6	60	0.80	0.50	264	303
261-92-3308	8	70	0.91	0.65	340	404
261-92-3312	12	70	1.04	0.85	474	554
261-92-3316	16	70	1.17	1.08	580	660
261-92-3320	20	80	1.32	1.37	722	828
261-92-3324	24	80	1.46	1.67	880	1023

† **Cross-sectional** area for calculation of cable tray fill in accordance with NEC Section 392.22

Length Tolerance: Cut lengths of 1000 feet or longer are subject to a tolerance of $\pm 10\%$; less than 1000 feet $\pm 15\%$.

▲ **Authorized Stock Item:** Available from our Customer Service Centers.

CHARACTERISTICS

- a) Characteristic Impedance, z_0 , at fr (31.25kHz), minimum100 ohms
- b) Maximum attenuation at 1.25 fr (39 kHz)3.0 dB/km
- c) Maximum capacitive unbalance to shield2 nF/km
- d) Maximum DC resistance (per conductor)24 ohms/km
- e) Maximum propagation delay change 0.25 fr to 1.25 fr1.7 μ s/km
- f) conductor cross-sectional area nominal (wire size)0.8 mm² (#18 AWG)
- g) Minimum shield coverage100%





Okobus C-L-X

Single Pair: Type P-OS - Multi Pair: Type SP-OS

Type PLTC & Type ITC-HL Fieldbus Cable

Single Pair or Multiple Shielded Pairs - Overall Shield

300 Volts 75°C Rating



- A Tinned Copper Stranded Conductor
- B Polypropylene Insulation
- C Tinned Stranded Copper Group Drain Wire
- D Aluminum/Polyester Tape
- E Twisted, Shielded Pairs
- F Aluminum/Polyester Tape
- G Tinned Stranded Copper Drain Wire
- H Rip Cord
- J Inner Orange Okoseal Jacket
- K Impervious, Continuous, Corrugated Aluminum C-L-X Sheath
- L Outer Orange Okoseal Jacket

Specifications

Conductors: #18 AWG tinned copper, Class M, stranded per ASTM B-174.

Insulation: Okolene® (Polypropylene) per UL 13 and 2250, 32 mils nominal thickness, 75°C temperature rating.

Conductor Identification: Pigmented orange and blue in pairs, orange conductor numerically printed for group identification.

Pair Shield: Aluminum/Polyester tape overlapped to provide 100% coverage, and a Class M tinned copper drain wire, two sizes smaller than the conductor. All multi-pair shields are isolated from each other.

Multiple Pair Assembly: Pairs assembled with a left-hand lay. Cable fillers included where required to provide a round cable.

Multiple Pair Cable Shield: Aluminum/Polyester tape overlapped to provide 100% coverage, and a class M strand tinned copper drain wire, same size as conductor.

Inner Jacket: Orange, flame-retardant, Okoseal per UL 13 and 2250. A rip cord is laid longitudinally under the jacket to facilitate removal.

C-L-X Sheath: A close-fitting, impervious, continuously welded and corrugated, aluminum sheath provides complete protection against moisture, liquids, and gases, has excellent mechanical strength, and provides equipment grounding through the sheath.

Outer Jacket: Orange, flame-retardant, Okoseal per UL 13 and 2250.

Classifications: UL Listed as PLTC-Power Limited Tray Cable and as ITC-HL - Instrument Tray Cable/Hazardous Locations for use in accordance with Article 727 and Article 725 of the National Electrical Code.

Cables comply with ISA-S-50-02, UL 2250 and UL 13 for Fieldbus circuits and CL2 and CL3.

Applications

C-L-X OKOBUS® cables are designed for use in rugged plant and off-shore marine

environments utilizing networked discrete or process automation and control. ITC-HL (Instrument Tray Cable - Hazardous Locations) eliminates the need for conduit when installed in accordance with NEC Article 501.10(A)(1)(d) "ITC-HL" installations. Fully complies with ANS/ISA 50.02 Part 2 Fieldbus Cable.

The isolated individual shields over each pair, in SP-OS cables, when properly grounded, prevent crosstalk or capacitive coupling between adjacent pairs which occurs with ac signals, particularly the pulse type.

The overall shield eliminates most of the static interference from the electrical field radiated by power cables and other electrical equipment.

The C-L-X sheath provides additional electrical shielding and physical protection against mechanical damage as well as complete protection against moisture or gases entering the cable.

Product Features

- Passes the UL 13 and IEEE 383 vertical tray flame tests.
- Passes IEEE 1202 vertical tray flame test.
- Sunlight & oil resistant.
- UL listed for direct burial.
- Complete pre-packaged, factory-tested wiring system-color coded.
- C-L-X enclosure permits installation in cable tray containing lighting and power cables without a barrier separator.
- Individual pairs are completely isolated.
- Impervious, continuous sheath excludes moisture, gases and liquids.
- C-L-X sheath exceeds equipment grounding conductor requirements of NEC Article 250.
- Lower installed system cost than conduit or EMT systems.

Okobus — C-L-X

Single Pair Type P-OS - Multi Pair Type SP-OS Type PLTC & Type ITC-HL Fieldbus Cable

Single Pair or Multiple Shielded Pairs - Overall Shield 300 V 75°C Rating

#18 AWG



Product Data Section 5: Sheet 48

Catalog Number	Number of Pairs	Inner Jacket Thickness - mils	Nominal Core O.D. Inches	C-L-X O.D. Inches	Outer Jacket mils	Nominal Cable O.D. - Inches	Cross-Sectional Area † (sq in)	Approx Net Weight (lbs/1000')	Approx Ship Weight (lbs/1000')
▲ 564-92-3301	1	45	0.34	0.53	40	0.62	0.30	155	194
561-92-3302	2	50	0.55	0.80	50	0.91	0.65	311	391
561-92-3304	4	60	0.71	0.93	50	1.04	0.85	400	480
561-92-3306	6	60	0.81	1.06	50	1.17	1.08	493	573
561-92-3308	8	70	0.91	1.15	50	1.26	1.25	587	693
561-92-3312	12	70	1.04	1.34	50	1.45	1.65	759	902
561-92-3316	16	70	1.17	1.47	50	1.58	1.96	902	1045
561-92-3320	20	80	1.33	1.64	50	1.75	2.41	1072	1236
561-92-3324	24	80	1.46	1.78	50	1.89	2.81	1308	1495

† **Cross-sectional** area for calculation of cable tray fill in accordance with NEC Section 392.22.

Copper or bronze C-L-X available on special order.

Length Tolerance: Cut lengths of 1000 feet or longer are subject to a tolerance of ± 10%; less than 1000 feet ± 15%.

▲ **Authorized Stock Item:** Available from our Customer Service Centers.

CHARACTERISTICS

- a) Characteristic Impedance, Z_0 , at fr (31.25kHz), minimum100 ohms
- b) Maximum attenuation at 1.25 fr (39 kHz).....3.0 dB/km
- c) Maximum capacitive unbalance to shield.....2 nF/km
- d) Maximum DC resistance (per conductor)24 ohms/km
- e) Maximum propagation delay change 0.25 fr to 1.25 fr.....1.7 μ s/km
- f) conductor cross-sectional area nominal (wire size)0.8 mm² (#18 AWG)
- g) Minimum shield coverage100%





C-L-X X-Olene® P-OS, SP-OS

UL Type MC-HL, PLTC, ITC-HL and cUL ACIC-TC Instrumentation Cable
 Single Pair/Triads or Multiple Shielded Pairs/Triads - Overall Shield
 600 Volts 90°C Rating: UL MC-HL and cUL ACIC-TC
 300 Volts 90°C Rating: UL PLTC & ITC-HL
For Cable Tray Use Sunlight Resistant For Direct Burial -50°C



- A Copper Stranded Conductor
- B X-Olene Insulation
- C Tinned Stranded Copper Group Drain Wire
- D Aluminum/Polyester Tape
- E Twisted, Shielded Pairs
- F Aluminum/Polyester Tape
- G Tinned Stranded Copper Drain Wire
- H Rip Cord
- J Inner Okoseal Jacket
- K Impervious, Continuous, Corrugated Aluminum C-L-X Sheath
- L Outer Okoseal Jacket

Specifications

Conductors: Bare copper, Class B, stranded per ASTM B-8.

Insulation: X-Olene (XLPE), per UL 13, 2250 & 1569, 30 mils nominal thickness, 90°C temperature rating. Meets MIL-DTL-1377H, section 4.8.4.1.2 Cold Bend at -66°C and ASTM D746-04 brittlepoint at -76°C.

Conductor Identification: Pigmented black and white in pairs, black, red and white in triads; white conductor numerically printed for group identification.

Pair Shield: Aluminum/Polyester tape overlapped to provide 100% coverage, and a Class B tinned copper drain wire, two sizes smaller than the conductor. All multi-pair shields are isolated from each other.

Multiple Pair Assembly: Pairs assembled with a left-hand lay. Cable fillers included where required to provide a round cable.

Multiple Pair Cable Shield: Aluminum/Polyester tape overlapped to provide 100% coverage, and a class B strand tinned copper drain wire, same size as conductor.

Inner Jacket: Black, flame-retardant, low temperature Okoseal® (PVC) per UL 13 and UL Standard 2250. The inner jacket meets the thickness requirements of UL standard 1277. A rip cord is laid longitudinally under the jacket to facilitate removal.

C-L-X Sheath: A close-fitting, impervious, continuously welded and corrugated, aluminum sheath provides complete protection against moisture, liquids, and gases, has excellent mechanical strength, and provides equipment grounding through the sheath.

Outer Jacket: Black, flame-retardant, low temperature Okoseal per UL 13 and UL Standard 2250.

Applications

ITC-HL and MC-HL cables eliminate the need for conduit when installed in accordance with NEC Article 501.10(A)(1)(d) "ITC-HL" or 501.10(A)(1)(C) "MC-HL" installations. UL listed as PLTC-Power Limited Tray Cable and as ITC-HL - Instrument Tray Cable/Hazardous Locations for use in accordance with Article 725 (Class 1, 2 & 3) and Article 727 of the National Electrical Code.

UL listed as MC-HL for use in Class I, II, and III, Divisions 1 and 2 hazardous location in accordance with NEC Articles 501, 502, 503, 504 & 505; in Zone 2, Class II Div 2, Class III Div 1 and Class III Div 2 per CEC.

The isolated individual shields over each pair, in SP-OS cables, when properly grounded, prevent crosstalk or capacitive coupling between adjacent pairs while the overall shield eliminates most of the static interference from the electrical field radiated by power cables and other electrical equipment.

Product Features

Complete pre-packaged, factory-tested wiring system-color coded.

C-L-X enclosure permits installation in cable tray containing lighting and power cables without a barrier separator.

Lower installed system cost than conduit or EMT systems.

Applicable Standards

- UL listed for cable tray use, direct burial, in ducts, and sunlight resistant.
- Vertical Tray Flame Tests; IEEE 383-1974 & FT4/IEEE 1202.
- UL listed at -50°C. Also, meets the CSA 22.2 No.3 Cold Impact Test at -45°C.
- API Standards 14F and 14FZ.
- ASTM B-8.
- OSHA Acceptable
- UL 2225 Type MC-HL & UL 1569
- NEC Articles 501, 502, 503, 504 and 505 for Classes I, II, and III, Divisions 1 and 2 Hazardous Locations.
- UL listed as PLTC-Power Limited Tray Cable and as ITC-HL - Instrument Tray Cable/Hazardous Locations for use in accordance with Article 725 (Class 1, 2 & 3) and Article 727 of the National Electrical Code.
- NPLF per NEC Code Article 760.
- CSA C22.2 No. 230 Type TC
- CSA C22.2 No. 239 type ACIC
- cUL listed as Type ACIC-TC complies with CEC Zone 2, Class II Div 2, Class III Div 1, Class III Div 2 Hazardous Locations.

C-L-X X-Olene P-OS, SP-OS



Product Data Section 5: Sheet 49

UL Type MC-HL, PLTC, ITC-HL and cUL ACIC-TC Instrumentation Cable
 Single Pair/Triads or Multiple Shielded Pairs/Triads - Overall Shield
 600 Volts 90°C Rating: UL MC-HL and cUL ACIC-TC
 300 Volts 90°C Rating: UL PLTC & ITC-HL
For Cable Tray Use Sunlight Resistant For Direct Burial -50°C
#16 AWG

Catalog Number	Number of Pairs	Number of Triads	Inner Jacket Thickness - mils	Nominal Core O.D. Inches	C-L-X O.D. Inches	Outer Jacket mils	Nominal Cable O.D. - Inches	Cross-Sectional Area † (sq in)	Approx Net Weight (lbs/1000')	Approx Ship Weight (lbs/1000')
567-75-3401	1		45	0.35	0.58	50	0.69	0.37	180	219
567-70-3402	2		60	0.58	0.80	50	0.91	0.65	325	405
567-70-3404	4		60	0.70	0.93	50	1.04	0.85	424	504
567-70-3408	8		80	0.92	1.19	50	1.30	1.33	650	752
567-70-3412	12		80	1.10	1.37	50	1.48	1.73	842	985
567-70-3424	24		80	1.44	1.78	60	1.91	2.87	1450	1640
567-70-3436	36		110	1.82	2.19	60	2.32	4.23	2145	2480
567-76-3401		1	45	0.37	0.58	50	0.69	0.37	195	234
567-71-3402		2	60	0.64	0.89	50	1.00	0.79	376	456
567-71-3404		4	60	0.75	1.02	50	1.13	1.00	500	580
567-71-3408		8	80	1.06	1.34	50	1.45	1.64	800	945
567-71-3412		12	80	1.26	1.56	60	1.69	2.24	1090	1235

#18 AWG

567-70-3302	2		45	0.50	0.71	50	0.82	0.53	253	333
567-70-3304	4		60	0.67	0.89	50	1.00	0.79	365	445
567-70-3308	8		60	0.83	1.06	50	1.17	1.08	503	583
567-70-3312	12		80	1.00	1.29	50	1.40	1.54	693	799
567-70-3324	24		80	1.34	1.64	60	1.78	2.48	1125	1290
567-70-3336	36		80	1.55	1.92	60	2.05	3.29	1545	1835
567-71-3302		2	60	0.62	0.84	50	0.95	0.71	326	406
567-71-3304		4	60	0.73	0.97	50	1.08	0.92	428	508
567-71-3308		8	80	0.98	1.24	50	1.35	1.43	658	764
567-71-3312		12	80	1.15	1.47	50	1.58	1.96	860	1003
567-71-3324		24	80	1.58	1.96	60	2.09	3.42	1505	1760

ELECTRICAL SPECIFICATIONS

Conductor Resistance, nominal - ohms/1000 ft.@20°C@25°C	
16 AWG	4.344.43
18 AWG	6.937.07
Insulation Test Voltage (spark test)	7500 Volts ac
Dielectric Test Voltage	3000 Volts ac
Insulation Resistance Constant @60°F minimum ...	10,000 ohms-1000 ft.
Loop Resistance, nominal (2 cdr.) - ohms/1000 ft .@20°C@25°C	
16 AWG	8.688.86
18 AWG	13.914.2
Mutual Capacitance (PF/ft.)*	
#16	23
#18	21

*Typical Value

† **Cross-sectional** area for calculation of cable tray fill in accordance with NEC Section 392.9.

Jackets - Optional jacket types available - consult local sales office.

Copper or bronze C-L-X available on special order.

To order without the outer Okoseal jacket (not "HL" listed), change the sixth digit of the catalog number from 3 to 1, for example to order 1 pr. 16 AWG with a bare aluminum C-L-X, the catalog number would be 567-75-1401.

Length Tolerance: Cut lengths of 1000 feet or longer are subject to a tolerance of ± 10%; less than 1000 feet ± 15%.





Okonite X-Ray/Hi-Voltage Cable

Low Noise

65kV, 75kV, 100kV, 230kV and 250kV dc Rating
Three Conductor or Four Conductor

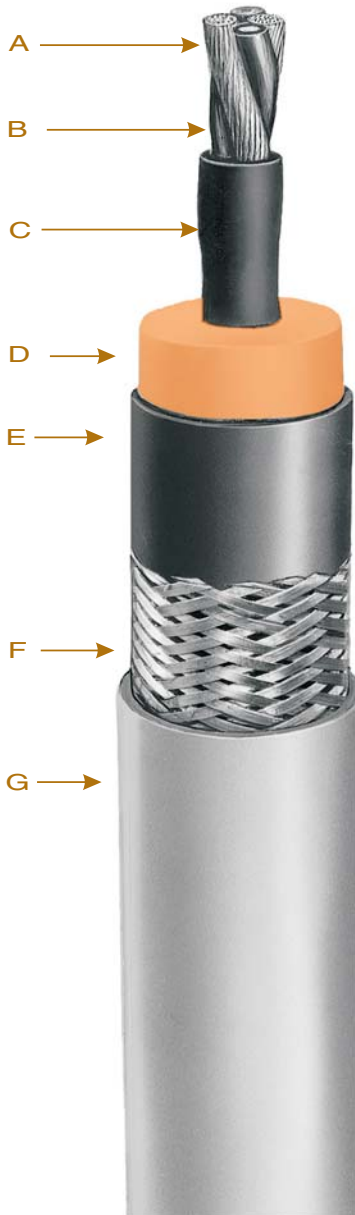

- A Coated Stranded Copper Conductors
- B Polyester Insulation
- C Extruded Semiconducting Layer
- D Primary Insulation – Okoguard
- E Extruded Insulation Shield
- F Coated Copper Braid
- G Jacket – Okoseal

Applications

Okonite X-Ray cables are suitable for use on X-Ray apparatus for medical, industrial, research and control applications. They give trouble-free performance where pulse type high voltages are required. Although primarily used with medical diagnostic imaging equipment, Okonite X-Ray cables are also used with equipment in industrial applications as well as in research projects where high voltages, low power are required.

Okonite LOW NOISE X-Ray cables have specifically been designed for use where sensitive measurements are required. These LOW NOISE cables are manufactured and assurance tested to meet less than 10 picocoulomb discharge thereby reducing noise to a minimum.

Okonite LOW NOISE X-Ray cables are offered at 65kV, 75kV, 100kV, 230kV and 250kV dc ratings.

Typically, Okonite X-Ray cables are used to supply the anode and cathode voltages to the X-Ray tube. Since one terminal operates at a negative potential and the other at a positive potential, the voltage across the X-Ray tube is twice (2X) the rated voltage of the cable.

The two usual constructions are (1) three conductor (3/C) used on typical cathode cable installations, and (2) four conductor (4/C) utilized on installations with a grid controlled lead. Upon request, designs and constructions can be developed for special applications.

Product Features

- Low Noise - < 10 pC @ 200 Vac/mil of insulation to 42 kV max.
- Performance tested for long trouble-free service.
- Small diameter.
- Flexible construction.
- Excellent flexing endurance.
- Mechanically rugged.
- Easy to strip and terminate.
- Resistant to most oils and chemicals.
- Complies with NEMA Standard XR-7 where applicable.

Installation

The minimum bending radius for permanent installation or flexing in service is four times the cable diameter.

Specifications

Cable Core: Each Low Noise cable core contains two insulated filament conductor. In 65, 75, and 100kV cable filament conductors are #15 AWG (19x) [1.65mm²] tinned copper insulated with heat sealed color coded polyester tape. In 230kV cables, the filament wires are #16 AWG (19x) [1.31mm²] tinned copper. The 250 kV cable filaments are #14 AWG (19x) [2.08mm²] tinned copper. Both the 230 and 250kV filament wires are insulated with an extrusion of ETFE. Four conductor cables include one #20 AWG (7x) [0.52mm²] copperweld conductor per ASTM B-45 insulated with heat sealed polyester and shielded with metalized red polyester.

The tinned copper uninsulated conductor in 3/C 65, 75, 100 and 230kV cables is segmented into two #18 AWG [0.83mm²] flex stranded wires. The 4/C uninsulated conductor is segmented into three #18 AWG wires. A single #12 AWG (19x) wire is used in the 250kV cable.

Core Shield: An extruded layer of semiconducting compound encapsulates the composite core assembly.

High Voltage Insulation: Okonite's premium EPR (ethylene-propylene rubber) insulation. This ozone resistant high voltage dielectric is extruded in tandem with the semiconducting layers which insures an intimate and contaminant free interface between the layers.

Insulation Shield: A strippable extruded layer of semiconducting EPR compound is applied directly over the insulation.

Shield: A braid of tinned copper wires is applied directly over the insulation shield. Minimum coverage indicated in table.

Jacket: A flexible Okoseal (specially compounded PVC) jacket is extruded over the shield to provide additional mechanical strength and resistance to most oils and chemicals.

Okonite X-Ray/Hi-Voltage Cable

Low Noise

65kV, 75kV, 100kV, 230kV and 250kV dc Rating

Three Conductor or Four Conductor

Product Data Section 6: Sheet 1

	Description	Catalog Number	Tinned Copper Braid Coverage (%)	Cellophane Wrap (1)	Jacket Color	Insulation O.D. Inches ± 0.010	Insulation O.D. mm ± 0.25	Jacket O.D. Inches ± 0.015	Jacket O.D. mm ± 0.38	Net. Wt. (lbs/1000 ft.)	Net. Wt. (kg/100m)	Approx. Ship Weight (lbs/1000')	Approx. Ship Weight (kg/100m)
65kV	3 Conductors 2-#15 AWG insulated 1-(2-#18 AWG) uninsulated	504-22-6436	80	yes	Gray	0.465	11.81	0.605	15.36	219	33	243	36
	3 Conductors 2-#15 AWG insulated 1-(2-#18 AWG) uninsulated	504-22-3437 504-22-3495	80 95	no	Gray	0.510	12.95	0.650	16.50	247 258	37 38	279 297	42 44
75kV	4 Conductors 2-#15 AWG 1-#20 AWG Copperweld, insulated 1-(3-#18 AWG) uninsulated	504-22-4464	80	no	Gray	0.570	14.48	0.715	18.20	296	44	335	50
75kV Extra Small Diameter	3 Conductors 2-#15 AWG insulated 1-(2-#18 AWG) uninsulated	504-22-3415	80	no	Gray	0.490	12.45	0.620	15.75	228	34	267	40
100kV	3 Conductors 2-#15 AWG insulated 1-(2-#18 AWG) uninsulated	▲ 504-22-3436 ▲ 504-22-4437	80	no yes	Gray	0.620	15.75	0.785	19.94	341	51	380	57
	4 Conductors 2-#15 AWG 1-#20 AWG Copperweld, insulated 1-(3#18 AWG) uninsulated	504-22-4436 504-22-4437	80	no yes	Gray	0.660	16.75	0.845	21.46	391	58	446	66
230kV	3 Conductors 2-#16 AWG insulated 1-(2-#18 AWG) uninsulated	▲ 504-22-7410	80	no	Black	0.980 ±.020	24.89 ±.51	1.250 ±.025	31.75 ±.64	759	113	849	126
250kV	3 Conductors 2-#14 AWG insulated 1-(#12 AWG) uninsulated	504-22-9430	80	no	Black	1.280 ±.020	32.51 ±.51	1.505 ±.025	38.23 ±.64	1119	167	1250	186

▲ Authorized stock item. Available from our Customer Service Centers.

(1) Cable is helically wrapped with a cellophane tape to maintain cleanliness during installation and includes a pull cord for ease of removal.

- Designs for special applications upon request.

- Refer to Product Data Section 6 Sheet 1 for X-Ray Cable - Low Noise constructions.

Electrical Characteristics				
Rated Voltage Rectified dc kV (2)	Number of Conductors	Core to Shield Capacitance ± 10%		4/C only: Copperweld grid lead capacitance = 70 pF/ft. (230 pF/m).
		pF/ft.	pF/m	
65	3	52	170	Conductor resistance @ 25°C: #16 AWG (1.31 mm ²) tinned copper = 4.18 ohms/1000 ft (1.37 ohms/100 m) #15 AWG (1.65 mm ²) tinned copper = 3.51 ohms/1000 ft (1.15 ohms/100 m) #18 AWG (0.83 mm ²) tinned copper = 7.16 ohms/1000 ft (2.34 ohms/100 m) 2 X #18 AWG (0.83 mm ²) tinned copper = 3.58 ohms/1000 ft (1.17 ohms/100 m) 3 X #18 AWG (0.83 mm ²) tinned copper = 2.39 ohms/1000 ft (0.78 ohms/100 m) #20 AWG (0.52 mm ²) copperweld = 24.12 ohms/1000 ft (7.91 ohms/100 m) #14 AWG (2.08 mm ²) tinned copper = 2.73 ohms/1000 ft (0.895 ohms/100 m) #12 AWG (3.31 mm ²) tinned copper = 1.72 ohms/1000 ft (0.564 ohms/100 m)
75 (ESD)	3	49.5	162	
75	3	47	154	
75	4	57	187	
100	3	40	131	
100	4	49	159	
230	3	35	115	
250	3	31	101	

(2) Voltage rating is between the conductor and the shielding braid.



Okonite X-Ray/Hi-Voltage Cable

65kV, 75kV and 100kV dc Rating
Three Conductor or Four Conductor

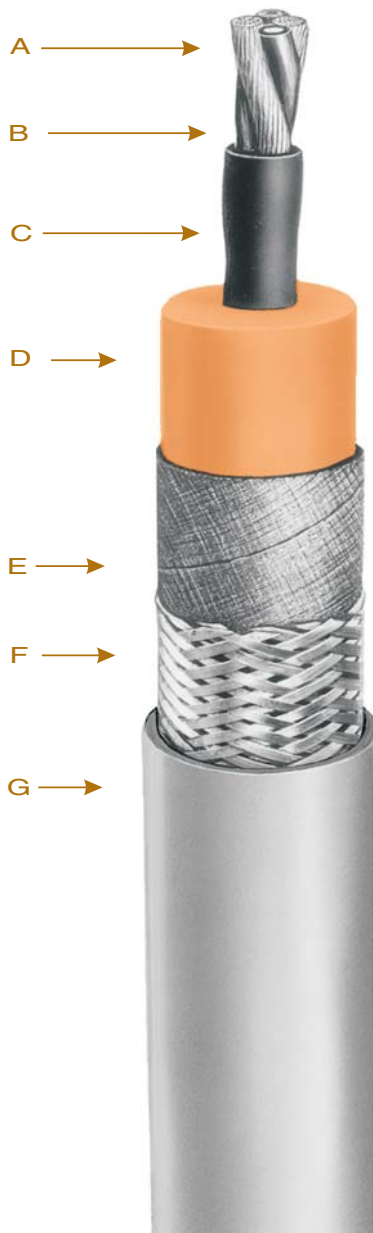

- A Coated Stranded Copper Conductors
- B Polyester Insulation
- C Extruded Semiconducting Layer
- D Insulation - Okoguard
- E Semiconducting Tape
- F Coated Copper Braid
- G Jacket - Okoseal

Applications

Okonite X-Ray cables are suitable for use on X-Ray apparatus for medical, industrial, research and control applications. They give trouble-free performance where pulse type high voltages are required. Although primarily used with medical diagnostic imaging equipment, Okonite X-Ray cables are also used with equipment in industrial applications as well as in research projects where high voltages, low power are required.

Typically, Okonite X-Ray cables are used to supply the anode and cathode voltages to the X-Ray tube. Since one terminal operates at a negative potential and the other at a positive potential, the voltage across the X-Ray tube is twice (2X) the rated voltage of the cable.

The two usual constructions are (1) three conductor (3/C) used on typical cathode cable installations, and (2) four conductor (4/C) utilized on installations with a grid controlled lead. Upon request, designs and constructions can be developed for special applications.

Product Features

- Performance tested for long trouble-free service.
- Small diameter.
- Flexible construction.
- Excellent flexing endurance.
- Mechanically rugged.
- Easy to strip and terminate.
- Resistant to most oils and chemicals.
- Complies with NEMA Standard XR-7 where applicable.

Installation

The minimum bending radius for permanent installation or flexing in service is four times the cable diameter.

Specifications

Cable Core: Each cable contains two #15 AWG (19x) [1.65mm²] tinned copper filament wires insulated with heat sealed color coded polyester tape. Three conductor cores include two uninsulated #18 AWG [0.83mm²] flex stranded tinned copper wires. Four conductor cables include one #20 AWG (7x)

[0.52mm²] copperweld conductor per ASTM - 45 insulated with heat sealed polyester and shielded with metalized red polyester. The four conductor core includes three uninsulated #18 AWG flex stranded tinned copper wires.

All conductors are twisted together into a composite assembly.

Core Shield: An extruded layer of semiconducting compound encapsulates the composite core assembly.

Insulation: Okonite's premium high voltage EPR (ethylene propylene rubber) insulation is extruded in tandem with the semiconducting compound ensuring an intimate contaminant free bond between the layers

Shield: A semiconducting tape is applied over the insulation with a tinned copper wire braid. Minimum coverage indicated in table.

Jacket: A light gray flexible Okoseal (specially compounded PVC) jacket is extruded over the shield to provide additional mechanical strength and resistance to most oils and chemicals.

Okonite X-Ray/Hi-Voltage Cable

65kV, 75kV, 100kV dc Rating

Three Conductor or Four Conductor

Product Data Section 6: Sheet 2

	Description	Catalog Number	#34 AWG T.C. Braid Coverage (%)	Cellophane Wrap (1)	Jacket Color	Insulation O.D. Inches ± 0.010	Insulation O.D. mm ± 0.25	Jacket O.D. Inches ± 0.015	Jacket O.D. mm ± 0.38	Net. Wt. (lbs/1000 ft.)	Net. Wt. (kg/100m)	Approx. Ship Weight (lbs/1000')	Approx. Ship Weight (kg/100m)
65kV	3 Conductors 2-#15 AWG insulated 1-(2-#18 AWG) un-insulated	504-22-6040	80	yes	Gray	0.465	11.81	0.605	15.40	219	33	252	38
		504-22-6041		no									
75kV	3 Conductors 2-#15 AWG insulated 1-(2-#18 AWG) un-insulated	▲ 504-22-3165	80	yes						236	35	273	41
		504-22-3164	80	no	Gray	0.510	12.95	0.650	16.50	236	35	273	41
		504-22-3836	95	yes						248	37	278	42
	4 Conductors 2-#15 AWG insulated 1-#20 AWG Copperweld, insulated 1-(3-#18 AWG) un-insulated	504-22-2164	80	no	Gray	0.570	14.48	0.715	18.20	289	43	333	50
75kV Extra Small Diameter	3 Conductors 2-#15 AWG insulated 1-(2-#18 AWG) un-insulated	▲ 504-22-3015	80	no	Gray	0.490	12.45	0.600	15.25	224	34	248	37
100kV	3 Conductors 2-#15 AWG insulated 1-(2-#18 AWG) un-insulated	504-22-1033	80	no	Gray	0.620	15.75	0.785	19.90	332	49	371	55
		504-22-1035		yes									
	4 Conductors 2-#15 AWG insulated 1-(#20 AWG) Copperweld, insulated 1-(3-#18 AWG) un-insulated	504-22-2041	80	no	Gray	0.660	16.75	0.845	21.50	380	57	441	66

▲ **Authorized stock item.** Available from our Customer Service Centers.

(1) Cable is helically wrapped with a cellophane tape to maintain cleanliness during installation and includes a pull cord for ease of removal.

- Designs for special applications upon request.

- Refer to Product Data Section 6 Sheet 1 for X-Ray Cable - Low Noise constructions.

Electrical Characteristics				
Rated Voltage Rectified dc kV (2)	Number of Conductors	Core to Shield Capacitance ± 10%		4/C only: Copperweld grid lead capacitance = 70 pF/ft. (230 pF/m).
		pF/ft.	pF/m	
65	3	52	170	Conductor resistance @ 25°C: #16 AWG (1.31 mm ²) tinned copper = 4.18 ohms/1000 ft (1.37 ohms/100 m) #15 AWG (1.65 mm ²) tinned copper = 3.51 ohms/1000 ft (1.15 ohms/100 m) #18 AWG (0.83 mm ²) tinned copper = 7.16 ohms/1000 ft (2.34 ohms/100 m) 2 X #18 AWG (0.83 mm ²) tinned copper = 3.58 ohms/1000 ft (1.17 ohms/100 m) 3 X #18 AWG (0.83 mm ²) tinned copper = 2.39 ohms/1000 ft (0.78 ohms/100 m) #20 AWG (0.52 mm ²) copperweld = 24.12 ohms/1000 ft (7.91 ohms/100 m)
75 (ESD)	3	49.5	162	
75	3	47	154	
75	4	57	187	
100	3	40	131	
100	4	49	159	
160	3	35	115	
250	3	31	101	
(2) Voltage rating is between the conductor and the shielding braid.				



Okoguard® Aerial Jumper Cable

15kV - 90°C Rating



- A Coated, Stranded Copper Conductor
- B Strand Screen
- C Insulation/Jacket-Okoguard

Insulation/Jacket

Okoguard is Okonite's registered trade name for its exclusive ethylene-propylene base, thermosetting compound, whose optimum balance of electrical and physical properties is unequaled in other solid dielectrics.

This durable Okoguard insulation serves as a jacket as well. It is permanently embossed with a legend and has a natural, highly visible, red color.

Applications

Okoguard Portable Jumper cables are designed as flexible power leads for use with tap-off or jumper clamps which permit temporary connections or "by-pass" of energized aerial lines operating at voltages up to and including 15000V (phase to phase).

Specifications

Power Conductors: Extra-flexible rope tin coated copper per ASTM B-33, flexible rope stranded.

Conductor Screen: A taped conductive screen, whose purpose is to improve service life, dielectric strength and eliminate internal corona, meets and exceeds ICEA Standard S-96-639.

Insulation: Okoguard meets and exceeds ICEA Standard S-93-639.

Product Features

- Extra-flexible conductors for ease of handling under adverse conditions.
- Conductor screen for improved voltage stress control.
- Heat, moisture and ozone resistant 90°C Okoguard Insulation/Jacket.
- Okoguard is red for visual attention and it has good color stability even when exposed to strong sunlight.
- Excellent low temperature properties.

Okoguard Aerial Jumper Cable

15kV - 90°C Rating

Product Data

Section 6: Sheet 4

Catalog Number	Conductor Size AWG	Min. No. Strands	Nominal Cdr. Diameter - Inches	Approx. O.D. - Inches	Approx. O.D. - mm	Approx. Net Weight (lbs./1000')	Approx. Ship Weight (lbs./1000')	Amps Per Cdr.
15kV - Okoguard Insulation: #2 AWG Through #4/0 AWG, 210 mils								
▲ 303-21-1934	2	259	0.319	0.780	19.8	425	480	192
▲ 303-21-1938	1/0	259	0.408	0.863	22.0	583	638	258
▲ 303-21-1940	2/0	259	0.450	0.910	23.3	687	752	298
▲ 303-21-1944	4/0	437	0.592	1.052	27.2	997	1092	400

▲ **Authorized Stock Item.** Available from our Customer Service Centers

Minimum Order Quantity is 150 ft.

Standard Package —1000' N.R. Reel. Standard package will be furnished where orders do not specify otherwise.

Ampacities

Ampacity based on 90°C conductor temperature, 40°C ambient temperature.
For ampacity correction factors covering various ambient temperatures:

Ambient Temperature Degrees		Correction Factor
C	F	
10	50	1.26
20	68	1.18
30	86	1.10
40	104	1.00
50	122	0.90



Okoguard®-Okolon® TS-CPE 5kV Airport Lighting Cable*

FAA-L-824 Type B

One Okopact (Compact Stranded) Copper Conductor/90°C Rating Wet or Dry

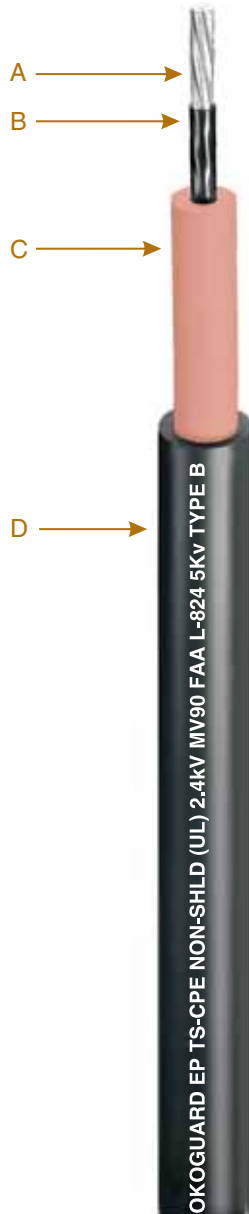

- A Uncoated, Okopact (Compact Stranded) Copper Conductor
- B Strand Screen-Extruded Semiconducting EPR
- C Insulation-Okoguard EPR
- D Jacket-Okolon TS-CPE

Insulation

Okoguard is Okonite's registered trade name for its exclusive medium voltage grade ethylene-propylene rubber (EPR) based, thermosetting compound, whose optimum balance of electrical and physical properties is unequaled in other solid dielectrics.

Okoguard insulation, with the distinctive red color and a totally integrated EPR system, provides the optimum balance for long, problem free service.

Jacket

The Okolon TS-CPE jacket on this cable is a vulcanized chlorinated polyethylene based compound which is mechanically rugged, flame, and oil resistant.

Applications

Okoguard-Okolon TS-CPE cables are heavy duty nonshielded cables designed for use at up to 5kV in wet or dry airport lighting applications.

Okoguard-Okolon TS-CPE nonshielded airport lighting cables are recommended for use in series lighting circuits for runways and control systems. Cables can be installed in metallic or non-metallic conduit, directly buried or aerial application.

Specifications

Meets or exceeds the requirements of FAA Advisory Circular AC 150/5345-7F.

Conductor: Annealed uncoated copper compact Class B stranded per ASTM B-496.

Strand Screen: Extruded semiconducting EPR strand screen. Meets or exceeds electrical and physical requirements of ICEA S-96-659/NEMA WC71.

Insulation: Meets or exceeds electrical and physical requirements of ICEA S-96-659/NEMA WC71. Insulation thickness per Table 4-3 for wet or dry applications.

Jacket: Meets or exceeds electrical and physical requirements of ICEA S-96-659/NEMA WC71 for chlorinated polyethylene jackets.

Product Features

- Resistant to runway and wing de-icers
- 90°C Continuous Rating, 130°C Emergency Overload Rating, 250°C Short Circuit Rating
- Exceptional resistance to surface tracking
- Superior Flexibility
- Constructed for "wet" location applications
- Excellent corona resistance
- Stress cones not required
- Resistant to most oils, acids, and alkalies

*Applications governed by the National Electrical Code limit non-shielded cable to 2.4kV

Catalog Number	Conductor** Size		Insulation Thickness		Jacket Thickness		Approx. O.D.		Approx. Net Wt. Lbs./1000'	Approx. Ship Wt. Lbs./1000'
	AWG	mm ²	mils	mm	mils	mm	inches	mm		
▲ 114-24-2213	8	8.4	125	3.18	80	2.03	0.60	15.1	215	250
▲ 114-24-2217	6	13.3	125	3.18	80	2.03	0.63	16.0	260	295

▲ **Authorized stock item.** Available from our Customer Service Centers.

**Class C stranded conductors are available.





Okonite® Armored Underground Signal Cables

With P.C.F. (Pull Cord Feature)

Heavy Duty Direct Burial Railroad Signal Cable

— AREMA Type I EPR Insulation — 600V

Multiple Copper Conductors/90°C Rating

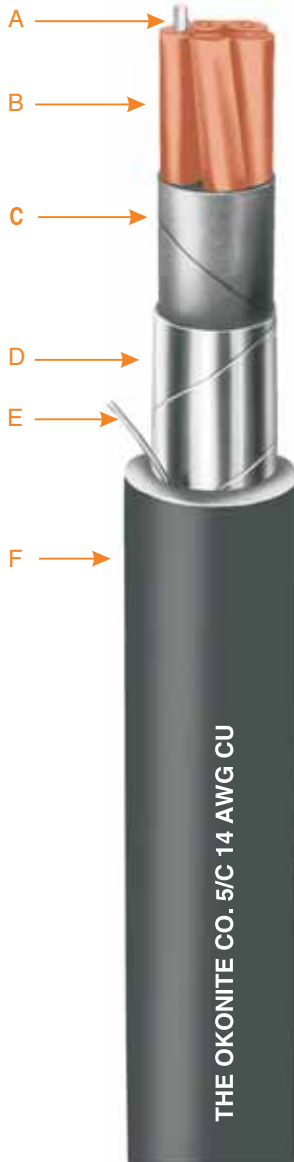

- A Solid or stranded, Uncoated Copper Conductors
- B Insulation—Okonite #14 AWG-#9 AWG 5/64", #6 - #2 AWG 6/64" with printed number code and tracer
- C Cushion Tape Layer
- D Flat Copper Alloy Armor Tape
- E Pull Cord
- F Jacket—Okolene with sequential footage markings

Insulation

Okonite EPR insulation is a heat, moisture and chemical resistant, mechanically rugged compound. The insulation thickness for size #14 AWG through #9 AWG is 5/64" and for #6 AWG through #2 AWG is 6/64". One conductor in each layer is identified as "Tracer". In addition, each conductor is number coded for ease of identification.

Assembly and Finish

Individual conductors are assembled with suitable fillers, where necessary, and a cable cushioning tape. A 7 mil flat copper alloy tape is then helically applied, giving outstanding mechanical protection. The black Okolene® (polyethylene) jacket is then applied overall.

Applications

Okonite Armored Underground Signal Cables are designed for use in all vital railroad signal circuits where security of service and long life are required in all vital circuit and safety related applications. These cables are recommended for use where crush resistance, termite and rodent protection are considerations and in all wet and dry locations.

Specifications

AREMA Signal Manual Part 10.3.17

Conductors: Solid uncoated copper per ASTM B-3, stranded uncoated compact round copper per ASTM B-496.

Insulation: Meets or exceeds electrical and physical requirements of ICEA S-95-658 (NEMA WC70) and AREMA Manual Part 10.3.19, thickness per table 10317-4.

Armor Tape: Copper alloy C19400 per ASTM B-465.

Jacket: Meets or exceeds electrical and physical requirements of ICEA S-95-658, Part 4.1.5.

Product Features

- Mechanically rugged.
- Resistant to aging.
- Easy to install and splice.
- Resistant to environmental hazards.
- Superior moisture resistance.
- Outstanding termite and rodent protection.
- Excellent electrical properties... high dielectric strength, low SIC and power factor and high insulation resistance.
- The Pull Cord feature affords easy and quick accessibility to conductors for splicing and terminating.
- Sequential footage markings on surface of outer jacket.

COMPOSITE CONSTRUCTIONS

Okonite Insulation: #14 AWG through #9 AWG 5/64", #6 AWG 6/64"

Catalog Number	Composite Make-Up	Conductors No. x Size (# Strands)	Conductors No. x Size (# Strands)	Outer Jacket Thickness 64th	Approx Cable O.D. (In.)	Approx Net Wt. Lbs./M'	Approx Ship Wt. Lbs./M
206-11-8974	7/C	2 x 9 (1X)	5 x 14 (1X)	5	0.99	523	574
▲ 206-11-8255	15/C	3 x 6 (1X)	12 x 14 (1X)	6	1.48	1711	1319
▲ 206-11-6283	19/C	6 x 6 (1X)	13 x 14 (1X)	6	1.69	1674	1877

▲ **Authorized Stock Item** - Available from Customer Service Centers.

Composite Cable Constructions are also available with stranded conductors. Consult your Okonite Representative.

Okonite Armored Underground Signal Cables

Product Data Section 7: Sheet 1

Okonite Insulation: #14 AWG Through #9 AWG, 5/64", #6 through #2 AWG, 6/64"

Catalog Number	Size AWG	No. of Strands (1)	No. Condrs.	Outer Jacket Thickness-64th	Approx. Cable O.D. Inches	Net Wt. Lbs./M'	Approx. Ship Wt. Lbs./M'
▲ 206-11-6882	14	Sol.	2	4	.65	208	241
206-11-6883	14	Sol.	3	4	.68	253	286
206-11-6884	14	Sol.	4	4	.74	300	338
▲ 206-11-6885	14	Sol.	5	4	.81	349	408
▲ 206-11-6887	14	Sol.	7	5	.91	451	510
206-11-6889	14	Sol.	9	5	1.05	579	671
206-11-6890	14	Sol.	10	5	1.12	698	790
▲ 206-11-6892	14	Sol.	12	5	1.17	700	792
206-11-6895	14	Sol.	15	6	1.33	871	994
206-11-6896	14	Sol.	16	6	1.33	906	1029
▲ 206-11-6899	14	Sol.	19	6	1.40	1028	1151
206-11-6901	14	Sol.	21	6	1.47	1127	1250
▲ 206-11-6907	14	Sol.	27	6	1.67	1388	1638
▲ 206-11-6910	14	Sol.	37	7	1.89	1834	2076
206-11-6692	12	Sol.	2	4	.68	240	273
206-11-6693	12	Sol.	3	4	.72	292	330
206-11-6694	12	Sol.	4	4	.78	354	392
206-11-6695	12	Sol.	5	4	.85	412	471
206-11-6697	12	Sol.	7	5	.96	535	594
206-11-6699	12	Sol.	9	5	1.11	689	781
206-11-6700	12	Sol.	10	5	1.19	774	866
206-11-6702	12	Sol.	12	5	1.24	847	952
206-11-6812	10	Sol.	2	4	.72	279	317
206-11-6813	10	Sol.	3	4	.76	346	384
206-11-6814	10	Sol.	4	4	.83	424	483
206-11-6815	10	Sol.	5	5	.94	518	577
206-11-6817	10	Sol.	7	5	1.02	654	746
206-11-6819	10	Sol.	9	5	1.18	842	934
206-11-6820	10	Sol.	10	6	1.30	973	1078
206-11-6822	10	Sol.	12	6	1.36	1076	1199
206-11-6922	9	Sol.	2	4	.75	317	350
▲ 206-11-6923	9	Sol.	3	4	.79	384	443
206-11-6924	9	Sol.	4	5	.90	495	554
▲ 206-11-6925	9	Sol.	5	5	.97	581	640
▲ 206-11-6927	9	Sol.	7	5	1.06	737	829
206-11-6928	9	Sol.	8	5	1.14	843	935
206-11-6929	9	Sol.	9	5	1.23	952	1057
▲ 206-11-6930	9	Sol.	10	6	1.35	1098	1221
206-11-6931	9	Sol.	12	6	1.42	1215	1338
▲ 206-11-6242	6	Sol.	2	5	.94	505	564
▲ 206-11-6243	6	Sol.	3	5	1.00	632	724
206-11-6244	6	Sol.	4	5	1.10	789	881
▲ 206-11-6245	6	Sol.	5	5	1.20	952	1044
▲ 206-11-6247	6	Sol.	7	6	1.34	1245	1368
206-11-6248	6	Sol.	8	6	1.45	1429	1552
206-11-6249	6	Sol.	9	6	1.56	1642	1820
▲ 206-11-6070	6	7	3	5	1.01	698	753
▲ 206-11-6042	4	7	2	5	1.02	619	674
▲ 206-11-6045	4	7	5	6	1.34	1266	1356
▲ 206-11-6130	2	7	3	6	1.28	1256	1346

Minimum Manufacturing Quantity is 1000 ft. Standard Package—1000' N.R. Reel.

▲ Authorized Stock Item - Available from Customer Service Centers.

(1) This construction is also available with stranded conductors. Consult your Okonite Representative.

E/14040701

 **THE OKONITE COMPANY**
Ramsey, New Jersey 07446



Okonite®-Okolene® Duplex Track Wire 600V

One Copper Conductor/90°C Rating



A Solid Uncoated Copper Conductors
B Insulation - Okonite-Sizes #9 AWG and #8 AWG-5/64", #6 AWG-6/64"
C Jacket-Okolene, Color Coded; 1-Black, 1-Red

Insulation

Okonite EPR is Okonite's trade name for its heat resistant, mechanically rugged ethylene-propylene based insulating compound. The insulation thickness for wire sizes #9 AWG is 5/64" and for #6 AWG is 6/64".

Jackets and Finishes

The Okolene (PE) jacket supplied with this cable provides excellent resistance to mechanical abuse, weathering and most acids, oils and alkalis. Color Coded; 1-Black, 1-Red.

Applications

Okonite-Okolene 600V Duplex Track Wire is recommended for use in track circuits, signal operations, car retarder and switch machine applications. Can be installed in either wet or dry locations, in conduit trays or trough or buried direct.

Specifications

Conductor: Solid uncoated copper per ASTM B-3.

Insulation: Per ICEA S-95-658, and AREMA Signal Manual Part 10.3.19.

Jacket: Meets or exceeds the physical and electrical requirements of ICEA S-95-658, and AREMA Signal Manual Part 10.3.21

Product Features

- Exceptional heat resistance.
- 90°C Continuous Rating
130°C Emergency Overload Rating.
250°C Short Circuit Rating.
- Mechanically rugged.
- Flexible, easy to handle and splice.
- Resistant to most oils, acids, alkalis and effects of weather.
- Stable electrical and physical properties.
- Excellent moisture resistance.

Okonite Insulation: #9 AWG, 5/64", #6 AWG, 6/64"

Catalog Number	Size AWG	No. of Strands	Jacket Thickness 64 th's	Approx. Duplexed O.D. (In.)	Approx. Net Wt. Lbs./M'	Approx. Ship Wt. Lbs./M'
150-12-3931	9	Solid	4	0.83"	199	243
▲ 150-12-3933	6	Solid	4	1.00"	329	404

▲ Authorized Stock Item: Available from our Customer Service Center
Standard Package -1000' Non-Returnable Reel





Okonite® TC Blue Tower and Case Wire

600 Volt

One Copper Conductor/90°C Rating



- A Uncoated, Stranded Copper Conductor
- B Insulation—Okonite
- C Jacket—Blue Okoseal

Insulation

Okonite EPR is Okonite's trade name for its heat resistant, mechanically rugged ethylene-propylene based insulating compound. The insulation thickness for wire sizes are listed below.

Jackets and Finishes

The Blue Okoseal® (PVC) jacket supplied with this cable provides excellent resistance to mechanical abuse, flame, weathering, and most acids, oils, and alkalis.

Applications

Okonite Tower and Case Wire is recommended for use as relay and associated signal apparatus wiring and for connector wire use where a flexible, small diameter wire is required.

Specifications

Conductor: Uncoated stranded copper stranded per ASTM B-8.

Insulation: Per ICEA S-95-658. Meets or exceeds all requirements for EPR insulation.

Jacket: Per ICEA S-95-658. Meets or exceeds all requirements.

Okonite Tower and Case Wire meets or exceeds the requirements of AREMA Manual Part 10.3.15.

Product Features

- Exceptional heat resistance.
- 90°C Continuous Rating
130°C Emergency Overload Rating.
250°C Short Circuit Rating.
- Mechanically rugged.
- Flexible, easy to handle and splice.
- Flame resistant—meets U.L. horizontal flame test.
- Resistant to most oils acids, alkalis and effects of weather.
- Stable electrical and physical properties.

Catalog Number	Size AWG	No. of Strands	Insulation Thickness Mils	Jacket Thickness Mils	Approx. O.D. (In.)	Approx. Net Wt. Lbs./m'	Approx. Ship Wt. Lbs./m'
▲ 152-11-3002	16	19	30	20	.17	20	24
▲ 152-11-3024	14	19	30	20	.20	26	28
152-11-3026	12	19	45	20	.23	42	46
▲ 152-11-3038	10	19	30	20	.23	56	60
152-11-3108	10	37	45	20	.26	58	62
152-11-3010	9	19	45	25	.29	71	75

▲ **Authorized Stock Item** - Available from our Customer Service Centers.

Note: The construction described has a Blue Jacket. Consult your local Okonite Representative for details about alternate colors.

Standard Package - #16 AWG and #14 AWG, 10000 spool; #12 AWG, #10 AWG, and #9 AWG, 500' spool.





Okonite® Okolon® - (TS-CPE) Case Wire 600V

One Copper Conductor/90°C Rating



- A Uncoated, Stranded Copper Conductor
- B Insulation—Okonite—#16 AWG and #14 AWG - 2/64"; #12 AWG thru #6 AWG - 3/64"
- C Jacket - Okolon TS-CPE

Insulation

Okonite EPR is Okonite's trade name for its heat resistant, mechanically rugged ethylene-propylene based insulating compound. The insulation thickness for wire size #16 AWG and #14 AWG is 2/64" and for #12 AWG and #10 AWG it is 3/64".

Jackets and Finishes

The Okolon (TS-CP) jacket supplied with this cable provides excellent resistance to mechanical abuse, flame, weathering and most acids, oils and alkalies.

Applications

Okonite Okolon (TS-CP) 600V Case Wire is recommended for use as relay and associated signal apparatus wiring and for connector wire use where a flexible, small diameter wire is required.

Specifications

Conductor: Uncoated stranded copper per ASTM B-8.

Insulation: Per ICEA S-95-658.

Jacket: Per ICEA S-95-658, Part 4.1.13 and 4.1.3.

Product Features

- Exceptional heat resistance.
- 90°C Continuous Rating
130°C Emergency Overload Rating.
250°C Short Circuit Rating.
- Mechanically rugged.
- Flexible, easy to handle and splice.
- Flame resistant — meets U.L. horizontal flame test.
- Resistant to most oils, acids, alkalies and effects of weather.
- Stable electrical and physical properties.

Okonite Insulation: #16 AWG and #14 AWG - 2/64"; #12 AWG to #6 AWG - 3/64"

Catalog Number	Size AWG	No. of Strands	Jacket Thickness 64 th's	Approx. O.D. (In.)	Approx. Net Wt. Lbs./M'	Approx. Ship Wt. Lbs./M'
151-12-1051	16	19	1	.16	20	24
▲151-12-1081	14	19	1	.18	26	30
151-12-1101	12	19	1	.23	42	46
151-12-1140	10	19	1	.25	58	62
151-12-1171	9	19	1	.26	67	75
▲151-12-1201	6	19	1	.31	112	122

▲ Authorized Stock Item - Available from Customer Service Centers.

Standard Package — #16 AWG and #14 AWG, 1000' spool; #12 AWG thru #6 AWG, 500' spool.





Okonite®-Nylon Braid Case Wire

600V

One Copper Conductor/90°C Rating



A Uncoated, Stranded Copper Conductor
B Insulation—Okonite #16 and #14 AWG 2/64"; #12 AWG through #9 AWG 3/64"
C Finish—Nylon Braid with Lacquer Overall

Insulation

Okonite EPR is Okonite's trade name for its heat resistant, mechanically rugged ethylene-propylene based insulating compound. The insulation thickness for wire sizes #16 AWG and #14 AWG is 2/64" and for #12 AWG through #9 AWG it is 3/64".

Finish

The nylon braid and lacquer finish supplied with this cable provides excellent resistance to mechanical abuse, weathering and most oils, acids and alkalis.

Applications

Okonite-Nylon Braid 600V Case Wire is recommended for use as relay and associated signal apparatus wiring, and for connector wire use where a flexible, small diameter wire is required.

Specifications

Conductor: Uncoated, stranded copper conductor per ASTM B-8.

Insulation: Per ICEA S-95-658.

Finish: Black nylon braid (100% coverage) with clean lacquer finish.

Product Features

- Mechanically rugged.
- 90°C Continuous Rating
130°C Emergency Overload Rating.
250°C Short Circuit Rating.
- Mechanically rugged.
- Flexible, easy to handle and splice.
- Resists most oils, acids, alkalis and effects of weather.
- Stable electrical and physical properties.

Nominal Finish Thickness: 5 mils

Catalog Number	Size AWG	No. of Strands	Insulation Thickness 64 th's	Approx. O.D. (In.)	Approx. Net Wt. Lbs./M'	Approx. Ship Wt. Lbs./M'
▲ 151-12-9051	16	19	2	.14	16	20
151-12-9081	14	19	2	.15	22	26
151-12-9111	12	19	3	.20	38	42
151-12-9145	10	19	3	.22	50	54
▲ 151-12-9161	10	37	3	.23	51	55
151-12-9181	9	19	3	.24	62	66

▲ **Authorized Stock Item** — Available from our Customer Service Centers

Standard Package — #16 AWG and #14 AWG, 1000' spool;
#12 AWG, #10 AWG, and #9 AWG, 500' spool.





Type DEL

600-2000V Diesel-Electric Locomotive, Motor Traction and Car Wire

One Copper Conductor/90°C — 110°C Hot Spot Rating



- A Coated Stranded Copper Conductor
- B Separator (sizes 36,700 CM and larger)
- C Insulation - Okonite
- D Jacket - Okolon TS-CPE

Insulation

Okonite EPR® is Okonite's trade name for its heat resistant, mechanically rugged ethylene-propylene based insulating compound. The insulation thickness for DEL numbers 002 and 004 is 2/64", for 008 through 016 is 3/64", 018 through 026 is 4/64", 030 through 040 is 5/64", 044 and 048 is 6/64", 050 through 056 is 7/64" and for 058 it is 8/64".

Jackets and Finishes

The Okolon TS-CPE jacket supplied with this cable provides excellent resistance to mechanical abuse, flame, weathering, most oils, acids and alkalis.

Applications

Okonite Type DEL, Diesel-Electric Locomotive Traction and Car Wires is designed for use in locomotives and car equipment circuits where reliability is for prime consideration. DEL can also be used in other low voltage applications where flexibility is important. It is suitable for use in wet or dry locations, in conduits, ducts, cable troughs or trays.

Specifications

Conductor: Coated copper stranded per AREMA Recommended Practice, Section M, RP-588, as applicable and ICEA S-95-658.

Insulation: Per AREMA Recommended Practice, Section M, RP-588, as applicable and ICEA S-95-658.

Jacket: Per AREMA Recommended Practice, Section M, RP-588, as applicable and ICEA S-95-658.

Product Features

- Extreme heat resistance.
- Extra flexible conductor.
- 90°C Continuous Rating, 110°C Hot Spot Rating, 130°C emergency Overload Rating, 300°C Short Circuit Rating.
- Mechanically rugged.
- Exceptional resistance to deformation and cut through at high temperature.
- Excellent flame resistance. Meets both UL vertical and horizontal flame test requirements.
- Resistant to oils, weather and most chemicals and alkalis.
- Stable electrical properties at high temperatures.
- Meets the RHH/RHW requirements of NEC/UL and can be labeled as such on special orders.

Type DEL

600-2000V Diesel - Electric Locomotive, Motor Traction and Car Wire

One Copper Conductor/90°C - 110°C Hot Spot Rating

Product Data Section 7: Sheet 17

Catalog Number	DEL Number	Size AWG or MCM	No. of Strands	Thickness 64ths		Voltage Rating	Approx. O.D. In.	Approx. Wt. Lbs./M'		Ampacity ac or dc		Conduit Size Inches ³	DC Resis @ 25°C ohms/1000'
				Ins.	Jkt.			Net	Ship	1/C in Air ¹	3/C in Duct ²		
▲ 112-11-1702	002	16	19 X .0117	2	1	600	.16	19	23	—	18	1/2"	4.490
112-11-1704	004	14	19 X .0142	2	1	600	.17	24	28	—	22	1/2"	2.790
112-11-1708	008	14	19 X .0147	3	1	2000	.21	31	35	—	23	1/2"	2.790
112-11-1710	010	12	19 X .0179	3	1	2000	.22	40	44	—	26	1/2"	1.720
▲ 112-11-1714	014	10	27 X .0201	3	1	2000	.26	58	60	55	37	3/4"	1.100
112-11-1716	016	8	37 X .0201	3	1	600	.28	74	78	83	42	3/4"	0.690
112-11-1718	018	6	61 X .0201	4	2	2000	.38	133	141	109	73	1"	0.440
112-11-1720	020	5	91 X .0201	4	2	2000	.44	182	200	122	91	1 1/4"	0.350
112-11-1722	022	4	105 X .0201	4	2	2000	.46	204	222	145	98	1 1/4"	0.280
112-11-1724	024	3	125 X .0201	4	2	2000	.48	223	241	167	107	1 1/4"	0.220
112-11-1726	026	2	150 X .0201	4	2	2000	.53	278	298	192	125	1 1/2"	0.180
112-11-1730	030	1	225 X .0201	5	3	2000	.68	459	497	223	160	2"	0.140
112-11-1732	032	1/0	275 X .0201	5	3	2000	.71	504	550	258	184	2"	0.110
112-11-1734	034	2/0	325 X .0201	5	3	2000	.75	579	633	298	202	2"	0.090
112-11-1738	038	3/0	450 X .0201	5	3	2000	.85	769	842	345	252	2 1/2"	0.070
112-11-1740	040	4/0	550 X .0201	5	3	2000	.90	912	985	400	285	2 1/2"	0.060
112-11-1744	044	313.1	775 X .0201	6	3	2000	1.06	1263	1371	515	364	3"	0.040
112-11-1748	048	444.4	1100 X .0201	6	3	2000	1.20	1722	1830	645	450	3 1/2"	0.030
112-11-1750	050	535.3	1325 X .0201	7	4	2000	1.36	2118	2263	725	493	4"	0.020
112-11-1752	052	646.4	1600 X .0201	7	4	2000	1.45	2490	2700	815	555	4"	0.018
112-11-1754	054	777.7	1925 X .0201	7	4	2000	1.55	2938	3148	910	608	5"	0.016
112-11-1756	056	929.2	2300 X .0201	7	4	2000	1.65	3350	3560	1025	664	5"	0.013
112-11-1758	058	1111.1	2750 X .0201	8	4	2000	1.80	3786	4072	1145	728	5"	0.011

▲ **Authorized Stock Item** - Available from Customer Service Centers.

Standard Package - 1000' Non-Returnable Reel; #16 #8 - 1000' coil in carton; #6 - 500' coil in carton; #5 - #4/0 - 2000' N.R. Reel; #313.1 MCM and Larger - 1000' N.R. Reel

¹ Ampacities based on single conductor in free air, 90°C conductor temperature, 40°C ambient air temperature per ICEA S-75-381.

² Three (3) conductors in a single enclosed or exposed conduit. Ampacities based on 90°C conductor temperature and 40°C ambient using ICEA methods. For 30°C ambient multiply values by 1.10; for 50°C multiply by 0.90. For other ambients or installation conditions, refer to Engineering Data Book.

³ Based on three (3) conductors in conduit with a fill of 40% or less.



C-L-X Terminating Tool Kit



C-L-X TERMINATING TOOL KIT CONTENTS

- | | |
|--|---------------------------|
| 1 Cable Slitting Saw | 1 5/16" x 11" Screwdriver |
| 1 Small Cable Guide | 1 Cable Knife, 4" blade |
| 12 2" dia. High Speed Steel Saw Blades | 1 Hacksaw Blade Holder |
| 1 Tubing Cutter | 3 10" Hacksaw Blades |
| 1 Channel Lock Pliers | 1 Tool Case |
| 1 10" Retractable Tape | 1 Padlock with 2 keys |

PACKAGING

Catalog Number	Description	Net Weight (lbs.)	Shipping Weight (lbs.)
C-L-X Terminating Tool Kit			
▲ 606-01-1026	Electric - 120 Volt ac	15 1/2	16
▲ 606-01-1526	Pneumatic - 90psi	15 1/2	16
Cable Slitting Saw, Small Cable Guide and 12 High Speed steel saw Blades			
▲ 606-01-0026	Electric - 120 Volt ac	13 1/2	14
▲ 606-01-0526	Pneumatic - 90psi	13 1/2	14
12 High Speed Steel Saw Blades			
▲ 606-01-5754	2" diameter, 7 teeth per inch, packaged in a round tin container	1/2	1/2

▲ Authorized Stock Item

Applications

The C-L-X Terminating Tool Kit contains all the tools required to remove the overall jacket and aluminum sheath from C-L-X power, control, and instrumentation cables. The Cable Slitting Saw may also be used on interlocked armor and lead sheathed cables. The Cable Slitting Saw provides a simple and efficient means of removing the aluminum C-L-X sheath. It is available in either an electric or a pneumatic model. Both models have a retractable blade guard to protect the user.

The electric model is powered by a 2500 rpm, 120 Volt ac double insulated motor. A 220 Volt ac model is also available.

The lightweight pneumatic model is powered by a 2200 rpm motor which requires 90 psi of air pressure for maximum efficiency. The Small Cable Guide keeps the saw centered on the cable when slitting cables of 1" diameter or less.

The High Speed Steel Saw Blades provide a smooth cut in the aluminum sheath and have a cutting depth of 3/8" without the cable guide.

Removing the C-L-X Armor

This procedure applies to all types of C-L-X armor - aluminum, copper, bronze and stainless steel. Safe working practices are to be observed, e.g., safety glasses and work gloves. Practice sessions are recommended to familiarize all concerned with the procedures and equipment.

1. Remove the jacket to expose the desired length of un-armored cable within the enclosure.
2. Refer to the C-L-X fitting instructions for the length of C-L-X armor to be exposed beyond the end of the jacket and mark the C-L-X armor at the top of the crown nearest to that point.

- For C-L-X Diameters 1 5/8" and Smaller, Go To Steps 10 through 12.

- For C-L-X Diameters greater than 1 5/8" Follow Steps 3. Through 9.

C-L-X Terminating Tool Kit

3. First the C-L-X armor will be circumferentially cut using a hacksaw blade, (note the C-L-X saw tool kit is supplied with a hacksaw blade and blade holder) cut through the crown (high point) of the C-L-X at an angle so as to connect (or bridge) the valleys (low points) on both sides of the crown.
4. Again using a hacksaw blade, make a circumferential score in the valleys adjacent to the cut crown connecting both sides of the crown cut to the valleys. Do not cut through armor in valleys.
5. Holding the score area rigid, flex the cable by moving the free end so as to break the score around the circumference of the cable.
6. Next the C-L-X will be longitudinally cut by performing the following:

Note on the C-L-X Saw - The longitudinal cut is made with the C-L-X saw, which has an adjustable positive depth stop that can be set so the saw blade cuts through the crowns and partially cuts through the valleys. A proper saw depth is achieved when 80 to 95 % of the metal in the valley is removed. Use an extra piece of the cable being terminated to adjust the blade depth and practice.

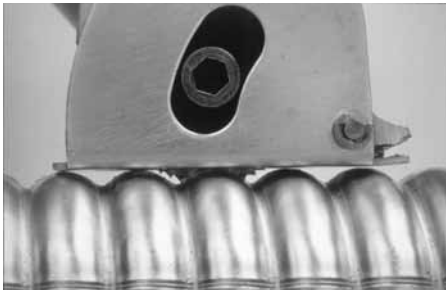

Set blade to remove 80 to 95% of the metal thickness in the valley.

7. With cable secured, start at the free end of the cable and advance the Kett saw, making sure to use slight downward pressure to maintain the depth of cut along the cable, to the ring cut. When advancing the saw, be sure maintain a straight line by cutting along the high point of the cable; this affects the cut depth also. See following:

Proper Saw Position

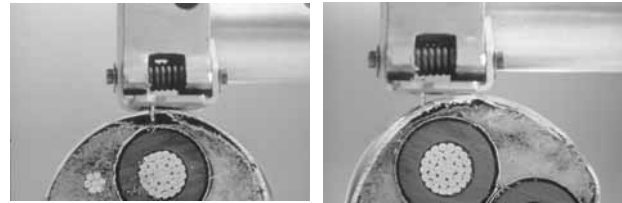

Correct

Incorrect

If it is necessary to stop cutting or if a portion of the cut is to be repeated, use caution when reinserting the blade as kickback may occur.

8. At the completion of the longitudinal cut, starting at the free end, insert a wide blade screwdriver into the cut and twist. Repeat until the ring cut is reached. This will cause the remaining metal in the valleys to break open and the armor to loosen on the cable. Do not drive the screwdriver into the cut with excessive force as this may damage the underlying conductors.
9. Slide the armor off the cable. In the event that the armor is tight around the cable, pliers may be used to grab the armor at the split and pull it away from the cable. For large diameter cables, where long lengths of armor are to be removed, two cuts spaced 180° apart are recommended so that the armor may be removed in two pieces.
 - For C-L-X Diameters 1 5/8" and Smaller Follow Steps 10. Through 13.
10. Using a hacksaw blade or tubing cutter, circumferentially score the C-L-X armor. Grip the cable in both hands with the score centered between hands, and flex the cable at the score line until it opens. Slide the sheath off the cable.
11. For C-L-X cables with an inner jacket or cable constructions where the C-L-X armor is tight fitting around the insulated conductors, the C-L-X saw should be used with the optional red colored cable guide. This guide assists in centering the saw on small diameter cable. The procedures and precautions of steps 3 to 9 apply here also.
12. Remove the cable fillers and marker tape and install the C-L-X fitting as per the manufacturer's instructions. The cable is now ready to be terminated into the enclosure.

CONDUCTOR COLOR CODING SEQUENCE

ICEA S-73-532 TABLE E-2
Color Sequence (No Green or White Conductors)

Conductor Number	Base Color	Tracer Color
1	Black	—
2	Red	—
3	Blue	—
4	Orange	—
5	Yellow	—
6	Brown	—
7	Red	Black
8	Blue	Black
9	Orange	Black
10	Yellow	Black
11	Brown	Black
12	Black	Red
13	Blue	Red
14	Orange	Red
15	Yellow	Red
16	Brown	Red
17	Black	Blue
18	Red	Blue
19	Orange	Blue
20	Yellow	Blue
21	Brown	Blue
22	Black	Orange
23	Red	Orange
24	Blue	Orange
25	Yellow	Orange
26	Brown	Orange
27	Black	Yellow
28	Red	Yellow
29	Blue	Yellow
30	Orange	Yellow
31	Brown	Yellow
32	Black	Brown
33	Red	Brown
34	Blue	Brown
35	Orange	Brown
36	Yellow	Brown
37	Black	

Color Coding per ICEA
Method 1, E-2
Sizes 8 AWG and larger:
Surface Printing of Numbers per
ICEA Method 4

Special Order: Any or all of the following conductors may be added when specifically requested by the customer to meet his specific application requirements. These conductor codings comply with UL and NEC requirements

Purpose	Base Color	Tracer Color
Equipment Grounding	Uninsulated	
	Green	
	Green	1 or more continuous yellow stripes
Grounded	White	
	White	Black continuous stripe
	White	Red continuous stripe
	White	Blue continuous stripe
	White	Orange continuous stripe
	White	Brown continuous stripe
	White	Numeric Printing

CONDUCTOR COLOR CODING SEQUENCE

ICEA S-73-532 TABLE E-1
Color Sequence (INCLUDES GREEN AND WHITE CONDUCTORS)

Conductor Number	Base Color	Tracer Color
1	Black	—
2	White	—
3	Red	—
4	Green	—
5	Orange	—
6	Blue	—
7	White	Black
8	Red	Black
9	Green	Black
10	Orange	Black
11	Blue	Black
12	Black	White
13	Red	White
14	Green	White
15	Blue	White
16	Black	Red
17	White	Red
18	Orange	Red
19	Blue	Red
20	Red	Green
21	Orange	Green

CONDUCTOR IDENTIFICATION INFORMATION

E-1 Color sequences for utility conductor identification, see Appendix E, Table E-1, ICEA Standard S-73-532, includes green and white.

E-2 Color sequence for industrial conductor identification, see Appendix E, Table E-2, ICEA Standard S-73-532, excludes green and white.

METHOD-1 Conductor identification, colored compounds with tracers in accordance with the ICEA standard.

METHOD-2 Conductor identification, neutral compounds with tracers in accordance with the ICEA Standard.

METHOD-3 Conductor identification, neutral or single colored compounds with surface printing of numbers and color designations in accordance with the ICEA Standard.

METHOD-4 Conductor identification, neutral or single colored compounds with surface printing of numbers in accordance with the ICEA Standard.

METHOD-5 Conductor identification, individual color coding with braids in accordance with the ICEA Standard.

MISCELLANEOUS INFORMATION

Decimal equivalents of one inch

Table 9-2

8ths	16ths	32nds	64ths	Decimal
—	—	—	1	.015625
—	—	1	2	.03125
—	—	—	3	.046875
—	1	2	4	.0625
—	—	—	5	.078125
—	—	3	6	.09375
—	—	—	7	.109375
1	2	4	8	.125
—	—	—	9	.140625
—	—	5	10	.15625
—	—	—	11	.171875
—	3	6	12	.1875
—	—	—	13	.203125
—	—	7	14	.21875
—	—	—	15	.234375
2	4	8	16	.25
—	—	—	17	.265625
—	—	9	18	.28125
—	—	—	19	.296875
—	5	10	20	.3125

Useful Identities, Equations and Conversion Factors

1 mil = 0.001"

1 circular mil = (1 mil)²

Area of a circle = Πr^2 or $\Pi D^2/4$

where,

$\Pi = 3.1416$

r = radius

D = diameter

1 mm = 39.4 mils

1 mile = 5280 ft

1 km = 0.6214 miles

1 km = 3281 ft

1 mile = 1.609 km

1 inch = 25.4 mm

1 meter = 3.281 ft

1 meter = 39.37 inches

1 ton (US) = 2000 lbs

To Convert	Multiply by	To Obtain
mils	0.0254	millimeters
circular mils	5.07×10^{-4}	square millimeters
inches	1.0×10^3	mils
inches	25.4	millimeters
feet	3.048×10^{-4}	kilometers
miles	1.609	kilometers
kilometers	0.6214	miles
kilometers	3.281×10^3	feet
pounds	0.4536	kilograms
pounds	4.448	Newtons (joules/meter)
pounds/ft	1.488	kilograms/meter
tons (US)	0.9078	tons (metric)
psi	0.00689	megapascals (Mpa)
volts/mil	0.03937	kV/mm
ohms/1000 ft	3.28	ohms/km
gigaohms - 1000 ft	305	gigaohms-meter

Temperature conversion table

Table 9-3

TO CONVERT DEGREES		
To C	F or C	To F
-65.	-85	-121
-62.22	-80	-112
-59.45	-75	-103
-56.67	-70	-94
-53.89	-65	-85
-51.11	-60	-76
-48.34	-55	-67
-45.56	-50	-58
-42.78	-45	-49
-40.	-40	-40
-37.22	-35	-31
-34.44	-30	-22
-31.67	-25	-13
-28.89	-20	-4
-26.11	-15	5
-23.33	-10	14
-20.56	-5	23
-17.78	0	32
-15.	5	41
-12.22	10	50
-9.44	15	59
-6.67	20	68
-3.89	25	77
-1.11	30	86
1.67	35	95
4.44	40	104
7.22	45	113
10.	50	122
12.78	55	131
15.56	60	140
18.33	65	149
21.11	70	158
23.89	75	167
26.67	80	176
29.44	85	185
32.22	90	194
35.	95	203
37.78	100	212
40.56	105	221
43.33	110	230
46.11	115	239
48.89	120	248
51.67	125	257
54.44	130	266
57.22	135	275
60.	140	284
62.78	145	293
65.56	150	302
68.33	155	311
71.11	160	320
73.89	165	329
76.67	170	338
79.44	175	347
82.22	180	356
85.	185	365
87.78	190	374
90.56	195	383
93.33	200	392
96.11	205	401
98.89	210	410
101.67	215	419
104.44	220	428
107.22	225	437
110.	230	446
112.78	235	455
115.56	240	464
118.33	245	473
121.11	250	482
123.89	255	491
126.67	260	500
129.44	265	509
132.22	270	518
135.	275	527

NOTES

NOTES
