

Beam and Purlin Clamps

Beam Clamps

- Supports threaded rod, threaded bridle rings and electrical boxes
- Bright zinc plating
- Supports 100 lbs. static load limit

Malleable Iron, Electro-Plated Finish

CAT. NO.	FIG. NO.	DESCRIPTION	STATIC LOAD LIMIT (LBS.)	STD. CTN.
BC1-TB	1	Steel beam clamp, 1/4"-20 threaded openings, fits flanges up to 3/8" thick	75	50
BC2-TB	1	Steel beam clamp, 3/8"-18 threaded openings, fits flanges up to 3/4" thick	320	50
510	2	Malleable iron beam clamp, 1/4"-20 threaded openings, fits flanges up to 3/8" thick	250	100
511-SC	2	Malleable iron beam clamp, 10-24 threaded openings, fits flanges up to 3/8" thick	250	100
500-SC	2	Malleable iron beam clamp, 1/4"-20 threaded openings, fits flanges up to 1 1/16" thick	250	50
509	2	Malleable iron beam clamp, 10-24 threaded openings, fits flanges up to 1 1/16" thick	150	100
501	2	Malleable iron beam clamp, 1 5/16"-18 threaded openings, fits flanges up to 7/8" thick	500	50
502	2	Malleable iron beam clamp, 3/8"-16 threaded openings, fits flanges up to 1" thick	750	25
503-SC	2	Malleable iron beam clamp, 1/2"-13 threaded openings, fits flanges up to 1" thick	1,250	20
507	2	Malleable iron beam clamp, 1/2"-13 threaded openings, fits flanges up to 1 3/8" thick	1,250	20
508	2	Malleable iron beam clamp, 1/2"-13 threaded openings, fits flanges up to 2 1/8" thick	1,250	10

Safety Factor of 3. Load Ratings based on bottom hole of Beam Clamp. CSA File No. LR-63683.

CAT. NO.	SIZE	TAPPED	DIMENSIONS (IN.)				STD. CTN.
			A	B	C	D	
BC1-TB	1	1/4-20	1 1/16	1 3/8	5/8	1 3/16	250
BC2-TB	2 1/16	3/8-16	2 1/2	2 1/8	3/4	1 1/16	25

Material: Steel. Finish: Zinc Plated.

Malleable Iron, Silver Electro-Plated Finish

CAT. NO.	BASE SIZE (IN.)		JAW OPENING (IN.)	TAPPING OF BASE AND BACK HOLES	LOAD RATING†	TORQUE IN INCH-LBS.	STD. CTN.
	A	B					
500-SC	1	1 1/4	1 1/16	1/4-20	250	60	50
501	1 1/2	1 3/8	7/8	5/16-18	500	60	50
502	2	2	1	3/8-16	750	125	25
503-SC	2 5/8	2 1/2	1	1/2-13	1,250	250	20
507	2 1/2	2 3/8	1 3/4	1/2-13	1,250	250	20
508	2 1/2	2 3/8	2 1/8	1/2-13	1,250	250	10
509	1	1 1/4	1 1/16	10-24	150	60	100
510	2 7/32	1 1/8	5/8	1/4-20	250	40	100
511-SC	2 7/32	1 1/8	5/8	10-24	150	40	100

†Safety Factor of 3. Load Ratings based on bottom hole of Beam Clamp. CSA File No. LR-63683.

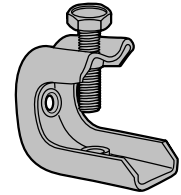
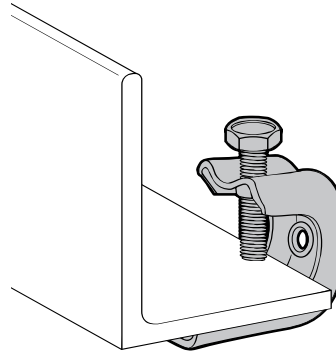

Fig. 1

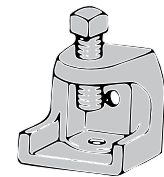
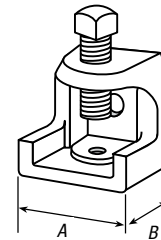
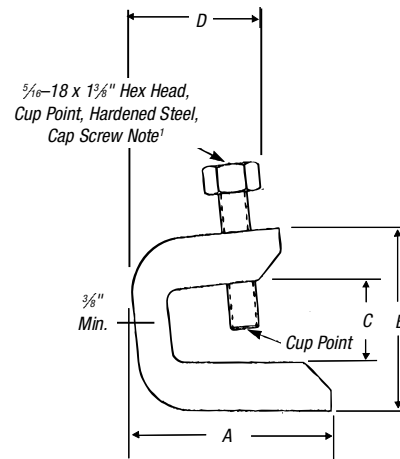

Fig. 2



500SS316, 502SS316 and 503SS316 in 316 Stainless Steel also available.

Beam and Purlin Clamps

Beam Clamps

- Supports threaded rod, threaded bridle rings and electrical boxes
- Bright zinc plating
- Supports 100 lbs. static load limit

Malleable Iron, Electro-Plated Finish

CAT. NO.	FIG. NO.	DESCRIPTION	STATIC LOAD LIMIT (LBS.)	STD. CTN.
BC1-TB	1	Steel beam clamp, 1/4"-20 threaded openings, fits flanges up to 3/8" thick	75	50
BC2-TB	1	Steel beam clamp, 3/8"-18 threaded openings, fits flanges up to 3/4" thick	320	50
510	2	Malleable iron beam clamp, 1/4"-20 threaded openings, fits flanges up to 3/8" thick	250	100
511-SC	2	Malleable iron beam clamp, 10-24 threaded openings, fits flanges up to 3/8" thick	250	100
500-SC	2	Malleable iron beam clamp, 1/4"-20 threaded openings, fits flanges up to 1 1/16" thick	250	50
509	2	Malleable iron beam clamp, 10-24 threaded openings, fits flanges up to 1 1/16" thick	150	100
501	2	Malleable iron beam clamp, 1 1/4"-18 threaded openings, fits flanges up to 7/8" thick	500	50
502	2	Malleable iron beam clamp, 3/8"-16 threaded openings, fits flanges up to 1" thick	750	25
503-SC	2	Malleable iron beam clamp, 1/2"-13 threaded openings, fits flanges up to 1" thick	1,250	20
507	2	Malleable iron beam clamp, 1/2"-13 threaded openings, fits flanges up to 1 3/8" thick	1,250	20
508	2	Malleable iron beam clamp, 1/2"-13 threaded openings, fits flanges up to 2 1/8" thick	1,250	10

Safety Factor of 3. Load Ratings based on bottom hole of Beam Clamp. CSA File No. LR-63683.

CAT. NO.	SIZE	TAPPED	DIMENSIONS (IN.)				STD. CTN.
			A	B	C	D	
BC1-TB	1	1/4-20	1 1/16	1 3/8	5/8	1 3/16	250
BC2-TB	2 1/16	3/8-16	2 1/2	2 1/8	3/4	1 1/16	25

Material: Steel. Finish: Zinc Plated.

Malleable Iron, Silver Electro-Plated Finish

CAT. NO.	BASE SIZE (IN.)		JAW OPENING (IN.)	TAPPING OF BASE AND BACK HOLES	LOAD RATING†	TORQUE IN INCH-LBS.	STD. CTN.
	A	B					
500-SC	1	1 1/4	1 1/16	1/4-20	250	60	50
501	1 1/2	1 3/8	7/8	5/16-18	500	60	50
502	2	2	1	3/8-16	750	125	25
503-SC	2 5/8	2 1/2	1	1/2-13	1,250	250	20
507	2 1/2	2 3/8	1 3/4	1/2-13	1,250	250	20
508	2 1/2	2 3/8	2 1/8	1/2-13	1,250	250	10
509	1	1 1/4	1 1/16	10-24	150	60	100
510	2 7/32	1 1/8	5/8	1/4-20	250	40	100
511-SC	2 7/32	1 1/8	5/8	10-24	150	40	100

†Safety Factor of 3. Load Ratings based on bottom hole of Beam Clamp. CSA File No. LR-63683.

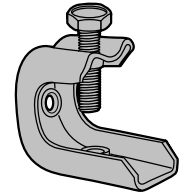
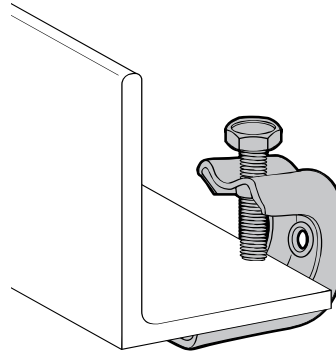

Fig. 1

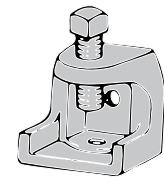
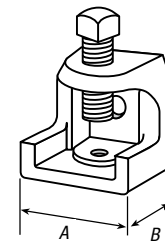
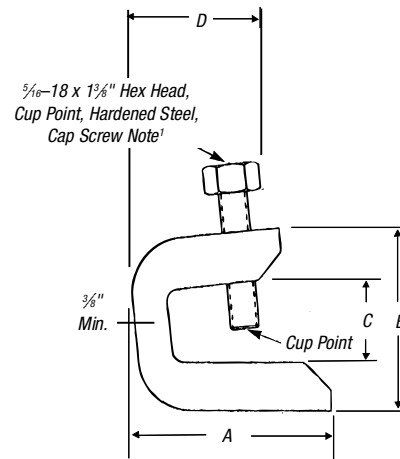

Fig. 2



500SS316, 502SS316 and 503SS316 in 316 Stainless Steel also available.