

Low Profile Design Combines Functionality With Aesthetics Ideal for Low Voltage and Power Applications

400, 800, 2300 and 2300BACD Series™ Raceway, are a family of low-profile raceways that are designed for communication or power applications. 400, 800 and 2300 Raceway offer a single channel for either communication or power. And when power and low voltage services are both needed in a single raceway, the divided 2300BACD Raceway with its low-profile design, is an easy-to-install option.

400,800,2300 and 2300BACD Raceways are an ideal solution for use in classrooms, offices, hospitality applications, or anywhere a small, secure, low profile raceway is needed.



2300D Series Raceway in a typical office application.

FEATURES & BENEFITS

- **Accommodates communication and/or power wiring.** Can be used for communications, computer lines, surveillance systems, fire alarms, outlets, and more.
- **Available in three sizes.** 400, 800, and 2300 sizes provide flexibility for meeting a variety of capacity and space requirements. Perfect for most small drops and horizontal runs to work stations.
- **Durable, textured PVC construction.** Available in ivory or white finish to blend with any decor. Also paintable using latex paint. Consult factory for custom color options.
- **Single- and dual-compartment low profile design.** Provides functionality and flexibility with aesthetics for single- or dual-service applications.
- **Adhesive backing for low voltage (under 50V) applications.** Allows base to be pressed onto mounting surface. Speeds installation.
- **Lightweight and easy to handle.** Saves time and labor costs. Standard 5' (1.525m) raceway lengths can be easily installed by one person. Custom lengths up to 10' (3.05m) are also available.
- **Divided FiberReady® fittings.** For use with 2300BAC and 2300BACD. Full capacity fittings provide 2" (51mm) bend radius.
- **Over-the-raceway box for 2300 and 2300D.** Boxes mount over continuous run of raceway base eliminating the need to cut raceway when locating devices.
- **Sure-Snap® boxes for 2300BACD.** Provides flush look and ease of installation.
- **Snap-on cover.** Provides security with access to wiring for changes or additions.
- **Datacom connectivity options.** Accepts industry standard and proprietary devices from a wide range of manufacturers to provide a seamless and aesthetically pleasing interface for voice, data, audio, and video applications at the point of use.
- **cULus Listed.** File E90378 Raceway, E90377 Fittings.



PEP
ECO
PASS
PORT®

Download this product's PEP ecopassport® environmental product declaration at www.legrand.us/resources-and-downloads. This declaration conforms with ISO 14025 and 14040 and is in alignment with EN 15804.

400, 800, 2300, 2300D Series Raceway System Layout



NOTE: Illustration shows product applications only. 2315 Tee Fitting cannot be used with 2300D Divided Raceway.

400, 800, 2300, 2300D Raceway Series Wire Fill Capacities for Power

WIRE SIZE THHN/THWN	O.D.		NUMBER OF CONDUCTORS			
	Inches	(mm)	400BAC	800BAC	2300BAC	2300BACD [†]
14 AWG	0.111	(2.8)	5	6	15	7
12 AWG	0.130	(3.3)	3	5	14	6
10AWG	0.164	(4.2)	0	4	12	5

400, 800, 2300, 2300D Raceway Series Wire Fill Capacities for Communications

	CABLE/WIRE SIZE	O.D.		40% FILL*			
		inches	(mm)	400	800	2300	2300D [†]
UNSHIELDED TWISTED PAIR	4-Pair, 24 AWG Cat. 3	0.190	(4.8)	1	3	11	5
	4-Pair, 24 AWG Cat. 5e	0.210	(5.3)	1	3	9	4
	4-Pair, 24 AWG Cat. 6	0.250	(6.3)	1	2	6	3
	4-Pair, 24 AWG Cat. 6a**	0.354	(9.0)	0	1	3	1
	25-Pair, 24 AWG	0.410	(10.4)	0	0	2	1
COAXIAL	RG6/U	0.270	(6.9)	0	1	5	2
FIBER	Zip Cord 0.118 x 0.157	(3 x 6)	1	3	12	6	
	Round 4 Strand Fiber	0.187	(4.8)	1	3	12	6
	Round 6 Strand Fiber	0.256	(6.5)	1	2	6	3

* Wire capacity is reduced to allow for proper conductor bend radius and maximum permissible heat rise.

** Category 6 augmented (6a) cable for 10 gigabit ethernet - max allowed cable diameter per addenda No. 11 ANSI TIA/EIA 568-B.2.

[†] each compartment.

400BAC, 800BAC, 2300BAC, 2300BACD Series Raceway Ordering Information

Catalog No./Item	Description/Specifications
400BAC 400BAC-WH 800BAC 800BAC-WH 2300BAC 2300BAC-WH 2300BACD 2300BACD-WH	Low profile, two-piece raceway with snap-on cover – Available in 5' (1.525m) and length. Supplied with wide adhesive tape along entire length of base.
	
	

400, 800, 2300, 2000D Series Fittings Ordering Information

Catalog No./Item	Description/Specifications																
400WC 800WC 2300WC 	Wire Clip – For holding conductors in place. <table border="1" style="margin-top: 10px;"> <thead> <tr> <th>CAT NO.</th> <th>A</th> </tr> </thead> <tbody> <tr> <td>400WC</td> <td>1/2" (12.7mm)</td> </tr> <tr> <td>800WC</td> <td>1" (25mm)</td> </tr> <tr> <td>2300WC</td> <td>1" (25mm)</td> </tr> </tbody> </table>	CAT NO.	A	400WC	1/2" (12.7mm)	800WC	1" (25mm)	2300WC	1" (25mm)								
CAT NO.	A																
400WC	1/2" (12.7mm)																
800WC	1" (25mm)																
2300WC	1" (25mm)																
406 806 2306 	Cover Clip – For covering joint where two pieces of 400BAC, 800BAC or 2300BAC Series Raceway cover come together. <table border="1" style="margin-top: 10px;"> <thead> <tr> <th>CAT NO.</th> <th>A</th> </tr> </thead> <tbody> <tr> <td>406</td> <td>13/16" (20.6mm)</td> </tr> <tr> <td>806</td> <td>1" (25mm)</td> </tr> <tr> <td>2306</td> <td>2" (51mm)</td> </tr> </tbody> </table>	CAT NO.	A	406	13/16" (20.6mm)	806	1" (25mm)	2306	2" (51mm)								
CAT NO.	A																
406	13/16" (20.6mm)																
806	1" (25mm)																
2306	2" (51mm)																
410B 810B 2310B 	Blank End Fitting – For closing open end of 400BAC, 800BAC, or 2300BAC Raceway Series. <table border="1" style="margin-top: 10px;"> <thead> <tr> <th>CAT NO.</th> <th>A</th> <th>B</th> <th>C</th> </tr> </thead> <tbody> <tr> <td>410B</td> <td>13/16" (20.6mm)</td> <td>1/2" (12.7mm)</td> <td>3/8 (9.5mm)</td> </tr> <tr> <td>810B</td> <td>1 1/4" (32mm)</td> <td>1/2" (12.7mm)</td> <td>3/8 (9.5mm)</td> </tr> <tr> <td>2310B</td> <td>2 1/4" (57mm)</td> <td>1" (25mm)</td> <td>3/8 (9.5mm)</td> </tr> </tbody> </table>	CAT NO.	A	B	C	410B	13/16" (20.6mm)	1/2" (12.7mm)	3/8 (9.5mm)	810B	1 1/4" (32mm)	1/2" (12.7mm)	3/8 (9.5mm)	2310B	2 1/4" (57mm)	1" (25mm)	3/8 (9.5mm)
CAT NO.	A	B	C														
410B	13/16" (20.6mm)	1/2" (12.7mm)	3/8 (9.5mm)														
810B	1 1/4" (32mm)	1/2" (12.7mm)	3/8 (9.5mm)														
2310B	2 1/4" (57mm)	1" (25mm)	3/8 (9.5mm)														
411* 	90° Flat Elbow – For right angle turns on same surface.																
415* 	Tee – For branches at right angles.																
417* 	Internal Elbow – For surfaces at right angles.																

NOTE: No suffix denotes ivory finish. Add "-WH" suffix for white finish.
 * For 2300BAC and 2300BACD Raceway must be mitered to use 2311 and 2318. 2315 cannot be used in divided raceway.

Catalog No./Item	Description/Specifications									
418 818 2318* 	90° External Elbow – For right angle turns around external corners. <table border="1" style="margin-top: 10px;"> <thead> <tr> <th>CAT NO.</th> <th>A</th> </tr> </thead> <tbody> <tr> <td>418</td> <td>1 1/2 (38mm)</td> </tr> <tr> <td>818</td> <td>2" (51mm)</td> </tr> <tr> <td>2318</td> <td>2 1/2" (64mm)</td> </tr> </tbody> </table>	CAT NO.	A	418	1 1/2 (38mm)	818	2" (51mm)	2318	2 1/2" (64mm)	
CAT NO.	A									
418	1 1/2 (38mm)									
818	2" (51mm)									
2318	2 1/2" (64mm)									
PVC-1 	PVC Cutter – Regular duty cutter. Ideal for use with small nonmetallic raceway.									
810A2 	Entrance End Fitting – For connecting 400 or 800 Series Raceway with 1/2" trade size conduit or armored cable. 1/2" trade size KO on end and bottom.									
811 2311** 	90° Flat Elbow – For right angle turns on same surface. <table border="1" style="margin-top: 10px;"> <thead> <tr> <th>CAT NO.</th> <th>A</th> </tr> </thead> <tbody> <tr> <td>811</td> <td>2 1/2" (64mm)</td> </tr> <tr> <td>2311</td> <td>4 3/16" (106mm)</td> </tr> </tbody> </table>	CAT NO.	A	811	2 1/2" (64mm)	2311	4 3/16" (106mm)			
CAT NO.	A									
811	2 1/2" (64mm)									
2311	4 3/16" (106mm)									
815 2315** 	Tee – For right angles turns on same surface. <table border="1" style="margin-top: 10px;"> <thead> <tr> <th>CAT NO.</th> <th>A</th> <th>B</th> </tr> </thead> <tbody> <tr> <td>815</td> <td>4 1/8" (105mm)</td> <td>2 3/4" (70mm)</td> </tr> <tr> <td>2315</td> <td>6" (152mm)</td> <td>4 1/8" (105mm)</td> </tr> </tbody> </table>	CAT NO.	A	B	815	4 1/8" (105mm)	2 3/4" (70mm)	2315	6" (152mm)	4 1/8" (105mm)
CAT NO.	A	B								
815	4 1/8" (105mm)	2 3/4" (70mm)								
2315	6" (152mm)	4 1/8" (105mm)								
817 2317* 	Internal Elbow – For surfaces at right angles. <table border="1" style="margin-top: 10px;"> <thead> <tr> <th>CAT NO.</th> <th>A</th> </tr> </thead> <tbody> <tr> <td>817</td> <td>2" (51mm)</td> </tr> <tr> <td>2317</td> <td>2 1/2" (64mm)</td> </tr> </tbody> </table>	CAT NO.	A	817	2" (51mm)	2317	2 1/2" (64mm)			
CAT NO.	A									
817	2" (51mm)									
2317	2 1/2" (64mm)									
889A 	Reducing Connector (800-400) – For transitioning from 800 to 400 Series Raceway.									

400, 800, 2300, 2000D Series Fittings Ordering Information (continued)

Catalog No./Item	Description/Specifications
2310A 	Entrance End Fitting – 1/2", 3/4", and 1" trade size KOs for feeding 2300 Series Raceway.
2310DFO 	Bend Radius Divided Entrance End Fitting – Divided fitting to feed 2300BAC and 2300BACD Series Raceway. Includes 1/2", 3/4" and 1" trade size KOs on back and top.
2311DFO 	Bend Radius Divided Flat Elbow – A 90° flat corner with integral dividers to provide 2" (51mm) cable bend radius for UTP and fiber optic installations.
2317DFO 	Bend Radius Divided Internal Elbow – A 90° internal corner with integral dividers to provide 2" (51mm) cable bend radius for UTP and fiber optic installations.

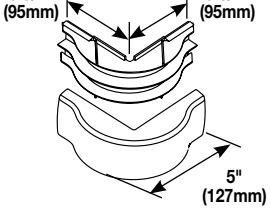
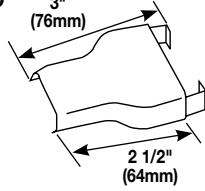
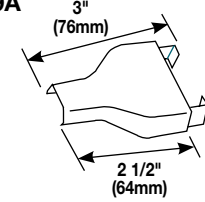
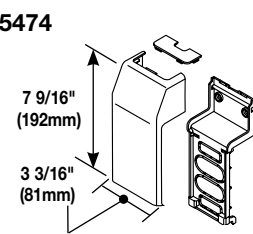
Catalog No./Item	Description/Specifications
2318DFO 	Bend Radius Divided External Elbow – A 90° external corner with integral dividers to provide 2" (51mm) cable bend radius for UTP and fiber optic installations.
2389 	Reducing Connector (2300BAC-800BAC) – For transitioning from 2300BAC to 800BAC Series Raceway.
2389A 	Reducing Connector (2300BAC-400BAC) – For transitioning from 2300BAC to 400BAC Series Raceway.
5474 	Transition Tap Fitting – Makes transition from 5400 Raceway to 400BAC, 800BAC, 2300BAC Series Raceway.

NOTE: No suffix denotes ivory finish. Add "-WH" suffix for white finish.

400, 800, 2300, 2000D Series Communications Boxes Ordering Information (continued)

Catalog No./Item	Description/Specifications
CM-MMB-231 	One Insert Multimedia Box - Compatible with 400BAC and 800BAC Series Raceway. Accepts Pass & Seymour® Activate Inserts and Wiremold Open System Communication Modules.
CM-MMB-232 	Two Insert FiberReady® Multimedia Box - Compatible with 400BAC, 800BAC, and 2300BAC Series Raceway. Accepts Pass & Seymour® Activate Inserts and Wiremold Open System Communications Modules.

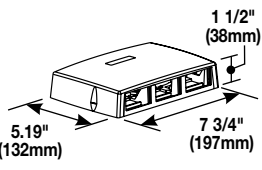
Catalog No./Item	Description/Specifications
CM-MMB-233 	Three-Insert FiberReady® Multimedia Box – Compatible with 400BAC, 800BAC and 2300BAC Series Raceway. Accepts Pass & Seymour® Activate Inserts and Wiremold Open System Communications Modules

400, 800, 2300 Series Raceway Sure-Snap® Device Boxes

- **Interchangeable covers and bases.** Provides installation flexibility.
- **Large knockout.** Accommodates many cable types and quantities.
- **Cover removes easily.** One twist of a screwdriver removes the cover for fast changes.
- **No screws to assemble.** The secure snap assembly requires fewer tools and parts, which means a shorter installation time.



Sure-Snap Device Boxes are available in a variety of sizes and depths.

400, 800, 2300 Series Raceway Sure-Snap® Device Boxes Ordering Information (For Non-Divided Raceways)

Catalog No./Item	Description/Specifications																		
2344 2344-2 	Extra Deep Device Box – 2344 one-gang, 2344-2 two-gang. 2344-2 base has rectangular KO to enable extension from existing single-gang flush wall box and 1/2" and 1" trade size concentric KOs. Accepts NEMA Faceplates																		
	<table border="1" style="width: 100%; border-collapse: collapse;"> <thead> <tr> <th>CAT #</th> <th>GANG(s)</th> <th>A</th> <th>B</th> <th>C</th> </tr> </thead> <tbody> <tr> <td style="text-align: center;">2344</td> <td style="text-align: center;">1</td> <td style="text-align: center;">4 3/4" (121mm)</td> <td style="text-align: center;">3" (76mm)</td> <td style="text-align: center;">2 3/4" (70mm)</td> </tr> <tr> <td style="text-align: center;">2344-2</td> <td style="text-align: center;">2</td> <td style="text-align: center;">4.3/4" (121mm)</td> <td style="text-align: center;">4 7/8" (124mm)</td> <td style="text-align: center;">2 3/4" (70mm)</td> </tr> </tbody> </table>	CAT #	GANG(s)	A	B	C	2344	1	4 3/4" (121mm)	3" (76mm)	2 3/4" (70mm)	2344-2	2	4.3/4" (121mm)	4 7/8" (124mm)	2 3/4" (70mm)			
CAT #	GANG(s)	A	B	C															
2344	1	4 3/4" (121mm)	3" (76mm)	2 3/4" (70mm)															
2344-2	2	4.3/4" (121mm)	4 7/8" (124mm)	2 3/4" (70mm)															

2347 2347-2 	Device Box – 2347 one-gang, 2347-2 two-gang. For standard switches and devices. 2347 and 2347-2 Bases have rectangular KO to enable extension from existing flush wall box and 1/2" and 1" trade size concentric KOs. Accepts NEMA Faceplates																		
	<table border="1" style="width: 100%; border-collapse: collapse;"> <thead> <tr> <th>CAT #</th> <th>GANG(S)</th> <th>A</th> <th>B</th> <th>C</th> </tr> </thead> <tbody> <tr> <td style="text-align: center;">2347</td> <td style="text-align: center;">1</td> <td style="text-align: center;">4 3/4" (121mm)</td> <td style="text-align: center;">3" (76mm)</td> <td style="text-align: center;">1 3/8" (35mm)</td> </tr> <tr> <td style="text-align: center;">2347-2</td> <td style="text-align: center;">2</td> <td style="text-align: center;">4 3/4" (121mm)</td> <td style="text-align: center;">4 7/8" (124mm)</td> <td style="text-align: center;">1 3/8" (35mm)</td> </tr> </tbody> </table>	CAT #	GANG(S)	A	B	C	2347	1	4 3/4" (121mm)	3" (76mm)	1 3/8" (35mm)	2347-2	2	4 3/4" (121mm)	4 7/8" (124mm)	1 3/8" (35mm)			
CAT #	GANG(S)	A	B	C															
2347	1	4 3/4" (121mm)	3" (76mm)	1 3/8" (35mm)															
2347-2	2	4 3/4" (121mm)	4 7/8" (124mm)	1 3/8" (35mm)															

NOTE: No suffix denotes ivory finish. Add “-WH” suffix for white finish.
 All single-gang bases have a rectangular knockout on the base.

Catalog No./Item	Description/Specifications																							
2348 2348-2 2348-3 	Deep Device Box – 2348 one-gang, 2348-2 two-gang, 2348-3 three-gang. For deeper switches and devices. 2348, 2348-2, and 2348-3 Bases have rectangular KO to enable extension from existing flush wall box and 1/2" and 1" concentric KOs. Accepts NEMA Faceplates.																							
	<table border="1" style="width: 100%; border-collapse: collapse;"> <thead> <tr> <th>CAT #</th> <th>GANG(S)</th> <th>A</th> <th>B</th> <th>C</th> </tr> </thead> <tbody> <tr> <td style="text-align: center;">2348</td> <td style="text-align: center;">1</td> <td style="text-align: center;">4 3/4" (121mm)</td> <td style="text-align: center;">3" (76mm)</td> <td style="text-align: center;">1 3/4" (35mm)</td> </tr> <tr> <td style="text-align: center;">2348-2</td> <td style="text-align: center;">2</td> <td style="text-align: center;">4 3/4" (121mm)</td> <td style="text-align: center;">4 7/8" (124mm)</td> <td style="text-align: center;">1 3/4" (44mm)</td> </tr> <tr> <td style="text-align: center;">2348-3</td> <td style="text-align: center;">3</td> <td style="text-align: center;">4 3/4" (121mm)</td> <td style="text-align: center;">7" (178mm)</td> <td style="text-align: center;">1 3/4" (44mm)</td> </tr> </tbody> </table>	CAT #	GANG(S)	A	B	C	2348	1	4 3/4" (121mm)	3" (76mm)	1 3/4" (35mm)	2348-2	2	4 3/4" (121mm)	4 7/8" (124mm)	1 3/4" (44mm)	2348-3	3	4 3/4" (121mm)	7" (178mm)	1 3/4" (44mm)			
CAT #	GANG(S)	A	B	C																				
2348	1	4 3/4" (121mm)	3" (76mm)	1 3/4" (35mm)																				
2348-2	2	4 3/4" (121mm)	4 7/8" (124mm)	1 3/4" (44mm)																				
2348-3	3	4 3/4" (121mm)	7" (178mm)	1 3/4" (44mm)																				

2348S/51 	Shallow Device Box / Extension Box – For shallow switches and receptacles. Base has rectangular KO. Accepts NEMA Faceplates.			
---	---	--	--	--

2348AMP 	Magnetic Deep Device Box (with Grommet) – For deeper switches and devices. Magnetic backing. Base has rectangular KO. Accepts NEMA Faceplates			
---	--	--	--	--

400, 800, 2300 Series Raceway Round Fixture Boxes for Non-Divided Raceway Ordering Information

Item	Description	Cat. No.	Diameter	Depth	Specifications
	Blank Cover	2336	4 1/2" (114mm)	—	Use with any round nonmetallic device box to convert into junction box.
	Round Extension Box	2337A	5 1/2" (140mm)	1" (25mm)	For hanging fixtures, smoke/fire alarms and other security devices with 3 1/2" (89mm) or 4 1/16" (103mm) mounting centers. 5 1/2" (140mm) diameter with open base. Not for use with ceiling fans.
	Fixture Box	2338A	5 1/2" (140mm)	1" (25mm)	For hanging smoke/fire alarms and other security devices with 3 1/2" (89mm) or 4 1/16" (103mm) mounting centers. Not for use with ceiling fans.

NOTE: No suffix denotes ivory finish. Add “-WH” suffix for white finish.

Sure-Snap® Device Boxes for 2300BACD Divided Series Raceway

The 2300BAC and 2300BACD Series Divided Raceway Box family provides two unique benefits; labor savings with “over-the-raceway” installation and Sure-Snap® device boxes. The 2348D and 2344D “over-the-raceway” design eliminates cutting the raceway base to mount boxes. The base snaps on anywhere along the raceway. The Sure-Snap integral device box of the 2344SD-2A combines aesthetics with labor savings. 5507 Series Faceplates, Pass & Seymour Activate Inserts, Wiremold Open System Communication Modules and Ortronics Series II and TracJack Modules snap directly into the Sure-Snap Device Box, eliminating the need for additional faceplates. The single-gang boxes accept standard NEMA faceplates.

Sure-Snap® Device Boxes for 2300BACD Divided Series Raceway Ordering Information

Catalog No./Item	Description/Specifications
<p>2348D</p>  <p>1 3/4" (44mm) 4 3/4" (121mm) 3" (76mm)</p>	<p>Device Box – For use with 2300BACD Divided Raceway. For mounting standard switches, receptacles and industry standard faceplates for communication devices. Accepts NEMA Faceplates.</p>
<p>2344D</p>  <p>2 3/4" (70mm) 4 3/4" (121mm) 3" (76mm)</p>	<p>Extra Deep Device Box – For use with 2300BACD Divided Raceway when additional depth is required. For mounting standard switches, receptacles and industry standard faceplates for communication devices. Accepts NEMA Faceplates.</p>
<p>2344SD-2A</p>  <p>2 1/4" (57mm) 4 3/4" (121mm) 4 7/8" (124mm)</p>	<p>Two-Gang Deep Divided Box – A divided two-gang box for use with 2300D Series Raceway. Provides the ability to have both power and low voltage at a single point of use. Accepts 5507 Series Faceplates, Ortronics® TracJack & Series II Modules, Pass & Seymour® Activate™ Series Inserts, and Wiremold Open System Communication Modules.</p> <p>Note: Not for use with NEMA Faceplates. CM-EPLA End Plates are required when using Wiremold Open System communication modules and Pass & Seymour® Activate inserts. S2-EPL End Plates are required when using Ortronics® Series II inserts. To mount Ortronics® TracJack modules, use 5507-4TJ or 5507-6TJ Faceplates.</p>

2344SD-2 Over-the-Raceway Box Application



5507 Series Faceplates Ordering Information

Catalog No./Item	Description/Specifications	Catalog No./Item	Description/Specifications
5507AD	 Modular Furniture Adapter – For mounting Activate modular furniture bezels and other modular furniture adapters. Not for use with rectangular (decorator) style devices.	5507RJ	 Dual RJ11/RJ45 Connector Faceplate – For mounting one or two RJ type connectors – has one opening and a KO for the other.
5507B	 Blank Faceplate – For covering unused compartments in the device bracket.	5507FRJ	 Flush Dual RJ11/RJ45 Connector Faceplate – Same as 5507RJ except the connectors are recessed to provide a flush installation.
5507D	 Duplex Receptacle Faceplate – For covering duplex style devices. Accepts 106 Frame.	5507-4TJ	 Ortronics® Faceplate – For mounting Ortronics® datacom inserts. Accepts four TracJack Devices.
5507R	 Rectangular Receptacle Faceplate – For covering rectangular decorator style devices.	5507-6TJ	 Ortronics® Faceplate – For mounting Ortronics® datacom inserts. Accepts six TracJack Devices.
5507S	 Rectangular Spacer – For mounting commercial device plates. Installs between the device bracket and a device.	CM-EPLA	 End Plates – Includes two outlet identification labels with clear covers and two matching screw covers. Required for mounting Pass & Seymour® Activate™ and Wiremold Open System communication modules into the 2344SD-2A.
5507SW	 Switch Faceplate – For covering standard toggle switches.	S2-EPL	 End Plates – Includes two outlet identification labels with clear covers and two matching screw covers. Required for mounting Ortronics® Series II modules into the 2344SD-2A.
5507T1	 Single Receptacle Faceplate – For covering single receptacles – 1.59" (40mm) diameter.		
5507T2	 Single Receptacle Faceplate – For covering single receptacles – 1.41" (36mm) diameter.		

NOTE: No suffix denotes ivory finish. Add “-WH” suffix for white finish, and “G” for Gray finish. Consult factory for custom colors.



Electrical Wiring Systems
 60 Woodlawn Street
 West Hartford, CT 06110
 Phone: 1.877.BY.LEGRAND (295-3472)
www.legrand.us
 570 Applewood Crescent
 Vaughan, Ontario L4K 4B4
 Phone: 905.738.9195
www.legrand.ca



Low Profile Design Combines Functionality With Aesthetics Ideal for Low Voltage and Power Applications

400, 800, 2300 and 2300BACD Series™ Raceway, are a family of low-profile raceways that are designed for communication or power applications. 400, 800 and 2300 Raceway offer a single channel for either communication or power. And when power and low voltage services are both needed in a single raceway, the divided 2300BACD Raceway with its low-profile design, is an easy-to-install option.

400,800,2300 and 2300BACD Raceways are an ideal solution for use in classrooms, offices, hospitality applications, or anywhere a small, secure, low profile raceway is needed.



2300D Series Raceway in a typical office application.

FEATURES & BENEFITS

- **Accommodates communication and/or power wiring.** Can be used for communications, computer lines, surveillance systems, fire alarms, outlets, and more.
- **Available in three sizes.** 400, 800, and 2300 sizes provide flexibility for meeting a variety of capacity and space requirements. Perfect for most small drops and horizontal runs to work stations.
- **Durable, textured PVC construction.** Available in ivory or white finish to blend with any decor. Also paintable using latex paint. Consult factory for custom color options.
- **Single- and dual-compartment low profile design.** Provides functionality and flexibility with aesthetics for single- or dual-service applications.
- **Adhesive backing for low voltage (under 50V) applications.** Allows base to be pressed onto mounting surface. Speeds installation.
- **Lightweight and easy to handle.** Saves time and labor costs. Standard 5' (1.525m) raceway lengths can be easily installed by one person. Custom lengths up to 10' (3.05m) are also available.
- **Divided FiberReady® fittings.** For use with 2300BAC and 2300BACD. Full capacity fittings provide 2" (51mm) bend radius.
- **Over-the-raceway box for 2300 and 2300D.** Boxes mount over continuous run of raceway base eliminating the need to cut raceway when locating devices.
- **Sure-Snap® boxes for 2300BACD.** Provides flush look and ease of installation.
- **Snap-on cover.** Provides security with access to wiring for changes or additions.
- **Datacom connectivity options.** Accepts industry standard and proprietary devices from a wide range of manufacturers to provide a seamless and aesthetically pleasing interface for voice, data, audio, and video applications at the point of use.
- **cULus Listed.** File E90378 Raceway, E90377 Fittings.



PEP
ECO
PASS
PORT®

Download this product's PEP ecopassport® environmental product declaration at www.legrand.us/resources-and-downloads. This declaration conforms with ISO 14025 and 14040 and is in alignment with EN 15804.

400, 800, 2300, 2300D Series Raceway System Layout



NOTE: Illustration shows product applications only. 2315 Tee Fitting cannot be used with 2300D Divided Raceway.

400, 800, 2300, 2300D Raceway Series Wire Fill Capacities for Power

WIRE SIZE THHN/THWN	O.D.		NUMBER OF CONDUCTORS			
	Inches	(mm)	400BAC	800BAC	2300BAC	2300BACD [†]
14 AWG	0.111	(2.8)	5	6	15	7
12 AWG	0.130	(3.3)	3	5	14	6
10AWG	0.164	(4.2)	0	4	12	5

400, 800, 2300, 2300D Raceway Series Wire Fill Capacities for Communications

	CABLE/WIRE SIZE	O.D.		40% FILL*			
		inches	(mm)	400	800	2300	2300D [†]
UNSHIELDED TWISTED PAIR	4-Pair, 24 AWG Cat. 3	0.190	(4.8)	1	3	11	5
	4-Pair, 24 AWG Cat. 5e	0.210	(5.3)	1	3	9	4
	4-Pair, 24 AWG Cat. 6	0.250	(6.3)	1	2	6	3
	4-Pair, 24 AWG Cat. 6a**	0.354	(9.0)	0	1	3	1
	25-Pair, 24 AWG	0.410	(10.4)	0	0	2	1
COAXIAL	RG6/U	0.270	(6.9)	0	1	5	2
FIBER	Zip Cord 0.118 x 0.157	(3 x 6)	1	3	12	6	
	Round 4 Strand Fiber	0.187	(4.8)	1	3	12	6
	Round 6 Strand Fiber	0.256	(6.5)	1	2	6	3

* Wire capacity is reduced to allow for proper conductor bend radius and maximum permissible heat rise.

** Category 6 augmented (6a) cable for 10 gigabit ethernet - max allowed cable diameter per addenda No. 11 ANSI TIA/EIA 568-B.2.

[†] each compartment.

400BAC, 800BAC, 2300BAC, 2300BACD Series Raceway Ordering Information

Catalog No./Item	Description/Specifications
400BAC 400BAC-WH 800BAC 800BAC-WH 2300BAC 2300BAC-WH 2300BACD 2300BACD-WH	Low profile, two-piece raceway with snap-on cover – Available in 5' (1.525m) and length. Supplied with wide adhesive tape along entire length of base.

400, 800, 2300, 2000D Series Fittings Ordering Information

Catalog No./Item	Description/Specifications																
400WC 800WC 2300WC 	Wire Clip – For holding conductors in place. <table border="1" style="margin-top: 10px;"> <thead> <tr> <th>CAT NO.</th> <th>A</th> </tr> </thead> <tbody> <tr> <td>400WC</td> <td>1/2" (12.7mm)</td> </tr> <tr> <td>800WC</td> <td>1" (25mm)</td> </tr> <tr> <td>2300WC</td> <td>1" (25mm)</td> </tr> </tbody> </table>	CAT NO.	A	400WC	1/2" (12.7mm)	800WC	1" (25mm)	2300WC	1" (25mm)								
CAT NO.	A																
400WC	1/2" (12.7mm)																
800WC	1" (25mm)																
2300WC	1" (25mm)																
406 806 2306 	Cover Clip – For covering joint where two pieces of 400BAC, 800BAC or 2300BAC Series Raceway cover come together. <table border="1" style="margin-top: 10px;"> <thead> <tr> <th>CAT NO.</th> <th>A</th> </tr> </thead> <tbody> <tr> <td>406</td> <td>13/16" (20.6mm)</td> </tr> <tr> <td>806</td> <td>1" (25mm)</td> </tr> <tr> <td>2306</td> <td>2" (51mm)</td> </tr> </tbody> </table>	CAT NO.	A	406	13/16" (20.6mm)	806	1" (25mm)	2306	2" (51mm)								
CAT NO.	A																
406	13/16" (20.6mm)																
806	1" (25mm)																
2306	2" (51mm)																
410B 810B 2310B 	Blank End Fitting – For closing open end of 400BAC, 800BAC, or 2300BAC Raceway Series. <table border="1" style="margin-top: 10px;"> <thead> <tr> <th>CAT NO.</th> <th>A</th> <th>B</th> <th>C</th> </tr> </thead> <tbody> <tr> <td>410B</td> <td>13/16" (20.6mm)</td> <td>1/2" (12.7mm)</td> <td>3/8 (9.5mm)</td> </tr> <tr> <td>810B</td> <td>1 1/4" (32mm)</td> <td>1/2" (12.7mm)</td> <td>3/8 (9.5mm)</td> </tr> <tr> <td>2310B</td> <td>2 1/4" (57mm)</td> <td>1" (25mm)</td> <td>3/8 (9.5mm)</td> </tr> </tbody> </table>	CAT NO.	A	B	C	410B	13/16" (20.6mm)	1/2" (12.7mm)	3/8 (9.5mm)	810B	1 1/4" (32mm)	1/2" (12.7mm)	3/8 (9.5mm)	2310B	2 1/4" (57mm)	1" (25mm)	3/8 (9.5mm)
CAT NO.	A	B	C														
410B	13/16" (20.6mm)	1/2" (12.7mm)	3/8 (9.5mm)														
810B	1 1/4" (32mm)	1/2" (12.7mm)	3/8 (9.5mm)														
2310B	2 1/4" (57mm)	1" (25mm)	3/8 (9.5mm)														
411* 	90° Flat Elbow – For right angle turns on same surface.																
415* 	Tee – For branches at right angles.																
417* 	Internal Elbow – For surfaces at right angles.																

NOTE: No suffix denotes ivory finish. Add “-WH” suffix for white finish.
 * For 2300BAC and 2300BACD Raceway must be mitered to use 2311 and 2318. 2315 cannot be used in divided raceway.

Catalog No./Item	Description/Specifications									
418 818 2318* 	90° External Elbow – For right angle turns around external corners. <table border="1" style="margin-top: 10px;"> <thead> <tr> <th>CAT NO.</th> <th>A</th> </tr> </thead> <tbody> <tr> <td>418</td> <td>1 1/2 (38mm)</td> </tr> <tr> <td>818</td> <td>2" (51mm)</td> </tr> <tr> <td>2318</td> <td>2 1/2" (64mm)</td> </tr> </tbody> </table>	CAT NO.	A	418	1 1/2 (38mm)	818	2" (51mm)	2318	2 1/2" (64mm)	
CAT NO.	A									
418	1 1/2 (38mm)									
818	2" (51mm)									
2318	2 1/2" (64mm)									
PVC-1 	PVC Cutter – Regular duty cutter. Ideal for use with small nonmetallic raceway.									
810A2 	Entrance End Fitting – For connecting 400 or 800 Series Raceway with 1/2" trade size conduit or armored cable. 1/2" trade size KO on end and bottom.									
811 2311** 	90° Flat Elbow – For right angle turns on same surface. <table border="1" style="margin-top: 10px;"> <thead> <tr> <th>CAT NO.</th> <th>A</th> </tr> </thead> <tbody> <tr> <td>811</td> <td>2 1/2" (64mm)</td> </tr> <tr> <td>2311</td> <td>4 3/16" (106mm)</td> </tr> </tbody> </table>	CAT NO.	A	811	2 1/2" (64mm)	2311	4 3/16" (106mm)			
CAT NO.	A									
811	2 1/2" (64mm)									
2311	4 3/16" (106mm)									
815 2315** 	Tee – For right angles turns on same surface. <table border="1" style="margin-top: 10px;"> <thead> <tr> <th>CAT NO.</th> <th>A</th> <th>B</th> </tr> </thead> <tbody> <tr> <td>815</td> <td>4 1/8" (105mm)</td> <td>2 3/4" (70mm)</td> </tr> <tr> <td>2315</td> <td>6" (152mm)</td> <td>4 1/8" (105mm)</td> </tr> </tbody> </table>	CAT NO.	A	B	815	4 1/8" (105mm)	2 3/4" (70mm)	2315	6" (152mm)	4 1/8" (105mm)
CAT NO.	A	B								
815	4 1/8" (105mm)	2 3/4" (70mm)								
2315	6" (152mm)	4 1/8" (105mm)								
817 2317* 	Internal Elbow – For surfaces at right angles. <table border="1" style="margin-top: 10px;"> <thead> <tr> <th>CAT NO.</th> <th>A</th> </tr> </thead> <tbody> <tr> <td>817</td> <td>2" (51mm)</td> </tr> <tr> <td>2317</td> <td>2 1/2" (64mm)</td> </tr> </tbody> </table>	CAT NO.	A	817	2" (51mm)	2317	2 1/2" (64mm)			
CAT NO.	A									
817	2" (51mm)									
2317	2 1/2" (64mm)									
889A 	Reducing Connector (800-400) – For transitioning from 800 to 400 Series Raceway.									

400, 800, 2300, 2000D Series Fittings Ordering Information (continued)

Catalog No./Item	Description/Specifications	Catalog No./Item	Description/Specifications
2310A 	Entrance End Fitting – 1/2", 3/4", and 1" trade size KOs for feeding 2300 Series Raceway.	2318DFO 	Bend Radius Divided External Elbow – A 90° external corner with integral dividers to provide 2" (51mm) cable bend radius for UTP and fiber optic installations.
2310DFO 	Bend Radius Divided Entrance End Fitting – Divided fitting to feed 2300BAC and 2300BACD Series Raceway. Includes 1/2", 3/4" and 1" trade size KOs on back and top.	2389 	Reducing Connector (2300BAC-800BAC) – For transitioning from 2300BAC to 800BAC Series Raceway.
2311DFO 	Bend Radius Divided Flat Elbow – A 90° flat corner with integral dividers to provide 2" (51mm) cable bend radius for UTP and fiber optic installations.	2389A 	Reducing Connector (2300BAC-400BAC) – For transitioning from 2300BAC to 400BAC Series Raceway.
2317DFO 	Bend Radius Divided Internal Elbow – A 90° internal corner with integral dividers to provide 2" (51mm) cable bend radius for UTP and fiber optic installations.	5474 	Transition Tap Fitting – Makes transition from 5400 Raceway to 400BAC, 800BAC, 2300BAC Series Raceway.

NOTE: No suffix denotes ivory finish. Add “-WH” suffix for white finish.

400, 800, 2300, 2000D Series Communications Boxes Ordering Information (continued)

Catalog No./Item	Description/Specifications	Catalog No./Item	Description/Specifications
CM-MMB-231 	One Insert Multimedia Box - Compatible with 400BAC and 800BAC Series Raceway. Accepts Pass & Seymour® Activate Inserts and Wiremold Open System Communication Modules.	CM-MMB-233 	Three-Insert FiberReady® Multimedia Box – Compatible with 400BAC, 800BAC and 2300BAC Series Raceway. Accepts Pass & Seymour® Activate Inserts and Wiremold Open System Communications Modules
CM-MMB-232 	Two Insert FiberReady® Multimedia Box - Compatible with 400BAC, 800BAC, and 2300BAC Series Raceway. Accepts Pass & Seymour® Activate Inserts and Wiremold Open System Communications Modules.		

400, 800, 2300 Series Raceway Sure-Snap® Device Boxes

- **Interchangeable covers and bases.** Provides installation flexibility.
- **Large knockout.** Accommodates many cable types and quantities.
- **Cover removes easily.** One twist of a screwdriver removes the cover for fast changes.
- **No screws to assemble.** The secure snap assembly requires fewer tools and parts, which means a shorter installation time.



Sure-Snap Device Boxes are available in a variety of sizes and depths.

400, 800, 2300 Series Raceway Sure-Snap® Device Boxes Ordering Information (For Non-Divided Raceways)

Catalog No./Item	Description/Specifications																		
2344 2344-2 	Extra Deep Device Box – 2344 one-gang, 2344-2 two-gang. 2344-2 base has rectangular KO to enable extension from existing single-gang flush wall box and 1/2" and 1" trade size concentric KOs. Accepts NEMA Faceplates																		
	<table border="1" style="width: 100%; border-collapse: collapse;"> <thead> <tr> <th>CAT #</th> <th>GANG(s)</th> <th>A</th> <th>B</th> <th>C</th> </tr> </thead> <tbody> <tr> <td style="text-align: center;">2344</td> <td style="text-align: center;">1</td> <td style="text-align: center;">4 3/4" (121mm)</td> <td style="text-align: center;">3" (76mm)</td> <td style="text-align: center;">2 3/4" (70mm)</td> </tr> <tr> <td style="text-align: center;">2344-2</td> <td style="text-align: center;">2</td> <td style="text-align: center;">4.3/4" (121mm)</td> <td style="text-align: center;">4 7/8" (124mm)</td> <td style="text-align: center;">2 3/4" (70mm)</td> </tr> </tbody> </table>	CAT #	GANG(s)	A	B	C	2344	1	4 3/4" (121mm)	3" (76mm)	2 3/4" (70mm)	2344-2	2	4.3/4" (121mm)	4 7/8" (124mm)	2 3/4" (70mm)			
CAT #	GANG(s)	A	B	C															
2344	1	4 3/4" (121mm)	3" (76mm)	2 3/4" (70mm)															
2344-2	2	4.3/4" (121mm)	4 7/8" (124mm)	2 3/4" (70mm)															

2347 2347-2 	Device Box – 2347 one-gang, 2347-2 two-gang. For standard switches and devices. 2347 and 2347-2 Bases have rectangular KO to enable extension from existing flush wall box and 1/2" and 1" trade size concentric KOs. Accepts NEMA Faceplates																		
	<table border="1" style="width: 100%; border-collapse: collapse;"> <thead> <tr> <th>CAT #</th> <th>GANG(S)</th> <th>A</th> <th>B</th> <th>C</th> </tr> </thead> <tbody> <tr> <td style="text-align: center;">2347</td> <td style="text-align: center;">1</td> <td style="text-align: center;">4 3/4" (121mm)</td> <td style="text-align: center;">3" (76mm)</td> <td style="text-align: center;">1 3/8" (35mm)</td> </tr> <tr> <td style="text-align: center;">2347-2</td> <td style="text-align: center;">2</td> <td style="text-align: center;">4 3/4" (121mm)</td> <td style="text-align: center;">4 7/8" (124mm)</td> <td style="text-align: center;">1 3/8" (35mm)</td> </tr> </tbody> </table>	CAT #	GANG(S)	A	B	C	2347	1	4 3/4" (121mm)	3" (76mm)	1 3/8" (35mm)	2347-2	2	4 3/4" (121mm)	4 7/8" (124mm)	1 3/8" (35mm)			
CAT #	GANG(S)	A	B	C															
2347	1	4 3/4" (121mm)	3" (76mm)	1 3/8" (35mm)															
2347-2	2	4 3/4" (121mm)	4 7/8" (124mm)	1 3/8" (35mm)															

NOTE: No suffix denotes ivory finish. Add “-WH” suffix for white finish.
 All single-gang bases have a rectangular knockout on the base.

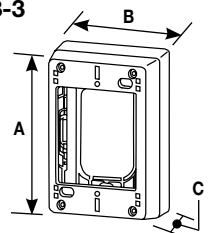
Catalog No./Item	Description/Specifications																							
2348 2348-2 2348-3 	Deep Device Box – 2348 one-gang, 2348-2 two-gang, 2348-3 three-gang. For deeper switches and devices. 2348, 2348-2, and 2348-3 Bases have rectangular KO to enable extension from existing flush wall box and 1/2" and 1" concentric KOs. Accepts NEMA Faceplates.																							
	<table border="1" style="width: 100%; border-collapse: collapse;"> <thead> <tr> <th>CAT #</th> <th>GANG(S)</th> <th>A</th> <th>B</th> <th>C</th> </tr> </thead> <tbody> <tr> <td style="text-align: center;">2348</td> <td style="text-align: center;">1</td> <td style="text-align: center;">4 3/4" (121mm)</td> <td style="text-align: center;">3" (76mm)</td> <td style="text-align: center;">1 3/4" (35mm)</td> </tr> <tr> <td style="text-align: center;">2348-2</td> <td style="text-align: center;">2</td> <td style="text-align: center;">4 3/4" (121mm)</td> <td style="text-align: center;">4 7/8" (124mm)</td> <td style="text-align: center;">1 3/4" (44mm)</td> </tr> <tr> <td style="text-align: center;">2348-3</td> <td style="text-align: center;">3</td> <td style="text-align: center;">4 3/4" (121mm)</td> <td style="text-align: center;">7" (178mm)</td> <td style="text-align: center;">1 3/4" (44mm)</td> </tr> </tbody> </table>	CAT #	GANG(S)	A	B	C	2348	1	4 3/4" (121mm)	3" (76mm)	1 3/4" (35mm)	2348-2	2	4 3/4" (121mm)	4 7/8" (124mm)	1 3/4" (44mm)	2348-3	3	4 3/4" (121mm)	7" (178mm)	1 3/4" (44mm)			
CAT #	GANG(S)	A	B	C																				
2348	1	4 3/4" (121mm)	3" (76mm)	1 3/4" (35mm)																				
2348-2	2	4 3/4" (121mm)	4 7/8" (124mm)	1 3/4" (44mm)																				
2348-3	3	4 3/4" (121mm)	7" (178mm)	1 3/4" (44mm)																				

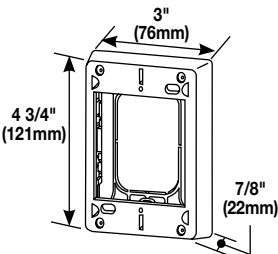
2348S/51 	Shallow Device Box / Extension Box – For shallow switches and receptacles. Base has rectangular KO. Accepts NEMA Faceplates.			
---	---	--	--	--

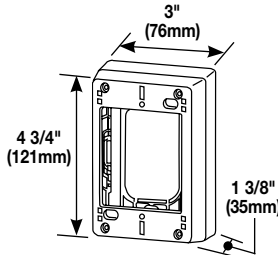
2348AMP 	Magnetic Deep Device Box (with Grommet) – For deeper switches and devices. Magnetic backing. Base has rectangular KO. Accepts NEMA Faceplates			
---	--	--	--	--

400, 800, 2300 Series Raceway Round Fixture Boxes for Non-Divided Raceway Ordering Information

Item	Description	Cat. No.	Diameter	Depth	Specifications
	Blank Cover	2336	4 1/2" (114mm)	—	Use with any round nonmetallic device box to convert into junction box.
	Round Extension Box	2337A	5 1/2" (140mm)	1" (25mm)	For hanging fixtures, smoke/fire alarms and other security devices with 3 1/2" (89mm) or 4 1/16" (103mm) mounting centers. 5 1/2" (140mm) diameter with open base. Not for use with ceiling fans.
	Fixture Box	2338A	5 1/2" (140mm)	1" (25mm)	For hanging smoke/fire alarms and other security devices with 3 1/2" (89mm) or 4 1/16" (103mm) mounting centers. Not for use with ceiling fans.

NOTE: No suffix denotes ivory finish. Add “-WH” suffix for white finish.

Sure-Snap® Device Boxes for 2300BACD Divided Series Raceway

The 2300BAC and 2300BACD Series Divided Raceway Box family provides two unique benefits; labor savings with “over-the-raceway” installation and Sure-Snap® device boxes. The 2348D and 2344D “over-the-raceway” design eliminates cutting the raceway base to mount boxes. The base snaps on anywhere along the raceway. The Sure-Snap integral device box of the 2344SD-2A combines aesthetics with labor savings. 5507 Series Faceplates, Pass & Seymour Activate Inserts, Wiremold Open System Communication Modules and Ortronics Series II and TracJack Modules snap directly into the Sure-Snap Device Box, eliminating the need for additional faceplates. The single-gang boxes accept standard NEMA faceplates.

Sure-Snap® Device Boxes for 2300BACD Divided Series Raceway Ordering Information

Catalog No./Item	Description/Specifications
<p>2348D</p> 	<p>Device Box – For use with 2300BACD Divided Raceway. For mounting standard switches, receptacles and industry standard faceplates for communication devices. Accepts NEMA Faceplates.</p>
<p>2344D</p> 	<p>Extra Deep Device Box – For use with 2300BACD Divided Raceway when additional depth is required. For mounting standard switches, receptacles and industry standard faceplates for communication devices. Accepts NEMA Faceplates.</p>
<p>2344SD-2A</p> 	<p>Two-Gang Deep Divided Box – A divided two-gang box for use with 2300D Series Raceway. Provides the ability to have both power and low voltage at a single point of use. Accepts 5507 Series Faceplates, Ortronics® TracJack & Series II Modules, Pass & Seymour® Activate™ Series Inserts, and Wiremold Open System Communication Modules.</p> <p>Note: Not for use with NEMA Faceplates. CM-EPLA End Plates are required when using Wiremold Open System communication modules and Pass & Seymour® Activate inserts. S2-EPL End Plates are required when using Ortronics® Series II inserts. To mount Ortronics® TracJack modules, use 5507-4TJ or 5507-6TJ Faceplates.</p>

2344SD-2 Over-the-Raceway Box Application



5507 Series Faceplates Ordering Information

Catalog No./Item	Description/Specifications	Catalog No./Item	Description/Specifications
5507AD	 Modular Furniture Adapter – For mounting Activate modular furniture bezels and other modular furniture adapters. Not for use with rectangular (decorator) style devices.	5507RJ	 Dual RJ11/RJ45 Connector Faceplate – For mounting one or two RJ type connectors – has one opening and a KO for the other.
5507B	 Blank Faceplate – For covering unused compartments in the device bracket.	5507FRJ	 Flush Dual RJ11/RJ45 Connector Faceplate – Same as 5507RJ except the connectors are recessed to provide a flush installation.
5507D	 Duplex Receptacle Faceplate – For covering duplex style devices. Accepts 106 Frame.	5507-4TJ	 Ortronics® Faceplate – For mounting Ortronics® datacom inserts. Accepts four TracJack Devices.
5507R	 Rectangular Receptacle Faceplate – For covering rectangular decorator style devices.	5507-6TJ	 Ortronics® Faceplate – For mounting Ortronics® datacom inserts. Accepts six TracJack Devices.
5507S	 Rectangular Spacer – For mounting commercial device plates. Installs between the device bracket and a device.	CM-EPLA	 End Plates – Includes two outlet identification labels with clear covers and two matching screw covers. Required for mounting Pass & Seymour® Activate™ and Wiremold Open System communication modules into the 2344SD-2A.
5507SW	 Switch Faceplate – For covering standard toggle switches.	S2-EPL	 End Plates – Includes two outlet identification labels with clear covers and two matching screw covers. Required for mounting Ortronics® Series II modules into the 2344SD-2A.
5507T1	 Single Receptacle Faceplate – For covering single receptacles – 1.59" (40mm) diameter.		
5507T2	 Single Receptacle Faceplate – For covering single receptacles – 1.41" (36mm) diameter.		

NOTE: No suffix denotes ivory finish. Add “-WH” suffix for white finish, and “G” for Gray finish. Consult factory for custom colors.



Electrical Wiring Systems
 60 Woodlawn Street
 West Hartford, CT 06110
 Phone: 1.877.BY.LEGRAND (295-3472)
www.legrand.us
 570 Applewood Crescent
 Vaughan, Ontario L4K 4B4
 Phone: 905.738.9195
www.legrand.ca

