

DESCRIPTION

The SkyRidge™ transforms ambient lighting by perfectly blending a refined modern styling with our breakthrough WaveStream™ LED technology to deliver exceptional performance and superior energy savings. SkyRidge's advanced engineered LED system with superior optical design delivers an unparalleled combination of optimal light uniformity and exceptional efficiency for greater energy savings.

SkyRidge is compatible with all of today's popular ceiling systems and available in a variety of configurations for application versatility. Its perfect balance of form and function make it an ideal choice for commercial office spaces, schools, hospitals, retail and other indoor ambient applications.

SPECIFICATION FEATURES

Construction

Shallow 4.75" deep housing is extruded aluminum frame and injected molded composite end plates. End plates are securely attached with screws for strength and rigidity and the elimination of gaps. End plates have accessory grid-lock feature for safety and convenience. Four auxiliary fixture end suspension points are provided. Large access plate for supply connection.

Controls

Metalux LED luminaires come standard with 0-10V dimming drivers (1% standard).

Options compatible with Eaton's Connected Lighting Systems:

- WaveLinX sensor
- LumaWatt Pro sensor
- SVPD sensor
- DLVP sensor and driver
- Fifth Light DALI driver

Other options include step-dimming and 3rd party drivers. Refer to the Connected Lighting options page and ordering information for more details.

Electrical

Long-life LED system coupled with

electrical driver to deliver optimal performance. LED's available in 3000K, 3500K, 4000K or 5000K with a minimum CRI of 80. Projected life is 100,000 hours at 92% lumen output. Electronic drivers are available for 120-277V applications.

Emergency Battery Pack Option

Optional 120V-277V integral emergency battery pack is available in 7-watts or 14-watts to meet critical life-safety lighting requirements. The 90-minute batteries provide constant power to the LED system, ensuring code-compliance. A test switch/indicator button can be tested safely from the ground using a laser pointer, while the patented EZ Key prevents accidental discharge of the battery during construction. Emergency/generator transfer options available – see ordering information for details.

Driver Access

Drivers can be accessed via plenum.

Finish

Durable frame has high reflectance baked matte white enamel finish for luminous uniformity.

Catalog #		Type
Project		
Comments		Date
Prepared by		

Optics

Precision formed optical assembly with positively retained high optical grade acrylic lens provides a directed optical distribution using WaveStream LED technology.

SkyTrim Accessory

Designed for an array of interior applications, SkyTrim is a luminous decorative accent that can be mounted directly on the light guide of a SkyRidge fixture either at the factory or in the field. It is ideal for spaces where color is necessary to provide visual cues, emphasize brand identity, directional awareness or simply as an artistic expression.

Compliance

Components are UL recognized. Indoor luminaires are cULus listed for 25° C ambient environments, RoHS compliant, and comply with IESNA LM-79. LEDs comply with LM-80 standards. DesignLights Consortium® Qualified and classified for DLC Standard, refer to www.designlights.org for details.

Warranty

Five year warranty.



22SR LED

2' X 2' TROFFER LED MODULE

Specification Grade Troffer

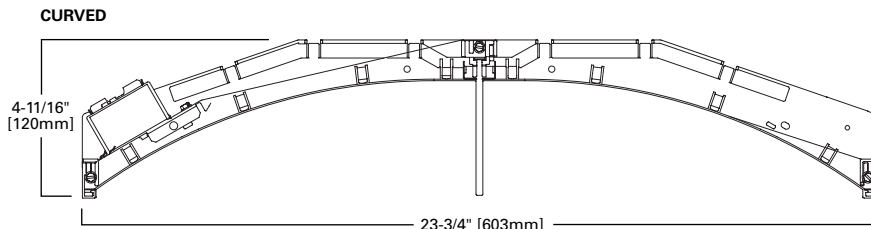

MOUNTING DATA

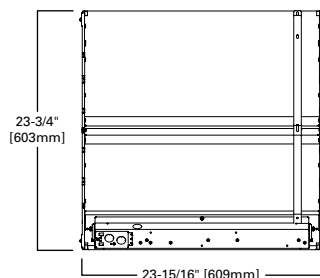

LAMP CONFIGURATIONS

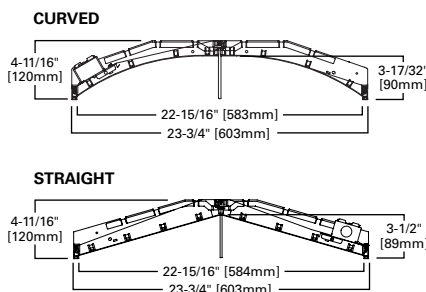

CERTIFICATION DATA

cULus - 1598 and 2043**
 Damp Location Listed
 IC Rated
 LM79/LM80 Compliant
 ROHS Compliant
 DesignLights Consortium® Qualified
 NOM Compliant

*See Drywall Frame Kit Accessory in Ordering Information section.

**Fixture construction is suitable for use in Air-handling and plenum rated spaces in accordance with Section 300.22 (C) of the National Electrical Code, Section 4.3.11.2.6.5 of NFPA 90A and Section 602.2.1.4 of ICC.

LINEAR DISCONNECT

Safe and convenient means of disconnecting power



CEILING COMPATIBILITY

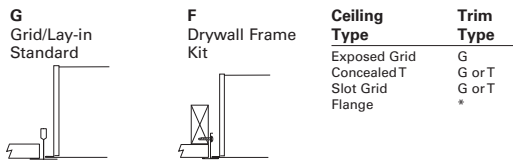

PHOTOMETRICS

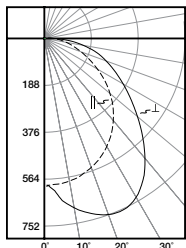

22SR-LD2-20-C-UNV-L835-CD1-U

Electronic Driver
Linear LED 3500K
Spacing criterion: (II) 1.22 x mounting height, (⊥) 1.6 x mounting height
Lumens: 2107
Input Watts: 15.4W
Efficacy: 136.8 lm/W
Test Report: 22SR-LD2-20-C-UNV-L835-CD1-U, IES

Candlepower

Angle	Along II	45°	Across ⊥
0	589	589	589
5	585	629	653
10	575	663	698
15	559	677	730
20	539	677	750
25	514	666	748
30	483	642	721
35	448	602	671
40	407	552	602
45	364	498	530
50	316	443	459
55	264	390	395
60	213	336	337
65	165	286	285
70	123	238	237
75	90	192	188
80	59	143	127
85	31	77	65
90	0	0	0

Coefficients of Utilization

rc rw RCR	Effective floor cavity reflectance																						
	80%				70%				50%				30%				10%				0%		
0	119	119	119	119	116	116	116	116	111	111	111	111	106	106	106	106	102	102	102	102	100	100	
1	108	103	98	94	105	100	96	92	96	93	90	92	89	87	89	86	84	82	82	82	82	82	
2	98	89	82	76	95	87	81	75	84	78	73	80	76	71	77	73	70	68	68	68	68	68	
3	89	78	69	63	86	76	68	62	73	67	61	71	65	60	68	63	59	57	57	57	57	57	
4	81	69	60	53	79	68	59	53	65	58	52	63	56	51	60	55	50	48	48	48	48	48	
5	75	62	52	45	73	60	52	45	58	51	45	56	49	44	54	48	44	41	41	41	41	41	
6	69	55	46	40	67	54	46	39	53	45	39	51	44	39	49	43	38	36	36	36	36	36	
7	64	50	41	35	62	49	41	35	48	40	34	46	39	34	45	39	34	32	32	32	32	32	
8	59	46	37	31	58	45	37	31	44	36	31	42	36	31	41	35	30	28	28	28	28	28	
9	56	42	34	28	54	41	33	28	40	33	28	39	32	27	38	32	27	25	25	25	25	25	
10	52	39	31	25	51	38	30	25	37	30	25	36	30	25	35	29	25	23	23	23	23	23	

Zonal Lumen Summary

Zone	Lumens	% Fixture
0-30	549	26.1
0-40	913	43.3
0-60	1602	76.0
0-90	2107	96.3
0-180	2107	100.0

Luminance Data

Angle in Deg	Average 0-Deg cd/sm	Average 45-Deg cd/sm	Average 90-Deg cd/sm
30	1650	2256	2400
45	1476	2175	2205
60	1247	2170	2162
75	1100	2376	2321
85	1128	2822	2377

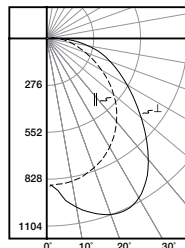

22SR-LD2-29-C-UNV-L835-CD1-U

Electronic Driver
Linear LED 3500K
Spacing criterion: (II) 1.22 x mounting height, (⊥) 1.6 x mounting height
Lumens: 3095
Input Watts: 23.4W
Efficacy: 132.3 lm/W
Test Report: 22SR-LD2-29-C-UNV-L835-CD1-U, IES

Candlepower

Angle	Along II	45°	Across ⊥
0	865	865	865
5	859	924	959
10	845	974	1025
15	820	995	1072
20	791	995	1101
25	754	978	1099
30	709	943	1059
35	658	885	985
40	598	811	885
45	535	732	779
50	464	651	674
55	388	572	580
60	313	493	495
65	242	421	419
70	181	350	348
75	131	282	276
80	87	210	187
85	45	113	95
90	0	0	0

Coefficients of Utilization

rc rw RCR	Effective floor cavity reflectance																						
	80%				70%				50%				30%				10%				0%		
0	119	119	119	119	116	116	116	116	111	111	111	111	106	106	106	106	102	102	102	102	100	100	
1	108	103	98	94	105	100	96	92	96	93	90	92	89	87	89	86	84	82	82	82	82	82	
2	98	89	82	76	95	87	81	75	84	78	73	80	76	71	77	73	70	68	68	68	68	68	
3	89	78	69	63	86	76	68	62	73	67	61	71	65	60	68	63	59	57	57	57	57	57	
4	81	69	60	53	79	68	59	53	65	58	52	63	56	51	60	55	50	48	48	48	48	48	
5	75	62	52	45	73	60	52	45	58	51	45	56	49	44	54	48	44	41	41	41	41	41	
6	69	55	46	40	67	54	46	39	53	45	39	51	44	39	49	43	38	36	36	36	36	36	
7	64	50	41	35	62	49	41	35	48	40	34	46	39	34	45	39	34	32	32	32	32	32	
8	59	46	37	31	58	45	37	31	44	36	31	42	36	31	41	35	30	28	28	28	28	28	
9	56	42	34	28	54	41	33	28	40	33	28	39	32	27	38	32	27	25	25	25	25	25	
10	52	39	31	25	51	38	30	25	37	30	25	36	30	25	35	29	25	23	23	23	23	23	

Zonal Lumen Summary

Zone	Lumens	% Fixture
0-30	807	26.1
0-40	1341	43.3
0-60	2353	76.0
0-90	3095	100.0
0-180	3095	100.0

Luminance Data

Angle in Deg	Average 0-Deg cd/sm	Average 45-Deg cd/sm	Average 90-Deg cd/sm
30	2423	3314	3526
45	2169	3195	3239
60	1832	3188	3176
75	1616	3491	3410
85	1657	4145	3494

LUMEN MAINTENANCE

Ambient Temperature	TM-21 Lumen Maintenance (100,000 hours)	Theoretical L70 (Hours)
25°C	> 92%	> 448,000

Non-IC data

SKYTRIM FIELD INSTALLATION KITS

Color Choice	Kit Catalog Number	Kit Quantity
Tahitian Blue	STK-2-TB-10PK	10
Primary Green	STK-2-PG-10PK	10
Storaro Orange	STK-2-SO-10PK	10
Belladonna Rose	STK-2-BR-10PK	10
Medium Red	STK-2-MR-10PK	10
Pearl	STK-2-PL-10PK	10
Straw	STK-2-ST-10PK	10

Note: Chosen color will be matched on acrylic but will appear lighter once applied to lit light guide.

ENERGY AND PERFORMANCE DATA BY CATALOG NUMBER

Stock or MTO*	Catalog Logic (Curved)	Delivered Lumens	Watts	Efficacy (LPW)
MTO	22SR-LD2-20-C-UNV-L830-CD1-U	2044	15.4	133
Stock	22SR-LD2-20-C-UNV-L835-CD1-U	2107	15.4	137
Stock	22SR-LD2-20-C-UNV-L840-CD1-U	2149	15.4	140
MTO	22SR-LD2-20-C-UNV-L850-CD1-U	2339	15.4	152
MTO	22SR-LD2-25-C-UNV-L830-CD1-U	2571	19.6	131
MTO	22SR-LD2-25-C-UNV-L835-CD1-U	2651	19.6	135
MTO	22SR-LD2-25-C-UNV-L840-CD1-U	2705	19.6	138
MTO	22SR-LD2-25-C-UNV-L850-CD1-U	2943	19.6	150
MTO	22SR-LD2-29-C-UNV-L830-CD1-U	3003	23.4	128
Stock	22SR-LD2-29-C-UNV-L835-CD1-U	3095	23.4	132
Stock	22SR-LD2-29-C-UNV-L840-CD1-U	3157	23.4	135
MTO	22SR-LD2-29-C-UNV-L850-CD1-U	3436	23.4	147

Stock or MTO*	Catalog Logic (Straight)	Delivered Lumens	Watts	Efficacy (LPW)
MTO	22SR-LD2-20-S-UNV-L830-CD1-U	2081	15.4	135
MTO	22SR-LD2-20-S-UNV-L835-CD1-U	2145	15.4	139
MTO	22SR-LD2-20-S-UNV-L840-CD1-U	2188	15.4	142
MTO	22SR-LD2-20-S-UNV-L850-CD1-U	2381	15.4	155
MTO	22SR-LD2-25-S-UNV-L830-CD1-U	2619	19.6	134
MTO	22SR-LD2-25-S-UNV-L835-CD1-U	2700	19.6	138
MTO	22SR-LD2-25-S-UNV-L840-CD1-U	2753	19.6	140
MTO	22SR-LD2-25-S-UNV-L850-CD1-U	2996	19.6	153
MTO	22SR-LD2-29-S-UNV-L830-CD1-U	3057	23.4	131
MTO	22SR-LD2-29-S-UNV-L835-CD1-U	3151	23.4	135
MTO	22SR-LD2-29-S-UNV-L840-CD1-U	3214	23.4	137
MTO	22SR-LD2-29-S-UNV-L850-CD1-U	3498	23.4	149

*Made to order (MTO) requires a typical two week lead time.

ORDERING INFORMATION

SAMPLE NUMBER: 22SR-LD2-29-C-UNV-L835-CD1-SVPD1-U

<p>Rating Blank=Standard ATW-SW4=Chicago Rated ⁽³⁾</p> <p>Series ⁽⁶⁾ 22SR=2' x 2' SkyRidge Series</p> <p>Air [Blank]=Standard A=Air (Vented) ⁽⁴⁾</p>	<p>Lamp Type LD2=LED 2.0</p> <p>Stock Lumen Outputs 20=2000 Lumens 29=2900 Lumens MTO Lumen Outputs 25=2500 Lumens</p> <p>Reflector C=Curved (Standard) S=Straight</p>	<p>Optics Blank=Standard</p> <p>Voltage ⁽¹⁾ 347V=347 Volt UNV=Universal Voltage 120-277 48V=48 Volt Low-voltage (Class 2) ⁽²⁾</p> <p>Options Emergency EL7W=7-watt, 120V-277V emergency battery pack installed ⁽²⁾ EL14W=14-watt 120V-277V emergency battery pack installed ⁽²⁾ ELV7W=7-watt, DLVP-compatible low voltage emergency battery pack installed ⁽²⁾ ELV14W=14-watt DLVP-compatible low voltage emergency battery pack installed ⁽²⁾ GTR2=Bodine Generator Transfer Relay ⁽⁷⁾ ETR2=lota Emergency Transfer Relay ⁽⁷⁾ ETRD=lota Emergency Transfer Relay with dimming control ⁽⁷⁾</p> <p>CCT L830=3000K L835=3500K L840=4000K L850=5000K</p> <p>Flex A3/8-4/18GDIM=3/8" Flex with 0-10V Dimming Leads Multiple other configurations available. See below for details.</p>	<p>Driver Type CD=0-10V Dimming Driver (1%-100% Dimming) SR=Sensor-ready Dimming Driver for LWIPD1 option (1%-100% Dimming) ⁽⁸⁾ 5LTD=Fifth Light DALI Driver (10%-100% Dimming) ⁽⁶⁾ 5LTHD=Fifth Light Dimming Driver (1%-100% Dimming) ⁽⁶⁾ LV1=DLVP Dimming Driver (0%-100% Dimming) ⁽²⁾ SD=Step Dimming Driver (50% or 100% Dimming) LH=Lutron HiLume (LDE1 series) 1%-100% EcoSystem Driver with Soft-on Fade to Black dimming ⁽⁹⁾ L5=Lutron 5 Series (LDE5-Series) 5%-100% EcoSystem Driver ⁽⁹⁾ LU=Lutron HiLume (L3D series) 1%-100% EcoSystem/3-wire Driver ⁽⁹⁾</p> <p>Number of Drivers 1=1 Driver</p>
--	---	---	---

Integrated Sensing Systems
SWPD1=WaveLinX Wireless Integrated Sensor ^(A)
LWIPD1=LumaWatt Pro Wireless Integrated Sensor ^(B)
LWTPD1=LumaWatt Pro Wireless Tile-mount Sensor ^(B)
SLVPD1=DLVP Low-voltage Integrated Sensor ^(C)
SVPD1=0-10V Stand-alone Integrated Sensor ^(D)

SkyTrim ⁽⁶⁾
TB=Tahitian Blue
PG=Primary Green
SO=Storaro Orange
PL=Pearl
BR=Belladonna Rose
MR=Medium Red
ST=Straw

Packaging
U=Unit Pack
PALC=Job Pack, in carton

ACCESSORIES

- T3A END E.Q. BRACKET PARTS BAG (Standard with fixture)
- DF-22-W=2' x 2' Drywall Frame Kit
- SK-22-WT=2' x 2' Tall Surface Mount Kit
- DF10P-C_=Decorator Dimmer, 0-10V
- SF10P-_=Decorator Slide Dimmer, 0-10V
- ISHH-01=Programming Remote for Integrated Sensor ^(D)
- ISHH-02=Personal Control Remote for Integrated Sensor ^(D)



NOTES: ⁽¹⁾ Products also available in non-US voltages and frequencies for international markets. ⁽²⁾ With integral test switch/indicator/laser test. For approximate delivered lumens multiply the lumens per watt of the desired fixture by the wattage of the emergency battery pack (100 lm/W x 7=700 lumens). IES-format photometry for luminaire under emergency operation available. ⁽³⁾ Chicago rated version does not allow for row mounting. ⁽⁴⁾ Air version is vented but does not meet air handling requirements. Air version is non-IC. Air version is not available with integrated sensor. ⁽⁵⁾ DesignLights Consortium® Qualified and classified for DLC Standard, refer to www.designlights.org for details. ⁽⁶⁾ Fixtures using factory installed SkyTrim option are not DLC qualified. ⁽⁷⁾ Used to bypass local control during outage. Must be used in conjunction with UL 1008 device (provided by others). GTR2 and ETR2 options include 2 relays on fixtures with dimming drivers. ETRD option only requires one relay when used on a dimming fixture. Must specify voltage as 120V or 277V when ordering these devices.

Integrated Sensing and Control System Options
NOTES: Integrated options must be used in conjunction with the associated system and may not be compatible with other options or accessories. Please refer to the following: ^(A) Consult WaveLinX system pages for additional details and compatibility. ^(B) Consult LumaWatt Pro system pages for additional details and compatibility. ^(C) Consult DLVP system pages for additional details and compatibility. ^(D) Consult SVPD series system pages for additional details and compatibility. ^(E) Consult Fifth Light system pages for additional details and compatibility. ^(F) Consult Marketplace Options - Lutron system pages for additional details and compatibility. Compatible only with driver series shown, and may require two or more drivers. Requires field commissioning to operate or dim. Contact Lutron at www.lutron.com.

Flexible Metal Conduit Options
Flex options available for 0-10V dimming control, DALI dimming control, emergency and night light functions. 72-inch factory-installed and pre-wired to driver, fitted to luminaire housing access plate with 90° enclosed FMC connector. Not all options may be combined and installation ratings vary by type.
A3/8-4/18GDIM series notes: Factory installed dimming option 3/8" flexible metal conduit with 2-#18 power and ground wires and 2-#18 UL-listed jacketed 0-10V +/- control wires. Meets UL 66, 83, 1479, 1569, 1581, 2556. NEC® 250.118, 300.22(C), 392, 396, 330, 501, 502, 503, 530, 504, 505, 518, 520, 530, 645, 72; Federal Specification A-A-59544 (formerly J-C-30B); all applicable OSHA and HUD Requirements. UL Classified 1-, 2-, and 3-hour through penetration with applicable fire stop product (not included). May be surface mounted, fished and/or embedded in plaster. Cable tray and approved raceway rated, install per NEC®; Environmental Air-Handling Space Installation per NEC® 300.22(C).

Specifications & dimensions subject to change without notice. Consult your Eaton Representative for availability and ordering information.

SHIPPING DATA	
Catalog No.	Wt.
22SR-LD2-20	12 lbs.
22SR-LD2-29	12 lbs.



Eaton
1121 Highway 74 South
Peachtree City, GA 30269
P: 770-486-4800
www.eaton.com/lighting

Specifications and dimensions subject to change without notice.

INTEGRATED SENSOR

The SkyRidge with Integrated Sensor technology provides automatic energy savings without sacrificing performance. Traditionally, these types of energy savings required coordination between the luminaire and a lighting control system. The SkyRidge delivers superior lighting with integrated occupancy and daylighting controls.

Capture the benefits of traditional lighting controls, without complicated coverage planning or special wiring. Ideal for new construction or retrofit, the SkyRidge delivers automatic ON to an energy saving light level, while ensuring lighting is turned OFF when the space is unoccupied.

The integral daylight sensor reduces the need for special daylight zone planning. Each luminaire will automatically adjust the light level based on reflected light beneath the sensor in a closed loop method.

Occupied daylight light levels and unoccupied light levels can be adjusted using the integrated sensor programming remote (Catalog Number: ISHH-01). The integrated sensor personal remote (Catalog Number: ISHH-02) provides code compliant manual raise, lower, ON, OFF control.

The SkyRidge with Integrated Sensor is easy to install with no special wiring and ensures energy savings out-of-the-box with default control settings.

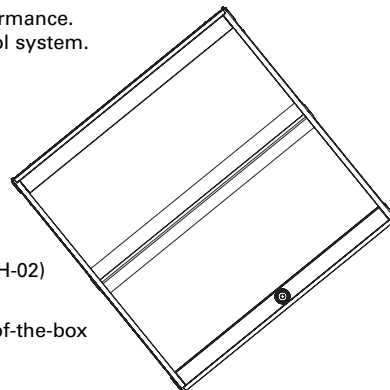

How it works:

- As the user enters the space controlled by the integral sensor, the lighting turns ON to the default daylight level.
- Lighting will remain at that the daylight level until the space is unoccupied. This will start the occupancy timeout period (default 20 minutes).
- If the space remains unoccupied for half of the timeout period, the lighting will automatically reduce to the Energy Saver light level. This adjustable light level is typically half of the occupied daylight level.
- At the end of the timeout period the lighting will go to the unoccupied light level. This adjustable light level uses the OFF default setting.

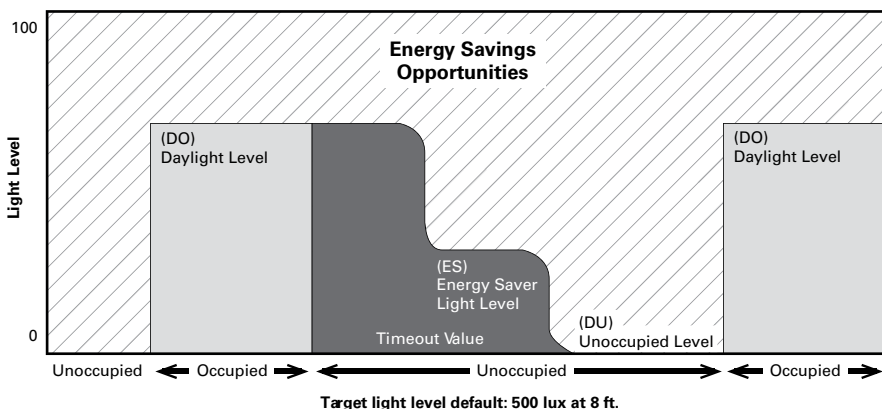

Coverage

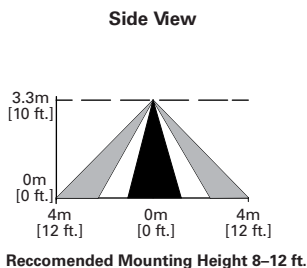
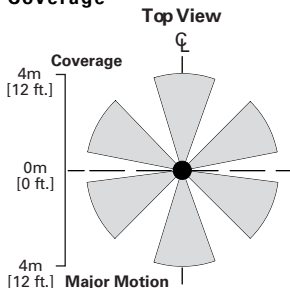

Optional Remote Controls



ISHH-01 Programming Remote



ISHH-02 Personal Control Remote

DESCRIPTION

The SkyRidge™ transforms ambient lighting by perfectly blending a refined modern styling with our breakthrough WaveStream™ LED technology to deliver exceptional performance and superior energy savings. SkyRidge's advanced engineered LED system with superior optical design delivers an unparalleled combination of optimal light uniformity and exceptional efficiency for greater energy savings.

SkyRidge is compatible with all of today's popular ceiling systems and available in a variety of configurations for application versatility. Its perfect balance of form and function make it an ideal choice for commercial office spaces, schools, hospitals, retail and other indoor ambient applications.

SPECIFICATION FEATURES

Construction

Shallow 4.75" deep housing is extruded aluminum frame and injected molded composite end plates. End plates are securely attached with screws for strength and rigidity and the elimination of gaps. End plates have accessory grid-lock feature for safety and convenience. Four auxiliary fixture end suspension points are provided. Large access plate for supply connection.

Controls

Metalux LED luminaires come standard with 0-10V dimming drivers (1% standard).

Options compatible with Eaton's Connected Lighting Systems:

- WaveLinX sensor
- LumaWatt Pro sensor
- SVPD sensor
- DLVP sensor and driver
- Fifth Light DALI driver

Other options include step-dimming and 3rd party drivers. Refer to the Connected Lighting options page and ordering information for more details.

Electrical

Long-life LED system coupled with

electrical driver to deliver optimal performance. LED's available in 3000K, 3500K, 4000K or 5000K with a minimum CRI of 80. Projected life is 100,000 hours at 92% lumen output. Electronic drivers are available for 120-277V applications.

Emergency Battery Pack Option

Optional 120V-277V integral emergency battery pack is available in 7-watts or 14-watts to meet critical life-safety lighting requirements. The 90-minute batteries provide constant power to the LED system, ensuring code-compliance. A test switch/indicator button can be tested safely from the ground using a laser pointer, while the patented EZ Key prevents accidental discharge of the battery during construction. Emergency/generator transfer options available – see ordering information for details.

Driver Access

Drivers can be accessed via plenum.

Finish

Durable frame has high reflectance baked matte white enamel finish for luminous uniformity.

Catalog #		Type
Project		
Comments		Date
Prepared by		

Optics

Precision formed optical assembly with positively retained high optical grade acrylic lens provides a directed optical distribution using WaveStream LED technology.

SkyTrim Accessory

Designed for an array of interior applications, SkyTrim is a luminous decorative accent that can be mounted directly on the light guide of a SkyRidge fixture either at the factory or in the field. It is ideal for spaces where color is necessary to provide visual cues, emphasize brand identity, directional awareness or simply as an artistic expression.

Compliance

Components are UL recognized. Indoor luminaires are cULus listed for 25° C ambient environments, RoHS compliant, and comply with IESNA LM-79. LEDs comply with LM-80 standards. DesignLights Consortium® Qualified and classified for DLC Standard, refer to www.designlights.org for details.

Warranty

Five year warranty.



**22SR
LED**

**2' X 2' TROFFER
LED MODULE**

Specification Grade Troffer



Connected Systems
[CLICK HERE](#)

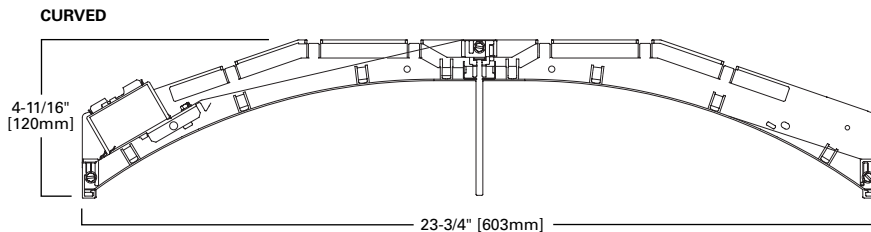

MOUNTING DATA

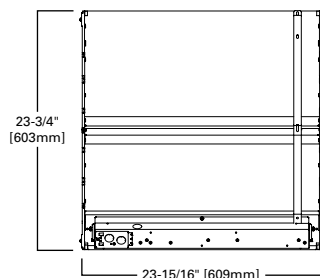

LAMP CONFIGURATIONS

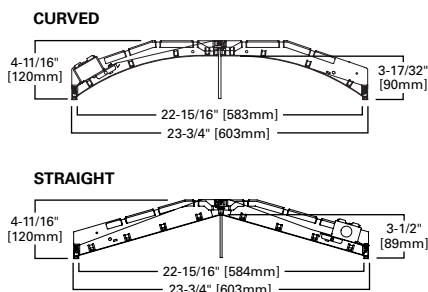

CERTIFICATION DATA

cULus - 1598 and 2043**
 Damp Location Listed
 IC Rated
 LM79/LM80 Compliant
 ROHS Compliant
 DesignLights Consortium® Qualified
 NOM Compliant

*See Drywall Frame Kit Accessory in Ordering Information section.

**Fixture construction is suitable for use in Air-handling and plenum rated spaces in accordance with Section 300.22 (C) of the National Electrical Code, Section 4.3.11.2.6.5 of NFPA 90A and Section 602.2.1.4 of ICC.

LINEAR DISCONNECT

Safe and convenient means of disconnecting power



PS519068EN
 May 4, 2018 1:56 PM

CEILING COMPATIBILITY

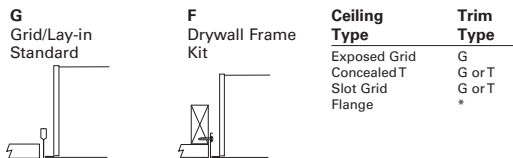

PHOTOMETRICS

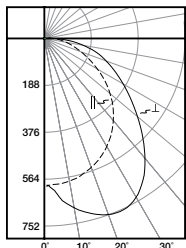

22SR-LD2-20-C-UNV-L835-CD1-U

Electronic Driver
Linear LED 3500K
Spacing criterion: (II) 1.22 x mounting height, (⊥) 1.6 x mounting height
Lumens: 2107
Input Watts: 15.4W
Efficacy: 136.8 lm/W
Test Report: 22SR-LD2-20-C-UNV-L835-CD1-U, IES

Candlepower

Angle	Along II	45°	Across ⊥
0	589	589	589
5	585	629	653
10	575	663	698
15	559	677	730
20	539	677	750
25	514	666	748
30	483	642	721
35	448	602	671
40	407	552	602
45	364	498	530
50	316	443	459
55	264	390	395
60	213	336	337
65	165	286	285
70	123	238	237
75	90	192	188
80	59	143	127
85	31	77	65
90	0	0	0

Coefficients of Utilization

rc rw RCR	Effective floor cavity reflectance																						
	80%				70%				50%				30%				10%				0%		
0	119	119	119	119	116	116	116	116	111	111	111	111	106	106	106	106	102	102	102	102	100	100	
1	108	103	98	94	105	100	96	92	96	93	90	92	89	87	89	86	84	82	82	82	82	82	
2	98	89	82	76	95	87	81	75	84	78	73	80	76	71	77	73	70	68	68	68	68	68	
3	89	78	69	63	86	76	68	62	73	67	61	71	65	60	68	63	59	57	57	57	57	57	
4	81	69	60	53	79	68	59	53	65	58	52	63	56	51	60	55	50	48	48	48	48	48	
5	75	62	52	45	73	60	52	45	58	51	45	56	49	44	54	48	44	41	41	41	41	41	
6	69	55	46	40	67	54	46	39	53	45	39	51	44	39	49	43	38	36	36	36	36	36	
7	64	50	41	35	62	49	41	35	48	40	34	46	39	34	45	39	34	32	32	32	32	32	
8	59	46	37	31	58	45	37	31	44	36	31	42	36	31	41	35	30	28	28	28	28	28	
9	56	42	34	28	54	41	33	28	40	33	28	39	32	27	38	32	27	25	25	25	25	25	
10	52	39	31	25	51	38	30	25	37	30	25	36	30	25	35	29	25	23	23	23	23	23	

Zonal Lumen Summary

Zone	Lumens	% Fixture
0-30	549	26.1
0-40	913	43.3
0-60	1602	76.0
0-90	2107	96.3
0-180	2107	100.0

Luminance Data

Angle in Deg	Average 0-Deg cd/sm	Average 45-Deg cd/sm	Average 90-Deg cd/sm
30	1650	2256	2400
45	1476	2175	2205
60	1247	2170	2162
75	1100	2376	2321
85	1128	2822	2377

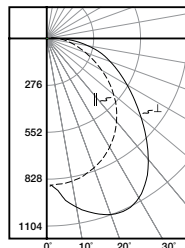

22SR-LD2-29-C-UNV-L835-CD1-U

Electronic Driver
Linear LED 3500K
Spacing criterion: (II) 1.22 x mounting height, (⊥) 1.6 x mounting height
Lumens: 3095
Input Watts: 23.4W
Efficacy: 132.3 lm/W
Test Report: 22SR-LD2-29-C-UNV-L835-CD1-U, IES

Candlepower

Angle	Along II	45°	Across ⊥
0	865	865	865
5	859	924	959
10	845	974	1025
15	820	995	1072
20	791	995	1101
25	754	978	1099
30	709	943	1059
35	658	885	985
40	598	811	885
45	535	732	779
50	464	651	674
55	388	572	580
60	313	493	495
65	242	421	419
70	181	350	348
75	131	282	276
80	87	210	187
85	45	113	95
90	0	0	0

Coefficients of Utilization

rc rw RCR	Effective floor cavity reflectance																						
	80%				70%				50%				30%				10%				0%		
0	119	119	119	119	116	116	116	116	111	111	111	111	106	106	106	106	102	102	102	102	100	100	
1	108	103	98	94	105	100	96	92	96	93	90	92	89	87	89	86	84	82	82	82	82	82	
2	98	89	82	76	95	87	81	75	84	78	73	80	76	71	77	73	70	68	68	68	68	68	
3	89	78	69	63	86	76	68	62	73	67	61	71	65	60	68	63	59	57	57	57	57	57	
4	81	69	60	53	79	68	59	53	65	58	52	63	56	51	60	55	50	48	48	48	48	48	
5	75	62	52	45	73	60	52	45	58	51	45	56	49	44	54	48	44	41	41	41	41	41	
6	69	55	46	40	67	54	46	39	53	45	39	51	44	39	49	43	38	36	36	36	36	36	
7	64	50	41	35	62	49	41	35	48	40	34	46	39	34	45	39	34	32	32	32	32	32	
8	59	46	37	31	58	45	37	31	44	36	31	42	36	31	41	35	30	28	28	28	28	28	
9	56	42	34	28	54	41	33	28	40	33	28	39	32	27	38	32	27	25	25	25	25	25	
10	52	39	31	25	51	38	30	25	37	30	25	36	30	25	35	29	25	23	23	23	23	23	

Zonal Lumen Summary

Zone	Lumens	% Fixture
0-30	807	26.1
0-40	1341	43.3
0-60	2353	76.0
0-90	3095	100.0
0-180	3095	100.0

Luminance Data

Angle in Deg	Average 0-Deg cd/sm	Average 45-Deg cd/sm	Average 90-Deg cd/sm
30	2423	3314	3526
45	2169	3195	3239
60	1832	3188	3176
75	1616	3491	3410
85	1657	4145	3494

LUMEN MAINTENANCE

Ambient Temperature	TM-21 Lumen Maintenance (100,000 hours)	Theoretical L70 (Hours)
25°C	> 92%	> 448,000

Non-IC data

SKYTRIM FIELD INSTALLATION KITS

Color Choice	Kit Catalog Number	Kit Quantity
Tahitian Blue	STK-2-TB-10PK	10
Primary Green	STK-2-PG-10PK	10
Storaro Orange	STK-2-SO-10PK	10
Belladonna Rose	STK-2-BR-10PK	10
Medium Red	STK-2-MR-10PK	10
Pearl	STK-2-PL-10PK	10
Straw	STK-2-ST-10PK	10

Note: Chosen color will be matched on acrylic but will appear lighter once applied to lit light guide.

ENERGY AND PERFORMANCE DATA BY CATALOG NUMBER

Stock or MTO*	Catalog Logic (Curved)	Delivered Lumens	Watts	Efficacy (LPW)
MTO	22SR-LD2-20-C-UNV-L830-CD1-U	2044	15.4	133
Stock	22SR-LD2-20-C-UNV-L835-CD1-U	2107	15.4	137
Stock	22SR-LD2-20-C-UNV-L840-CD1-U	2149	15.4	140
MTO	22SR-LD2-20-C-UNV-L850-CD1-U	2339	15.4	152
MTO	22SR-LD2-25-C-UNV-L830-CD1-U	2571	19.6	131
MTO	22SR-LD2-25-C-UNV-L835-CD1-U	2651	19.6	135
MTO	22SR-LD2-25-C-UNV-L840-CD1-U	2705	19.6	138
MTO	22SR-LD2-25-C-UNV-L850-CD1-U	2943	19.6	150
MTO	22SR-LD2-29-C-UNV-L830-CD1-U	3003	23.4	128
Stock	22SR-LD2-29-C-UNV-L835-CD1-U	3095	23.4	132
Stock	22SR-LD2-29-C-UNV-L840-CD1-U	3157	23.4	135
MTO	22SR-LD2-29-C-UNV-L850-CD1-U	3436	23.4	147

Stock or MTO*	Catalog Logic (Straight)	Delivered Lumens	Watts	Efficacy (LPW)
MTO	22SR-LD2-20-S-UNV-L830-CD1-U	2081	15.4	135
MTO	22SR-LD2-20-S-UNV-L835-CD1-U	2145	15.4	139
MTO	22SR-LD2-20-S-UNV-L840-CD1-U	2188	15.4	142
MTO	22SR-LD2-20-S-UNV-L850-CD1-U	2381	15.4	155
MTO	22SR-LD2-25-S-UNV-L830-CD1-U	2619	19.6	134
MTO	22SR-LD2-25-S-UNV-L835-CD1-U	2700	19.6	138
MTO	22SR-LD2-25-S-UNV-L840-CD1-U	2753	19.6	140
MTO	22SR-LD2-25-S-UNV-L850-CD1-U	2996	19.6	153
MTO	22SR-LD2-29-S-UNV-L830-CD1-U	3057	23.4	131
MTO	22SR-LD2-29-S-UNV-L835-CD1-U	3151	23.4	135
MTO	22SR-LD2-29-S-UNV-L840-CD1-U	3214	23.4	137
MTO	22SR-LD2-29-S-UNV-L850-CD1-U	3498	23.4	149

*Made to order (MTO) requires a typical two week lead time.

ORDERING INFORMATION

SAMPLE NUMBER: 22SR-LD2-29-C-UNV-L835-CD1-SVPD1-U

<p>Rating Blank=Standard ATW-SW4=Chicago Rated ⁽³⁾</p> <p>Series ⁽⁶⁾ 22SR=2' x 2' SkyRidge Series</p> <p>Air [Blank]=Standard A=Air (Vented) ⁽⁴⁾</p>	<p>Lamp Type LD2=LED 2.0</p> <p>Stock Lumen Outputs 20=2000 Lumens 29=2900 Lumens MTO Lumen Outputs 25=2500 Lumens</p> <p>Reflector C=Curved (Standard) S=Straight</p>	<p>Optics Blank=Standard</p> <p>Voltage ⁽¹⁾ 347V=347 Volt UNV=Universal Voltage 120-277 48V=48 Volt Low-voltage (Class 2) ⁽²⁾</p> <p>Options Emergency EL7W=7-watt, 120V-277V emergency battery pack installed ⁽²⁾ EL14W=14-watt 120V-277V emergency battery pack installed ⁽²⁾ ELV7W=7-watt, DLVP-compatible low voltage emergency battery pack installed ⁽²⁾ ELV14W=14-watt DLVP-compatible low voltage emergency battery pack installed ⁽²⁾ GTR2=Bodine Generator Transfer Relay ⁽⁷⁾ ETR2=lota Emergency Transfer Relay ⁽⁷⁾ ETRD=lota Emergency Transfer Relay with dimming control ⁽⁷⁾</p> <p>CCT L830=3000K L835=3500K L840=4000K L850=5000K</p> <p>Flex A3/8-4/18GDIM=3/8" Flex with 0-10V Dimming Leads Multiple other configurations available. See below for details.</p>	<p>Driver Type CD=0-10V Dimming Driver (1%-100% Dimming) SR=Sensor-ready Dimming Driver for LWIPD1 option (1%-100% Dimming) ⁽⁸⁾ 5LTD=Fifth Light DALI Driver (10%-100% Dimming) ⁽⁶⁾ 5LTHD=Fifth Light Dimming Driver (1%-100% Dimming) ⁽⁶⁾ LV1=DLVP Dimming Driver (0%-100% Dimming) ⁽²⁾ SD=Step Dimming Driver (50% or 100% Dimming) LH=Lutron HiLume (LDE1 series) 1%-100% EcoSystem Driver with Soft-on Fade to Black dimming ⁽⁹⁾ L5=Lutron 5 Series (LDE5-Series) 5%-100% EcoSystem Driver ⁽⁹⁾ LU=Lutron HiLume (L3D series) 1%-100% EcoSystem/3-wire Driver ⁽⁹⁾</p>	<p>Number of Drivers 1=1 Driver</p>
--	---	---	--	--

Integrated Sensing Systems
SWPD1=WaveLinX Wireless Integrated Sensor ^(A)
LWIPD1=LumaWatt Pro Wireless Integrated Sensor ^(B)
LWTPD1=LumaWatt Pro Wireless Tile-mount Sensor ^(B)
SLVPD1=DLVP Low-voltage Integrated Sensor ^(C)
SVPD1=0-10V Stand-alone Integrated Sensor ^(D)

SkyTrim ⁽⁶⁾
TB=Tahitian Blue
PG=Primary Green
SO=Storaro Orange
PL=Pearl
BR=Belladonna Rose
MR=Medium Red
ST=Straw

Packaging
U=Unit Pack
PALC=Job Pack, in carton

ACCESSORIES
T3A END E.Q. BRACKET PARTS BAG (Standard with fixture)
DF-22-W=2' x 2' Drywall Frame Kit
SK-22-WT=2' x 2' Tall Surface Mount Kit
DF10P-C_=Decorator Dimmer, 0-10V
SF10P-_=Decorator Slide Dimmer, 0-10V
ISHH-01=Programming Remote for Integrated Sensor ^(D)
ISHH-02=Personal Control Remote for Integrated Sensor ^(D)



NOTES: ⁽¹⁾ Products also available in non-US voltages and frequencies for international markets. ⁽²⁾ With integral test switch/indicator/laser test. For approximate delivered lumens multiply the lumens per watt of the desired fixture by the wattage of the emergency battery pack (100 lm/W x 7=700 lumens). IES-format photometry for luminaire under emergency operation available. ⁽³⁾ Chicago rated version does not allow for row mounting. ⁽⁴⁾ Air version is vented but does not meet air handling requirements. Air version is non-IC. Air version is not available with integrated sensor. ⁽⁵⁾ DesignLights Consortium® Qualified and classified for DLC Standard, refer to www.designlights.org for details. ⁽⁶⁾ Fixtures using factory installed SkyTrim option are not DLC qualified. ⁽⁷⁾ Used to bypass local control during outage. Must be used in conjunction with UL 1008 device (provided by others). GTR2 and ETR2 options include 2 relays on fixtures with dimming drivers. ETRD option only requires one relay when used on a dimming fixture. Must specify voltage as 120V or 277V when ordering these devices.

Integrated Sensing and Control System Options
NOTES: Integrated options must be used in conjunction with the associated system and may not be compatible with other options or accessories. Please refer to the following: ^(A) Consult WaveLinX system pages for additional details and compatibility. ^(B) Consult LumaWatt Pro system pages for additional details and compatibility. ^(C) Consult DLVP system pages for additional details and compatibility. ^(D) Consult SVPD series system pages for additional details and compatibility. ^(E) Consult Fifth Light system pages for additional details and compatibility. ^(F) Consult Marketplace Options - Lutron system pages for additional details and compatibility. Compatible only with driver series shown, and may require two or more drivers. Requires field commissioning to operate or dim. Contact Lutron at www.lutron.com.

Flexible Metal Conduit Options
Flex options available for 0-10V dimming control, DALI dimming control, emergency and night light functions. 72-inch factory-installed and pre-wired to driver, fitted to luminaire housing access plate with 90° enclosed FMC connector. Not all options may be combined and installation ratings vary by type.
A3/8-4/18GDIM series notes: Factory installed dimming option 3/8" flexible metal conduit with 2-#18 power and ground wires and 2-#18 UL-listed jacketed 0-10V +/- control wires. Meets UL 66, 83, 1479, 1569, 1581, 2556. NEC® 250.118, 300.22(C), 392, 396, 330, 501, 502, 503, 530, 504, 505, 518, 520, 530, 645, 72; Federal Specification A-A-59544 (formerly J-C-30B); all applicable OSHA and HUD Requirements. UL Classified 1-, 2-, and 3-hour through penetration with applicable fire stop product (not included). May be surface mounted, fished and/or embedded in plaster. Cable tray and approved raceway rated, install per NEC®; Environmental Air-Handling Space Installation per NEC® 300.22(C).

Specifications & dimensions subject to change without notice. Consult your Eaton Representative for availability and ordering information.

SHIPPING DATA	
Catalog No.	Wt.
22SR-LD2-20	12 lbs.
22SR-LD2-29	12 lbs.



Eaton
1121 Highway 74 South
Peachtree City, GA 30269
P: 770-486-4800
www.eaton.com/lighting

Specifications and dimensions subject to change without notice.

PS519068EN
May 4, 2018 1:56 PM

INTEGRATED SENSOR

The SkyRidge with Integrated Sensor technology provides automatic energy savings without sacrificing performance. Traditionally, these types of energy savings required coordination between the luminaire and a lighting control system. The SkyRidge delivers superior lighting with integrated occupancy and daylighting controls.

Capture the benefits of traditional lighting controls, without complicated coverage planning or special wiring. Ideal for new construction or retrofit, the SkyRidge delivers automatic ON to an energy saving light level, while ensuring lighting is turned OFF when the space is unoccupied.

The integral daylight sensor reduces the need for special daylight zone planning. Each luminaire will automatically adjust the light level based on reflected light beneath the sensor in a closed loop method.

Occupied daylight light levels and unoccupied light levels can be adjusted using the integrated sensor programming remote (Catalog Number: ISHH-01). The integrated sensor personal remote (Catalog Number: ISHH-02) provides code compliant manual raise, lower, ON, OFF control.

The SkyRidge with Integrated Sensor is easy to install with no special wiring and ensures energy savings out-of-the-box with default control settings.

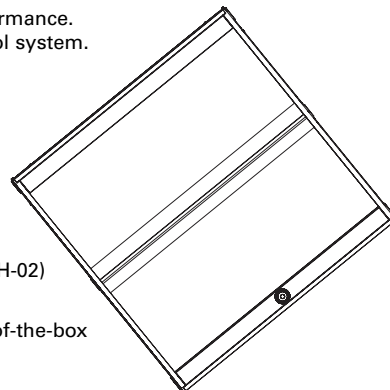

How it works:

- As the user enters the space controlled by the integral sensor, the lighting turns ON to the default daylight level.
- Lighting will remain at that the daylight level until the space is unoccupied. This will start the occupancy timeout period (default 20 minutes).
- If the space remains unoccupied for half of the timeout period, the lighting will automatically reduce to the Energy Saver light level. This adjustable light level is typically half of the occupied daylight level.
- At the end of the timeout period the lighting will go to the unoccupied light level. This adjustable light level uses the OFF default setting.

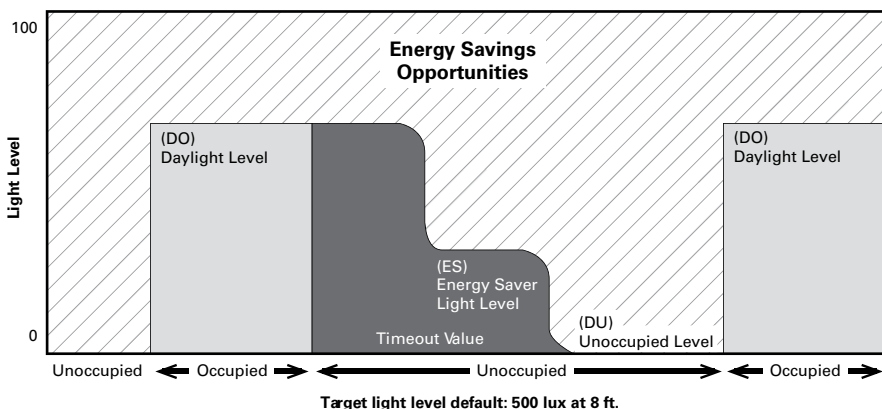

Coverage

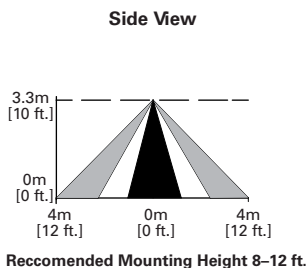
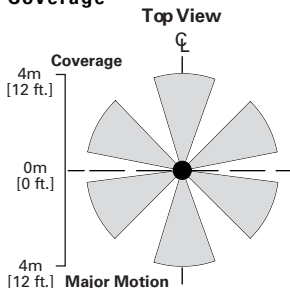

Optional Remote Controls



ISHH-01 Programming Remote



ISHH-02 Personal Control Remote