

# TUBE GUARDS

## STANDARD TUBE GUARDS

The Standard Tube Guard is a light stabilized polycarbonate and has 0% transmittance below 365 nanometers (Clear Tube Guards only). Available Colors: Clear, Amber, Red, Green, Yellow and Blue. Available Sizes: T5, T8, and T12.

- An efficient economical solution where fluorescent lamp breakage would be hazardous to personnel, product, equipment or animals.
- Slip over fluorescent lamps to retain shattered glass and control the release of mercury vapor and phosphorescent material.
- Constructed of unbreakable lexan polycarbonate.
- "Cut-to-order" custom lengths are also available.

## T5 HD SERIES TUBE GUARDS

Using T5 lamps is a cost-effective lighting systems solution for a variety of reasons. Unfortunately the average T5 lamp will dissipate about 73% of its total lamp power as heat. And when this lamp is used in combination with a tube guard, that heat must be properly dissipated from the lamp.

Our T5 HD (Heat Dissipation) Series Tube Guard takes into consideration two major factors; the temperature on the inside of the tube guard, and how close the T5 lamp is actually located to the tube guard.

- Our T5 HD Series Tube Guard's larger diameter and its "vented" End Caps allow a layer of air to absorb heat from the lamp and cool it before making contact with the inside wall of the tube guard. This results in a 25°F temperature drop.\*
- The larger diameter of the T5 HD Series Tube Guard allows it to accommodate Heat Sink to control and distribute heat, in addition to lowering the temperatures over a larger area on the end of the tube guard.

**Note:** We strongly recommend using Heat Sink with our T5 HD Series Tube Guards. Part Numbers 17185 and 17186 arrive with the Heat Sink built into the Tube Guard. See photo to the right below.

- The combination of the T5 HD Series Tube Guard, "vented" End Caps, and Heat Sink lower the inside temperature of the tube guard approximately 30°F.\*\*
- Together, these components provide a unique operational advantage over other competitors T5 tube guards and still fits all T5 lamp applications.

TEMPERATURE TESTING	
CONFIGURATION	TEMPERATURE*
Competitors T5 Tube Guard	215°F
T5 HD Series Tube Guard and "Vented" End Caps	190°F*
T5 HD Series Tube Guard, "Vented" End Caps and Heat Sink	185°F**

\***Note:** The temperature is measured on the inside surface of the Tube Guard. The ambient testing temperature was 72°F using a T5 F54 HO Lamp.

### Fast, Efficient and Repeatable Results

EPCO always recommends using "Heat Sink Screens" when installing T5 HD Series Tube Guards. Heat sink helps distribute excessive heat on both ends of the fluorescent lamp. But when installing a large number of tube guards and heat sink screen combinations, time is money.

High volume installers can now reduce their installation time by using our T5 HD Series Tube Guard with "pre-installed" Heat Sink. In addition to saving time and money, EPCO's T5 HD Series Tube Guard with "pre-installed" Heat Sink provide a convenient and economical solution to expedite the installation by eliminating the process of having the contractor pre-roll two Heat Sinks (per tube guard).

Simply insert the lamp into the T5 HD Series Tube Guard, insert the "vented" end cap on each end of the tube guard and install the "tubed" lamp into the fixture.

[www.engproducts.com](http://www.engproducts.com)

5401 SMETANA DRIVE | MINNETONKA, MN 55343

P 800.336.1976 | F 800.336.2801

 Made in the USA. Complies with the American Recovery and Reinvestment Act – Buy American Provision.



STANDARD TUBE GUARDS

### TYPICAL APPLICATIONS:

- Food Processing Facilities
- Commercial Kitchens
- Grocery Stores
- Laundries
- Industrial Facilities
- Saunas
- Car Washes
- Storage Buildings
- Pedestrian and Road Tunnels
- Parking Garages
- Elevator Shafts
- Refrigerators and Freezers
- Locker Rooms
- And more...

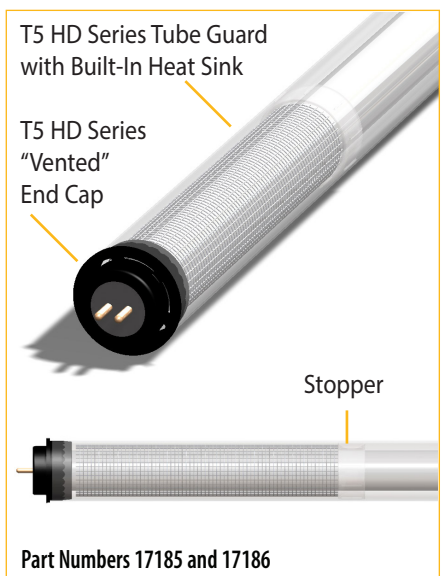

**Note:** T5 HD Series Tube Guards, Part Numbers 17185 and 17186, are bundled with the T5 HD Heat Sink built into the Tube Guard as shown above.

# TUBE GUARDS

## EPCO's YELLOW TUBE GUARDS - How do they work?

Insects and humans have different visual perceptions. Light sources that radiate ultraviolet energy and blue light are most attractive to insects. Light sources that insects have a difficult time seeing are "yellow" hues in the color spectrum. EPCO's yellow tube guards do not repel insects! Using these tube guards will simply minimize the number of insects.

## TYPICAL APPLICATIONS

- Commercial businesses that maintain night-time operations such as gas stations, fast food restaurants, etc.
- Commercial food preparation and serving areas
- Parking lots loading areas
- Airport, Train and Bus Stations
- Building entrances
- Decks and patios



## STANDARD AND UV FILTERING TUBE GUARD DIMENSIONS

T5 HD SERIES TUBE GUARDS		
DIM. "A"	DIM. "B"	NOMINAL LENGTH
44.68	45.27	4'

T8 TUBE GUARDS		
DIM. "A"	DIM. "B"	NOMINAL LENGTH
46.38	47.10	4'
68.38	69.10	6'
92.38	93.10	8'

T12 TUBE GUARDS		
DIM. "A"	DIM. "B"	NOMINAL LENGTH
45.97	47.10	4'
67.97	69.10	6'
91.97	93.10	8'

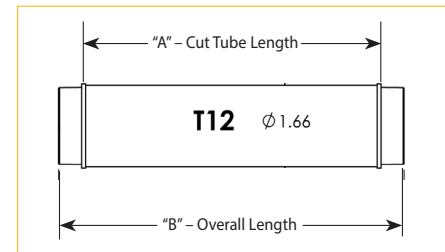
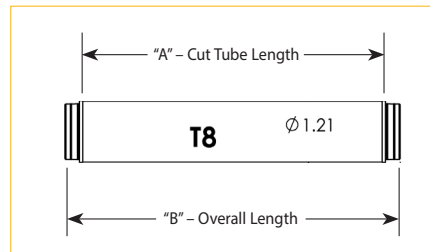
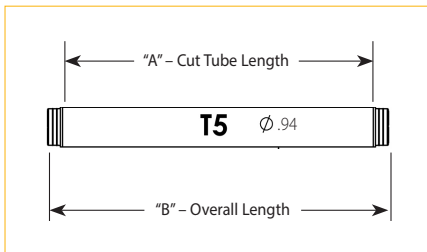

**Note:** Dimension "B" includes End Caps.

## STANDARD TUBE GUARD END CAPS (BLACK)

Catalog Number	UPC Number	Description	Order Unit	Order Qty	Unit Pkg	Units/ Case	TL Case Qty	Min Order Qty	MM Req	Ship Wt (Lbs)
17103	17103	End Caps: for T5 HD Series, "Vented"	EA	48	BG	0	0	48	Yes	1
17100	17100	End Caps: for T8	EA	48	BG	0	0	48	Yes	1
17101	17101	End Caps: for T12	EA	48	BG	0	0	48	Yes	1

**Note:** End Caps for T5 HD Series, T8 and T12 Tube Guards fit inside the Tube Guard.



### UNITS OF MEASURE KEY

**Order Unit:** The Unit to be ordered; **Order Qty:** Number of pieces in each Unit; **Unit Pkg:** Packaging types - BG (Bag), BX (Box), BN (Bulk); **Units/Case:** Unit packages contained in the Case; **TL Case Qty:** The total number of items in each Master Case; **Min Order Qty:** The smallest Unit that can be ordered; **MM Req:** Must order multiples of the Unit in the stated quantities; **Ship Wt (Lbs):** Total weight of the units per carton

 EPCO Standard Tube Guards are Made in the USA.  
Complies with the American Recovery and Reinvestment Act – Buy American Provision.

Specifications subject to change without prior notice.

## STANDARD TUBE GUARDS

Catalog Number	UPC Number	Description	Order Unit	Unit Qty	Unit Pkg	Units/Case	TL Case Qty	Min Order Qty	MM Req	Ship Wt (Lbs)
<b>4-FT T5 HD Series Tube Guard</b>										
17183*	17183	Clear Polycarbonate: with "Vented" Black End Caps	EA	1	BX	48	48	48	Yes	6
17184*	17184	Clear Polycarbonate: with "Vented" Black End Caps	EA	1	BX	120	120	120	Yes	16
17194†	17194	Amber Polycarbonate: with "Vented" Black End Caps	EA	1	BX	24	24	24	Yes	4
17195†	17195	Red Polycarbonate: with "Vented" Black End Caps	EA	1	BX	24	24	24	Yes	4
17196†	17196	Green Polycarbonate: with "Vented" Black End Caps	EA	1	BX	24	24	24	Yes	4
17197†	17197	Blue Polycarbonate: with "Vented" Black End Caps	EA	1	BX	24	24	24	Yes	4
17199†	17199	Yellow Polycarbonate: with "Vented" Black End Caps	EA	1	BX	24	24	24	Yes	4
<b>4-FT T5 HD Series Tube Guard with Built-In Heat Sink</b>										
17185**	17185	Clear Polycarbonate: with "Vented" Black End Caps and built-in Heat Sink	EA	1	BX	48	48	48	Yes	7
17186**	17186	Clear Polycarbonate: with "Vented" Black End Caps and built-in Heat Sink	EA	1	BX	120	120	120	Yes	17
<b>4-FT T8 Tube Guard</b>										
17000	17000	Clear Polycarbonate: with Black End Caps	EA	1	BX	24	24	24	Yes	6
17005	17005	Amber Polycarbonate: with Black End Caps	EA	1	BX	24	24	24	Yes	6
17010	17010	Red Polycarbonate: with Black End Caps	EA	1	BX	24	24	24	Yes	6
17015	17015	Green Polycarbonate: with Black End Caps	EA	1	BX	24	24	24	Yes	6
17020	17020	Blue Polycarbonate: with Black End Caps	EA	1	BX	24	24	24	Yes	6
17025	17025	Yellow Polycarbonate: with Black End Caps	EA	1	BX	24	24	24	Yes	6
<b>6-FT T8 Tube Guard</b>										
17050	17050	Clear Polycarbonate: with Black End Caps	EA	1	BX	24	24	24	Yes	8
<b>8-FT T8 Tube Guard</b>										
17030	17030	Clear Polycarbonate: with Black End Caps	EA	1	BX	24	24	24	Yes	10
17031	17031	Amber Polycarbonate: with Black End Caps	EA	1	BX	24	24	24	Yes	10
17032	17032	Red Polycarbonate: with Black End Caps	EA	1	BX	24	24	24	Yes	10
17033	17033	Green Polycarbonate: with Black End Caps	EA	1	BX	24	24	24	Yes	10
17034	17034	Blue Polycarbonate: with Black End Caps	EA	1	BX	24	24	24	Yes	10
17035	17035	Yellow Polycarbonate: with Black End Caps	EA	1	BX	24	24	24	Yes	10
<b>4-FT T12 Tube Guard</b>										
17060	17060	Clear Polycarbonate: with Black End Caps	EA	1	BX	24	24	24	Yes	7
<b>6-FT T12 Tube Guard</b>										
17040	17040	Clear Polycarbonate: with Black End Caps	EA	1	BX	24	24	24	Yes	10
<b>8-FT T12 Tube Guard</b>										
17090	17090	Clear Polycarbonate: with Black End Caps	EA	1	BX	24	24	24	Yes	10

- Note:** \*1. Standard Tube Guards are sold ONLY in case quantities of 24 per Carton. We will not break case carton quantities!  
The exception is the T5 HD Series - Clear, which is available in carton quantities of 48 and 120 Units (P/Ns: 17183, 17184, 17185 and 17186).
- \*\*2. T5 HD Series Tube Guards, Part Numbers 17185 and 17186 include the built-in T5 HD Heat Sink.
- †3. Indicates long lead time. Contact our Inside Sales Department (800.336.1976 or sales@engproducts.com) for more information.
4. Standard Tube Guards are not intended for use with HO or VHO Lamps! The exception is the T5 HD Series Tube Guard that is rated for use with a T5 HO Lamp.
5. Tube Guards, other than sizes and colors listed, can be special ordered. Contact our Inside Sales Department (800.336.1976 or sales@engproducts.com) for more information.

 EPCO Standard Tube Guards are Made in the USA.  
Complies with the American Recovery and Reinvestment Act – Buy American Provision.

Specifications subject to change without prior notice.

**UNITS OF MEASURE KEY** Order Unit: The Unit to be ordered; Unit Qty: Number of pieces in each Unit; Unit Pkg: Unit Packages contained in the case - Packaging types - BG (Bag), BRL (Barrel), BX (Box), BN (Bulk), PKG (Package), EA (Each), RL (Roll), LB (Pound), C (Hundred), M (Thousand); Units/Case: Unit packages contained in the Case; TL Case Qty: The total number of items in each Master Case; Min Order Qty: The smallest Unit that can be ordered; MM Req: Must order multiples of the Unit in the stated quantities; Ship Wt (Lbs): Total weight of the units per Carton

# TUBE GUARDS

## UV FILTERING TUBE GUARDS

- EPCO's UV Filtering Tube Guards provide the basic reduction of harmful UV energy by filtering 99.9% of harmful UV rays up to 390 nanometers.\*
- Manufactured using thin-wall high tensile and impact resistant polycarbonate material that is flexible to hold the lamp to facilitate lamp changes; does not easily crack.
- Special UV additive filters UV rays better than acrylic materials with comparable wall thickness (0.016" wall thickness).
- Minimizes premature color shifting (fading) and deterioration that can be detrimental to food products, paper, natural and synthetic textiles, paints, coatings, wood and polymer materials, inc.
- Provides years of protection from dangerous UV light.
- Can readily be "field-cut" to length if desired.
- Manufactured to the highest quality standards.
- Sizes: T5, T8, and T12.
- Available in nominal 4-foot and 8-foot lengths.

**\*Note:** Tested by two independent light testing laboratories.



UV FILTERING TUBE GUARDS

### TYPICAL APPLICATIONS:

- Food Service
- Commercial Kitchens
- Photography Studios
- Grocery Stores
- Fabric Stores
- Movie Theaters
- Book Stores
- Libraries
- Furniture Stores
- Warehouses
- Special lighting applications where UV protection is required

Catalog Number	UPC Number	Description	Order Unit	Order Qty	Unit Pkg	Units/Case	TL Case Qty	Min Order Qty	MM Req	Ship Wt (Lbs)
<b>T5 HD Series 4-Foot</b>										
17206	17206	Clear UV Filtering: with "Vented" Green End Caps	EA	24	BX	0	0	24	Yes	4
<b>T8 4-Foot</b>										
17201	17201	Clear UV Filtering: with Green End Caps	EA	24	BX	0	0	24	Yes	7
<b>T8 8-Foot</b>										
17202	17202	Clear UV Filtering: with Green End Caps	EA	24	BX	0	0	24	Yes	12
<b>T12 4-Foot</b>										
17203	17203	Clear UV Filtering: with Green End Caps	EA	24	BX	0	0	24	Yes	8
<b>T12 8-Foot</b>										
17204	17204	Clear UV Filtering: with Green End Caps	EA	24	BX	0	0	24	Yes	15

**Note:** 1. UV Filtering Tube Guards are sold ONLY in case quantities of 24 per Carton. EPCO will not break case carton quantities.

2. UV Filtering Tube Guards are not to be used with HO or VHO Lamps! The exception is the UV Filtering T5 HD Series Tube Guard that is rated for use with a T5 HO Lamp.

## UV FILTERING TUBE GUARD END CAPS (GREEN)

Catalog Number	UPC Number	Description	Order Unit	Order Qty	Unit Pkg	Units/Case	TL Case Qty	Min Order Qty	MM Req	Ship Wt (Lbs)
17303	17303	End Caps: for T5 HD Series, "Vented"	EA	48	BG	0	0	48	Yes	1
17300	17300	End Caps: for T8	EA	48	BG	0	0	48	Yes	1
17301	17301	End Caps: for T12	EA	48	BG	0	0	48	Yes	1

**Note:** End Caps for T5, T8 and T12 Tube Guards fit inside the Tube Guard.

### UNITS OF MEASURE KEY

Order Unit: The Unit to be ordered; Order Qty: Number of pieces in each Unit; Unit Pkg: Packaging types - BG (Bag), BX (Box), BN (Bulk); Units/Case: Unit packages contained in the Case; TL Case Qty: The total number of items in each Master Case; Min Order Qty: The smallest Unit that can be ordered; MM Req: Must order multiples of the Unit in the stated quantities; Ship Wt (Lbs): Total weight of the units per carton



Specifications subject to change without prior notice.

 EPCO UV Filtering Tube Guards are Made in the USA. Complies with the American Recovery and Reinvestment Act – Buy American Provision.

## HEAT SINK

Engineered Products Company recommends the use of Heat Sink with all of its Tube Guards to aid in controlling heat that is generated by the fluorescent lamp. The primary function of our Heat Sink is to distribute heat and lower the temperatures of the fluorescent lamp over a larger area at each end of the Tube Guard.

The Heat Sink is available in sizes specific to the T5 HD Series Tube Guard, as well as the T8 and T12 Tube Guards.

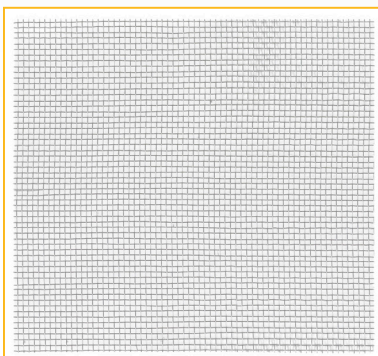

T5 HD SERIES HEAT SINK

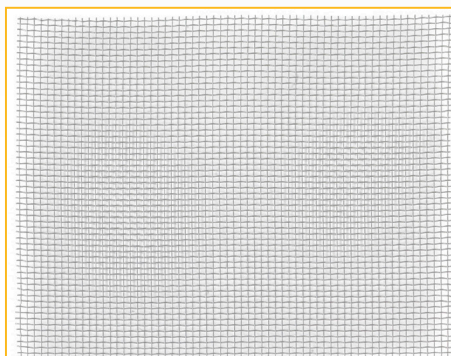

T8 HEAT SINK

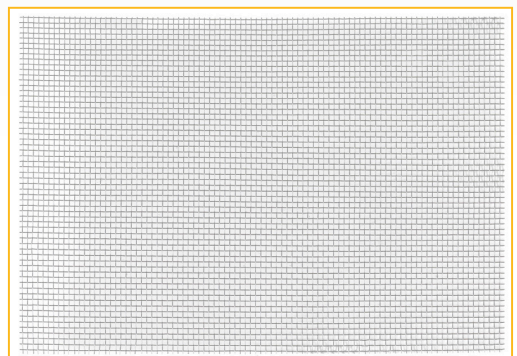

T12 HEAT SINK

Catalog Number	UPC Number	Description	Order Unit	Order Qty	Unit Pkg	Units/Case	TL Case Qty	Min Order Qty	MM Req	Ship Wt (Lbs)
17893	17893	Heat Sink: for T5 HD Series Tube Guards	EA	2	BG	0	0	2	Yes	1
17800	17800	Heat Sink: for T8 Tube Guards	EA	2	BG	0	0	2	Yes	1
17860	17860	Heat Sink: for T12 Tube Guards	EA	2	BG	0	0	2	Yes	1

**Note:** Heat Sinks are not for use with VHO Fluorescent Lamps.

**UNITS OF MEASURE KEY** Order Unit: The Unit to be ordered; Unit Qty: Number of pieces in each Unit; Unit Pkg: Unit Packages contained in the case - Packaging types - BG (Bag), BRL (Barrel), BX (Box), BN (Bulk), PKG (Package), EA (Each), RL (Roll), LB (Pound), C (Hundred), M (Thousand); Units/Case: Unit packages contained in the Case; TL Case Qty: The total number of items in each Master Case; Min Order Qty: The smallest Unit that can be ordered; MM Req: Must order multiples of the Unit in the stated quantities; Ship Wt (Lbs): Total weight of the units per Carton

# TUBE GUARDS

## Engineered Product Company (EPCO) Standard and UV Filtering Tube Guards Comply with the following Regulations:

### FDA Plant Construction and Design ... 110.20 Section B, Part 5

(5) Provide adequate lighting in hand-washing areas, dressing and locker rooms, and toilet rooms and in all areas where food is examined, processed, or stored and where equipment or utensils are cleaned; and provide safety-type light bulbs, fixtures, skylights, or other glass suspended over exposed food in any step of preparation or otherwise protect against food contamination in case of glass breakage.

### FDA Food Code Chapter 6, Section 202.11

"Shielding of light bulbs helps prevent breakage. Light bulbs that are shielded, coated, or otherwise shatter resistant are necessary to protect exposed food, clean equipment, utensils and linens, and unwrapped single-service and single-use articles from glass fragments should the bulb break."

## ⚠ WARNING

1. It is safe to use EPCO T5, T8, or T12 Tube Guards only in conjunction with electronic high efficiency ballasts designed to prevent an over-current condition to these fluorescent lamps during use and at the lamp's "end of life" (EOL).
2. We strongly recommend using EPCO Heat Sink with all T5, T8, or T12 Tube Guards.
  - T5 HD Series Heat Sink: Part Number 17893
  - T8 Heat Sink: Part Number 17800
  - T12 Heat Sink: Part Number 17860
3. The Installer must ensure the electrode bi-pin base end on the T5, T8, or T12 fluorescent lamps are firmly "placed, rotated a ¼ turn, and fully seated" in the luminaire's lamp holder for maximum lamp retention.

Note: After the fluorescent lamp is installed, there should no gap between the electrode bi-pin base end on the fluorescent lamp and the luminaire's lamp holder. A gap between the electrode bi-pin base on the fluorescent lamp and luminaire's lamp holder can create an "arcing" condition and cause a potential fire.
4. Do not misalign the electrode bi-pin base end on the fluorescent lamp and the luminaire's lamp holder! Misalignment causes a poor electrical connection and subsequent "voltage drop" between the lamp holder contacts and the bi-pins of the lamp sufficient to cause an "arcing" condition that can start a fire.
5. EPCO does not recommend using its T5, T8 and T12 Tube Guards under any conditions where the surface temperature of the fluorescent lamp can or will exceed 225°F (107°C) or in "any" enclosed luminaire where normal venting is not available.
6. EPCO T5, T8, or T12 Tube Guards must not be used with any lighting system that includes dimming capability where power surges or voltage spikes can cause "arcing" or over-current condition to the lamps.
7. We strongly recommend changing lamp(s) whenever there is "blackening" at the electrode bi-pin base end on the fluorescent lamp.

Distributed by:

Specifications subject to change without prior notice.

E02-041-002 I1 (10/15-SP)  
©2015 Engineered Products Company. All Rights Reserved.

[www.engproducts.com](http://www.engproducts.com)

5401 SMETANA DRIVE | MINNETONKA, MN 55343

P 800.336.1976 | F 800.336.2801



Made in the USA. Complies with the American Recovery and Reinvestment Act – Buy American Provision.



**ENGINEERED  
PRODUCTS CO.**

# TUBE GUARDS

## STANDARD TUBE GUARDS

The Standard Tube Guard is a light stabilized polycarbonate and has 0% transmittance below 365 nanometers (Clear Tube Guards only). Available Colors: Clear, Amber, Red, Green, Yellow and Blue. Available Sizes: T5, T8, and T12.

- An efficient economical solution where fluorescent lamp breakage would be hazardous to personnel, product, equipment or animals.
- Slip over fluorescent lamps to retain shattered glass and control the release of mercury vapor and phosphorescent material.
- Constructed of unbreakable lexan polycarbonate.
- "Cut-to-order" custom lengths are also available.

## T5 HD SERIES TUBE GUARDS

Using T5 lamps is a cost-effective lighting systems solution for a variety of reasons. Unfortunately the average T5 lamp will dissipate about 73% of its total lamp power as heat. And when this lamp is used in combination with a tube guard, that heat must be properly dissipated from the lamp.

Our T5 HD (Heat Dissipation) Series Tube Guard takes into consideration two major factors; the temperature on the inside of the tube guard, and how close the T5 lamp is actually located to the tube guard.

- Our T5 HD Series Tube Guard's larger diameter and its "vented" End Caps allow a layer of air to absorb heat from the lamp and cool it before making contact with the inside wall of the tube guard. This results in a 25°F temperature drop.\*
- The larger diameter of the T5 HD Series Tube Guard allows it to accommodate Heat Sink to control and distribute heat, in addition to lowering the temperatures over a larger area on the end of the tube guard.

**Note:** We strongly recommend using Heat Sink with our T5 HD Series Tube Guards. Part Numbers 17185 and 17186 arrive with the Heat Sink built into the Tube Guard. See photo to the right below.

- The combination of the T5 HD Series Tube Guard, "vented" End Caps, and Heat Sink lower the inside temperature of the tube guard approximately 30°F.\*\*
- Together, these components provide a unique operational advantage over other competitors T5 tube guards and still fits all T5 lamp applications.

TEMPERATURE TESTING	
CONFIGURATION	TEMPERATURE*
Competitors T5 Tube Guard	215°F
T5 HD Series Tube Guard and "Vented" End Caps	190°F*
T5 HD Series Tube Guard, "Vented" End Caps and Heat Sink	185°F**

\***Note:** The temperature is measured on the inside surface of the Tube Guard. The ambient testing temperature was 72°F using a T5 F54 HO Lamp.

### Fast, Efficient and Repeatable Results

EPCO always recommends using "Heat Sink Screens" when installing T5 HD Series Tube Guards. Heat sink helps distribute excessive heat on both ends of the fluorescent lamp. But when installing a large number of tube guards and heat sink screen combinations, time is money.

High volume installers can now reduce their installation time by using our T5 HD Series Tube Guard with "pre-installed" Heat Sink. In addition to saving time and money, EPCO's T5 HD Series Tube Guard with "pre-installed" Heat Sink provide a convenient and economical solution to expedite the installation by eliminating the process of having the contractor pre-roll two Heat Sinks (per tube guard).

Simply insert the lamp into the T5 HD Series Tube Guard, insert the "vented" end cap on each end of the tube guard and install the "tubed" lamp into the fixture.

[www.engproducts.com](http://www.engproducts.com)

5401 SMETANA DRIVE | MINNETONKA, MN 55343

P 800.336.1976 | F 800.336.2801

 Made in the USA. Complies with the American Recovery and Reinvestment Act – Buy American Provision.



STANDARD TUBE GUARDS

### TYPICAL APPLICATIONS:

- Food Processing Facilities
- Commercial Kitchens
- Grocery Stores
- Laundries
- Industrial Facilities
- Saunas
- Car Washes
- Storage Buildings
- Pedestrian and Road Tunnels
- Parking Garages
- Elevator Shafts
- Refrigerators and Freezers
- Locker Rooms
- And more...



**Note:** T5 HD Series Tube Guards, Part Numbers 17185 and 17186, are bundled with the T5 HD Heat Sink built into the Tube Guard as shown above.

# TUBE GUARDS

## EPCO's YELLOW TUBE GUARDS - How do they work?

Insects and humans have different visual perceptions. Light sources that radiate ultraviolet energy and blue light are most attractive to insects. Light sources that insects have a difficult time seeing are "yellow" hues in the color spectrum. EPCO's yellow tube guards do not repel insects! Using these tube guards will simply minimize the number of insects.

## TYPICAL APPLICATIONS

- Commercial businesses that maintain night-time operations such as gas stations, fast food restaurants, etc.
- Commercial food preparation and serving areas
- Parking lots loading areas
- Airport, Train and Bus Stations
- Building entrances
- Decks and patios



## STANDARD AND UV FILTERING TUBE GUARD DIMENSIONS

T5 HD SERIES TUBE GUARDS		
DIM. "A"	DIM. "B"	NOMINAL LENGTH
44.68	45.27	4'

T8 TUBE GUARDS		
DIM. "A"	DIM. "B"	NOMINAL LENGTH
46.38	47.10	4'
68.38	69.10	6'
92.38	93.10	8'

T12 TUBE GUARDS		
DIM. "A"	DIM. "B"	NOMINAL LENGTH
45.97	47.10	4'
67.97	69.10	6'
91.97	93.10	8'

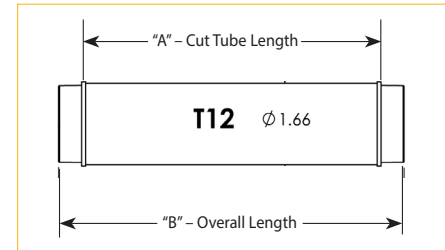
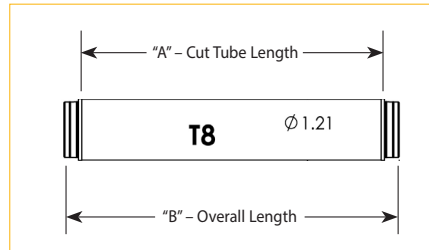
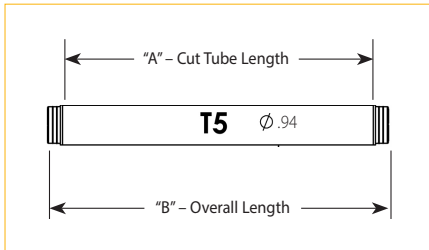

**Note:** Dimension "B" includes End Caps.

## STANDARD TUBE GUARD END CAPS (BLACK)

Catalog Number	UPC Number	Description	Order Unit	Order Qty	Unit Pkg	Units/ Case	TL Case Qty	Min Order Qty	MM Req	Ship Wt (Lbs)
17103	17103	End Caps: for T5 HD Series, "Vented"	EA	48	BG	0	0	48	Yes	1
17100	17100	End Caps: for T8	EA	48	BG	0	0	48	Yes	1
17101	17101	End Caps: for T12	EA	48	BG	0	0	48	Yes	1

**Note:** End Caps for T5 HD Series, T8 and T12 Tube Guards fit inside the Tube Guard.



### UNITS OF MEASURE KEY

**Order Unit:** The Unit to be ordered; **Order Qty:** Number of pieces in each Unit; **Unit Pkg:** Packaging types - BG (Bag), BX (Box), BN (Bulk); **Units/Case:** Unit packages contained in the Case; **TL Case Qty:** The total number of items in each Master Case; **Min Order Qty:** The smallest Unit that can be ordered; **MM Req:** Must order multiples of the Unit in the stated quantities; **Ship Wt (Lbs):** Total weight of the units per carton

 EPCO Standard Tube Guards are Made in the USA.  
Complies with the American Recovery and Reinvestment Act – Buy American Provision.

Specifications subject to change without prior notice.



## STANDARD TUBE GUARDS

Catalog Number	UPC Number	Description	Order Unit	Unit Qty	Unit Pkg	Units/Case	TL Case Qty	Min Order Qty	MM Req	Ship Wt (Lbs)
<b>4-FT T5 HD Series Tube Guard</b>										
17183*	17183	Clear Polycarbonate: with "Vented" Black End Caps	EA	1	BX	48	48	48	Yes	6
17184*	17184	Clear Polycarbonate: with "Vented" Black End Caps	EA	1	BX	120	120	120	Yes	16
17194†	17194	Amber Polycarbonate: with "Vented" Black End Caps	EA	1	BX	24	24	24	Yes	4
17195†	17195	Red Polycarbonate: with "Vented" Black End Caps	EA	1	BX	24	24	24	Yes	4
17196†	17196	Green Polycarbonate: with "Vented" Black End Caps	EA	1	BX	24	24	24	Yes	4
17197†	17197	Blue Polycarbonate: with "Vented" Black End Caps	EA	1	BX	24	24	24	Yes	4
17199†	17199	Yellow Polycarbonate: with "Vented" Black End Caps	EA	1	BX	24	24	24	Yes	4
<b>4-FT T5 HD Series Tube Guard with Built-In Heat Sink</b>										
17185**	17185	Clear Polycarbonate: with "Vented" Black End Caps and built-in Heat Sink	EA	1	BX	48	48	48	Yes	7
17186**	17186	Clear Polycarbonate: with "Vented" Black End Caps and built-in Heat Sink	EA	1	BX	120	120	120	Yes	17
<b>4-FT T8 Tube Guard</b>										
17000	17000	Clear Polycarbonate: with Black End Caps	EA	1	BX	24	24	24	Yes	6
17005	17005	Amber Polycarbonate: with Black End Caps	EA	1	BX	24	24	24	Yes	6
17010	17010	Red Polycarbonate: with Black End Caps	EA	1	BX	24	24	24	Yes	6
17015	17015	Green Polycarbonate: with Black End Caps	EA	1	BX	24	24	24	Yes	6
17020	17020	Blue Polycarbonate: with Black End Caps	EA	1	BX	24	24	24	Yes	6
17025	17025	Yellow Polycarbonate: with Black End Caps	EA	1	BX	24	24	24	Yes	6
<b>6-FT T8 Tube Guard</b>										
17050	17050	Clear Polycarbonate: with Black End Caps	EA	1	BX	24	24	24	Yes	8
<b>8-FT T8 Tube Guard</b>										
17030	17030	Clear Polycarbonate: with Black End Caps	EA	1	BX	24	24	24	Yes	10
17031	17031	Amber Polycarbonate: with Black End Caps	EA	1	BX	24	24	24	Yes	10
17032	17032	Red Polycarbonate: with Black End Caps	EA	1	BX	24	24	24	Yes	10
17033	17033	Green Polycarbonate: with Black End Caps	EA	1	BX	24	24	24	Yes	10
17034	17034	Blue Polycarbonate: with Black End Caps	EA	1	BX	24	24	24	Yes	10
17035	17035	Yellow Polycarbonate: with Black End Caps	EA	1	BX	24	24	24	Yes	10
<b>4-FT T12 Tube Guard</b>										
17060	17060	Clear Polycarbonate: with Black End Caps	EA	1	BX	24	24	24	Yes	7
<b>6-FT T12 Tube Guard</b>										
17040	17040	Clear Polycarbonate: with Black End Caps	EA	1	BX	24	24	24	Yes	10
<b>8-FT T12 Tube Guard</b>										
17090	17090	Clear Polycarbonate: with Black End Caps	EA	1	BX	24	24	24	Yes	10

- Note:** \*1. Standard Tube Guards are sold ONLY in case quantities of 24 per Carton. We will not break case carton quantities!  
The exception is the T5 HD Series - Clear, which is available in carton quantities of 48 and 120 Units (P/Ns: 17183, 17184, 17185 and 17186).
- \*\*2. T5 HD Series Tube Guards, Part Numbers 17185 and 17186 include the built-in T5 HD Heat Sink.
- †3. Indicates long lead time. Contact our Inside Sales Department (800.336.1976 or sales@engproducts.com) for more information.
4. Standard Tube Guards are not intended for use with HO or VHO Lamps! The exception is the T5 HD Series Tube Guard that is rated for use with a T5 HO Lamp.
5. Tube Guards, other than sizes and colors listed, can be special ordered. Contact our Inside Sales Department (800.336.1976 or sales@engproducts.com) for more information.



EPCO Standard Tube Guards are Made in the USA.  
Complies with the American Recovery and Reinvestment Act – Buy American Provision.

Specifications subject to change without prior notice.

**UNITS OF MEASURE KEY** Order Unit: The Unit to be ordered; Unit Qty: Number of pieces in each Unit; Unit Pkg: Unit Packages contained in the case - Packaging types - BG (Bag), BRL (Barrel), BX (Box), BN (Bulk), PKG (Package), EA (Each), RL (Roll), LB (Pound), C (Hundred), M (Thousand); Units/Case: Unit packages contained in the Case; TL Case Qty: The total number of items in each Master Case; Min Order Qty: The smallest Unit that can be ordered; MM Req: Must order multiples of the Unit in the stated quantities; Ship Wt (Lbs): Total weight of the units per Carton

# TUBE GUARDS

## UV FILTERING TUBE GUARDS

- EPCO's UV Filtering Tube Guards provide the basic reduction of harmful UV energy by filtering 99.9% of harmful UV rays up to 390 nanometers.\*
- Manufactured using thin-wall high tensile and impact resistant polycarbonate material that is flexible to hold the lamp to facilitate lamp changes; does not easily crack.
- Special UV additive filters UV rays better than acrylic materials with comparable wall thickness (0.016" wall thickness).
- Minimizes premature color shifting (fading) and deterioration that can be detrimental to food products, paper, natural and synthetic textiles, paints, coatings, wood and polymer materials, inc.
- Provides years of protection from dangerous UV light.
- Can readily be "field-cut" to length if desired.
- Manufactured to the highest quality standards.
- Sizes: T5, T8, and T12.
- Available in nominal 4-foot and 8-foot lengths.

**\*Note:** Tested by two independent light testing laboratories.



UV FILTERING TUBE GUARDS

### TYPICAL APPLICATIONS:

- Food Service
- Commercial Kitchens
- Photography Studios
- Grocery Stores
- Fabric Stores
- Movie Theaters
- Book Stores
- Libraries
- Furniture Stores
- Warehouses
- Special lighting applications where UV protection is required

Catalog Number	UPC Number	Description	Order Unit	Order Qty	Unit Pkg	Units/Case	TL Case Qty	Min Order Qty	MM Req	Ship Wt (Lbs)
<b>T5 HD Series 4-Foot</b>										
17206	17206	Clear UV Filtering: with "Vented" Green End Caps	EA	24	BX	0	0	24	Yes	4
<b>T8 4-Foot</b>										
17201	17201	Clear UV Filtering: with Green End Caps	EA	24	BX	0	0	24	Yes	7
<b>T8 8-Foot</b>										
17202	17202	Clear UV Filtering: with Green End Caps	EA	24	BX	0	0	24	Yes	12
<b>T12 4-Foot</b>										
17203	17203	Clear UV Filtering: with Green End Caps	EA	24	BX	0	0	24	Yes	8
<b>T12 8-Foot</b>										
17204	17204	Clear UV Filtering: with Green End Caps	EA	24	BX	0	0	24	Yes	15

**Note:** 1. UV Filtering Tube Guards are sold ONLY in case quantities of 24 per Carton. EPCO will not break case carton quantities.

2. UV Filtering Tube Guards are not to be used with HO or VHO Lamps! The exception is the UV Filtering T5 HD Series Tube Guard that is rated for use with a T5 HO Lamp.

## UV FILTERING TUBE GUARD END CAPS (GREEN)

Catalog Number	UPC Number	Description	Order Unit	Order Qty	Unit Pkg	Units/Case	TL Case Qty	Min Order Qty	MM Req	Ship Wt (Lbs)
17303	17303	End Caps: for T5 HD Series, "Vented"	EA	48	BG	0	0	48	Yes	1
17300	17300	End Caps: for T8	EA	48	BG	0	0	48	Yes	1
17301	17301	End Caps: for T12	EA	48	BG	0	0	48	Yes	1

**Note:** End Caps for T5, T8 and T12 Tube Guards fit inside the Tube Guard.

### UNITS OF MEASURE KEY

Order Unit: The Unit to be ordered; Order Qty: Number of pieces in each Unit; Unit Pkg: Packaging types - BG (Bag), BX (Box), BN (Bulk); Units/Case: Unit packages contained in the Case; TL Case Qty: The total number of items in each Master Case; Min Order Qty: The smallest Unit that can be ordered; MM Req: Must order multiples of the Unit in the stated quantities; Ship Wt (Lbs): Total weight of the units per carton



Specifications subject to change without prior notice.

 EPCO UV Filtering Tube Guards are Made in the USA. Complies with the American Recovery and Reinvestment Act – Buy American Provision.

## HEAT SINK

Engineered Products Company recommends the use of Heat Sink with all of its Tube Guards to aid in controlling heat that is generated by the fluorescent lamp. The primary function of our Heat Sink is to distribute heat and lower the temperatures of the fluorescent lamp over a larger area at each end of the Tube Guard.

The Heat Sink is available in sizes specific to the T5 HD Series Tube Guard, as well as the T8 and T12 Tube Guards.

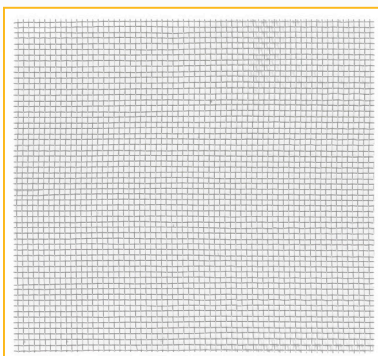

T5 HD SERIES HEAT SINK

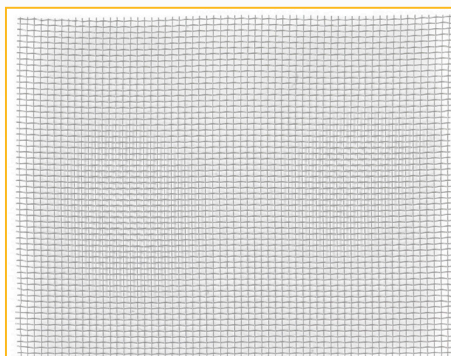

T8 HEAT SINK

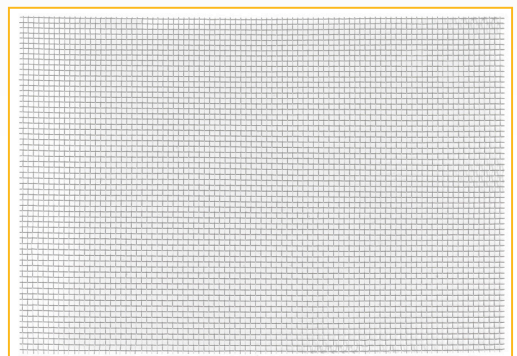

T12 HEAT SINK

Catalog Number	UPC Number	Description	Order Unit	Order Qty	Unit Pkg	Units/Case	TL Case Qty	Min Order Qty	MM Req	Ship Wt (Lbs)
17893	17893	Heat Sink: for T5 HD Series Tube Guards	EA	2	BG	0	0	2	Yes	1
17800	17800	Heat Sink: for T8 Tube Guards	EA	2	BG	0	0	2	Yes	1
17860	17860	Heat Sink: for T12 Tube Guards	EA	2	BG	0	0	2	Yes	1

**Note:** Heat Sinks are not for use with VHO Fluorescent Lamps.

**UNITS OF MEASURE KEY** Order Unit: The Unit to be ordered; Unit Qty: Number of pieces in each Unit; Unit Pkg: Unit Packages contained in the case - Packaging types - BG (Bag), BRL (Barrel), BX (Box), BN (Bulk), PKG (Package), EA (Each), RL (Roll), LB (Pound), C (Hundred), M (Thousand); Units/Case: Unit packages contained in the Case; TL Case Qty: The total number of items in each Master Case; Min Order Qty: The smallest Unit that can be ordered; MM Req: Must order multiples of the Unit in the stated quantities; Ship Wt (Lbs): Total weight of the units per Carton

# TUBE GUARDS

## Engineered Product Company (EPCO) Standard and UV Filtering Tube Guards Comply with the following Regulations:

### FDA Plant Construction and Design ... 110.20 Section B, Part 5

(5) Provide adequate lighting in hand-washing areas, dressing and locker rooms, and toilet rooms and in all areas where food is examined, processed, or stored and where equipment or utensils are cleaned; and provide safety-type light bulbs, fixtures, skylights, or other glass suspended over exposed food in any step of preparation or otherwise protect against food contamination in case of glass breakage.

### FDA Food Code Chapter 6, Section 202.11

"Shielding of light bulbs helps prevent breakage. Light bulbs that are shielded, coated, or otherwise shatter resistant are necessary to protect exposed food, clean equipment, utensils and linens, and unwrapped single-service and single-use articles from glass fragments should the bulb break."

## ⚠ WARNING

1. It is safe to use EPCO T5, T8, or T12 Tube Guards only in conjunction with electronic high efficiency ballasts designed to prevent an over-current condition to these fluorescent lamps during use and at the lamp's "end of life" (EOL).
2. We strongly recommend using EPCO Heat Sink with all T5, T8, or T12 Tube Guards.
  - T5 HD Series Heat Sink: Part Number 17893
  - T8 Heat Sink: Part Number 17800
  - T12 Heat Sink: Part Number 17860
3. The Installer must ensure the electrode bi-pin base end on the T5, T8, or T12 fluorescent lamps are firmly "placed, rotated a ¼ turn, and fully seated" in the luminaire's lamp holder for maximum lamp retention.

Note: After the fluorescent lamp is installed, there should no gap between the electrode bi-pin base end on the fluorescent lamp and the luminaire's lamp holder. A gap between the electrode bi-pin base on the fluorescent lamp and luminaire's lamp holder can create an "arcing" condition and cause a potential fire.
4. Do not misalign the electrode bi-pin base end on the fluorescent lamp and the luminaire's lamp holder! Misalignment causes a poor electrical connection and subsequent "voltage drop" between the lamp holder contacts and the bi-pins of the lamp sufficient to cause an "arcing" condition that can start a fire.
5. EPCO does not recommend using its T5, T8 and T12 Tube Guards under any conditions where the surface temperature of the fluorescent lamp can or will exceed 225°F (107°C) or in "any" enclosed luminaire where normal venting is not available.
6. EPCO T5, T8, or T12 Tube Guards must not be used with any lighting system that includes dimming capability where power surges or voltage spikes can cause "arcing" or over-current condition to the lamps.
7. We strongly recommend changing lamp(s) whenever there is "blackening" at the electrode bi-pin base end on the fluorescent lamp.

Distributed by:

Specifications subject to change without prior notice.

E02-041-002 I1 (10/15-SP)  
©2015 Engineered Products Company. All Rights Reserved.

[www.engproducts.com](http://www.engproducts.com)

5401 SMETANA DRIVE | MINNETONKA, MN 55343

P 800.336.1976 | F 800.336.2801



Made in the USA. Complies with the American Recovery and Reinvestment Act – Buy American Provision.



**ENGINEERED  
PRODUCTS CO.**