



24/7 Emergency Assistance Hotline
1-877-OSCAR99 (672-2799)



MANY ERICSON PRODUCTS ARE LISTED OR CERTIFIED.
FOR THE LATEST FULL SEARCHABLE LISTING BY PART NUMBER, GO TO: WWW.ERICSON.COM/AGENCY
Note: Products shown on this page may not be listed.



Ericson Manufacturing Company offers a wide variety of plugs and connectors to fit your needs.

PERMA-LINK®



- Two-screw cable clamp secures cord and provides superior strain-relief
- Withstand high impact, corrosion, oils, greases, solvents and other chemicals across -20 °C to + 100°C
- Individual wire pockets help prevent flashovers
- Rubberized outer housing for superior grip and impact resistance
- Flexibility of reverse-cover design creates weather-resistant connections by interchanging covers
- Internal cord seals keep out water/mud/dust
- Available in all black

PERMA-GRIP™



- Quick field assembly with cord grip nut
- Superior water/mud/dust resistance provided by safety compression cord grips
- Withstand high impact, corrosion, oils, greases, solvents and other chemicals across -20 °C to + 100°C
- Flexibility of reverse-cover design (straight blade devices) creates weather-resistant connections by interchanging covers
- Custom marking available on cord grip nut
- Available in all black

PERMA-TITE® 2



- Tongue & groove sealing system provides extreme environmental protection of:
 - NEMA Type 4, 4X, 6, 6P & IP67
- Devices resist high-pressure hose down of 1,500 psi.
- Withstand high impact, corrosion, oils, greases, solvents and other chemicals across -20 °C to + 100°C
- Removable/replaceable self-retained sealing cap provided with connector to keep out contaminants when not in use (plug cap also available)
- Custom marking available on cord grip nut
- Available in all black

50 Amp Devices



- Rugged nylon construction resists impact, corrosion and jobsite oils/chemicals
- Quick field assembly, with color coded markings
- Nickel plated blades and stainless steel screws provide optimum corrosion resistance
- Boots can be threaded together with the optional sealing collar system to provide maximum environmental protection
- Available in plugs, connectors, inlets and receptacles
- Rubberized grey "Twist-Grip" for ease of connection

Commercial Grade

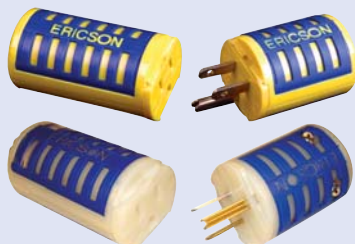

- Translucent body allows device to glow from power on lamp (EL Models)
- Wide open "suitcase" style construction makes wiring easy
- Fits 10/3 to 18/3 cord diameters
- Rugged design withstands abuse on the jobsite
- Color coded termination screws for ground, hot and neutral
- Combo screw heads speed up installation
- Rubberized "grip" cushions and surrounds device
- Economy priced



SmartMonitor™



Features of All SmartMonitor™ Plugs & Connectors:

- Super bright 2-color LED technology
- SmartMonitor™ Module
- Easy to wire
- Clear internal wiring cover
- Multiple cord grommets included
- Makes OSHA safety compliance easy and cost effective

24/7 Monitoring of These 7 Events

- No Ground
- Loss of Ground In Cord
- Hot/Neutral Swap
- Reverse Polarity
- Hot on Ground
- Open Neutral

3 Styles to Pick From:

- Perma-Link®
- Perma-Grip™
- Perma-Tite® 2



Smart Cords



New From Ericson... Industrial application SmartCords factory built to last and last. Models with Smart Connector (Economy Safe) and both Smart Plug and connector are available. 24/7 monitoring with Assured Grounding Compliance to NEC and OSHA standards. Built with the highest quality materials to withstand your environment.

FS Series Single Receptacles & Male Inlets Under All Weather Flip Covers



- Weather resistant boot seals around Ericson Perma-Tite plug to provide weather resistant protection
- Spring-loaded flip-lid covers receptacle when not in use
- Includes cover plate, rubber boot, stainless steel mounting plate/mounting screws
- Impact, chemical & corrosion resistant construction stands up to demanding environments
- Mounts easily to 6200 or 6300 series FS/FD boxes and any flat surface
- Collar plug seals and grips all types of round plugs or connectors

Double Outlet Receptacle with Cover Plates - PWDX Series

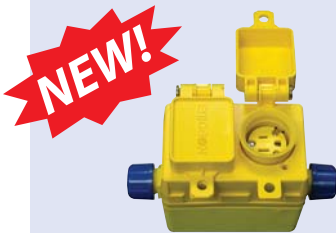

- Weather resistant boot seals around Ericson Perma-Tite plug to provide weather resistant protection
- Spring-loaded flip-lid covers the receptacle when not in use
- Two independent fully rated receptacles in one easy to install assembly
- Impact, chemical & corrosion resistant construction stands up to demanding environments
- Mounts easily to 6200 series FS/FD boxes and any flat surface

Adapters



NEMA Change Adapters

Now make quick, secure connections between straight-blade and locking plugs and connectors with Ericson's NEMA configuration adapters.

- Heavy-duty non-conducting housing and using heavy gauge solid brass blades
- Compact size makes them easy to use and transport
- Available in molded style or short cords



MANY ERICSON PRODUCTS ARE LISTED OR CERTIFIED.

FOR THE LATEST FULL SEARCHABLE LISTING BY PART NUMBER, GO TO: WWW.ERICSON.COM/AGENCY

Note: Products shown on this page may not be listed.



Ericson NEMA Chart

EXTREME









BEST



| Face View | NEMA | Electrical Ratings | | PERMA-TITE® 2 | | PERMA-GRIP™ | |
|-------------------------------------|---------------|--------------------|-------------------|---------------|------------|-------------|------------|
| | Configuration | Amps | Volts | Plugs | Connectors | Plugs | Connectors |
| 2-pole, 3-Wire Grounding | | | | | | | |
| | 5-15 | 15 | 125 | 1510-PW6P | 1610-CW6P | 1510-PG | 1610-CG |
| | 5-20 | 20 | 125 | 1512-PW6P | 1612-CW6P | 1512-PG | 1612-CG |
| | 6-15 | 15 | 250 | 1514-PW6P | 1614-CW6P | 1514-PG | 1614-CG |
| | 6-20 | 20 | 250 | 1516-PW6P | 1616-CW6P | 1516-PG | 1616-CG |
| | L5-15 | 15 | 125 | 1520-PW6P | 1620-CW6P | 1520-PG | 1620-CG |
| | L6-15 | 15 | 250 | 1522-PW6P | 1622-CW6P | 1522-PG | 1622-CG |
| | L7-15 | 15 | 277 | 1524-PW6P | 1624-CW6P | 1524-PG | 1624-CG |
| | L5-20 | 20 | 125 | 2310-PW6P | 2410-CW6P | 2310-PG | 2410-CG |
| | L6-20 | 20 | 250 | 2312-PW6P | 2412-CW6P | 2312-PG | 2412-CG |
| | L7-20 | 20 | 277 | 2314-PW6P | 2414-CW6P | 2314-PG | 2414-CG |
| 3-Pole, 3-Wire Non-Grounding | | | | | | | |
| | Non-NEMA | 20 | 125/250 | 2316-PW6P | 2416-CW6P | 2316-PG | 2416-CG |
| | Non-NEMA | 20/10 | 250/600 | 2317-PW6P | 2417-CW6P | 2317-PG | 2417-GC |
| | Non-NEMA | 15A/10A | 125V/250V | 1507-PW6P | 1607-CW6P | 1507-PG | 1607-CG |
| 3-Pole, 4-Wire Grounding | | | | | | | |
| | L14-20 | 20 | 125/250 | 2320-PW6P | 2420-CW6P | | |
| | L15-20 | 20 | 250, 3Ø | 2322-PW6P | 2422-CW6P | | |
| | L16-20 | 20 | 480, 3Ø | 2324-PW6P | 2424-CW6P | | |
| 2-Pole, 3-Wire Grounding | | | | | | | |
| | L5-30 | 30 | 125 | 2510-PW6P | 2610-CW6P | 2510-PG | 2610-CG |
| | L6-30 | 30 | 250 | 2512-PW6P | 2612-CW6P | 2512-PG | 2612-GC |
| | L7-30 | 30 | 277 | 2514-PW6P | 2614-CW6P | 2514-PG | 2614-CG |
| 3-Pole, 3-Wire Non-Grounding | | | | | | | |
| | Non-NEMA | 30 | 125/250 | 2516-PW6P | 2616-CW6P | | |
| 3-Pole, 4-Wire Grounding | | | | | | | |
| | L14-30 | 30 | 125/250 3Ø | 2520-PW6P | 2620-CW6P | | |
| | L15-30 | 30 | 250, 3Ø | 2522-PW6P | 2622-CW6P | | |
| | L16-30 | 30 | 480, 3Ø | 2524-PW6P | 2624-CW6P | | |
| | L17-30 | 30 | 600, 3Ø | 2526-PW6P | 2626-CW6P | | |
| 4-Pole, 4-Wire | | | | | | | |
| | L18-30 | 30 | 120/208 3Ø wye | 2530-PW6P | 2630-CW6P | | |
| 4-Pole, 4-Wire Non-Grounding | | | | | | | |
| | Non-NEMA | 30 | 120/208 3Ø wye | 2528-PW6P | 2628-CW6P | | |



| |  BETTER | |  GOOD | |  SMART | |  Single Outlet | |  Male Inlets |  Dual Recept (PWDX) |
|-------------------------------------|---|------------|---|------------|--|------------|---|------------|--|---|
| Face View | Plugs | Connectors | Plugs | Connectors | Plugs | Connectors | FS Cover Plates | | Receptacle with Cover | |
| 2-pole, 3-Wire Grounding | | | | | | | | | | |
| | 1510-P | 1610-C | 5266-E | 5269-E | 1510-PXX | 1610-CXX | 2715-FS10 | 2705-15/A | 1610-PWDX | |
| | 1512-P | 1612-C | | | 1512-PXX | 1612-CXX | 2715-FS12 | 2705-20/A | 1612-PWDX | |
| | 1514-P | 1614-C | Note: Lighted power-on glow models also: 5266-EL & 5269-EL | | | | 2715-FS14 | | 1614-PWDX | |
| | 1516-P | 1616-C | | | | | 2715-FS16 | | 1616-PWDX | |
| | 1520-P | 1620-C | | | | | 2715-FS20 | 2705-L15/A | 1620-PWDX | |
| | 1522-P | 1622-C | | | | | 2715-FS22 | | 1622-PWDX | |
| | 1524-P | 1624-C | | | | | 2715-FS24 | | 1624-PWDX | |
| | 2310-P | 2410-C | | | 2310-PXX | 2410-CXX | 2820-FS10 | 2705-L20 | 6200 Series Boxes For FS Series & PWDX Series <ul style="list-style-type: none"> • Rubberized • Fully Enclosed • Single and Double Sided • Standard and Deep  | |
| | 2312-P | 2412-C | | | | | 2820-FS12 | | | |
| | 2314-P | 2414-C | | | | | 2820-FS14 | | | |
| 3-Pole, 3-Wire Non-Grounding | | | | | | | | | | |
| | 2316-P | 2416-C | | | | | 2820-FS16 | | | |
| | 2317-P | 2417-C | | | | | 2820-FS17 | | | |
| | 1507-P | 1607-C | | | | | 2715-FS07 | | | |
| 3-Pole, 4-Wire Grounding | | | | | | | | | | |
| | 2320-P | 2420-C | | | | | 2920-FS20 | 2705-L142 | | |
| | 2322-P | 2422-C | | | | | 2920-FS22 | | | |
| | 2324-P | 2424-C | | | | | 2920-FS24 | 2705-L162 | | |
| 2-Pole, 3-Wire Grounding | | | | | | | | | | |
| | 2510-P | 2610-C | | | | | 2830-FS10 | | | |
| | 2512-P | 2612-C | | | | | 2830-FS12 | | | |
| | 2514-P | 2614-C | | | | | 2830-FS14 | | | |
| 3-Pole, 3-Wire Non-Grounding | | | | | | | | | | |
| | 2516-P | 2616-C | | | | | 2830-FS16 | | | |
| 3-Pole, 4-Wire Grounding | | | | | | | | | | |
| | 2520-P | 2620-C | | | | | 2930-FS20 | | | |
| | 2522-P | 2622-C | | | | | 2930-FS22 | | | |
| | 2524-P | 2624-C | | | | | 2930-FS24 | | | |
| | 2526-P | 2626-C | | | | | 2930-FS26 | | | |
| 4-Pole, 4-Wire | | | | | | | | | | |
| | 2530-P | 2630-C | | | | | 2930-FS30 | | | |
| 4-Pole, 4-Wire Non-Grounding | | | | | | | | | | |
| | 2528-P | 2628-C | | | | | 2930-FS28 | | | |

↑

***Part Number Note for Smart Monitors:**

PLUGS (-PXX)

PML
Perma-Link® Style

PMGL
Perma-Grip™ Style

PW6PL
Perma-Tite®2 Style

CONNECTORS (-CXX)

CML
Perma-Link® Style

CMGL
Perma-Grip™ Style

CW6PL
Perma-Tite®2 Style



MANY ERICSON PRODUCTS ARE LISTED OR CERTIFIED.
 FOR THE LATEST FULL SEARCHABLE LISTING BY PART NUMBER, GO TO: WWW.ERICSON.COM/AGENCY
 Note: Products shown on this page may not be listed.

SmartMonitor™ Series

SmartMonitor™ Plugs & Connectors Constantly Monitors These Conditions:

- No Ground • Loss of Ground In Cord • Hot/Neutral Swap • Reverse Polarity • Hot on Ground • Open Neutral

Features Of All SmartMonitor™ Plugs & Connectors:

- Super Bright LED Technology
- SmartMonitor™ Module
- Keyed body and cover
- Easy to wire
- Clear internal wiring cover
- Non-slip finger grips
- Color coded terminal screws
- Multiple cord grommets included
- Rubberized outer body
- Safety Yellow and Blue body

ERICSON EXCLUSIVE

"LIKE HAVING A METER IN EVERY PLUG..."

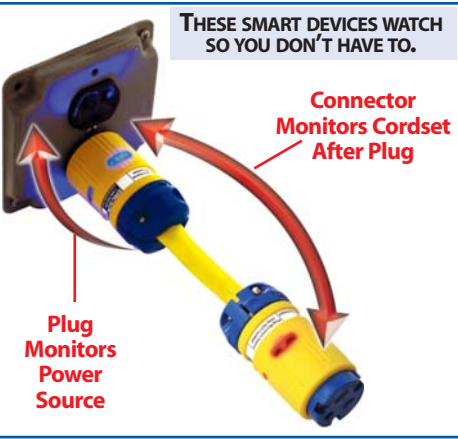
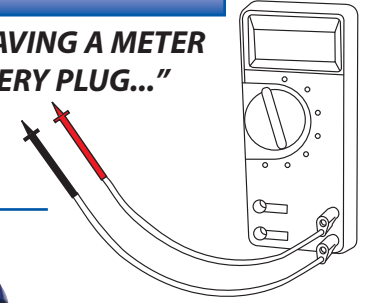

BLUE
OK TO USE



LEDs light up to let you know power is O.K.



24/7
Monitoring

- No Ground
- Loss of Ground In Cord
- Hot/Neutral Swap
- Reverse Polarity
- Hot on Ground
- Open Neutral

RED
STOP, CALL AN ELECTRICIAN!



LEDs light up to let you know there is a problem

How It Works - Diagnostic Safety Cords

Economy Safe Cords



- Cordset is OK to Use**
- Safety earth ground is OK
 - power polarity is OK

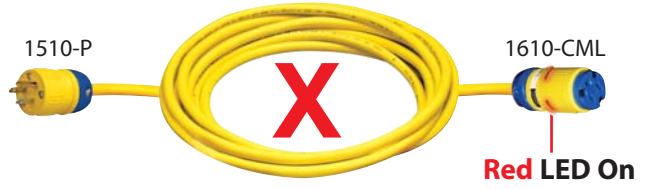

- Do Not Use**
- Check power source for proper wiring and ground
 - Check cord for cuts, nicks etc.
 - Check plug wiring
 - Check connector wiring

Full Diagnostic Safety Cords*



Do Not Use

- Source power is OK
- Check cord for cuts, nicks etc.
- Check connector wiring



- Do Not Use**
- Check power source for wiring or missing earth ground

* Full diagnostic safety cords give easy-to-understand indications which saves time tracking down electrical safety issues.

**This device does not diagnose any tool internal issues. This device is an indication that the power and safety earth ground are present.

Using SmartMonitor™ with Tool Cords

Blue OK to use tool**

Red STOP!

- Check power source for wiring or missing earth ground
- Check for miswired receptacle



Cord Clamp Style



Perma-Link™ Cord Clamp Style Features:

- Internal cord seal
- Dual screw self-centering clamp
- Rubberized outer body

XXXX-PML

Cord Grip Style



Perma-Grip™ Cord Grip Nut Style Features:

- Nickel plated solid brass blades
- Super sealing cord grip nut design



XXXX-PMGL

Water Tight Style



Perma-Tite2™ All Weather Cord Grip Nut Style features:

- All weather - NEMA 6P rated
- Super sealing rings
- Nickel plated solid brass blades
- Super sealing cord grip nut design
- Connector includes cover
- 360° indication

XXXX-CW6PL

Plug & Connector Selection Guide

| Face View | NEMA Configuration | Electrical Ratings | | Perma-Link® | | Perma-Grip® | | Perma-Tite® 2 | |
|---|--------------------|--------------------|-------|-------------|------------|-------------|------------|---------------|------------|
| | | Amps | Volts | Plugs | Connectors | Plugs | Connectors | Plugs | Connectors |
| Straight Blade, 2-pole, 3-wire Grounding Devices | | | | | | | | | |
| | 5-15 | 15 | 125 | 1510-PML | 1610-CML | 1510-PMGL | 1610-CMGL | 1510-PW6PL | 1610-CW6PL |
| | 5-20 | 20 | 125 | 1512-PML | 1612-CML | 1512-PMGL | 1612-CMGL | 1512-PW6PL | 1612-CW6PL |
| Locking, 2-pole, 3-wire Grounding | | | | | | | | | |
| | L5-20 | 20 | 125 | 2310-PML | 2410-CML | 2310-PMGL | 2410-CMGL | 2310PW6PL | 2410-CW6PL |
| | L5-15 | 15 | 125 | 1520-PML | 1620-CML | 1520-PMGL | 1620-CMGL | 1520-PW6PL | 1620-CW6PL |

New From Ericson... Industrial application SmartCords factory built to last and last. Models with Smart Connector (Economy Safe) and both Smart Plug and Connector are available. 24/7 monitoring with Assured Grounding Compliance to NEC and OSHA standards. Built with the highest quality materials to withstand your environment.



1510PML123A shown

Cord

Tough 600V rated SOW cordage for long lasting wear

SmartMonitor™ Connector

Checks entire cordset from the plug to the connector

Cordset Selection Guide

| Economy Safe SmartCords P/N* | Length | Non-smart PLUG | Smart Connector | Cord Size | Rating |
|--|--------------------------|----------------|-----------------|-----------|--------|
| 1610XXX143 | A = 25ft B= 50Ft D=100ft | 1510-__ | 1610-__L | #14/3 SOW | 15A |
| 1610XXX123 | | 1510-__ | 1610-__L | #12/3 SOW | 15A |
| 1612XXX123 | | 1510-__ | 1610-__L | #12/3 SOW | 20A |
| 2410XXX123 | | 2310-__ | 2410-__L | #12/3 SOW | 20A |
| Note: plug and connector type will be based on selection made of the master cordset part number - style will match | | | | | |
| Full Diagnostic Safety SmartCords P/N** | Length | Smart PLUG | Smart Connector | Cord Size | Rating |
| 1510XXX143 | A = 25ft B= 50Ft D=100ft | 1510-__L | 1610-__L | #14/3 SOW | 15A |
| 1510XXX123 | | 1510-__L | 1610-__L | #12/3 SOW | 15A |
| 1512XXX123 | | 1512-__L | 1610-__L | #12/3 SOW | 20A |
| 2310XXX123 | | 2310-__L | 2410-__L | #12/3 SOW | 20A |

Note: plug and connector type will be based on selection made of the master cordset part number

* Replace XXX with: (Economy Cordsets Only)

CML = PermaLink Style Light Industrial Wiring Devices (non-smart Plug and Smart Connector installed)

CMGL = PermaGrip Style Industrial Wiring Devices with nickel plated blades (non-smart Plug and Smart Connector installed)

CW6PL = PermaTite Style Industrial All-Weather Wiring Devices (non-smart Plug and Smart Connector installed)

** Replace XXX with: (Full Diag Cordsets Only)

PML = PermaLink Style Light Industrial Wiring Devices (Smart Plug and Smart Connector installed)

PMGL = PermaGrip Style Industrial Wiring Devices with nickel plated blades (Smart Plug and Smart Connector installed)

PW6PL = PermaTite Style Industrial All-Weather Wiring Devices (Smart Plug and Smart Connector installed)



MANY ERICSON PRODUCTS ARE LISTED OR CERTIFIED.

FOR THE LATEST FULL SEARCHABLE LISTING BY PART NUMBER, GO TO: WWW.ERICSON.COM/AGENCY

Note: Products shown on this page may not be listed.



Perma-Tite® 2 Devices - Extreme Conditions

PERMA-TITE® 2 Plugs and Connectors

Perma-Tite®2 plugs and connectors are engineered and manufactured to the highest quality standards to provide the ultimate in electrical service and protection. They are designed and proven to do their best under the worst conditions in a broad array of the most severe food processing, industrial, marine, construction and petro-chemical work environments.

- UL Listed & CSA Certified, some ETL Listed
- Tongue & groove sealing system provides environmental protection of:
 - NEMA Type 4, 4X, 6, 6P & IP67
- Devices resist high-pressure hose down of 1,500 psi.
- Plug & Connector bodies made with PBT chosen for its high resistance to moisture absorption, high voltage arcing and carbon tracking
- Keyed body and cover for easy alignment/assembly
- Color coded sealing bushings are provided to fit a variety of cord diameters
- Removable/replaceable self-retained sealing cap provided with connector to keep out contaminants when not in use
- Nickel plated blades for corrosion resistance
- Transparent back-plate makes for quick visual wiring checks
- Ericson's new brilliant Blue and Radiant Yellow High Visibility Dual Color Safety System symbolizes that legendary Ericson Quality



All Black Available

NEMA TYPE 4, 4X, 6, 6P & IP67

- Excels in demanding outdoor & in-plant environments
- Resists hose directed water, the entry of water during prolonged submersion at a limited depth & damage from external ice formation

Typical Applications

- Food processing
- Pulp and paper mills
- Refineries and Petro Chem Facilities
- Ship yards
- Utilities
- Marine



PERMA-TITE® 2

EXTRA GROMMETS Color coded rubber cord sealer grommets supplied for a variety of diameters.

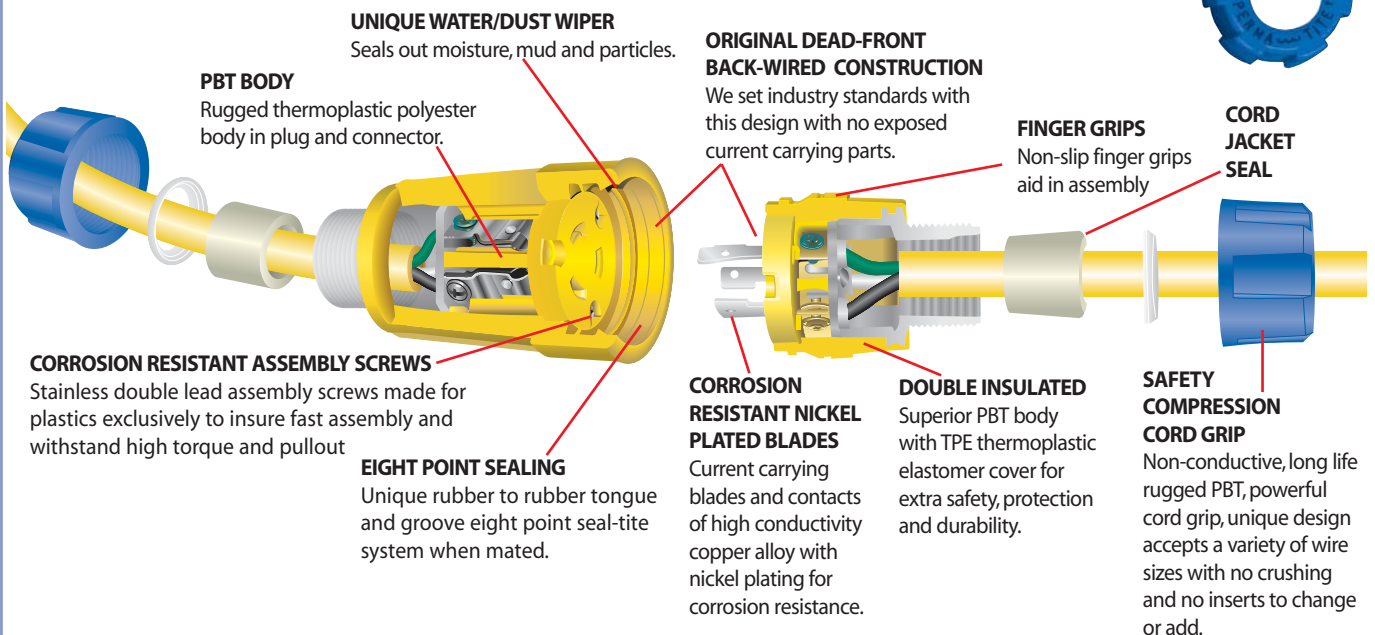

Note: Add - BLK for all black as available.



ERICSON EXCLUSIVE

PERMA-GRIP™ Plugs and Connectors

Ericson's industry exclusive design combines the Perma-Tite® cord grip with the industry proven design of its Perma-Link® devices to provide a line of **incredibly tough plugs and connectors** that stand up to the most demanding industrial and construction environments.

- UL Listed and CSA Certified, some ETL Listed
- Quick field assembly, no cable clamp screws to tighten, simply twist on the cord grip nut
- Water/mud/dust resistance provided by safety compression cord grips
- Keyed body and cover for easy alignment/assembly
- Color coded rubber cord-seal bushings accommodate a wide range of cable diameters
- Molded-in non-slip fingers grips makes devices easy to assemble and handle
- Withstand high impact, corrosion, oils, greases, solvents and other chemicals across -20 °C - +65 °C
- Nickel plated brass blades and ground pin stops corrosion and keeps solid electrical contact

- Individual wire pockets help prevent flashovers
- Transparent back plate speeds wiring inspection
- Selected models available with Ground Continuity Monitor
- Available individually or on factory assembled cord sets
- Flexibility of reverse-cover design (straight blade devices) creates weather-resistant connections by interchanging covers
- Ericson's exclusive Brilliant Blue and Radiant Yellow High Visibility Dual Color Safety System



Complete Kit as Shown

FEATURE

Safety Compression Cord Grip

Non-conductive, long life rugged PBT, powerful cord grip, unique design accepts all AWG wire range sizes from #18 through #12 with no crushing and no inserts to change or add

High-Visibility Safety Colors
Added safety in dull work areas With Brilliant Blue and Radiant Yellow colors.

Transparent Back Plate

Clear polycarbonate permits visual wiring inspection without disassembly

Keyed PBT Body

Adds to quick alignment and assembly.

Double Insulated

Superior PBT body with TPE thermoplastic elastomer cover for extra safety, protection and durability.

FEATURE!

Internal Cord Seal

Built-in cord entrance seal in cover seals out moisture and most foreign material that can cause short circuit.

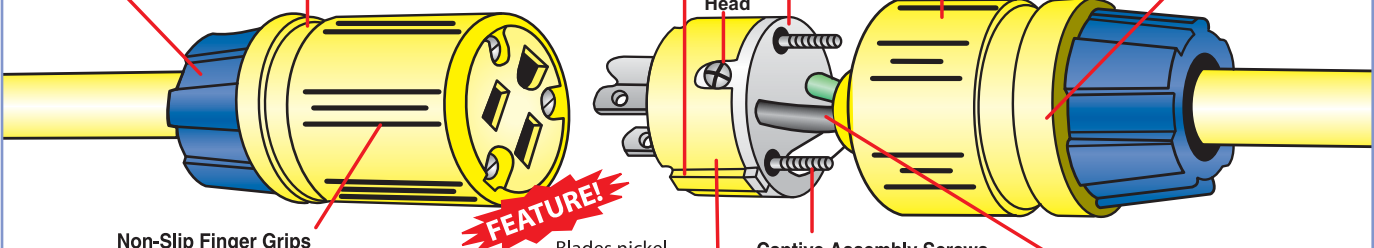

Non-Slip Finger Grips

FEATURE!

Blades nickel plated to prevent corrosion

Captive Assembly Screws

Double lead screws provide rigid assembly, no bulging of cover, maximum pull out resistance, fast assembly.

Individual Wire Chambers

Accepts up to #12 AWG conductors and prevents flash overs and short circuits.

EXTRA GROMMETS Color coded rubber cord sealer grommets supplied for a variety of diameters.



Dead-Front Back-Wired Design

We set industry standards with this design, no exposed current carrying parts, meets NEC article #410-56 (d).

Note: Add - BLK for all black as available.



MANY ERICSON PRODUCTS ARE LISTED OR CERTIFIED.

FOR THE LATEST FULL SEARCHABLE LISTING BY PART NUMBER, GO TO: WWW.ERICSON.COM/AGENCY

Note: Products shown on this page may not be listed.





PERMA-LINK® Plugs and Connectors

United States patent number 4,021,092 was assigned to today's Perma-Link® plugs and connectors which are classified among the most rugged and safest wiring devices available. They incorporate many of the same features as Ericson Perma-Tite® 2 and Perma-Grip™ devices and utilize a two-screw cable clamp. Perma-Link® plugs and connectors are designed to provide many years of trouble-free service in the most demanding industrial and construction environments.

- UL Listed and CSA Certified
- Two-screw cable clamp secures wire and provides strain-relief
- Solid brass blades for optimum electrical and mechanical performance
- Keyed body and cover for easy alignment/assembly
- Molded-in non-slip finger-grips makes devices easy to assemble and handle
- Withstand high impact, corrosion, oils, greases, solvents and other chemicals across -20 °C to 100 °C
- Individual wire pockets help prevent flashovers
- Transparent back plate speeds wiring inspection
- Selected models available with Ground Continuity Monitor
- Available individually or on factory assembled cord sets
- Flexibility of reverse-cover design creates weather-resistant connections by interchanging covers
- Ericson's exclusive Brilliant Blue and Radiant Yellow High Visibility Dual Color Safety System

All Black Available

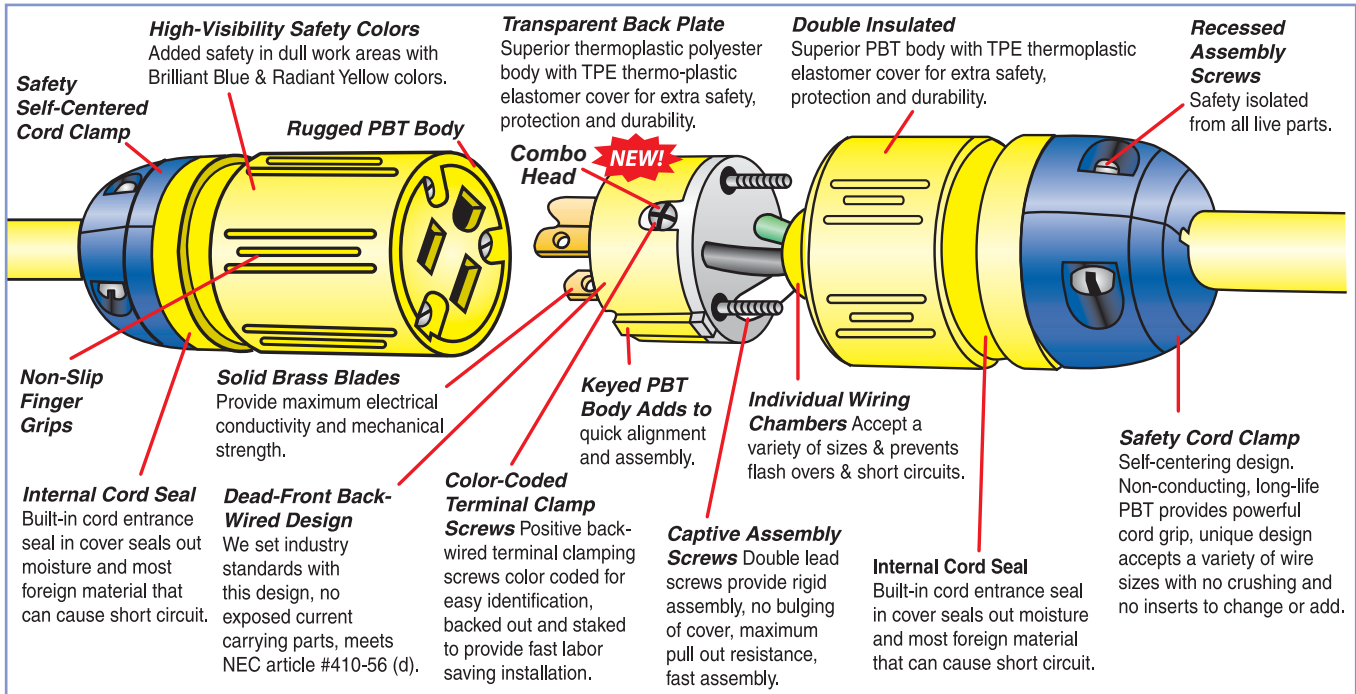
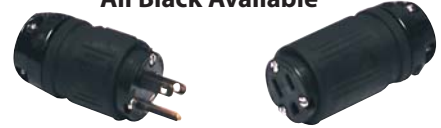

Note: Add - BLK for all black as available.



Versatile Weather-Resistant Field Conversion

Our Perma-Link® plugs and connectors (as listed below) are designed so they can easily be converted to create weather-resistant connections by interchanging the internal assemblies. Insert the plug body into the connector cover, and the connector body into the plug cover. There are no extra parts to purchase.

Step 1:

Disassemble The Plug & Connector As Shown

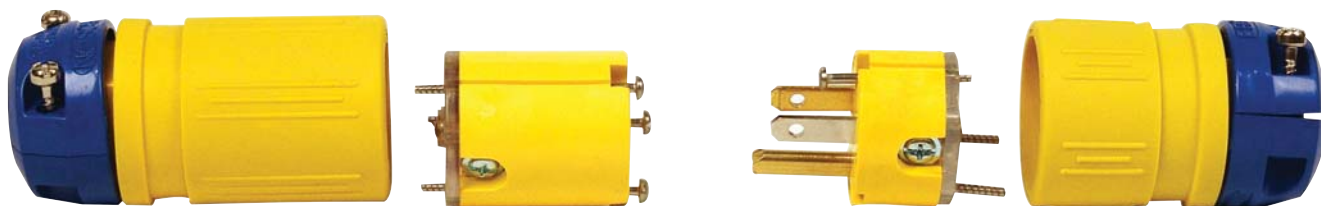

Step 2:

Swap Plug & Connector Assemblies

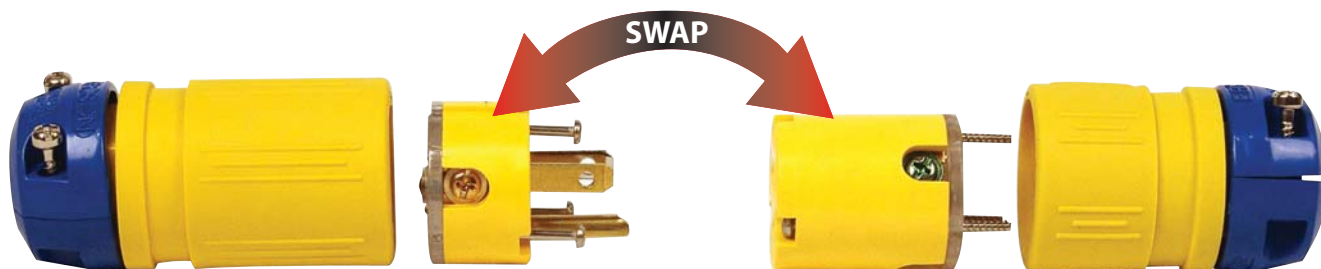

Step 3:

Assemble Cords Per Bag Instructions

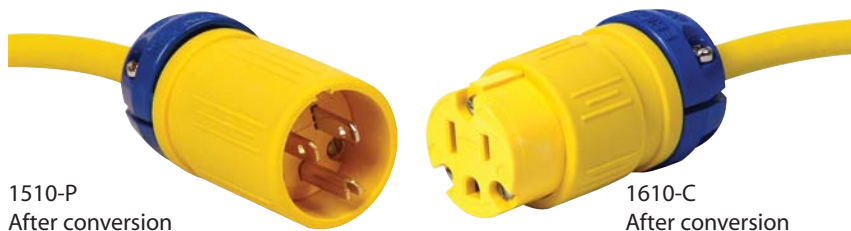

| Convertible Parts | |
|-------------------|--------|
| 1510-P | 1610-C |
| 1512-P | 1612-C |
| 1514-P | 1614-C |



“Crowsfoot” Devices - Non-NEMA

This Non-NEMA configuration, commonly called the “crowsfoot”, is widely used in critical applications that require equipment to be plugged into a specific electrical system to ensure proper function or to prevent equipment damage.

Typical Applications

- Low-voltage hand lamps and matching transformers
- Data acquisition/logging equipment to detect level and flow measurements on tanks and valves
- Sensitive electronic equipment that must be used on voltage regulated circuits

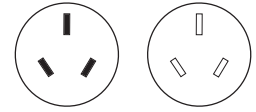

Features Guide

- Plug and connector bodies made with PBT chosen for its high resistance to moisture absorption, high voltage arcing and carbon tracking.
- Transparent back-plate makes for quick visual wiring checks.
- Keyed body and cover for easy alignment/assembly.
- Color-coded sealing bushings are provided to fit a variety of cord diameters.
- Perma-Tite® 2 devices have the eight-point rubber tongue and groove sealing system to provide environmental protection.
- Rubber sealing cap provided with Perma-Tite® 2 connector to keep out contaminants when not in use.
- Optional plug cover available - order catalog number 15PW.
- Ericson's exclusive Brilliant Blue and Radiant Yellow High Visibility Dual Color Safety System.
- Perma-Tite® 2 devices rated NEMA 4, 4X, 6, 6P & IP67.

PERMA-GRIP™ plug and connector with industry exclusive cord grip nut for rapid field assembly



1607-CG

1507-PG



1507-PW6P



1607-CW6P

Perma-Grip™ & Perma-Tite®2 plugs & connectors come with color coded rubber cord seal bushings for a variety of cable diameters.

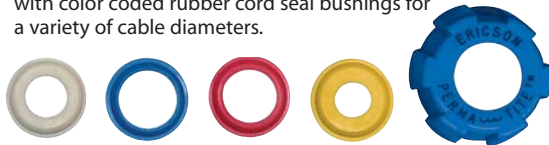

PERMA-TITE® 2 plug and connector

| Face View | NEMA Config. | Electrical Ratings | | Perma-Grip™ | | Perma-Tite® 2 | |
|-----------|--------------|--------------------|------|-------------|---------|---------------|-----------|
| | Non-NEMA | 15A | 125V | 1507-PG | 1607-CG | 1507-PW6P | 1607-CW6P |
| | | 10A | 250V | | | | |



Commercial Grade Plugs & Connectors

The Ericson 5266 and 5269 Series of Commercial Grade plugs offer the latest in design innovation and quality in an economy grade wiring device. The demands of today's electrical industry are met with this new design with features never before seen in a commercial device. Designed to provide years of trouble free service in demanding industrial, construction and rental environments. Available in 2 styles, with and without the power on "glow" module to light up the entire device.

- 2 styles – with and without internal lamp module (see chart)
- Translucent body allows device to glow from power on lamp
- Tough, soft feel, rubber overmold grip
- Wide open "suitcase" style construction makes wiring easy
- Two captive screw body clamp design is easy to assemble
- Cord diameter matching inserts fit a wide range of cord sizes
- Solid brass blades for optimum electrical contact
- Fits 10/3 to 18/3 cord diameters*
- Rugged design withstands abuse on the jobsite
- Clear internal conductor cover allows visual inspection
- Color coded termination screws for ground, hot and neutral
- Combo screw head

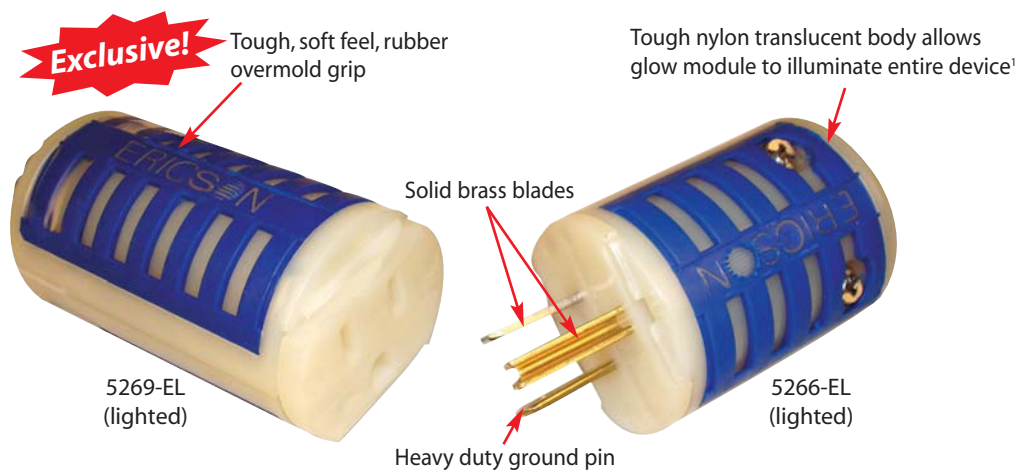

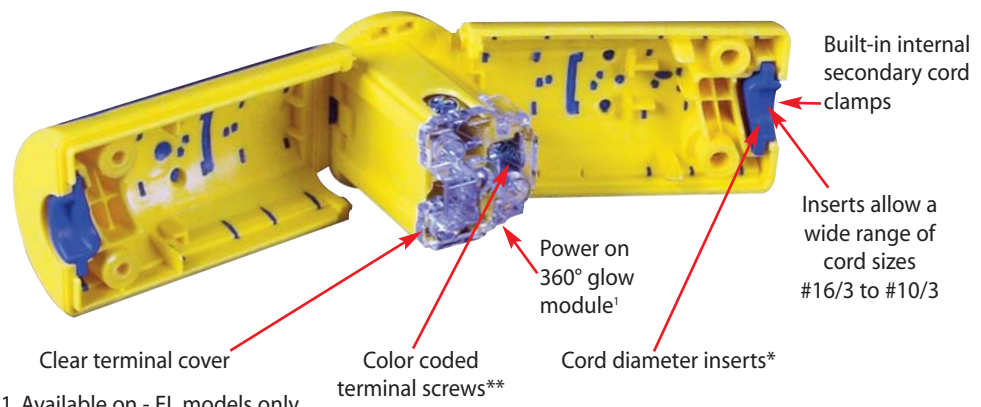

EL Models Translucent Body "Glow"

1 Piece Design - EZ To Wire



Devices Selection Guide

| Face View | NEMA Configuration | Electrical Ratings | | With Internal Glow Light | | Without Internal Glow Light | |
|---|--------------------|--------------------|-------|--------------------------|------------|-----------------------------|------------|
| | | Amps | Volts | Plugs | Connectors | Plugs | Connectors |
| Straight Blade, 2-pole, 3-wire Grounding Devices | | | | | | | |
|    | 5-15 | 15 | 125 | 5266-EL | 5269-EL | 5266-E | 5269-E |

Notes:
 *Cord diameters - .3 to .6 inch
 **Slot - Phillips



MANY ERICSON PRODUCTS ARE LISTED OR CERTIFIED.
 FOR THE LATEST FULL SEARCHABLE LISTING BY PART NUMBER, GO TO: WWW.ERICSON.COM/AGENCY
 Note: Products shown on this page may not be listed.



Ericson can customize our offering of wiring devices to meet your individual needs. The custom solution can be as simple as the popular printing on the back of the cord grip nut to fully custom colored and labeled product. Minimum order sizes will apply as well as some setup fees. Contact us to discuss your needs and custom design details.



Notes:

- 1. Some customization can void certain agency safety listings or warranty.
- 2. Minimum quantities will apply. Other design and tooling fees may apply.

How to order: Contact you local Ericson Factory Representative or call us at 1-800-Ericson (374-2766)



ERICSONTM
electrical
specialties

*ORIGINATORS OF DEAD-FRONT,
BACK-WIRED PLUG CAPS

PERMA-LINKTM

DOUBLE INSULATED PLUG CAPS AND
CONNECTOR BODIES

Original 1930's Advertisement



MANY ERICSON PRODUCTS ARE LISTED OR CERTIFIED.
FOR THE LATEST FULL SEARCHABLE LISTING BY PART NUMBER, GO TO: WWW.ERICSON.COM/AGENCY
Note: Products shown on this page may not be listed.



All Weather Heavy Duty Wet Location Double Outlet Receptacle with Cover Plates



FEATURES:

- **SafetyFirst™** UL Listed to American and Canadian Standards for wet or damp locations
- Impact, chemical and corrosion resistant
- Superior interior splash and hose down protection
- Exceptional all weather outdoor protection
- Simplified, flexible mounting alternatives
- Secure power access lockout / tagout capability
- Popular NEMA configuration alternatives
- Pre-wired for quick installation
- Rubberized box with stainless steel hardware
- Non-metallic cord grip
- Spring loaded flip covers

Ericson's PWDX Series of all weather, heavy duty double outlet receptacles are ideal for a wide range of demanding applications where splash and hose-down protection is required. A perfect fit for food and liquid processing facilities, the non-metallic enclosure and optional cord grip construction guards against metal and glass fragments that can pose health and safety risks, while the extra deep internally sealed spring-loaded flip covers provide protection when not in use.

The versatile PWDX Series receptacles, when mated with Ericson's Perma-Tite2 plugs, provide NEMA 4X levels of protection against dust, rain, hose/spray, chemical, and snow/ice. The 8-point seal-tite mating design seals around the plug to provide unmatched weather resistance.

Flexible mounting configurations, including pendant, rigid conduit, wall and "stringer" cordset, make this an ideal solution for a wide range of applications including:

- | | | | |
|---------------------------|-----------------------|------------------------|----------------------|
| • Food Processing | • Beverage Processing | • Marina Ship-to-shore | • Petro-Chemical |
| • Vehicle / Engine Heater | • Pulp / Paper Mills | • Utilities | • Refineries |
| • Venue Landscape | • Outdoor Events | • Automotive | • Harsh Environments |



PWDX Series - All Weather Heavy Duty Receptacles

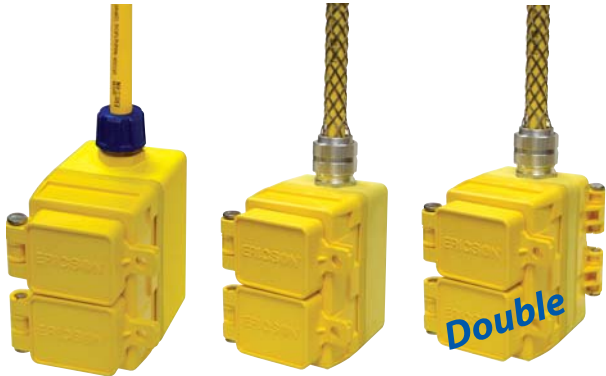

6212NFS Box with 1610-PWDX "pendant non-metallic" style 6234WFS with 1610-PWDX pendant style Double 1610-PWDX on 6234WFT enclosure

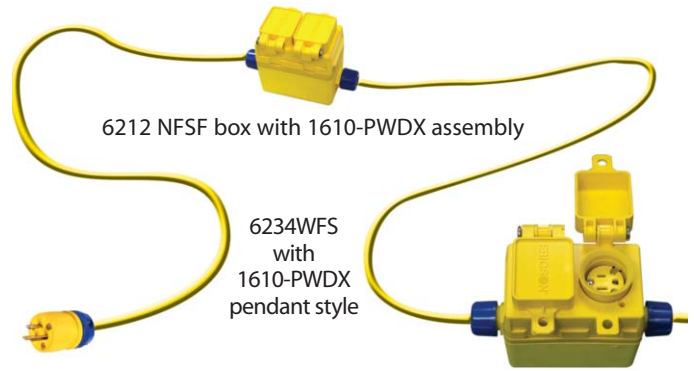

6212 NFSF box with 1610-PWDX assembly

6234WFS with 1610-PWDX pendant style

NOTICE:
 *The NEC restricts the use of metallic "job" boxes for use in temporary relocateable power cords. Only use non-metallic enclosures designed and tested to meet compliance.





| NEMA | NEMA | NEMA | NEMA | NEMA | NEMA | NEMA |
|------------------|------------------|------------------|------------------|------------------|------------------|------------------|
| | | | | | | |
| 1610-PWDX | 1612-PWDX | 1614-PWDX | 1616-PWDX | 1620-PWDX | 1622-PWDX | 1624-PWDX |

| Part Number | Description | NEMA Config | Amps | Volts |
|--|---|-------------|------|-------|
| PWDX Dual Receptacle & Cover Assembly/ Prewired | | | | |
| Straight | | | | |
| 1610-PWDX | Receptacle & Flip Cover, Duplex, All Weather, 5-15 | 5-15 | 15 | 125 |
| 1612-PWDX | Receptacle & Flip Cover, Duplex, All Weather, 5-20 | 5-20 | 20 | 125 |
| 1614-PWDX | Receptacle & Flip Cover, Duplex, All Weather, 6-15 | 6-15 | 15 | 250 |
| 1616-PWDX | Receptacle & Flip Cover, Duplex, All Weather, 6-20 | 6-20 | 20 | 250 |
| Locking | | | | |
| 1620-PWDX | Receptacle & Flip Cover, Duplex, All Weather, L5-15 | L5-15 | 15 | 125 |
| 1622-PWDX | Receptacle & Flip Cover, Duplex, All Weather, L6-15 | L6-15 | 15 | 250 |
| 1624-PWDX | Receptacle & Flip Cover, Duplex, All Weather, L7-15 | L7-15 | 15 | 277 |

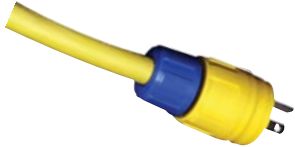

MANY ERICSON PRODUCTS ARE LISTED OR CERTIFIED.
 FOR THE LATEST FULL SEARCHABLE LISTING BY PART NUMBER, GO TO: WWW.ERICSON.COM/AGENCY
 Note: Products shown on this page may not be listed.

| Ericson Perma-Tite®2 Series Mating Plugs | | | |
|--|---------------------------|--|---|
| PWDX Part Number | Mating Plug Perma-Tite 2® | Perma-Tite 2® Series Plug | Plug Bushing Kit |
| 1610-PWDX | 1520-PW6P |  | 82005 - 1/2" Kit  |
| 1612-PWDX | 1512-PW6P | | |
| 1614-PWDX | 1514-PW6P | | |
| 1616-PWDX | 1516-PW6P | | |
| 1620-PWDX | 1520-PW6P | | |
| 1622-PWDX | 1522-PW6P | | |
| 1624-PWDX | 1528-PW6P | | |

| Rubberized FS & FD Boxes | | | |
|---|---|--|---|
|  6212FS |  6234FD |  6234FT |  6234WFS |
|  6212NFS |  6212NFD |  6212NFT |  6212WFD |
|  6234NFS |  6234NFD |  6234NFT |  6234WFT |

| Wall/Post Mount Kit 6260WK | | (NM) Non Metallic Bushing Kits | | Wire Mesh Grips | | |
|---|---|---|--|---|--|---------------|
| Optional Wall Mount Kit |  | 82034 - 3/4" | 82010 - 1" |  | | |
|  | |  |  | | | 82005W = 1/2" |
| | | | | | | 82034W = 3/4" |
| | | | | | | 82010W = 1" |
| | | | | | | 82005W-1 |
| | | | 82034W-1 | | | |





| Boxes for PWDX - Punched - No Bushing Kit | | | |
|---|---|---|--|
| | Part Number | Description | |
| | 6212FS | Box, Std Depth, PWDX, No bushing, 1/2" NPT | |
| | 6234FS | Box, Std Depth, PWDX, No bushing, 3/4" NPT | |
| | 6210FS | Box, Std Depth, PWDX, No bushing, 1" NPT | |
| | 6212FD | Box, Deep, PWDX, No bushing, 1/2" NPT | |
| | 6234FD | Box, Deep, PWDX, No bushing, 3/4" NPT | |
| | 6210FD | Box, Deep, PWDX, No bushing, 1" NPT | |
| | 6212FT | Box, OPEN, PWDX, No bushing, 1/2" NPT | |
| | 6234FT | Box, OPEN, PWDX, No bushing, 3/4" NPT | |
| | 6210FT | Box, OPEN, PWDX, No bushing, 1" NPT | |
| | 6212FSF | Box, Std Depth, PWDX, No Bushing, Feed thru, 1/2" NPT | |
| | 6234FSF | Box, Std Depth, PWDX, No Bushing, Feed thru, 3/4" NPT | |
| | 6210FSF | Box, Std Depth, PWDX, No Bushing, Feed thru, 1" NPT | |
| | 6212FDF | Box, Deep, PWDX, No Bushing, Feed thru, 1/2" NPT | |
| | 6234FDF | Box, Deep, PWDX, No Bushing, Feed thru, 3/4" NPT | |
| | 6210FDF | Box, Deep, PWDX, No Bushing, Feed thru, 1" NPT | |
| | 6212FTF | Box, OPEN, PWDX, No Bushing, Feed thru, 1/2" NPT | |
| 6234FTF | Box, OPEN, PWDX, No Bushing, Feed thru, 3/4" NPT | | |
| 6210FTF | Box, OPEN, PWDX, No Bushing, Feed thru, 1" NPT | | |
| Boxes for PWDX - 1/2" NPT Bushing Installed (N = Non Metallic W = Wire Mesh) | | | |
| | 6212NFS | Box, Std Depth, PWDX, NM Bushing, 1/2" NPT | |
| | 6212NFD | Box, Deep, PWDX, NM Bushing, 1/2" NPT | |
| | 6212NFT | Box, OPEN, PWDX, NM Bushing, 1/2" NPT | |
| | 6212NFSF | Box, Std Depth, PWDX, NM Bushing, Feed thru, 1/2" NPT | |
| | 6212NFDF | Box, Deep, PWDX, NM Bushing, Feed thru, 1/2" NPT | |
| | 6212NFTF | Box, OPEN, PWDX, NM Bushing, Feed thru, 1/2" NPT | |
| | 6212WFS | Box, Std Depth, PWDX, WireMesh Bushing, 1/2" NPT | |
| | 6212WFD | Box, Deep, PWDX, WireMesh Bushing, 1/2" NPT | |
| | 6212WFT | Box, OPEN, PWDX, WireMesh Bushing, 1/2" NPT | |
| | 6212WFSF | Box, Std Depth, PWDX, WireMesh Bushing, Feed thru, 1/2" NPT | |
| | 6212WFDF | Box, Deep, PWDX, WireMesh Bushing, Feed thru, 1/2" NPT | |
| | 6212WFTF | Box, OPEN, PWDX, WireMesh Bushing, Feed thru, 1/2" NPT | |
| | Boxes for PWDX - 3/4" NPT Bushing Installed (N = Non Metallic W = Wire Mesh) | | |
| | 6234NFS | Box, Std Depth, PWDX, NM Bushing, 3/4" NPT | |
| | 6234NFD | Box, Deep, PWDX, NM Bushing, 3/4" NPT | |
| | 6234NFT | Box, OPEN, PWDX, NM Bushing, 3/4" NPT | |
| | 6234NFSF | Box, Std Depth, PWDX, NM Bushing, Feed thru, 3/4" NPT | |
| | 6234NFDF | Box, Deep, PWDX, NM Bushing, Feed thru, 3/4" NPT | |
| | 6234NFTF | Box, OPEN, PWDX, NM Bushing, Feed thru, 3/4" NPT | |
| | 6234WFS | Box, Std Depth, PWDX, WireMesh Bushing, 3/4" NPT | |
| 6234WFD | Box, Deep, PWDX, WireMesh Bushing, 3/4" NPT | | |
| 6234WFT | Box, OPEN, PWDX, WireMesh Bushing, 3/4" NPT | | |
| 6234WFSF | Box, Std Depth, PWDX, WireMesh Bushing, Feed thru, 3/4" NPT | | |
| 6234WFDF | Box, Deep, PWDX, WireMesh Bushing, Feed thru, 3/4" NPT | | |
| 6234WFTF | Box, OPEN, PWDX, WireMesh Bushing, Feed thru, 3/4" NPT | | |
| Boxes for PWDX - 1" NPT Bushing Installed (N = Non Metallic W = Wire Mesh) | | | |
| 6210NFS | Box, Std Depth, PWDX, NM Bushing, 1" NPT | | |
| 6210NFD | Box, Deep, PWDX, NM Bushing, 1" NPT | | |
| 6210NFT | Box, OPEN, PWDX, NM Bushing, 1" NPT | | |
| 6210NFSF | Box, Std Depth, PWDX, NM Bushing, Feed thru, 1" NPT | | |
| 6210NFDF | Box, Deep, PWDX, NM Bushing, Feed thru, 1" NPT | | |
| 6210NFTF | Box, OPEN, PWDX, NM Bushing, Feed thru, 1" NPT | | |
| 6210WFS | Box, Std Depth, PWDX, WireMesh Bushing, 1" NPT | | |
| 6210WFD | Box, Deep, PWDX, WireMesh Bushing, 1" NPT | | |
| 6210WFT | Box, OPEN, PWDX, WireMesh Bushing, 1" NPT | | |
| 6210WFSF | Box, Std Depth, PWDX, WireMesh Bushing, Feed thru, 1" NPT | | |
| 6210WFDF | Box, Deep, PWDX, WireMesh Bushing, Feed thru, 1" NPT | | |
| 6210WFTF | Box, OPEN, PWDX, WireMesh Bushing, Feed thru, 1" NPT | | |



MANY ERICSON PRODUCTS ARE LISTED OR CERTIFIED.

FOR THE LATEST FULL SEARCHABLE LISTING BY PART NUMBER, GO TO: WWW.ERICSON.COM/AGENCY

Note: Products shown on this page may not be listed.

PERMA-TITE®2 Single Outlet Receptacle with Cover Plates - FS Series

- Weather resistant boot seals around Ericson Perma-Tite plug to provide weather resistant protection
- Spring-loaded flip-lid covers receptacle when not in use
- Includes cover plate, rubber boot, stainless steel mounting plate/mounting screws
- Impact, chemical & corrosion resistant construction stands up to demanding environments
- Mounts easily to any FS and FD boxes and any flat surface

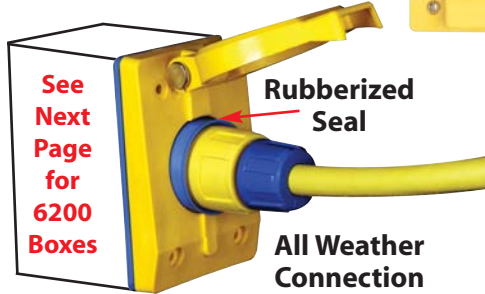
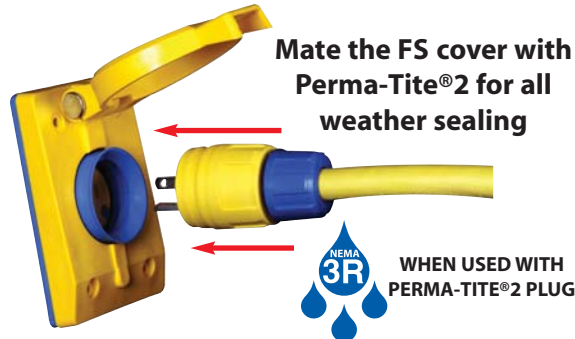

Also Available in:

- Green
- Black
- Sand



PERMA-TITE®2 Single Outlet Cover Plates - FS Series

| Face View | NEMA Configuration | Electrical Ratings | | FS Female Receptacle | 2705 Male Inlet Std Opening | 2705 Male Inlet Large Opening |
|--|--------------------|--------------------|-----------------------|------------------------------|-----------------------------|-------------------------------|
| | | Amps | Volts | | | |
| 15A Straight Blade & Locking 20A Straight Blade | | | | | | |
| Flip Seal Cover w/ weatherproof boot only | | | | 2700-FS⁽¹⁾ | 1 7/16" Dia. | 2" Dia. |
| | Non-NEMA | 10/15 Amp | 125/250 Volt | 2715FS07 | | |
| | 5-15 | 15 Amp | 125 Volt | 2715-FS10 | 2705-15 | 2705-15A |
| | 5-20 | 20 Amp | 125 Volt | 2715-FS12 | 2705-20 | 2705-20A |
| | 6-15 | 15 Amp | 250 Volt | 2715-FS14 | | |
| | 6-20 | 20 Amp | 250 Volt | 2715-FS16 | | |
| | L5-15 | 15 Amp | 125 Volt | 2715-FS20 | 2705-L15 | 2705-L15A |
| | L6-15 | 15 Amp | 250 Volt | 2715-FS22 | | |
| | L7-15 | 15 Amp | 277 Volt | 2715-FS24 | | |
| 20A & 30A Locking, 3-Wire | | | | | | |
| Flip Seal Cover w/ weatherproof boot only | | | | 2800-FS⁽¹⁾ | 2 1/8" Dia. | |
| | L5-20 | 20 Amp | 125 Volt | 2820-FS10 | 2705-L20 | |
| | L6-20 | 20 Amp | 250 Volt | 2820-FS12 | | |
| | L7-20 | 20 Amp | 277 Volt | 2820-FS14 | | |
| | Non-NEMA | 20 Amp | 125/250 Volt | 2820-FS16 | | |
| | Non-NEMA | 20 Amp/10 Amp | 250 Volt/600 Volt | 2820-FS17 | | |
| | L5-30 | 30 Amp | 125 Volt | 2830-FS10 | | |
| | L6-30 | 30 Amp | 250 Volt | 2830-FS12 | | |
| | L7-30 | 30 Amp | 277 Volt | 2830-FS14 | | |
| | Non-NEMA | 30 Amp | 125/250 Volt | 2830-FS16 | | |
| 20A & 30A Locking, 4-Wire | | | | | | |
| Flip Seal Cover w/ weatherproof boot only | | | | 2900-FS⁽¹⁾ | 2 1/8" Dia. | |
| | L14-20 | 20 Amp | 125/250 Volt | 2920-FS20 | 2705-L142 | |
| | L15-20 | 20 Amp | 250 Volt, 3 ø | 2920-FS22 | | |
| | L16-20 | 20 Amp | 480 Volt, 3 ø | 2920-FS24 | 2705-L162 | |
| | L14-30 | 30 Amp | 125/250 Volt | 2930-FS20 | | |
| | L15-30 | 30 Amp | 250 Volt, 3 ø | 2930-FS22 | | |
| | L16-30 | 30 Amp | 480 Volt, 3 ø | 2930-FS24 | | |
| | L17-30 | 30 Amp | 600 Volt, 3 ø | 2930-FS26 | | |
| | L18-30 | 30 Amp | 120/208 Volt, 3 ø wye | 2930-FS30 | | |
| | Non-NEMA | 30 Amp | 120/208 Volt, 3 ø wye | 2930-FS28 | | |

NOTES:

1. Does not include receptacle. Use with standard receptacles of same electrical ratings.



Single Male Inlet Assemblies with Cover Plates - 2705 FS Series

- Weather resistant boot seals around the connector to provide weather resistant protection
- Spring-loaded flip-lid covers inlet when not in use
- Includes cover plate, rubber boot, stainless steel mounting plate/mounting screws
- Impact, chemical & corrosion resistant construction stands up to demanding environments
- Mounts easily to any 6200 series FS/FD boxes or any flat surface
- Spring Loaded SS hardware flip cover



Application Notes:

The 2705 FS series of male inlets is designed for all weather power inlet on a variety of applications. The heavy duty flip cover assembly and superior round sealing collar provides a superior seal against the elements. Use for inlet power only. Never use these devices for power output or receptacle. These devices must be wired dead and cannot be accidentally energized without a connector in place.

- Power inlet for powered food trolley carts
- Power charging inlet for fire trucks, ambulances and electric service vehicles
- Power charging port for electric battery cars or golf carts
- Power inlet for machines in tough environments
- Power inlet for portable temporary power panels



Also available in all black or customized - call Ericson for details

6200 Series Boxes for FS Series Mounting

| Part Number | Description |
|---|--|
| 6212FSK | Box, Std Depth, No bushing, 1/2" NPT |
| 6234FSK | Box, Std Depth, No bushing, 3/4" NPT |
| 6210FSK | Box, Std Depth, No bushing, 1" NPT |
| 6212FDK | Box, Deep, No bushing, 1/2" NPT |
| 6234FDK | Box, Deep, No bushing, 3/4" NPT |
| 6210FDK | Box, Deep, No bushing, 1" NPT |
| Boxes for 2705 - 1/2" NPT Bushing Installed (N=Non Metallic W = Wire Mesh) | |
| 6212NFSK | Box, Std Depth, NM Bushing, 1/2" NPT |
| 6212NFDK | Box, Deep, NM Bushing, 1/2" NPT |
| 6212WFSK | Box, Std Depth, WireMesh Bushing, 1/2" NPT |
| 6212WFDK | Box, Deep, WireMesh Bushing, 1/2" NPT |
| 6234NFSK | Box, Std Depth, NM Bushing, 3/4" NPT |
| 6234NFDK | Box, Deep, NM Bushing, 3/4" NPT |
| 6234WFSK | Box, Std Depth, WireMesh Bushing, 3/4" NPT |
| 6234WFDK | Box, Deep, WireMesh Bushing, 3/4" NPT |
| 6210NFSK | Box, Std Depth, NM Bushing, 1" NPT |
| 6210NFDK | Box, Deep, NM Bushing, 1" NPT |
| 6210NFTK | Box, OPEN, NM Bushing, 1" NPT |
| 6210WFSK | Box, Std Depth, WireMesh Bushing, 1" NPT |
| 6210WFDK | Box, Deep, WireMesh Bushing, 1" NPT |
| 6210WFTK | Box, OPEN, WireMesh Bushing, 1" NPT |

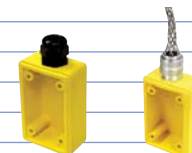
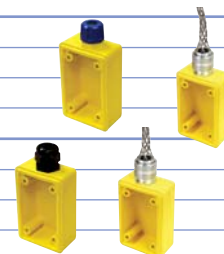

MANY ERICSON PRODUCTS ARE LISTED OR CERTIFIED.

FOR THE LATEST FULL SEARCHABLE LISTING BY PART NUMBER, GO TO: WWW.ERICSON.COM/AGENCY

Note: Products shown on this page may not be listed.

Physical Box Sizes

FT Feed Thru Box

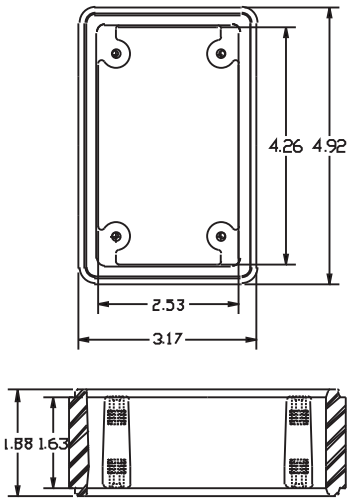

FD Deep Box

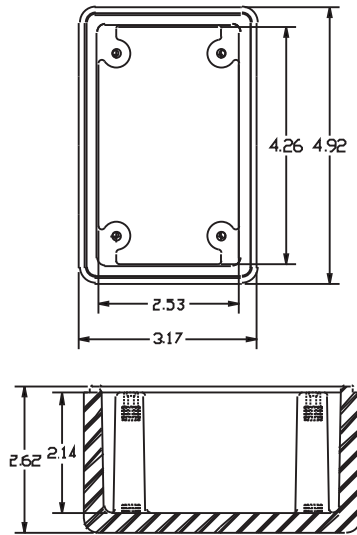

FS Standard Box

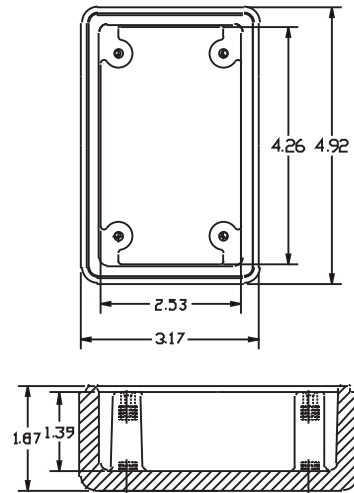

Mounting Templates

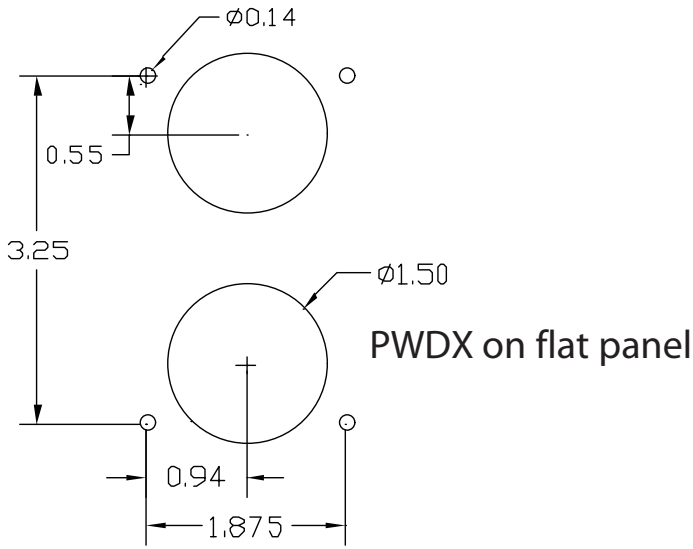

6260 WK Wall Kit

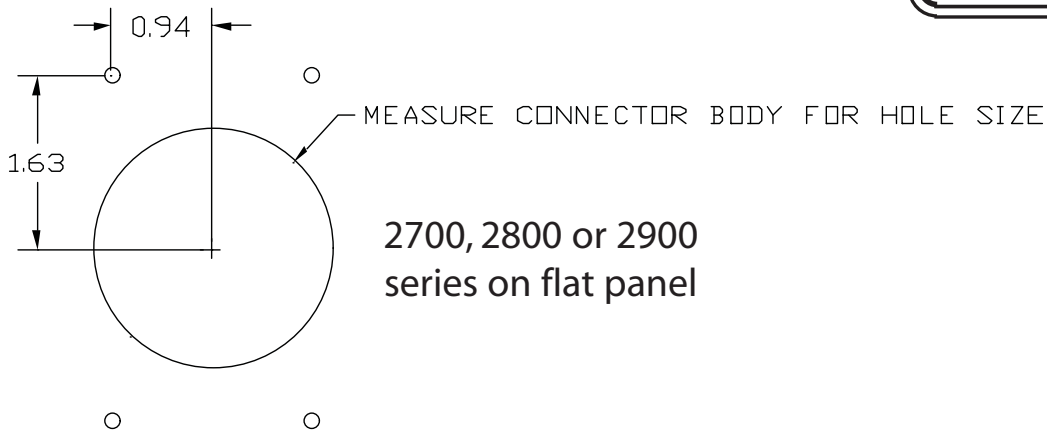
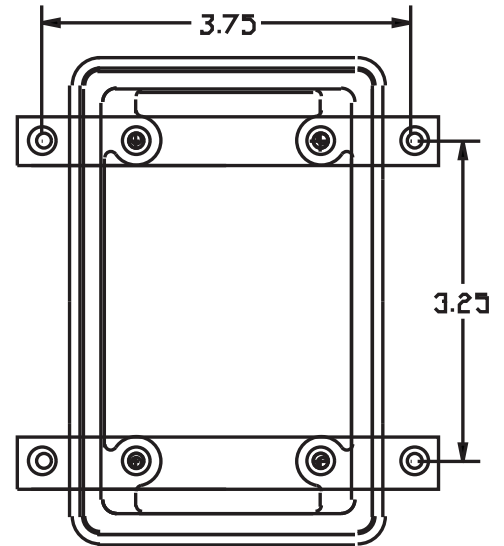



NEMA Configuration Adapters

Now make quick, secure connections between straight-blade and locking plugs and connectors with Ericson's NEMA configuration adapters.

- Heavy-duty non-conducting housing and using heavy gauge solid brass blades
- Compact size makes them easy to use and transport
- Available in four of the most popular models

NEMA Configuration Adapters Selection Guide



123-15P20C

123-20P15C

| Catalog Number | NEMA Configuration | | Description |
|----------------|--------------------|--------|---|
| | Male | Female | |
| 1705 | | | Male 15A, 125V twist (L5-15P) to 20A, 125V straight (5-20R) |
| 1712 | | | Male 15A, 125V straight (5-15P) to 15A, 125V twist (L5-15R) |
| 1740 | | | Male 20A, 125V twist (L5-20P) to 20A, 125V straight (5-20R) |
| 1744 | | | Male 15A, 125V straight (5-15P) to 20A, 125V twist (L5-20R) |
| 123-20P15C | | | Male 20A, 125V twist (L5-20P) to 15A, 125V straight (5-15R) |
| 123-15P20C | | | Male 15A, 125V straight (5-15P) to 20A, 125V twist (L5-20R) |

PERMA-TITE® 2 Plug Cover

- Use with Ericson's Perma-Tite® plugs to seal out water, dust and other contaminants and to protect blades from damage when plug is not in-use
- Eight-point rubber tongue and groove sealing system provides environmental protection
- Additional protection provided by a unique internal water/dust wiper
- Easy to assemble
- Ericson's Radiant Yellow for High Visibility on job sites



15PW with 1510-PW6P Plug

PERMA-TITE® 2 Plug Cover Selection Guide

| Catalog Number | Description |
|----------------|---|
| 15PW | Male closure cap, for use with 15A Straight Blade & Locking devices and 20A Straight Blade devices. |
| 16CW | Female replacement cover for CW6P connectors |
| 24CW | Female Large replacement cover for CW6P connectors |
| 26CW | Female 30 Amp Large replacement cover for CW6P connectors |



16CW - Fits 16XXCW6P Connectors

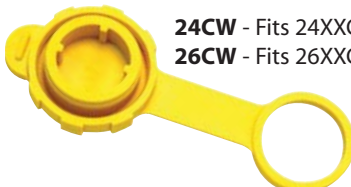

24CW - Fits 24XXCW6P Connectors
26CW - Fits 26XXCW6P Connectors



MANY ERICSON PRODUCTS ARE LISTED OR CERTIFIED.
FOR THE LATEST FULL SEARCHABLE LISTING BY PART NUMBER, GO TO: WWW.ERICSON.COM/AGENCY
Note: Products shown on this page may not be listed.

Hospital Grade Perma-Link® Plugs and Connectors

The same rugged internal construction as our standard Perma-Link line is found in these units, and in addition they meet UL Hospital Grade standards. Designed for reliable long life, built to withstand exceptional abuse, these dead-front, back-wired devices save installation time, provide maximum protection and can be used for straight blade installations in hospitals, schools, and extended care facilities. Constructed of rugged polybutylene terephthalate (PBT) and a high-tech thermoplastic elastomer (TPE), they have passed tests for ground pin retention, ground resistance, face impact, ground temperature contact, fault current, line blade retention and abrupt removal.

INSULATED/INSTITUTION GRAY RUBBER COVER

White and light "institution" gray colors identify this style which provides superior insulation. They are clearly marked "Hospital Grade" and clearly marked with a green dot to signify UL Hospital Grade. Non-conductive cord clamp to accommodate cord sizes #16/3 SJ through #12/3 SO.

FAST WIRING CHECK THROUGH CLEAR COVER

White PBT and transparent polycarbonate housing identify this type which permits visual inspection of wiring terminations without disassembly. Impact resistance, and non-conductive. Cord clamp has removable insert to accommodate #16/3 SJTW through #12/3 SO cord sizes.

PERMA-LINK® Hospital Grade Selection Guide

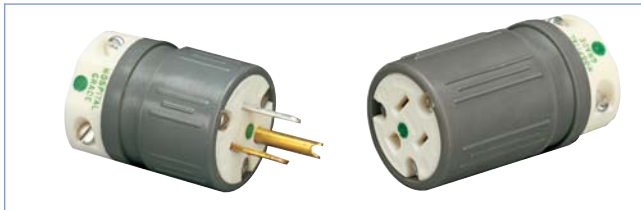

Hospital Grade Devices with Gray Covers

| Face View | NEMA Configuration | Electrical Ratings | | Perma-Link | |
|-----------|--------------------|--------------------|-------|------------|------------|
| | | Amps | Volts | Plugs | Connectors |
| | 5-15 | 15 | 125 | 1530-PH | 1630-CH |
| | 5-20 | 20 | 125 | 1532-PH | 1632-CH |

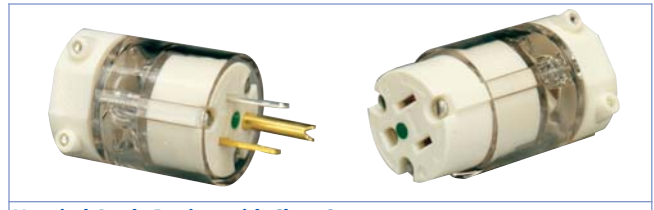

Hospital Grade Devices with Clear Covers
Straight Blade, 2-pole, 3-wire Grounding

| Face View | NEMA Configuration | Electrical Ratings | | Perma-Link | |
|-----------|--------------------|--------------------|-------|------------|------------|
| | | Amps | Volts | Plugs | Connectors |
| | 5-15 | 15 | 125 | 1530-PHC | 1630-CHC |
| | 5-20 | 20 | 125 | 1532-PHC | 1632-CHC |

EML520R & EML630R

Ericson offers our same heavy duty receptacles that we use in our own Temporary Power Panels. These wiring devices are primarily used in our OSCAR series and can be used as replacement parts for those products. Features such as color coded screw terminals with combo heads for ease of wiring makes these superior devices the best choice.



L6-30

EML630R



L5-20

EML520R



PERMA-LINK® 50Amp Locking Plugs and Connectors

Ericson's 50 Amp plugs and connectors incorporate the latest technologies to provide wiring devices that are safer, faster to wire, lighter and easier to identify. These devices are available as plugs, connectors, inlets and receptacles and are available in 3 and 4 wire configurations.



- UL Listed, CSA Certified, CETLUS Listed
- Rugged nylon construction resists impact, corrosion and jobsite oils/chemicals
- Quick field assembly, no need to disassemble the entire device
- Nickel plated blades and stainless steel screws provide optimum corrosion resistance
- Optional heavy-duty weather-proof boots are available and provide added environmental protection and UV resistance
- Boots can be threaded together with the optional sealing collar system to provide maximum environmental protection
- Available in plugs, connectors, inlets and receptacles

50-Amp Devices Selection Guide



| Face View | NEMA | Electrical Ratings | | Perma-Link® | | Receptacles | Flanged Inlets | Inlet with Flip Cover |
|--|---------------|--------------------|----------------|-------------|------------|-------------|----------------|-----------------------|
| | Configuration | Amps | Volts | Plugs | Connectors | | | |
| Locking, 2-pole, 3-wire Grounding | | | | | | | | |
| | Non-NEMA | 50 | 250VDC, 600VAC | 3763-P | 3762-C | 3771 | 3777 | |
| Locking, 3-pole, 4-wire Grounding | | | | | | | | |
| | Non-NEMA | 50 | 250VDC, 600VAC | 3765-P | 3764-C | 3769 | 3775 | |
| | | | 250VDC, 600VAC | 7765-P(1) | 7764-C(1) | 7379 | 7958 | |
| Locking, California Style, 2-pole, 3-wire Grounding | | | | | | | | |
| | Non-NEMA | 50 | 125 | CS6361-P | CS6360-C | - | - | |
| | | | 250 | CS8265-P | CS8264-C | CS8269 | CS8275 | |
| | | | 480 | CS8465-P | - | CS8469 | - | |
| Locking, California Style, 3-pole, 4-wire Grounding | | | | | | | | |
| | Non-NEMA | 50 | 125/250 | CS6365-P | CS6364-C | CS6369 | CS6375 | CS6375-F |
| | | | 480, 3ø | CS8165-P | CS8164-C | CS8169 | CS8175 | |

Notes:

1. For replacement use only, not recommended for new installations
2. Contact factory for custom assemblies

| Perma-Link® 50-Amp Accessories | Cat. Number |
|---|-------------|
| Weatherproof boot for plug or connector | 7717 |
| Sealing Collar for weatherproof boots | 510-RR |
| Weatherproof receptacle cover | 7788-CR |

Plug into Oscar™



7717 Provides A Superior Seal With Our SR-50 Receptacle

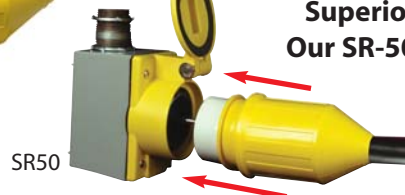

Sealing Collar System

Our exclusive sealing collar system is available to provide maximum moisture protection between cordsets. The two boots are securely sealed together with threaded polycarbonate rings.



MANY ERICSON PRODUCTS ARE LISTED OR CERTIFIED. FOR THE LATEST FULL SEARCHABLE LISTING BY PART NUMBER, GO TO: WWW.ERICSON.COM/AGENCY
 Note: Products shown on this page may not be listed.



Commercial Grade



Commercial Grade

| Insert Used | Cord Diameter |
|-------------|------------------------|
| Both | Less than .220 - .450" |
| None | Over .460 - .650" |

PERMA-LINK®

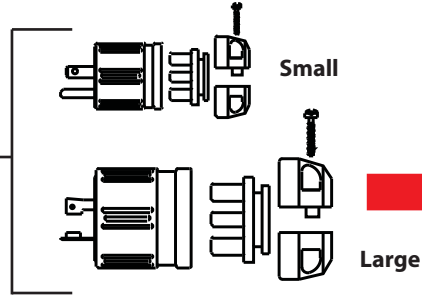

PERMA-LINK® Devices

| Self centering cord clamp accommodates cord diameters | |
|---|--------------|
| Small | .335 - .720" |
| Med/Large | .360 - 1.0" |

PERMA-GRIP™

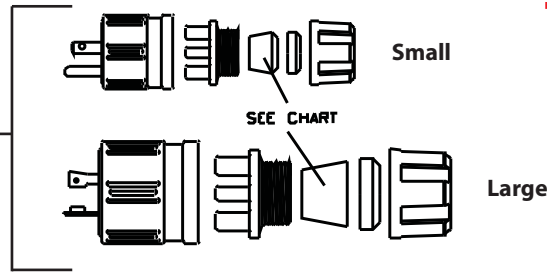

For Grommet Sizing

See Chart Next Page

PERMA-TITE® 2

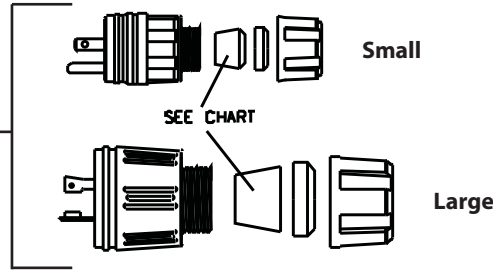

Strip Lengths

Dimensions in inches
Round Cord Only

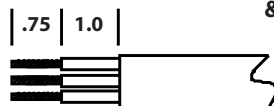
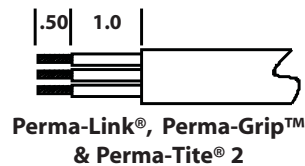
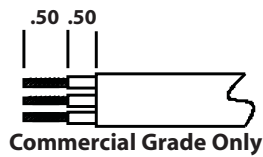
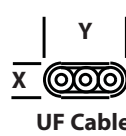

Grommet Sizes

| | | B10200XX | | | | | | B10220XX | | | | | | | | | |
|-----------------------------|-------------|------------------------------|------------------------------|-------------------|------------------|----------------|-----------------|------------------|-------------------|------------------|-----------------|-----------------|----------------|-------------------|----------|----------|-----------|
| | | Sm White OVAL # 24 | Sm Orange OVAL # 25 | Sm Yellow # 21 | Sm White # 20 | Sm Red # 16 | Sm Blue # 18 | Lg White # 91 | Lg Yellow # 90 | Lg Black # 89 | Lg Blue # 88 | Lg Gray # 87 | Lg Red # 86 | Lg Orange # 85 | | | |
| MAX CORD DIA. (inch) | | OVAL (UF) .160 x .360 | OVAL (UF) .230 x .440 | 0.370 | 0.450 | 0.560 | 0.610 | 0.450 | 0.560 | 0.630 | 0.690 | 0.750 | 0.830 | 0.900 | | | |
| | Plug | Connector | | Yellow | White* | Red | Blue | White* | Yellow | Black | Blue | Gray | Red | Orange | 3 | 4 | 3Ø |
| 1510 | 1610 | ✓ Optional ** | ✓ Optional ** | ✓ | ✓ | ✓ | ✓ | | | | | | | X | | | |
| 1512 | 1612 | | | ✓ | ✓ | ✓ | ✓ | | | | | | | | X | | |
| 1514 | 1614 | | | ✓ | ✓ | ✓ | ✓ | | | | | | | | X | | |
| 1516 | 1616 | | | ✓ | ✓ | ✓ | ✓ | | | | | | | | X | | |
| 1520 | 1620 | | | ✓ | ✓ | ✓ | ✓ | | | | | | | | X | | |
| 1522 | 1622 | | | ✓ | ✓ | ✓ | ✓ | | | | | | | | X | | |
| 1524 | 1624 | | | ✓ | ✓ | ✓ | ✓ | | | | | | | | X | | |
| 2310 | 2410 | | | | | | | ✓ | ✓ | ✓ | ✓ | | | X | | | |
| 2312 | 2412 | | | | | | | ✓ | ✓ | ✓ | ✓ | | | X | | | |
| 2314 | 2414 | | | | | | | ✓ | ✓ | ✓ | ✓ | | | X | | | |
| 2316 | 2416 | | | | | | | ✓ | ✓ | ✓ | ✓ | | | X | | X | |
| 2317 | 2417 | | | | | | | ✓ | ✓ | ✓ | ✓ | | | X | | | |
| 2320 | 2420 | | | | | | | | ✓ | ✓ | ✓ | ✓ | | | X | | |
| 2322 | 2422 | | | | | | | | ✓ | ✓ | ✓ | ✓ | | | X | X | |
| 2324 | 2424 | | | | | | | | ✓ | ✓ | ✓ | ✓ | | | X | X | |
| 2510 | 2610 | | | | | | | ✓ | ✓ | ✓ | ✓ | | | X | | | |
| 2512 | 2612 | | | | | | | ✓ | ✓ | ✓ | ✓ | | | X | | | |
| 2514 | 2614 | | | | | | | ✓ | ✓ | ✓ | ✓ | | | X | | | |
| 2516 | 2616 | | | | | | | ✓ | ✓ | ✓ | ✓ | | | X | | X | |
| 2520 | 2620 | | | | | | | | | | ✓ | ✓ | ✓ | | X | | |
| 2522 | 2622 | | | | | | | | | | ✓ | ✓ | ✓ | | X | X | |
| 2524 | 2624 | | | | | | | | | | ✓ | ✓ | ✓ | | X | X | |
| 2526 | 2626 | | | | | | | | | | ✓ | ✓ | ✓ | | X | X | |
| 2528 | 2628 | | | | | | | | | | ✓ | ✓ | ✓ | | X | X | |
| 2530 | 2630 | | | | | | | | | | ✓ | ✓ | ✓ | | X | X | |

* May also appear as light tan

** May be ordered separately - Call Ericson for details

✓ = Included in package

Diameter Ranges of Portable Electrical Cord In Accordance with UL 62

| Type | AWG Size | 2 Conductors | 3 Conductors | 4 Conductors |
|--|-------------|--------------|--------------|--------------|
| SJ, SJE, SJOO, SJO, SJEO, SJT, SJTO, SJTOO | 18 | 0.280-0.315 | 0.300-0.335 | 0.325-0.365 |
| | 16 | 0.305-0.340 | 0.325-0.360 | 0.350-0.395 |
| | 14 | 0.335-0.375 | 0.360-0.395 | 0.390-0.435 |
| | 12 | 0.405-0.455 | 0.425-0.475 | 0.465-0.520 |
| | 10 | 0.540-0.605 | 0.565-0.635 | 0.625-0.700 |
| S, SE, SOO, SO, SEO, ST, STOO, STO | 18 | 0.340-0.385 | 0.360-0.400 | 0.385-0.430 |
| | 16 | 0.365-0.410 | 0.385-0.430 | 0.410-0.460 |
| | 14 | 0.495-0.550 | 0.520-0.575 | 0.560-0.620 |
| | 12 | 0.565-0.625 | 0.590-0.655 | 0.640-0.710 |
| | 10 | 0.615-0.685 | 0.650-0.720 | 0.700-0.775 |
| | 8 | 0.780-0.880 | 0.830-0.930 | 0.925-1.050 |
| | 6 | 0.920-1.050 | 0.970-1.100 | 1.050-1.200 |
| | 4 | 1.060-1.210 | 1.130-1.280 | 1.250-1.450 |
| 2 | 1.210-1.400 | 1.300-1.500 | 1.450-1.650 | |



MANY ERICSON PRODUCTS ARE LISTED OR CERTIFIED.

FOR THE LATEST FULL SEARCHABLE LISTING BY PART NUMBER, GO TO: WWW.ERICSON.COM/AGENCY

Note: Products shown on this page may not be listed.



24/7 Emergency Assistance Hotline
1-877-OSCAR99 (672-2799)



MANY ERICSON PRODUCTS ARE LISTED OR CERTIFIED.
FOR THE LATEST FULL SEARCHABLE LISTING BY PART NUMBER, GO TO: WWW.ERICSON.COM/AGENCY
Note: Products shown on this page may not be listed.



Ericson Manufacturing Company offers a wide variety of plugs and connectors to fit your needs.

PERMALINK®



- Two-screw cable clamp secures cord and provides superior strain-relief
- Withstand high impact, corrosion, oils, greases, solvents and other chemicals across -20 °C to + 100°C
- Individual wire pockets help prevent flashovers
- Rubberized outer housing for superior grip and impact resistance
- Flexibility of reverse-cover design creates weather-resistant connections by interchanging covers
- Internal cord seals keep out water/mud/dust
- Available in all black

PERMAGRIP™



- Quick field assembly with cord grip nut
- Superior water/mud/dust resistance provided by safety compression cord grips
- Withstand high impact, corrosion, oils, greases, solvents and other chemicals across -20 °C to + 100°C
- Flexibility of reverse-cover design (straight blade devices) creates weather-resistant connections by interchanging covers
- Custom marking available on cord grip nut
- Available in all black

PERMATITE® 2



- Tongue & groove sealing system provides extreme environmental protection of:
 - NEMA Type 4, 4X, 6, 6P & IP67
- Devices resist high-pressure hose down of 1,500 psi.
- Withstand high impact, corrosion, oils, greases, solvents and other chemicals across -20 °C to + 100°C
- Removable/replaceable self-retained sealing cap provided with connector to keep out contaminants when not in use (plug cap also available)
- Custom marking available on cord grip nut
- Available in all black

50 Amp Devices



- Rugged nylon construction resists impact, corrosion and jobsite oils/chemicals
- Quick field assembly, with color coded markings
- Nickel plated blades and stainless steel screws provide optimum corrosion resistance
- Boots can be threaded together with the optional sealing collar system to provide maximum environmental protection
- Available in plugs, connectors, inlets and receptacles
- Rubberized grey "Twist-Grip" for ease of connection

Commercial Grade

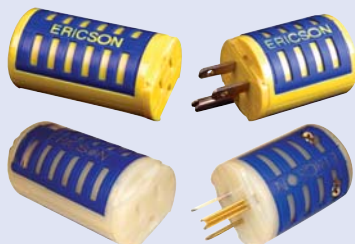

- Translucent body allows device to glow from power on lamp (EL Models)
- Wide open "suitcase" style construction makes wiring easy
- Fits 10/3 to 18/3 cord diameters
- Rugged design withstands abuse on the jobsite
- Color coded termination screws for ground, hot and neutral
- Combo screw heads speed up installation
- Rubberized "grip" cushions and surrounds device
- Economy priced



SmartMonitor™



Features of All SmartMonitor™ Plugs & Connectors:

- Super bright 2-color LED technology
- SmartMonitor™ Module
- Easy to wire
- Clear internal wiring cover
- Multiple cord grommets included
- Makes OSHA safety compliance easy and cost effective

24/7 Monitoring of These 7 Events

- No Ground
- Loss of Ground In Cord
- Hot/Neutral Swap
- Reverse Polarity
- Hot on Ground
- Open Neutral

3 Styles to Pick From:

- Perma-Link®
- Perma-Grip™
- Perma-Tite® 2



Smart Cords



New From Ericson... Industrial application SmartCords factory built to last and last. Models with Smart Connector (Economy Safe) and both Smart Plug and connector are available. 24/7 monitoring with Assured Grounding Compliance to NEC and OSHA standards. Built with the highest quality materials to withstand your environment.

FS Series Single Receptacles & Male Inlets Under All Weather Flip Covers



- Weather resistant boot seals around Ericson Perma-Tite plug to provide weather resistant protection
- Spring-loaded flip-lid covers receptacle when not in use
- Includes cover plate, rubber boot, stainless steel mounting plate/mounting screws
- Impact, chemical & corrosion resistant construction stands up to demanding environments
- Mounts easily to 6200 or 6300 series FS/FD boxes and any flat surface
- Collar plug seals and grips all types of round plugs or connectors

Double Outlet Receptacle with Cover Plates - PWDX Series

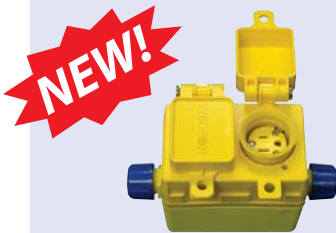

- Weather resistant boot seals around Ericson Perma-Tite plug to provide weather resistant protection
- Spring-loaded flip-lid covers the receptacle when not in use
- Two independent fully rated receptacles in one easy to install assembly
- Impact, chemical & corrosion resistant construction stands up to demanding environments
- Mounts easily to 6200 series FS/FD boxes and any flat surface

Adapters



NEMA Change Adapters

Now make quick, secure connections between straight-blade and locking plugs and connectors with Ericson's NEMA configuration adapters.

- Heavy-duty non-conducting housing and using heavy gauge solid brass blades
- Compact size makes them easy to use and transport
- Available in molded style or short cords



MANY ERICSON PRODUCTS ARE LISTED OR CERTIFIED.

FOR THE LATEST FULL SEARCHABLE LISTING BY PART NUMBER, GO TO: WWW.ERICSON.COM/AGENCY

Note: Products shown on this page may not be listed.



Ericson NEMA Chart

EXTREME









BEST



| Face View | NEMA | Electrical Ratings | | PERMA-TITE® 2 | | PERMA-GRIP™ | |
|-------------------------------------|---------------|--------------------|-------------------|---------------|------------|-------------|------------|
| | Configuration | Amps | Volts | Plugs | Connectors | Plugs | Connectors |
| 2-pole, 3-Wire Grounding | | | | | | | |
| | 5-15 | 15 | 125 | 1510-PW6P | 1610-CW6P | 1510-PG | 1610-CG |
| | 5-20 | 20 | 125 | 1512-PW6P | 1612-CW6P | 1512-PG | 1612-CG |
| | 6-15 | 15 | 250 | 1514-PW6P | 1614-CW6P | 1514-PG | 1614-CG |
| | 6-20 | 20 | 250 | 1516-PW6P | 1616-CW6P | 1516-PG | 1616-CG |
| | L5-15 | 15 | 125 | 1520-PW6P | 1620-CW6P | 1520-PG | 1620-CG |
| | L6-15 | 15 | 250 | 1522-PW6P | 1622-CW6P | 1522-PG | 1622-CG |
| | L7-15 | 15 | 277 | 1524-PW6P | 1624-CW6P | 1524-PG | 1624-CG |
| | L5-20 | 20 | 125 | 2310-PW6P | 2410-CW6P | 2310-PG | 2410-CG |
| | L6-20 | 20 | 250 | 2312-PW6P | 2412-CW6P | 2312-PG | 2412-CG |
| | L7-20 | 20 | 277 | 2314-PW6P | 2414-CW6P | 2314-PG | 2414-CG |
| 3-Pole, 3-Wire Non-Grounding | | | | | | | |
| | Non-NEMA | 20 | 125/250 | 2316-PW6P | 2416-CW6P | 2316-PG | 2416-CG |
| | Non-NEMA | 20/10 | 250/600 | 2317-PW6P | 2417-CW6P | 2317-PG | 2417-GC |
| | Non-NEMA | 15A/10A | 125V/250V | 1507-PW6P | 1607-CW6P | 1507-PG | 1607-CG |
| 3-Pole, 4-Wire Grounding | | | | | | | |
| | L14-20 | 20 | 125/250 | 2320-PW6P | 2420-CW6P | | |
| | L15-20 | 20 | 250, 3Ø | 2322-PW6P | 2422-CW6P | | |
| | L16-20 | 20 | 480, 3Ø | 2324-PW6P | 2424-CW6P | | |
| 2-Pole, 3-Wire Grounding | | | | | | | |
| | L5-30 | 30 | 125 | 2510-PW6P | 2610-CW6P | 2510-PG | 2610-CG |
| | L6-30 | 30 | 250 | 2512-PW6P | 2612-CW6P | 2512-PG | 2612-GC |
| | L7-30 | 30 | 277 | 2514-PW6P | 2614-CW6P | 2514-PG | 2614-CG |
| 3-Pole, 3-Wire Non-Grounding | | | | | | | |
| | Non-NEMA | 30 | 125/250 | 2516-PW6P | 2616-CW6P | | |
| 3-Pole, 4-Wire Grounding | | | | | | | |
| | L14-30 | 30 | 125/250 3Ø | 2520-PW6P | 2620-CW6P | | |
| | L15-30 | 30 | 250, 3Ø | 2522-PW6P | 2622-CW6P | | |
| | L16-30 | 30 | 480, 3Ø | 2524-PW6P | 2624-CW6P | | |
| | L17-30 | 30 | 600, 3Ø | 2526-PW6P | 2626-CW6P | | |
| 4-Pole, 4-Wire | | | | | | | |
| | L18-30 | 30 | 120/208 3Ø wye | 2530-PW6P | 2630-CW6P | | |
| 4-Pole, 4-Wire Non-Grounding | | | | | | | |
| | Non-NEMA | 30 | 120/208 3Ø wye | 2528-PW6P | 2628-CW6P | | |



| |  BETTER | |  GOOD | |  SMART | |  Single Outlet | |  Male Inlets | |  Dual Recept (PWDX) | |
|-------------------------------------|---|------------|---|------------|--|------------|---|------------|--|-----------------------|---|--|
| Face View | Plugs | Connectors | Plugs | Connectors | Plugs | Connectors | FS Cover Plates | | | Receptacle with Cover | | |
| 2-pole, 3-Wire Grounding | | | | | | | | | | | | |
| | 1510-P | 1610-C | 5266-E | 5269-E | 1510-PXX | 1610-CXX | 2715-FS10 | 2705-15/A | 1610-PWDX | | | |
| | 1512-P | 1612-C | | | 1512-PXX | 1612-CXX | 2715-FS12 | 2705-20/A | 1612-PWDX | | | |
| | 1514-P | 1614-C | Note: Lighted power-on glow models also: 5266-EL & 5269-EL | | | | 2715-FS14 | | 1614-PWDX | | | |
| | 1516-P | 1616-C | | | | | 2715-FS16 | | 1616-PWDX | | | |
| | 1520-P | 1620-C | | | | | 2715-FS20 | 2705-L15/A | 1620-PWDX | | | |
| | 1522-P | 1622-C | | | | | 2715-FS22 | | 1622-PWDX | | | |
| | 1524-P | 1624-C | | | | | 2715-FS24 | | 1624-PWDX | | | |
| | 2310-P | 2410-C | | | 2310-PXX | 2410-CXX | 2820-FS10 | 2705-L20 | 6200 Series Boxes For FS Series & PWDX Series <ul style="list-style-type: none"> • Rubberized • Fully Enclosed • Single and Double Sided • Standard and Deep  | | | |
| | 2312-P | 2412-C | | | | | 2820-FS12 | | | | | |
| | 2314-P | 2414-C | | | | | 2820-FS14 | | | | | |
| 3-Pole, 3-Wire Non-Grounding | | | | | | | | | | | | |
| | 2316-P | 2416-C | | | | | 2820-FS16 | | | | | |
| | 2317-P | 2417-C | | | | | 2820-FS17 | | | | | |
| | 1507-P | 1607-C | | | | | 2715-FS07 | | | | | |
| 3-Pole, 4-Wire Grounding | | | | | | | | | | | | |
| | 2320-P | 2420-C | | | | | 2920-FS20 | 2705-L142 | | | | |
| | 2322-P | 2422-C | | | | | 2920-FS22 | | | | | |
| | 2324-P | 2424-C | | | | | 2920-FS24 | 2705-L162 | | | | |
| 2-Pole, 3-Wire Grounding | | | | | | | | | | | | |
| | 2510-P | 2610-C | | | | | 2830-FS10 | | | | | |
| | 2512-P | 2612-C | | | | | 2830-FS12 | | | | | |
| | 2514-P | 2614-C | | | | | 2830-FS14 | | | | | |
| 3-Pole, 3-Wire Non-Grounding | | | | | | | | | | | | |
| | 2516-P | 2616-C | | | | | 2830-FS16 | | | | | |
| 3-Pole, 4-Wire Grounding | | | | | | | | | | | | |
| | 2520-P | 2620-C | | | | | 2930-FS20 | | | | | |
| | 2522-P | 2622-C | | | | | 2930-FS22 | | | | | |
| | 2524-P | 2624-C | | | | | 2930-FS24 | | | | | |
| | 2526-P | 2626-C | | | | | 2930-FS26 | | | | | |
| 4-Pole, 4-Wire | | | | | | | | | | | | |
| | 2530-P | 2630-C | | | | | 2930-FS30 | | | | | |
| 4-Pole, 4-Wire Non-Grounding | | | | | | | | | | | | |
| | 2528-P | 2628-C | | | | | 2930-FS28 | | | | | |

↑

***Part Number Note for Smart Monitors:**

PLUGS (-PXX)

PML
Perma-Link® Style

PMGL
Perma-Grip™ Style

PW6PL
Perma-Tite®2 Style

CONNECTORS (-CXX)

CML
Perma-Link® Style

CMGL
Perma-Grip™ Style

CW6PL
Perma-Tite®2 Style

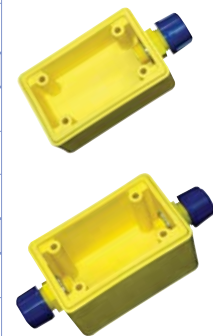

MANY ERICSON PRODUCTS ARE LISTED OR CERTIFIED.
 FOR THE LATEST FULL SEARCHABLE LISTING BY PART NUMBER, GO TO: WWW.ERICSON.COM/AGENCY
 Note: Products shown on this page may not be listed.

SmartMonitor™ Series

SmartMonitor™ Plugs & Connectors Constantly Monitors These Conditions:

- No Ground • Loss of Ground In Cord • Hot/Neutral Swap • Reverse Polarity • Hot on Ground • Open Neutral

Features Of All SmartMonitor™ Plugs & Connectors:

- Super Bright LED Technology
- SmartMonitor™ Module
- Keyed body and cover
- Easy to wire
- Clear internal wiring cover
- Non-slip finger grips
- Color coded terminal screws
- Multiple cord grommets included
- Rubberized outer body
- Safety Yellow and Blue body

ERICSON EXCLUSIVE

"LIKE HAVING A METER IN EVERY PLUG..."

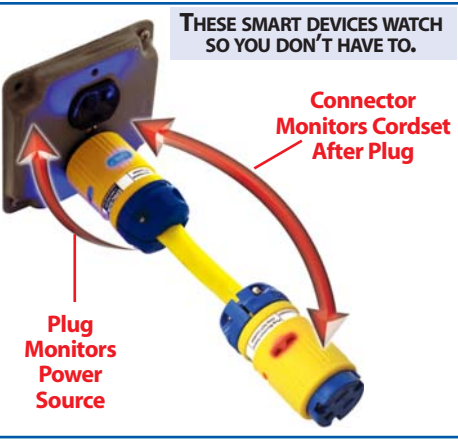
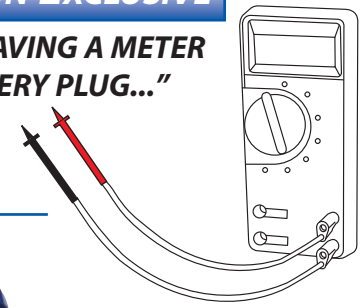

BLUE
OK TO USE



LEDs light up to let you know power is O.K.



24/7
Monitoring

- No Ground
- Loss of Ground In Cord
- Hot/Neutral Swap
- Reverse Polarity
- Hot on Ground
- Open Neutral

RED
STOP, CALL AN ELECTRICIAN!



LEDs light up to let you know there is a problem

How It Works - Diagnostic Safety Cords

Economy Safe Cords



Cordset is OK to Use

- Safety earth ground is OK
- power polarity is OK

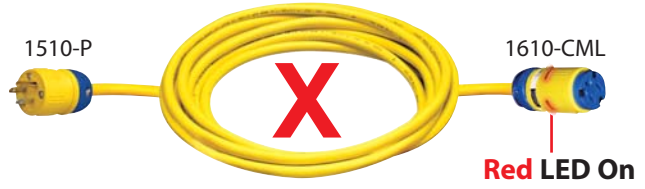

Do Not Use

- Check power source for proper wiring and ground
- Check cord for cuts, nicks etc.
- Check plug wiring
- Check connector wiring

Full Diagnostic Safety Cords*



Do Not Use

- Source power is OK
- Check cord for cuts, nicks etc.
- Check connector wiring



Do Not Use

- Check power source for wiring or missing earth ground

* Full diagnostic safety cords give easy-to-understand indications which saves time tracking down electrical safety issues.

**This device does not diagnose any tool internal issues. This device is an indication that the power and safety earth ground are present.

Using SmartMonitor™ with Tool Cords

Blue OK to use tool**

Red STOP!

- Check power source for wiring or missing earth ground
- Check for miswired receptacle



Cord Clamp Style



Perma-Link™ Cord Clamp Style Features:

- Internal cord seal
- Dual screw self-centering clamp
- Rubberized outer body

XXXX-PML

Cord Grip Style



Perma-Grip™ Cord Grip Nut Style Features:

- Nickel plated solid brass blades
- Super sealing cord grip nut design



XXXX-PMGL

Water Tight Style



Perma-Tite2™ All Weather Cord Grip Nut Style features:

- All weather - NEMA 6P rated
- Super sealing rings
- Nickel plated solid brass blades
- Super sealing cord grip nut design
- Connector includes cover
- 360° indication

XXXX-CW6PL

Plug & Connector Selection Guide

| Face View | NEMA Configuration | Electrical Ratings | | Perma-Link® | | Perma-Grip® | | Perma-Tite® 2 | |
|---|--------------------|--------------------|-------|-------------|------------|-------------|------------|---------------|------------|
| | | Amps | Volts | Plugs | Connectors | Plugs | Connectors | Plugs | Connectors |
| Straight Blade, 2-pole, 3-wire Grounding Devices | | | | | | | | | |
| | 5-15 | 15 | 125 | 1510-PML | 1610-CML | 1510-PMGL | 1610-CMGL | 1510-PW6PL | 1610-CW6PL |
| | 5-20 | 20 | 125 | 1512-PML | 1612-CML | 1512-PMGL | 1612-CMGL | 1512-PW6PL | 1612-CW6PL |
| Locking, 2-pole, 3-wire Grounding | | | | | | | | | |
| | L5-20 | 20 | 125 | 2310-PML | 2410-CML | 2310-PMGL | 2410-CMGL | 2310PW6PL | 2410-CW6PL |
| | L5-15 | 15 | 125 | 1520-PML | 1620-CML | 1520-PMGL | 1620-CMGL | 1520-PW6PL | 1620-CW6PL |

New From Ericson... Industrial application SmartCords factory built to last and last. Models with Smart Connector (Economy Safe) and both Smart Plug and Connector are available. 24/7 monitoring with Assured Grounding Compliance to NEC and OSHA standards. Built with the highest quality materials to withstand your environment.



1510PML123A shown

Cord

Tough 600V rated SOW cordage for long lasting wear

SmartMonitor™ Connector

Checks entire cordset from the plug to the connector

Cordset Selection Guide

| Economy Safe SmartCords P/N* | Length | Non-smart PLUG | Smart Connector | Cord Size | Rating |
|--|--------------------------|----------------|-----------------|-----------|--------|
| 1610XXX143 | A = 25ft B= 50Ft D=100ft | 1510-__ | 1610-__L | #14/3 SOW | 15A |
| 1610XXX123 | | 1510-__ | 1610-__L | #12/3 SOW | 15A |
| 1612XXX123 | | 1510-__ | 1610-__L | #12/3 SOW | 20A |
| 2410XXX123 | | 2310-__ | 2410-__L | #12/3 SOW | 20A |
| Note: plug and connector type will be based on selection made of the master cordset part number - style will match | | | | | |
| Full Diagnostic Safety SmartCords P/N** | Length | Smart PLUG | Smart Connector | Cord Size | Rating |
| 1510XXX143 | A = 25ft B= 50Ft D=100ft | 1510-__L | 1610-__L | #14/3 SOW | 15A |
| 1510XXX123 | | 1510-__L | 1610-__L | #12/3 SOW | 15A |
| 1512XXX123 | | 1512-__L | 1610-__L | #12/3 SOW | 20A |
| 2310XXX123 | | 2310-__L | 2410-__L | #12/3 SOW | 20A |
| Note: plug and connector type will be based on selection made of the master cordset part number | | | | | |

* Replace XXX with: (Economy Cordsets Only)

CML = PermaLink Style Light Industrial Wiring Devices (non-smart Plug and Smart Connector installed)

CMGL = PermaGrip Style Industrial Wiring Devices with nickel plated blades (non-smart Plug and Smart Connector installed)

CW6PL = PermaTite Style Industrial All-Weather Wiring Devices (non-smart Plug and Smart Connector installed)

** Replace XXX with: (Full Diag Cordsets Only)

PML = PermaLink Style Light Industrial Wiring Devices (Smart Plug and Smart Connector installed)

PMGL = PermaGrip Style Industrial Wiring Devices with nickel plated blades (Smart Plug and Smart Connector installed)

PW6PL = PermaTite Style Industrial All-Weather Wiring Devices (Smart Plug and Smart Connector installed)



MANY ERICSON PRODUCTS ARE LISTED OR CERTIFIED.

FOR THE LATEST FULL SEARCHABLE LISTING BY PART NUMBER, GO TO: WWW.ERICSON.COM/AGENCY

Note: Products shown on this page may not be listed.



Perma-Tite® 2 Devices - Extreme Conditions

PERMA-TITE® 2 Plugs and Connectors

Perma-Tite®2 plugs and connectors are engineered and manufactured to the highest quality standards to provide the ultimate in electrical service and protection. They are designed and proven to do their best under the worst conditions in a broad array of the most severe food processing, industrial, marine, construction and petro-chemical work environments.

- UL Listed & CSA Certified, some ETL Listed
- Tongue & groove sealing system provides environmental protection of:
 - NEMA Type 4, 4X, 6, 6P & IP67
- Devices resist high-pressure hose down of 1,500 psi.
- Plug & Connector bodies made with PBT chosen for its high resistance to moisture absorption, high voltage arcing and carbon tracking
- Keyed body and cover for easy alignment/assembly
- Color coded sealing bushings are provided to fit a variety of cord diameters
- Removable/replaceable self-retained sealing cap provided with connector to keep out contaminants when not in use
- Nickel plated blades for corrosion resistance
- Transparent back-plate makes for quick visual wiring checks
- Ericson's new brilliant Blue and Radiant Yellow High Visibility Dual Color Safety System symbolizes that legendary Ericson Quality



All Black Available



NEMA TYPE 4, 4X, 6, 6P & IP67

- Excels in demanding outdoor & in-plant environments
- Resists hose directed water, the entry of water during prolonged submersion at a limited depth & damage from external ice formation

Typical Applications

- Food processing
- Pulp and paper mills
- Refineries and Petro Chem Facilities
- Ship yards
- Utilities
- Marine



| | |
|--|---|
| 16CW  Connector Cover Available | 15PW  Plug Cover Available |
|--|---|

PERMA-TITE® 2

EXTRA GROMMETS Color coded rubber cord sealer grommets supplied for a variety of diameters.

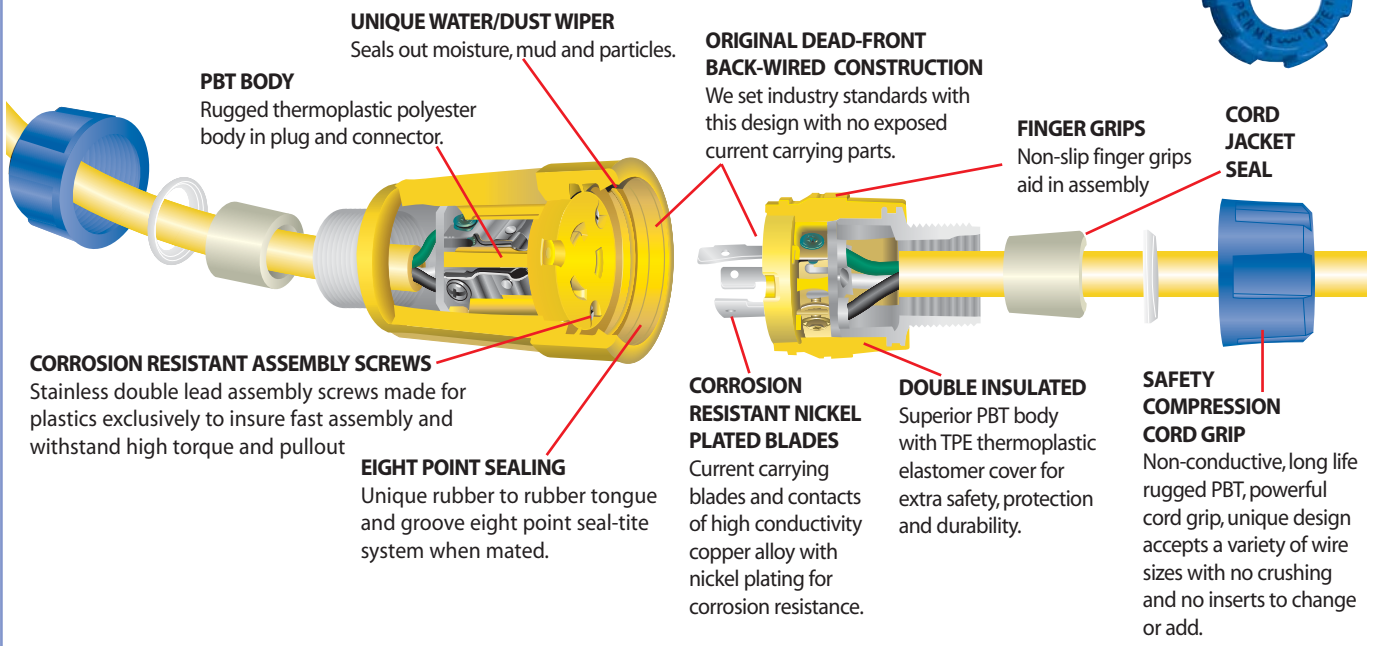

Note: Add - BLK for all black as available.



ERICSON EXCLUSIVE

PERMA-GRIP™ Plugs and Connectors

Ericson's industry exclusive design combines the Perma-Tite® cord grip with the industry proven design of its Perma-Link® devices to provide a line of **incredibly tough plugs and connectors** that stand up to the most demanding industrial and construction environments.

- UL Listed and CSA Certified, some ETL Listed
- Quick field assembly, no cable clamp screws to tighten, simply twist on the cord grip nut
- Water/mud/dust resistance provided by safety compression cord grips
- Keyed body and cover for easy alignment/assembly
- Color coded rubber cord-seal bushings accommodate a wide range of cable diameters
- Molded-in non-slip fingers grips makes devices easy to assemble and handle
- Withstand high impact, corrosion, oils, greases, solvents and other chemicals across -20 °C - +65 °C
- Nickel plated brass blades and ground pin stops corrosion and keeps solid electrical contact

- Individual wire pockets help prevent flashovers
- Transparent back plate speeds wiring inspection
- Selected models available with Ground Continuity Monitor
- Available individually or on factory assembled cord sets
- Flexibility of reverse-cover design (straight blade devices) creates weather-resistant connections by interchanging covers
- Ericson's exclusive Brilliant Blue and Radiant Yellow High Visibility Dual Color Safety System



Complete Kit as Shown

FEATURE

Safety Compression Cord Grip

Non-conductive, long life rugged PBT, powerful cord grip, unique design accepts all AWG wire range sizes from #18 through #12 with no crushing and no inserts to change or add

High-Visibility Safety Colors
Added safety in dull work areas With Brilliant Blue and Radiant Yellow colors.

Transparent Back Plate

Clear polycarbonate permits visual wiring inspection without disassembly

FEATURE!

Internal Cord Seal
Built-in cord entrance seal in cover seals out moisture and most foreign material that can cause short circuit.

Keyed PBT Body

Adds to quick alignment and assembly.

Double Insulated

Superior PBT body with TPE thermoplastic elastomer cover for extra safety, protection and durability.

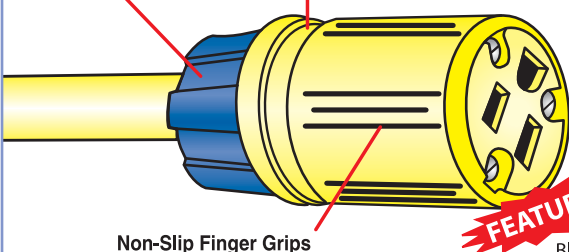

NEW! Combo Head

Blades nickel plated to prevent corrosion

NEW!

Combo Head

NEW!

Combo Head

NEW!

Combo Head

NEW!

Combo Head

NEW!

Combo Head

NEW!

Combo Head

NEW!

Combo Head

NEW!

Combo Head

NEW!

Combo Head

NEW!

Combo Head

NEW!

Combo Head

NEW!

Combo Head

NEW!

Combo Head

Captive Assembly Screws

Double lead screws provide rigid assembly, no bulging of cover, maximum pull out resistance, fast assembly.

Individual Wire Chambers

Accepts up to #12 AWG conductors and prevents flash overs and short circuits.

EXTRA GROMMETS Color coded rubber cord sealer grommets supplied for a variety of diameters.



Dead-Front Back-Wired Design

We set industry standards with this design, no exposed current carrying parts, meets NEC article #410-56 (d).

Note: Add - BLK for all black as available.



MANY ERICSON PRODUCTS ARE LISTED OR CERTIFIED.

FOR THE LATEST FULL SEARCHABLE LISTING BY PART NUMBER, GO TO: WWW.ERICSON.COM/AGENCY

Note: Products shown on this page may not be listed.





PERMA-LINK® Plugs and Connectors

United States patent number 4,021,092 was assigned to today's Perma-Link® plugs and connectors which are classified among the most rugged and safest wiring devices available. They incorporate many of the same features as Ericson Perma-Tite® 2 and Perma-Grip™ devices and utilize a two-screw cable clamp. Perma-Link® plugs and connectors are designed to provide many years of trouble-free service in the most demanding industrial and construction environments.

- UL Listed and CSA Certified
- Two-screw cable clamp secures wire and provides strain-relief
- Solid brass blades for optimum electrical and mechanical performance
- Keyed body and cover for easy alignment/assembly
- Molded-in non-slip finger-grips makes devices easy to assemble and handle
- Withstand high impact, corrosion, oils, greases, solvents and other chemicals across -20 °C to 100 °C
- Individual wire pockets help prevent flashovers
- Transparent back plate speeds wiring inspection
- Selected models available with Ground Continuity Monitor
- Available individually or on factory assembled cord sets
- Flexibility of reverse-cover design creates weather-resistant connections by interchanging covers
- Ericson's exclusive Brilliant Blue and Radiant Yellow High Visibility Dual Color Safety System

All Black Available

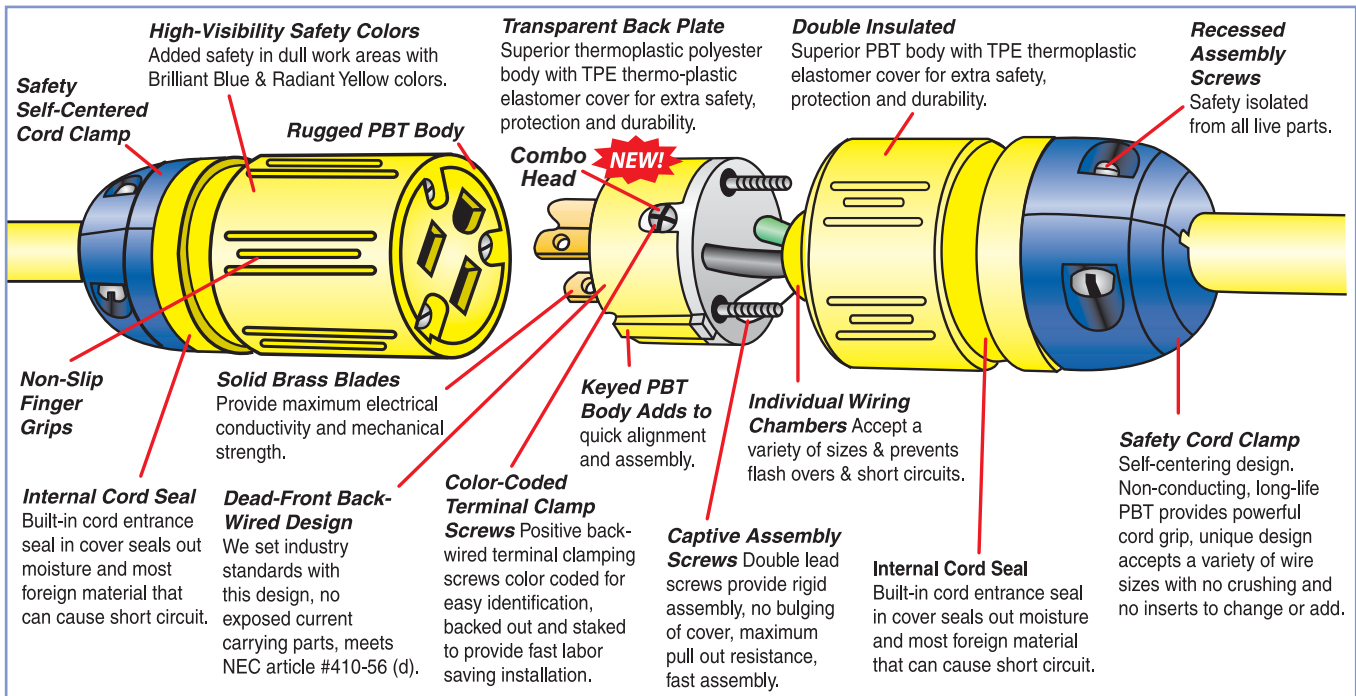
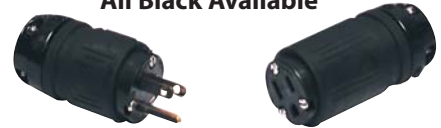

Note: Add - BLK for all black as available.



Versatile Weather-Resistant Field Conversion

Our Perma-Link® plugs and connectors (as listed below) are designed so they can easily be converted to create weather-resistant connections by interchanging the internal assemblies. Insert the plug body into the connector cover, and the connector body into the plug cover. There are no extra parts to purchase.

Step 1:

Disassemble The Plug & Connector As Shown

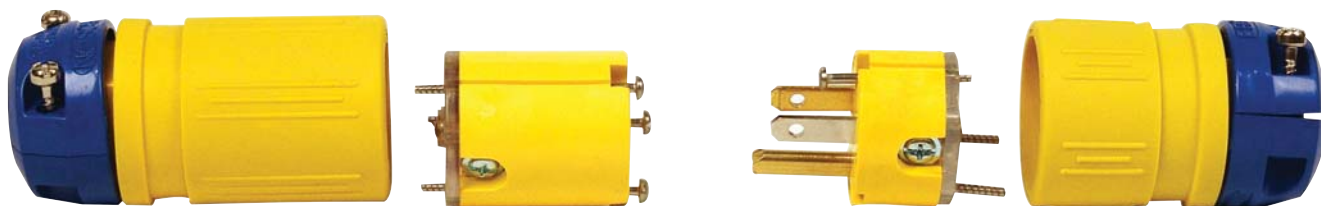

Step 2:

Swap Plug & Connector Assemblies

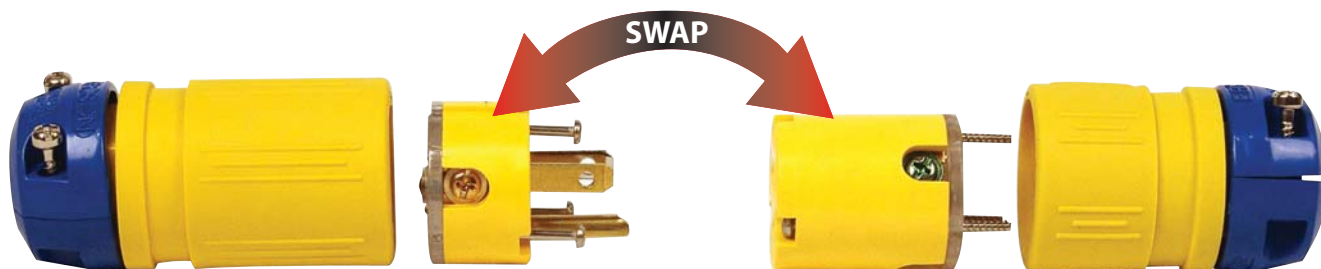

Step 3:

Assemble Cords Per Bag Instructions

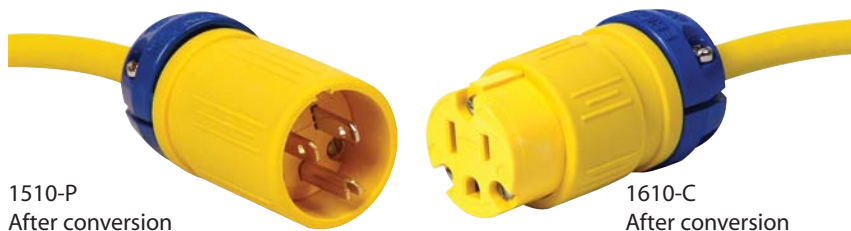

1510-P
After conversion

1610-C
After conversion

| Convertible Parts | |
|-------------------|--------|
| 1510-P | 1610-C |
| 1512-P | 1612-C |
| 1514-P | 1614-C |



**Now Your Perma-Link® Plugs & Connectors
Are More Weather Resistant!**



MANY ERICSON PRODUCTS ARE LISTED OR CERTIFIED.
FOR THE LATEST FULL SEARCHABLE LISTING BY PART NUMBER, GO TO: WWW.ERICSON.COM/AGENCY
Note: Products shown on this page may not be listed.



“Crowsfoot” Devices - Non-NEMA

This Non-NEMA configuration, commonly called the “crowsfoot”, is widely used in critical applications that require equipment to be plugged into a specific electrical system to ensure proper function or to prevent equipment damage.

Typical Applications

- Low-voltage hand lamps and matching transformers
- Data acquisition/logging equipment to detect level and flow measurements on tanks and valves
- Sensitive electronic equipment that must be used on voltage regulated circuits

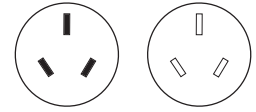

Features Guide

- Plug and connector bodies made with PBT chosen for its high resistance to moisture absorption, high voltage arcing and carbon tracking.
- Transparent back-plate makes for quick visual wiring checks.
- Keyed body and cover for easy alignment/assembly.
- Color-coded sealing bushings are provided to fit a variety of cord diameters.
- Perma-Tite® 2 devices have the eight-point rubber tongue and groove sealing system to provide environmental protection.
- Rubber sealing cap provided with Perma-Tite® 2 connector to keep out contaminants when not in use.
- Optional plug cover available - order catalog number 15PW.
- Ericson's exclusive Brilliant Blue and Radiant Yellow High Visibility Dual Color Safety System.
- Perma-Tite® 2 devices rated NEMA 4, 4X, 6, 6P & IP67.

PERMA-GRIP™ plug and connector with industry exclusive cord grip nut for rapid field assembly



1607-CG

1507-PG



1507-PW6P



1607-CW6P

Perma-Grip™ & Perma-Tite®2 plugs & connectors come with color coded rubber cord seal bushings for a variety of cable diameters.

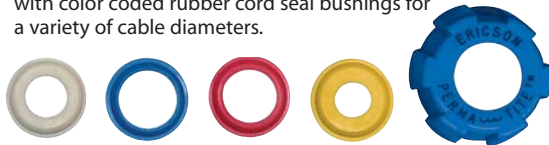

PERMA-TITE® 2 plug and connector

| Face View | NEMA Config. | Electrical Ratings | | Perma-Grip™ | | Perma-Tite® 2 | |
|-----------|--------------|--------------------|------|-------------|---------|---------------|-----------|
| | Non-NEMA | 15A | 125V | 1507-PG | 1607-CG | 1507-PW6P | 1607-CW6P |
| | | 10A | 250V | | | | |



Commercial Grade Plugs & Connectors

The Ericson 5266 and 5269 Series of Commercial Grade plugs offer the latest in design innovation and quality in an economy grade wiring device. The demands of today's electrical industry are met with this new design with features never before seen in a commercial device. Designed to provide years of trouble free service in demanding industrial, construction and rental environments. Available in 2 styles, with and without the power on "glow" module to light up the entire device.

- 2 styles – with and without internal lamp module (see chart)
- Translucent body allows device to glow from power on lamp
- Tough, soft feel, rubber overmold grip surrounds device body
- Wide open "suitcase" style construction makes wiring easy
- Two captive screw body clamp design is easy to assemble
- Cord diameter matching inserts fit a wide range of cord sizes
- Solid brass blades for optimum electrical contact
- Fits 10/3 to 18/3 cord diameters*
- Rugged design withstands abuse on the jobsite
- Clear internal conductor cover allows visual inspection
- Color coded termination screws for ground, hot and neutral
- Combo screw head

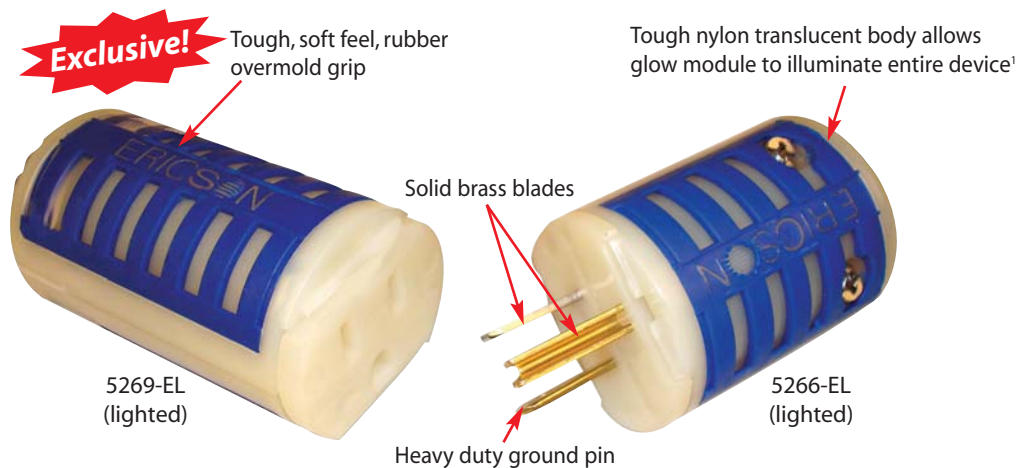



5266-EL Lighted

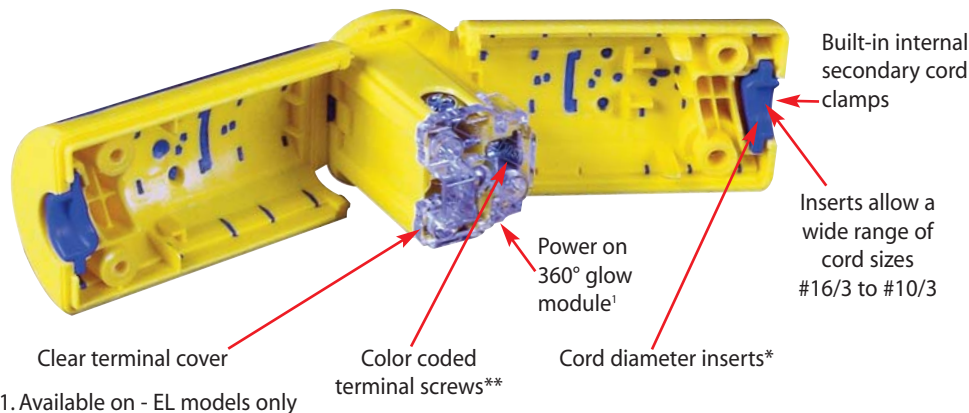

1 Piece Design - EZ To Wire



Devices Selection Guide

| Face View | NEMA Configuration | Electrical Ratings | | With Internal Glow Light | | Without Internal Glow Light | |
|---|--------------------|--------------------|-------|--------------------------|------------|-----------------------------|------------|
| | | Amps | Volts | Plugs | Connectors | Plugs | Connectors |
| Straight Blade, 2-pole, 3-wire Grounding Devices | | | | | | | |
|    | 5-15 | 15 | 125 | 5266-EL | 5269-EL | 5266-E | 5269-E |

Notes:

*Cord diameters - .3 to .6 inch
 **Slot - Phillips



MANY ERICSON PRODUCTS ARE LISTED OR CERTIFIED.
 FOR THE LATEST FULL SEARCHABLE LISTING BY PART NUMBER, GO TO: WWW.ERICSON.COM/AGENCY
 Note: Products shown on this page may not be listed.



Ericson can customize our offering of wiring devices to meet your individual needs. The custom solution can be as simple as the popular printing on the back of the cord grip nut to fully custom colored and labeled product. Minimum order sizes will apply as well as some setup fees. Contact us to discuss your needs and custom design details.



Notes:

- 1. Some customization can void certain agency safety listings or warranty.
- 2. Minimum quantities will apply. Other design and tooling fees may apply.

How to order: Contact you local Ericson Factory Representative or call us at 1-800-Ericson (374-2766)



ERICSONTM
electrical
specialties

*ORIGINATORS OF DEAD-FRONT,
BACK-WIRED PLUG CAPS

PERMA-LINKTM

DOUBLE INSULATED PLUG CAPS AND
CONNECTOR BODIES

Original 1930's Advertisement



MANY ERICSON PRODUCTS ARE LISTED OR CERTIFIED.
FOR THE LATEST FULL SEARCHABLE LISTING BY PART NUMBER, GO TO: WWW.ERICSON.COM/AGENCY
Note: Products shown on this page may not be listed.



All Weather Heavy Duty Wet Location Double Outlet Receptacle with Cover Plates



FEATURES:

- **SafetyFirst™** UL Listed to American and Canadian Standards for wet or damp locations
- Impact, chemical and corrosion resistant
- Superior interior splash and hose down protection
- Exceptional all weather outdoor protection
- Simplified, flexible mounting alternatives
- Secure power access lockout / tagout capability
- Popular NEMA configuration alternatives
- Pre-wired for quick installation
- Rubberized box with stainless steel hardware
- Non-metallic cord grip
- Spring loaded flip covers

Ericson's PWDX Series of all weather, heavy duty double outlet receptacles are ideal for a wide range of demanding applications where splash and hose-down protection is required. A perfect fit for food and liquid processing facilities, the non-metallic enclosure and optional cord grip construction guards against metal and glass fragments that can pose health and safety risks, while the extra deep internally sealed spring-loaded flip covers provide protection when not in use.

The versatile PWDX Series receptacles, when mated with Ericson's Perma-Tite2 plugs, provide NEMA 4X levels of protection against dust, rain, hose/spray, chemical, and snow/ice. The 8-point seal-tite mating design seals around the plug to provide unmatched weather resistance.

Flexible mounting configurations, including pendant, rigid conduit, wall and "stringer" cordset, make this an ideal solution for a wide range of applications including:

- | | | | |
|---------------------------|-----------------------|------------------------|----------------------|
| • Food Processing | • Beverage Processing | • Marina Ship-to-shore | • Petro-Chemical |
| • Vehicle / Engine Heater | • Pulp / Paper Mills | • Utilities | • Refineries |
| • Venue Landscape | • Outdoor Events | • Automotive | • Harsh Environments |



PWDX Series - All Weather Heavy Duty Receptacles

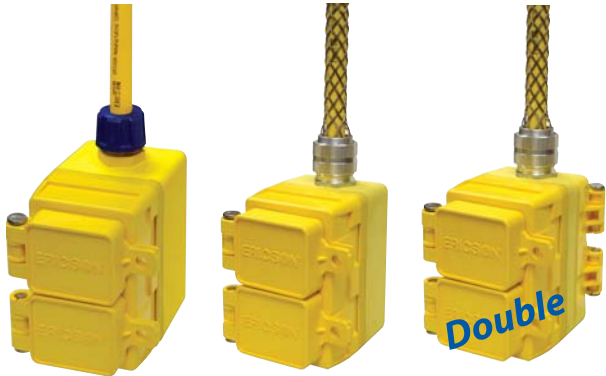

6212NFS Box with 1610-PWDX "pendant non-metallic" style 6234WFS with 1610-PWDX pendant style Double 1610-PWDX on 6234WFT enclosure

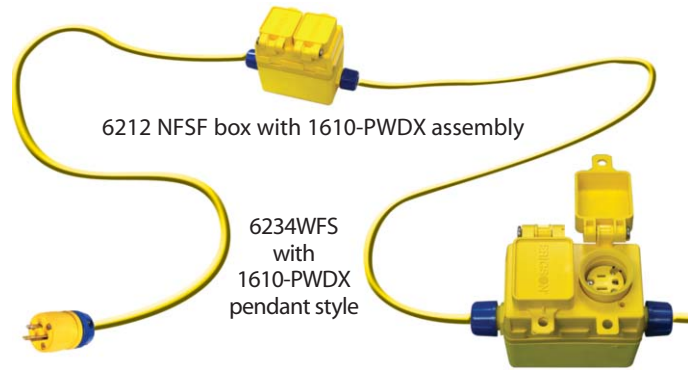

6212 NFSF box with 1610-PWDX assembly

6234WFS with 1610-PWDX pendant style



NOTICE:
 *The NEC restricts the use of metallic "job" boxes for use in temporary relocateable power cords. Only use non-metallic enclosures designed and tested to meet compliance.

| NEMA | NEMA | NEMA | NEMA | NEMA | NEMA | NEMA |
|------------------|------------------|------------------|------------------|------------------|------------------|------------------|
| | | | | | | |
| 1610-PWDX | 1612-PWDX | 1614-PWDX | 1616-PWDX | 1620-PWDX | 1622-PWDX | 1624-PWDX |

| Part Number | Description | NEMA Config | Amps | Volts |
|--|---|-------------|------|-------|
| PWDX Dual Receptacle & Cover Assembly/ Prewired | | | | |
| Straight | | | | |
| 1610-PWDX | Receptacle & Flip Cover, Duplex, All Weather, 5-15 | 5-15 | 15 | 125 |
| 1612-PWDX | Receptacle & Flip Cover, Duplex, All Weather, 5-20 | 5-20 | 20 | 125 |
| 1614-PWDX | Receptacle & Flip Cover, Duplex, All Weather, 6-15 | 6-15 | 15 | 250 |
| 1616-PWDX | Receptacle & Flip Cover, Duplex, All Weather, 6-20 | 6-20 | 20 | 250 |
| Locking | | | | |
| 1620-PWDX | Receptacle & Flip Cover, Duplex, All Weather, L5-15 | L5-15 | 15 | 125 |
| 1622-PWDX | Receptacle & Flip Cover, Duplex, All Weather, L6-15 | L6-15 | 15 | 250 |
| 1624-PWDX | Receptacle & Flip Cover, Duplex, All Weather, L7-15 | L7-15 | 15 | 277 |

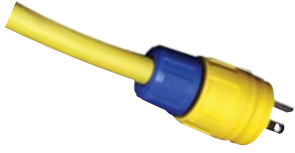

MANY ERICSON PRODUCTS ARE LISTED OR CERTIFIED.
 FOR THE LATEST FULL SEARCHABLE LISTING BY PART NUMBER, GO TO: WWW.ERICSON.COM/AGENCY
 Note: Products shown on this page may not be listed.

| Ericson Perma-Tite®2 Series Mating Plugs | | | |
|--|---------------------------|--|---|
| PWDX Part Number | Mating Plug Perma-Tite 2® | Perma-Tite 2® Series Plug | Plug Bushing Kit |
| 1610-PWDX | 1520-PW6P |  | 82005 - 1/2" Kit  |
| 1612-PWDX | 1512-PW6P | | |
| 1614-PWDX | 1514-PW6P | | |
| 1616-PWDX | 1516-PW6P | | |
| 1620-PWDX | 1520-PW6P | | |
| 1622-PWDX | 1522-PW6P | | |
| 1624-PWDX | 1528-PW6P | | |

| Rubberized FS & FD Boxes | | | |
|---|---|--|---|
|  <p>6212FS</p> |  <p>6234FD</p> |  <p>6234FT</p> |  <p>6234WFS</p> |
|  <p>6212NFS</p> |  <p>6212NFD</p> |  <p>6212NFT</p> |  <p>6212WFD</p> |
|  <p>6234NFS</p> |  <p>6234NFD</p> |  <p>6234NFT</p> |  <p>6234WFT</p> |

| Wall/Post Mount Kit 6260WK | | (NM) Non Metallic Bushing Kits | | Wire Mesh Grips | | |
|---|---|---|--|-----------------|--|---|
| Optional Wall Mount Kit |  | 82034 - 3/4" | 82010 - 1" | | | |
|  | |  |  | | |  |
| | | | | 82005W = 1/2" | | |
| | | | | 82034W = 3/4" | | |
| | | | | 82010W = 1" | | |
| | | | 82005W-1 | | | |
| | | 82034W-1 | | | | |





| Boxes for PWDX - Punched - No Bushing Kit | | | |
|---|---|---|--|
| | Part Number | Description | |
| | 6212FS | Box, Std Depth, PWDX, No bushing, 1/2" NPT | |
| | 6234FS | Box, Std Depth, PWDX, No bushing, 3/4" NPT | |
| | 6210FS | Box, Std Depth, PWDX, No bushing, 1" NPT | |
| | 6212FD | Box, Deep, PWDX, No bushing, 1/2" NPT | |
| | 6234FD | Box, Deep, PWDX, No bushing, 3/4" NPT | |
| | 6210FD | Box, Deep, PWDX, No bushing, 1" NPT | |
| | 6212FT | Box, OPEN, PWDX, No bushing, 1/2" NPT | |
| | 6234FT | Box, OPEN, PWDX, No bushing, 3/4" NPT | |
| | 6210FT | Box, OPEN, PWDX, No bushing, 1" NPT | |
| | 6212FSF | Box, Std Depth, PWDX, No Bushing, Feed thru, 1/2" NPT | |
| | 6234FSF | Box, Std Depth, PWDX, No Bushing, Feed thru, 3/4" NPT | |
| | 6210FSF | Box, Std Depth, PWDX, No Bushing, Feed thru, 1" NPT | |
| | 6212FDF | Box, Deep, PWDX, No Bushing, Feed thru, 1/2" NPT | |
| | 6234FDF | Box, Deep, PWDX, No Bushing, Feed thru, 3/4" NPT | |
| | 6210FDF | Box, Deep, PWDX, No Bushing, Feed thru, 1" NPT | |
| | 6212FTF | Box, OPEN, PWDX, No Bushing, Feed thru, 1/2" NPT | |
| 6234FTF | Box, OPEN, PWDX, No Bushing, Feed thru, 3/4" NPT | | |
| 6210FTF | Box, OPEN, PWDX, No Bushing, Feed thru, 1" NPT | | |
| Boxes for PWDX - 1/2" NPT Bushing Installed (N = Non Metallic W = Wire Mesh) | | | |
| | 6212NFS | Box, Std Depth, PWDX, NM Bushing, 1/2" NPT | |
| | 6212NFD | Box, Deep, PWDX, NM Bushing, 1/2" NPT | |
| | 6212NFT | Box, OPEN, PWDX, NM Bushing, 1/2" NPT | |
| | 6212NFSF | Box, Std Depth, PWDX, NM Bushing, Feed thru, 1/2" NPT | |
| | 6212NFDF | Box, Deep, PWDX, NM Bushing, Feed thru, 1/2" NPT | |
| | 6212NFTF | Box, OPEN, PWDX, NM Bushing, Feed thru, 1/2" NPT | |
| | 6212WFS | Box, Std Depth, PWDX, WireMesh Bushing, 1/2" NPT | |
| | 6212WFD | Box, Deep, PWDX, WireMesh Bushing, 1/2" NPT | |
| | 6212WFT | Box, OPEN, PWDX, WireMesh Bushing, 1/2" NPT | |
| | 6212WFSF | Box, Std Depth, PWDX, WireMesh Bushing, Feed thru, 1/2" NPT | |
| | 6212WFDF | Box, Deep, PWDX, WireMesh Bushing, Feed thru, 1/2" NPT | |
| | 6212WFTF | Box, OPEN, PWDX, WireMesh Bushing, Feed thru, 1/2" NPT | |
| | Boxes for PWDX - 3/4" NPT Bushing Installed (N = Non Metallic W = Wire Mesh) | | |
| | 6234NFS | Box, Std Depth, PWDX, NM Bushing, 3/4" NPT | |
| | 6234NFD | Box, Deep, PWDX, NM Bushing, 3/4" NPT | |
| | 6234NFT | Box, OPEN, PWDX, NM Bushing, 3/4" NPT | |
| | 6234NFSF | Box, Std Depth, PWDX, NM Bushing, Feed thru, 3/4" NPT | |
| | 6234NFDF | Box, Deep, PWDX, NM Bushing, Feed thru, 3/4" NPT | |
| | 6234NFTF | Box, OPEN, PWDX, NM Bushing, Feed thru, 3/4" NPT | |
| | 6234WFS | Box, Std Depth, PWDX, WireMesh Bushing, 3/4" NPT | |
| 6234WFD | Box, Deep, PWDX, WireMesh Bushing, 3/4" NPT | | |
| 6234WFT | Box, OPEN, PWDX, WireMesh Bushing, 3/4" NPT | | |
| 6234WFSF | Box, Std Depth, PWDX, WireMesh Bushing, Feed thru, 3/4" NPT | | |
| 6234WFDF | Box, Deep, PWDX, WireMesh Bushing, Feed thru, 3/4" NPT | | |
| 6234WFTF | Box, OPEN, PWDX, WireMesh Bushing, Feed thru, 3/4" NPT | | |
| Boxes for PWDX - 1" NPT Bushing Installed (N = Non Metallic W = Wire Mesh) | | | |
| 6210NFS | Box, Std Depth, PWDX, NM Bushing, 1" NPT | | |
| 6210NFD | Box, Deep, PWDX, NM Bushing, 1" NPT | | |
| 6210NFT | Box, OPEN, PWDX, NM Bushing, 1" NPT | | |
| 6210NFSF | Box, Std Depth, PWDX, NM Bushing, Feed thru, 1" NPT | | |
| 6210NFDF | Box, Deep, PWDX, NM Bushing, Feed thru, 1" NPT | | |
| 6210NFTF | Box, OPEN, PWDX, NM Bushing, Feed thru, 1" NPT | | |
| 6210WFS | Box, Std Depth, PWDX, WireMesh Bushing, 1" NPT | | |
| 6210WFD | Box, Deep, PWDX, WireMesh Bushing, 1" NPT | | |
| 6210WFT | Box, OPEN, PWDX, WireMesh Bushing, 1" NPT | | |
| 6210WFSF | Box, Std Depth, PWDX, WireMesh Bushing, Feed thru, 1" NPT | | |
| 6210WFDF | Box, Deep, PWDX, WireMesh Bushing, Feed thru, 1" NPT | | |
| 6210WFTF | Box, OPEN, PWDX, WireMesh Bushing, Feed thru, 1" NPT | | |



MANY ERICSON PRODUCTS ARE LISTED OR CERTIFIED.
 FOR THE LATEST FULL SEARCHABLE LISTING BY PART NUMBER, GO TO: WWW.ERICSON.COM/AGENCY
 Note: Products shown on this page may not be listed.



PERMA-TITE®2 Single Outlet Receptacle with Cover Plates - FS Series

- Weather resistant boot seals around Ericson Perma-Tite plug to provide weather resistant protection
- Spring-loaded flip-lid covers receptacle when not in use
- Includes cover plate, rubber boot, stainless steel mounting plate/mounting screws
- Impact, chemical & corrosion resistant construction stands up to demanding environments
- Mounts easily to any FS and FD boxes and any flat surface

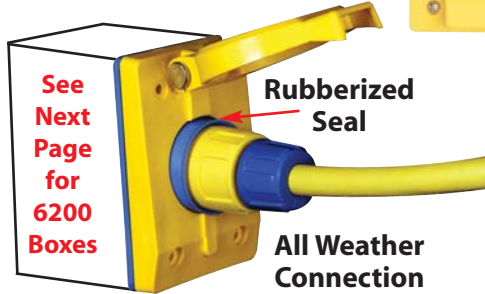
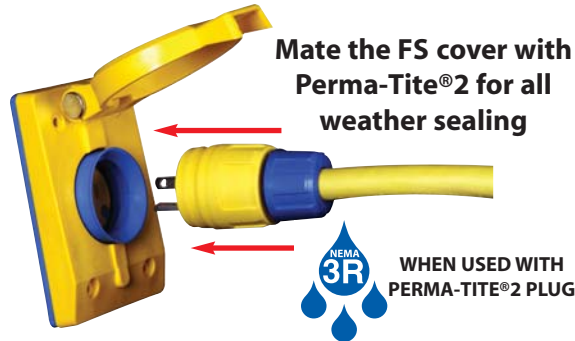

Also Available in:

- Green
- Black
- Sand



PERMA-TITE®2 Single Outlet Cover Plates - FS Series

| Face View | NEMA Configuration | Electrical Ratings | | FS Female Receptacle | 2705 Male Inlet Std Opening | 2705 Male Inlet Large Opening |
|--|--------------------|--------------------|-----------------------|------------------------------|-----------------------------|-------------------------------|
| | | Amps | Volts | | | |
| 15A Straight Blade & Locking 20A Straight Blade | | | | | | |
| Flip Seal Cover w/ weatherproof boot only | | | | 2700-FS⁽¹⁾ | 1 7/16" Dia. | 2" Dia. |
| | Non-NEMA | 10/15 Amp | 125/250 Volt | 2715FS07 | | |
| | 5-15 | 15 Amp | 125 Volt | 2715-FS10 | 2705-15 | 2705-15A |
| | 5-20 | 20 Amp | 125 Volt | 2715-FS12 | 2705-20 | 2705-20A |
| | 6-15 | 15 Amp | 250 Volt | 2715-FS14 | | |
| | 6-20 | 20 Amp | 250 Volt | 2715-FS16 | | |
| | L5-15 | 15 Amp | 125 Volt | 2715-FS20 | 2705-L15 | 2705-L15A |
| | L6-15 | 15 Amp | 250 Volt | 2715-FS22 | | |
| | L7-15 | 15 Amp | 277 Volt | 2715-FS24 | | |
| 20A & 30A Locking, 3-Wire | | | | | | |
| Flip Seal Cover w/ weatherproof boot only | | | | 2800-FS⁽¹⁾ | 2 1/8" Dia. | |
| | L5-20 | 20 Amp | 125 Volt | 2820-FS10 | 2705-L20 | |
| | L6-20 | 20 Amp | 250 Volt | 2820-FS12 | | |
| | L7-20 | 20 Amp | 277 Volt | 2820-FS14 | | |
| | Non-NEMA | 20 Amp | 125/250 Volt | 2820-FS16 | | |
| | Non-NEMA | 20 Amp/10 Amp | 250 Volt/600 Volt | 2820-FS17 | | |
| | L5-30 | 30 Amp | 125 Volt | 2830-FS10 | | |
| | L6-30 | 30 Amp | 250 Volt | 2830-FS12 | | |
| | L7-30 | 30 Amp | 277 Volt | 2830-FS14 | | |
| | Non-NEMA | 30 Amp | 125/250 Volt | 2830-FS16 | | |
| 20A & 30A Locking, 4-Wire | | | | | | |
| Flip Seal Cover w/ weatherproof boot only | | | | 2900-FS⁽¹⁾ | 2 1/8" Dia. | |
| | L14-20 | 20 Amp | 125/250 Volt | 2920-FS20 | 2705-L142 | |
| | L15-20 | 20 Amp | 250 Volt, 3 ø | 2920-FS22 | | |
| | L16-20 | 20 Amp | 480 Volt, 3 ø | 2920-FS24 | 2705-L162 | |
| | L14-30 | 30 Amp | 125/250 Volt | 2930-FS20 | | |
| | L15-30 | 30 Amp | 250 Volt, 3 ø | 2930-FS22 | | |
| | L16-30 | 30 Amp | 480 Volt, 3 ø | 2930-FS24 | | |
| | L17-30 | 30 Amp | 600 Volt, 3 ø | 2930-FS26 | | |
| | L18-30 | 30 Amp | 120/208 Volt, 3 ø wye | 2930-FS30 | | |
| | Non-NEMA | 30 Amp | 120/208 Volt, 3 ø wye | 2930-FS28 | | |

NOTES:

1. Does not include receptacle. Use with standard receptacles of same electrical ratings.



Single Male Inlet Assemblies with Cover Plates - 2705 FS Series

- Weather resistant boot seals around the connector to provide weather resistant protection
- Spring-loaded flip-lid covers inlet when not in use
- Includes cover plate, rubber boot, stainless steel mounting plate/mounting screws
- Impact, chemical & corrosion resistant construction stands up to demanding environments
- Mounts easily to any 6200 series FS/FD boxes or any flat surface
- Spring Loaded SS hardware flip cover



Application Notes:

The 2705 FS series of male inlets is designed for all weather power inlet on a variety of applications. The heavy duty flip cover assembly and superior round sealing collar provides a superior seal against the elements. Use for inlet power only. Never use these devices for power output or receptacle. These devices must be wired dead and cannot be accidentally energized without a connector in place.

- Power inlet for powered food trolley carts
- Power charging inlet for fire trucks, ambulances and electric service vehicles
- Power charging port for electric battery cars or golf carts
- Power inlet for machines in tough environments
- Power inlet for portable temporary power panels



Also available in all black or customized - call Ericson for details

6200 Series Boxes for FS Series Mounting

| Part Number | Description |
|---|--|
| 6212FSK | Box, Std Depth, No bushing, 1/2" NPT |
| 6234FSK | Box, Std Depth, No bushing, 3/4" NPT |
| 6210FSK | Box, Std Depth, No bushing, 1" NPT |
| 6212FDK | Box, Deep, No bushing, 1/2" NPT |
| 6234FDK | Box, Deep, No bushing, 3/4" NPT |
| 6210FDK | Box, Deep, No bushing, 1" NPT |
| Boxes for 2705 - 1/2" NPT Bushing Installed (N=Non Metallic W = Wire Mesh) | |
| 6212NFSK | Box, Std Depth, NM Bushing, 1/2" NPT |
| 6212NFDK | Box, Deep, NM Bushing, 1/2" NPT |
| 6212WFSK | Box, Std Depth, WireMesh Bushing, 1/2" NPT |
| 6212WFDK | Box, Deep, WireMesh Bushing, 1/2" NPT |
| 6234NFSK | Box, Std Depth, NM Bushing, 3/4" NPT |
| 6234NFDK | Box, Deep, NM Bushing, 3/4" NPT |
| 6234WFSK | Box, Std Depth, WireMesh Bushing, 3/4" NPT |
| 6234WFDK | Box, Deep, WireMesh Bushing, 3/4" NPT |
| 6210NFSK | Box, Std Depth, NM Bushing, 1" NPT |
| 6210NFDK | Box, Deep, NM Bushing, 1" NPT |
| 6210NFTK | Box, OPEN, NM Bushing, 1" NPT |
| 6210WFSK | Box, Std Depth, WireMesh Bushing, 1" NPT |
| 6210WFDK | Box, Deep, WireMesh Bushing, 1" NPT |
| 6210WFTK | Box, OPEN, WireMesh Bushing, 1" NPT |

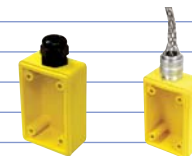
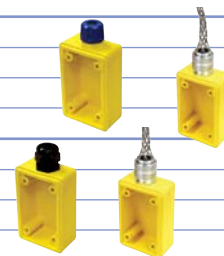

MANY ERICSON PRODUCTS ARE LISTED OR CERTIFIED.

FOR THE LATEST FULL SEARCHABLE LISTING BY PART NUMBER, GO TO: WWW.ERICSON.COM/AGENCY

Note: Products shown on this page may not be listed.

Physical Box Sizes

FT Feed Thru Box

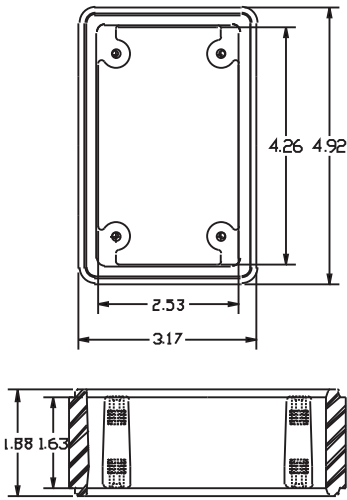

FD Deep Box

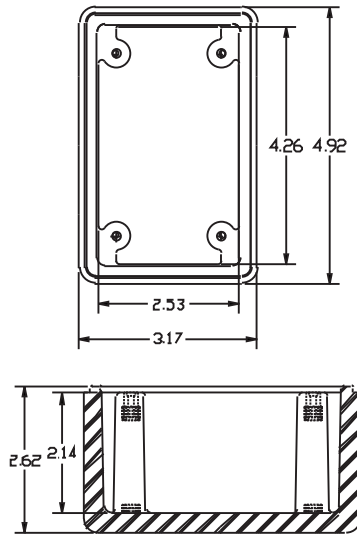

FS Standard Box

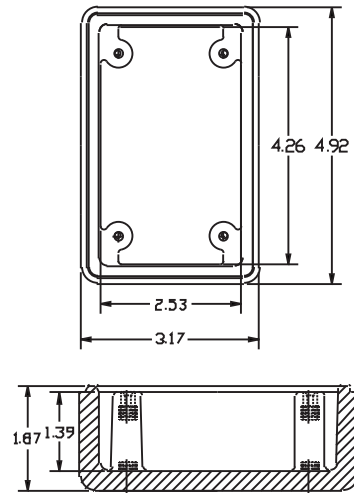

Mounting Templates

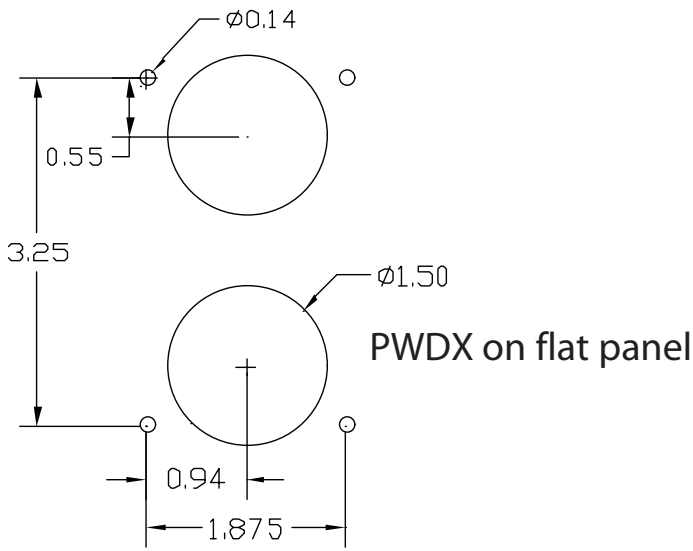

6260 WK Wall Kit

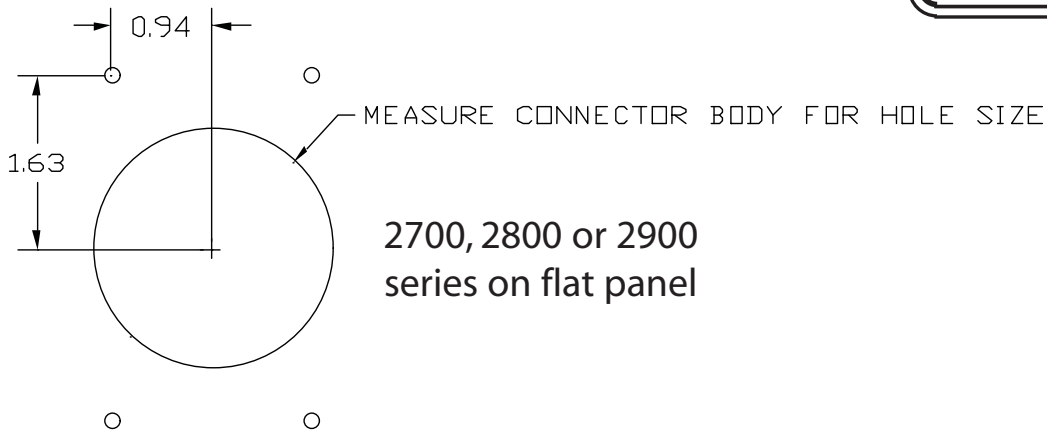
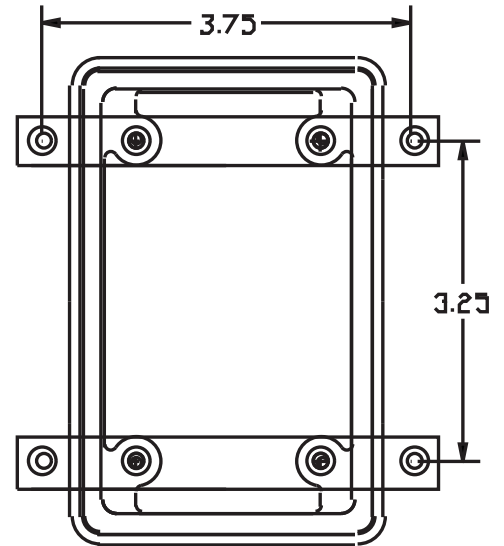



NEMA Configuration Adapters

Now make quick, secure connections between straight-blade and locking plugs and connectors with Ericson's NEMA configuration adapters.

- Heavy-duty non-conducting housing and using heavy gauge solid brass blades
- Compact size makes them easy to use and transport
- Available in four of the most popular models

NEMA Configuration Adapters Selection Guide



123-15P20C

123-20P15C

| Catalog Number | NEMA Configuration | | Description |
|----------------|--------------------|--------|---|
| | Male | Female | |
| 1705 | | | Male 15A, 125V twist (L5-15P) to 20A, 125V straight (5-20R) |
| 1712 | | | Male 15A, 125V straight (5-15P) to 15A, 125V twist (L5-15R) |
| 1740 | | | Male 20A, 125V twist (L5-20P) to 20A, 125V straight (5-20R) |
| 1744 | | | Male 15A, 125V straight (5-15P) to 20A, 125V twist (L5-20R) |
| 123-20P15C | | | Male 20A, 125V twist (L5-20P) to 15A, 125V straight (5-15R) |
| 123-15P20C | | | Male 15A, 125V straight (5-15P) to 20A, 125V twist (L5-20R) |

PERMA-TITE® 2 Plug Cover

- Use with Ericson's Perma-Tite® plugs to seal out water, dust and other contaminants and to protect blades from damage when plug is not in-use
- Eight-point rubber tongue and groove sealing system provides environmental protection
- Additional protection provided by a unique internal water/dust wiper
- Easy to assemble
- Ericson's Radiant Yellow for High Visibility on job sites



15PW with 1510-PW6P Plug

PERMA-TITE® 2 Plug Cover Selection Guide

| Catalog Number | Description |
|----------------|---|
| 15PW | Male closure cap, for use with 15A Straight Blade & Locking devices and 20A Straight Blade devices. |
| 16CW | Female replacement cover for CW6P connectors |
| 24CW | Female Large replacement cover for CW6P connectors |
| 26CW | Female 30 Amp Large replacement cover for CW6P connectors |



16CW - Fits 16XXCW6P Connectors

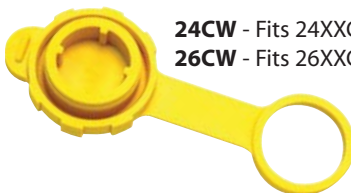

24CW - Fits 24XXCW6P Connectors
26CW - Fits 26XXCW6P Connectors



MANY ERICSON PRODUCTS ARE LISTED OR CERTIFIED.

FOR THE LATEST FULL SEARCHABLE LISTING BY PART NUMBER, GO TO: WWW.ERICSON.COM/AGENCY

Note: Products shown on this page may not be listed.

Hospital Grade Perma-Link® Plugs and Connectors

The same rugged internal construction as our standard Perma-Link line is found in these units, and in addition they meet UL Hospital Grade standards. Designed for reliable long life, built to withstand exceptional abuse, these dead-front, back-wired devices save installation time, provide maximum protection and can be used for straight blade installations in hospitals, schools, and extended care facilities. Constructed of rugged polybutylene terephthalate (PBT) and a high-tech thermoplastic elastomer (TPE), they have passed tests for ground pin retention, ground resistance, face impact, ground temperature contact, fault current, line blade retention and abrupt removal.

INSULATED/INSTITUTION GRAY RUBBER COVER

White and light "institution" gray colors identify this style which provides superior insulation. They are clearly marked "Hospital Grade" and clearly marked with a green dot to signify UL Hospital Grade. Non-conductive cord clamp to accommodate cord sizes #16/3 SJ through #12/3 SO.

FAST WIRING CHECK THROUGH CLEAR COVER

White PBT and transparent polycarbonate housing identify this type which permits visual inspection of wiring terminations without disassembly. Impact resistance, and non-conductive. Cord clamp has removable insert to accommodate #16/3 SJTW through #12/3 SO cord sizes.

PERMA-LINK® Hospital Grade Selection Guide

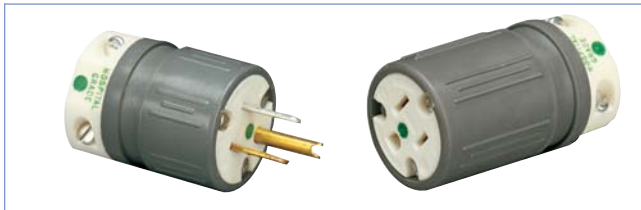

Hospital Grade Devices with Gray Covers

| Face View | NEMA Configuration | Electrical Ratings | | Perma-Link | |
|-----------|--------------------|--------------------|-------|------------|------------|
| | | Amps | Volts | Plugs | Connectors |
| | 5-15 | 15 | 125 | 1530-PH | 1630-CH |
| | 5-20 | 20 | 125 | 1532-PH | 1632-CH |

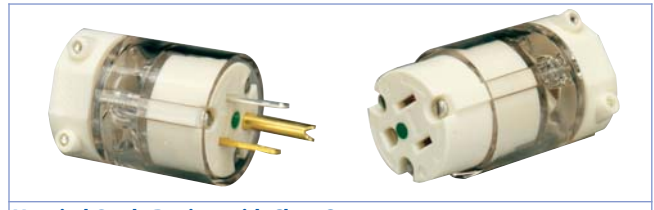

Hospital Grade Devices with Clear Covers
Straight Blade, 2-pole, 3-wire Grounding

| Face View | NEMA Configuration | Electrical Ratings | | Perma-Link | |
|-----------|--------------------|--------------------|-------|------------|------------|
| | | Amps | Volts | Plugs | Connectors |
| | 5-15 | 15 | 125 | 1530-PHC | 1630-CHC |
| | 5-20 | 20 | 125 | 1532-PHC | 1632-CHC |

EML520R & EML630R

Ericson offers our same heavy duty receptacles that we use in our own Temporary Power Panels. These wiring devices are primarily used in our OSCAR series and can be used as replacement parts for those products. Features such as color coded screw terminals with combo heads for ease of wiring makes these superior devices the best choice.



L6-30

EML630R



L5-20

EML520R



PERMA-LINK® 50Amp Locking Plugs and Connectors

Ericson's 50 Amp plugs and connectors incorporate the latest technologies to provide wiring devices that are safer, faster to wire, lighter and easier to identify. These devices are available as plugs, connectors, inlets and receptacles and are available in 3 and 4 wire configurations.



- UL Listed, CSA Certified, CETLUS Listed
- Rugged nylon construction resists impact, corrosion and jobsite oils/chemicals
- Quick field assembly, no need to disassemble the entire device
- Nickel plated blades and stainless steel screws provide optimum corrosion resistance
- Optional heavy-duty weather-proof boots are available and provide added environmental protection and UV resistance
- Boots can be threaded together with the optional sealing collar system to provide maximum environmental protection
- Available in plugs, connectors, inlets and receptacles

50-Amp Devices Selection Guide



| Face View | NEMA | Electrical Ratings | | Perma-Link® | | Receptacles | Flanged Inlets | Inlet with Flip Cover |
|--|---------------|--------------------|----------------|-------------|------------|-------------|----------------|-----------------------|
| | Configuration | Amps | Volts | Plugs | Connectors | | | |
| Locking, 2-pole, 3-wire Grounding | | | | | | | | |
| | Non-NEMA | 50 | 250VDC, 600VAC | 3763-P | 3762-C | 3771 | 3777 | |
| Locking, 3-pole, 4-wire Grounding | | | | | | | | |
| | Non-NEMA | 50 | 250VDC, 600VAC | 3765-P | 3764-C | 3769 | 3775 | |
| | | | 250VDC, 600VAC | 7765-P(1) | 7764-C(1) | 7379 | 7958 | |
| Locking, California Style, 2-pole, 3-wire Grounding | | | | | | | | |
| | Non-NEMA | 50 | 125 | CS6361-P | CS6360-C | - | - | |
| | | | 250 | CS8265-P | CS8264-C | CS8269 | CS8275 | |
| | | | 480 | CS8465-P | - | CS8469 | - | |
| Locking, California Style, 3-pole, 4-wire Grounding | | | | | | | | |
| | Non-NEMA | 50 | 125/250 | CS6365-P | CS6364-C | CS6369 | CS6375 | CS6375-F |
| | | | 480, 3ø | CS8165-P | CS8164-C | CS8169 | CS8175 | |

Notes:

1. For replacement use only, not recommended for new installations
2. Contact factory for custom assemblies

| Perma-Link® 50-Amp Accessories | Cat. Number |
|---|-------------|
| Weatherproof boot for plug or connector | 7717 |
| Sealing Collar for weatherproof boots | 510-RR |
| Weatherproof receptacle cover | 7788-CR |

Plug into Oscar™



7717 Provides A Superior Seal With Our SR-50 Receptacle

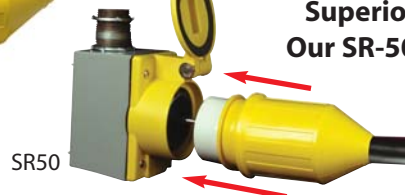

Sealing Collar System

Our exclusive sealing collar system is available to provide maximum moisture protection between cordsets. The two boots are securely sealed together with threaded polycarbonate rings.



MANY ERICSON PRODUCTS ARE LISTED OR CERTIFIED. FOR THE LATEST FULL SEARCHABLE LISTING BY PART NUMBER, GO TO: WWW.ERICSON.COM/AGENCY
 Note: Products shown on this page may not be listed.



Commercial Grade



Commercial Grade

| Insert Used | Cord Diameter |
|-------------|------------------------|
| Both | Less than .220 - .450" |
| None | Over .460 - .650" |

PERMA-LINK®

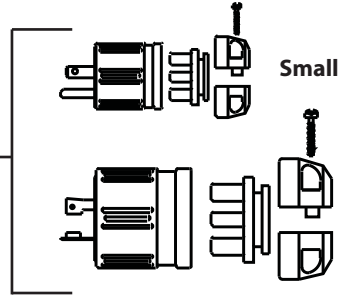

PERMA-LINK® Devices

| Self centering cord clamp accommodates cord diameters | |
|---|--------------|
| Small | .335 - .720" |
| Med/Large | .360 - 1.0" |

PERMA-GRIP™

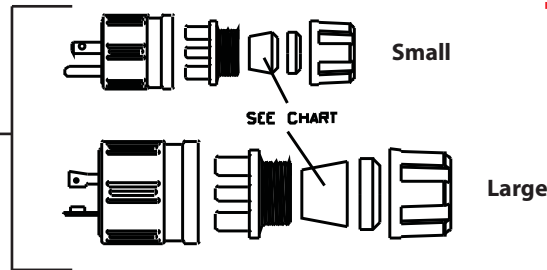

For Grommet Sizing

See Chart Next Page

PERMA-TITE® 2

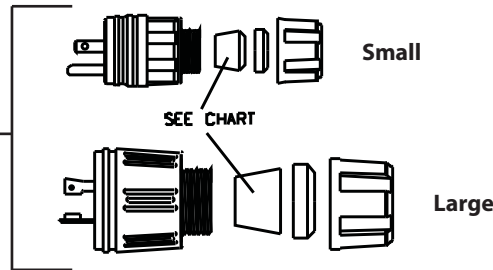

Strip Lengths

Dimensions in inches
Round Cord Only

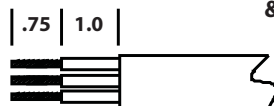
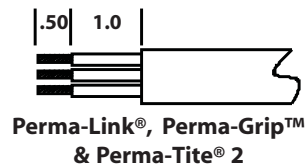
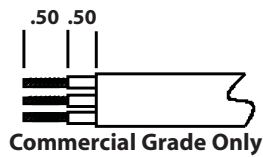
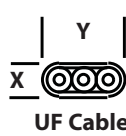

Grommet Sizes

| | | B10200XX | | | | | | B10220XX | | | | | | | | | | | | |
|-----------------------------|------|------------------------------|------------------------------|-------------------|------------------|----------------|-----------------|------------------|-------------------|------------------|-----------------|-----------------|----------------|-------------------|------------|---------------|----------|----------|-----------|--|
| | | Sm White OVAL # 24 | Sm Orange OVAL # 25 | Sm Yellow # 21 | Sm White # 20 | Sm Red # 16 | Sm Blue # 18 | Lg White # 91 | Lg Yellow # 90 | Lg Black # 89 | Lg Blue # 88 | Lg Gray # 87 | Lg Red # 86 | Lg Orange # 85 | | | | | | |
| MAX CORD DIA. (inch) | | OVAL (UF) .160 x .360 | OVAL (UF) .230 x .440 | 0.370 | 0.450 | 0.560 | 0.610 | 0.450 | 0.560 | 0.630 | 0.690 | 0.750 | 0.830 | 0.900 | | | | | | |
| | | Plug | Connector | | | Yellow | White* | Red | Blue | White* | Yellow | Black | Blue | Gray | Red | Orange | 3 | 4 | 3Ø | |
| 1510 | 1610 | ✓ Optional ** | ✓ Optional ** | ✓ | ✓ | ✓ | ✓ | | | | | | | | | X | | | | |
| 1512 | 1612 | | | ✓ | ✓ | ✓ | ✓ | | | | | | | | | | | X | | |
| 1514 | 1614 | | | ✓ | ✓ | ✓ | ✓ | | | | | | | | | | | X | | |
| 1516 | 1616 | | | ✓ | ✓ | ✓ | ✓ | | | | | | | | | | | X | | |
| 1520 | 1620 | | | ✓ | ✓ | ✓ | ✓ | | | | | | | | | | | X | | |
| 1522 | 1622 | | | ✓ | ✓ | ✓ | ✓ | | | | | | | | | | | X | | |
| 1524 | 1624 | | | ✓ | ✓ | ✓ | ✓ | | | | | | | | | | | X | | |
| 2310 | 2410 | | | | | | | ✓ | ✓ | ✓ | ✓ | | | | | X | | | | |
| 2312 | 2412 | | | | | | | ✓ | ✓ | ✓ | ✓ | | | | | X | | | | |
| 2314 | 2414 | | | | | | | ✓ | ✓ | ✓ | ✓ | | | | | X | | | | |
| 2316 | 2416 | | | | | | | ✓ | ✓ | ✓ | ✓ | | | | | X | | X | | |
| 2317 | 2417 | | | | | | | ✓ | ✓ | ✓ | ✓ | | | | | X | | | | |
| 2320 | 2420 | | | | | | | | ✓ | ✓ | ✓ | ✓ | | | | | X | | | |
| 2322 | 2422 | | | | | | | | ✓ | ✓ | ✓ | ✓ | | | | | X | X | | |
| 2324 | 2424 | | | | | | | | ✓ | ✓ | ✓ | ✓ | | | | | X | X | | |
| 2510 | 2610 | | | | | | | ✓ | ✓ | ✓ | ✓ | | | | | X | | | | |
| 2512 | 2612 | | | | | | | ✓ | ✓ | ✓ | ✓ | | | | | X | | | | |
| 2514 | 2614 | | | | | | | ✓ | ✓ | ✓ | ✓ | | | | | X | | | | |
| 2516 | 2616 | | | | | | | ✓ | ✓ | ✓ | ✓ | | | | | X | | X | | |
| 2520 | 2620 | | | | | | | | | | ✓ | ✓ | ✓ | ✓ | | | X | | | |
| 2522 | 2622 | | | | | | | | | | ✓ | ✓ | ✓ | ✓ | | | X | X | | |
| 2524 | 2624 | | | | | | | | | | ✓ | ✓ | ✓ | ✓ | | | X | X | | |
| 2526 | 2626 | | | | | | | | | | ✓ | ✓ | ✓ | ✓ | | | X | X | | |
| 2528 | 2628 | | | | | | | | | | ✓ | ✓ | ✓ | ✓ | | | X | X | | |
| 2530 | 2630 | | | | | | | | | | ✓ | ✓ | ✓ | ✓ | | | X | X | | |

* May also appear as light tan

** May be ordered separately - Call Ericson for details

✓ = Included in package

Diameter Ranges of Portable Electrical Cord In Accordance with UL 62

| Type | AWG Size | 2 Conductors | 3 Conductors | 4 Conductors |
|--|-------------|--------------|--------------|--------------|
| SJ, SJE, SJOO, SJO, SJEO, SJT, SJTO, SJTOO | 18 | 0.280-0.315 | 0.300-0.335 | 0.325-0.365 |
| | 16 | 0.305-0.340 | 0.325-0.360 | 0.350-0.395 |
| | 14 | 0.335-0.375 | 0.360-0.395 | 0.390-0.435 |
| | 12 | 0.405-0.455 | 0.425-0.475 | 0.465-0.520 |
| | 10 | 0.540-0.605 | 0.565-0.635 | 0.625-0.700 |
| S, SE, SOO, SO SEO, ST, STOO, STO | 18 | 0.340-0.385 | 0.360-0.400 | 0.385-0.430 |
| | 16 | 0.365-0.410 | 0.385-0.430 | 0.410-0.460 |
| | 14 | 0.495-0.550 | 0.520-0.575 | 0.560-0.620 |
| | 12 | 0.565-0.625 | 0.590-0.655 | 0.640-0.710 |
| | 10 | 0.615-0.685 | 0.650-0.720 | 0.700-0.775 |
| | 8 | 0.780-0.880 | 0.830-0.930 | 0.925-1.050 |
| | 6 | 0.920-1.050 | 0.970-1.100 | 1.050-1.200 |
| | 4 | 1.060-1.210 | 1.130-1.280 | 1.250-1.450 |
| 2 | 1.210-1.400 | 1.300-1.500 | 1.450-1.650 | |



MANY ERICSON PRODUCTS ARE LISTED OR CERTIFIED.

FOR THE LATEST FULL SEARCHABLE LISTING BY PART NUMBER, GO TO: WWW.ERICSON.COM/AGENCY

Note: Products shown on this page may not be listed.